



iAPX 86,88 FAMILY UTILITIES USER'S GUIDE

**iAPX 86,88 FAMILY UTILITIES
USER'S GUIDE**

Order Number: 121616-004

Additional copies of this manual or other Intel literature may be obtained from:

Literature Department
Intel Corporation
3065 Bowers Avenue
Santa Clara, CA 95051

The information in this document is subject to change without notice.

Intel Corporation makes no warranty of any kind with regard to this material, including, but not limited to, the implied warranties of merchantability and fitness for a particular purpose. Intel Corporation assumes no responsibility for any errors that may appear in this document. Intel Corporation makes no commitment to update nor to keep current the information contained in this document.

Intel Corporation assumes no responsibility for the use of any circuitry other than circuitry embodied in an Intel product. No other circuit patent licenses are implied.

Intel software products are copyrighted by and shall remain the property of Intel Corporation. Use, duplication or disclosure is subject to restrictions stated in Intel's software license, or as defined in ASPR 7-104.9(a)(9).

No part of this document may be copied or reproduced in any form or by any means without the prior written consent of Intel Corporation.

The following are trademarks of Intel Corporation and its affiliates and may be used to identify Intel products:

BXP	int _e l	iSBC	MULTICHANNEL
CREDIT	Intelevision	iSBX	MULTIMODULE
i	int _e ligent Identifier	iSXM	Plug-A-Bubble
ICE	int _e ligent Programming	Library Manager	PROMPT
ICE	Intellec	MCS	RMX/80
iCS	Intellink	Megachassis	RUPI
i _m	iOSP	MICROMAINFRAME	System 2000
iMMX	iPDS	MULTIBUS	UPI
Insite	iRMX		

REV.	REVISION HISTORY	DATE
-001	Original issue.	9/80
-002	Adds information to support V2.0 of LINK86, LOC86, and LIB86 and V1.0 of CREF86; corrects technical and typographical errors.	11/81
-003	Adds examples for iRMX 86 operating environment.	5/82
-004	Adds examples for Series IV operating environment.	10/82



This manual describes how to use the iAPX 86,88 Family utilities:

- LINK86
- CREF86
- LIB86
- LOC86
- OH86

These products run on 8086- and 8088-based systems. They are used by programmers developing programs with ASM86, ASM89, PL/M-86, PASCAL-86, FORTRAN-86, or any other language translator that produces object code compatible with the iAPX 86,88 Family of processors. The iAPX 86,88 Family of processors includes 8086, 8088, 8087, and 8089 processor chips. Because the 8086 is the first member of this family, this manual uses 8086 generically to represent the entire family.

This manual presumes familiarity with the conventions of the operating system under which the iAPX 86,88 utilities are being executed. It also presumes familiarity with the basic requirements of individual languages and translators.

This manual is divided into the following chapters:

- Chapter 1, Introduction: a summary of the relationship among the utilities and basic concepts governing their use
- Chapter 2, LINK86: how to invoke, use the controls for, and read the printed listing from LINK86
- Chapter 3, CREF86: how to invoke, use the controls for, and read the output listing from CREF86
- Chapter 4, LIB86: how to invoke and use the commands for LIB86
- Chapter 5, LOC86: how to invoke, use the controls for, and read the printed listing from LOC86
- Chapter 6, OH86: how to invoke OH86

This manual also contains several appendixes, meant for quick access to the following information:

- iAPX 86,88 absolute object file format definitions (Appendix A)
- Hexadecimal-decimal conversion information (Appendix B)
- The effect of available memory on the performance of LINK86, CREF86, LIB86, and LOC86 (Appendix C)
- Summaries of iAPX 86,88 Family utility controls and error messages:
 - LINK86 (Appendix D)
 - CREF86 (Appendix E)
 - LIB86 (Appendix F)
 - LOC86 (Appendix G)
 - OH86 (Appendix H)

NOTE

The following appendixes address issues dependent on specific operating systems, such as operating environments, related publications, and examples. These appendixes contain foldout pages, designed to be opened out to your right and used in conjunction with general instructions provided in the chapters and other appendixes. On these foldout pages you will find sample invocations for the iAPX 86,88 Family utility controls and commands.

- Additional information for Series III users (Appendix I)
- Additional information for iRMX 86 users (Appendix J)
- Additional information for Series IV users (Appendix K)

Once you have gained sufficient familiarity with the basic principles of iAPX 86,88 Family utilities operation, you will find the following publication convenient for quick syntax reference:

- *iAPX 86,88 Family Utilities Pocket Reference*, order number 121669

Before reading this manual, ensure that you are familiar with the following terms and conventions.

Notational Conventions

punctuation	other than the following must be entered if required by the control syntax.
{ }	indicates that one and only one of the syntactic items contained within the braces is required.
[]	indicates that the syntactic item or items contained within the brackets are optional.
...	indicates that the preceding syntactic item may be repeated an indefinite number of times. (The ellipsis is often used within brackets and with a comma “[...]” to indicate that preceding item may be repeated, but each repetition must be separated by a comma.)
	separates various options within the brackets [] or braces { }.
UPPERCASE	indicates that these characters must be entered exactly as shown.
<i>italic</i>	indicates a meta symbol that may be replaced with an item that fulfills the rules for that symbol. The actual symbol may be any of the following:
<i>pathname</i>	is a valid designation for a file; in its entirety, it consists of a <i>directory-name</i> and a <i>filename</i> .
<i>directory-name</i>	is that portion of a <i>pathname</i> that acts as a file locator by identifying the device and/or directory containing the <i>filename</i> .
<i>filename</i>	is a valid name for the part of a <i>pathname</i> that names a file.

minimum-size
maximum-size
paragraph
offset
address

are numbers and must follow Intel standards for number representation (see PL/M-86 or ASM86). Use the H suffix for hexadecimal, B suffix for binary, O or Q suffix for octal and D or nothing for decimal.

segment name
module name
class name
group name
overlay name
public symbol
variable name

are defined by the 8086 object file formats described in Appendix A. They may be up to forty characters long and may contain any of the following characters in any order:

A, B, C, D, E, F, G, H, I, J, K, L, M, N, O, P, Q, R, S, T, U, V, W, X, Y, Z, 0, 1, 2, 3, 4, 5, 6, 7, 8, 9, ?, @, :, ., —,

black

Black background is used in examples to indicate the user's entries.

system-id

is a generic label placed on sample listings where an operating system-dependent name would actually be printed.

pathname1,
pathname2, ...

are generic labels placed on sample listings where one or more user-specified pathnames would actually be printed.

Vx.y

is a generic label placed on sample listings where the version number of the product that produced the listing would actually be printed.



	PAGE		PAGE
CHAPTER 1		CHAPTER 3	
INTRODUCTION		CREF86	
Program Development	1-1	CREF86 Invocation Line	3-2
Overview of the Utilities	1-2	CREF86 Controls	3-2
External References and Public Symbols	1-2	PAGELENGTH	3-3
Use of Libraries	1-3	PAGEWIDTH	3-4
Relative Addressing	1-4	PRINT	3-5
The LINK86/LOC86 Process	1-4	TITLE	3-6
An 8086 Overview	1-5	CREF86's Print File	3-7
Memory	1-5	Header	3-7
8086 Addressing Techniques	1-5	Warnings	3-7
Segments	1-6	Module List	3-8
Segment Alignment	1-7	Symbol Cross-Reference Information	3-8
Segment Combining	1-8		
Segment Locating	1-8		
Classes	1-9	CHAPTER 4	
Groups	1-9	LIB86	
Overlays	1-10	LIB86 Invocation	4-1
Position-Independent-Code and Load-Time- Locatable Code	1-10	LIB86 Commands	4-1
		ADD	4-2
		CREATE	4-3
		DELETE	4-4
		EXIT	4-5
		LIST	4-6
CHAPTER 2		CHAPTER 5	
LINK86		LOC86	
LINK86 Invocation Line	2-1	LOC86 Invocation Line	5-1
LINK86 Controls	2-2	LOC86 Controls	5-1
ASSIGN	2-4	ADDRESSES	5-3
ASSUMEROOT	2-5	BOOTSTRAP	5-4
BIND/NOBIND	2-6	COMMENTS/NOCOMMENTS	5-5
COMMENTS/NOCOMMENTS	2-7	INITCODE/NOINITCODE	5-6
FASTLOAD/NOFASTLOAD	2-8	LINES/NOLINES	5-7
INITCODE	2-9	MAP/NOMAP	5-8
LINES/NOLINES	2-10	NAME	5-9
MAP/NOMAP	2-11	OBJECTCONTROLS	5-10
MEMPOOL	2-12	ORDER	5-11
NAME	2-13	PRINT/NOPRINT	5-12
OBJECTCONTROLS	2-14	PRINTCONTROLS	5-13
ORDER	2-15	PUBLICS/NOPUBLICS	5-14
OVERLAY/NOOVERLAY	2-16	PURGE/NOPURGE	5-15
PRINT/NOPRINT	2-17	RESERVE	5-16
PRINTCONTROLS	2-18	SEGSIZE	5-17
PUBLICS/NOPUBLICS	2-19	START	5-18
PUBLICSONLY	2-20	SYMBOLS/NOSYMBOLS	5-19
PURGE/NOPURGE	2-21	SYMBOLCOLUMNS	5-20
RENAMEGROUPS	2-22	LOC86's Print File	5-21
SEGSIZE	2-23	The Symbol Table	5-21
SYMBOLS/NOSYMBOLS	2-24	The Memory Map	5-23
SYMBOLCOLUMNS	2-25	Error and Warning Messages	5-24
TYPE/NOTYPE	2-26	LOC86's Algorithm for Locating Segments	5-24
LINK86's Print File	2-27	Absolute Segments	5-24
The Header	2-27	Segment Ordering	5-24
The Link Map	2-27		
The Group Map	2-28		
The Symbol Table	2-29		
Error Messages	2-30		



CONTENTS (Cont'd.)

	PAGE
Assigning Addresses to Relocatable Segments	5-25
LOC86's Algorithm for Locating Modules Containing Overlays	5-25

CHAPTER 6 OH86

APPENDIX A iAPX 86,88 ABSOLUTE OBJECT FILE FORMATS

APPENDIX B HEXADECIMAL-DECIMAL CONVERSION

APPENDIX C THE EFFECT OF AVAILABLE MEMORY ON LINK86, CREF86, LIB86, AND LOC86

APPENDIX D LINK86 CONTROLS AND ERROR MESSAGES

APPENDIX E CREF86 CONTROLS AND ERROR MESSAGES

APPENDIX F LIB86 COMMANDS AND ERROR MESSAGES

APPENDIX G LOC86 CONTROLS AND ERROR MESSAGES

APPENDIX H OH86 ERROR MESSAGES

APPENDIX I ADDITIONAL INFORMATION FOR INTELLEC SERIES III USERS

APPENDIX J ADDITIONAL INFORMATION FOR iRMX 86 USERS

APPENDIX K ADDITIONAL INFORMATION FOR SERIES IV USERS



TABLES

TABLE	TITLE	PAGE	TABLE	TITLE	PAGE
2-1	Summary of LINK86 Controls	2-2	E-1	Summary of CREF86 Controls	E-1
3-1	Summary of CREF86 Controls	3-2	F-1	Summary of LIB86 Commands	F-1
4-1	Summary of LIB86 Commands	4-1	G-1	Summary of LOC86 Controls	G-1
5-1	Summary of LOC86 Controls	5-1	J-1	iRMX 86 Memory Requirements	J-1
D-1	Summary of LINK86 Controls	D-1			



ILLUSTRATIONS

FIGURE	TITLE	PAGE	FIGURE	TITLE	PAGE
1-1	The iAPX 86,88 Family Development Process	1-1	I-3	LINK86 Default Print File	I-5
1-2	Library Linkage by LINK86	1-3	I-4	CREF86 Cross-Reference Listing	I-6
1-3	The LINK86/LOC86 Process	1-4	I-5	LINK86 Listing for Program with Overlays	I-9
1-4	8086 Addressing	1-6	I-6	LOC86 Listing for Program with Overlays	I-10
1-5	Segment Physical Relationships	1-7	I-7	LINK86 Map for Root File	I-11
1-6	Segment Alignment Boundaries	1-8	I-8	Module Information for Overlays	I-12
1-7	Memory Configuration of Program with Overlays	1-10	I-9	Memory Organization for Example 6	I-13
2-1	LINK86 Input and Output Files	2-1	J-1	CREF86 Cross-Reference Listing	J-4
2-2	LINK86 Print File Header	2-27	J-2	LINK86 Listing for Program with Overlays	J-7
2-3	LINK86 Link Map	2-27	J-3	LOC86 Listing for Program with Overlays	J-8
2-4	LINK86 Group Map	2-28	J-4	LINK86 Map for Root File	J-9
2-5	LINK86 Symbol Table	2-29	J-5	Module Information for Overlays	J-10
3-1	CREF86 Input and Output Files	3-1	J-6	Memory Organization for Example 4	J-11
3-2	Header of Cross-Reference Listing	3-7	K-1	LINK86 Print File for Bound Object Module	K-3
3-3	Warning Messages on CREF86 Listing	3-7	K-2	LINK86 Default Print File	K-5
3-4	Module List on CREF86 Listing	3-8	K-3	CREF86 Cross-Reference Listing	K-5
3-5	Symbol Cross-Reference Information	3-9	K-4	LINK86 Listing for Program with Overlays	K-8
5-1	LOC86 Input and Output Files	5-1	K-5	LOC86 Listing for Program with Overlays	K-10
5-2	LOC86 Symbol Table	5-22	K-6	LINK86 Map for Root File	K-11
5-3	LOC86 Memory Map	5-23	K-7	Module Information for Overlays	K-12
5-4	LOC86's Address Assignments for Overlays	5-26	K-8	Memory Organization for Example 6	K-13
6-1	OH86 Input and Output Files	6-1			
I-1	LINK86 Print File for Bound Object Module	I-3			
I-2	LOC86 Print File for Bound Object Module	I-4			

Program Development

Program development is a process of varying complexity. The complexity depends on the language used to develop code, the complexity of the end product, and the tools chosen.

Figure 1-1 shows the development process and the tools available for development of an iAPX86,88 Family-based product.

The tools described in this manual are:

- LINK86, which is a linkage and binding tool
- CREF86, which provides a cross-reference of information on symbols in several modules
- LIB86, which is the librarian function for 8086 object modules
- LOC86, which is the relocation tool
- OH86, which converts 8086 absolute object information to the hexadecimal format

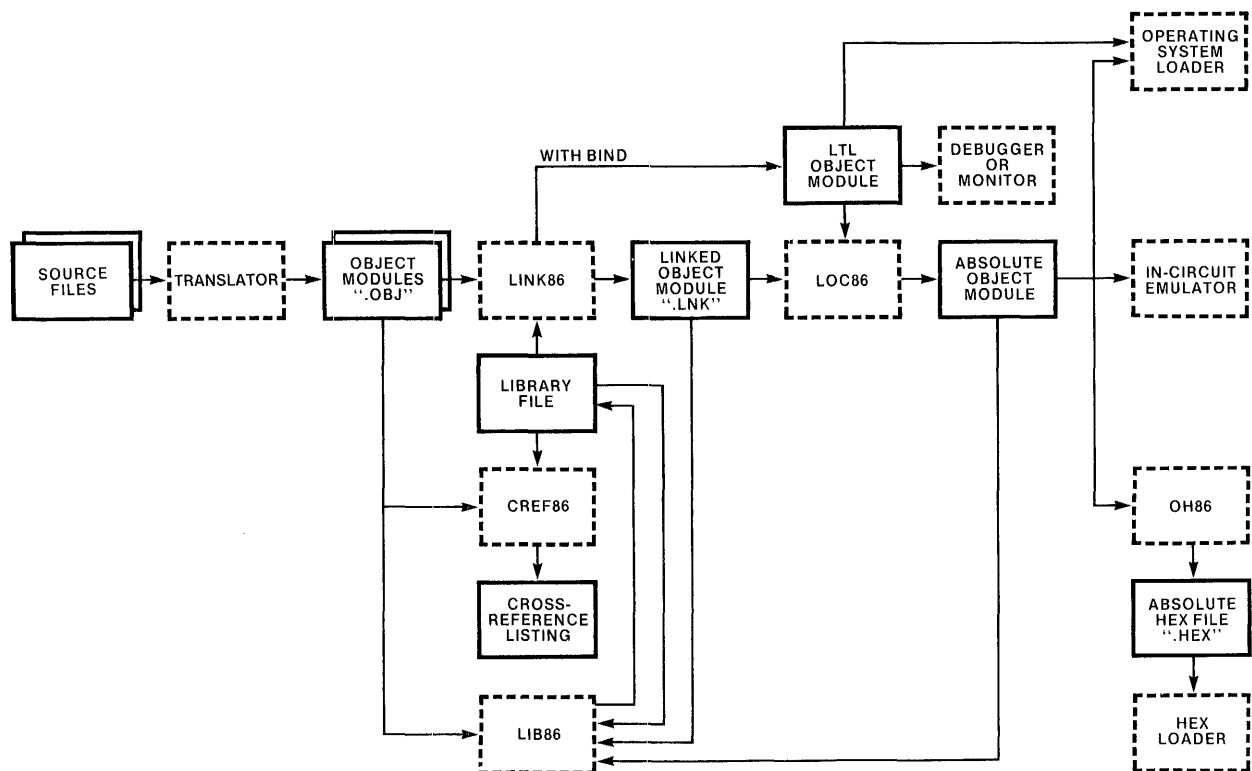

Figure 1-1. The iAPX86,88 Family Development Process

121616-1

Overview of the Utilities

ASM86, ASM89, PL/M-86, PASCAL-86, FORTRAN-86, and other translators as well as LINK86 and LOC86 produce 8086 object modules. The language translators produce 8086 relocatable object modules that must usually be processed by utilities before execution. (Under certain circumstances the translators can produce absolute object modules, but this is rare and does not contribute to modular design.) LINK86 combines 8086 object modules, and LOC86 converts relocatable object modules into absolute object modules. OH86 converts 8086 absolute object modules to 8086 hexadecimal format.

LINK86 combines a list of 8086 object modules into a single object module and attempts to match all external symbol declarations with their public symbol definitions in library modules. (LIB86 is the utility used to create and maintain program libraries.) The output of LINK86 is a relocatable object module. However, when specified in the controls, LINK86 produces a load-time-locatable (LTL) object module; an LTL module can be executed on an 8086-based system. (See the description of LTL modules later in this chapter.) Whether the LINK86 output is an LTL or a relocatable object module, it can serve as input to LOC86.

CREF86 provides a means for producing a cross-reference listing of public and external symbols in multiple 8086 object modules. The object modules may include library modules. The output produced by CREF86 should help the programmer to identify how symbols will be resolved by LINK86, given the same input files.

LOC86 converts relocatable (or LTL) object modules to absolute object modules. Absolute object modules contain references that require the module segments to be placed at particular places in 8086 memory.

The sequence in which the segments in the input modules are combined and absolute addresses assigned to segments is determined by the controls supplied and the order in which the modules are listed in the LINK86 and LOC86 invocations.

External References and Public Symbols

An address field that refers to a location in a different object module is called an external reference. An external reference differs from a relative address because the translator that generates the modules knows nothing about the location of the referenced symbol. You must declare these references as external when coding a program. This tells the translator, and subsequently the relocation and linkage (R&L) utilities, that the target of the reference is in a different module.

A module that contains external references is called an unsatisfied module. To satisfy the module, a module with a public symbol that matches the external symbol must be found. Associated with a public symbol in a module is an address that allows other modules, with the appropriate external reference, to reference the module with the public symbol. You must define these symbols as public when coding the program. This tells the source translator and the R&L utilities that other modules can reference the symbol.

If there are external references that are not satisfied by public symbols, warning messages are issued and the resulting module remains unsatisfied.

Use of Libraries

Libraries aid in the job of building programs. The library manager program, LIB86, creates and maintains files containing object modules.

LINK86 and CREF86 treat library files in a special manner. If you specify a library file in the input to these utilities, they search the library for modules that satisfy unresolved external references in the input modules *already* read. This means that libraries should be specified after the input modules that contain external references. If a module included from the library has an external reference, the library is searched again to try to satisfy the reference. This process continues until all external references have been the subject of a search of all public symbols in the library modules.

When LINK86 and CREF86 search a library, they *normally* include only library modules that satisfy external references in the output. If no external references are satisfied by a library, no modules from the library are included in the LINK86 output module or the CREF86 output listing. However, LINK86 and CREF86 provide the means to unconditionally include a library module even if there is no external reference to it. Figure 1-2 shows LINK86 handling of a library file.

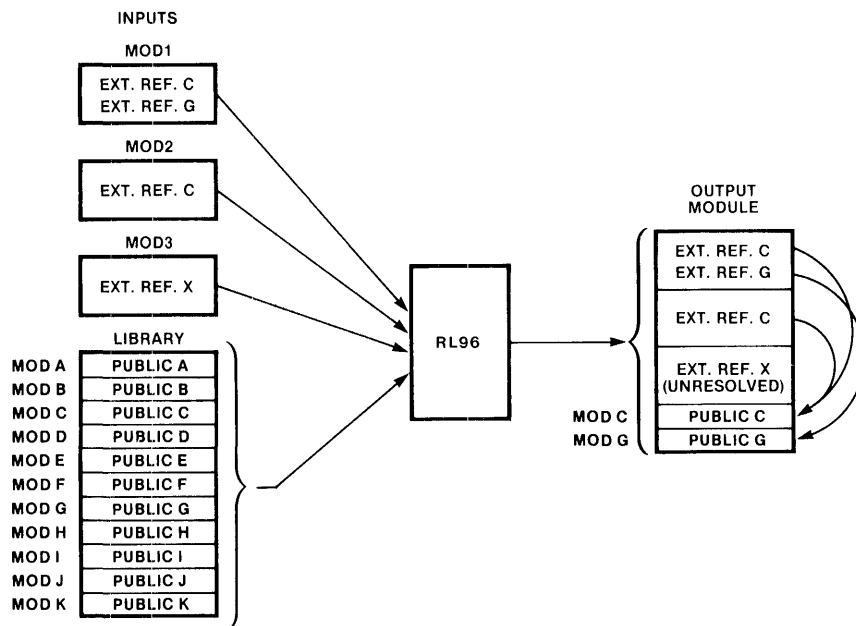

Figure 1-2. Library Linkage by LINK86

121616-2

Relative Addressing

The relative addresses of instructions and data in program modules are assigned by the source translator. The addresses are relative to the beginning of the segment in which they reside. The relative address is actually the number of bytes from the beginning of the segment.

After LINK86 combines all the input segments, LOC86 can be used to assign absolute memory addresses to all relative addresses. The resulting output module can only be executed when its segments are loaded at the absolute addresses assigned by the command. If LINK86 is used to create a bound object module, LOC86 is not needed to execute the program.

The LINK86/LOC86 Process

Although controls are not required for LINK86 and LOC86 execution, the commands invoking them may contain controls that affect their output. The controls make it possible to change the defaults for module combination, address assignment, and output information.

The inputs are object modules in disk files. The input modules can contain relative addresses, absolute addresses, external references, and public symbols. The input modules must be in the 8086 object module format such as is generated by 8086 translators and LINK86 and LOC86 themselves.

LINK86 combines segments from the input modules, and for LTL object modules LINK86 orders segments in groups and assigns offsets. LOC86 orders the segments and assigns absolute addresses according to the controls specified with the command and/or the default algorithms. Both commands output the module when processing is completed along with any error messages and diagnostic information. Figure 1-3 shows the LINK86/LOC86 process.

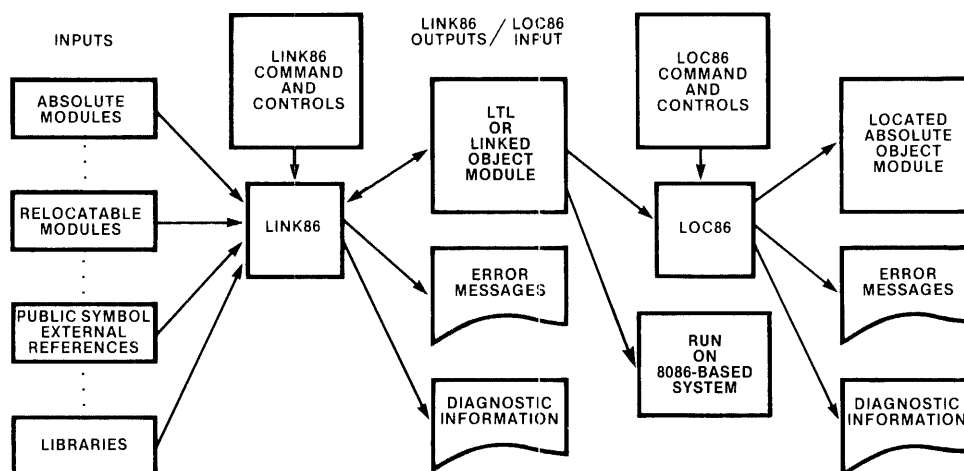

Figure 1-3. The LINK86/LOC86 Process

121616-3

An 8086 Overview

To use the R&L commands you must have an understanding of the following concepts:

- Addresses, given as offsets into segments, which must be translated into absolute memory addresses, or base offsets
- Segment definitions, which identify contiguous pieces of information, usually code or data
- Class definitions, which identify segments that share common attributes and should be kept together
- Group definitions, which identify segments that must be kept within a 64K byte range of memory
- Overlay definitions, which identify modules that will be loaded in memory at different times during execution.
- Load-time-locatable object modules

Memory

The 8086 can address up to a maximum of a megabyte of memory. In decimal a megabyte is 1,048,576 bytes. Memory addresses are always shown in hexadecimal. A megabyte of memory has the addresses: 0H through 0FFFFH.

Not all 8086-based systems will have a full megabyte of memory. Many systems will have gaps in the memory that is available. The different portions of memory will probably be implemented with different types of memory chips. The system monitor or supervisor is usually stored in ROM or PROM chips. Because it is not modified by execution it can be a permanent part of the system. This prevents the need to load it each time the system is turned on. The data that is referenced often is kept in high-speed RAM because it is modified frequently. It may be practical to keep data that is referenced less often in slower-speed memory. The size and composition of a system's memory is totally dependent on the application the system serves.

Linkage and relocation is designed to handle the linking and locating of your program, no matter how your 8086-based system memory is implemented. It provides very flexible segment placement within any given memory configuration.

8086 Addressing Techniques

The 8086 addresses memory with a 20-bit address that is constructed from a segment address and a 16-bit offset from that segment address. This means that with a single segment address, 64K bytes of memory is directly addressable by changing only the offset.

A hardware segment address is a 20-bit address. But the segment address is constrained such that the segment is placed on a boundary that is a multiple of 16 (10H). The segment address can be set to any hexadecimal address ending in 0:

```

0H
010H
020H
.
.
.
0FFFF0H

```

Because the low four bits of the 20-bit segment address are always zero, the segment address can be represented with only 16 bits.

The segment address is kept in one of four 16-bit segment registers. Because there are four segment registers, the 8086 can, at any moment, access 256K ($4 \times 64\text{K}$) bytes of memory. The full megabyte of memory is accessed by changing the values in the segment registers. Figure 1-4 shows the 8086 addressing concept.

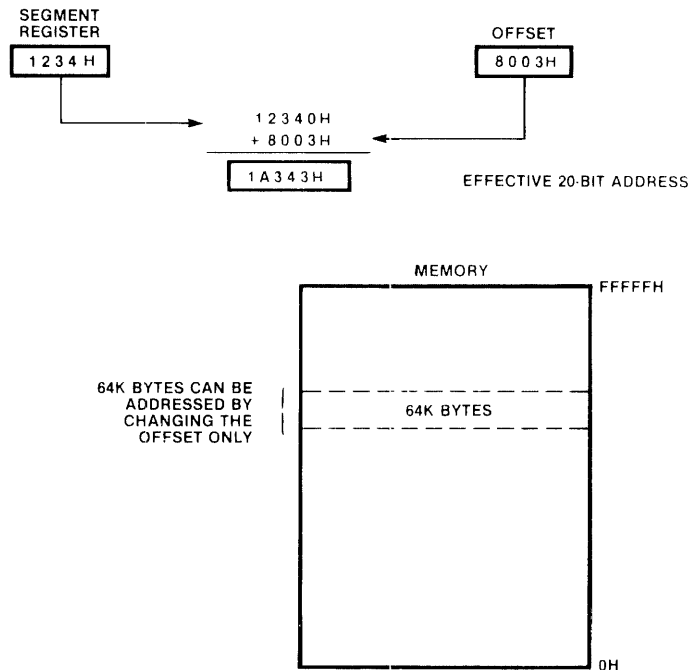

Figure 1-4. 8086 Addressing

639-4

Segments

Programs comprise pieces called segments, which are the fundamental units of linkage and relocation. The basic divisions have functional purposes related to the hardware configuration of memory. The portions of programs that are to be kept in ROM or PROM can be put in separate segments from the portions that will be kept in RAM.

The 8086 Assembler allows the programmer to name the segments of the program being developed. The PL/M-86 compiler may generate predefined names for segments.

A segment is a contiguous area of memory that is defined at translation time (assemble or compile). When defined, a segment does not necessarily have a fixed address or size. A fixed address is assigned to a segment during the locate function. The size can be changed by combining segments and by a control that specifies a specific size. Some translations may produce absolute object information, with absolute addresses and a specific segment size.

LINK86 combines all segments with the same complete (segment, class and overlay) name and combination type (memory, stack, etc.) from all input modules. The ordering of segments is done on the basis of these combined segments. The manner in which segments are combined depends on the alignment of the segments (which is described in the next topic) and a combining attribute associated with the segment.

When we refer to combining segments, we are talking about how the segments will be loaded in memory, *not* how they will be stored in the output module. The segments in the LOC86 output module contain addresses that determine where they will be loaded in memory. The segments reside in the output module in the same order as they were in the input modules. Figure 1-5 shows the physical relationships between the input modules, output module, and loaded program.

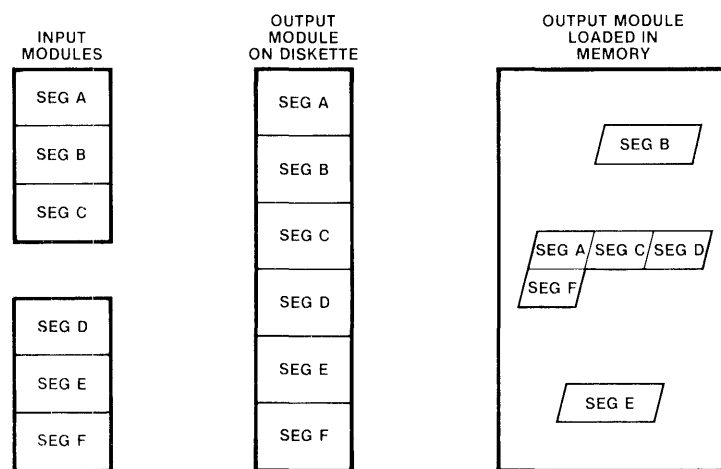

Figure 1-5. Segment Physical Relationships

639-5

Segment Alignment

A segment can have one (and in the case of the inpage attribute, two) of five alignment attributes:

- Byte, which means a segment can be located at any address
- Word, which means a segment can be located only at an address that is a multiple of two, starting from address 0H
- Paragraph, which means a segment can be located only at an address that is a multiple of 16, starting from address 0
- Page, which means a segment can be located only at an address that is a multiple of 256, starting from address 0
- Inpage, which means a segment can be located at whichever of the preceding attributes apply, plus must be located so that it does not cross a page boundary

Figure 1-6 shows the segment alignment boundaries.

Any alignment attribute except byte can result in a gap between combined segments. For example, when two page-aligned segments are combined, there will always be a gap, unless the first happens to be an exact multiple of 256 bytes in length.

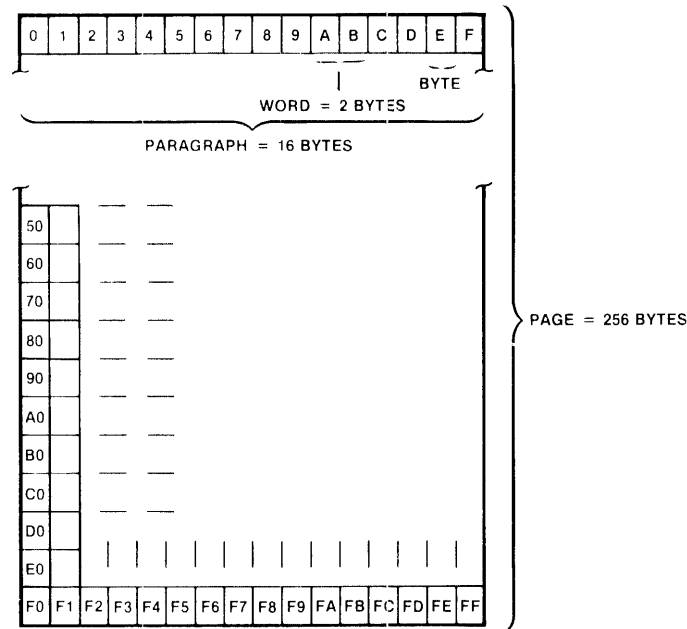

Figure 1-6. Segment Alignment Boundaries

639-6

Segment Combining

Segments containing data and code are combined end to end. There may be a gap between the segments if the alignment characteristics require it. The relative addresses in the segments are adjusted for the new longer segment.

There are two special cases of segment combination: stack segments and memory segments. Such translators as PL/M-86 define these segments with the names STACK and MEMORY. With ASM86 you must define them by adding the STACK or MEMORY parameter to the SEGMENT directive.

When stack segments are combined, they are overlaid but their lengths are added together.

When memory segments are combined, they are overlaid with their low addresses at a common address. The length of the combined memory segment is the length of the largest segment that was combined. No relative address adjusting is necessary. Normally the memory segment is located above (at a higher memory address) the rest of the program segments if no controls are used to override this.

To make sure that stack segments are combined correctly, you should always give them the same segment name in each module. The same is true of memory segments. If you are going to link assembly language routines to PL/M-86 routines you should give them the names STACK and MEMORY to be compatible with PL/M-86.

Segment Locating

Segments are located in the order in which they are encountered in the input modules. If classes (described in the next section) are defined, the segments from a class are located together. The locating algorithm can be changed by using LOC86 locating controls.

One variation to the sequential locating of segments is how the MEMORY segment is located. When the first segment with the memory attribute is encountered, it is placed last in the list of segments. This means that after all other segments are located, the MEMORY segment will be assigned the highest address in the output module.

NOTE

The MEMORY segment may not get located at the top of the module if its name or class name appears in any LOC86 control (other than SEGSIZE) or it has the absolute attribute.

Classes

A class is a collection of segments. When segments are defined in assembly language, a class name can be specified. The segments generated by such translators as PL/M-86 are generated with predefined class names. Any number of segments can be given the same class name. Class names can extend beyond module boundaries; the same class name can be used in different modules that are to be combined.

The primary purpose of classes is to collect together (in an arbitrary order) segments that share a common attribute and to manipulate this collection at locate-time by specifying only the class name.

All segments with the same class name are located together in the memory address space of the output module. (You can override class collection by specifying the location of segments with the LOC86 ORDER control or LOC86 ADDRESSES control.)

Classes give you a second means of collecting like segments in the output module. The first is giving segments the same name. If you are developing several modules that are to be combined, you may want to give the segment containing executable code the name CODE in each module. If there are several differently named segments within a module that contain executable code, you may want to give these segments the class name of CODE that causes them to be located together but not combined. (The same name can be used for segments and classes.)

Groups

A group is also a collection of segments. Groups define addressing range limitations in 8086 object modules. A group specifies a collection of segments that must be located within a 64K byte range. This means that the entire group of segments can be addressed with offsets from a single segment register. Or, to put it another way, the segment register need not be changed when addressing any segment in a group. This permits efficient addressing within the module.

Group addressing always begins at an address that is a multiple of 16 (i.e., a paragraph boundary). R&L does not manipulate segments of a group to make sure they fall within a 64K byte range. However, if they do not fit in the range, a warning message is issued.

The segments included in a group do not have to be contiguous in the output module. The only requirement is that all the segments defined in the group must totally fall within 64K bytes of the beginning address of the group.

Overlays

Sometimes your 8086 program is too large to fit into the memory available on the system. Overlays permit programs to be larger than the available memory.

Typically, an overlay is composed of code and data that is executed in one phase of a program's execution, but not used at any other time. Once executed the memory used by this code can be overwritten with code and data used in an other phase. Sections of code that occupy the same part of memory at different times during execution are called overlays.

Part of an overlaid program is always resident in memory; it usually comprises the main program module, frequently used routines, and the overlay loader. This part of the program is called the root. Figure 1-7 illustrates the memory configuration of one program that uses overlays.

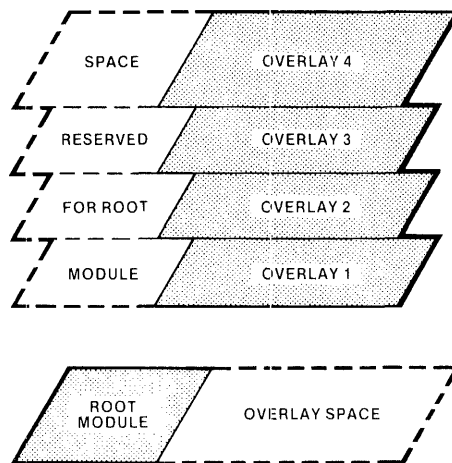

Figure 1-7. Memory Configuration of Program with Overlays

639-7

Position-Independent Code and Load-Time-Locatable Code

An LTL (load-time-locatable) program can be loaded anywhere in memory (assuming alignment attributes are honored). Code and data addresses are assigned by the system loader. References to segment bases (segment registers) are permitted. The loader, when it determines where to locate each segment, must resolve these references to the segment bases. Before executing the LTL program, the loader must also initialize the segment registers.

A PIC (position-independent-code) program is an LTL program, but it contains no references to segment bases. To execute these programs the loader need only place the program in memory (recognizing alignment attributes) and initialize the segment registers and go. No fixup of segment bases is required.

LINK86 combines 8086 object modules and resolves references between independently translated modules. LINK86 takes a list of files and controls as input and produces two output files: a print file and an object file.

Figure 2-1 illustrates the linkage process. The input files may be any object module (output from a translator, LINK86, LOC86 or an 8086 library file). The print file contains diagnostic information. The output object file is a bound load-time-locatable module or simply a relocatable module.

This chapter provides details concerning the LINK86 invocation, controls, and print file. For definition of file-naming and syntax notation conventions used in this chapter, refer to Notational Conventions following the Preface. For a summary of the LINK86 controls and information on error and warning messages that may be produced, refer to Appendix D. For details concerning symbol table space limitations, refer to Appendix C.

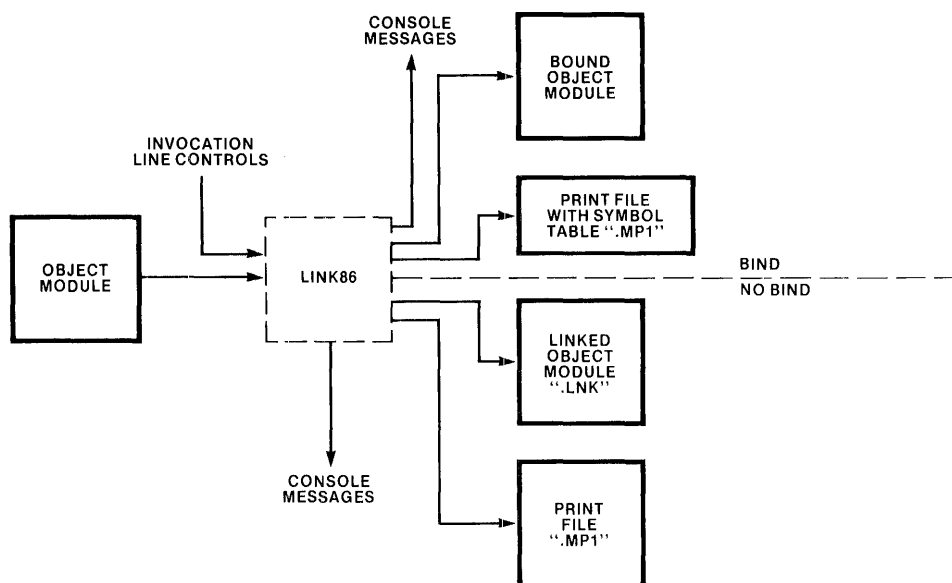

Figure 2-1. LINK86 Input and Output Files

121616-4

LINK86 Invocation Line

The general syntax for the invocation line is:

```
[directory-name]LINK86 input list[TO output file][controls]
```

The *input list* is one or more modules to be linked together into a single object module:

```
pathname[(module name[, ...])][, ...]
```

Unless a *module name* is specified, all modules in a *pathname* are included. If the *pathname* is a library file, any modules named in parentheses are included in the *output file* even if they do not contain public symbol definitions for external symbols declared elsewhere in the input list.

The *input list* may also contain the control PUBLICSONLY before selected *pathnames*. If you wish to include a file called PO or PUBLICSONLY, ensure that the filename is preceded by a directory-name in order to distinguish it from the control or its abbreviation.

The order of modules in the input list affects the order of segments in the output file.

TO *output file* designates the file to receive the linked object module. If *output file* is not specified, then output is directed to a file that has the same pathname as the first element in the input list, but its extension is .LNK. If the first element in the list is a PUBLICSONLY control, then the first pathname in its argument is used for the default name.

If the BIND control is specified, then the default name for the output file has no extension, and the object module can be executed without locating.

The *controls* can be any subset of the controls specified in the next section.

LINK86 Controls

The *controls* are described in table 2-1.

Table 2-1. Summary of LINK86 Controls

Control	Abbrev.	Default
ASSIGN({ <i>variable</i> (address)}{,...})	AS	Not applicable
ASSUMEROOT(<i>pathname</i>)	AR	Not applicable
BIND	BI	NOBIND
NOBIND	NOBI	
COMMENTS	CM	COMMENTS
NOCOMMENTS	NOCM	
FASTLOAD	FL	NOFASTLOAD
NOFASTLOAD	NOFL	
INITCODE	IC	Not applicable
LINES	LI	LINES
NOLINES	NOLI	
MAP	MA	MAP
NOMAP	NOMA	
MEMPOOL(<i>min-size</i> {, <i>max-size</i> })	MP	Not applicable
NAME(<i>module name</i>)	NA	Not applicable
OBJECTCONTROLS({LINES NOLINES COMMENTS NOCOMMENTS SYMBOLS NOSYMBOLS PUBLICS [EXCEPT(<i>symbol</i> {,...})] NOPUBLICS [EXCEPT(<i>symbol</i> {,...})] TYPE NOTYPE PURGE NOPURGE}{,...})	OC	Not applicable
ORDER({ <i>group</i> ({ <i>segment</i> { \class[\overlay] } {,...} } {,...})	OD	Not applicable

Table 2-1. Summary of LINK86 Controls (Cont'd.)

Control	Abbrev.	Default
OVERLAY[<i>overlay</i>]	OV	NOOVERLAY
NOOVERLAY	NOOV	
PRINT[<i>pathname</i>]	PR	PRINT(<i>object file</i> .MP1)
NOPRINT	NOPR	
PRINTCONTROLS({ LINES NOLINES COMMENTS NOCOMMENTS SYMBOLS NOSYMBOLS PUBLICS [EXCEPT(<i>symbol</i> [,...])] NOPUBLICS [EXCEPT(<i>symbol</i> [,...])] TYPE NOTYPE PURGE NOPURGE } [,...])	PC	Not applicable
PUBLICS [EXCEPT(<i>symbol</i> [,...])]	PL [EC]	PUBLICS
NOPUBLICS [EXCEPT(<i>symbol</i> [,...])]	NOPL[EC]	
PUBLICSONLY(<i>pathname</i> [,...])	PO	Not applicable
PURGE	PU	NOPURGE
NOPURGE	NOPU	
RENAMEGROUPS({ <i>group</i> TO <i>group</i> } [,...])	RG	Not applicable
SEGSIZE({ <i>segment</i> [\ <i>class</i> [\ <i>overlay</i>]] (<i>min-size</i> [, <i>max-size</i>])} [,...])	SS	Not applicable
SYMBOLS	SB	SYMBOLS
NOSYMBOLS	NOSB	
SYMBOLCOLUMNS({1 2 3 4})	SC	SYMBOLCOLUMNS(2)
TYPE	TY	TYPE
NOTYPE	NOTY	

If you specify a control more than once in a single invocation line, only the last version entered counts. For example, if you enter NOMAP on the invocation line and then later decide you want a link map, you can specify MAP. The ASSIGN control, however, is an exception to this general rule.

The following controls are effective only when the BIND control is specified:

- FASTLOAD
- MEMPOOL
- ORDER
- PRINTCONTROLS
- SEGSIZE
- SYMBOLCOLUMNS

The following control is effective only when the BIND control is NOT specified:

- INITCODE

The following control is effective only when the OVERLAY control is specified:

- ASSUMEROOT

At the end of this document you will find operating system-specific examples of the LINK86 controls. Fold out the pages containing the examples relevant to your operating environment and use them in conjunction with the syntax conventions provided in this chapter.

Syntax

```
ASSIGN ( {variable-name (address) } [, ...] )
```

Abbreviation

AS

Default

Not applicable

Definition

ASSIGN makes it possible to define absolute addresses for symbols at LINK time. The absolute address associated with the *variable-name* is specified in *address*, which should be an absolute 20-bit memory address that conforms to PL/M-86 notation. The *variable-name* is internally defined as a PUBLIC symbol.

Notes

- This control is particularly useful for memory-mapped I/O.
- If the *variable-name* has a matching public definition in another module, the public definition in that module is flagged as a duplicate. Whenever a reference to the *variable-name* occurs, the variable defined in the ASSIGN control governs.
- If multiple ASSIGN specifications are provided in one LINK86 invocation, *all* will be effective (not only the final entry).

Syntax

ASSUMEROOT (*pathname*)

Abbreviation

AR

Default

Not applicable

Definition

ASSUMEROOT suppresses the inclusion of any library module(s) in an overlay if the library module(s) have already been included in a root file identified by *pathname*. When this control is used, the root file is scanned, and all external, undefined symbols in the overlay modules which have a matching definition in the root file are marked “temporarily resolved.” This marking means that while a library search for the symbols will not be made, their status remains externally undefined until the overlays are linked with the root.

Notes

- This control should be used only in conjunction with the OVERLAY control and libraries.
- This control will not eliminate common library modules from overlay to overlay.
- This control may not be used when an input module already has an overlay record.

Syntax

BIND
NOBIND

Abbreviation

BI
NOBI

Default

NOBIND

Definition

BIND combines the input modules into a load-time-locatable (LTL) module. An LTL module may be loaded and executed, and any logical reference to a segment or group base can be resolved at load time. The load-time-locatable output cannot be loaded by the ICE-86 loader or UPM.

Notes

- FASTLOAD, MEMPOOL, ORDER, SEGSIZE, and SYMBOLCOLUMNS have no effect when NOBIND is specified.
- When NOBIND is in effect, [NO]LINES, [NO]SYMBOLS, [NO]PUBLICS, and [NO]PURGE affect only the output object module.
- When BIND is specified, the default object file name has no extension.

Syntax

COMMENTS
NOCOMMENTS

Abbreviation

CM
NOCM

Default

COMMENTS

Definition

COMMENTS allows object file comment records to remain in the output module. The NOCOMMENTS control removes all comment records except those designated as nonpurgable.

Comment records are added to the object module for various reasons. All translators add a comment record, identifying the compiler or assembler that produced it.

Comment records are superfluous to the production of executable code and may be removed at any time during the development process.

Notes

- See PURGE, PRINTCONTROLS and OBJECTCONTROLS.
- COMMENT records should not be removed when you submit an object file in a Software Problem Report.
- NOCOMMENTS will decrease the size of the output object file.

Syntax

FASTLOAD
NOFASTLOAD

Abbreviation

FL
NOFL

Default

NOFASTLOAD

Definition

FASTLOAD reduces program loading time by causing data record concatenation. The data records are concatenated to a maximum length of 64K. FASTLOAD also makes the object file compact by removing such information as local symbols, public records, comments, and type information (unless the object file contains unresolved external symbols).

Notes

- This control is effective only when BIND is specified.
- Output produced with this control in effect may be incompatible with LINK86 versions earlier than 2.0.

Syntax

INITCODE

Abbreviation

IC

Default

Not applicable

Definition

INITCODE causes LINK86 to create a new segment that contains code to initialize the segment registers. The equivalent assembly language code is shown below:

```

STACKFRAME  DW    stack frame
DATAFRAME   DW    data frame
EXTRAFRAME  DW    extra frame
             CLI
             MOV   SS, CS:STACKFRAME
             MOV   SP, stack offset
             MOV   DS, CS:DATAFRAME
             MOV   ES, CS:EXTRAFRAME
             JMP   program start

```

Notes

- The initialization code segment is created only if a register initialization record for 8086 segment registers exists in the input. These register initialization records are automatically produced by 8086-based translators for main modules.
- BIND and OVERLAY controls used in conjunction with INITCODE will cause LINK86 to ignore the INITCODE control and issue a warning message.
- INITCODE should be used to ensure compatibility with 8085-based LINK86, LOC86, and LIB86 products.
- The name of the new segment, if created, is ??INITCODE.

Syntax

LINES
NOLINES

Abbreviation

LI
NOLI

Default

LINES

Definition

LINES allows line number information to remain in the object file. ICE-86 and other debuggers use this information. The line number information is not needed to produce executable code. The NOLINES control removes this information from the output file.

Notes

- See PRINTCONTROLS and OBJECTCONTROLS.
- See the PURGE control.
- NOLINES will decrease the size of the output object file.
- Unless BIND is in effect, LINES/NOLINES affects only the object module.
- LINES has no effect on local symbols; the inclusion of local symbol records in the object file is controlled by SYMBOLS.

Syntax

MAP
NOMAP

Abbreviation

MA
NOMA

Default

MAP

Definition

MAP produces a link map and inserts it in the PRINT file. The link map contains information about the attributes of logical segments in the output module. This includes size, class, alignment attribute, address (if the segment is absolute) and overlay name (if the segment is a member of an overlay).

NOMAP inhibits the production of the link map.

Notes

- MAP can be overridden by the NOPRINT control.
- See the discussion of the link map at the end of this chapter.

Syntax

MEMPOOL (*minimum-size* [, *maximum-size*])

Abbreviation

MP

Default

Not applicable.

Definition

MEMPOOL specifies the dynamic memory requirements of the program. This allows the loader to check free memory at load time, and prevent a run-time error.

The *minimum size* is a 20-bit number. There are three ways of specifying this value:

- + indicates that the number should be added to the current dynamic memory requirements.
- — indicates that the number should be subtracted from the current dynamic memory requirements.
- no sign indicates that the number should become the new minimum dynamic memory requirement.

The *maximum size* is a 20-bit number. There are two ways of specifying this value:

- + indicates that the number should be added to the current minimum dynamic memory requirement.
- no sign indicates that the number should become the new maximum dynamic memory requirement.

Notes

- The *minimum-size* must be less than or equal to the *maximum-size*.
- MEMPOOL has no effect unless the BIND control is also specified.

Syntax

NAME (*module name*)

Abbreviation

NA

Default

The module name of the first element in the input list.

Definition

NAME assigns the specified *module name* to the output module. If NAME is not specified, then the output module will have the name of the first module in the input list.

The *module name* may be up to 40 characters long. It may be composed of any of the following characters in any order:

- ? (question mark),
- @ (commercial at),
- : (colon),
- . (period),
- _ (underscore),
- A, B, C, ..., Z or
- 0, 1, 2, ..., 9.

Lower-case letters may be used, but they are automatically converted to uppercase.

Notes

- NAME does not affect the output file's name. Only the module name in the output module's header record is changed.

Syntax

```
OBJECTCONTROLS({LINES | NOLINES |  
                COMMENTS | NOCOMMENTS |  
                SYMBOLS | NOSYMBOLS |  
                PUBLICS [EXCEPT(symbol[,...])] |  
                NOPUBLICS [EXCEPT(symbol[,...])] |  
                TYPE | NOTYPE |  
                PURGE | NOPURGE} [,...]  
)
```

Abbreviation

OC

Default

Controls apply to both the print file and the object file.

Definition

OBJECTCONTROLS causes the controls specified in its arguments to be applied to the object file only. Comment records, line number records, local and public symbol records, and symbol type records are selectively included or excluded from the object file. This will not affect the print file nor the information contained in it.

Notes

- Abbreviations for the controls within the parentheses may be given.
- A control specified in *both* OBJECTCONTROLS and PRINTCONTROLS has the same effect as specifying it *once* outside of these controls.

Syntax

```
ORDER ( {group name ( {segment name  
                        [ \class name [ \overlay name] ] }  
                        [ , ... ] ) }  
      [ , ... ] )
```

Abbreviation

OD

Default

Segments are placed into object file in the same order in which they were encountered in the input list.

Definition

ORDER specifies a partial or complete order for the segments in one or more groups.

The *group name* identifies the group whose segments are to be ordered.

The *segment name* identifies the segments to be ordered. The *\class name* and *\overlay name* may be used to resolve conflicts with duplicate segment names. If *\overlay name* is specified, the *\class name* is required.

Notes

- ORDER has no effect unless BIND is also specified.
- If one of the segments specified is not contained in the designated group, an error message is generated.
- See discussion of module combination at the end of the chapter for details of the default ordering.

Syntax

```
OVERLAY[(overlay name)]  
NOOVERLAY
```

Abbreviation

```
OV  
NOOV
```

Default

```
NOOVERLAY
```

Definition

OVERLAY specifies that all of the input modules shall be combined into a single overlay module. When the optional *overlay name* argument is specified, all segments contained within the overlay module have that name in addition to their segment names and class names. When *overlay name* is not specified, LINK86 uses the module name of the first module in the input list.

Notes

- Each overlay in a given program must be linked separately before they are all linked into a single object module.
- The overlay specified in the argument must be the same as the overlay name used when calling the operating system to load the overlay.
- When linking root and overlay files, LINK86 assumes the first file in the invocation line is the root.
- The ASSUMEROOT control can be specified in conjunction with the OVERLAY control.

Syntax

```
PRINT[(pathname)]  
NOPRINT
```

Abbreviation

```
PR  
NOPR
```

Default

```
PRINT (object file .MP1)
```

Definition

PRINT allows you to direct the link map and other diagnostic information to a particular file. If the PRINT control is not specified or if the control is given without an argument, the print file will have the same pathname as the output file except the extension will be .MP1. NOPRINT prevents the creation of this file.

Notes

- The discussion at the end of this chapter describes the contents of the print file.
- MAP, SYMBOLCOLUMNS, LINES, SYMBOLS, PUBLICS and PRINTCONTROLS affect the contents of the print file.

Syntax

```
PRINTCONTROLS({LINES | NOLINES |  
              COMMENTS | NOCOMMENTS |  
              SYMBOLS | NOSYMBOLS |  
              PUBLICS [EXCEPT(symbol[,...])] |  
              NOPUBLICS [EXCEPT(symbol[,...])] |  
              TYPE | NOTYPE |  
              PURGE | NOPURGE}[, ...]  
              )
```

Abbreviation

PC

Default

Controls apply to both the print file and the object file.

Definition

PRINTCONTROLS causes the controls specified in its arguments to be applied to the print file only. Line number information, and local and public symbol information are selectively included or excluded from the print file. This will not affect the object file or the information contained in it.

Notes

- When a control is specified in both the PRINTCONTROLS and the OBJECTCONTROLS, it has the same effect as specifying it once outside of these controls.
- Abbreviations to the parenthesized controls may be used.
- Unless BIND is specified, PRINTCONTROLS and its arguments have no effect.

Syntax

```
PUBLICS [EXCEPT (public symbol [,...])]  
NOPUBLICS[EXCEPT (public symbol [,...])]
```

Abbreviation

```
PL [EC]  
NOPL [EC]
```

Default

```
PUBLICS
```

Definition

PUBLICS causes the public symbol records to be kept in the object file and the corresponding information to be placed in the print file. Public symbol records are needed to resolve external symbol definitions in other files. The EXCEPT sub-control allows you to modify the control. Public records are used by LINK86 to resolve external references.

Notes

- The scope of PUBLICS can be modified by PRINTCONTROLS and OBJECTCONTROLS.
- Unless BIND is specified PUBLICS/NOPUBLICS affect only the object file.
- NOPUBLICS will decrease the size of the output object file.

Syntax

`PUBLICSONLY (pathname [, ...])`

Abbreviation

P0

Default

Not applicable

Definition

`PUBLICSONLY` is an input list control. When used it must appear in the input list and not the control list.

`PUBLICSONLY` indicates that only the absolute public symbol records of the argument files will be used. The other records in the module will be ignored. This can be used to resolve external references to 8089 files and overlays when a multiframe overlay system is desired.

Notes

- Although it is possible to create overlays using `PUBLICSONLY`, it is easier to use the `OVERLAY` control to create overlays.

Syntax

PURGE
NOPURGE

Abbreviation

PU
NOPU

Default

NOPURGE

Definition

PURGE in the control list is exactly the same as specifying NOLINES, NOSYMBOLS, NOCOMMENTS, NOPUBLICS, and NOTYPE. NOPURGE in the control list is the same as specifying LINES, SYMBOLS, COMMENTS, PUBLICS, and TYPE.

PURGE removes all of the debug or public records from the object file and their information from the print file. It will produce the most compact object file possible.

The records that would be included by NOPURGE are useful to debuggers, but otherwise they are unnecessary for producing executable code.

Notes

- PRINTCONTROLS and OBJECTCONTROLS can be used to modify the scope of PURGE.
- Unless BIND is specified, PURGE affects only the output object file.

Syntax

```
RENAMEGROUPS({group name TO group name} [, ...])
```

Abbreviation

RG

Default

All groups keep the name they already have.

Definition

RENAMEGROUPS allows you to change the group names assigned by the translator. The first *group name* must be an existing group in one of the modules in the input list.

Notes

None

Syntax

```
SEGSIZE ( {segment name[\class name[\overlay name]]
          (minimum size [, [maximum size]]) }
          [, ...] )
```

Abbreviation

SS

Default

Not applicable

Definition

SEGSIZE allows you to specify the minimum memory space needed for any segment. If you specify the maximum size for a segment, that segment must either not be a member of any group or be the last segment in the group.

The *segment name* identifies the segment whose size is to be changed.

The *minimum size* is a 16-bit number. There are three ways of specifying this value:

- + indicates that the number should be added to the current segment length.
- — indicates that the number should be subtracted from the current segment length.
- no sign indicates that the number should become the new segment length.

The *maximum size* is a 16-bit number. There are two ways of specifying this value:

- + indicates that the number should be added to the minimum segment length.
- no sign indicates that the number should become the new maximum segment length.

Notes

- The maximum segment size must always be greater than or equal to the minimum segment size.
- Segment lengths are initially assigned by the translator.
- Unless BIND is also specified SEGSIZE has no effect.

Syntax

SYMBOLS
NOSYMBOLS

Abbreviation

SB
NOSB

Default

SYMBOLS

Definition

SYMBOLS specifies that all local symbol records shall be included in the object file. Local symbol records are used by debuggers.

Notes

- Unless BIND is also specified, SYMBOLS affects only the output object file.
- NOSYMBOLS will decrease the size of the output object file.
- SYMBOLS has no effect on line numbers; the inclusion of line numbers in the object file is controlled by the LINES control.

Syntax

```
SYMBOLCOLUMNS({1 | 2 | 3 | 4})
```

Abbreviation

SC

Default

```
SYMBOLCOLUMNS(2)
```

Definition

SYMBOLCOLUMNS indicates the number of columns to be used when producing the symbol table for the object module. Two columns fit on a 78-character line; four columns fit on a single 128-character line printer line.

Notes

- SYMBOLCOLUMNS has no effect unless BIND is also specified.

Syntax

TYPE
NOTYPE

Abbreviation

TY
NOTY

Default

TYPE

Definition

TYPE specifies that type checking is to be performed on the object file. Symbol type records produced by the translator are used by LINK86 to perform type checking on modules. Symbol type records should be kept in the file if it may be relinked with another file.

Notes

- NOTYPE will decrease the size of the output object file without affecting run-time operation.

LINK86's Print File

The print file is always created unless you specify NOPRINT. The optional argument to PRINT designates the name of the print file. The default print file is the object file with the extension .MP1.

The print file may contain as many as five parts:

1. A header (always in the print file)
2. A link map (requires MAP)
3. A group map (requires BIND)
4. A symbol table (requires BIND and PUBLICS, LINES, or SYMBOLS)
5. An error message list (always included when they occur)

The Header

The header is self-explanatory; it identifies the 8086 linker by version number and gives the important details about the input and output files used during this execution. Figure 2-2 shows an example of LINK86's print file header.

```

system-id 8086 LINKER, Vx.y
INPUT FILES: : pathname1,pathname2
OUTPUT FILE: : pathname3
CONTROLS SPECIFIED IN INVOCATION COMMAND:
  BIND
DATE: MM/DD/YY    TIME: HH:MM:SS
  
```

Figure 2-2. LINK86 Print File Header

The Link Map

The link map supplies useful information about segments in the object file — order, size, alignment attribute, and segment, class, and overlay names. Figure 2-3 shows LINK86's link map.

```

LINK MAP OF MODULE ROOT
LOGICAL SEGMENTS INCLUDED:
LENGTH ADDRESS ALIGN SEGMENT CLASS OVERLAY
09B6H ----- w CODE CODE
0016H ----- w CONST CONST
0B38H ----- w DATA DATA
0442H ----- w STACK STACK
0000H ----- w MEMORY MEMORY
0000H ----- G ??SEG
INPUT MODULES INCLUDED:
pathname1(ROOT)
  
```

Figure 2-3. LINK86 Link Map

The map consists of three parts:

- Segment map
- Input module list
- Unresolved symbol list

The segment map describes all of the segments included in the object file. Each segment description includes five entries: length, the address (if the segment is absolute), alignment attribute, segment name, class name and overlay name, if any.

A segment may have any one of the following alignment attributes:

A absolute
 B byte
 G paragraph
 M member of an LTL group
 P page
 W word
 R in-page

In-page alignment means that the entire segment must be resident within a single 256-byte page. The address of the first byte in any page has zeros in the first 2-hexadecimal digits (00H, 100H, 200H,...0FFF00H).

The module list identifies the order of modules included in the output file. LINK86 gives both the file containing the module and the module name for each entry in the list.

The unresolved symbol list itemizes each external symbol whose public definition was not encountered. The module that references the unresolved symbol is also indicated. The printed message that appears under the heading UNRESOLVED EXTERNAL NAMES is as follows:

- *symbol name* IN *pathname* (*module name*)
- If ASSUMEROOT is specified, the message would read:
symbol name (DEFINED IN ROOT-FILE,*pathname*)
- If PUBLICS/NOPUBLICS EXCEPT is specified, the message would read:
symbol name IN LINK86 COMMAND LINE

The Group Map

LINK86 produces a group map when the BIND control is specified. Each group name and all segments contained in that group are listed. The offset from the group base for each segment appears to the right of the segment name. Figure 2-4 shows an example of the group map.

GROUP MAP		
GROUP NAME: CGROUP		
OFFSET	SEGMENT NAME	
0000H	CODE	
GROUP NAME: DGROUP		
OFFSET	SEGMENT NAME	
0000H	CONST	
0016H	DATA	
0B4EH	STACK	
0F90H	MEMORY	

Figure 2-4. LINK86 Group Map

The Symbol Table

LINK86 produces a symbol table only when the following conditions are true:

1. BIND is specified
2. PRINT and MAP controls are in effect.
3. At least one of the following controls is in effect: PUBLICS, LINES, or SYMBOLS.

Figure 2-5 shows LINK86's symbol table with the SYMBOLCOLUMNS set at two (the default). The symbol table is shown in two parts: the top section contains the public symbol information; the lower section contains line and local symbol information.

SYMBOL TABLE OF MODULE ROOT							
BASE	OFFSET	TYPE	SYMBOL	BASE	OFFSET	TYPE	SYMBOL
G(2)	0166H	PUB	BINDCONTROL	G(2)	004CH	PUB	BNODEBASE
G(2)	0018H	PUB	BUFBASE	G(2)	0016H	PUB	BUFLEN
G(2)	004EH	PUB	CLASHNODEBASE	G(2)	0060H	PUB	COCONN
G(2)	015AH	PUB	COMMENTSCONTROL	G(2)	0171H	PUB	CURRENTOVERLAYNU
G(2)	0173H	PUB	DEBUGTOGGLE	G(2)	00A7H	PUB	DEFAULTPRTFILENA
G(2)	0062H	PUB	EXCEPTION	G(2)	0048H	PUB	FANODEBASE
G(2)	006EH	PUB	FBLOCKBASE	G(2)	006AH	PUB	FBLOCKLISTHEAD
G(2)	006CH	PUB	FBLOCKLISTTAIL	G(2)	013DH	PUB	FBLOCKSEQUENCENU
G(2)	004AH	PUB	FBNODEBASE	G(2)	0046H	PUB	FDNODEBASE
G(2)	0044H	PUB	FENODEBASE	G(2)	0040H	PUB	FFNODEBASE
G(2)	0034H	PUB	FIRSTBNODEP	G(2)	0028H	PUB	FIRSTXNODEP
G(2)	002CH	PUB	FIRSTGRNODEP	G(2)	001CH	PUB	FIRSTMNODEP
G(2)	0030H	PUB	FIRSTOVNODEP	G(2)	0050H	PUB	FIRSTRENAMEBLOCK
G(2)	0020H	PUB	FIRSTSGNODEP	G(2)	0024H	PUB	FIRSTTDNODEP
G(2)	0038H	PUB	GRNODEBASE	G(2)	0B4CH	PUB	HIGHESTDATALOCAT
							-ION

MODULE NAME = ROOT							
BASE	OFFSET	TYPE	SYMBOL	BASE	OFFSET	TYPE	SYMBOL
G(2)	0F90H	SYM	MEMORY	G(2)	0000H	SYM	COPYRIGHT
G(2)	0016H	SYM	BUFLEN	G(2)	0018H	SYM	BUFBASE
G(1)	00F7H	SYM	ERROR	G(1)	00FEH	SYM	WARNING
G(2)	001AH	SYM	LASTNMNODEP	G(2)	001CH	SYM	FIRSTNMNODEP
G(2)	001EH	SYM	LASTSGNODEP	G(2)	0020H	SYM	FIRSTSGNODEP
G(2)	0022H	SYM	LASTTDNODEP	G(2)	0024H	SYM	FIRSTTDNODEP
G(2)	0026H	SYM	LASTXNODEP	G(2)	0026H	SYM	FIRSTXNODEP
G(2)	002AH	SYM	LASTGRNODEP	G(2)	002CH	SYM	FIRSTGRNODEP
G(2)	002EH	SYM	LASTOVNODEP	G(2)	0030H	SYM	FIRSTOVNODEP
G(2)	0032H	SYM	LASTBNODEP	G(2)	0034H	SYM	FIRSTBNODEP
G(2)	0036H	SYM	SGNODEBASE	G(2)	0038H	SYM	GRNODEBASE
G(2)	003AH	SYM	SYNODEBASE	G(2)	003CH	SYM	NMNODEBASE
G(2)	003EH	SYM	TDNODEBASE	G(2)	0040H	SYM	FFNODEBASE
G(2)	0042H	SYM	OVNODEBASE	G(2)	0044H	SYM	FENODEBASE
G(2)	0046H	SYM	FDNODEBASE	G(2)	0048H	SYM	FANODEBASE
G(2)	004AH	SYM	FBNODEBASE	G(2)	004CH	SYM	BNODEBASE
G(2)	004EH	SYM	CLASHNODEBASE	G(2)	0050H	SYM	FIRSTRENAMEBLOCK
							-P

Figure 2-5. LINK86 Symbol Table

G(2)	01A4H	SYM	SIGNONMSG	G(1)	0174H	SYM	PRINTNAME
G(1)	01A3H	SYM	INITIALIZEINPUT	G(1)	01A6H	SYM	OPENFBLOCKFILE
G(1)	01F6H	SYM	CLOSEFBLOCKFILE	G(1)	00F7H	LIN	7
G(1)	00FAH	LIN	10	G(1)	00FEH	LIN	11
G(1)	0101H	LIN	14	G(1)	0105H	LIN	73
G(1)	0106H	LIN	75	G(1)	010FH	LIN	76
G(1)	0118H	LIN	77	G(1)	0110H	LIN	78
G(1)	0126H	LIN	79	G(1)	012AH	LIN	80
G(1)	012DH	LIN	84	G(1)	0136H	LIN	85
G(1)	013DH	LIN	86	G(1)	0144H	LIN	87
G(1)	0151H	LIN	88	G(1)	015AH	LIN	89
G(1)	0168H	LIN	90	G(1)	0170H	LIN	91
G(1)	0174H	LIN	94	G(1)	0177H	LIN	96
G(1)	018EH	LIN	97	G(1)	0198H	LIN	98
G(1)	019FH	LIN	99	G(1)	01A3H	LIN	100
G(1)	01A6H	LIN	103	G(1)	01A8H	LIN	105
G(1)	01ABH	LIN	106	G(1)	01BEH	LIN	107
G(1)	01C8H	LIN	108	G(1)	01CFH	LIN	109

REFERENCES TO SEGMENT BASES EXIST IN INPUT MODULES:							
ROOT							

Figure 2-5. LINK86 Symbol Table (Cont'd.)

BASE is usually a symbolic group or segment index. If the base is the stack, then STACK is used instead of the index.

OFFSET is a four-digit hexadecimal number that is the offset of the symbol or line from BASE, or from the current BP for stack symbols.

TYPE describes the kind of symbol it is. There are four possible entries in the TYPE column:

BAS based on an other symbol's value
 LIN line (not a symbol)
 PUB public symbol (alphabetized within each separate BASE)
 SYM local symbol

SYMBOL refers to the name of the symbol or number of the line. If the SYMBOLCOLUMNS value is one, this field is 40 characters wide. Otherwise, this field is 16 characters wide. If the symbol name is longer than the width of the field, then the name is hyphenated and continued on the next line.

If there are any references to segment bases in the input modules (if the output module is an LTL program), LINK86 prints the following message at the bottom of figure 2-5. The message identifies all input modules containing such references. These references are to be resolved by the system loader or LOC86.

Error Messages

The warning messages are listed consecutively as warning situations are encountered. They may appear before or after the link map. Errors always terminate processing—an error message will always be the last line in the print file.

See the discussion of the interpretation of individual messages in Appendix C.

CREF86 scans 8086 object modules to provide a cross-reference among external and public symbols in multiple modules. CREF86 accepts a list of files and controls as input and produces one output file: a print file.

Figure 3-1 illustrates the types of input accepted and output produced. The input modules may include one or more of the following 8086 object modules:

- Unlinked modules from one or more translators
- Library files or specific library modules
- Linked modules

The output file consists of information about files and modules, plus an alphabetically sorted list of external and public symbols. Information printed for each symbol includes the name of the module defining the symbol and the name(s) of the module(s) declaring the symbol as external.

This chapter provides details concerning the CREF86 invocation, controls, and cross-reference listing. For definition of file-naming and syntax notation conventions used in this chapter, refer to Notational Conventions following the Preface. For a summary of the CREF86 controls and information on error and warning messages which may be produced, refer to Appendix E. For details concerning CREF86 symbol table space limitations, refer to Appendix C.

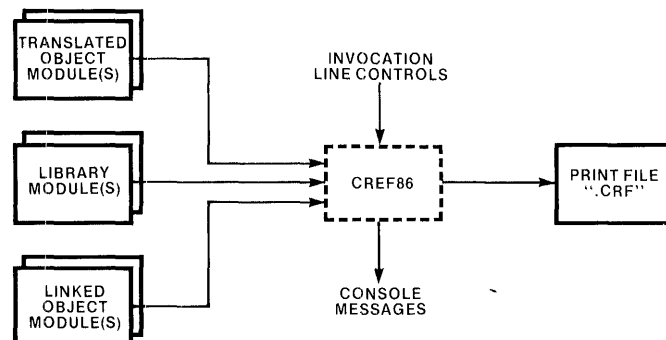

Figure 3-1. CREF86 Input and Output Files

121616-5

CREF86 Invocation Line

The general syntax for invocation is:

`[directory-name]CREF86 input list[controls]`

The *input list* is one or more modules to be scanned for external-public cross-references:

`pathname[(module name[, ...])][, ...]`

Unless a *module name* is specified, all modules in a *pathname* are included in the cross-reference listing produced. If the *pathname* is a library file, any modules named in parentheses are included in the cross-reference listing, even if they do not contain public symbol definitions for external symbols declared elsewhere in the *input list*.

Either all or none of the *pathnames* may contain overlay records (produced by LINK86 with the OVERLAY control). If the input modules do contain overlay records, the first file named in the invocation is considered to be the root file; the rest are treated as overlays.

The *controls* can be any subset of the controls described in the next section.

CREF86 Controls

The *controls* specify cross-reference listing attributes such as print file name, the title at the top of each listing page, and the amount of information printed on each page. The *controls* are described in table 3-1.

Table 3-1. Summary of CREF86 Controls

Control	Abbrev.	Default
PAGELength(<i>number</i>)	PL	PAGELength(60)
PAGEWIDTH(<i>number</i>)	PW	PAGEWIDTH(120)
PRINT[(<i>pathname</i>)]	PR	PRINT(<i>first input file.CRF</i>)
TITLE(<i>character-string</i>)	TT	Not applicable

If there are multiple occurrences of any control in the invocation line, the rightmost occurrence governs.

At the end of this document you will find operating system-specific examples of the CREF86 controls. Fold out the pages containing the examples relevant to your operating environment and use them in conjunction with the syntax conventions provided in this chapter.

Syntax

PAGELNGTH (*number*)

Abbreviation

PL

Default

PAGELNGTH(60)

Definition

PAGELNGTH specifies the number of lines to be printed on each page. The *number* must be a decimal value between 10 and 255, inclusive.

Notes

None

Syntax

PAGEWIDTH (*number*)

Abbreviation

PW

Default

PAGEWIDTH(120)

Definition

PAGEWIDTH specifies the maximum number of characters to be printed on a single line. The *number* must be a decimal value from 80 to 132, inclusive.

Notes

- PAGEWIDTH truncates the TITLE if TITLE is greater than the number of unused character locations on the title line.
- If the specified PAGEWIDTH does not allow enough space to print the referring module name(s) on the same line as the defining module name, the referring module names(s) will be printed on separate lines.

Syntax

PRINT[(*pathname*)]

Abbreviation

PR

Default

PRINT (*first input file* .CRF)

Definition

PRINT provides the ability to specify a *pathname* for the cross-reference listing. The *pathname* identifies the destination of the listing. If the PRINT control is not specified or if the control is given without an argument, the print file will have the same pathname as the first file in the input list, except the extension will be .CRF.

Notes

- If no PRINT control is specified, output goes to a default file. The name of the default file is the name of the first file in the invocation command with the extension .CRF.
- If PRINT is specified with no *pathname*, output goes to the default file.

Syntax

TITLE (*character string*)

Abbreviation

TT

Default

Not applicable

Definition

TITLE may be used to specify a heading having a *character string* of null to 80 characters, inclusive. This heading appears on the first line of every page of the cross-reference listing.

Notes

- The TITLE string is truncated if the PAGEWIDTH control is not large enough to accommodate the entire string.
- If the *character string* contains any characters defined by the operating system as special, the string must be delimited in accord with operating system conventions for special characters and string delimiters.

CREF86's Print File

The print file is a cross-reference listing of external and public symbols in the input modules. This listing consists of the following parts:

- A header
- Warnings (if any)
- Module list
- Cross-reference information

Header

Figure 3-2 illustrates the components printed in this part of the cross-reference listing:

- A title line output by CREF86, usually consisting of a program identifier (CREF86), any user-defined TITLE, date of listing, and the page number
- A line identifying the CREF86 environment (operating system and version number)
- One or more lines summarizing the pathnames of input files
- A line for identifying the print file pathname
- One or more lines giving the controls specified at invocation, present only if controls were specified

Warnings

Figure 3-3 illustrates how warning messages appear on the cross-reference listing when CREF86 detects such conditions as mismatched types, modules not found, etc. Refer to Appendix E for information on CREF86 error and warning messages.

```

CREF86  EXAMPLE OF CROSS REFERENCE USING CREF86                                MM/DD/YY          PAGE
system-id CREF86 Vx.y

INPUT FILES:      pathname1      pathname2      pathname3      pathname4      pathname5      pathname6
                  pathname7      pathname8      pathname9      pathname10     pathname11     pathname12
                  pathname13     pathname14     pathname15     pathname16     pathname17
OUTPUT FILE:      pathname18
CONTROLS SPECIFIED: PR(OUT) TT(EXAMPLE OF CROSS REFERENCE USING CREF86) PW(120) PL(60)
  
```

Figure 3-2. Header of Cross-Reference Listing

```

WARNING 19: TYPE MISMATCH
FILE:      pathname15
MODULE: MISMATCH
SYMBOL: ENAMEID
WARNING 19: TYPE MISMATCH
FILE:      pathname15
MODULE: MISMATCH
SYMBOL: FOUR
WARNING 20: SPECIFIED MODULE NOT FOUND
FILE:      pathname18
MODULE: UNKNOWN_MODULE
  
```

Figure 3-3. Warning Messages on CREF86 Listing

Module List

The module list, shown in figure 3-4, is a tabulated summary of all input files and corresponding modules included from these files.

After the module list is printed, the rest of the page is skipped, so that the symbol cross-references begin on the next new page.

MODULES INCLUDED:					
FILE NAME	MODULE NAME(S)				
pathname1	CREF86				
pathname2	PARSE				
pathname3	SIGNON				
pathname4	NEXTSTATE				
pathname5	ERROR				
pathname6	UTILITIES				
pathname7	MEMORYMANAGEMENT				
pathname8	SCANMODULES				
pathname9	PROCESSRECORDS				
pathname10	SCANUTILITIES				
pathname11	LISTOUTPUT				
pathname12	LISTUTILITIES				
pathname13	SYMBOLSORT				
pathname14	OBJMAN				
pathname15	MISMATCH				
pathname16	DQALLOCATE	DQATTACH	DQCHANGEEXTENSION	DQCREATE	DQDECODEEXCEPTION
pathname17	DQDETACH	DQEXIT	DQFREE	DQGETARGUMENT	DQGETSYSTEMID
	DQGETTIME	DQOPEN	DQREAD	DQSEEK	DQWRITE
	SYSTEMSTACK				

Figure 3-4. Module List on CREF86 Listing

Symbol Cross-Reference Information

Figure 3-5 illustrates the format for listing data for all external and public symbols referenced in the Module List.

The first column contains the names of the external and public symbols, in alphabetical order.

The second column identifies the type of each symbol, as declared in the external or public reference. The following tabulation identifies the entries which may occur in this column:

CREF86 Entry	Symbol Type
BYTE	8-bit unsigned
WORD	16-bit unsigned
DWORD	32-bit unsigned
LWORD	64-bit unsigned
INTEGER (n)	n = 1, 2, 4, or 8 bytes
REAL (n)	n = 1, 2, 4, or 8 bytes
POINTER	
STRUCTURE	
ARRAY OF	
UNKNOWN	null
FILE	
LABEL	
PROCEDURE	
(NEAR, FAR)	
CONSTANT	
SELECTOR	

The symbol type that appears in the second column is that associated with the first occurrence of that symbol in the input list.

```

CREF86      EXAMPLE OF CROSS REFERENCE USING CREF86                               MM/DD/YY          PAGE 3

SYMBOL NAME          SYMBOL TYPE          DEFINING MODULE; REFERRING MODULE(S)
-----
ACCESS_PAGE . . . . . UNKNOWN          OBJMAN
ALLOCATE . . . . . UNKNOWN          OBJMAN
APPENDNODE . . . . . PROCEDURE NEAR    UTILITIES
APPENDUDSMNODE . . . . . PROCEDURE NEAR    UTILITIES;          PARSE  SCANMODULES  PROCESSRECORDS
ARRAYBASE . . . . . POINTER          SYMBOLSORT;
ATOI . . . . . PROCEDURE WORD NEAR    UTILITIES;          PARSE
BTOK . . . . . PROCEDURE WORD NEAR    UTILITIES;          LISTUTILITIES
BUBBLESORTVARNAMES . . . . . PROCEDURE NEAR    SYMBOLSORT;          LISTOUTPUT
BUMLINECOUNT . . . . . PROCEDURE NEAR    LISTUTILITIES;      LISTOUTPUT
CHECKHEADER . . . . . PROCEDURE NEAR    SCANUTILITIES;      SCANMODULES
CHECKOVERLAY . . . . . PROCEDURE NEAR    SCANUTILITIES;      SCANMODULES
CHECKVARTYPE . . . . . PROCEDURE BYTE NEAR  SCANUTILITIES;      PROCESSRECORDS
CMPNAMES . . . . . PROCEDURE BYTE NEAR  LISTUTILITIES;      SYMBOLSORT
CMPSTRNGS . . . . . PROCEDURE BYTE NEAR  UTILITIES;          NEXTSTATE  SCANMODULES  SCANUTILITIES
CNCTI . . . . . WORD          UTILITIES;          MISMATCH
CNCTO . . . . . WORD          UTILITIES;          SIGNON  ERROR  MISMATCH
CONTROLIDCOORDINATE . . . . . WORD          PARSE;              UTILITIES
CONTROLOFFSETCOORDINATE . . . . . BYTE          PARSE;              UTILITIES
CONTROLSARESPECIFIED . . . . . BYTE          PARSE;              UTILITIES
CREATEOBJECT . . . . . PROCEDURE WORD NEAR  OBJMAN;             PARSE  SCANMODULES  PROCESSRECORDS
CURRENTOVLNUM . . . . . BYTE          PROCESSRECORDS;    SCANUTILITIES  SYMBOLSORT
CURRENT_PAGE . . . . . UNKNOWN          OBJMAN;             SCANUTILITIES
DEBUGTOGGLE . . . . . BYTE          PARSE;              ERROR
DEBUGTOGGLE . . . . . BYTE          ****DUPLICATE DECLARATION***: MISMATCH
DQALLOCATE . . . . . PROCEDURE WORD NEAR  DQALLOCATE;        MEMORYMANAGEMENT  SYMBOLSORT  OBJMAN
DQATTACH . . . . . PROCEDURE WORD NEAR  DQATTACH;          UTILITIES  SCANUTILITIES
DQCHANGEEXTENSION . . . . . PROCEDURE NEAR    DQCHANGEEXTENSION; PARSE
DQCREATE . . . . . PROCEDURE WORD NEAR  DQCREATE;          UTILITIES
DQDECODEEXCEPTION . . . . . PROCEDURE NEAR    DQDECODEEXCEPTION; ERROR
DQDETACH . . . . . PROCEDURE NEAR    DQDETACH;          SCANMODULES
DQEXIT . . . . . PROCEDURE NEAR    DQEXIT;            CREF86  ERROR
DQFREE . . . . . PROCEDURE NEAR    DQFREE;            LISTOUTPUT
DQGETARGUMENT . . . . . PROCEDURE BYTE NEAR  DQGETARGUMENT;    PARSE
DQGETSYSTEMID . . . . . PROCEDURE NEAR    DQGETSYSTEMID;    SIGNON
DQGETTIME . . . . . PROCEDURE NEAR    DQGETTIME;        LISTOUTPUT
    
```

Figure 3-5. Symbol Cross-Reference Information

The third column contains the following for each symbols listed:

- The name of the module in which the symbol is defined public (defining module)
- A semicolon (;), if there are external references to the symbol in any of the input modules
- The name(s) of the modules(s) in which the symbol is declared external (referring module(s))

The third column is also used to flag unresolved and duplicate references. In the case of unresolved external references, the string *****UNRESOLVED***** appears before the semicolon. In the case of duplicate references, i.e., when a symbol has two or more public definitions, the first public declaration is considered legal, and the rest are flagged as duplicates. The string *****DUPLICATE DECLARATION***** appears, followed by a colon (:) and the name of the module containing the duplicate public declaration.

If the input files contain overlays, CREF86 produces a symbol cross-reference that consolidates all the symbols from all overlay and root modules. The first file in the input list is considered to be the root file. CREF86 distinguishes between public symbols with the same name in different overlays and does not flag these symbols as duplicates. However, CREF86 does flag duplicate public declarations within any one root/overlay combination.



LIB86 allows you to create, modify, and examine library files. It is an interactive program.

This chapter provides details concerning LIB86 invocation and commands. For definition of file-naming and syntax notation conventions used in this chapter, refer to Notational Conventions following the Preface. For a summary of the LIB86 commands and information on error and warning messages that may be produced, refer to Appendix F. For details concerning LIB86 symbol table space limitations, refer to Appendix C.

LIB86 Invocation

The general syntax for the invocation line is:

```
[directory-name]LIB86[comment]
```

LIB86 Commands

Once LIB86 has begun execution, it displays an asterisk (*) and waits for a command. Table 4-1 lists all of LIB86's commands.

Table 4-1. Summary of LIB86 Commands

Command	Abbrev.	Description
ADD { <i>pathname</i> {(<i>module name</i> [...])} [...]} TO <i>pathname</i>	A	Adds modules to a library
CREATE <i>pathname</i>	C	Creates library files
DELETE <i>pathname</i> (<i>module name</i> [...])	D	Deletes modules from a library file
EXIT	E	Terminates session with LIB86
LIST { <i>pathname</i> {(<i>module name</i> [...])} [...]} [TO <i>pathname</i>] [PUBLICS]	L [P]	Lists modules contained in a library file, and optionally lists all publics

At the end of this document you will find operating system-specific examples of the LIB86 commands. Fold out the pages containing the examples relevant to your operating environment and use them in conjunction with the syntax conventions provided in this chapter.

Syntax

```
ADD {pathname1[(module name[, ...])][, ...]T0 pathname2
```

Abbreviation

A

Definition

ADD adds modules to a library file.

The *pathname1* can be an object file or a library file.

The *pathname2* is the destination library file. The library must exist before the ADD command is given; it may contain other modules.

If *pathname1* is an object file produced by a translator, LINK86, or LOC86, then all modules contained within the object file will be added to the designated library.

If *pathname2* is a library file, it may be specified with or without the *module name* list. If no *module name* list is specified, all modules contained in the source library will be added to the destination library. If the module name list is specified, then only the modules specified within the parentheses are added to the destination library.

Syntax

CREATE *pathname*

Abbreviation

C

Definition

CREATE creates a library file with the specified *pathname*.

Notes

- If a file with the specified *pathname* already exists, the library will not be created and an error message will be provided.

DELETE

Syntax

DELETE *pathname* (*module name* [, ...])

Abbreviation

D

Definition

DELETE removes modules from a library file. Modules can be deleted from only one library at a time.

Notes

None

Syntax

EXIT

Abbreviation

E

Definition

EXIT terminates a session with LIB86 and returns control to the operating system.

Notes

- LIB86 disassembles libraries into an internal form. The library is not reconstituted until the EXIT command is processed. Therefore significant I/O will take place following an EXIT command.

Syntax

```
LIST {pathname1[(module name [, ...])]} [, ...][TO pathname2]
      [PUBLICS]
```

Abbreviation

L [P]

Definition

LIST prints the names of modules, and optionally the public symbols contained in those modules, to the specified output pathname.

The *pathname1* is the library whose modules are to be listed.

The *module name*, if specified, identifies the modules to be listed.

TO *pathname2* identifies the device or file to receive the listing. If it is not specified, the listing is directed to the console output device.

PUBLICS indicates that, in addition to the module names, all public symbols contained within the module will also be listed. PUBLICS may be abbreviated as 'P'.

Notes

None

LOC86 changes a relocatable 8086 object module into an absolute object module. As figure 5-1 illustrates, LOC86 takes a single 8086 object module as input and outputs a located object file and, optionally, a print file. The print file output contains diagnostic information. The object file contains absolute object code.

This chapter provides details concerning the LOC86 invocation, controls, and print file. For definition of file-naming and syntax notation conventions used in this chapter, refer to Notational Conventions following the Preface. For a summary of the LOC86 controls and information on error and warning messages that may be produced, refer to Appendix G. For details concerning LOC86 segment support capabilities, refer to Appendix C.

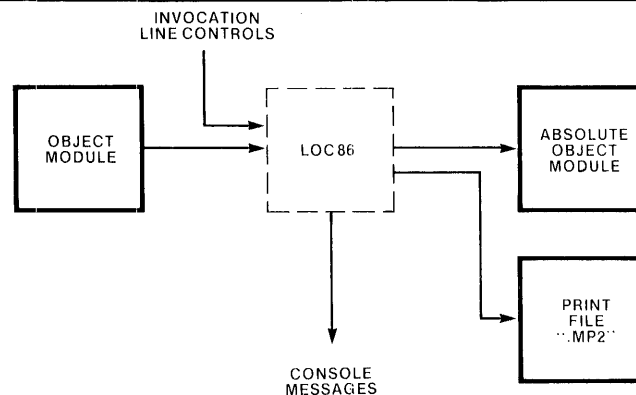

Figure 5-1. LOC86 Input and Output Files

121616-6

LOC86 Invocation Line

The general syntax for the invocation line is:

```
[directory-name]LOC86 input file [TO object file][controls]
```

The *input file* is a file containing an object module to be located. It is usually, but not necessarily, the output from LINK86.

TO object file specifies the file to receive the located object module. In most cases this is an executable file. If *object file* is not specified, then output will be directed to a file that has the same pathname as the *input file*, except it will have no extension.

The *controls* may be any subset of the controls described in the next section.

LOC86 Controls

The *controls* are described in table 5-1.

If you specify the same control more than once in the same invocation line, only the last version entered counts. For example, if you enter NOMAP, and then later decide you want a locate map, you can enter the MAP control without error. The second version of the control is recognized and the first is ignored.

At the end of this document you will find operating system-specific examples of the LOC86 controls. Fold out the pages containing the examples relevant to your operating environment and use them in conjunction with the syntax conventions provided in this chapter.

Table 5-1. Summary of LOC86 Controls

Control	Abbrev.	Default
ADDRESSES({SEGMENTS({segment[\class[\overlay]] (addr)}{,...}) CLASSES({class(addr)}{,...}) GROUPS({group(addr)}{,...}) } {,...})	AD (SM CS GR)	Not applicable
BOOTSTRAP	BS	Not applicable
COMMENTS	CM	COMMENTS
NOCOMMENTS	NOCM	
INITCODE[<i>address</i>]	IC	INITCODE(200H)
NOINITCODE	NOIC	
LINES	LI	LINES
NOLINES	NOLI	
MAP	MA	MAP
NOMAP	NOMA	
NAME(<i>module</i>)	NA	Not applicable
OBJECTCONTROLS({LINES NOLINES COMMENTS NOCOMMENTS SYMBOLS NOSYMBOLS PUBLICS NOPUBLICS PURGE NOPURGE }{,...})	OC	Not applicable
ORDER({SEGMENTS({segment[\class[\overlay]] {,...}) CLASSES({class({segment {,...}} }{,...}) }{,...})	OD (SM CS) CS	Not applicable
PRINT[<i>pathname</i>]	PR	PRINT(<i>object file</i> .MP2)
NOPRINT	NOPR	
PRINTCONTROLS({LINES NOLINES COMMENTS NOCOMMENTS SYMBOLS NOSYMBOLS PUBLICS NOPUBLICS PURGE NOPURGE }{,...})	PC	Not applicable
PUBLICS	PL	PUBLICS
NOPUBLICS	NOPL	
PURGE	PU	NOPURGE
NOPURGE	NOPU	
RESERVE({addr TO addr }{,...})	RS	Not applicable
SEGSIZE({segment[\class[\overlay]] (size)}{,...})	SS	Not applicable
START({symbol paragraph,offset})	ST	Not applicable
SYMBOLS	SB	SYMBOLS
NOSYMBOLS	NOSB	
SYMBOLCOLUMNS({1 2 3 4})	SC	SYMBOLCOLUMNS(2)

Syntax

```
ADDRESSES ( ( SEGMENTS ( { segment name [ \ class name
                               [ \ overlay name ] ] ( address ) }
              [ , ... ] ) |
            CLASSES ( { class name ( address ) } [ , ... ] ) |
            GROUPS ( { group name ( address ) } [ , ... ] ) }
           [ , ... ]
          )
```

Abbreviation

```
AD ( SM | CS | GR )
```

Default

Not applicable

Definition

ADDRESSES allows you to override LOC86's default address assignment algorithm. You may assign a beginning address to segments, classes, or groups. All addresses must follow Intel rules for integer representation. (These rules are the same as those used by ASM86 and PL/M-86.) The subcontrols, SEGMENTS, CLASSES, and GROUPS, identify exactly what elements of the input module are being assigned addresses. When assigning an address with the SEGMENTS subcontrol, you may also specify the class name and overlay name of the particular segment.

LOC86 attempts to detect and avoid conflicts whenever possible. If the specified address does not agree with the alignment attribute of the specified segment or the first segment in the specified class, then the address is ignored. If an absolute segment is located at the address assigned to a class, then the class begins at the first free address after the absolute segment. If you assign a non-paragraph address to a group, LOC86 will assign the first paragraph address *below* the specified address.

Notes

- The subcontrols SEGMENTS, CLASSES, and GROUPS can be specified multiple times in a single ADDRESSES control.
- If an address assignment causes a conflict with an ORDER control, a RESERVE control or an absolute segment, LOC86 generates an error message.
- When locating bound object modules, you may not assign an address to a segment in a group.

Syntax

BOOTSTRAP

Abbreviation

BS

Default

Not applicable

Definition

BOOTSTRAP indicates that the code for a long jump to the module's start address should be placed at location 0FFFF0H, when the module is loaded. This is the first instruction executed by the 8086 after reset. If the input module has no start address and none is specified in the START control, LOC86 will generate an error message.

Notes

- See also the START and INITCODE controls.

Syntax

COMMENTS
NOCOMMENTS

Abbreviation

CM
NOCM

Default

COMMENTS

Definition

COMMENTS allows object file comment records to remain in the output module. The NOCOMMENTS control removes all comment records except those designated as non-purgable.

Comment records are added to the object module for various reasons. All translators add a comment record to the object files they produce. The record identifies the compiler or assembler that produced the object file.

Comment records are superfluous to the production of executable code and may be removed at any time during the development process, or left in the file.

Notes

- See PRINTCONTROLS, OBJECTCONTROLS, and PURGE.
- Comment records should not be removed when you submit an object file in a Software Problem Report.
- NOCOMMENTS will decrease the size of the output object module.
- COMMENTS has no effect on the print file.

Syntax

```
INITCODE[(address)]  
NOINITCODE
```

Abbreviation

```
IC  
NOIC
```

Default

```
INITCODE(200H)
```

Definition

INITCODE causes LOC86 to create a new segment that contains code to initialize the segment registers. The optional *address* argument specifies the physical address of the code that performs this initialization. If no *address* is specified, the initialization code will be placed at 200H. The equivalent assembly language code is shown below:

```
STACKFRAME  DW  stack frame  
DATAFRAME   DW  data frame  
EXTRAFRAME  DW  extra frame  
             CLI  
             MOV  SS, CS:STACKFRAME  
             MOV  SP, stack offset  
             MOV  DS, CS:DATAFRAME  
             MOV  ES, CS:EXTRAFRAME  
             JMP  program start
```

Notes

- The initialization code segment is created only if a register initialization record for 8086 segment registers exists in the input. These register initialization records are automatically produced by 8086-based translators for main modules.
- If the area of memory used by the INITCODE default is reserved, LOC86 places the initialization code above the reserved space.
- If created, the new segment is called ??LOC86__INITCODE.

Syntax

LINES
NOLINES

Abbreviation

LI
NOLI

Default

LINES

Definition

LINES allows line number information to remain in the object file. In-circuit emulators and other debuggers use this information; it is not needed to produce executable code. The NOLINES control removes this information from the output file.

Notes

- The scope of the LINES control can be modified with PRINTCONTROLS and OBJECTCONTROLS.
- See the PURGE control.
- NOLINES will decrease the size of the output object file.

Syntax

MAP
NOMAP

Abbreviation

MA
NOMA

Default

MAP

Definition

MAP causes LOC86 to produce a locate map for the output module and add it to the print file. For all segments in the module the map shows the complete name (segment name, class name, and overlay name), size, alignment, start address, and stop address. A more complete description of the locate map and the rest of the print file is at the end of this chapter.

Notes

- MAP can be overridden by the NOPRINT control.

Syntax

NAME (*module name*)

Abbreviation

NA

Default

Module retains its current name.

Definition

NAME assigns the specified *module name* to the output module. If **NAME** is not specified, then the output module retains its current name.

The *module name* may be up to 40 characters long. It may be composed of any of the following characters in any order:

- ? (question mark)
- @ (commercial at)
- : (colon)
- . (period)
- _ (underscore)
- A, B, C, ..., Z
- 0, 1, 2, ..., 9.

Lower case letters may be used, but they are automatically converted to upper case.

Notes

- **NAME** does not affect the output file's name, only the module name in the output module's header record.

Syntax

```
OBJECTCONTROLS({LINES | NOLINES |  
                COMMENTS | NOCOMMENTS |  
                SYMBOLS | NOSYMBOLS |  
                PUBLICS | NOPUBLICS |  
                PURGE | NOPURGE}  
                [,...]  
)
```

Abbreviation

OC

Default

Controls apply to both the print file and the object file.

Definition

OBJECTCONTROLS causes the controls specified in its arguments to be applied to the object file only. Comment records, line number records, local and public symbol records, and symbol type records are selectively included or excluded from the object file. This will not affect the print file and the information contained in it.

Notes

- If you specify an invalid control in the arguments to OBJECTCONTROLS, LOC86 generates an error message.
- You may specify a control or control pair more than once within OBJECTCONTROLS, but only the last version specified counts.
- You may abbreviate the controls used within OBJECTCONTROLS.
- When you specify a control in both OBJECTCONTROLS and PRINTCONTROLS, it will have the same effect as specifying it once outside of these controls.

Syntax

```
ORDER ( { SEGMENTS ( { segment name [ \ class name [ \ overlay name ] ] }
           [ , ... ] ) }
        CLASSES ( \ { class name [ ( segment name [ , ... ] ) ] } [ , ... ] ) }
        [ , ... ] )
```

Abbreviation

```
OD ( SM | CS | )
```

Default

Not applicable

Definition

ORDER specifies a partial or complete order for segments, classes, and the segments within a class. Segments and classes listed in ORDER are located before any other relocatable segment.

The subcontrol SEGMENTS indicates that the list of segment names shall be ordered.

The *segment name* identifies the specific segments to be ordered. The *\class name* and *\overlay name* may be used to resolve conflicts with duplicate segment names. If *\overlay name* is specified, the *\class name* is required.

If one of the segments specified is not contained in the designated group, an error message is generated.

Notes

- See “LOC86’s Algorithm for Locating Segments” at the end of this chapter.

Syntax

```
PRINT[(pathname)]  
NOPRINT
```

Abbreviation

```
PR  
NOPR
```

Default

```
PRINT(object file.MP2)
```

Definition

PRINT allows you to direct the locate map symbol table and other diagnostic information to a particular file. If the PRINT control is not specified or if the control is given without an argument, the print file will have the same pathname as the output file except the extension will be .MP2. NOPRINT prevents the creation of this file.

Notes

- The discussion at the end of this chapter describes the contents of the print file.
- See also MAP, SYMBOLCOLUMNS, LINES, SYMBOLS, PUBLICS, and PRINTCONTROLS.

Syntax

```
PRINTCONTROLS({LINES | NOLINES |  
               COMMENTS | NOCOMMENTS |  
               SYMBOLS | NOSYMBOLS |  
               PUBLICS | NOPUBLICS |  
               PURGE | NOPURGE}  
               [,...]  
            )
```

Abbreviation

PC

Default

Controls apply to both the print file and the object file.

Definition

PRINTCONTROLS causes the controls specified in its arguments to be applied to the print file only. Line number information, and local and public symbol information are selectively included or excluded from the print file. This will not affect the object file or the information contained in it.

Notes

- If you specify an invalid control in the arguments to PRINTCONTROLS, LOC86 generates an error message.
- You may specify a control in OBJECTCONTROLS more than once, but only the last version specified counts.
- You may abbreviate the controls used within PRINTCONTROLS.
- When you specify a control in both PRINTCONTROLS and OBJECTCONTROLS, it will have the same effect as specifying it once outside of these controls.

Syntax

PUBLICS
NOPUBLICS

Abbreviation

PL
NOPL

Default

PUBLICS

Definition

PUBLICS causes the public symbol records to be kept in the object file and the corresponding information to be placed in the print file.

Notes

- The scope of PUBLICS can be modified by PRINTCONTROLS and OBJECTCONTROLS.
- NOPUBLICS will reduce the size of the output object file; however, public symbol records are used by debuggers.
- See the PURGE control.

Syntax

PURGE
NOPURGE

Abbreviation

PU
NOPU

Default

NOPURGE

Definition

PURGE is exactly the same as specifying NOLINES, NOSYMBOLS, NOCOMMENTS, and NOPUBLICS. NOPURGE in the control list is the same as specifying LINES, SYMBOLS, COMMENTS, and PUBLICS.

PURGE removes all of the public and debug information from the object file and the print file. It will produce the most compact object file possible. The records that would be included by NOPURGE are useful to debuggers and in-circuit emulators, but otherwise they are unnecessary for producing executable code.

Notes

- PRINTCONTROLS and OBJECTCONTROLS can be used to modify the scope of PURGE.

Syntax

RESERVE({*address1* TO *address2*} [, ...])

Abbreviation

RS

Default

All of memory is assumed available.

Definition

RESERVE prevents LOC86 from locating segments in certain areas of memory. LOC86 will not use all memory addresses from *address1* to *address2* inclusive; *address1* must be less than or equal to *address2*.

Notes

- If an absolute segment uses a reserved memory area, a warning message is generated.
- Reserved areas may overlap.

Syntax

```
SEGSIZE ({segment name[\ class name[\ overlay name]] (size) }  
[, ...])
```

Abbreviation

SS

Default

Not applicable

Definition

SEGSIZE allows you to specify the memory space used by a segment.

The *segment name* may be any segment contained in the input module.

The *size* is a 16-bit number that LOC86 uses to change the size of the specified segment. There are three ways of specifying this value:

- + indicates that the number should be added to the current segment length.
- — indicates that the number should be subtracted from the current segment length.
- No sign indicates that the number should become the new segment length.

Notes

- LOC86 issues a warning message when SEGSIZE decreases the size of a segment.

Syntax

START ({*public symbol* | *paragraph* , *offset* })

Abbreviation

ST

Default

The start address designated in the input module

Definition

START allows you to specify the start address of your program.

If you specify *public symbol*, that symbol must be defined within the input module.

The *paragraph* value initializes the CS register and the *offset* value initializes the IP in an 8086 long jump when your program is started.

Notes

- See the BOOTSTRAP and INITCODE controls.

Syntax

SYMBOLS
NOSYMBOLS

Abbreviation

SB
NOSB

Default

SYMBOLS

Definition

SYMBOLS specifies that all local symbol records shall be included in the object file, and information concerning local symbols will also appear in the symbol table contained in the print file. Local symbol records are used by debuggers and in-circuit emulators.

Notes

- The scope can be modified by OBJECTCONTROLS and PRINTCONTROLS.
- NOSYMBOLS will decrease the size of the output object file.
- See the PURGE control.

SYMBOLCOLUMNS

Syntax

```
SYMBOLCOLUMNS({1|2|3|4})
```

Abbreviation

SC

Default

```
SYMBOLCOLUMNS(2)
```

Definition

SYMBOLCOLUMNS indicates the number of columns to be used when producing the symbol table for the object module. Two columns fit on a 78-character line; four columns fit on a single 128-character line printer line.

Notes

None

LOC86's Print File

The print file is always created unless you specify NOPRINT. The optional argument to PRINT designates the name of the print file. The default print file is the object file with the extension .MP2.

The print file may contain as many as three parts:

- A symbol table
- A memory map
- An error message list

The symbol table is included in the print file when a PUBLICS, LINES, or SYMBOLS control is in effect. The memory map is controlled by the MAP/NOMAP control. Error and warning messages, if any, are always added to the print file.

The Symbol Table

LOC86 produces a symbol table when any or all of the symbol controls (LINES, SYMBOLS, and PUBLICS) are in effect. No symbol table will be produced when PURGE is in effect for the print file.

Figure 5-2 shows LOC86's symbol table with the SYMBOLCOLUMNS set at 2 (the default).

BASE is usually a 4-digit hexadecimal number that is the base address of the group that contains the symbol. If the base is the stack, then STACK is used instead of a number. If the symbol is based on another symbol's value, then the BASE and OFFSET values for that symbol are given.

OFFSET is a 4-digit hexadecimal number that is the offset of the symbol or line from BASE, or from the current BP for stack symbols.

To compute the physical address of the specified symbol you would use the following equation:

$$(\text{BASE} * 10\text{H}) + \text{OFFSET} = \text{Physical Address}$$

Of course, the physical address of the symbols whose base is the STACK, or symbols that are based on another symbol's value, cannot be computed until run-time.

TYPE describes the kind of symbol it is. There are four possible entries in the TYPE column:

BAS	based on another symbol's value
LIN	line (not a symbol)
PUB	public symbol
SYM	local symbol

SYMBOL field contains the name of the symbol or number of the line. If the SYMBOLCOLUMNS value is 1, this field is 40 characters wide. If the SYMBOLCOLUMNS value is 2 or more, then this field is 16 characters wide. If the symbol name is longer than the width of the entry, then the name is hyphenated and continued in the SYMBOL field on the next line.

```

system-id 8086 LOCATER, Vx.y

INPUT FILE: pathname1
OUTPUT FILE: pathname2
CONTROLS SPECIFIED IN INVOCATION COMMAND:

DATE: MM/DD/YY TIME: HH:MM:SS

SYMBOL TABLE OF MODULE ROOT

BASE    OFFSET TYPE SYMBOL                BASE    OFFSET TYPE SYMBOL
00BBH  016CH PUB BINDCONTROL            00BBH  0052H PUB BNODEBASE
00BBH  001EH PUB BUFBASE                00BBH  001CH PUB BUFLN
00BBH  0054H PUB CLASHNODEBASE          00BBH  0066H PUB COCGNN
00BBH  0160H PUB COMMENTSCONTROL        00BBH  0177H PUB CURRENTOVLRLAYWU
                                           -M
00BBH  0179H PUB DEBUGTOGGLE            00BBH  00ADH PUB DEFAULTPRTFILENA
                                           -ME
00BBH  0068H PUB EXCEPTION              00BBH  004EH PUB FANODEBASE
00BBH  0074H PUB FBLOCKBASE             00BBH  0070H PUB FBLOCKLISTHEAD
00BBH  0072H PUB FBLOCKLISTTAIL         00BBH  0143H PUB FBLOCKSEQUENCENU
                                           -MERR
00BBH  0050H PUB FBNODEBASE             00BBH  004CH PUB FDNODEBASE
00BBH  004AH PUB FENODEBASE             00BBH  0046H PUB FFNODEBASE
00BBH  003AH PUB FIRSTRNODEP            00BBH  002EH PUB FIRSTRNODEP
00BBH  0032H PUB FIRSTGRNODEP           00BBH  0022H PUB FIRSTNMNODEP
00BBH  0036H PUB FIRSTOVNODEP           00BBH  0056H PUB FIRSTRENAMEBLOCK
                                           -P
00BBH  0026H PUB FIRSTSGNODEP           00BBH  002AH PUB FIRSTTDNODEP
00BBH  003EH PUB GRNODEBASE             00BBH  0B52H PUB HIGHESTDATALOCAT
                                           -ION
    
```

```

MODULE = ROOT

BASE    OFFSET TYPE SYMBOL                BASE    OFFSET TYPE SYMBOL
00BBH  0FA0H SYM MEMORY                  00BBH  0006H SYM COPYRIGHT
00BBH  001CH SYM BUFLN                   00BBH  001EH SYM BUFBASE
0020H  00F7H SYM ERROR                    0020H  00FEH SYM WARNING
00BBH  0020H SYM LASTNMNODEP             00BBH  0022H SYM FIRSTRNODEP
00BBH  0024H SYM LASTSGNODEP             00BBH  0026H SYM FIRSTSGNODEP
00BBH  0028H SYM LASTTDNODEP             00BBH  002AH SYM FIRSTTDNODEP
00BBH  002CH SYM LASTEXNODEP             00BBH  002EH SYM FIRSTEXNODEP
00BBH  0030H SYM LASTGRNODEP             00BBH  0032H SYM FIRSTGRNODEP
00BBH  0034H SYM LASTOVNODEP             00BBH  0036H SYM FIRSTOVNODEP
00BBH  0038H SYM LASTENODEP              00BBH  003AH SYM FIRSTRNODEP
00BBH  003CH SYM SGNODEBASE               00BBH  003EH SYM GRNODEBASE
00BBH  0040H SYM SYNODEBASE               00BBH  0042H SYM MNODEBASE
00BBH  0044H SYM TDNODEBASE               00BBH  0046H SYM FFNODEBASE
00BBH  0048H SYM QVNODEBASE               00BBH  004AH SYM FENODEBASE
00BBH  004CH SYM FDNODEBASE               00BBH  004EH SYM FANODEBASE
00BBH  0050H SYM FBNODEBASE               00BBH  0052H SYM BNODEBASE
00BBH  0054H SYM CLASHNODEBASE           00BBH  0056H SYM FIRSTRENAMEBLOCK
                                           -P
    
```

```

00BBH  01AAH SYM SIGNONMSG                0020H  0174H SYM PRINTNAME
0020H  01A3H SYM INITIALIZEINPUT          0020H  01A8H SYM OPENFBLOCKFILE
0020H  01F6H SYM CLOSEFBLOCKFILE          0020H  00F7H LIN 7
0020H  00FAH LIN 10                       0020H  00FEH LIN 11
0020H  0101H LIN 14                       0020H  0105H LIN 73
0020H  0108H LIN 75                       0020H  010FH LIN 76
0020H  0118h LIN 77                       0020H  011DH LIN 78
0020H  0126H LIN 79                       0020H  012AH LIN 80
0020H  012DH LIN 84                       0020H  0136H LIN 85
0020H  013Dh LIN 86                       0020H  0144H LIN 87
0020H  0151h LIN 88                       0020H  015AH LIN 89
0020H  0160h LIN 90                       0020H  0170H LIN 91
0020H  0174H LIN 94                       0020H  0177H LIN 96
0020H  018EH LIN 97                       0020H  0196h LIN 98
0020H  019Fh LIN 99                       0020H  01A3H LIN 100
0020H  01A6h LIN 103                      0020H  01A6H LIN 105
    
```

Figure 5-2. LOC86 Symbol Table

The Memory Map

The memory map supplies useful information about segment placement and address assignment. Figure 5-3 shows LOC86's memory map.

The map consists of three parts:

- Header
- Segment map
- Group map

The header includes the input module name and the start address.

The segment map is a table with six columns. From left to right the columns show:

- the START address of the segment
- the STOP address of the segment
- the LENGTH of the segment
- the ALIGNMENT attribute of the segment
- the NAME of the segment
- the CLASS of the segment
- the OVERLAY of the segment

A "C" printed between the STOP and LENGTH columns indicates that two segments have overlapping memory locations; a warning message is also issued.

A segment may have any one of the following alignment attributes:

- A absolute
- B byte
- G paragraph
- M member of an LTL group
- P page
- W word
- R in-page

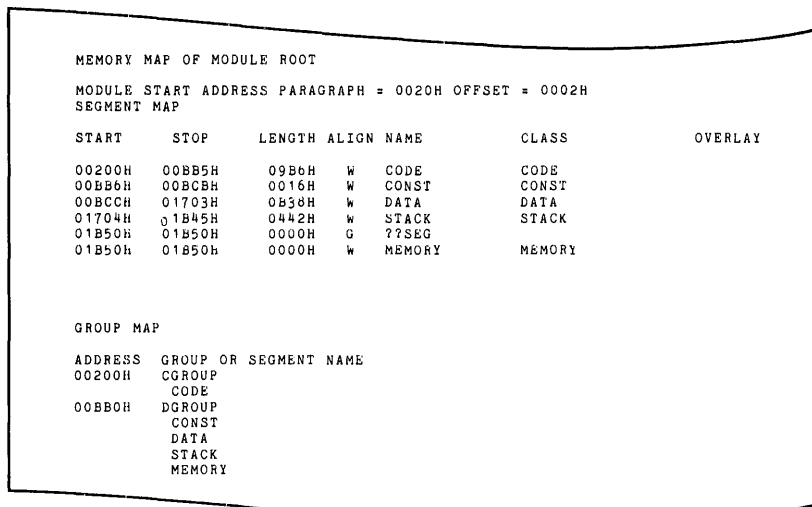

Figure 5-3. LOC86 Memory Map

In-page alignment means that the entire segment must be resident within a single 256-byte page. The address of the first byte in any page has zeros in the first two hexadecimal digits (00H, 100H, 200H, ... 0FFF00H).

The group map has two columns: the first is the physical address (five-digit hexadecimal number) of the beginning of the group; the second column is the group name, followed by the segments contained in that group. The segment names contained within a given group are listed in the same column but indented slightly.

Error and Warning Messages

The error and warning messages are listed consecutively as the error situations are encountered.

See the discussion of the interpretation of individual messages in Appendix F.

LOC86's Algorithm for Locating Segments

Assuming that there are no errors in the invocation line or input module, LOC86 locates an input module in three stages.

1. All absolute segments are removed from the list of segments contained in the module.
2. The remaining relocatable segments are ordered into a sequential list.
3. The relocatable segments are then given absolute addresses according to each segment's alignment, size, and memory attribute.

Absolute Segments

When LOC86 encounters an absolute segment, LOC86 removes the segment from a list of input segments and reserves the memory area used by that segment. LOC86 maintains a map of free memory. Each time an absolute segment is encountered, the memory space used by that segment is removed from the memory map. A segment can become absolute in one of three ways:

1. It may be assigned an absolute address by the translator.
2. It may be explicitly specified in an ADDRESSES control.
3. It may become absolute implicitly. If an absolute segment is specified in an ORDER control, then all other segments referred to in that control, either by segment name or by class name, are treated as absolute.

Segment Ordering

After all memory used by absolute segments has been removed from LOC86's free memory map and before LOC86 begins assigning addresses to the remaining relocatable segments, LOC86 prepares an ordered list of all relocatable segments.

All relocatable segments specified in an ORDER control are placed at the head of the list.

After all ORDER controls, if any, have been processed, LOC86 adds the relocatable segments that remain to the end of the list. If the first segment not previously used has a class name, then all other segments with the same class name are added to the list. After all segments of the class have been added to the list, then the next segment is added to the list.

This process continues until all segments have been added to the ordered list.

NOTE

Memory segments do not adhere to this process — a memory segment is always located at the top of memory, if possible. If an input module contains more than one memory segment, only the first is placed at the top of memory; the other segments are treated as any other relocatable segment.

Assigning Addresses to Relocatable Segments

Once LOC86 completes the ordered list of relocatable segments, it begins assigning addresses. LOC86 will never assign addresses that conflict with the location of absolute segments or the RESERVE control or between 00H and 200H, since that area is reserved for interrupt routines.

Starting at location 200H, LOC86 scans free memory to find an area in which the first segment will fit. When LOC86 finds a suitable address, it assigns it to the segment and removes that area from free memory. LOC86 then scans free memory for an area that will fit the next segment in the ordered list. LOC86 begins scanning at the end of the previous segment.

IF LOC86 reaches the end of memory and all of the relocatable modules have not been located, it makes an additional scan through free memory. The scanning process continues until all modules have been located.

LOC86's Algorithm for Locating Modules Containing Overlays

LOC86 locates programs with overlays in much the same way as it handles programs that do not contain overlays. However, there are some differences.

1. Segments contained in the root and each overlay are ordered separately.
2. Segments that are common to both the root and overlays (e.g., STACK and MEMORY) are put at the end of the list of relocatable segments.
3. Segments in the root are located at the lowest available addresses in memory.
4. Segments contained in the overlays are located at the first available address above the root.
5. Segments common to the root and overlays are located immediately above the largest overlay in the file.

Figure 5-4 illustrates how LOC86 treats two PL/M-86 programs that use overlays. Figure 5-4a shows how segments are located when the modules are compiled with the LARGE model. Figure 5-4b shows how segments are located when the modules are compiled with the SMALL model of segmentation.

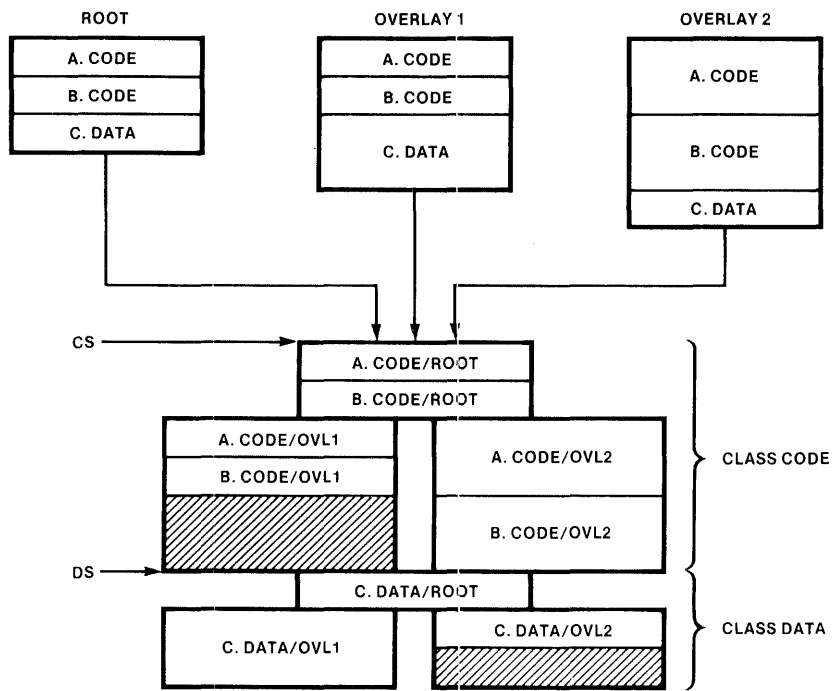

a. LARGE Model

Figure 5-4. LOC86's Address Assignments for Overlays

121616-7

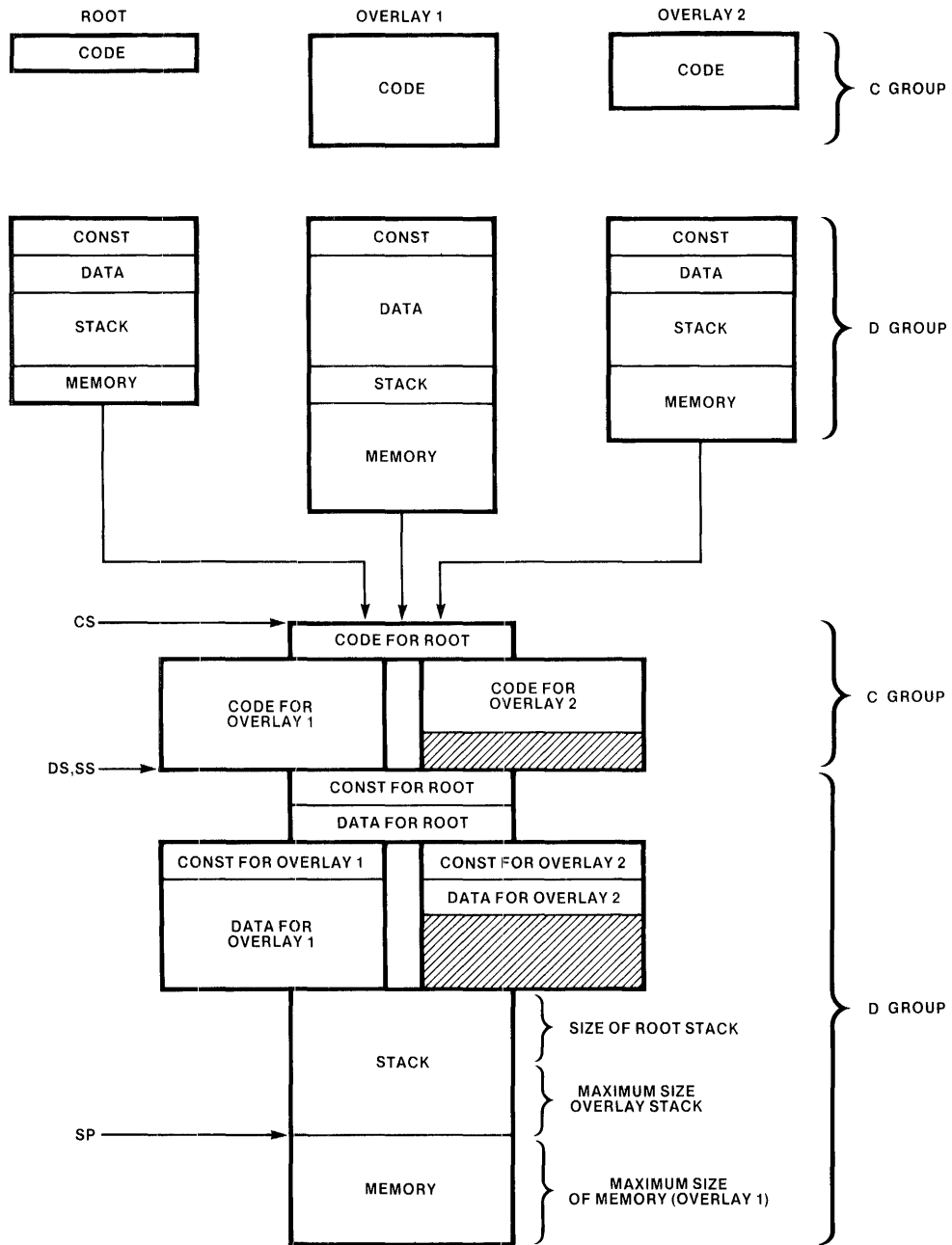

b. SMALL Model

Figure 5-4. LOC86's Assignments for Overlays (Cont'd.)

121616-8

OH86 converts 8086 absolute object modules to 8086 hexadecimal format. The input module must be in absolute format, and it may not contain overlays or register initialization records.

Figure 6-1 illustrates the object-to-hexadecimal conversion process. Any errors encountered during execution are displayed at the console output device.

For definition of file-naming conventions and syntax notation, refer to Notational Conventions following the Preface. For information on error and warning messages which may be produced, refer to Appendix H.

The general syntax for the invocation line is:

```
[directory-name]OH86 input file[TO output file]
```

The *input file* contains an 8086 absolute object module.

TO *output file* designates the file to receive the 8086 hexadecimal format. If *output file* is not specified, then output is directed to a file that has the same pathname as the input list, but its extension is HEX.

At the end of this document you will find operating system-specific examples of the OH86 invocation.

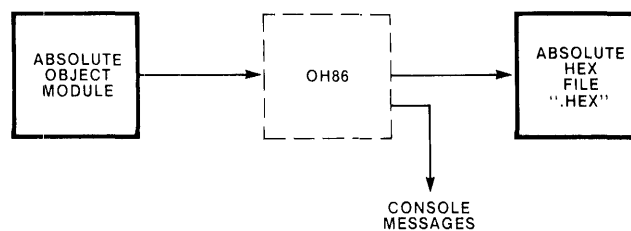

Figure 6-1. OH86 Input and Output Files

121616-9



Introduction

The 8086 Absolute Object File Format herein described is a proper subset of the full 8086 Object File Formats. An absolute object file consists of a sequence of records defining a single absolute module. An absolute module is defined as a collection of absolute object information that is specified by a sequence of object records.

Definitions

This section defines certain terms fundamental to 8086 Relocation and Linkage (R&L). The terms are ordered not alphabetically, but so you can read forward without forward references.

Definition of Terms

OMF—acronym for Object Module Formats

R&L—acronym for Relocation and Linkage

MAS—acronym for Memory Address Space. The 8086 MAS is one megabyte (1,048,576 bytes). Note that the MAS should be distinguished from actual memory, which may occupy only a portion of the MAS.

MODULE—an “inseparable” collection of object code and other information produced by a translator or by the LINK86 program. When a distinction must be made:

T-MODULE—denotes a module created by a translator, such as PL/M-86 or ASM86, and

L-MODULE—denotes a module created by LINK86 from one or more constituent modules. (Note that modules are not “created” in this sense by the iAPX86,88 Locator, LOC86; the output module from LOC86 is merely a transformation of the input module).

Two observations about modules must be made:

1. Every module must have a name, so that the iAPX86,88 Librarian, LIB86, has a handle for the module for display to the user. (If there is no need to provide a handle for LIB86, the name may be null.) Translators provide names for T-modules, providing a default name (possibly the file name or a null name) if neither source code nor user specifies otherwise.
2. Every T-module in a collection of modules linked together may have a different name, so that symbolic debugging systems can distinguish the various symbols. This restriction is not required by R&L and is not enforced by it.

FRAME—a contiguous region of 64K of MAS, beginning on a paragraph boundary (i.e., on a multiple of 16 bytes). This concept is useful because the content of the four 8086 segment registers define four (possibly overlapping) FRAME's; no 16-bit address in the 8086 code can access a memory location outside of the current four FRAME's. The FRAME starting at address 0000H is FRAME 0.

Module Identification

In order to determine that a file contains an object program, a module header record will always be the first record in a module. There are two kinds of header records and each provides a module name. The additional functions of the header records are explained below.

A module name may be generated during one of two processes: translation or linking. A module that results from translation is called a T-MODULE. A T-MODULE will have a T-MODULE HEADER RECORD (THEADR). A name may be provided in the THEADR record by a translator. This name is then used to identify the progenitor of all debug information found in the T-MODULE. The name may be null, i.e., of length zero.

A module that results from linking and locating is called an L-MODULE. An L-MODULE will always have an L-MODULE HEADER RECORD (LHEADR) or an R-MODULE HEADER RECORD (RHEADR). In the LHEADR or RHEADR record a name is also provided. This name is available for use to refer to the module without using any of its constituent T-MODULE names. An example would be two T-MODULES, A and B, linked together to form L-MODULE C. L-MODULE C will contain two THEADR records and will begin with an LHEADR record with the name C provided by the linker as a directive from the user. The L-MODULE C can be referred to by other tools such as the library manager without having to know about the originating module's names, yet the originating module's names are preserved for debugging purposes.

Module Attributes

In addition to a name, a module may have the attribute of being a main program as well as having a specified starting address.

If a module is not a main module yet has a starting address, then this value has been provided by a translator, possibly for debugging purposes. A starting address specified for a non-main module could be the entry point of a procedure, which may be loaded and initiated independent of a main program.

Physical Segment Definition

A module is defined as a collection of data bytes defined by a sequence of records produced by a translator. The data bytes represent contiguous regions of memory whose contents are determined at translation time.

Physical Segment Addressability

The 8086 addressing mechanism provides segment base registers from which a 64K byte region of memory, called a Frame, may be addressed. There is one code segment base register (CS), two data segment base registers (DS, ES), and one stack segment base register (SS).

Data

The data that defines the memory image represented by a module is maintained in two varieties of DATA records: PHYSICAL ENUMERATED DATA RECORD (PEDATA) and PHYSICAL ITERATED DATA RECORD (PIDATA). Both records specify the data to be loaded into a contiguous section of memory. The start address of this contiguous section is given in the record. PEDATA records contain an exact byte-by-byte copy of the desired memory image. The PIDATA record differs in that the data bytes are represented within a structure that must be expanded by the loader. The purpose of the PIDATA record is to reduce module size by encoding repeated data rather than explicitly enumerating each byte, as the PEDATA record does.

Record Syntax

The following syntax shows the valid orderings of records to form an absolute module. In addition, the given semantic rules provide information about how to interpret the record sequence. The syntactic description language used herein is defined in Wirth: CACM, November 1977, V20, N 11, pg. 822-823.

```

absolute__object__file      =module.
module                      =tmod | lmod | omod.
tmod                       =THEADR [REGINT]content__def mod__tail.
lmod                       =LHEADR [REGINT]t__component mod__tail.
omod                       =RHEADR {OVLDEF}[REGINT] o__component
                           {OVLDEF} mod__tail.
o__component               =t__component ENDREC.
t__component               =[THEADR] content__def
content__def               =PEDATA | PIDATA.
mod__tail                  =[REGINT] MODEND.

```

NOTE

The character strings represented by capital letters above are not literals but are identifiers that are further defined in the section defining the Record Formats.

One module may not contain more than one REGINT record and more than one OVLDEF sequence. If a REGINT record and an OVLDEF sequence exist, the REGINT record must immediately follow the OVLDEF sequence.

A proper Absolute Object File produced by Intel products will contain at least the above record types. It may also contain other record types which, if present, will follow the Module Header record and precede the Module End record. These other record types fall into two categories:

1. Extraneous, containing information not pertinent to an absolute loader. The record numbers in this category are:
72H, 74H, 7AH, 7CH, 7EH, 88H, 8CH, 8EH, 90H, 92H, 94H, 96H, 98H, 9AH, 9CH
2. Erroneous, containing information about relocation, indicating that the object module is not yet in absolute form or that erroneous record types exist. The record numbers in this category are all other record type numbers.

Record Formats

The following pages present diagrams of Record Formats in schematic form. Here is a sample, to illustrate the various conventions:

Sample Record Format (SAMREC)

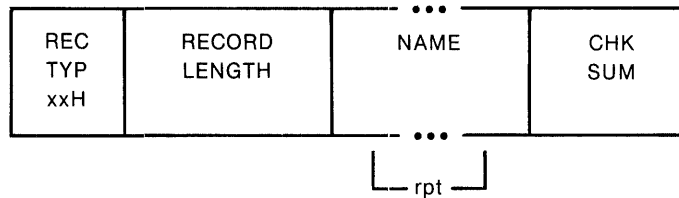

Title and Official Abbreviation

At the top is the name of the Record Format described, together with an official abbreviation. To promote uniformity among various programs, the abbreviation should be used in both code and documentation. The abbreviation is always six letters.

The Boxes

Each format is drawn with boxes of two sizes. The narrow boxes represent single bytes. The wide boxes represent two bytes (or one word) each. In the object file, the low order byte of a word value comes first. The wide boxes with four vertical bars in the top and bottom represent 4-byte fields. The wide boxes with three dots in the top and bottom represent a variable number of bytes, one or more, depending upon content.

Rec Typ

The first byte in each record contains a value between 0 and 255, indicating the type of record.

Record Length

The second field in each record contains the number of bytes in the record, exclusive of the first two fields.

Name

Any field that indicates a "NAME" has the following internal structure: the first byte contains a number between 0 and 40, inclusive, that indicates the number of remaining bytes in the field. The remaining bytes are interpreted as a byte string; each byte must represent the ASCII code of a character drawn from this set:

[?@ :._0123456789ABCDEFGHIJKLMNPOQRSTUVWXYZ]

Most translators will choose to constrain the character set more strictly; the above set has been chosen to "cover" that required by all current processors.

Repeated Fields

Some portions of a Record Format contain a field or series of fields that may occur an indefinite number of times (zero or more). Such fields are indicated by the “repeated” or “rpt” brackets below the boxes.

Similarly, some portions of the Record Format are present only if some given condition obtains; these fields are indicated by similar “conditional” brackets below the boxes.

Chk Sum

The last field in each record is a check sum, which contains the two’s complement of the sum (modulo 256) of all other bytes in the record. Therefore, the sum (modulo 256) of all bytes in the record equals 0.

Bit Fields

Descriptions of contents of fields will sometimes get down to the bit level. Boxes with vertical lines drawn through them represent bytes or words; the vertical lines indicate bit boundaries; thus this byte has three bit-fields of three, one, and four bits:

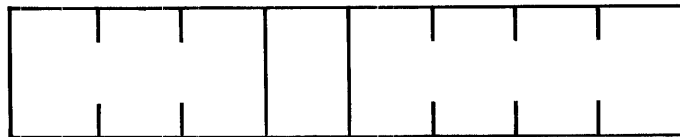

Ignored Records

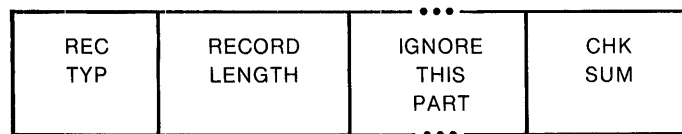

All record types that may be in an object module that provide information not pertinent to an absolute loader must be ignored. They may all be treated as if they have the above format. Records in this category have REC TYP in the set 72H, 74H, 7AH, 7CH, 7EH, 88H, 8CH, 8EH, 90H, 92H, 94H, 96H, 98H, 9AH, 9CH.

T-Module Header Record (THEADR)

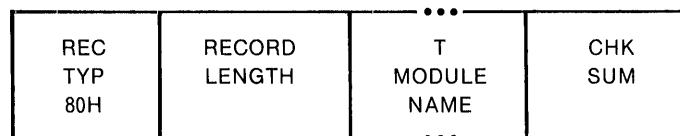

Every module output from a translator must have a T-MODULE HEADER RECORD. Its purpose is to provide the identity of the original defining module for all debug information encountered in the module up to the following T-MODULE HEADER RECORD or MODULE END RECORD.

This record can also serve as the header for a module; i.e., it can be the first record and will be for modules that are output from translators.

T-Module Name

The T-MODULE NAME provides a name for the T-MODULE.

L-Module Header Record (LHEADR)

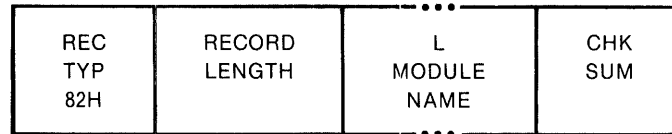

A module created by LINK86 and LOC86 may have an L-MODULE HEADER RECORD. This record serves only to identify a module that has been processed (output) by LINK86 and/or LOC86. When several modules are linked to form another module, the new module requires a name, perhaps unique from those of the linked modules, by which it can be referred to (by the LIB86 program, for example).

L-Module Name

The L-MODULE NAME provides a name for the L-Module.

R-MODULE HEADER RECORD (RHEADR)

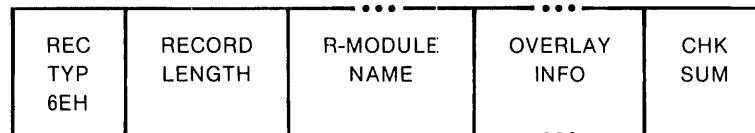

Every module with overlays created by LINK86/LOC86 will have an R-MODULE HEADER RECORD. This record serves to identify a module that has been processed (output) by LINK86/LOC86. It also specifies the overlay count and the location of the Overlay Definition records. When several modules are linked to form another module, the new module requires a name, perhaps unique from those of the linked modules, by which it can be referred to.

R-MODULE NAME

The R-MODULE NAME provides a name for the R-Module.

OVERLAY INFO

The OVERLAY INFO field provides information on overlays in the module and has the following format:

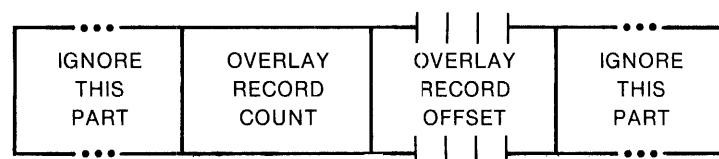

The first subfield is a 5-byte field that should be ignored.

The OVERLAY RECORD COUNT subfield indicates the number of Overlay Definition Records in the module.

The OVERLAY RECORD OFFSET subfield is a 4-byte field. It contains a 32-byte unsigned number indicating the location in bytes, relative to the start of the object file, of the first Overlay Definition Record in the Module.

The last subfield is a 16-byte field that should be ignored.

OVERLAY DEFINITION RECORD (OVLDEF)

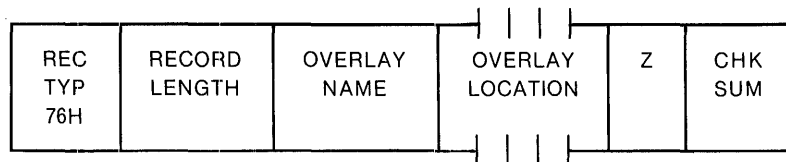

This Record provides the overlay name, the location of the overlay in the object file.

A loader may use this record to locate the data records of the overlay in the object file.

OVERLAY NAME

The OVERLAY NAME field provides a name by which a collection of data records may be referenced for loading.

OVERLAY LOCATION

The OVERLAY LOCATION is a 4-byte field which gives the location in bytes relative to the start of the file of the first byte of the records in the overlay.

Z

The Z field is a reserved field. This field is required to be zero.

END RECORD (ENDREC)

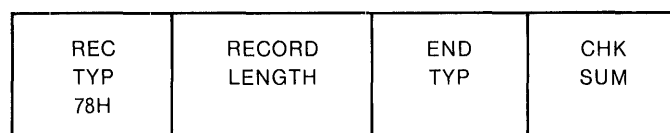

This record is used to denote the end of a set of records such as records in an overlay.

END TYP

This field specifies the type of the set. It has the following format:

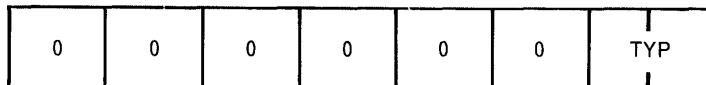

TYP is a two bit subfield that specifies the following types of ends:

TYP	TYPE OF END
0	End of overlay
1	(Reserved)
2	(Illegal)
3	(Illegal)

REGISTER INITIALIZATION RECORD (REGINT)

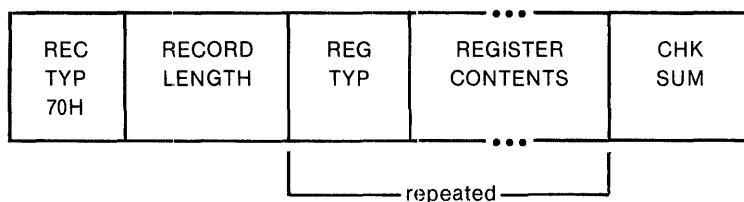

This record provides information about the 8086 registers/register-pairs: CS and IP, SS and SP, DS and ES. The purpose of this information is for a loader to set the necessary registers for initiation of execution.

REG TYP

The REG TYP field provides the register/register-pair name. It has the following format:

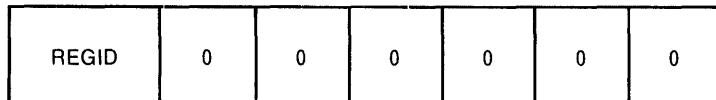

REGID is a two bit subfield that specifies the name of the registers/register-pairs as follows:

REGID	REGISTER/REGISTERPAIR
0	CS and IP
1	SS and SP
2	DS
3	ES

REGISTER CONTENTS

The REGISTER CONTENTS field has the following format:

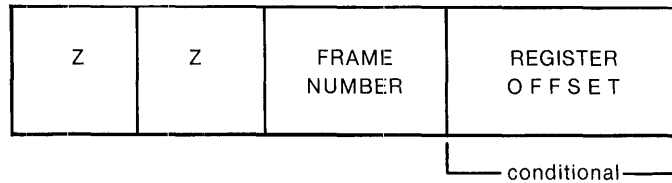

The Z fields are reserved fields. They are required to be zero.

The FRAME NUMBER field specifies a frame number that must be used to initialize the base register indicated by the REGID value.

The REGISTER OFFSET field, present only if REGID ≤ 1, specifies an offset relative to the FRAME. This value is appropriate for the initialization of either the IP register (REGID = 0) or the SP register (REGID = 1).

Module End Record (MODEND)

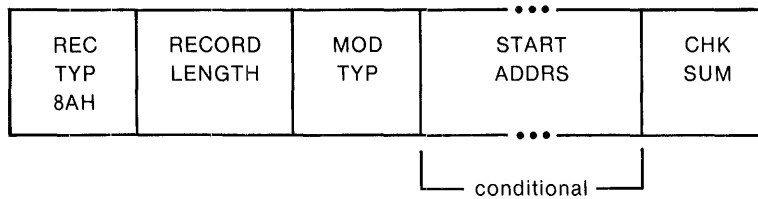

This record serves two purposes. It denotes the end of a module and indicates whether the module just terminated has a specified entry point for initiation of execution. If the latter is true, then the execution address is specified.

Mod Typ

This field specifies the attributes of the module. The bit allocation and their associated meanings are as follows:

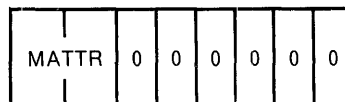

MATTR is a two-bit subfield that specifies the following module attributes:

MATTR	MODULE ATTRIBUTE
0	Non-main module with no starting address
1	Non-main module with starting address
2	(invalid value for MATTR)
3	Main module with starting address

Start Adrs

The START ADRS field has the following format:



FRAME NUMBER. This field specifies a frame number relative to which the module will begin execution. This value is appropriate for insertion into the CS register for program initiation.

OFFSET. This field specifies an offset relative to the FRAME NUMBER that defines the exact location of the first byte at which to begin execution. This value is appropriate for insertion into the IP register for program initiation.

Physical Enumerated Data Record (PEDATA)

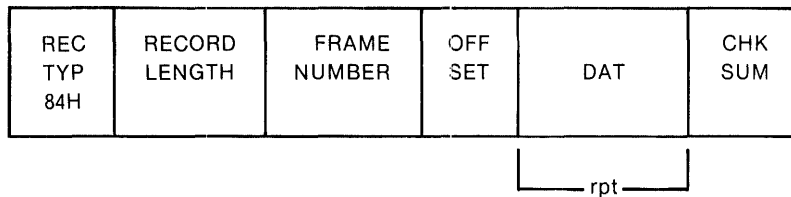

This record provides contiguous data, from which a portion of an 8086 memory image may be constructed.

Frame Number

This field specifies a Frame Number relative to which the data bytes will be loaded.

Offset

This field specifies an offset relative to the FRAME NUMBER which defines the location of the first data byte of the DAT field. Successive data bytes in the DAT field occupy successively higher locations of memory. The value of OFFSET is constrained to be in the range 0 to 15 inclusive. If an OFFSET value greater than 15 is desired, then an adjustment of the FRAME NUMBER should be done.

Dat

This field provides consecutive bytes of an 8086 memory image. The number of DAT bytes is constrained only by the RECORD LENGTH field. The address of each byte must be within the frame specified by FRAME NUMBER.

Physical Iterated Data Record (PIDATA)

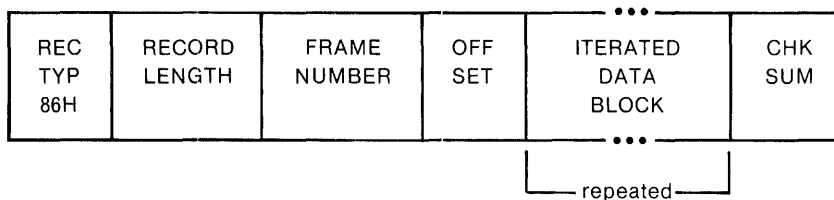

This record provides contiguous data, from which a portion of an 8086 memory image may be constructed. It allows initialization of data segments and provides a mechanism to reduce the size of object modules when there are repeated data to be used to initialize a memory image.

Frame Number

This field specifies a frame number relative to which the data bytes will be loaded.

Offset

This field specifies an offset relative to the FRAME NUMBER which defines the location of the first data byte in the ITERATED DATA BLOCK. Successive data bytes in the ITERATED DATA BLOCK occupy successively higher locations of memory. The range of OFFSET is constrained to be between 0 and 15 inclusive. If a value larger than 15 is desired for OFFSET, then an adjustment of FRAME NUMBER should be done.

Iterated Data Block

This repeated field is a structure specifying the repeated data bytes. It is a structure that has the following format:

REPEAT COUNT	BLOCK COUNT	CONTENT
-----------------	----------------	---------

Repeat Count. This field specifies the number of times that the CONTENT portion of this ITERATED DATA BLOCK is to be repeated, and must be greater than zero.

Block Count. This field specifies the number of ITERATED DATA BLOCKS that are to be found in the CONTENT portion of this ITERATED DATA BLOCK. If this field has value zero then the CONTENT portion of this ITERATED DATA BLOCK is interpreted as data bytes.

If BLOCK COUNT is non-zero then the CONTENT portion of this ITERATED DATA BLOCK is interpreted as that number of ITERATED DATA BLOCKS.

Content. This field may be interpreted in one of two ways, depending on the value of the previous BLOCK COUNT field.

If BLOCK COUNT is zero, then this field is a one-byte count followed by the indicated number of data bytes.

If BLOCK COUNT is non-zero, then this field is interpreted as the first byte of another ITERATED DATA BLOCK.

NOTE

From the outermost level, the number of nested ITERATED DATA BLOCKS is limited to 17; i.e., the number of levels of recursion is limited to 17.

The address of each data byte must be within the frame specified by FRAME NUMBER.

Hexadecimal Object File Format

Hexadecimal object file format is a way of representing an object file in ASCII.

The function of the utility program, 0H86, is to convert 8086 absolute object modules to 8086 hexadecimal object modules.

The hexadecimal representation of binary is coded in ASCII. For example, the eight-bit binary value 0011 1111 is 3F in hexadecimal. To code this ASCII, one eight-bit byte containing the ASCII code for 3(00110011 or 33H) and one eight-bit byte containing the ASCII code for F(0100 0110 or 46H) are required. This representation (ASCII hexadecimal) requires twice as many bytes as the binary.

There are four different types of records that may make up an 8086 hexadecimal object file. They are:

- Extended Address Record
- Start Address Record
- Data Record
- End of File Record

Each record begins with a RECORD MARK field containing 3AH, the ASCII code for colon (:).

Each record has a REC LEN field which specifies the number of bytes of information or data which follows the RECTYP field of each record. Note that one byte is represented by two ASCII characters.

Each record ends with a CHECKSUM field that contains the ASCII hexadecimal representation of the two's complement of the eight-bit sum of the eight-bit bytes that result from converting each pair of ASCII hexadecimal digits to one byte of binary, from and including the RECORD LENGTH field to and including the last byte of the DATA field. Therefore, the sum of all the ASCII pairs in a record after converting to binary, from the RECORD LENGTH field to and including the CHECKSUM field, is zero.

Extended Address Record

RECD MARK '.'	REC LEN '02'	ZEROES '0000'	REC TYP '02'	USBA	CHK SUM
---------------------	--------------------	------------------	--------------------	------	------------

The 8086 EXTENDED ADDRESS RECORD is used to specify bits 4-19 of the Segment Base Address (SBA) where bits 0-3 of the SBA are zero. Bits 4-19 of the SBA are referred to as the Upper Segment Base Address (USBA). The absolute memory address of a content byte in a subsequent DATA RECORD is obtained by adding the SBA to an offset calculated by adding the Load Address Field of the containing DATA RECORD to the index of the byte in the DATA RECORD (0, 1, 2, ... n). The offset addition is done modulo 64K, ignoring a carry, so that offset wrap-around loading (from 0FFFFH to 00000H) results in wrapping around from the end to the beginning of the 64K segment defined by the SBA. The address at which a particular data byte is loaded is calculated as:

$$SBA + ([DRLA + DRI] \text{ MOD } 64K)$$

where

DRLA is the DATA RECORD LOAD ADDRESS.

DRI is the data byte index within a DATA RECORD.

When an EXTENDED ADDRESS RECORD defines the value of SBA, the EXTENDED ADDRESS RECORD may appear anywhere within an 8086 hexadecimal object file. This value remains in effect until another EXTENDED ADDRESS RECORD is encountered. The SBA defaults to zero until an EXTENDED ADDRESS RECORD is encountered.

Recd Mark

The RECD MARK field contains 03AH, the hex encoding of ASCII ‘.’.

Rec Len

The Record Length field contains 3032H, the hex encoding of ASCII ‘02’.

Zeroes

The Load Address field contains 30303030H, the hex encoding of ASCII ‘0000’.

Rec Typ

The Record Type field contains 3032H, the hex encoding of ASCII ‘02’.

USBA

The USBA field contains four ASCII hexadecimal digits that specify the 8086 USBA value. The high-order digit is the 10th character of the record. The low order digit is the 13th character of the record.

Chk Sum

This is the check sum on the REC LEN, ZEROES, REC TYP, and USBA fields:

Data Record

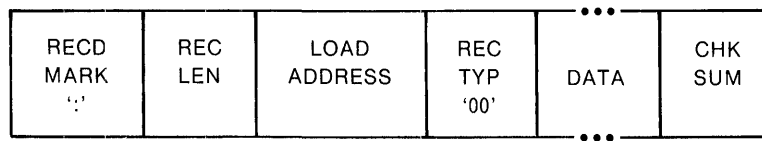

The DATA RECORD provides a set of hexadecimal digits that represent the ASCII code for data bytes that make up a portion of an 8086 memory image. The method for calculating the absolute address for each byte of DATA is described in the discussion of the Extended Address Record.

Recd Mark

The RECD MARK field contains 03AH, the hex encoding of ASCII ‘.’.

Rec Len

The REC LEN field contains two ASCII hexadecimal digits representing the number of data bytes in the record. The high-order digit comes first. The maximum value is ‘FF’ or 4646H (255 decimal).

Load Address

The LOAD ADDRESS field contains four ASCII hexadecimal digits representing the offset from the SBA (see EXTENDED ADDRESS RECORD) defining the address at which byte 0 of the DATA is to be placed. The LOAD ADDRESS value is used in calculation of the address of all DATA bytes.

Rec Typ

The REC TYP field in a DATA record contains 3030H, the hex encoding of ASCII '00'.

Data

The DATA field contains a pair of hexadecimal digits that represent the ASCII code for each data byte. The high order digit is the first digit of each pair.

Chk Sum

This is the check sum on the REC LEN, LOAD ADDRESS, REC TYPE, and DATA fields.

Start Address Record

RECD MARK '.'	REC LEN '04'	ZEROES '0000'	REC TYP '03'	CS	IP	CHK SUM
---------------------	--------------------	------------------	--------------------	----	----	------------

The START ADDRESS RECORD is used to specify the execution start address for the object file. Values are given for both the Instruction Pointer (IP) and Code Segment (CS) registers. This record can appear anywhere in a hexadecimal object file.

If a START ADDRESS RECORD is not present in an 8086 hexadecimal file, a loader is free to assign a default start address.

Recd Mark

The RECD MARK field contains 03AH, the hex encoding for ASCII '.'.

Rec Len

The REC LEN field contains 3034H, the hex encoding for ASCII '04'.

Zeroes

The ZEROES field contains 30303030H, the hex encoding for ASCII '0000'.

Rec Typ

The REC TYP field contains 3033H, the hex encoding for ASCII '03'.

CS

The CS field contains four ASCII hexadecimal digits that specify the 8086 CS value. The high-order digit is the 10th character of the record; the low-order digit is the 13th character of the record.

IP

The IP field contains the four ASCII hexadecimal digits that specify the 8086 IP value. The high-order digit is the 14th character of the record, the low order digit is the 17th character of the record.

Chk Sum

This is the check sum on the REC LEN, ZEROES, REC TYP, CS, and IP fields.

End of File Record

RECD MARK '.'	REC LEN '00'	ZEROES '0000'	REC TYP '01'	CHK SUM 'FF'
---------------------	--------------------	------------------	--------------------	--------------------

The END OF FILE RECORD specifies the end of the hexadecimal object file.

Recd Mark

The RECD MARK field contains 03AH, the ASCII code for colon (:).

Rec Len

The REC LEN field contains two ASCII zeroes (3030H).

Zeroes

The ZEROES field contains four ASCII zeroes (30303030H).

Rec Typ

The REC TYP field contains 3031H, the ASCII code for 01H.

Chk Sum

The CHK SUM field contains 4646H, the ASCII code for FFH, which is the check sum on the REC LEN, ZEROES and REC TYP fields.

Examples

Sample Absolute Object File

The following is an example of an absolute object file. The file contains eight records. The eight records perform the following functions:

Record	Function
1	LHEADR record begins the object module and defines the module name.
2	THEADR record defines the translator-generated module name which is the same as the name in the LHEADR record.
3	PEDATA record defines a contiguous memory image from 00200H to 00215H.
4	PEDATA record defines a contiguous memory image from 00360H to 00377H.
5	PEDATA record defines a contiguous memory image from 00415H to 0042BH.
6	PEDATA record defines a contiguous memory image from 051620H to 051633H.
7	PIDATA record defines a contiguous memory image from 051B00H to 051B1DH. The iterated data consists of three repetitions of "ABC" (414243H), followed by three repetitions of (four repetitions of "D" (44H)), three repetitions of "E" (45H).
8	MODEND record specifies that the module should be started with CS = 5162H and IP = 0005H.

- ```
(1) 82 0008 0653414D504C45 AE
(2) 80 0008 0653414D504C45 B0
(3) 84 001A 0020 00
 004992DB246DB6FF4891DA236CB5FE47
 90D9226BB4FD 63
(4) 84 001C 0036 00
 0062C42688EA4CAE1072D43698FA5CBE
 2082E446A80A6CCE 82
(5) 84 001B 0041 05
 001D3A577491AECBE805223F5C7996B3
 D0ED0A2744617E 72
(6) 84 0018 5162 00
 00850A8F14991EA328AD32B73CC146CB
 50D55ADF FB
(7) 86 001C 51B0 00
 0003 0000 03 414243
 0003 0002
 0004 0000 01 44
 0003 0000 01 45 FA
(8) 8A 0006 C0 5162 0005 F8
```

#### NOTE

The blank characters and carriage return and line feed characters are inserted here to improve readability. They do not occur in an object module. This file has been converted to ASCII hex so that it may be printed here. All word values (RECORD LENGTH, REPEAT COUNT, etc.) have been byte-reversed to improve readability.

### Sample Absolute Hexadecimal Object File

The following is the hexadecimal object file representation of the object file given in the example above:

```
:020000020020DC
:10000000004992DB246DB6FF4891DA236CB5FE47B8
:0600100090D9226BB4FD43
:020000020036C6
:100000000062C42688EA4CAE1072D43698FA5CBE00
:080010002082E446A80A6CCE30
:020000020041BB
:10000500001D3A577491AECBE805223F5C7996B353
:07001500D0ED0A2744617ED3
:02000002516249
:100000000085A8F14991EA328AD32B73CC146CB98
:0400100050D55ADF8E
:0200000251B0FB
:10000000414243414243414243444444444454545BF
:0E001000444444444454545444444444445454524
:040000035162000541
:00000001FF
```







# APPENDIX B

## HEXADECIMAL-DECIMAL CONVERSION

The following table is for hexadecimal-to-decimal and decimal-to-hexadecimal conversion. To find the decimal equivalent of a hexadecimal number, locate the hexadecimal number in the correct position and note the decimal equivalent. Add the decimal numbers.

To find the hexadecimal equivalent of a decimal number, locate the next lower decimal number in the table and note the hexadecimal number and its position. Subtract the decimal number from the table from the starting number. Find the difference in the table. Continue this process until there is no difference.

| BYTE |            | BYTE |         | BYTE |        | BYTE |       | BYTE |     |
|------|------------|------|---------|------|--------|------|-------|------|-----|
| HEX  | DEC        | HEX  | DEC     | HEX  | DEC    | HEX  | DEC   | HEX  | DEC |
| 0    | 0          | 0    | 0       | 0    | 0      | 0    | 0     | 0    | 0   |
| 1    | 1,048,576  | 1    | 65,536  | 1    | 4,096  | 1    | 256   | 1    | 16  |
| 2    | 2,097,152  | 2    | 131,072 | 2    | 8,192  | 2    | 512   | 2    | 32  |
| 3    | 3,145,728  | 3    | 196,608 | 3    | 12,288 | 3    | 768   | 3    | 48  |
| 4    | 4,194,304  | 4    | 262,144 | 4    | 16,384 | 4    | 1,024 | 4    | 64  |
| 5    | 5,242,880  | 5    | 327,680 | 5    | 20,480 | 5    | 1,280 | 5    | 80  |
| 6    | 6,291,456  | 6    | 393,216 | 6    | 24,576 | 6    | 1,536 | 6    | 96  |
| 7    | 7,340,032  | 7    | 458,752 | 7    | 28,672 | 7    | 1,792 | 7    | 112 |
| 8    | 8,388,608  | 8    | 524,288 | 8    | 32,768 | 8    | 2,048 | 8    | 128 |
| 9    | 9,437,184  | 9    | 589,824 | 9    | 36,864 | 9    | 2,304 | 9    | 144 |
| A    | 10,485,760 | A    | 655,360 | A    | 40,960 | A    | 2,560 | A    | 160 |
| B    | 11,534,336 | B    | 720,896 | B    | 45,056 | B    | 2,816 | B    | 176 |
| C    | 12,582,912 | C    | 786,432 | C    | 49,152 | C    | 3,072 | C    | 192 |
| D    | 13,631,488 | D    | 851,968 | D    | 53,248 | D    | 3,328 | D    | 208 |
| E    | 14,680,064 | E    | 917,504 | E    | 57,344 | E    | 3,584 | E    | 224 |
| F    | 15,728,640 | F    | 983,040 | F    | 61,440 | F    | 3,840 | F    | 240 |





# APPENDIX C

## THE EFFECT OF AVAILABLE MEMORY ON LINK86, CREF86, LIB86, AND LOC86

The system resources required by LINK86, CREF86, LIB86, or LOC86 depend on the number of symbols, modules, or segments in the input file(s). The greater the number of symbols in the input, the greater the memory requirements.

### LINK86, CREF86, AND LIB86

These utilities can take advantage of up to 512K of available memory space. When the number of symbols in the input list requires more memory than is available, these utilities use disk resources to accommodate the remainder. *Available memory* means RAM which the utilities have available to them exclusively. Once a utility has run out of memory and has to use disk, performance will become impaired.

The following table defines the number of symbols or modules which these utilities may process without performance degradation, given several levels of available memory. The available memory depends on the hardware and software environment under which the utilities are running on your system. Note that the relationship between number of symbols or modules and the amount of available memory is linear, up to a maximum. The following assumptions were used to calculate the figures provided:

- Variable and module names average 10 characters.
- Each symbol has five references (CREF86).
- Each module has 1.4 public names (LIB86).
- A symbol as used here is an abstract representation of an 8086 object module format record:

|                                                                                          | LINK86         | CREF86         | LIB86         |
|------------------------------------------------------------------------------------------|----------------|----------------|---------------|
| Maximum number of symbols or modules which can be processed without performance penalty: |                |                |               |
| With 100K available memory                                                               | 1,700 symbols  | 1,900 symbols  | 450 modules   |
| With 164K available memory                                                               | 2,900 symbols  | 3,300 symbols  | 1,000 modules |
| With 228K available memory                                                               | 4,200 symbols  | 4,700 symbols  | 1,700 modules |
| With 484K available memory                                                               | 10,000 symbols | 11,000 symbols | 4,000 modules |
| Theoretical maximum number of symbols or modules, regardless of available memory:        | 10,000 symbols | 11,000 symbols | 4,000 symbols |

### LOC86

With 96K of available memory, LOC86 will support up to 900 segments.





# APPENDIX D LINK86 CONTROLS AND ERROR MESSAGES

Table D-1 lists all of LINK86's control syntax, abbreviations, and default settings.

**Table D-1. Summary of LINK86 Controls**

| Control                                                                                                                                                                                                                              | Abbrev. | Default                         |
|--------------------------------------------------------------------------------------------------------------------------------------------------------------------------------------------------------------------------------------|---------|---------------------------------|
| ASSIGN({ <i>variable(address)</i> }[,...])                                                                                                                                                                                           | AS      | Not applicable                  |
| ASSUMEROOT( <i>pathname</i> )                                                                                                                                                                                                        | AR      | Not applicable                  |
| BIND                                                                                                                                                                                                                                 | BI      | NOBIND                          |
| NOBIND                                                                                                                                                                                                                               | NOBI    |                                 |
| COMMENTS                                                                                                                                                                                                                             | CM      | COMMENTS                        |
| NOCOMMENTS                                                                                                                                                                                                                           | NOCM    |                                 |
| FASTLOAD                                                                                                                                                                                                                             | FL      | NOFASTLOAD                      |
| NOFASTLOAD                                                                                                                                                                                                                           | NOFL    |                                 |
| INITCODE                                                                                                                                                                                                                             | IC      | Not applicable                  |
| LINES                                                                                                                                                                                                                                | LI      | LINES                           |
| NOLINES                                                                                                                                                                                                                              | NOLI    |                                 |
| MAP                                                                                                                                                                                                                                  | MA      | MAP                             |
| NOMAP                                                                                                                                                                                                                                | NOMA    |                                 |
| MEMPOOL( <i>min-size</i> [, <i>maxsize</i> ])                                                                                                                                                                                        | MP      | Not applicable                  |
| NAME( <i>module name</i> )                                                                                                                                                                                                           | NA      | Not applicable                  |
| OBJECTCONTROLS(<br>{LINES   NOLINES  <br>COMMENTS   NOCOMMENTS  <br>SYMBOLS   NOSYMBOLS  <br>PUBLICS [EXCEPT( <i>symbol</i> [,...])]  <br>NOPUBLICS [EXCEPT( <i>symbol</i> [,...])]  <br>TYPE   NOTYPE  <br>PURGE   NOPURGE} [,...]) | OC      | Not applicable                  |
| ORDER({ <i>group</i> ( { <i>segment</i> [\ <i>class</i> [\ <i>overlay</i> ] ] }<br>[,...]) }<br>[,...])                                                                                                                              | OD      | Not applicable                  |
| OVERLAY({ <i>overlay</i> })                                                                                                                                                                                                          | OV      | NOOVERLAY                       |
| NOOVERLAY                                                                                                                                                                                                                            | NOOV    |                                 |
| PRINT({ <i>pathname</i> })                                                                                                                                                                                                           | PR      | PRINT( <i>object file</i> .MP1) |
| NOPRINT                                                                                                                                                                                                                              | NOPR    |                                 |
| PRINTCONTROLS(<br>{LINES   NOLINES  <br>COMMENTS   NOCOMMENTS  <br>SYMBOLS   NOSYMBOLS  <br>PUBLICS [EXCEPT( <i>symbol</i> [,...])]  <br>NOPUBLICS [EXCEPT( <i>symbol</i> [,...])]  <br>TYPE   NOTYPE  <br>PURGE   NOPURGE} [,...])  | PC      | Not applicable                  |

Table D-1. Summary of LINK86 Controls (Cont'd.)

| Control                                                                                             | Abbrev.   | Default          |
|-----------------------------------------------------------------------------------------------------|-----------|------------------|
| PUBLICS [EXCEPT( <i>symbol</i> [...])]                                                              | PL [EC]   | PUBLICS          |
| NOPUBLICS [EXCEPT( <i>symbol</i> [...])]                                                            | NOPL [EC] |                  |
| PUBLICSONLY( <i>pathname</i> [...])                                                                 | PO        | Not applicable   |
| PURGE                                                                                               | PU        | NOPURGE          |
| NOPURGE                                                                                             | NOPU      | NOPURGE          |
| RENAMEGROUPS( <i>{group TO group}</i> [...])                                                        | RG        | Not applicable   |
| SEGSIZE(<br><i>{segment}{\class}{\overlay}</i><br>( <i>min-size</i> [, <i>max-size</i> ])<br>[...]) | SS        | Not applicable   |
| SYMBOLS                                                                                             | SB        | SYMBOLS          |
| NOSYMBOLS                                                                                           | NOSB      |                  |
| SYMBOLCOLUMNS( <i>{1 2 3 4}</i> )                                                                   | SC        | SYMBOLCOLUMNS(2) |
| TYPE                                                                                                | TY        | TYPE             |
| NOTYPE                                                                                              | NOTY      |                  |

The following are descriptions of all LINK86 error and warning messages. The description of each message has up to four parts:

- Meaning—how to interpret the message
- Cause—the usual reason for the error or warning condition
- Effect—the state of LINK86 and the object file(s) after the message is issued
- User Action—what you can do to correct the condition

Not all these parts are given for each message. However, parts excluded are self-explanatory.

Error messages are always fatal, but warning messages are not. In the event of a warning, read the EFFECT of the warning carefully to determine whether the resulting code is valid.

Error and warning messages are displayed at the console device, but printed only if a listing would otherwise be printed.

```
ERROR 1: I/O ERROR
 operating system error message
 FILE: pathname
```

```
ERROR 2: I/O ERROR
 operating system error message
 FILE: pathname
```

**ERROR 3: I/O ERROR**  
*operating system error message*  
FILE: *pathname*

**ERROR 4: CONSOLE I/O ERROR**  
*operating system error message*  
FILE: *pathname*

### Meaning

An I/O error was detected by the operating system. The error number identifies the file that caused the error:

1. The input file
2. The print file
3. The object file
4. The console file (usually the console)

Refer to the documentation for your operating system for a complete list of all possible messages.

### Effect

LINK 86 immediately terminates processing, all open files are closed. The contents of the print and object files are undefined.

### User Action

Correct the error and restart LINK86.

**ERROR 5: INPUT PHASE ERROR**  
FILE: *pathname*  
MODULE: *module name*

### Meaning

LINK86 encountered a record during the second phase of linkage that does not agree with information gathered during the first phase of linkage.

### Cause

This error is caused by a data transmission error or a LINK86 error.

### Effect

LINK86 immediately terminates processing and closes all open files. The contents of the print file and the object file are undefined.

### User Action

Contact Intel immediately. Forward a copy of the object file, the LINK86 invocation line, and your version of LINK86.



```
ERROR 6: CHECK SUM ERROR
FILE: pathname
MODULE: module name
```

**Meaning**

The check sum field at the end of one of the object module records indicates a transcription error.

**Cause**

Any one of many possible data encoding or communication errors could be at fault.

**Effect**

LINK86 immediately terminates processing and closes all open files. The contents of the print file and the object file are undefined.

**User Action**

Retranslate the source that produced the specified module and relink.

```
ERROR 7: COMMAND INPUT ERROR
```

**Meaning**

LINK86 encountered an error while attempting to read the complete invocation line.

**Cause**

Possibly an end-of-file while reading from the console input device.

**Effect**

LINK86 immediately terminates processing and closes all open files. The contents of the print file and the object file are undefined.

**User Action**

Examine the invocation line, and reinvoke LINK86 correctly.

```
WARNING 8: SEGMENT COMBINATION ERROR
FILE: pathname
MODULE: module name
SEGMENT: segment name
CLASS: class name
```

**Meaning**

Two segments with the same name have been found to be uncombinable.

**Cause**

The specified segments have different combination attributes or incompatible alignment attributes.

**Effect**

Although LINK86 will continue processing pass 1, pass 2 will not be started. The object file will be useless and the print file will contain limited information.

**User Action**

Retranslate the source that produced the specified file and module.

```
WARNING 9: TYPE MISMATCH
FILE: pathname
MODULE: module name
SYMBOL: symbol name
```

**Meaning**

LINK86 has found a public/external symbol pair for which the type definitions do not agree.

**Effect**

LINK86 continues processing using the first definition only. The object file and the print file should be valid, except the second definition is ignored.

**User Action**

Modify the public or external declaration and recompile and relink the source file.

```
WARNING 10: DIFFERENT VALUES FOR
FILE: pathname
MODULE: module name
SYMBOL: symbol name
```

**Meaning**

LINK86 encountered the same symbol declared public in two different modules. The specified file and module contains the second definition encountered.

**Cause**

Two modules have used the same symbol name for different public definitions.

**Effect**

LINK86 continues processing using the value of the first public definition; the second definition is ignored. Both the print file and the object file will be valid.

**User Action**

Change the name of the symbol in either the specified file or the file containing the earlier definition.

```
ERROR 11: INSUFFICIENT MEMORY
FILE: pathname
MODULE: module name
```

**Meaning**

There is insufficient memory in your system for LINK86 to build its internal tables and data structures.

**Cause**

You are using too many public symbols.

**Effect**

LINK86 immediately terminates processing and closes all open files. The contents of the print file and the object file are undefined.

**User Action**

If expanding system memory is not possible, try incremental linkage (i.e., link smaller sets of files together using the NOPUBLICS control, then link the resulting composite modules together).

```
WARNING 12: UNRESOLVED SYMBOLS
FILE: pathname
MODULE: module name
```

**Meaning**

There are declarations of external symbols that were not resolved during this linkage.

**Cause**

This is very common when performing an incremental linkage.

**Effect**

The print file is valid. The object file must be linked to resolve the external references.

**User Action**

Link object file to a file that will resolve the external references.

```
WARNING 13: IMPROPER FIXUP
FILE: pathname
MODULE: module name
```

**Cause**

The external reference makes assumptions about the segment register that do not agree with the assumption made for the public definition.

**Effect**

LINK86 continues processing. The object file will not be usable, but the print file will be complete and accurate.

**User Action**

Depending on the cause of the error: change your ORDER control, recompile with a different model of segmentation, or change the source and reassemble.

```
WARNING 14: GROUP ENLARGED
FILE: pathname
GROUP: group name
MODULE: module name
```

### Meaning

The specified group name has been defined twice in two different modules. The segments contained in the two definitions are different.

### Effect

The two groups are combined into one. All segments that were in either group are included in the resulting group. Segments with the same segment name, class name, and overlay name are combined. LINK86 continues processing. Both the print file and object file are valid.

### User Action

No user action should be necessary.

```
ERROR 15: LINK86 ERROR
FILE: pathname
MODULE: module name
```

### User Action

Contact Intel immediately. Forward a copy of the object file, the LINK86 invocation line, and your version of LINK86.

```
ERROR 16: STACK OVERFLOW
FILE: pathname
MODULE: module name
```

### Meaning

LINK86's run time stack used for type matching has overflowed.

### Cause

The type definition of one of your symbols is overly complex.

### Effect

LINK86 immediately terminates processing and closes all open files. The contents of the print file and the object file are undefined.

### User Action

Try incremental linkage — if error persists, contact Intel.

**WARNING 17: SEGMENT OVERFLOW**  
SEGMENT: *segment name*  
CLASS: *class name*

### Meaning

The combination of two or more segments has resulted in a segment that exceeds 64K.

### Effect

LINK86 continues processing during the current pass, but the print and object files are not useable.

### User Action

Reorganize your segments and reassemble.

**WARNING 18: IMPROPER START ADDRESS**  
FILE: *pathname*  
MODULE: *module name*

### Meaning

A start address was found in one of the overlay modules, and none was found in the root module.

### Cause

This error is often caused by misordering the input modules in the input list.

### Effect

LINK86 ignores the start address in the specified overlay module and continues processing.

### User Action

If you want the module containing the start address to be the root, relink with that module first in the input list.

**ERROR 19: TYPE DESCRIPTION TOO LONG**  
FILE: *pathname*  
MODULE: *module name*

### Meaning

The type definition is too long to fit in LINK86's symbol table.

### Effect

LINK86 immediately terminates processing and closes all open files. The contents of the print file and the object file are undefined.

### User Action

Contact Intel immediately. Forward a copy of the object file, the LINK86 invocation line, and your version of LINK86.

```
WARNING 20: NO SUCH GROUP
NAME: group name
```

**Cause**

You have attempted to rename a nonexistent group.

**Effect**

LINK86 ignores the RENAME control and continues processing.

**User Action**

Reinvoke LINK86 with the correct invocation line.

```
WARNING 21: RENAME ERROR
NAME: name
```

**Meaning**

The new group name specified is the same as an existing group.

**Effect**

The group is not renamed. LINK86 continues as if the rename control was not given.

**User Action**

Reinvoke LINK86 with the correct invocation line.

```
ERROR 22: INVALID SYNTAX
ERROR IN COMMAND TAIL NEAR #
partial command tail
```

**Cause**

This is usually the result of a typo in the invocation line. The partial command tail up to the point where the error was detected is printed.

**Effect**

LINK86 terminates processing and closes all open files. The contents of the print file and the object file are undefined.

**User Action**

Reinvoke LINK86 more carefully this time.

```
ERROR 23: BAD OBJECT FILE
 FILE: pathname
 MODULE: module name
```

**Meaning**

LINK86 has discovered an inconsistency in the fields of a record in the specified input file.

**Cause**

This could be an error by the translator or a data transmission error.

**Effect**

LINK86 immediately terminates processing and closes all open files. The contents of the print file and the object file are undefined.

**User Action**

Retranslate the source file. If the problem persists contact Intel.

```
WARNING 24: CANNOT FIND MODULE
 FILE: pathname
 MODULE: module name
```

**Meaning**

The specified module cannot be found in the specified library file.

**Effect**

LINK86 continues processing as if the specified module was not in the list.

**User Action**

If the module is important, you can link it into the output object file later.

```
WARNING 25: EXTRA START ADDRESS IGNORED
 FILE: pathname
 MODULE: module name
```

**Meaning**

LINK86 has encountered a start address in more than one module.

**Cause**

This will occur any time you specify more than one main module in the input list.

**Effect**

LINK86 uses the start address encountered earlier and ignores the start address in the specified module. LINK86 continues processing with no other side effects.

**User Action**

None, if the start address in the specified module was intended to be ignored.



ERROR 26: NOT AN OBJECT FILE  
FILE: *pathname*

### Meaning

The specified file is not an object file.

### Cause

This is usually the result of a typo when entering. However, certain data transmission errors can also cause this error.

### Effect

LINK86 terminates processing and closes all open files.

### User Action

Reinvoke LINK86 typing the line more carefully. If error resulted from a data transmission error, retranslate and then relink.

ERROR 27: OPERATING SYSTEM INTERFACE ERROR  
FILE: *pathname*

### Effect

LINK86 immediately terminates processing and closes all open files. The contents of the print file and the object file are undefined.

### User Action

Refer to the documentation for your operating system. If you cannot correct the error condition, contact Intel; forward a copy of the object file, the LINK86 invocation line, and your version of LINK86.

WARNING 28: POSSIBLE OVERLAP  
FILE: *pathname*  
MODULE: *module name*  
SEGMENT: *segment name*  
CLASS: *class name*

### Meaning

LINK86 issues this warning when it combines two absolute segments.

### Effect

LINK86 continues processing with no side effects.

### User Action

If there is a conflict LOC86 or the loader will detect the overlap.

**WARNING 29: GROUP HAS BAD EXTERNAL REFERENCE**  
GROUP: *group name*  
SEGMENT: *segment name*

### Meaning

This error occurs if the public symbol corresponding to an external reference has been specified by its absolute address, and the address does not reside in any segment.

### Effect

LINK86 continues processing and the print and object files will be valid except the external reference has not been properly resolved.

### User Action

Either remove the reference to the public symbol or do not allow the symbol to be absolute.

**ERROR 30: LIBRARY IS NOT ALLOWED WITH PUBLICONLY CONTROL**  
FILE: *pathname*

### Meaning

The specified file is a library and libraries are not allowed in a PUBLICONLY control.

### Effect

LINK86 immediately terminates processing and closes all open files. The contents of the print file and the object file are undefined.

### User Action

Remove library file from PUBLICONLY argument list and reinvoke LINK86.

**WARNING 31: REFERENCED LOCATION OFFSET UNDERFLOW**  
FILE: *pathname*  
MODULE: *module name*

### Meaning

While computing the offset for an 8089 self relative reference, LINK86 had a negative result.

### Cause

Either with the ORDER control or the order of files in the input list, the reference was separated from its target, or the 8089 segment is too large.

### Effect

LINK86 continues processing; however, the invalid offset computation is used.

### User Action

Examine the ORDER control in the invocation line and modify its arguments. Reinvoke LINK86 carefully.

```
WARNING 32: EXTRA REGISTER INITIALIZATION RECORD IGNORED
FILE: pathname
MODULE: module name
```

**Cause**

You have included two main modules in your input list.

**Effect**

LINK86 uses the first register initialization record and ignores the second. Processing continues.

**User Action**

If the register initialization information in the specified file and module should be used, then modify your input list; otherwise, no user action is necessary.

```
ERROR 33: ILLEGAL USE OF OVERLAY CONTROL
FILE: pathname
MODULE: module name
```

**Meaning**

LINK86 has found an overlay definition in the specified file and module, while processing input modules for an overlay.

**Effect**

LINK86 immediately terminates processing; all open files are closed. The contents of the print and object files are undefined.

**User Action**

Remove the specified file from the input list and relink.

```
ERROR 34: TOO MANY OVERLAYS IN INPUT FILE
FILE: pathname
MODULE: module name
```

**Meaning**

The specified file and module above contains more than one overlay definition.

**Effect**

LINK86 immediately terminates processing; all open files are closed. The contents of the print and object files are undefined.

**User Action**

Remove the specified file from the input list and relink.

```
ERROR 35: SAME OVERLAY NAME IN TWO OVERLAYS
 FILE: pathname
 MODULE: module name
 NAME: name
```

**Meaning**

The specified file contains an overlay that has the same name as an overlay encountered in the input list.

**Effect**

LINK86 immediately terminates processing; all open files are closed. The contents of the print and object files are undefined.

**User Action**

Remove one of the duplicate names from the input list and relink. If both overlays are necessary, relink one overlay specifying a different overlay name.

```
ERROR 36: ILLEGAL OVERLAY CONSTRUCTION
 FILE: pathname
 MODULE: module name
```

**Meaning**

Some of the modules in the input list contain overlay definitions while others do not. This is not permitted — all modules in the input list must be the same with respect to overlays.

**Effect**

LINK86 immediately terminates processing; all open files are closed. The contents of the print and object files are undefined.

**User Action**

Remove the non-overlay files and relink.

```
WARNING 37: DIFFERENT PUBLICS FOR EXTERNAL IN ROOT
 FILE: pathname
 MODULE: module name
```

**Meaning**

LINK86 has found two symbol definitions in the overlay modules that resolve an external symbol definition in the root.

**Effect**

LINK86 ignores the definition in the specified file and module, and continues processing with no side effects.

**User Action**

Remove the unwanted symbol definition and relink.

```
ERROR 38: INVALID OVERLAPPING GROUPS
FILE: pathname
MODULE: module name
SEGMENT: segment name
GROUP: group name
```

**Meaning**

While binding the input list LINK86 found a segment that was defined to be within two groups.

**Effect**

LINK86 immediately terminates processing; all open files are closed. The contents of the print and object files are undefined.

**User Action**

Either modify the source to remove the segment from one of the groups or do not link with the BIND control.

```
ERROR 39: SPECIFIED GROUP NOT FOUND IN INPUT MODULE
GROUP: group name
```

**Cause**

Often this is the result of a typographical error in the invocation line.

**Effect**

LINK86 immediately terminates processing; all open files are closed. The contents of the print and object files are undefined.

**User Action**

Correct the invocation line and relink.

```
ERROR 40: SPECIFIED SEGMENT NOT FOUND IN THE GROUP
SEGMENT: segment name
GROUP: group name
```

**Cause**

Usually this is the result of a typographical error in the ORDER control.

**Effect**

LINK86 immediately terminates processing; all open files are closed. The contents of the print and object files are undefined.

**User Action**

Correct the invocation line and relink.

```
ERROR 41: SPECIFIED SEGMENT NOT FOUND IN INPUT MODULE
 SEGMENT: segment name
 CLASS: class name
```

**Cause**

Usually this is the result of a typographical in the SEGSIZE control.

**Effect**

LINK86 immediately terminates processing; all open files are closed. The contents of the print and object files are undefined.

**User Action**

Find the module that contains the specified segment and add it to the input list.

```
WARNING 42: DECREASING SIZE OF SEGMENT
 SEGMENT: segment name
```

**Meaning**

The size change specified in SEGSIZE has caused LINK86 to decrease the size of the specified segment.

**Effect**

Decreasing the size of a segment can cause sections of code to be unaccounted for during the memory allocation process. LINK86 continues processing with no side effects.

**User Action**

None if the size decrease was intended.

```
ERROR 43: SEGMENT SIZE OVERFLOW; OLD SIZE + CHANGE > 64K
 SEGMENT: segment name
 CLASS: class name
```

**Meaning**

The size change specified in the SEGSIZE control caused the segment to become greater than 64K.

**Effect**

LINK86 immediately terminates processing; all open files are closed. The contents of the print and object files are undefined.

**User Action**

Reinvoke LINK86 with the correct SEGSIZE control.

```
ERROR 44: SEGMENT SIZE UNDERFLOW; OLD SIZE + CHANGE < 0
 SEGMENT: segment name
 CLASS: class name
```

**Meaning**

The size change specified in the SEGSIZE control caused the segment's size to be less than zero.

**Effect**

LINK86 immediately terminates processing; all open files are closed. The contents of the print and object files are undefined.

**User Action**

Reinvoke LINK86 with the correct SEGSIZE control.

```
ERROR 45: THE SEGMENT MAXIMUM SIZE IS LESS THAN THE
 SEGMENT MINIMUM SIZE
 SEGMENT: segment name
 CLASS: class name
```

**Cause**

Usually this is the result of a typographical error in the SEGSIZE control.

**Effect**

LINK86 immediately terminates processing; all open files are closed. The contents of the print and object files are undefined.

**User Action**

Correct the invocation line and relink.

```
ERROR 46: ILLEGAL USE OF SEGSIZE CONTROL
 SEGMENT: segment name
 CLASS: class name
```

**Cause**

A maximum size was specified for either a stack segment, an absolute segment, or a segment that is not the highest component of its group.

**Effect**

LINK86 immediately terminates processing; all open files are closed. The contents of the print and object files are undefined.

**User Action**

Remove the specified segment from the SEGSIZE control and relink.

WARNING 47: GROUP HAS NO CONSTITUENT SEGMENTS  
GROUP: *group name*

**Meaning**

The group has no segments and is not placed in the output object file.

**Cause**

Often this is the result of a typographical error in the invocation line.

**Effect**

LINK86 does not place the specified group in the object file and continues processing with no side effects.

**User Action**

Unless there is some particular need for the specified group, no user action is necessary.

WARNING 48: SIZE OF GROUP EXCEEDS 64K  
GROUP: *group name*

**Meaning**

All of the segments that belong to the specified group do not fit within the physical segment defined for that group.

**Cause**

This error is usually caused by misuse of the SEGSIZE or ORDER controls.

**Effect**

LINK86 includes all segments in the object file and continues processing the input module. The output module will be executable, although addressing errors may occur.

**User Action**

Examine the invocation line and reinvoke LINK86 using the SEGSIZE or ORDER control more carefully.



WARNING 49: MAXIMUM SIZE OF GROUP EXCEEDS 64K  
GROUP: *group name*

### Meaning

The maximum segment size for the segments contained in the specified group exceeds 64K.

### Cause

This error is usually caused by misuse of the SEGSIZE control.

### Effect

LINK86 reduces the maximum size of the group and its constituent segments. LINK86 continues processing the input module. The output module will be executable.

### User Action

No action is necessary. If you want to remove the error, examine the invocation line and reinvoke LINK86 using the SEGSIZE control more carefully.

WARNING 50: MORE THAN ONE SEGMENT WITH THE MEMORY  
ATTRIBUTE  
SEGMENT: *segment name*

### Meaning

After the first memory segment is found, LINK86 issues this warning each time it finds a segment with the memory attribute.

### Effect

LINK86 ignores the memory attribute on the segment specified in the message. Processing continues with LINK86 treating the additional memory segment as just another segment.

### User Action

Depending on your intentions, this message may be ignored or you may wish to change the segment definition and relink.

WARNING 51: SEGMENT WITH MEMORY ATTRIBUTE NOT PLACED  
HIGHEST IN MEMORY  
SEGMENT: *segment name*

### Meaning

The specified memory segment was not located at the highest offset in its group.

### Cause

This can only occur when you explicitly request this organization through the ORDER control.

### Effect

Since this can only occur by user request, LINK86 continues processing without side effects.

```
WARNING 52: OFFSET FIXUP OVERFLOW
FILE: pathname
MODULE: module name
```

**Meaning**

While computing an offset from a base, LINK86 found that the offset was greater than 64K.

**Cause**

One of the segments of a group is outside the 64K frame of reference defined by its group base.

**Effect**

LINK86 continues processing. The print file will be valid, but the output file with regard to the out of place segment will not be usable.

**User Action**

Modify the group definitions in your source and retranslate.

```
WARNING 53: OVERFLOW OF LOW BYTE FIXUP VALUE
FILE: pathname
MODULE: module name
```

**Meaning**

An 8-bit displacement value, when calculated, exceeded 255.

**Cause**

This type of error often occurs when a page resident segment crosses a page boundary.

**Effect**

LINK86 continues processing. The contents of both the print file and the object file will be valid. However, the fixup value will remain invalid.

**User Action**

Organize your segments so that the addressing error will not be encountered.

```
ERROR 54: ILLEGAL USE OF ORDER CONTROL
GROUP: group name
```

**Meaning**

The specified group's segments have already been ordered.

**Cause**

You are attempting to relink a file that has been linked with the BIND control.

**Effect**

LINK86 immediately terminates processing; all open files are closed. The contents of the print and object files are undefined.

**User Action**

Relink using the unbound input modules.

ERROR 55: ILLEGAL FIXUP  
FILE: *pathname*  
MODULE: *module name*

### Meaning

While processing a fixup record, LINK86 found that the base for the reference and target are different.

### Cause

This is usually a coding error.

### Effect

LINK86 immediately terminates processing; all open files are closed. The contents of the print and object files are undefined.

### User Action

Examine your assembly language source and retranslate.

ERROR 56: DATA ADDRESS OUTSIDE SEGMENT BOUNDARIES  
FILE: *pathname*  
MODULE: *module name*  
SEGMENT: *segment name*

### Meaning

One of the data records associated with the specified segment contains an address outside of the segment's boundary.

### Cause

This error can occur when you decrease the size of a segment.

### Effect

LINK86 immediately terminates processing; all open files are closed. The contents of the print and object files are undefined.

### User Action

Change SEGSIZE control and relink.

ERROR 57: MAXIMUM DYNAMIC STORAGE LESS THAN MINIMUM  
DYNAMIC STORAGE

### Meaning

The size change specified in MEMPOOL has caused the maximum dynamic storage to be less than the minimum dynamic storage.

### Effect

LINK86 immediately terminates processing; all open files are closed. The contents of the print and object files are undefined.

### User Action

Reinvoke LINK86 with correct arguments to MEMPOOL.

WARNING 58: NO START ADDRESS SPECIFIED IN INPUT MODULES

**Meaning**

The BIND control was specified, and none of the input modules has a start address.

**Cause**

The input list contains no main module.

**Effect**

The CS and IP registers remain uninitialized, and their values are dependent on your system loader. The object module will be valid.

**User Action**

Reinvoke LINK86 with a main module or execute LOC86 with the START control.

ERROR 59: I/O ERROR WITH ROOT-FILE IN ASSUMEROOT CONTROL  
FILE: *pathname*  
*operating system message*

**Meaning**

The ASSUMEROOT control was specified, but the root file identified by *pathname* in the invocation could not be accessed.

**Effect**

LINK86 immediately terminates processing.

**User Action**

Refer to your operating system documentation to correct the condition, then reinvoke LINK86.

ERROR 60: OUTPUT FILE IS SAME AS INPUT FILE  
FILE: *pathname*

**Meaning**

LINK86 detected an output pathname identical to an input pathname.

**Cause**

The pathnames of the specified input file and the output file were identical.

**Effect**

LINK86 terminates processing immediately.

**User Action**

Reinvoke LINK86 after fixing the duplicate-name situation.

```
ERROR 61: ROOT-FILE IN ASSUMEROOT CONTROL IS NOT PROPER
 OBJECT FILE
 FILE: pathname
```

**Meaning**

The ASSUMEROOT control was specified, but the root file is not found to have an overlay record in it.

**Cause**

The root file needs an overlay record.

**Effect**

LINK86 terminates processing immediately.

**User Action**

Relink the root file using the OVERLAY control.

```
WARNING 62: ASSUMEROOT CONTROL MEANINGFUL ONLY WITH
 OVERLAYS
```

**Meaning**

The ASSUMEROOT control should be used only when the input modules do not contain overlay records.

**Cause**

ASSUMEROOT was specified, but not in conjunction with the OVERLAY control.

**Effect**

LINK86 ignores the ASSUMEROOT control. The object code is valid.

**User Action**

Reinvoke LINK86, using the OVERLAY and ASSUMEROOT controls.

```
WARNING 63: BAD SEGMENT ALIGNMENT
 FILE: pathname
 MODULE: module name
 SEGMENT: segment name
```

**Meaning**

The segment is not paragraph/page-aligned.

**Cause**

The object code has references to the base of the specified segment, and the segment is not declared as paragraph/page-aligned.

**Effect**

Although the object module will be valid, the loader may not load the program correctly.

**User Action**

Declare the specified segment to be paragraph/page-aligned.

WARNING 64: PUBLIC SYMBOLS NOT SORTED DUE TO INSUFFICIENT  
MEMORY

### Meaning

The amount of memory required to sort the public symbols for the LINK86 print file listing is insufficient.

### Cause

The number of public symbols in the input-list modules is too large for LINK86 to sort with the available memory resources.

### Effect

The LINK86 print file listing provides public symbols in the order in which they were encountered in the input files. This condition has no effect on the correctness or validity of the output module.

### User Action

Increase the amount of available RAM or decrease the number of public symbols.

WARNING 65: ILLEGAL FIXUP: INCORRECT DECLARATION OF  
EXTERNAL SYMBOL

FILE: *pathname containing external declaration*

MODULE: *name of module containing external declaration*

SYMBOL: *name of external symbol*

FRAME: *identification of reference location*

TARGET: *identification of target location*

### Meaning

The declaration of the specified SYMBOL was found to be inconsistent with a corresponding public symbol definition, and LINK86 could not resolve the reference.

### Cause

This condition may exist for several reasons. The modules containing the external and public symbols may have been compiled under different translator controls (e.g., SMALL, LARGE). In the case of assembly language programs, the SYMBOL may be defined in a group, segment, or frame different from that in which it is declared as external. Or an attempt has been made to access absolute entry points from pre-located code without using the PUBLICSONLY control explicitly.

### Effect

LINK86 internally converts these illegal fixups to legal formats to identify all occurrences in a single execution. Thus the output object module may not be correct, although it will be a valid 8086 object module.

### User Action

If the warning occurred because of an attempted access of absolute entry points from pre-located code, use the PUBLICSONLY control in conjunction with the file that contains public definitions for those entry points. Otherwise, use the FRAME and TARGET information given in the warning message to pinpoint the source of the error, then correct the code.

For example:

```
WARNING 65: ILLEGAL FIXUP: INCORRECT DECLARATION OF
 EXTERNAL SYMBOL
FILE: EXTFIL
MODULE: EXTMODULE
SYMBOL: EXTSYM
FRAME: GROUP - GROUP1
TARGET: SEGMENT - SEGMENT5
```

The symbol EXTSYM is declared to be in SEGMENT5. The external-public resolution specified that the calculations be made with respect to the base of GROUP1, but the segment SEGMENT5 is not in GROUP1.

```
WARNING 66: CS AND IP REGISTERS ARE NOT INITIALIZED
```

### Meaning

The INITCODE control was specified, and the register initialization record does not contain information for initialization of 8086 registers. CS means code segment register, and IP means instruction pointer.

### Cause

This condition is usually the result of an incomplete END directive in your assembly language module or a translation error.

### Effect

The values of CS and IP at the beginning of program execution are entirely dependent on the loader of your system. The object code will be valid.

### User Action

Retranslate your code, then reinvoke LINK86.

```
WARNING 67: SS AND SP REGISTERS ARE NOT INITIALIZED
```

### Meaning

The INITCODE control was specified, and the register initialization record does not contain information for initialization of 8086 registers. SS means stack segment and SP means stack pointer.

### Cause

This condition is usually the result of an incomplete END directive in your assembly language module or a translation error.

### Effect

The values of SS and SP at the beginning of program execution are entirely dependent on the loader of your system. The object code will be valid.

### User Action

Correct your code if necessary, then reinvoke LINK86.

**WARNING 68: DS REGISTER NOT INITIALIZED****Meaning**

The INITCODE control was specified, and the register initialization record does not contain information for initialization of the 8086 DS (data segment) register.

**Cause**

This condition is usually the result of an incomplete END directive in your assembly language module or a translation error.

**Effect**

The value of the DS register at program execution is entirely dependent on the loader of your system.

**User Action**

Correct your code if necessary, then reinvoke LINK86.

**WARNING 69: OVERLAPPING DATA RECORDS****Meaning**

The FASTLOAD control was specified, and two data records belonging to the same segment have offsets which make them overlapping.

**Cause**

This warning is usually the result of a translation error, unless you have intentionally overlapped data records.

**Effect**

LINK86 ignores the second record and does not include it in the output file. The code will be unusable.

**User Action**

If you want an overlap condition to exist, reinvoke, but do not use the FASTLOAD control. Otherwise, retranslate, then reinvoke LINK86.

**WARNING 70: INITCODE CONTROL INEFFECTIVE WITH BIND CONTROL****Meaning**

The INITCODE and BIND controls were combined in one invocation statement.

**Effect**

The INITCODE control will be ignored by LINK86.

**User Action**

Do not invoke LINK86 using both of these controls at the same time. To invoke them separately, use the INITCODE control first, then the BIND control during a second invocation.



```
WARNING 71: TOO MANY MAIN MODULES IN INPUT
FILE: pathname
MODULE: module name
```

**Meaning**

LINK86 discovered two or more main modules (modules with start addresses) in the input list.

**Cause**

The input list contains too many main modules.

**Effect**

LINK86 uses the start address of the first main module it reads and ignores the others. The object code will be valid.

**User Action**

Ensure that the LINK86 interpretation is suitable to your objectives. If not, modify the input list, and reinvoke LINK86.

```
WARNING 72: REGISTER INITIALIZATION CODE EXISTS, NEW
INITIALIZATION IGNORED
FILE: pathname
MODULE: module name
```

**Meaning**

Two or more initialization codes for 8086 registers were encountered in the input list.

**Cause**

This condition resulted from a translation or linkage problem.

**Effect**

LINK86 uses the first initialization code and ignores the others. The object code will be valid.

**User Action**

If retranslating or relinking does not correct the error, contact Intel.

```
WARNING 73: INITCODE CONTROL INEFFECTIVE WITH OVERLAYS
```

**Meaning**

Both INITCODE and OVERLAY controls were specified.

**Effect**

The INITCODE control is ignored. The object code will be valid.

**User Action**

Reinvoke LINK86, using the INITCODE control. In a second invocation, specify the OVERLAY control.

ERROR 74: PRINT FILE SAME AS INPUT FILE  
FILE: *pathname*

**Meaning**

The pathnames of the print file and one of the input files are identical.

**Effect**

LINK86 terminates processing immediately.

**User Action**

Reinvoke LINK86 after fixing the duplicate-name situation.

ERROR 75: PRINT FILE SAME AS OUTPUT FILE

**Meaning**

The names of the print and output files are identical.

**Cause**

The invocation line included duplicate names.

**Effect**

LINK86 terminates processing immediately.

**User Action**

Correct the invocation line and reinvoke LINK86.

WARNING 76: BASE OF REFERENCED SEGMENT DIFFERS FROM BASE  
OF CONTAINING GROUP

FILE: *pathname*  
GROUP: *group name*  
MODULE: *module name*  
SEGMENT: *segment name*

**Meaning**

An assembly language reference to the base of the specified segment in the specified group exists. However, the specified segment is not the first segment in the group. This warning occurs only when BIND is in effect.

**Cause**

Unless you have deliberately created this reference, this warning is most likely the result of an incorrect ASSUME directive or an incorrect OFFSET operator specification.

**Effect**

LINK86 will process the specified reference to the segment base rather than to the group base. The output module will be valid.

**User Action**

If the reference to the segment base was deliberate, continue debugging your assembly language code as planned. Otherwise, check the correctness of the code, particularly the ASSUME directives and OFFSET operator specifications; then reassemble and relink.

WARNING 77: REFERENCED OFFSET IN SEGMENT DIFFERS FROM  
OFFSET FROM GROUP BASE

FILE: *pathname*  
GROUP: *group name*  
MODULE: *module name*  
SEGMENT: *segment name*

### Meaning

An assembly language reference to an offset from the base of the specified segment in the specified group exists. However, the specified segment is not the first segment in the group. This warning occurs only when BIND is in effect.

### Cause

Unless you have deliberately created this reference, this warning is most likely the result of an incorrect ASSUME directive or an incorrect OFFSET operator specification.

### Effect

LINK86 will process the specified reference as an offset from the segment base rather than the group base. The output module will be valid.

### User Action

If the reference to the offset in the segment was deliberate, continue debugging your assembly language code as planned. Otherwise, check the correctness of the code, particularly the ASSUME directives and OFFSET operator specifications; then reassemble and relink.



# APPENDIX E CREF86 CONTROLS AND ERROR MESSAGES

Table E-1 lists all of CREF86's control syntax, abbreviations, and default settings.

Table E-1. Summary of CREF86 Controls

| Control                          | Abbrev. | Default                                |
|----------------------------------|---------|----------------------------------------|
| PAGELength( <i>number</i> )      | PL      | PAGELength(60)                         |
| PAGEWIDTH( <i>number</i> )       | PW      | PAGEWIDTH(120)                         |
| PRINT ( <i>pathname</i> )        | PR      | PRINT ( <i>first input file .CRF</i> ) |
| TITLE( <i>character-string</i> ) | TT      | Not applicable                         |

The following are descriptions of all CREF86 error and warning messages. The description of each message has up to four parts:

- Meaning—how to interpret the message
- Cause—the usual reason for the error or warning condition
- Effect—the state of CREF86 and the object file(s) after the message is issued
- User Action—what you can do to correct the condition

Not all these parts are given for each message. However, parts excluded are self-explanatory.

Error messages are always fatal, but warning messages are not.

Error and warning messages are displayed at the console device, but printed only if a listing would otherwise be printed.

**ERROR 1: I/O ERROR**  
*operating system message explaining the cause of this error*  
FILE: *pathname*

### Meaning

An I/O error was detected. See the appropriate operating system documentation for interpretation.

### Effect

CREf86 immediately terminates processing; all open files are closed. The contents of the print file are undefined.

### User Action

Correct the error and restart CREF86.

**ERROR 2: SYNTAX ERROR IN INPUT COMMAND****Meaning**

An error in the syntax of the invocation line was detected.

**Cause**

This condition is usually the result of a typographical error or transposition.

**Effect**

The invocation command line, to the point it is parsed, is written to the console with a # following this string.

**User Action**

Correct the syntactic error and retransmit the invocation line(s).

**ERROR 3: OUT OF MEMORY****Meaning**

CREF86 does not have enough memory to create its internal data structures, tables, etc. This condition may also occur because of inadequate disk space for temporary files.

**Cause**

The input list contains too many symbols and/or too many references among them.

**Effect**

CREF86 immediately terminates processing, closing all open files. The contents of the print file are undefined.

**User Action**

Ensure that adequate resources are available to run CREF86.

**ERROR 4: I/O ERROR**

*operating system error message*

**FILE:** *pathname*

**Meaning**

An I/O error was detected. See the appropriate operating system documentation for interpretation.

**Effect**

CREF86 processing is immediately terminated.

**User Action**

Correct the error and restart CREF86.

```
ERROR 5: IMPROPER OBJECT MODULE
 FILE: pathname
 MODULE: module name
```

**Meaning**

The specified module does not meet 8086 object module requirements.

**Cause**

This condition may be caused by the translator or by an error in data transmission.

**Effect**

CREF86 processing is immediately terminated.

**User Action**

Try retranslating the source file. If the problem persists, call Intel.

```
ERROR 6: PREMATURE EOF
 FILE: pathname
```

**Meaning**

CREF86 expects more input data, but encounters an end-of-file (EOF) condition.

**Cause**

This condition usually results from a translator error.

**Effect**

CREF86 processing is immediately terminated.

**User Action**

Return to the previous step in program development, then retranslate or relink.

```
ERROR 7: LIBRARY SEEK ERROR
 FILE: pathname
 MODULE: module name
```

**Meaning**

CREF86 did not encounter a proper library record when scanning a library file.

**Cause**

The library file or the disk may be corrupted.

**Effect**

CREF86 immediately terminates processing.

**User Action**

Reinvoke CREF86 after replacing the file or the disk.

ERROR 8: LIBRARY IN OVERLAY MODE  
FILE: *pathname*

**Meaning**

An input list contains object file(s) with an overlay record count greater than zero and a library file.

**Cause**

Libraries cannot contain overlay records. CREF86 can process either all modules or no modules with overlay records.

**Effect**

CREF86 immediately terminates processing.

**User Action**

Reinvoke CREF86 using a valid input list.

ERROR 9: IMPROPER MODULE SEQUENCE  
FILE: *pathname*  
MODULE: *module name*

**Meaning**

A combination of modules containing overlay records with those containing nonoverlay records was encountered in the input list.

**Cause**

CREF86 can process input lists consisting of either all modules with overlay records or no modules with overlay records.

**Effect**

CREF86 immediately terminates processing.

**User Action**

Reinvoke CREF86 with a valid input list.

ERROR 10: MORE THAN 255 OVERLAYS NOT SUPPORTED

**Meaning**

The input list contains over 255 files with overlay records.

**Cause**

CREF86 does not support more than 255 overlay files. In the case of input lists without overlays, however, there is no limit (except available memory) on the number of files CREF86 can process.

**Effect**

CREF86 immediately terminates processing.

**User Action**

Reinvoke CREF86 using fewer than 255 overlay files.

ERROR 11: TOO MANY OVERLAYS

FILE: *pathname*

MODULE: *module name*

**Meaning**

The input file contains more than one overlay.

**Cause**

CREF86 can support files with only one overlay record each.

**Effect**

CREF86 terminates processing immediately.

**User Action**

Reinvoke CREF86 with an input list containing files with no more than one overlay each.



ERROR 12: I/O ERROR  
*operating system error message*  
FILE: *pathname*

**Meaning**

An I/O error was detected. See the appropriate operating system documentation for interpretation.

**Effect**

CREF86 terminates processing immediately.

**User Action**

Correct the error and restart CREF86.

ERROR 13: IMPROPER PAGE WIDTH SPECIFICATION

**Meaning**

The PAGEWIDTH control specification includes a *number* outside the valid syntactic range.

**Effect**

CREF86 terminates processing immediately.

**User Action**

Correct the syntax error and reinvoke CREF86. CREF86 accepts a PAGEWIDTH *number* in decimal form from 80 to 132, inclusive, in the following format:

PAGEWIDTH(*number*)

**ERROR 14: IMPROPER PAGE LENGTH SPECIFICATION****Meaning**

The PAGELENGTH control specification includes a *number* outside the valid syntactic range.

**Effect**

CREF86 terminates processing immediately.

**User Action**

Reinvoke CREF86 using the proper PAGELENGTH syntax. CREF86 accepts a PAGELENGTH *number* in decimal form from 10 through 255, in the following format:

PAGELENGTH (*number*)

**ERROR 15: ILLEGAL LIBRARY FILE**  
**FILE: *pathname*****Meaning**

CREF86 did not encounter a proper library record in the proper location.

**Cause**

The library file or disk may be corrupted.

**Effect**

CREF86 terminates processing immediately.

**User Action**

Reinvoke CREF86 after replacing the file or the disk.

```
ERROR 16: IMPROPER OBJECT FILE
 FILE: pathname
 MODULE: module name
```

**Meaning**

CREF86 did not encounter an 8086 object module record in the proper location.

**Cause**

The object file may be corrupt or the file may not be an 8086 object file.

**Effect**

CREF86 terminates processing immediately.

**User Action**

Determine whether the integrity of the object file is intact and whether the file is a proper input file for CREF86. Reinvoke CREF86 with a valid and usable object file.

```
ERROR 17: OUTPUT FILE SAME AS INPUT FILE
 FILE: pathname
 MODULE: module name
```

**Meaning**

CREF86 detected an output pathname identical to an input pathname.

**Cause**

The invocation line specified two identical pathnames.

**Effect**

CREF86 terminates processing immediately.

**User Action**

Reinvoke CREF86 after fixing the duplicate-name situation.

**ERROR 18: CREF86 INTERNAL ERROR**  
FILE: *pathname*  
MODULE: *module name*

#### **User Action**

Contact Intel immediately. Forward a copy of the object file, the CREF86 invocation line, and your version of CREF86.

**WARNING 19: TYPE MISMATCH**  
FILE: *pathname*  
MODULE: *module name*  
SYMBOL: *symbol name*

#### **Meaning**

CREF86 detected a type mismatch between two symbols with the same name.

#### **Cause**

Two symbols are declared to have identical names but different types, and the symbols are not in different overlay modules.

CREF86 does not check the entire TYPE declaration for any given symbol. For example, dimension values for arrays, number of parameters in procedure calls, etc. are not compared. Only simple types (e.g., byte, word, structure) are checked.

#### **Effect**

CREF86 flags the condition in the cross-reference listing.

#### **User Action**

Ensure that the condition is not damaging to your programming objectives.

```
WARNING 20: SPECIFIED MODULE NOT FOUND
FILE: pathname
MODULE: module name
```

**Meaning**

A module explicitly included in the input list of the invocation is not found by CREF86.

**Cause**

The specified module is not part of the file specified by the pathname.

**Effect**

CREF86 continues processing the modules it is able to find.

**User Action**

Determine why the module is missing, then reinvoke CREF86.

```
ERROR 21: OPERATING SYSTEM INTERFACE ERROR
operating system error message
```

**Meaning**

CREF86 cannot open its temporary file.

**Effect**

CREF86 terminates processing immediately.

**User Action**

Refer to the documentation on the operating system to help diagnose any possible operating system malfunction.



# APPENDIX F LIB86 COMMANDS AND ERROR MESSAGES

The table below shows all of LIB86's commands.

Table F-1. Summary of LIB86 Commands

| Command                                                                                         | Abbrev.  | Description                                                                 |
|-------------------------------------------------------------------------------------------------|----------|-----------------------------------------------------------------------------|
| ADD { <i>pathname</i> {( <i>module name</i> [...])}<br>[,...] TO <i>pathname</i>                | A        | Adds modules to a library                                                   |
| CREATE <i>pathname</i>                                                                          | C        | Creates a library file                                                      |
| DELETE <i>pathname</i> { <i>module name</i> [...]}                                              | D        | Deletes modules from a library file                                         |
| EXIT                                                                                            | E        | Terminates session with LIB86                                               |
| LIST { <i>pathname</i> {( <i>module name</i> [...])}<br>[,...] [TO <i>pathname</i> ] [PUBLICS]} | L<br>[P] | Lists modules contained in a library file, and optionally lists all publics |

The following are descriptions of all LIB86 error and warning messages. The description of each message has up to four parts:

- Meaning—how to interpret the message
- Cause—the usual reason for the error or warning condition
- Effect—the state of LIB86 and the object file(s) after the message is issued
- User Action—what you can do to correct the condition

Not all these parts are given for each message. However, parts excluded are self-explanatory.

Error and warning messages are displayed at the console device.

```
MODULE NOT FOUND
MODULE: module name
FILE: pathname
```

### Meaning

The specified module could not be found in the specified library.

### Cause

There is a typographical error in the command line.

### Effect

LIB86 ignores the module in the list and continues processing.

### User Action

No user action is necessary.

RIGHT PARENTHESIS EXPECTED  
*partial command tail*

LEFT PARENTHESIS EXPECTED  
*partial command tail*

INVALID MODULE NAME  
*partial command tail*

MODULE NAME TOO LONG  
*partial command tail*

INVALID SYNTAX  
*partial command tail*

'TO' EXPECTED  
*partial command tail*

### **Meaning**

All of the above errors are syntax errors. For each of the above errors LIB86 issues the associated error message and displays the partial command up to the point of the error.

### **Cause**

There is a typographical error in the command line.

### **Effect**

LIB86 immediately terminates processing the command, displays the error message, and issues the prompt character (\*).

### **User Action**

Examine the command line, make the necessary corrections and reissue the command.

**UNRECOGNIZED COMMAND****Cause**

You mistyped a command (ADD, CREATE, DELETE, EXIT, or LIST).

**Effect**

LIB86 immediately terminates processing the command, displays the error message, and issues the prompt character (\*).

**User Action**

Examine the command line and enter the corrected command.

**INSUFFICIENT MEMORY****Meaning**

There is not enough memory available to execute the command.

**Cause**

Exceptionally long and complex commands can cause this error.

**Effect**

LIB86 immediately terminates processing the command, displays the error message, and issues the prompt character (\*).

**User Action**

Simplify your command line and reexecute.

**COMMAND LINE TOO LONG**

*partial command tail*

**Meaning**

The length of the LIB86 command you tried to execute exceeded the size limit of the system's command buffer.

**Effect**

LIB86 immediately terminates processing the command, displays this error message plus the portion of the command it would accept, then issues the prompt character (\*).

**User Action**

Simplify your command line and reexecute.



**LIB86 ERROR****Meaning**

LIB86 failed an internal consistency check.

**Effect**

LIB86 immediately terminates processing. The results of previous commands on the library being manipulated when this error occurred may have been lost.

**User Action**

Contact Intel. Forward a copy of the libraries and object files used during the session in which the error occurred.

**FILE ALREADY EXISTS**

FILE: *pathname*

**Meaning**

The file specified in the CREATE command already exists.

**Effect**

LIB86 immediately terminates processing the command, displays the error message, and issues the prompt character (\*).

**User Action**

Specify a nonexistent file in the CREATE command.

**DUPLICATE SYMBOL IN INPUT**

SYMBOL: *symbol name*

MODULE: *module name*

FILE: *pathname*

**Meaning**

The specified public symbol conflicts with a public symbol defined in one of the files given earlier in the input list. This error occurs only during the ADD command.

**Effect**

LIB86 immediately terminates processing the command, displays the error message, and issues the prompt character (\*). The library being manipulated returns to the state it was in prior to the ADD command that prompted this message.

**User Action**

Correct the ADD command and reinvoke LIB86.

NOT A LIBRARY  
FILE: *pathname*

**Cause**

The file that the command requests LIB86 to DELETE or LIST is not a library file.

**Effect**

LIB86 immediately terminates processing the command, displays the error message, and issues the prompt character (\*).

**User Action**

Reissue the command specifying a library file.

ILLEGAL RECORD FORMAT  
MODULE: *module name*  
FILE: *pathname*

**Cause**

This error is usually caused by a transcription error or translation error in some part of an object file examined by LIB86.

**Effect**

LIB86 immediately terminates processing the command, displays the error message, and issues the prompt character (\*).

**User Action**

Return to the last step in program development, then retranslate, relink, or relocate.

PREMATURE EOF  
MODULE: *module name*  
FILE: *pathname*

**Meaning**

Due to some transcription error or other the specified file has no module end record.

**Cause**

This is usually the result of a transcription error or translator error.

**Effect**

LIB86 immediately terminates processing the command, displays the error message, and issues the prompt character (\*).

**User Action**

Return to the last step in program development, then retranslate, relink, or relocate.

```
CHECKSUM ERROR
MODULE: module name
FILE: pathname
```

**Meaning**

The specified file has an error in one of its checksum fields.

**Cause**

This is the result of a transcription error.

**Effect**

LIB86 immediately terminates processing the command, displays the error message, and issues the prompt character (\*).

**User Action**

Return to the last step in program development, then retranslate, relink, or relocate.

```
ATTEMPT TO ADD DUPLICATE MODULE
MODULE: module name
```

**Meaning**

A module with the specified module name already exists in the library.

**Effect**

LIB86 immediately terminates processing the command, displays the error message, and issues the prompt character (\*).

**User Action**

Remove the duplicate module from the list and reissue the command.

```
ATTEMPT TO ADD MODULE CONTAINING OVERLAYS
MODULE: module name
FILE: pathname
```

**Effect**

LIB86 immediately terminates processing the command, displays the error message, and issues the prompt character (\*). All modules in the input list up to the erroneous file are added to library.

**User Action**

Reissue the command with all elements in the input list except those that contain overlays.

```
PUBLIC SYMBOL ALREADY IN LIBRARY
SYMBOL: symbol name
MODULE: input module name
FILE: input pathname
```

**Meaning**

The library already contains the public symbol identified in the error message.

**Cause**

This error occurs when a module is added that has a symbol definition already in the library.

**Effect**

LIB86 immediately terminates processing the command, displays the error message, and issues the prompt character (\*).

**User Action**

Reexecute the command without the file that contains the duplicate symbol.





# APPENDIX G LOC86 CONTROLS AND ERROR MESSAGES

Table G-1 lists all of LOC86's control syntax, abbreviations, and default settings.

**Table G-1. Summary of LOC86 Controls**

| Control                                                                                                                                         | Abbrev.                 | Default                        |
|-------------------------------------------------------------------------------------------------------------------------------------------------|-------------------------|--------------------------------|
| ADDRESSES(<br>{SEGMENTS({segment[\class\overlay]]<br>(addr)}[...])  <br>CLASSES({class(addr)}[...])  <br>GROUPS({group(addr)}[...]) }<br>[...]) | AD<br>(SM  <br>CS   GR) | Not applicable                 |
| BOOTSTRAP                                                                                                                                       | BS                      | Not applicable                 |
| COMMENTS                                                                                                                                        | CM                      | COMMENTS                       |
| NOCOMMENTS                                                                                                                                      | NOCM                    |                                |
| INITCODE([address])                                                                                                                             | IC                      | INITCODE(200H)                 |
| NOINITCODE                                                                                                                                      | NOIC                    |                                |
| LINES                                                                                                                                           | LI                      | LINES                          |
| NOLINES                                                                                                                                         | NOLI                    |                                |
| MAP                                                                                                                                             | MA                      | MAP                            |
| NOMAP                                                                                                                                           | NOMA                    |                                |
| NAME( <i>module name</i> )                                                                                                                      | NA                      | Not applicable                 |
| OBJECTCONTROLS(<br>{LINES   NOLINES  <br>COMMENTS   NOCOMMENTS  <br>SYMBOLS   NOSYMBOLS  <br>PUBLICS   NOPUBLICS  <br>PURGE   NOPURGE } [...])  | OC                      | Not applicable                 |
| ORDER(<br>{SEGMENTS({segment[\class\overlay]] }<br>[...])  <br>CLASSES({class[segment [...]] } [...]) }<br>[...])                               | OD<br>(SM  <br>CS)      | Not applicable                 |
| PRINT([ <i>pathname</i> ])                                                                                                                      | PR                      | PRINT( <i>objectfile.MP2</i> ) |
| NOPRINT                                                                                                                                         | NOPR                    |                                |
| PRINTCONTROLS(<br>{LINES   NOLINES  <br>COMMENTS   NOCOMMENTS  <br>SYMBOLS   NOSYMBOLS  <br>PUBLICS   NOPUBLICS  <br>PURGE   NOPURGE } [...])   | PC                      | Not applicable                 |
| PUBLICS                                                                                                                                         | PL                      | PUBLICS                        |
| NOPUBLICS                                                                                                                                       | NOPL                    |                                |
| PURGE                                                                                                                                           | PU                      | NOPURGE                        |
| NOPURGE                                                                                                                                         | NOPU                    |                                |

**Table G-1. Summary of LOC86 Controls (Cont'd.)**

| Control                                                                | Abbrev. | Default           |
|------------------------------------------------------------------------|---------|-------------------|
| RESERVE({ <i>addr</i> TO <i>addr</i> } {,...})                         | RS      | Not applicable    |
| SEGSIZE({ <i>segment</i> [\class[\overlay]]<br>( <i>size</i> )}{,...}) | SS      | Not applicable    |
| START({ <i>symbol</i>   <i>paragraph,offset</i> })                     | ST      | Not applicable    |
| SYMBOLS                                                                | SB      | SYMBOLS           |
| NOSYMBOLS                                                              | NOSB    |                   |
| SYMBOLCOLUMNS(<1   2   3   4>)                                         | SC      | SYMBOLCOLUMNS (2) |

The following are descriptions of all LOC86 error and warning messages. The description of each message has up to four parts:

- Meaning—how to interpret the message
- Cause—the usual reason for the error or warning condition
- Effect—the state of LOC86 and the object file(s) after the message is issued
- User Action—what you can do to correct the condition

Not all these parts are given for each message. However, parts excluded are self-explanatory.

Error messages are always fatal, but warning messages are not. In the event of a warning, read the EFFECT of the warning carefully to determine whether the code is valid.

Error and warning messages are displayed at the console device, but printed only if a listing would otherwise be printed.

**ERROR 1: I/O ERROR:**  
*operating system error message*

**Meaning**

An I/O error was detected. Refer to the documentation for your operating system for interpretation.

**Effect**

LOC86 immediately terminates processing; all open files are closed. The contents of the print and object files are undefined.

**User Action**

Correct the error and restart LOC86.

```
ERROR 2: INVALID SYNTAX
 ERROR IN COMMAND TAIL NEAR #:
 partial command tail
```

**Meaning**

A syntax error was detected in the invocation line. LOC86 repeats the invocation line up to the point of the error.

**Cause**

This is usually the result of a typographical error in the invocation line.

**Effect**

LOC86 immediately terminates processing; all open files are closed. The contents of the print and object files are undefined.

**User Action**

Reenter the invocation line more carefully.

```
ERROR 3: MISSING INPUT FILE NAME
 ERROR IN COMMAND TAIL NEAR #:
 partial command tail
```

**Meaning**

LOC86 was unable to find the input file name in the invocation. LOC86 repeats the invocation line up to the point of the error.

**Cause**

This is usually the result of a typographical error in the invocation line.

**Effect**

LOC86 immediately terminates processing; all open files are closed. The contents of the print and object files are undefined.

**User Action**

Reinvoke LOC86 more carefully.



**ERROR 4: INSUFFICIENT MEMORY****Meaning**

The memory available on your system has been used up by LOC86.

**Cause**

This can be caused by an input module that has a very large number of segments or an impossibly long invocation line.

**Effect**

LOC86 immediately terminates processing; all open files are closed. The contents of the print and object files are undefined.

**User Action**

This may require changing the source file to reduce the number of segments and retranslating.

**ERROR 5: BAD RECORD FORMAT**

MODULE: *module name*

**Meaning**

There is a record in the specified input module that has an incorrect format.

**Cause**

This is usually a transcription error.

**Effect**

LOC86 immediately terminates processing; all open files are closed. The contents of the print and object files are undefined.

**User Action**

Retranslate and relink the input files before attempting to locate the input module again.

```
ERROR 6: INVALID KEY WORD
 ERROR IN COMMAND TAIL NEAR #:
 partial command tail
```

**Meaning**

One of the controls or subcontrols in the invocation line is incorrect. LOC86 repeats the invocation line up to the point of the error.

**Cause**

This is usually the result of a typographical error in the invocation line.

**Effect**

LOC86 immediately terminates processing; all open files are closed. The contents of the print and object files are undefined.

**User Action**

Reinvoke LOC86 more correctly.

```
ERROR 7: NUMERIC CONSTANT LARGER THAN 20 BITS
 ERROR IN COMMAND TAIL NEAR #:
 partial command tail
```

**Meaning**

You have specified an address greater than 1,048,575 (0FFFFFFH). LOC86 repeats the invocation line up to the point of the error.

**Effect**

LOC86 immediately terminates processing; all open files are closed. The contents of the print and object files are undefined.

**User Action**

Examine the invocation line and invoke LOC86 with the correct address.

```
ERROR 8: NON NUMERIC CHARACTER IN NUMERIC CONSTANT
 ERROR IN COMMAND TAIL NEAR #:
 partial command tail
```

**Meaning**

This is a type of syntax error. LOC86 repeats the invocation line up to the point of the error.

**Cause**

This is usually caused by a typographical error in the invocation line.

**Effect**

LOC86 immediately terminates processing; all open files are closed. The contents of the print and object files are undefined.

**User Action**

Enter the invocation more carefully.

```
ERROR 9: NUMERIC CONSTANT LARGER THAN 16 BITS
ERROR IN COMMAND TAIL NEAR #:
partial command tail
```

**Meaning**

You have specified an offset greater than 65,536 (0FFFFH). LOC86 repeats the invocation line up to the point of the error.

**Effect**

LOC86 immediately terminates processing; all open files are closed. The contents of the print and object files are undefined.

**User Action**

Retype the invocation line more carefully.

```
ERROR 10: INVALID SEGMENT NAME
ERROR IN COMMAND TAIL NEAR #:
partial command tail
```

**Meaning**

LOC86 was expecting a segment name when it found a token that does not correspond to a valid segment name. LOC86 repeats the invocation line up to the point of the error.

**Cause**

This is usually the result of a typographical error.

**Effect**

LOC86 immediately terminates processing; all open files are closed. The contents of the print and object files are undefined.

**User Action**

Reinvoke LOC86 more carefully.

```
ERROR 11: INVALID CLASS NAME
 ERROR IN COMMAND TAIL NEAR #:
 partial command tail
```

**Meaning**

LOC86 was expecting a class name when it found a token that does not correspond to a valid class name. LOC86 repeats the invocation line up to the point of the error.

**Cause**

This is usually the result of a typographical error.

**Effect**

LOC86 immediately terminates processing; all open files are closed. The contents of the print and object files are undefined.

**User Action**

Reinvoke LOC86 more carefully.

```
ERROR 12: INVALID INPUT MODULE
 MODULE: module name
```

**Meaning**

The input module is invalid. It could mean that object module records are out of order, or LOC86 has found an invalid field within a record, or a required record is missing.

**Cause**

This is usually caused by a translator error or an attempt to locate something other than an object file (e.g., a source file).

**Effect**

LOC86 immediately terminates processing; all open files are closed. The contents of the print and object files are undefined.

**User Action**

Retranslate source and relink, then try to locate again. If this error continues contact Intel.

WARNING 13: MORE THAN ONE SEGMENT WITH THE MEMORY  
ATTRIBUTE  
SEGMENT: *segment name*

### Meaning

After the first memory segment is found, LOC86 issues this warning each time it finds a segment with the memory attribute.

### Effect

LOC86 ignores the memory attribute on the segment specified in the message. Processing continues with LOC86 treating the additional memory segment as just another segment.

### User Action

Depending on your intentions, this message may be ignored or you may wish to change the attribute for the segments and relink them.

WARNING 14: GROUP DEFINED BY AN EXTERNAL REFERENCE  
NAME: *external name*  
GROUP: *group name*

### Meaning

The specified group is defined by an external reference. This is a type of unresolved external reference.

### Effect

LOC86 continues processing without side effects.

### User Action

Find the module that defines the specified symbol and relink the input module.

WARNING 15: PUBLIC SYMBOL NOT ADDRESSABLE  
NAME: *public symbol name*

### Meaning

The specified symbol is more than 64K from its base. This error occurs when the segment containing the public symbol is not completely contained within the 64K physical segment defined by the symbol's base.

### Effect

LOC86 continues processing. The object file will be executable. However, any attempt to access the specified public symbol will not produce the desired results. Debug symbols with this attribute will not be added to the object file.

### User Action

Change the ORDER or ADDRESSES control so that the segment containing the public symbol will be within range of the symbol's base.

**WARNING 16: LOCAL SYMBOL NOT ADDRESSABLE**  
NAME: *local symbol name*

### Meaning

The specified symbol is more than 64K from its base. This error occurs when the segment containing the local symbol is not completely contained within the 64K physical segment defined by the symbol's base.

### Effect

LOC86 continues processing. The object file will be executable. However, any attempt to access the specified symbol will not produce the desired results. Debug symbols with this attribute will not be added to the object file.

### User Action

Change the ORDER or ADDRESSES control so that the segment containing the local symbol will be within range of the symbol's base.

**WARNING 17: LINE NUMBER NOT ADDRESSABLE**  
NAME: *line number*

### Meaning

The specified line is more than 64K from its base. This error occurs when the segment containing the line number is not completely contained within the 64K physical segment defined by the line's base.

### Effect

LOC86 continues processing. The object file will be executable. However, any attempt to access the specified line number will not produce the desired results. Debug symbols with this attribute will not be added to the object file.

### User Action

Change the ORDER or ADDRESSES control so that the segment containing the line number will be within range of the line's base.

```
WARNING 18: SIZE OF GROUP EXCEEDS 64K
 GROUP: group name
```

**Meaning**

Some of the segments of the specified group are not contained within the physical segment defined by the group's base.

**Cause**

This error is usually caused by misuse of the ORDER or ADDRESSES control.

**Effect**

LOC86 continues processing the input module. The output module will be executable, but addressing errors may result.

**User Action**

Examine the invocation line and reinvoke LOC86 using the ORDER or ADDRESSES control more carefully.

```
WARNING 19: BOOTSTRAP SPECIFIED FOR MODULE WITHOUT START
 ADDRESS
```

**Meaning**

You have specified BOOTSTRAP when locating a module that has no start address.

**Effect**

LOC86 continues processing as if no BOOTSTRAP control was specified.

**User Action**

If you wish initialization code in the program, relocate the input module specifying both BOOTSTRAP and START.

```
ERROR 20: INVALID NAME
 NAME: bad name
```

**Cause**

This is the result of a typographical error in the NAME control. A valid name is composed of up to forty of the following characters in any order:

- Alphabetic (A, B, C, ..., Z)
- Numeric (0, 1, 2, ..., 9)
- Special (@, ?, :, ., \_, —)

**Effect**

LOC86 immediately terminates processing; all open files are closed. The contents of the print and object files are undefined.

**User Action**

Reinvoke LOC86 more carefully.

```
ERROR 21: SEGMENT REGISTER DEFINED BY SPECIFIED EXTERNAL
 NAME
 NAME: external name
```

**Meaning**

A segment register or register pair is defined using the specified external symbol name.

**Effect**

LOC86 immediately terminates processing; all open files are closed. The contents of the print and object files are undefined.

**User Action**

Relink and relocate your object modules.

```
ERROR 22: SEGMENT SIZE OVERFLOW; OLD SIZE + CHANGE > 64K
 SEGMENT: segment name
 CLASS: class name
```

**Meaning**

The size change specified in the SEGSIZE control caused the segment to become greater than 64K.

**Effect**

LOC86 immediately terminates processing; all open files are closed. The contents of the print and object files are undefined.

**User Action**

Look at the segment's size in the link map and reinvoke LOC86 with the correct SEGSIZE control.

```
ERROR 23: SEGMENT SIZE UNDERFLOW; OLD SIZE - CHANGE < 0
 SEGMENT: segment name
 CLASS: class name
```

**Meaning**

The size change specified in the SEGSIZE control caused the segment's size to be less than zero.

**Effect**

LOC86 immediately terminates processing; all open files are closed. The contents of the print and object files are undefined.

**User Action**

Look at the segment's size in the link map and reinvoke LOC86 with the correct SEGSIZE control.



**ERROR 24: INVALID ADDRESS RANGE****Meaning**

The arguments to the RESERVE control are invalid.

**Cause**

The usual cause of this error is that the low address is larger than the high address.

**Effect**

LOC86 immediately terminates processing; all open files are closed. The contents of the print and object files are undefined.

**User Action**

Examine the invocation line and reinvoke LOC86 correctly.

**ERROR 25: PUBLIC SYMBOL NOT FOUND**  
**NAME:** *public symbol name***Meaning**

The symbol specified in the START control was not found.

**Effect**

LOC86 immediately terminates processing; all open files are closed. The contents of the print and object files are undefined.

**User Action**

Either specify the argument to START with paragraph and offset, or specify an existing public symbol.

**WARNING 26: DECREASING SIZE OF SEGMENT**  
**SEGMENT:** *segment name***Meaning**

The size change specified in SEGSIZE has caused LOC86 to decrease the size of the specified segment.

**Effect**

Decreasing the size of a segment can cause sections of code to be unaccounted for during the locating process. This is only a warning message. LOC86 continues processing with no side effects.

**User Action**

If the size decrease was not intended, examine the SEGSIZE control in the invocation line and relocate.

ERROR 27: SPECIFIED SEGMENT IS ABSOLUTE  
SEGMENT: *segment name*

**Meaning**

You attempted to assign an address to an absolute segment.

**Effect**

LOC86 immediately terminates processing; all open files are closed. The contents of the print and object files are undefined.

**User Action**

Reinvoke LOC86 without using absolute segments in the ADDRESSES control.

WARNING 28: PAGE RESIDENT SEGMENT CROSSES PAGE BOUNDARY  
SEGMENT: *segment name*

**Cause**

If you have changed the specified segment's size, it may be too large to fit within a 256 byte page, or if you have specified an address for the segment, it may force the segment to cross a page boundary.

**Effect**

Since this error can only occur when you have intentionally specified the segment in a control, LOC86 ignores the page resident attribute and continues to process the module as if no error has occurred.

**User Action**

If you have invoked LOC86 correctly, then the message is only verifying your intentions — no action is necessary.

```
WARNING 29: OFFSET FIXUP OVERFLOW
MODULE: module name
REFERENCED LOCATION: 20-bit address
FRAME OF REFERENCE: 20-bit address
```

### Meaning

While computing an offset from a base (FRAME OF REFERENCE), LOC86 found that the REFERENCED LOCATION was more than 64K bytes away from the base.

### Cause

This error usually occurs as a result of misuse of the ORDER or ADDRESSES control. One of the segments of a group is outside the 64K byte physical segment defined by its group base.

### Effect

LOC86 continues processing. The print file will be valid, but the output file with regard to the out-of-place segment will not be usable.

### User Action

Find the symbol that corresponds to the referenced location, and change the ORDER or ADDRESSES control.

```
WARNING 30: UNRESOLVED EXTERNAL REFERENCE TO NAME
 AT SPECIFIED ADDRESS
NAME: symbol name
SEGMENT: segment name
ADDRESS: 20-bit address
```

### Meaning

There is no public definition for the specified public symbol. There is an unresolved external reference to that symbol in the specified segment.

### Cause

You are locating a module that is not completely linked.

### Effect

LOC86 continues processing with no side effects. The print file will be valid, and except for the unresolved references the object file should be executable.

### User Action

No action is necessary if the unresolved reference is known. Otherwise, you must relink and resolve the external reference.

WARNING 31: UNRESOLVED EXTERNAL REFERENCE TO NAME NEAR  
SPECIFIED ADDRESS

NAME: *symbol name*  
SEGMENT: *segment name*  
ADDRESS: *20-bit address*

### Meaning

There is no public definition for the specified public symbol. There is an unresolved external reference to that symbol in the specified segment.

### Cause

You are locating a module that has not been completely linked.

### Effect

LOC86 continues processing with no side effects. The print file will be valid, and except for the unresolved references the object file should be executable.

### User Action

No action is necessary if the unresolved reference is known. Otherwise, you must relink to resolve the external reference.

WARNING 32: OVERFLOW OF LOW BYTE FIXUP VALUE

MODULE: *module name*  
REFERENCED LOCATION: *20-bit address*  
FRAME OF REFERENCE: *20-bit address*

### Meaning

An 8-bit displacement value, when calculated, exceeded 255.

### Cause

This type of error often occurs when a page resident segment crosses a page boundary.

### Effect

LOC86 continues processing. The contents of both the print file and the object file will be valid. However, the fixup value will remain invalid.

### User Action

Find the symbol that corresponds to the REFERENCED LOCATION and organize your segments so that the addressing error will not be encountered.

WARNING 33: GROUP HAS NO CONSTITUENT SEGMENTS  
GROUP: *group name*

**Meaning**

The group has no segments and is not placed in the output object file.

**Cause**

Often this is the result of a typographical error in the invocation line. However, it may be a linking error that has not shown up until now.

**Effect**

LOC86 continues processing with no side effects.

**User Action**

Unless there is some particular need for the specified group, no user action is necessary.

ERROR 34: SPECIFIED CLASS NOT FOUND IN INPUT MODULE  
CLASS: *class name*

**Effect**

LOC86 immediately terminates processing; all open files are closed. The contents of the print and object files are undefined.

**User Action**

Find the module that contains the specified class and link it into the module to be located.

ERROR 35: SPECIFIED SEGMENT NOT FOUND IN INPUT MODULE  
SEGMENT: *segment name*  
CLASS: *class name*

**Effect**

LOC86 immediately terminates processing; all open files are closed. The contents of the print and object files are undefined.

**User Action**

Find the module that contains the specified segment and link it into the module to be located.

```
WARNING 36: SEGMENTS OVERLAP
 SEGMENT: segment name
 SEGMENT: segment name
 LOW OVERLAP ADDRESS: 20-bit address
 HIGH OVERLAP ADDRESS: 20-bit address
```

**Meaning**

The two segments overlap in the specified address range.

**Cause**

This can be caused by any number of things: mistake in the SEGSIZE control, misuse of ADDRESSES, or two absolute segments that overlap.

**Effect**

LOC86 continues processing the input module. The print file is valid, and the object file, with the exception of the overlap, should be usable.

**User Action**

If overlap was intended, no action is necessary. Otherwise, depending on the cause of the message, it may be necessary to relocate or even modify the source, and retranslate, relink, and relocate.

```
ERROR 37: INPUT MODULE EXCEEDS 8086 MEMORY
 SEGMENT: segment name
```

**Meaning**

While attempting to locate the specified segment, LOC86 ran out of available 8086 address space.

**Cause**

Although it is possible to write a program that uses a full megabyte of memory, this error usually results from an error in the arguments to the RESERVE control.

**Effect**

LOC86 immediately terminates processing; all open files are closed. The contents of the print and object files are undefined.

**User Action**

Examine the RESERVE control. If, in fact, your program requires more than 1,048,576 bytes of memory, try optimizing with ASM86 or use overlays.

WARNING 38: SEGMENT WITH MEMORY ATTRIBUTE NOT PLACED  
HIGHEST IN MEMORY  
SEGMENT: *segment name*

**Meaning**

The specified memory segment was not located at the highest address in memory.

**Cause**

This can only occur when you explicitly request this organization through the ORDER or ADDRESSES control, or when you implicitly request it by assigning another segment to the top of memory.

**Effect**

Since this can only occur by user request, LOC86 continues processing without side effects.

ERROR 39: NO MEMORY BELOW SEGMENT FOR SPECIFIED SEGMENT  
SEGMENT: *segment name*  
SEGMENT: *segment name*

**Meaning**

In the ORDER control you have requested that the first segment be located below the second segment. LOC86 found that there is not enough memory to maintain this order.

**Cause**

This error can only occur when one of the segments in an ORDER control is absolute. The absolute segment is not necessarily either of the segments specified in the command.

**Effect**

LOC86 immediately terminates processing; all open files are closed. The contents of the print and object files are undefined.

**User Action**

Modify the order control.

WARNING 40: CANNOT MAINTAIN SPECIFIED ORDERING  
SEGMENT: *segment name*

### Meaning

LOC86 cannot locate all of the segments in the ORDER control consecutively.

### Cause

This is usually caused by specifying absolute segments in the ORDER control or by specifying the same segments in ORDER and ADDRESSES. The conflict might not be immediately obvious. For example, the specified segment may be specified in the ORDER control by its segment name and specified in the ADDRESSES control by its class name.

### Effect

LOC86 continues processing. The print and object files are valid. However, the requested segment ordering is not maintained.

### User Action

Carefully examine your invocation line to find the conflict and relocate the input module.

ERROR 41: SPECIFIED CLASS OUT OF ORDER  
CLASS: *class name*

### Meaning

The ORDER control and ADDRESSES control for the specified class disagree.

### Cause

Either you have assigned an address to the specified class or one of its constituent segments, or the translator has made one of its constituent segments absolute. In either case, the ORDER control cannot be realized.

### Effect

LOC86 immediately terminates processing; all open files are closed. The contents of the print and object files are undefined.

### User Action

Modify the ADDRESSES control or modify the ORDER control.



ERROR 42: SPECIFIED SEGMENT OUT OF ORDER  
SEGMENT: *segment name*

### Meaning

The ORDER control and ADDRESSES control for the specified segment disagree.

### Cause

Either you have assigned an address to the specified segment or the translator has made the segment absolute. In either case, the ORDER control cannot be realized.

### Effect

LOC86 immediately terminates processing; all open files are closed. The contents of the print and object files are undefined.

### User Action

Modify the ADDRESSES control or modify the ORDER control.

ERROR 43: ADDRESS FOR CLASS SPECIFIED MORE THAN ONCE  
CLASS: *class name*

### Cause

This is often caused by a typographical error or some other mechanical error while entering the invocation line.

### Effect

LOC86 immediately terminates processing; all open files are closed. The contents of the print and object files are undefined.

### User Action

Examine the invocation line and reinvoke LOC86 correctly.

ERROR 44: SEGMENT ADDRESS PREVIOUSLY SPECIFIED IN INPUT  
MODULE OR COMMAND LINE  
SEGMENT: *segment name*  
CLASS: *class name*

### Cause

Either the specified segment is absolute or it has been listed twice in the same ADDRESSES control.

### Effect

LOC86 immediately terminates processing; all open files are closed. The contents of the print and object files are undefined.

### User Action

Examine the invocation line. If the translator has made it an absolute segment, either use the translator-assigned address or retranslate the segment.

```
ERROR 45: SEGMENT SPECIFIED MORE THAN ONCE IN ORDER
 SEGMENT: segment name
 CLASS: class name
```

**Cause**

This error can be caused by either of two errors in the invocation line. You have simply specified the same segment twice in the ORDER control.

**Effect**

LOC86 immediately terminates processing; all open files are closed. The contents of the print and object files are undefined.

**User Action**

Examine the invocation line and ORDER control and reinvoke LOC86.

```
ERROR 46: CLASS SPECIFIED MORE THAN ONCE IN ORDER
 CLASS: class name
```

**Cause**

You have specified the same class more than once in the same ORDER control.

**Effect**

LOC86 immediately terminates processing; all open files are closed. The contents of the print and object files are undefined.

**User Action**

Examine the invocation line and reinvoke LOC86 correctly.

```
ERROR 47: SPECIFIED SEGMENT NOT IN SPECIFIED CLASS
 SEGMENT: segment name
 CLASS: class name
```

**Cause**

This error is usually caused by a typographical error in the arguments to an ORDER control.

**Effect**

LOC86 immediately terminates processing; all open files are closed. The contents of the print and object files are undefined.

**User Action**

Examine the invocation line and reinvoke LOC86 correctly.

**ERROR 48: INVALID COMMAND LINE****Meaning**

LOC86 has encountered an end-of-file or an I/O error while reading the invocation line.

**Cause**

You probably terminated the invocation line in the middle of a control argument. Most likely you forgot to type the ampersand before you typed the carriage return.

**Effect**

LOC86 immediately terminates processing; all open files are closed. The contents of the print and object files are undefined.

**User Action**

Examine the invocation line and reinvoke LOC86 correctly.

**WARNING 49: SEGMENT ALIGNMENT NOT COMPATIBLE WITH  
ASSIGNED ADDRESS**  
**SEGMENT: *segment name*****Meaning**

The alignment attribute does not agree with the address specified in the ADDRESSES control.

**Effect**

LOC86 ignores the address assignment and treats the segment as any other relocatable segment.

**User Action**

If the address that LOC86 assigns is satisfactory, then no action is necessary. Otherwise, examine the print file and assign an address that will agree with the alignment attribute.

```
ERROR 50: INVALID COMMAND LINE; TOKEN TOO LONG
 ERROR IN COMMAND LINE NEAR #:
 partial command tail
```

**Meaning**

An invocation line “token” is impossibly long. A token is a series of characters that are not broken by a parenthesis, a comma or a blank (space, carriage-return, line-feed or tab). Tokens are syntactic units used in invocation line parsing. Depending on how it is used, a token can be a control word, a symbol name, a segment name, a filename, etc.

**Cause**

This is often the result of a typographical error in the invocation line.

**Effect**

LOC86 immediately terminates processing; all open files are closed. The contents of the print and object files are undefined.

**User Action**

Examine the invocation line and reinvoke LOC86 correctly.

```
WARNING 51: REFERENCING LOCATION IS OUTSIDE 64K FRAME OF
 REFERENCE
 MODULE: module name
 ADDRESS: 20-bit address
 FRAME OF REFERENCE: 20-bit address
```

**Meaning**

The address of a self-relative reference lies outside of the 64K frame of reference of the jump or call. This error occurs while locating the module containing the self-relative instruction.

**Cause**

This error occurs as a result of misuse of the ORDER or ADDRESSES control.

**Effect**

LOC86 continues processing. The print file is valid, but the object file with respect to the module containing the self-relative reference is not executable.

**User Action**

Examine the locate map and reinvoke LOC86 modifying your ORDER and ADDRESSES control to correct the error.

```
WARNING 52: REFERENCED LOCATION OUTSIDE 64K FRAME OF
 REFERENCE
MODULE: module name
REFERENCED LOCATION: 20-bit address
FRAME OF REFERENCE: 20-bit address
```

### Meaning

The target of a self-relative reference lies outside of the 64K frame of reference of the jump or call. This error occurs while locating the module containing the target of a self-relative instruction.

### Cause

This error occurs as a result of misuse of the ORDER or ADDRESSES control.

### Effect

LOC86 continues processing. The print file is valid, but the object file with respect to the module containing the self-relative reference is not executable.

### User Action

Examine the locate map and reinvoke LOC86 modifying your ORDER and ADDRESSES control to correct the error.

```
WARNING 53: CANNOT ALLOCATE CLASS AT SPECIFIED ADDRESS
ADDRESS: 20-bit address
CLASS: class name
```

### Meaning

The specified class cannot be located at the address requested. This is the result of a conflict with another address assignment, or an absolute segment, or an address less than 200H.

### Effect

LOC86 assigns the class to the nearest address that will not cause conflict. LOC86 continues processing, and both the print and object file are valid.

### User Action

If the alternate address suits your purpose, then no action is necessary. Otherwise, examine the locate map and modify your invocation line.

```
ERROR 54: DATA ADDRESS OUTSIDE SEGMENT BOUNDARIES
 SEGMENT: segment name
 MODULE: module name
```

### Meaning

One of the data records associated with the specified segment contains an address outside of the segment's boundary.

### Cause

This error can occur when you assign an address or an order to an absolute segment, or a size to a segment. Under some circumstances this can be the result of a linkage or translation error.

### Effect

LOC86 immediately terminates processing; all open files are closed. The contents of the print and object files are undefined.

### User Action

Change the ADDRESSES, ORDER, or SEGSIZE control and relocate.

```
WARNING 55: UNDEFINABLE SYMBOL ADDRESS
 SEGMENT: segment name
 MODULE: module name
```

### Meaning

A local symbol, line number, or public symbol has been found in the specified segment that is addressed relative to the specified group's base address. However, the segment containing the symbol is not within the 64K frame of reference that is defined for that group.

### Cause

This is usually the result of an address assignment error in the invocation line.

### Effect

LOC86 continues processing with no other side effects. The print file and object files are valid. However, you cannot use the symbols contained in the specified segment.

### User Action

Examine the invocation line and reinvoke LOC86.

WARNING 56: SEGMENT IN RESERVE SPACE  
SEGMENT: *segment name*

### Cause

Either an absolute segment uses the area reserved in the invocation line or you assigned an address to a segment or class that forces the specified segment to be located in the reserved area.

### Effect

The specified segment is located in the reserved area, and LOC86 continues processing with no other side effects. Both the print file and object file are usable.

### User Action

If the assigned address is acceptable for the segment, no action is necessary.

ERROR 57: INVALID GROUP NAME  
ERROR IN COMMAND TAIL NEAR #:  
*partial command tail.*

### Meaning

LOC86 was expecting a group name when it found a token that did not correspond to a valid group name. LOC86 repeats the invocation line up to the point of the error.

### Cause

This is often caused by a typographical error in the invocation line.

### Effect

LOC86 immediately terminates processing; all open files are closed. The contents of the print and object files are undefined.

### User Action

Examine the invocation line and reinvoke LOC86 correctly.

ERROR 58: SPECIFIED GROUP NOT FOUND IN INPUT MODULE  
GROUP: *group name*

### Cause

This is often caused by a typographical error in the invocation line.

### Effect

LOC86 immediately terminates processing; all open files are closed. The contents of the print and object files are undefined.

### User Action

Examine the invocation line to LOC86 and the link map for the input module. Reinvoke LOC86 correctly.

ERROR 59: GROUP ADDRESS PREVIOUSLY SPECIFIED IN INPUT  
MODULE OR COMMAND LINE  
GROUP: *group name*

**Cause**

Either you gave a single group an address twice in the same ADDRESSES control or the group already had an address (due to a previous locate).

**Effect**

LOC86 immediately terminates processing; all open files are closed. The contents of the print and object files are undefined.

**User Action**

Examine the invocation line and either use the previously assigned address or assign the group one address per ADDRESSES control.

WARNING 60: REFERENCED LOCATION IS NOT WITHIN 32K OF  
SPECIFIED ADDRESS  
MODULE: *module name*  
REFERENCED LOCATION: *20-bit address*  
FRAME OF REFERENCE: *20-bit address*

**Meaning**

An 8089 self-relative reference is not within 32K bytes of its target address.

**Cause**

Either with the ORDER or ADDRESSES control you have separated the reference from its target or the 8089 segment is too large.

**Effect**

LOC86 leaves the invalid reference and continues processing with no other side effects. Both the print file and the object file will be valid.

**User Action**

Examine the invocation line and reinvoke LOC86 correctly.

ERROR 61: OVERLAY ERROR

**Meaning**

An internal LOC86 error has occurred.

**User Action**

Contact Intel immediately.



**WARNING 62: CS AND IP REGISTERS NOT INITIALIZED****Meaning**

This warning occurs when INITCODE is specified and the input register initialization record does not specify initialization of the 8086 code segment (CS) register and the 8086 instruction pointer (IP) register.

**Cause**

This condition is usually the result of an incomplete END directive in your assembly language module or a translation error.

**Effect**

The values of CS and IP at the beginning of program execution are completely dependent on the loader of your system.

**User Action**

Invoke LOC86 with the START control if desired.

**WARNING 63: SS AND SP REGISTERS NOT INITIALIZED****Meaning**

The INITCODE control was specified, but the register initialization record does not contain information for initialization of stack segment (SS) and stack pointer (SP) records.

**Cause**

This condition is usually the result of an incomplete END directive in your assembly language module or a translation error.

**Effect**

The values of SS and SP at the beginning of program execution are entirely dependent on the loader of your system.

**User Action**

If you will need to use the stack, retranslate your code, then relink and relocate.

**WARNING 64: DS REGISTER NOT INITIALIZED****Meaning**

INITCODE was specified, but the data segment (DS) register initialization record is incomplete.

**Cause**

This condition is usually the result of an incomplete END directive in your assembly language module or a translation error.

**Effect**

The value of the CS register at program execution is entirely dependent on the system loader.

**User Action**

Correct your code if necessary, then reinvoke LINK86 and LOC86.

**WARNING 65: SEGMENT ORDER IN ORDER-CONTROL CANNOT BE  
MAINTAINED**  
**SEGMENT: *segment name*****Meaning**

The ADDRESSES and ORDER control specifications for a segment are in conflict and/or the segment cannot be allocated space in accordance with the ORDER control.

**Effect**

The conflicting segment is allocated space after all other segments in the target 8086 memory.

**User Action**

If desired, reinvoke LOC86, using the appropriate ADDRESSES and ORDER controls.

**WARNING 66: START ADDRESS NOT SPECIFIED IN OUTPUT MODULE**

**Meaning**

The CS (code segment) and IP (instruction pointer) registers are not initialized.

**Cause**

The input module does not have an explicit start address, and the START control was not specified.

**Effect**

The values of these registers upon initial program execution are entirely dependent on the loader.

**User Action**

Either reinvoke LOC86 using the START control or relink to include a main module.



## APPENDIX H OH86 ERROR MESSAGES

The following are descriptions of all OH86 error and warning messages. The description of each message has up to four parts:

- **Meaning**—how to interpret the message
- **Cause**—the usual reason for the error or warning condition
- **Effect**—the state of OH86 and the object file(s) after the message is issued
- **User Action**—what you can do to correct the condition

Not all these parts are given for each message. However, parts excluded are self-explanatory.

Error messages are always fatal, but warning messages are not. In the event of a warning, read the EFFECT of the warning carefully to determine whether the resulting code is valid.

Error and warning messages are displayed at the console device.

*pathname*, PREMATURE END-OF-FILE ENCOUNTERED

### **Meaning**

OH86 has scanned the entire input file without finding the record that signals the end of the module.

### **Cause**

There is a transcription error in the specified file.

### **Effect**

OH86 immediately terminates processing and closes all open files. The contents of the output file are undefined.

### **User Action**

Return to the last step in the program development process that did not generate this error and relocate, relink, or even retranslate.

*pathname*, EXPECTED MODULE HEADER NOT FOUND

**Meaning**

The first record in the input file was not a module header record.

**Cause**

This is usually caused by specifying an input file that does not contain an 8086 object module.

**Effect**

OH86 immediately terminates processing and closes all open files. The contents of the output file are undefined.

**User Action**

Check the invocation line; if you specified the input file incorrectly, then reinvoke OH86 more carefully. Otherwise, return to the last step in the program development process and reexecute.

*pathname*, ILLEGAL RELOCATION RECORD ENCOUNTERED

**Cause**

This error occurs whenever you specify a non-absolute 8086 object module as the input file.

**Effect**

OH86 immediately terminates processing and closes all open files. The contents of the output file are undefined.

**User Action**

Locate the object module with LOC86 before reinvoking OH86.

*pathname*, INSUFFICIENT MEMORY TO PROCESS DATA RECORD

**Meaning**

There is insufficient memory in your system for OH86 to process your input file.

**Cause**

You are trying to convert a file that is too complex for the available memory in your system.

**Effect**

OH86 immediately terminates processing and closes all open files. The contents of the output file are undefined.

**User Action**

Expand the memory on your system.

*pathname*, ILLEGAL REGISTER INITIALIZATION RECORD ENCOUNTERED

**Cause**

Your input module contains a register initialization record.

**Effect**

OH86 immediately terminates processing and closes all open files. The contents of the output file are undefined.

**User Action**

Relocate with INITCODE in effect.

*pathname*, ILLEGAL OVERLAY INFORMATION ENCOUNTERED

**Cause**

You attempted to convert a file containing overlay information.

**Effect**

OH86 immediately terminates processing and closes all open files. The contents of the output file are undefined.

**User Action**

If overlays are necessary, create root and overlay in separate files.





# APPENDIX I

## ADDITIONAL INFORMATION FOR INTELLEC® SERIES III USERS

### Environmental Considerations

The iAPX 86,88 Family utilities run on and can be used to produce code executable on the Intellec Series III Microcomputer Development System. Resulting code is also compatible with the ICE-86 Emulator and DEBUG-86.

The following conventions of the Series III operating system (ISIS-II) are encountered in running the utilities:

- The utilities must be executed when the Series III is in the 8086 mode. This operating mode is activated by entering the RUN command, either in conjunction with a utility program invocation or by itself (to enter the "interactive" 8086 mode):

```
-RUN :F1:LOC86 :F3:MYPROG.LNK<cr>
```

```
-RUN<cr>
>:F1:LOC86 :F3:MYPROG.LNK<cr>
>
```

- The :Fn: portion of the pathname is the Series III directory-name. In this configuration, the directory-name is the equivalent of a device name, the device on which the filename is located. If the file is located on the system disk (:F0:), the directory-name may be omitted from the pathname.
- Continuation lines are necessary when a command or invocation will not fit on one line. The following example illustrates the line-end conventions to use and the continuation characters to expect:

```
>LINK86 :F3:TEST.OBJ,SMALL.LIB,USER.LIB &<cr>
>>TO :F3:TEST.86 BIND<cr>
>
```

- The LIB86 utility presents an exception to these prompt conventions. Because this program is interactive, it has its own prompts:

```
-RUN LIB86<cr>
SERIES-III 8086 LIBRARIAN Vx.y
*ADD :F1:SEC.LNK, :F1:CSC.LNK, &<cr>
** :F1:TAN.LNK TO TRIG.LIB<cr>
*
```

The following table defines compatible software version combinations.

|        | ISIS-II |               |                      |                  | ISIS-III(D)<br>V1.0 or later |                  |
|--------|---------|---------------|----------------------|------------------|------------------------------|------------------|
|        | V4.0    | V4.1          | V4.2                 |                  |                              |                  |
| RUN    | —       | V1.0<br>V1.1  | V1.0<br>V1.1<br>V1.2 | V1.3<br>or later | V1.2                         | V1.3<br>or later |
| LINK86 | —       | V1.0          | V1.0                 | V2.0<br>or later | V1.0                         | V2.0<br>or later |
| REF86  | —       | V1.0 or later |                      |                  |                              |                  |
| LIB86  | —       | V1.0 or later |                      |                  |                              |                  |
| LOC86  | —       | V1.0 or later |                      |                  |                              |                  |
| OH86   | —       | V1.0 or later |                      |                  |                              |                  |



## Related Publications

The following manuals may be helpful during various aspects of your work with iAPX 86,88 utilities on the Series III:

- *Intellec Series III Microcomputer Development System Product Overview*, order number 121575
- *iAPX 86,88 User's Manual*, order number 210201
- *Intellec Series III Microcomputer Development System Console Operating Instructions*, order number 121609
- *Intellec Series III Microcomputer Development System Programmer's Reference Manual*, order number 121618
- *PASCAL-86 User's Guide*, order number 121539
- *PL/M-86 User's Guide*, order number 121636
- *ASM86 Language Reference Manual*, order number 121703
- *ASM86 Macro Assembler Operator's Manual*, order number 121628
- *8089 Macro Assembler User's Guide*, order number 9800938
- *FORTTRAN-86 User's Guide*, order number 121570

## Program Development Examples

The following examples are programming problems solved by using one or more of the iAPX 86,88 utilities on the Series III to develop code for an 8086-based host.

### Example 1: Preparing to Use DEBUG-86

There are only two steps to preparing your code for execution: translating the code, then linking it with BIND.

First you must translate your code. Any of the 8086 translators will work. An example of one such translation is shown below:

```
-RUN PLM86 :F6:TEST.SRC DEBUG SMALL<cr>
```

Once the program has been translated, you must then link the program with the BIND control. LINK86 with BIND produces an LTL module — the loader assigns addresses to the LTL modules at load time. This operation can be performed by the 8086 loader, RUN. The operation and control of both of these programs is given in the *Intellec Series III Microcomputer Development System Console Operating Instructions*.

The invocation line for LINK86 when linking the program shown above might appear as follows:

```
-RUN LINK86 :F6:TEST.OBJ, :F6:UTILS.OBJ, &<cr>
>>:F6:SMALL.LIB TO :F6:TEST.86 BIND<cr>
```

In the above example note that all of the symbol information (LINES, SYMBOLS, PUBLICS) is left in the output object file. This will aid you while debugging your program. DEBUG-86 uses the symbol information to produce diagnostic information on the program.

This information is also included in the symbol table. Figure I-1 shows the print file from the invocation above.

The libraries specified resolve all of the external references in TEST.OBJ.

After the above linkage, the program can be executed with the following command to the Series III:

**-RUN DEBUG :F6:TEST.86<cr>**

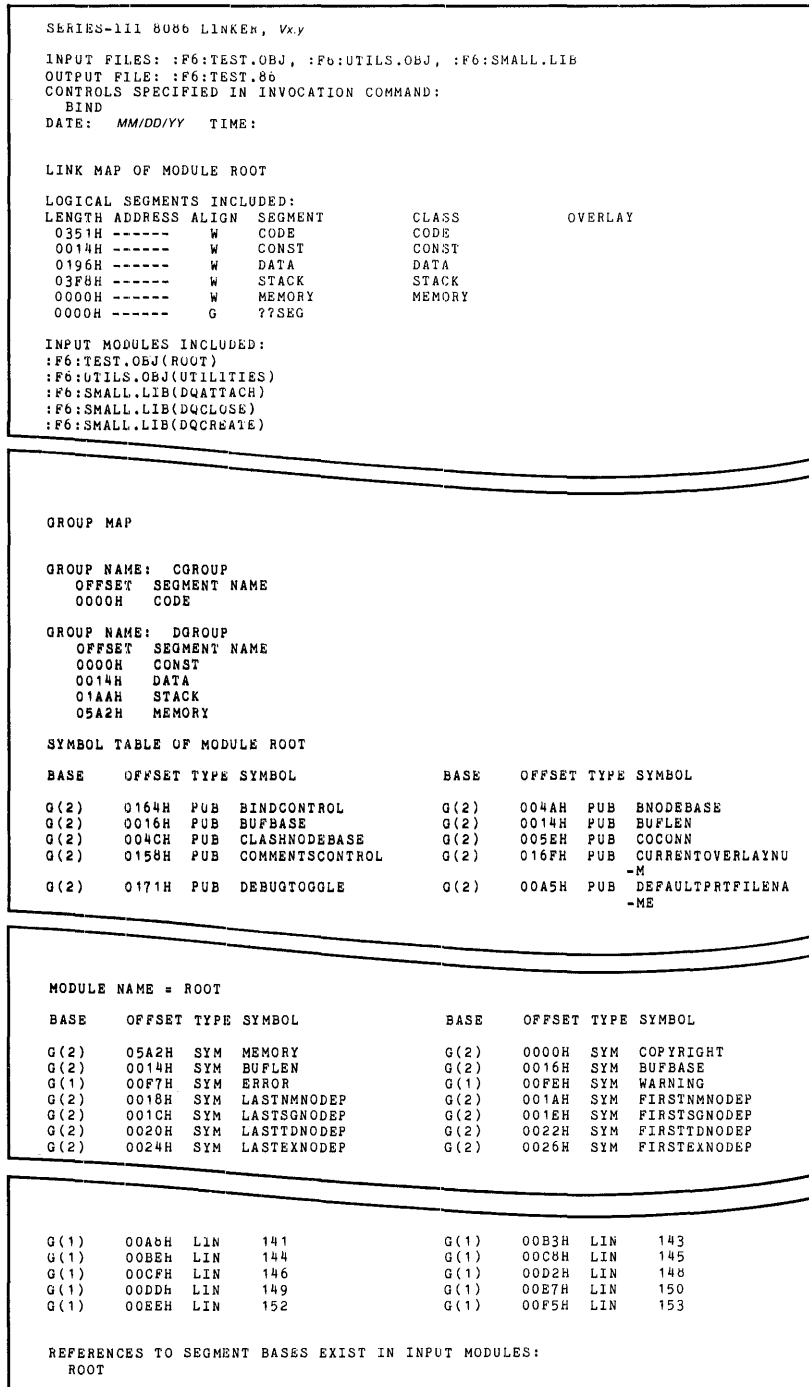

Figure I-1. LINK86 Print File for Bound Object Module

Although we do not recommend it, it is possible to execute an absolute object module with DEBUG-86. However, the module must be located in free user memory. DEBUG-86 uses the address from 0FC000H to 0FFFFFFH, and RUN uses the address from 00H to 77FFH. All other memory is available. However, if your system does not have a full megabyte of memory, there may be other areas that must be reserved. You can use the RESERVE control to prevent LOC86 from using these areas.

The following invocation line is an example of how :F6:TEST.86 might be located; although :F6:TEST.86 has been bound, programs that are to be located for execution on the Series III need not be bound:

```
-RUN LOC86 :F6:TEST.86 RESERVE(00H TO 77FFH,0FC000H &<cr>
>>TO 0FFFFFFH)<cr>
```

The print file produced from the above invocation is shown in figure I-2.

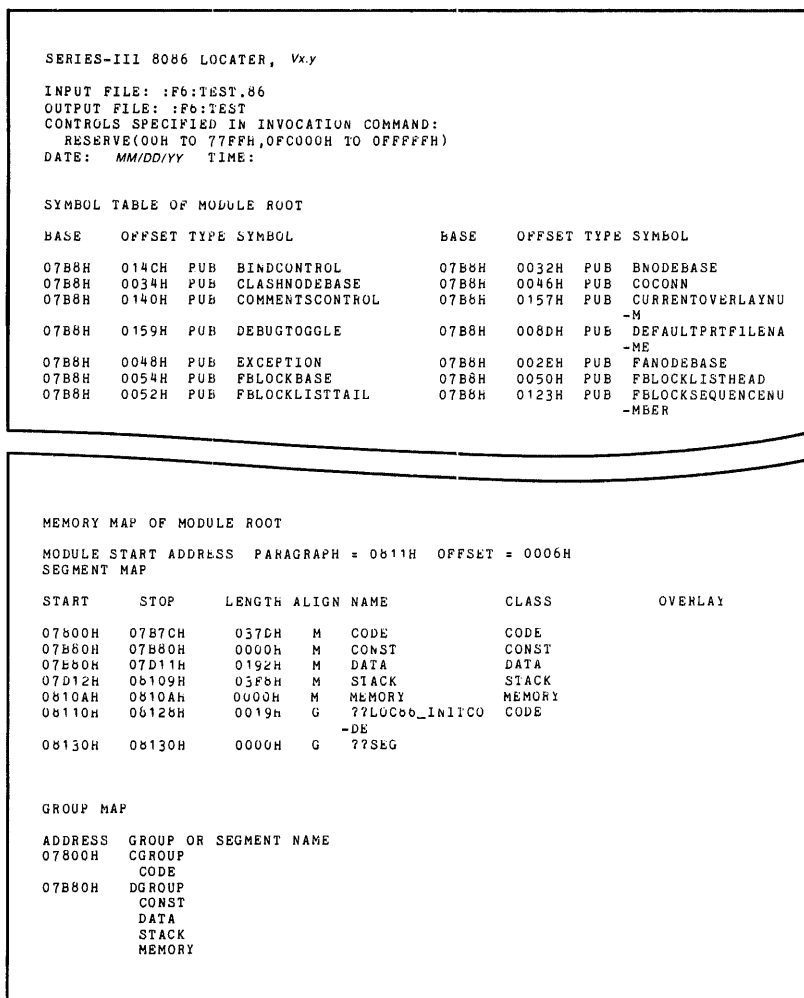

Figure I-2. LOC86 Print File for Bound Object Module

## Example 2: Preparing to Use an ICE-86 System

Another way to test and debug software is using in-circuit emulation (ICE) system. The ICE-86 loader can load only absolute object modules. Therefore, you cannot use the output from LINK86 immediately; it must be located too.

The whole process of preparing a program for ICE-86 execution takes three steps. The first two are the same as in Example 1: the program must be translated and linked:

```
-RUN PLM86 :F6:ICETST.SRC SMALL<cr>
```

```
.
.
.
```

```
-RUN LINK86 :F6:ICETST.OBJ,:F6:$SMALL.LIB<cr>
```

The above example shows a straightforward linkage with no change to the default control setting. Note that NOOVERLAY and NOBIND, the defaults, are set. The ICE-86 loader has no facility for dealing with overlay modules created by using the LINK86 OVERLAY control. In this case there are no unresolved external references in the object module. If the module did contain unresolved references, it could still be executed by the ICE-86 system. However, as with execution under DEBUG-86, executing instructions that contain unresolved references will produce undefined results.

Figure I-3 shows the print file produced during the invocation shown above. LINK86 does not produce a symbol table with NOBIND is in effect.

The last step before ICE-86 execution is transforming the relocatable object module into an absolute object module with LOC86. The invocation line shown below would produce an object file that could be loaded and executed by the ICE-86 Emulator:

```
-RUN LOC86 :F6:ICETST.LNK<cr>
```

```

SERIES-III 8086 LINKER, Vx.y
INPUT FILES: :F6:ICETST.OBJ, :F6:SMALL.LIB
OUTPUT FILE: :F6:ICETST.LNK
CONTROLS SPECIFIED IN INVOCATION COMMAND:
DATE: MM/DD/YY TIME:

LINK MAP OF MODULE LOANER

LOGICAL SEGMENTS INCLUDED:
LENGTH ADDRESS ALIGN SEGMENT CLASS OVERLAY
037DH ----- W CODE CODE
0000H ----- W CONST CONST
0192H ----- W DATA DATA
03F8H ----- W STACK STACK
0000H ----- W MEMORY MEMORY
0000H ----- G ??SEG

INPUT MODULES INCLUDED:
:F6:ICETST.OBJ(LOANER)
:F6:SMALL.LIB(DQATTACH)
:F6:SMALL.LIB(DQCLOSE)
:F6:SMALL.LIB(DQCREATE)
:F6:SMALL.LIB(DQDETACH)
:F6:SMALL.LIB(DQEXIT)
:F6:SMALL.LIB(DQGETSYSTEMID)
:F6:SMALL.LIB(DQOPEN)
:F6:SMALL.LIB(DQOVERLAY)
:F6:SMALL.LIB(DQWRITE)
:F6:SMALL.LIB(SYSTEMSTACK)

```

Figure I-3. LINK86 Default Print File

This invocation line shows LOC86 invoked with the default control setting. Note that the INITCODE control is in effect by default.

The PL/M-86 program ICETST.SRC is ready for execution on an ICE-86 system.

### Example 3: Using CREF86

Figure I-4 illustrates a CREF86 cross-reference listing for an input list of 15 files, one of which contains several modules. The output print file pathname OUT and a title for the listing were specified in the controls. Although PAGEWIDTH (PW) and PAGELENGTH (PL) specifications were also noted in the controls, the numbers specified are the same as those provided by default.

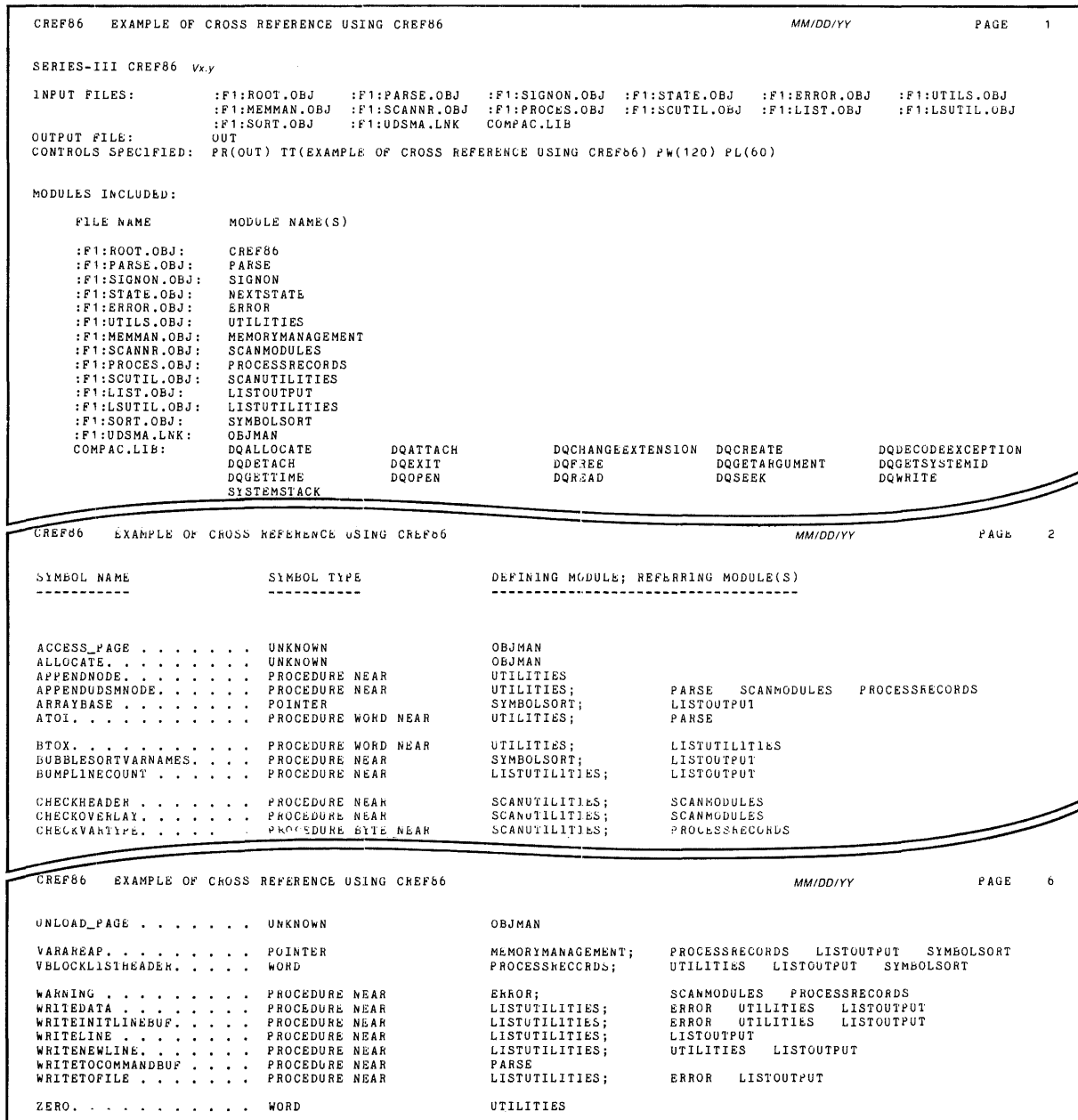

Figure I-4. CREF86 Cross-Reference Listing

## Example 4: Building and Using Library Files

A library is a file that contains object modules. Libraries allow you to collect commonly used pieces of software into one file. The library file can be included in a LINK86 invocation, and LINK86 will use the modules to resolve references.

You can add the output from a translator, LINK86, or LOC86 to a library. The modules added may be relocatable or absolute; they can have unresolved references or be completely linked.

Let's consider the following scenario — we have created six routines (SINE, COSINE, TANGENT, COSECANT, SECANT, and COTANGENT). We want to create a library file that will allow each routine to be linked to programs separately.

The first step necessary to create the library is to translate each routine separately. If we were to put them in a single source module, the translator would translate them into one module with six public symbols. We could add this module to a library, but when we tried to link one of the routines into a program, all six would be included.

Once the routines are translated, LIB86 can be used to create a library file and add modules. The LIST command is used to display the contents of the library and the publics contained within it.

```
-RUN LIB86<cr>
SERIES-III 8086 LIBRARIAN Vx.y
*CREATE TRIG.LIB<cr>
*ADD :F1:SIN.OBJ, :F1:COS.OBJ TO TRIG.LIB<cr>
*LIST TRIG.LIB PUBLICS<cr>
:F0:TRIG.LIB
SIN
SINE
COS
COSINE
*ADD :F1:SEC.LNK, :F1:CSC.LNK, :F1:COT.LNK, &<cr>
*:F1:TAN.LNK TO TRIG.LIB<cr>
*LIST TRIG.LIB PUBLICS<cr>
:F0:TRIG.LIB
SIN
SINE
COS
COSINE
SEC
SECANT
CSC
COSECANT
COT
COTANGENT
TAN
TANGENT
*EXIT<cr>
-
```

## Example 5: Linking and Locating Programs with Overlays Using OVERLAY Control

The easiest way to build an 8086 program that contain overlays is with LINK86's OVERLAY control. Overlay modules built with this control reside in the same file as the root. The operating system supplies routines that will load the overlays constructed in this way. See *Intellec Series III Microcomputer Development System Programmer's Reference*.

After the program modules that will constitute the root and its overlays are translated, each of the overlays and the root must be linked separately. Then the root and all of the overlays are linked together.

The example below shows the first step toward linking overlays—linking all of the modules that will constitute each overlay and the root separately:

```
-RUN LINK86 OV1.OBJ,OV1A.OBJ,OV1B.OBJ &<cr>
>>OVERLAY(OVERLAY1)<cr>

-RUN LINK86 OV2A.OBJ,OV2B.OBJ,OV2C.OBJ TO &<cr>
>>OV2.LNK OVERLAY(OVERLAY2)<cr>

-RUN LINK86 OV3.OBJ,OV3A.OBJ OVERLAY(OVERLAY3)<cr>

-RUN LINK86 OV4.OBJ,OV4A.OBJ OVERLAY(OVERLAY4)<cr>

-RUN LINK86 ROOT.OBJ,ROOTA.OBJ,ROOTB.OBJ, &<cr>
>>SMALL.LIB OVERLAY(ROOT)<cr>
```

Notice that all of the modules, including the root, are linked with the OVERLAY and NOBIND controls. The overlay name for the root is not as critical as for the overlays, since the overlay name is used when calling the loader.

Finally, the overlays and root must be linked together. Since any one of the files could be the root, LINK86 requires that for the final link the file containing the root must be first in the input list. During this final the OVERLAY control is not used:

```
-RUN LINK86 ROOT.LNK, OV1.LNK, OV2.LNK, OV3.LNK, &<cr>
>>OV4.LNK TO PROG.86<cr>
```

In the invocation, the optional BIND control is specified. The resulting object file is executable on a Series III.

Figure I-5 shows the LINK86 print file listing for the above invocation.

There is nothing special about the invocation line to LOC86 when locating a file that contains overlays or that has been bound:

```
-RUN LOC86 PROG.86 RESERVE (0H TO 77FFH, &<cr>
>>0FC000H TO 0FFFFFFH)<cr>
```

The RESERVE control prevents LOC86 from assigning memory addresses reserved for the operating system. Figure I-6 illustrates the printout from this invocation.

```

SERIES-III 8086 LINKER, Vx.y

INPUT FILES: ROOT.LNK, OV1.LNK, OV2.LNK, OV3.LNK, OV4.LNK
OUTPUT FILE: PROG.86
CONTROLS SPECIFIED IN INVOCATION COMMAND:
 BIND
DATE: MM/DD/YY TIME:

LINK MAP OF MODULE ROOT

LOGICAL SEGMENTS INCLUDED:
LENGTH ADDRESS ALIGN SEGMENT CLASS OVERLAY
3CE7H ----- G CODE CODE ROOT
0D00H ----- G CONST CONST ROOT
2840H ----- G DATA DATA ROOT

INPUT MODULES INCLUDED:
ROOT.LNK(ROOT)
OV1.LNK(PARSE)
OV2.LNK(ILUDE)
OV3.LNK(PICILUDE)
OV4.LNK(FASTLOAD)

GROUP MAP

GROUP NAME: CGROUP
 OFFSET SEGMENT NAME
0000H CODE\CODE\ROOT
3CE8H CODE\CODE\PASS1
3CE8H CODE\CODE\PASS2

SYMBOL TABLE OF MODULE ROOT

BASE OFFSET TYPE SYMBOL BASE OFFSET TYPE SYMBOL
G(2) 251CH PUB ACTUAL G(2) 0F0DH PUB ASSUMEROOTCONTRO
-L
G(2) 0F22H PUB BASEFIXUPSEXIST G(2) 0F0CH PUB BINDCONTROL
G(2) 0D26H PUB BNODEID G(2) 24EAH PUB BUFBASE
G(2) 0D28H PUB CLASHNODEID G(2) 0D5AH PUB COCONN
G(2) 0F00H PUB COMMENTSCONTROL G(2) 0F50H PUB CURRENTFILNUM
G(2) 0F1AH PUB CURRENTOVERLAYNU G(2) 0F8EH PUB CURRENTRECINDEX
-M

OVERLAY NAME = ROOT, MODULE NAME = ROOT

BASE OFFSET TYPE SYMBOL BASE OFFSET TYPE SYMBOL
G(2) 4A20H SYM MEMORY G(2) 0002H SYM COPYRIGHT
G(2) 0D00H SYM LASTNMNODEID G(2) 0D02H SYM FIRSTNMNODEID
G(2) 0D04H SYM LASTSGNODEID G(2) 0D06H SYM FIRSTSGNODEID
G(2) 0D08H SYM LASTIDNODEID G(2) 0D0AH SYM FIRSTIDNODEID
G(2) 0D0CH SYM LASTEXNODEID G(2) 0D0EH SYM FIRSTEXNODEID
G(2) 0D10H SYM LASTGRNODEID G(2) 0D12H SYM FIRSTGRNODEID
G(2) 0D14H SYM LASTOVNODEID G(2) 0D16H SYM FIRSTOVNODEID
G(2) 0D16H SYM LASTGNODEID G(2) 0D1AH SYM FIRSTBNODEID

OVERLAY NAME = ROOT, MODULE NAME = LIT

BASE OFFSET TYPE SYMBOL BASE OFFSET TYPE SYMBOL
G(2) 4A20H SYM MEMORY G(2) 003CH BAS SGNODE
G(2) 0F56H SYM LITBASE G(2) 0F58H SYM LITID
G(2) 0F56H BAS LITNODE G(2) 0F5AH SYM FIRSTNODEIDS
G(2) 0F64H SYM FIRSTNODE G(2) 0F8EH SYM CURRENTRECINDEX
G(2) 0F96H SYM TEMPLATE G(2) 0FB9H SYM II
G(1) 016EH SYM GETLIT STACK 0006H SYM INDEX
STACK 0004H SYM I G(1) 0207H SYM SGLIT

```

Figure I-5. LINK86 Listing for Program with Overlays



```

SERIES-III 8086 LOCALER, Vx.y
INPUT FILE: PROG.86
OUTPUT FILE: PROG
CONTROLS SPECIFIED IN INVOCATION COMMAND:
RESEKVE(OH TO 77FFH,0FC000H TO 0FFFFH)
DATE: MM/DD/YY TIME:

SYMBOL TABLE OF MODULE ROOT

```

| BASE  | OFFSET | TYPE | SYMBOL           | BASE  | OFFSET | TYPE | SYMBOL           |
|-------|--------|------|------------------|-------|--------|------|------------------|
| 1034H | 251CH  | PUB  | ACTUAL           | 1034H | 0F0DH  | PUB  | ASSUMEROOTCONTRO |
| 1034H | 0F22H  | PUB  | BASEFIXUPSEXIST  | 1034H | 0F0CH  | PUB  | BINDCONTROL      |
| 1034H | 0D26H  | PUB  | BNODEID          | 1034H | 24EAH  | PUB  | BUFBASE          |
| 1034H | 0D28H  | PUB  | CLASHNODEID      | 1034H | 0D5AH  | PUB  | COCONN           |
| 1034H | 0F00H  | PUB  | COMMENTSCONTROL  | 1034H | 0F50H  | PUB  | CURRENTFILNUM    |
| 1034H | 0F1AH  | PUB  | CURRENTOVERLAYNU | 1034H | 0F8EH  | PUB  | CURRENTRECINDEX  |

-M

```

OVERLAY = ROOT, MODULE = ROOT

```

| BASE  | OFFSET | TYPE | SYMBOL       | BASE  | OFFSET | TYPE | SYMBOL        |
|-------|--------|------|--------------|-------|--------|------|---------------|
| 1034H | 4A20H  | SYM  | MEMORY       | 1C34H | 0002H  | SYM  | COPYRIGHT     |
| 1034H | 0D00H  | SYM  | LASTNMNODEID | 1C34H | 0D02H  | SYM  | FIRSTNMNODEID |
| 1034H | 0D04H  | SYM  | LASTSGNODEID | 1C34H | 0D06H  | SYM  | FIRSTSGNODEID |
| 1034H | 0D08H  | SYM  | LASTTDNODEID | 1C34H | 0D0AH  | SYM  | FIRSTTDNODEID |
| 1034H | 0D0CH  | SYM  | LASTEXNODEID | 1C34H | 0D0EH  | SYM  | FIRSTEXNODEID |
| 1034H | 0D10H  | SYM  | LASTGRNODEID | 1C34H | 0D12H  | SYM  | FIRSTGRNODEID |
| 1034H | 0D14H  | SYM  | LASTOVNODEID | 1C34H | 0D16H  | SYM  | FIRSTOVNODEID |
| 1034H | 0D18H  | SYM  | LASTBNODEID  | 1C34H | 0D1AH  | SYM  | FIRSTBNODEID  |
| 1034H | 0D1CH  | SYM  | SGNODEID     | 1C34H | 0D1EH  | SYM  | GRNODEID      |

```

OVERLAY = ROOT, MODULE = LIT

```

| BASE  | OFFSET | TYPE | SYMBOL    | BASE  | OFFSET | TYPE | SYMBOL          |
|-------|--------|------|-----------|-------|--------|------|-----------------|
| 1034H | 4A20H  | SYM  | MEMORY    | 1034H | 003CH  | SYM  | SGNODE          |
| 1034H | 0F56H  | SYM  | LITBASE   | 1034H | 0F58H  | SYM  | LITID           |
| 1034H | 0F56H  | SYM  | LITNODE   | 1034H | 0F5AH  | SYM  | FIRSTNODEIDS    |
| 1034H | 0F64H  | SYM  | FIRSTNODE | 1034H | 0F8EH  | SYM  | CURRENTRECINDEX |
| 1034H | 0F66H  | SYM  | TEMPLATE  | 1034H | 0F89H  | SYM  | II              |
| 0780H | 016EH  | SYM  | GETLIT    | STACK | 0006H  | SYM  | INDEX           |
| STACK | 0004H  | SYM  | I         | 0780H | 0207H  | SYM  | SGLIT           |

```

MEMORY MAP OF MODULE ROOT
MODULE START ADDRESS PARAGNAPH = 14D6H OFFSET = 0006H
SEGMENT MAP

```

| START  | STOP   | LENGTH | ALIGN | NAME | CLASS | OVERLAY   |
|--------|--------|--------|-------|------|-------|-----------|
| 07800H | 0B4E6H | 3CE7H  | M     | CODE | CODE  | ROOT      |
| 0B4E8H | 0F9BAH | 44D3H  | M     | CODE | CODE  | PASS1     |
| 0B4E8H | 0E0CEH | 2B87H  | M     | CODE | CODE  | PASS2     |
| 0B4E8H | 10337H | 4E50H  | M     | CODE | CODE  | PIC_PASS2 |

```

GROUP MAP

```

| ADDRESS | GROUP OR SEGMENT NAME |
|---------|-----------------------|
| 07800H  | CGROUP                |
|         | CODE\CODE\ROOT        |
|         | CODE\CODE\PASS1       |
|         | CODE\CODE\PASS2       |
|         | CODE\CODE\PIC_PASS2   |
|         | CODE\CODE\FASTLOAD    |
| 10340H  | DGROUP                |
|         | CONST\CONST\ROOT      |
|         | DATA\DATA\ROOT        |
|         | STACK\STACK\          |

Figure I-6 LOC86 Listing for Program with Overlays

## Example 6: Linking and Locating Programs with Overlays Without OVERLAY Control

It is harder to produce overlay modules without using the OVERLAY control. However, sometimes it is necessary to build programs in this way, for example, building a program for running under an operating system that does not support overlay modules contained in the same file as the root module.

But regardless of the reason, building overlays in this fashion places an extra burden on the programmer. He must do some of the work that would be left to LINK86 (and LOC86) if he were to use the OVERLAY control. In the following example we prepare a root and two overlay modules in separate files.

First we must compile all modules. Examples of the invocation lines are shown below:

```
-RUN PLM86 :F1:ROOT.SRC SMALL<cr>
-RUN PLM86 :F1:OV1.SRC SMALL<cr>
-RUN PLM86 :F1:OV2.SRC SMALL<cr>
```

In the next step we must link the root module to resolve external symbols with a library and to obtain a link map:

```
-RUN LINK86 :F1:ROOT.OBJ,USER.LIB MAP<cr>
```

We will need the link map for locating purposes. The link map, shown in figure 1-7, shows the size of each segment in the root. Since the overlays are self-contained except for references to the root, we do not need a link map for them. The PL/M-86 listing files will show the size of each overlay's segments, as illustrated in figure 1-8.

Note that the length of the root's code segment and OV1's code segment must fit within 64K. This means that the code for the overlays must be in a part of memory contiguous with the root (to avoid altering the CS register during execution). OV2's CONST and DATA segments are larger than OV1's so that the STACK segment must be placed to leave room for OV2's CONST and DATA segments. If the overlays share the STACK and MEMORY segments with the root, they must be located at the same address.

```
SERIES-III 8086 LINKER, Vx.y
INPUT FILES: :F1:ROOT.OBJ,USER.LIB
OUTPUT FILE: :F1:ROOT.LNK
CONTROLS SPECIFIED IN INVOCATION COMMAND:
MAP
DATE: MM/DD/YY TIME:

LINK MAP OF MODULE LOANER

LOGICAL SEGMENTS INCLUDED:
LENGTH ADDRESS ALIGN SEGMENT CLASS OVERLAY
8A95H ----- W CODE CODE
0381H ----- W CONST CONST
0291H ----- W DATA DATA
0030H ----- W STACK STACK
0000H ----- W MEMORY MEMORY

INPUT MODULES INCLUDED:
:F1:ROOT.OBJ(ROOT)
:F0:USER.LIB(LOADER)
:F0:USER.LIB(EXIT)
:F0:USER.LIB(ERROR)
:F0:USER.LIB(TIME)
```

Figure I-7. LINK86 Map for Root File

```

 OV1's segment size information
MODULE INFORMATION:
 CODE AREA SIZE = 7531H 30001D this is the CODE segment
 CONSTANT AREA SIZE = 0081H 129D this is the CONST segment
 VARIABLE AREA SIZE = 0181H 385D this is the DATA segment
 MAXIMUM STACK SIZE = 0040H 64D this is the STACK segment
 918 LINES READ
 0 PROGRAM ERROR(S)
 END OF PL/M-86 COMPILATION

 OV2's segment size information
MODULE INFORMATION:
 CODE AREA SIZE = 189AH 7066D this is the CODE segment
 CONSTANT AREA SIZE = 0101H 257D this is the CONST segment
 VARIABLE AREA SIZE = 0454H 1108D this is the DATA segment
 MAXIMUM STACK SIZE = 0067H 103D this is the STACK segment
 918 LINES READ
 0 PROGRAM ERROR(S)
 END OF PL/M-86 COMPILATION

```

Figure I-8. Module Information for Overlays

After computing the required location for the root's DGROUP and STACK, we can locate the root module. The resulting file will not be executable, but it allows us to resolve references to the root's code and data symbols in the overlays. The following LOC86 invocation will leave room for the overlays' code segments and place the DGROUP in the first unused memory location. (In the command line below, the DS register is initialized to 0FFCEH, and the CS register is initialized to 0.) The STACK and MEMORY segments will be located above OV2's DATA segment:

```

-RUN LOC86 :F1:ROOT.LNK &<cr>
>>ADDRESSES(GROUPS(CGROU(0H), DGROU(0FFCEH)), &<cr>
>> SEGMENTS(CODE(0H), CONST(0FFCEH), STACK(10B34H))) &<cr>
>>ORDER(SEGMENTS(CODE, CONST, DATA, STACK, MEMORY)) &<cr>
>>SEGSIZE(STACK(100H))<cr>

```

Once the root is located, we can use it to resolve external references in the overlay modules. The overlay modules cannot call each other, since only one is resident in memory at any time. The link commands are shown below. The NOPUBLICS with the EXCEPT control is used to avoid conflicts when we use the located overlays to resolve external references in the root:

```

-RUN LINK86 :F1:OV1.OBJ, PUBLICSONLY(:F1:ROOT) &<cr>
>>NOPUBLICS EXCEPT(OV1CODE, OV1DATA)<cr>

-RUN LINK86 :F1:OV2.OBJ, PUBLICSONLY(:F1:ROOT) &<cr>
>>NOPUBLICS EXCEPT(OV2CODE, OV2DATA)<cr>

```

The PUBLICSONLY control resolves references to public symbols contained in the root.

After the overlays have been linked, they must be located. The code and data segments must be placed in the memory locations that were reserved when we first located the root. In this case the STACK and MEMORY segments must be the same for the overlays and the root:

```
-RUN LOC86 :F1:OV1.LNK &<cr>
>>ADDRESSES(GROUPS(CGROU(0H),DGROU(0FFCEH)), &<cr>
>> SEGMENTS(CODE(8A9CH),CONST(105E0H),STACK(10B34H))) &<cr>
>>ORDER(SEGMENTS(CODE,CONST,STACK,MEMORY)) &<cr>
>>SEGSIZE(STACK(100H))<cr>
```

```
-RUN LOC86 :F1:OV2.LNK &<cr>
>>ADDRESSES(GROUPS(CGROU(0H),DGROU(0FFCEH)), &<cr>
>> SEGMENTS(CODE(8A9CH),CONST(105E0H),STACK(10B34H))) &<cr>
>>ORDER(SEGMENTS(CODE,CONST,DATA,STACK,MEMORY)) &<cr>
>>SEGSIZE(STACK(100H))<cr>
```

The CGROUP and DGROUP base address must be specified in order to compute offset information. The final base address assigned to DGROUP by LOC86 will be rounded up to 0FFD0H.

Once the overlays are located, the root is linked and located into an executable form. The PUBLICSONLY control will resolve references to symbols in the overlay modules. Other than the addition of this input control, the LINK86 and LOC86 command must be identical to those used previously:

```
-RUN LINK86 :F1:ROOT.OBJ,USER.LIB, &<cr>
>>PUBLICSONLY(:F1:OV1,:F1:OV2)<cr>
```

```
-RUN LOC86 :F1:ROOT.LNK &<cr>
>>ADDRESSES(GROUPS(CGROU(0H),DGROU(0FFCEH)), &<cr>
>> SEGMENTS(CODE(0H),CONST(0FFCEH),STACK(10B34H))) &<cr>
>>ORDER(SEGMENTS(CODE,CONST,DATA,STACK,MEMORY)) &<cr>
>>SEGSIZE(STACK(100H))<cr>
```

The executable forms of the root and its overlay files are contained in :F1:ROOT, :F1:OV1, and :F1:OV2. Figure I-9 shows the resulting layout of memory.

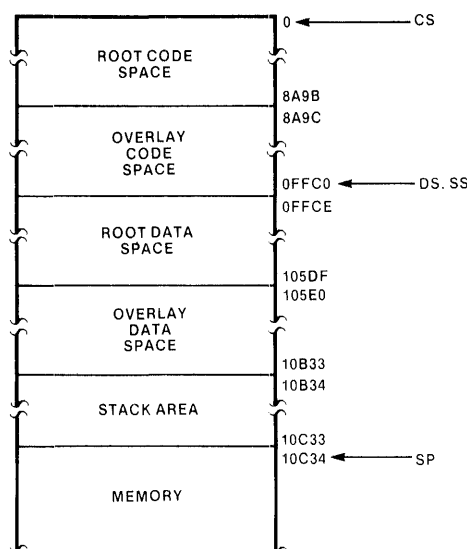

Figure I-9. Memory Organization for Example 6

121616-10

## Example 7: Linking 8089 Programs with 8086 Programs

The process of linking and locating 8086 programs with 8089 programs that use 8089 local memory is very similar to creating overlay modules in separate files.

Let us consider the following example: we have created an 8086 program and two 8089 program modules. The 8089 programs reference each other's symbols and public symbols in the 8086 program. In addition, one of the 8089 programs must be resident in 8089 local memory.

The first step is to translate the programs. The 8089 program modules must be translated separately, since they will be located in different 8089 address spaces. The following lines illustrate the invocation lines to the translators:

```
-RUN ASM86 :F1:PROG86.A86<cr>
```

```
-ASM89 :F1:TASK1.A89<cr>
```

```
-ASM89 :F1:TASK2.A89<cr>
```

TASK2 should be linked and located first for 8089 local memory. This linkage will leave unresolved external references, but it is needed to resolve the references in TASK1:

```
-RUN LINK86 :F1:TASK2.OBJ,8089.LIB<cr>
```

```
-RUN LOC86 :F1:TASK2.LNK RESERVE(10000H TO 0FFFFFFH)<cr>
```

The RESERVE control in the locate above is a precaution to avoid exceeding 64K.

The next step is to link and locate the object modules that will reside in the 8086's address space. The external references to the 8089 program module that is resident in 8089 local memory are resolved with the PUBLICSONLY control. The invocation lines for linking and locating the modules are:

```
-RUN LINK86 :F1:PROG86.OBJ, &<cr>
>>8086.LIB,:F1:TASK1.OBJ,8089.LIB, &<cr>
>>PUBLICSONLY(:F1:TASK2) TO :F1:86N89.LNK<cr>
```

```
-RUN LOC86 :F1:86N89.LNK<cr>
```

:F1:86N89 contains an absolute object module that includes PROG86 and TASK1. It may be loaded and executed on an 8086-based system. However, the 8089 program to be located in 8089 local memory still has some unresolved external references. To resolve those references we must relink with PUBLICSONLY and relocate. The invocation lines to LINK86 and LOC86 shown below are identical to those used earlier. This is necessary to guarantee that the references resolved earlier are not invalidated:

```
-RUN LINK86 :F1:TASK2.OBJ,8089.LIB, &<cr>
>>PUBLICSONLY(:F1:86N89)<cr>
```

```
-RUN LOC86 :F1:TASK2.LNK RESERVE(10000H TO 0FFFFFFH)<cr>
```

### NOTE

The example above makes many assumptions about the 8089 and 8086 code that it deals with. In most practical situations it is usually necessary to use a more complex LINK86 and LOC86 invocation. However, the example above illustrates the key linking and locating principles underlying ASM86/ASM89 module combination.

## Invocation Examples

The following foldout pages contain examples of the iAPX 86,88 Family utility controls and commands. The examples, all in the “interactive 8086” mode, may be used in conjunction with syntax specifications given:

- In Chapter 2 for LINK86
- In Chapter 3 for CREF86
- In Chapter 4 for LIB86
- In Chapter 5 for LOC86

When using the directions in these chapters, fold out the page in this appendix containing examples of the command or control you are interested in.

The following is a sample Series III OH86 invocation:

```
>OH86 :F3:DONE TO :F3:FINI.HEX<cr>
```



| Comments                                                                                                                                                                    | Control                    | Examples                                                                                                                                                                                                                                                                                                                                                                                                                                                                        |
|-----------------------------------------------------------------------------------------------------------------------------------------------------------------------------|----------------------------|---------------------------------------------------------------------------------------------------------------------------------------------------------------------------------------------------------------------------------------------------------------------------------------------------------------------------------------------------------------------------------------------------------------------------------------------------------------------------------|
| This example defines two public symbols, VARONE and VARTWO, with absolute addresses 50H and 2000H, respectively.                                                            | <b>ASSIGN</b>              | <pre>&gt;LINK86 FILE1, FILE2, FILE3 ASSIGN &amp;&lt;cr&gt; &gt;&gt;(VARONE(50H), VARTWO(2000))&lt;cr&gt;</pre>                                                                                                                                                                                                                                                                                                                                                                  |
| In this example the root file is RTFILE and LIB1 and LIB2 are library files.                                                                                                | <b>ASSUMEROOT</b>          | <pre>&gt;LINK86 ROOT1.OBJ, ROOT2.OBJ, LIB1, &amp;&lt;cr&gt; &gt;&gt;LIB2 TO RTFILE OVERLAY&lt;cr&gt;  &gt;LINK86 OV11.OBJ, OV12.OBJ, LIB1, &amp;&lt;cr&gt; &gt;&gt;LIB2 TO OV1.OBJ OVERLAY &amp;&lt;cr&gt; &gt;&gt;ASSUMEROOT(RTFILE)&lt;cr&gt;  &gt;LINK86 OV21.OBJ, OV22.OBJ, LIB1, &amp;&lt;cr&gt; &gt;&gt;LIB2 TO OV2.OBJ OVERLAY &amp;&lt;cr&gt; &gt;&gt;ASSUMEROOT(RTFILE)&lt;cr&gt;  &gt;LINK86 RTFILE, OV1.OBJ, OV2.OBJ &amp;&lt;cr&gt; &gt;&gt;TO PROG&lt;cr&gt;</pre> |
| This line creates an LTL module. The output object file is TEST with no extension.                                                                                          | <b>BIND/NOBIND</b>         | <pre>&gt;LINK86 TEST.OBJ,USER.LIB BIND PRINT&lt;cr&gt;</pre>                                                                                                                                                                                                                                                                                                                                                                                                                    |
| This example specifies default to avoid ambiguity.                                                                                                                          | <b>COMMENTS/NOCOMMENTS</b> | <pre>&gt;LINK86 GEN.OBJ NOBIND&lt;cr&gt;  &gt;LINK86 :F1:SOURCE.OBJ NOCOMMENTS &lt;cr&gt;  &gt;LINK86 :F1:PROG.OBJ TO &amp;&lt;cr&gt; &gt;&gt;:F1:TEMP.TST COMMENTS&lt;cr&gt;</pre>                                                                                                                                                                                                                                                                                             |
|                                                                                                                                                                             | <b>FASTLOAD/NOFASTLOAD</b> | <pre>&gt;LINK86 PROG.OBJ, LIB1, LIB2 BIND &amp;&lt;cr&gt; &gt;&gt;FASTLOAD&lt;cr&gt;</pre>                                                                                                                                                                                                                                                                                                                                                                                      |
|                                                                                                                                                                             | <b>INITCODE</b>            | <pre>&gt;LINK86 :F1:MYPROG INITCODE&lt;cr&gt;</pre>                                                                                                                                                                                                                                                                                                                                                                                                                             |
|                                                                                                                                                                             | <b>LINES/NOLINES</b>       | <pre>&gt;LINK86 :F1:RUN.OBJ NOLINES&lt;cr&gt;  &gt;LINK86 :F1:TEST.OBJ LINES&lt;cr&gt;</pre>                                                                                                                                                                                                                                                                                                                                                                                    |
| LINES is the default, so it need not be specified.                                                                                                                          | <b>MAP/NOMAP</b>           | <pre>&gt;LINK86 :F1:TESTER.OBJ MAP&lt;cr&gt;  &gt;LINK86.86 :F3:MAIN.OBJ,USER.OBJ, &amp;&lt;cr&gt; &gt;&gt;PUBLICSONLY(:F2:8089.LOC) NOMAP&lt;cr&gt;</pre>                                                                                                                                                                                                                                                                                                                      |
| This MEMPOOL example will increase the minimum dynamic memory requirements by 20H bytes, and by default the maximum size will increase, if necessary, to equal the minimum. | <b>MEMPOOL</b>             | <pre>&gt;LINK86 :F1:TEST.OBJ,USER.LIB, &amp;&lt;cr&gt; &gt;&gt;PASCAL.LIB BIND MEMPOOL(+20H)&lt;cr&gt;</pre>                                                                                                                                                                                                                                                                                                                                                                    |
| The minimum dynamic memory requirement is 100H. The maximum dynamic memory requirement is 300H.                                                                             |                            | <pre>&gt;LINK86 :F1:TESTED.OBJ MEMPOOL &amp;&lt;cr&gt; &gt;&gt;(100H,+200H) BIND&lt;cr&gt;</pre>                                                                                                                                                                                                                                                                                                                                                                                |



| Comments                                                                                              | Control                  | Examples                                                                                                                                                                                                                                                        |
|-------------------------------------------------------------------------------------------------------|--------------------------|-----------------------------------------------------------------------------------------------------------------------------------------------------------------------------------------------------------------------------------------------------------------|
| The LINK86 output module will have the name specified in parentheses in the control.                  | <b>NAME</b>              | <pre>&gt;LINK86 :F1:TOM.OBJ,SYS.LIB NAME &amp;&lt;cr&gt; &gt;&gt;(THIS_IS_A_VERY_LONG_MODULE@NAME.)&lt;cr&gt;</pre>                                                                                                                                             |
| This example removes all debug and public records from the object file.                               | <b>OBJECTCONTROLS</b>    | <pre>&gt;LINK86 :F1:FINAL, USER.LIB, &amp;&lt;cr&gt; &gt;&gt;SYS.LIB OBJECTCONTROLS(PURGE)&lt;cr&gt;</pre>                                                                                                                                                      |
| The EXCEPT in the NOPUBLICS overrides the PURGE.                                                      | <b>ORDER</b>             | <pre>&gt;LINK86 :F3:PASCL1.OBJ &amp;&lt;cr&gt; &gt;&gt;OBJECTCONTROLS(PURGE,NOPUBLICS &amp;&lt;cr&gt; &gt;&gt;EXCEPT(START, DATA1, DATA2))&lt;cr&gt;</pre>                                                                                                      |
| This use of ORDER specifies the order of segments for two groups.                                     | <b>OVERLAY/NOOVERLAY</b> | <pre>&gt;LINK86 :F6:PLMPRG.OBJ, PLM86.LIB, &amp;&lt;cr&gt; &gt;&gt;SMALL.LIB, USER.LIB &amp;&lt;cr&gt; &gt;&gt;ORDER(DGROUP(SEG1,SEG2\CLASS1, &amp;&lt;cr&gt; &gt;&gt;SEG2\CLASS1\OVERLAY1), &amp;&lt;cr&gt; &gt;&gt;CGROUP(CSEG1,CSEG2,CSEG3))&lt;cr&gt;</pre> |
| This example will create an overlay record, and the name of the overlay will be OVERLAY1.             | <b>PRINT/NOPRINT</b>     | <pre>&gt;LINK86 FILE1,FILE2,FILE3 TO &amp;&lt;cr&gt; &gt;&gt;:F1:OV1.LNK OVERLAY(OVERLAY1)&lt;cr&gt;</pre>                                                                                                                                                      |
| First the constituent files must be linked to form overlays.                                          | <b>PRINT CONTROLS</b>    | <pre>&gt;LINK86 FILE4,FILE5,FILE6 TO &amp;&lt;cr&gt; &gt;&gt;:F1:OV2.LNK OVERLAY(OVERLAY2)&lt;cr&gt;</pre>                                                                                                                                                      |
| The print file is :F1:TEMP1.MP1.                                                                      | <b>PRINT CONTROLS</b>    | <pre>&gt;LINK86 FILE7,FILE8,FILE9 TO &amp;&lt;cr&gt; &gt;&gt;:F1:ROOT.LNK OVERLAY(ROOT)&lt;cr&gt;</pre>                                                                                                                                                         |
| The print file is :F1:PROG.MP1.                                                                       | <b>PRINT CONTROLS</b>    | <pre>&gt;LINK86 :F1:ROOT.LNK,:F1:OV1.LNK, &amp;&lt;cr&gt; &gt;&gt;:F1:OV2.LNK&lt;cr&gt;</pre>                                                                                                                                                                   |
| The print file is :F1:THE.MAP.                                                                        | <b>PRINT CONTROLS</b>    | <pre>&gt;LINK86 :F1:PROG.OBJ TO &amp;&lt;cr&gt; &gt;&gt;:F1:TEMP1.TST PRINT&lt;cr&gt;</pre>                                                                                                                                                                     |
| This example removes information about line numbers, local symbols, and comments from the print file. | <b>PRINT CONTROLS</b>    | <pre>&gt;LINK86 :F1:PROG.OBJ&lt;cr&gt;</pre>                                                                                                                                                                                                                    |
| This statement removes all but the segment information and error messages from the print file.        | <b>PRINT CONTROLS</b>    | <pre>&gt;LINK86 :F1:PROG.OBJ, &amp;&lt;cr&gt; &gt;&gt;USER.LIB PRINT(:F1:THE.MAP)&lt;cr&gt;</pre>                                                                                                                                                               |
|                                                                                                       | <b>PRINT CONTROLS</b>    | <pre>&gt;LINK86 :F2:TEMP.OBJ &amp;&lt;cr&gt; &gt;&gt;BIND PRINTCONTROLS(NOLINES, &amp;&lt;cr&gt; &gt;&gt;NOCOMMENTS, NOSYMBOLS)&lt;cr&gt;</pre>                                                                                                                 |
|                                                                                                       | <b>PRINT CONTROLS</b>    | <pre>&gt;LINK86 :F3:PASCL1.OBJ &amp;&lt;cr&gt; &gt;&gt;PRINTCONTROLS(PURGE)&lt;cr&gt;</pre>                                                                                                                                                                     |

**Comments**

Public information concerning only DATA1, DATA2, LABEL3, and PROC4 is placed in the object file and print file.

All public symbol information will be included in both the print file and output file.

This example will produce a file containing only the absolute public symbol records from :F1:8089.LOC. The object file will be :F1:8089.LNK.

This will resolve the references in ROOT.OBJ to absolute public symbols in the separately linked and located overlays OV1 and OV2.

This produces an object file containing no debug or public information.

This confirms that the line and symbol information should be kept in the print file.

This will change the translator-assigned name CGROUP to THE@CODE. A subsequent linkage would not combine THE@CODE with a group named CGROUP.

This changes the name of the CODE group to CGROUP.

This tells the loader that 15FFH bytes of code is the minimum requirement for MEMORY. The new maximum size of MEMORY is 35FFH.

This increments MEMORY's minimum size by 1FFH (7951D) bytes. The maximum size of MEMORY is equal to the old minimum size plus 3FEH (15902D).

The local symbol records will be included in the object file.

PURGE is a shorthand for NOSYMBOLS, NOCOMMENTS, NOPUBLICS, NOTYPE, and NOLINES.

SYMBOLCOLUMNS has no effect, since BIND was not specified.

The symbol table will be printed on a line printer.

LIBMOD will retain its type information.

**Control****PUBLICS/NOPUBLICS****PUBLICSONLY****PURGE/NOPURGE****RENAMEGROUPS****SEGSIZE****SYMBOLS/NOSYMBOLS****SYMBOLCOLUMNS****TYPE/NOTYPE****Examples**

```
>LINK86 :F1:TEST.OBJ,USER.LIB &<cr>
>>NOPUBLICS EXCEPT(DATA1, DATA2, &<cr>
>>LABEL3,PROC4)<cr>
```

```
>LINK86 :F4:TEMP.OBJ,SMALL.LIB, &<cr>
>>USER.LIB PUBLICS<cr>
```

```
>LINK86 PUBLICSONLY(:F1:8089.LOC)<cr>
```

```
>LINK86 :F1:ROOT.OBJ, &<cr>
>>PUBLICSONLY(:F1:OV1, :F1:OV2)<cr>
```

```
>LINK86 :F1:INDEX.OBJ PURGE<cr>
```

```
>LINK86 :F3:FINAL.OBJ PRINTCONTROLS &<cr>
>>(NOPURGE)<cr>
```

```
>LINK86 :F1:PLMPRG.OBJ RENAMEGROUPS &<cr>
>>(CGROUP TO THE@CODE)<cr>
```

```
>LINK86 :F9:ASMPRG.OBJ &<cr>
>>RENAMEGROUPS(CODE TO CGROUP)<cr>
```

```
>LINK86 :F7:GEORGE.OBJ, USER.LIB, &<cr>
>>SYSTEM.LIB BIND SEGSIZE(MEMORY &<cr>
>>(15FFH,+2000H))<cr>
```

```
>LINK86 :F4:PROJCT.OBJ, &<cr>
>>REST.LIB SEGSIZE(MEMORY(+1FF,+1FF))<cr>
```

```
>LINK86 :F1:TEMP.OBJ,USER.LIB &<cr>
>>NOSYMBOLS SYMBOLS<cr>
```

```
>LINK86 :F3:TEST.OBJ,USER.LIB PURGE<cr>
```

```
>LINK86 :F1:TEST.OBJ SYMBOLCOLUMNS(1)<cr>
```

```
>LINK86 :F1:ROOT.LNK, :F1:OV1.LNK, &<cr>
>>:F1:OV2.LNK, PUBLICSONLY(:F3:8089) &<cr>
>>SYMBOLCOLUMNS(4) BIND PRINT(:LP:)<cr>
```

```
>LINK86 :F1:LIBMOD.OBJ TYPE<cr>
```

| Comments                                                                                                                                           | Control    | Examples                                                                                                                            |
|----------------------------------------------------------------------------------------------------------------------------------------------------|------------|-------------------------------------------------------------------------------------------------------------------------------------|
| The cross-reference listing will have 35 lines on each page.                                                                                       | PAGELENGTH | >CREF86 :F1:FILE1, FILE.LIB &<cr><br>>>PAGELENGTH(35)<cr>                                                                           |
| The cross-reference listing will be 100 characters wide maximum per page.                                                                          | PAGEWIDTH  | >CREF86 :F1:PROG, :F1:LIB(MOD1) &<cr><br>>>PAGEWIDTH(100)<cr>                                                                       |
| The pathname of the print file will be :F1:MYFILE.                                                                                                 | PRINT      | >CREF86 :F2:FILES(MODULE1,MODULE2) &<cr><br>>>PRINT(:F1:MYFILE)<cr>                                                                 |
| The message in the TITLE control must be placed on one line. If the message contains special characters, it must be enclosed in single quotes ('). | TITLE      | >CREF86 MYPROG,HISPROG,HERPROG, &<cr><br>>>MYLIB,HISLIB,HERLIB TITLE &<cr><br>>>('A CROSS-REFERENCE') &<cr><br>>>PAGEWIDTH(105)<cr> |

| Comments                                                          | Control | Examples                                                                                                                                                                                                                          |
|-------------------------------------------------------------------|---------|-----------------------------------------------------------------------------------------------------------------------------------------------------------------------------------------------------------------------------------|
| Three object files are added to the USER.LIB.                     | ADD     | <pre>*ADD :F1:SIN,:F1:COS,:F1:TAN TO &amp;&lt;cr&gt; ** :F0:USER.LIB&lt;cr&gt; *</pre>                                                                                                                                            |
| Three modules from the library LIB.ABC are added to :F3:PROJ.TOM. |         | <pre>*ADD :F1:LIB.ABC(MOD1, MOD2, MOD3) &amp;&lt;cr&gt; **TO :F3:PROJ.TOM&lt;cr&gt; *</pre>                                                                                                                                       |
| This command will produce an empty library file called TOMS.LIB.  | CREATE  | <pre>*CREATE :F3:TOMS.LIB&lt;cr&gt; *</pre>                                                                                                                                                                                       |
|                                                                   |         | <pre>*CREATE :F0:USER.LIB&lt;cr&gt; *</pre>                                                                                                                                                                                       |
| Four modules are deleted from the library USER.LIB.               | DELETE  | <pre>*DELETE :F3:USER.LIB(TEMP1, &amp;&lt;cr&gt; **TEMP3, TEM_TMP,TEST?)&lt;cr&gt; *</pre>                                                                                                                                        |
|                                                                   |         | <pre>*DELETE :F0:IO.LIB(FLOPPY, CRT, &amp;&lt;cr&gt; **PAPER_TAPE)&lt;cr&gt; *</pre>                                                                                                                                              |
|                                                                   | EXIT    | <pre>*EXIT&lt;cr&gt; &gt;</pre>                                                                                                                                                                                                   |
|                                                                   | LIST    | <pre>*LIST USER.LIB&lt;cr&gt; USER.LIB TEMP TEST EXEC MAIN LOOP *LIST USER.LIB(TEMP,TEST)&lt;cr&gt; USER.LIB TEMP TEST *LIST USER.LIB,TEMP.LIB&lt;cr&gt; USER.LIB TEMP TEST EXEC MAIN LOOP TEMP.LIB MODULE1 MODULE3 MODULE4</pre> |

| Comments                                                                                                                                                                                                                                                                                                                                 | Control                    | Examples                                                                                                                                                                 |
|------------------------------------------------------------------------------------------------------------------------------------------------------------------------------------------------------------------------------------------------------------------------------------------------------------------------------------------|----------------------------|--------------------------------------------------------------------------------------------------------------------------------------------------------------------------|
| If SEG1 is byte alignable, it will be located at 15FFH.<br>If SEG2 is byte or word alignable, it will be at 4F5AH.                                                                                                                                                                                                                       | <b>ADDRESSES</b>           | >LOC86 :F7:COME.LNK TO :F8:WENT &<cr><br>>>ADDRESSES(SEGMENTS(SEG1\CLASS2\ &<cr><br>>>OVERLAY3(15FFH), SEG2(4F5AH))<cr>                                                  |
| Address assignment of groups, segments, and classes can be in any order, unless they are absolute.                                                                                                                                                                                                                                       | <b>BOOTSTRAP</b>           | >LOC86 :F8:IST.LNK TO LOCIST.RDY &<cr><br>>>ADDRESSES(SEGMENTS(SEG1\CLASS1 &<cr><br>>>(23H)), GROUPS(CGROU(00H),DGROU &<cr><br>>>(10000H)), CLASSES(MEMORY(15000H)))<cr> |
| A long jump to GO will be placed at location 0FFFF0H.                                                                                                                                                                                                                                                                                    | <b>COMMENTS/NOCOMMENTS</b> | >LOC86 :F3:TEST.LNK START(GO) &<cr><br>>>BOOTSTRAP<cr>                                                                                                                   |
| The initialization code is placed at address 32768 decimal (8000H).                                                                                                                                                                                                                                                                      | <b>INITCODE/NOINITCODE</b> | >LOC86 :F1:SOURCE.LNK NOCOMMENTS<cr>                                                                                                                                     |
| No initialization code will be produced.                                                                                                                                                                                                                                                                                                 | <b>LINES/NOLINES</b>       | >LOC86 :F1:TEMP.LNK COMMENTS<cr>                                                                                                                                         |
| LINES is the default, so it need not be specified.                                                                                                                                                                                                                                                                                       | <b>MAP/NOMAP</b>           | >LOC86 :F1:FORK.LNK INITCODE(32768)<cr>                                                                                                                                  |
| This statement removes all debug records from the object file, but keeps the information in the print file.                                                                                                                                                                                                                              | <b>NAME</b>                | >LOC86 :F1:TEST.LNK NOINITCODE<cr>                                                                                                                                       |
| NOPUBLICS is implied by PURGE, but PUBLICS overrides it.                                                                                                                                                                                                                                                                                 | <b>OBJECTCONTROLS</b>      | >LOC86 :F1:RUN.LNK NOLINES<cr>                                                                                                                                           |
| SEG@A of CLASS1 will be the first relocatable segment located. SEG@B will be next, followed immediately by any other segments contained within CLASS1. The extra segments in CLASS1 (and all of the segments in CLASS2) are located in the order in which they are encountered. Finally, the list in the SEGMENTS subcontrol is handled. | <b>ORDER</b>               | >LOC86 :F1:TEST.LNK<cr>                                                                                                                                                  |

| Comments                                                                                                              | Control           | Examples                                                                        |
|-----------------------------------------------------------------------------------------------------------------------|-------------------|---------------------------------------------------------------------------------|
| The print file is :F1:TEMP.MP2.                                                                                       | PRINT/NOPRINT     | >LOC86 :F1:PROG.LNK TO &<cr><br>>>:F1:TEMP1.TST PRINT<cr>                       |
| The print file is :F5:INTERPL.MP2.                                                                                    |                   | >LOC86 :F5:INTERP.LNK<cr>                                                       |
| The print file is :F1:MAP.                                                                                            |                   | >LOC86 :F4:PROG.LNK PRINT(:F1:MAP)<cr>                                          |
| Information about line numbers is removed from the print file.                                                        | PRINTCONTROLS     | >LOC86 :F1:LINEAR.LNK &<cr><br>>>PRINTCONTROLS(NOLINES)<cr>                     |
| All but the segment information is removed from the print file.                                                       |                   | >LOC86 :F3:PROG.LNK PRINTCONTROLS &<cr><br>>>(PURGE)<cr>                        |
| No public information is included in the output files (:F7:PRIVAT.MP2 and :F7:PRIVAT).                                | PUBLICS/NOPUBLICS | >LOC86 :F7:PRIVAT.LNK NOPUBLICS<cr>                                             |
| All public symbol information will be included in both the print file and output file.                                |                   | >LOC86 :F9:TEXT.LNK NOPUBLICS &<cr><br>>>PUBLICS<cr>                            |
| The object file contains no public or debug information, and the symbol table does not appear in the print file.      | PURGE/NOPURGE     | >LOC86 :F3:PROJ5.LNK PURGE<cr>                                                  |
| The line and symbol information will be kept in the print file and object file.                                       |                   | >LOC86 :F5:B0209.LNK PURGE &<cr><br>>>PRINTCONTROLS (NOPURGE)<cr>               |
| This control reserves the high order 64K of memory.                                                                   | RESERVE           | >LOC86 :F3:LOWMEM.LNK RESERVE &<cr><br>>>(0F0000H TO 0FFFFFFH)<cr>              |
| A 200H and a 100H section of memory at the top and bottom of memory are reserved.                                     |                   | >LOC86 :F2:HUGOS.LNK RESERVE &<cr><br>>>(00H TO 0200H, 0FFF00H TO 0FFFFFFH)<cr> |
| The size of segment MEMORY will be increased by 2000 bytes.                                                           | SEGSIZE           | >LOC86 :F6:GROW.LNK SEGSIZE &<cr><br>>>(MEMORY(+2000))<cr>                      |
| The size of segment FREUD will be decreased by 511 bytes.                                                             |                   | >LOC86 :F1: SHRINK.LNK SEGSIZE &<cr><br>>>(FREUD(-1FFH))<cr>                    |
| The new segment size for XENDA is 7770 bytes.                                                                         |                   | >LOC86 :F1:RPLACE.LNK SEGSIZE &<cr><br>>>(XENDA(7770))<cr>                      |
| :F9:AUTO will start at IGNITION.                                                                                      | START             | >LOC86 :F9:AUTO.LNK START(IGNITION)<cr>                                         |
| :F7:HALTS will start at location 200H.                                                                                |                   | >LOC86 :F7:HALTS.LNK START(00H,200H)<cr>                                        |
| This statement will include the local symbol records in the object file and the symbol information in the print file. | SYMBOLS/NOSYMBOLS | >LOC86 GESHTA.LNK SYMBOLS<cr>                                                   |
| PURGE is a shorthand for NOSYMBOLS, NOCOMMENTS, NOPUBLICS, and NOLINES.                                               |                   | >LOC86 :F3:TEST.LNK PURGE<cr>                                                   |
| The symbol table will be printed on a line printer. A line printer line can hold a four-column symbol table.          | SYMBOLCOLUMNS     | >LOC86 :F1:TEST.LNK SYMBOLCOLUMNS(1)<cr>                                        |
|                                                                                                                       |                   | >LOC86 :F5:LINKED.LNK &<cr><br>>>SYMBOLCOLUMNS(4) PRINT(:LP:)<cr>               |



## Environmental Considerations

The iAPX 86,88 Family utilities run on and can be used to produce code executable on the iRMX 86-based systems. Resulting code is also compatible with the ICE-86 Emulator and the iSBC 957B Interface and Execution Package.

To run the utilities on an iRMX 86-based system, you must have the following hardware and software:

- The iRMX 86 Human Interface (and other iRMX 86 layers necessary to support the Human Interface).
- At least one mass storage device. The installation of the utilities always requires a single- or double-density diskette drive, since the product is delivered in diskette form.
- Enough memory to run the utilities (above and beyond that required for the Operating System). Table J-1 lists the memory requirements for the individual utilities. The minimum required column indicates the minimum amount of memory needed to run the utilities, assuming connection to only six files. The maximum usable column indicates the largest amount of memory the utilities can use.

**Table J-1. iRMX 86 Memory Requirements**

| Utility | Minimum Required | Maximum Usable |
|---------|------------------|----------------|
| LINK86  | 105K             | 512K           |
| CREF86  | 129K             | 512K           |
| LIB86   | 128K             | 512K           |
| LOC86   | 120K             | 120K           |
| OH86    | 90K              | 90K            |

When you run the utilities on an iRMX 86-based system, you must obey the following conventions:

- To invoke a utility, you must enter the pathname of the file that contains the utility. An example of this is:

```
-:PROG:LOC86 :FD0:PROGDIR/MYPROGRAM.LNK <cr>
```

- The portion of the pathname delimited with colons (:) is an iRMX 86 logical name. A logical name identifies the device that contains the file; in some cases it also identifies a portion of the directory tree. In this example, LOC86 resides in a directory identified by the logical name :PROG:: MYPROGRAM.LNK resides in a subdirectory of a device identified by the logical name :FD0:. If you omit the logical name from the command (in this case, LOC86), the Operating System automatically searches several directories for the command. The directories searched and the order of search are iRMX 86 configuration parameters. If you omit the logical name from a file used as a parameter (in this case PROGDIR/MYPROGRAM.LNK), the Operating System assumes that the file resides in the default directory (:\$:).
- Slashes (/) and up-arrows or circumflexes (^) separate individual components of the pathname. A file's pathname can consist of several components, depending on where the file exists in the overall directory tree. To identify a file, you start with a logical name (or assume the default), continue through the directory tree specifying as many directory names as necessary, and finally specify the name of the file with which you are concerned. You use separators between the individual components of the pathname (except immediately after the logical name). The slash separator tells the Operating System to search down one level in the directory tree for the next component. The circumflex separator tells the Operating System to search up one level in the directory tree. For example, if file TEXTFILE.P86 resides in directory PROGRAMS, and if directory PROGRAMS resides on a device identified by logical name :FD1:, you can identify the file by specifying the following pathname:  
:FD1:PROGRAMS/TEXTFILE.P86
- Continuation lines are necessary when a command or invocation will not fit on one line. The following example illustrates the line-end conventions to use and the continuation characters to expect:

```
-LINK86 :WD1:PROG/TEST.OBJ, :WD1:PROG/SMALL.LIB, &<cr>
**USER.LIB TO :WD1:PROG/TEST BIND<cr>
```

- The LIB86 utility presents an exception to these prompt conventions. Because this program is interactive, it has its own prompts:

```
-LIB86<cr>
iRMX 86 8086 LIBRARIAN Vx.y
*ADD :F1:SEC.LNK, :F1:CSC.LNK | &<cr>
** :F1:TAN.LNK TO :PROG:LIBRARY/TRIG.LIB<cr>
```

## Related Publications

The following manuals may be helpful during various aspects of your work with the iAPX 86, 88 utilities on an iRMX 86-based system:

- *Introduction to the iRMX 86 Operating System*, order number 9803124
- *iRMX 86 Human Interface Reference Manual*, order number 9803202
- *iAPX 86, 88 User's Manual*, order number 210201
- *PASCAL-86 User's Guide*, order number 121539
- *PL/M-86 User's Guide*, order number 121636
- *ASM86 Language Reference Manual*, order number 121703
- *ASM86 Macro Assembler Operating Instructions for 8086-Based Development Systems*, order number 121628
- *FORTRAN-86 User's Guide*, order number 121570



## Generating Code to Run on an iRMX 86-Based System

To generate code that runs on an iRMX 86-based system, perform the following steps:

1. Translate the program into object code by using the appropriate compiler or assembler.
2. Use LINK86 to link the program with other routines or libraries as necessary. When doing this, remember the following:
  - If you wrote your program in FORTRAN or Pascal, or if you invoked specific universal development interface (UDI) calls, you must link your program to the iRMX 86 UDI library that corresponds to the model of segmentation for your program. These libraries are:

| Library    | Model of Segmentation |
|------------|-----------------------|
| URXLRG.LIB | LARGE or MEDIUM       |
| URXCOM.LIB | COMPACT               |
| URXSML.LIB | SMALL                 |

- Do not use FASTLOAD control. Currently, the iRMX 86 Operating System cannot load programs linked with this control.
  - To produce LTL code, use the BIND control. In this case, also specify the MEMPOOL and SEGSIZE controls to allocate memory for the memory pool and stack. If you do not use BIND, you must specify SEGSIZE with the LOC86 command.
3. If you did not specify the BIND control in the LINK86 command, use LOC86 to assign absolute addresses to your program. In order to run this program in an iRMX 86 environment, you must also reserve the program's memory locations during iRMX 86 configuration.
  4. To invoke the program from a terminal, enter the pathname of the file that contains the program's linked (if LTL code) or located object code.

## Program Development Examples

The following examples are programming problems solved by using one or more of the iAPX 86,88 utilities on an iRMX 86-based system.

### Example 1: Using CREF86

Figure J-1 illustrates a CREF86 cross-reference listing for an input list of 15 files, one of which contains several modules. The output print file pathname OUT and a title for the listing were specified in the controls. Although PAGESWIDTH (PW) and PAGESLENGTH (PL) specifications were also noted in the controls, the numbers specified are the same as those provided by default.

```

CREF86 EXAMPLE OF CROSS REFERENCE USING CREF86 MM/DD/YY PAGE 1

iRMX 86 CREF86 Vx.y

INPUT FILES: :F1:ROOT.OBJ :F1:PARSE.OBJ :F1:SIGNON.OBJ :F1:STATE.OBJ :F1:ERROR.OBJ :F1:UTILS.OBJ
 :F1:MEMMAN.OBJ :F1:SCANNR.OBJ :F1:PROCES.OBJ :F1:SCUTIL.OBJ :F1:LIST.OBJ :F1:LSUTIL.OBJ
 :F1:SORT.OBJ :F1:UDSMA.LNK URXCOM.LIB

OUTPUT FILE: OUT

CONTROLS SPECIFIED: PR(OUT) TT(EXAMPLE OF CROSS REFERENCE USING CREF86) PW(120) PL(60)

MODULES INCLUDED:

FILE NAME MODULE NAME(S)

:F1:ROOT.OBJ: CREF86
:F1:PARSE.OBJ: PARSE
:F1:SIGNON.OBJ: SIGNON
:F1:STATE.OBJ: NEXTSTATE
:F1:ERROR.OBJ: ERROR
:F1:UTILS.OBJ: UTILITIES
:F1:MEMMAN.OBJ: MEMORYMANAGEMENT
:F1:SCANNR.OBJ: SCANMODULES
:F1:PROCES.OBJ: PROCESSRECORDS
:F1:SCUTIL.OBJ: SCANUTILITIES
:F1:LIST.OBJ: LISTOUTPUT
:F1:LSUTIL.OBJ: LISTUTILITIES
:F1:SORT.OBJ: SYMBOLSORT
:F1:UDSMA.LNK: OBJMAN
URXCOM.LIB DQALLOCATE DQATTACH DQCHANGEEXTENSION DQCREATE DQCODEEXCEPTION
 DQDETACH DQEXIT DQFREE DQGETARGUMENT DQGETSYSTEMID
 DQGETTIME DQOPEN DQREAD DQSEEK DQWRITE
 SYSTEMSTACK

```

```

CREF86 EXAMPLE OF CROSS REFERENCE USING CREF86 MM/DD/YY PAGE 2

SYMBOL NAME SYMBOL TYPE DEFINING MODULE; REFERRING MODULE(S)

ACCESS_PAGE UNKNOWN OBJMAN
ALLOCATE UNKNOWN OBJMAN
APPENDNODE PROCEDURE NEAR UTILITIES
APPENDUDSMNODE PROCEDURE NEAR UTILITIES;
ARRAYBASE POINTER SYMBOLSORT;
ATOI PROCEDURE WORD NEAR UTILITIES;
BTOX PROCEDURE WORD NEAR UTILITIES;
BUBBLESORTVARNAMES PROCEDURE NEAR SYMBOLSORT;
BUMPLINECOUNT PROCEDURE NEAR LISTUTILITIES;
CHECKHEADER PROCEDURE NEAR SCANUTILITIES;
CHECKOVERLAY PROCEDURE NEAR SCANUTILITIES;
CHECKVARTYPE PROCEDURE BYTE NEAR SCANUTILITIES;

```

```

CREF86 EXAMPLE OF CROSS REFERENCE USING CREF86 MM/DD/YY PAGE 6

UNLOAD_PAGE UNKNOWN OBJMAN
VARAREAP POINTER MEMORYMANAGEMENT;
VBLOCKLISTHEADER WORD PROCESSRECORDS;
WARNING PROCEDURE NEAR ERROR;
WRITEDATA PROCEDURE NEAR LISTUTILITIES;
WRITEINITLINEBUF PROCEDURE NEAR LISTUTILITIES;
WRITEBLINE PROCEDURE NEAR LISTUTILITIES;
WRITENEWLINE PROCEDURE NEAR LISTUTILITIES;
WRITETOCOMMANDBUF PROCEDURE NEAR PARSE
WRITETOFILE PROCEDURE NEAR LISTUTILITIES;
ZERO WORD UTILITIES

```

Figure J-1. CREF86 Cross-Reference Listing

## Example 2: Building and Using Library Files

A library is a file that contains object modules. Libraries allow you to collect commonly-used pieces of software into one file. The library file can be included in a LINK86 invocation, and LINK86 will use the modules to resolve references.

You can add the output from a translator, LINK86, or LOC86 to a library. The modules added may be relocatable or absolute; they can have unresolved references or be completely linked.

Let's consider the following scenario—we have created six routines (SINE, COSINE, TANGENT, COSECANT, SECANT, and COTANGENT). We want to create a library file that will allow each routine to be linked to programs separately.

The first step necessary to create the library is to translate each routine separately. If we were to put them in a single source module, the translator would translate them into one module with six public symbols. We could add this module to a library, but when we tried to link one of the routines into a program, all six would be included.

Once the routines are translated, LIB86 can be used to create a library file and add modules. The LIST command is used to display the contents of the library and the publics contained within it.

```

- LIB86<cr>
iRMX 86 8086 LIBRARIAN Vx.y
*CREATE :PROG:LIBRARY/TRIG.LIB<cr>
*ADD :FDO:SIN.OBJ, :FDO:COS.OBJ TO :PROG:LIBRARY/TRIG.LIB<cr>
*LIST :PROG:LIBRARY/TRIG.LIB PUBLICS<cr>
:PROG:LIBRARY/TRIG.LIB
SIN
SINE
COS
COSINE
*ADD :FDO:SEC.LNK, :FDO:.CSC.LNK, :FDO:COT.LNK, &<cr>
**FDO:TAN.LNK TO :PROG:LIBRARY/TRIG.LIB <cr>
*LIST :PROG:LIBRARY/TRIG.LIB PUBLICS<cr>
:PROG:LIBRARY/TRIG.LIB
SIN
SINE
COS
COSINE
SEC
SECANT
CSC
COSECANT
COT
COTANGENT
TAN
TANGENT
*EXIT<cr>

```

### Example 3: Linking and Locating Programs with Overlays Using OVERLAY Control

The easiest way to build an 8086 program that contains overlays is with LINK86's OVERLAY control. Overlay modules built with this control reside in the same file as the root. The operating system supplies routines that will load the overlays constructed in this way. See the *iRMX 86 Loader Reference Manual* or the *Run-Time Support Manual for iAPX 86,88 Applications*.

After the program modules that will constitute the root and its overlays are translated, each of the overlays and the root must be linked separately. Then the root and all of the overlays are linked together.

The example following shows the first step toward linking overlays—linking all of the modules that will constitute each overlay and the root separately:

```
-LINK86 OV1.OBJ, OV1A.OBJ, OV1B.OBJ &<cr>
**OVERLAY(OVERLAY1)<cr>

-LINK86 OV2.OBJ, OV2B.OBJ, OV2C.OBJ &<cr>
**OVERLAY(OVERLAY2)<cr>

-LINK86 OV3.OBJ, OV3A.OBJ OVERLAY(OVERLAY3)<cr>

-LINK86 OV4.OBJ, OV4A.OBJ OVERLAY(OVERLAY4)<cr>

-LINK86 ROOT.OBJ, ROOTA.OBJ, ROOTB.OBJ, &<cr>
**URXSM.LIB OVERLAY(ROOT)<cr>
```

Notice that all of the modules, including the root, are linked with the OVERLAY and NOBIND controls. The overlay name for the root is not as critical as for the overlays, since the overlay name is used when calling the loader.

Finally, the overlays and root must be linked together. Since any one of the files could be the root, LINK86 requires for the final link the file containing the root must be first in the input list. During this final link, the OVERLAY control is not used:

```
-LINK86 ROOT.LNK, OV1.LNK, OV2.LNK, OV3.LNK, &<cr>
**OV4.LNK TO PROG.86 BIND<cr>
```

In the invocation, the BIND control is specified. The resulting object file is executable on an iRMX 86-based system.

Figure J-2 shows the LINK86 print file listing for the previous invocation.

There is nothing special about the invocation line to LOC86 when locating a file that contains overlays or that has been bound:

```
-LOC86 PROG.86 RESERVE (0H TO 77FFH, &<cr>
**0FC000H TO 0FFFFFFH)<cr>
```

The RESERVE control prevents LOC86 from assigning memory addresses reserved for the Operating System. However, the values you enter with the RESERVE control must depend on the size and location of your Operating System and other application software. Figure J-3 illustrates the printout from this invocation.

```

1RMX 86 8086 LINKER.Vx.y

INPUT FILES: ROOT.LNK, OV1.LNK, OV2.LNK, OV3.LNK, OV4.LNK
OUTPUT FILE: PROG.86
CONTROLS SPECIFIED IN INVOCATION COMMAND:
 BIND
DATE: MM/DD/YY TIME:

LINK MAP OF MODULE ROOT

LOGICAL SEGMENTS INCLUDED:
LENGTH ADDRESS ALIGN SEGMENT CLASS OVERLAY
3CE7H ----- G CODE CODE ROOT
0D00H ----- G CONST CONST ROOT
2840H ----- G DATA DATA ROOT

INPUT MODULES INCLUDED:
ROOT.LNK(ROOT)
OV1.LNK(PARSE)
OV2.LNK(ILUDE)
OV3.LNK(PICILUDE)
OV4.LNK(FASTLOAD)

GROUP MAP

GROUP NAME: CGROUP
OFFSET SEGMENT NAME
0000H CODE\CODE\ROOT
3CE8H CODE\CODE\PASS1
3CE6H CODE\CODE\PASS2

SYMBOL TABLE OF MODULE ROOT

BASE OFFSET TYPE SYMBOL BASE OFFSET TYPE SYMBOL
G(2) 251CH PUB ACTUAL G(2) 0F0DH PUB ASSUMEROOTCONTRO
-L
G(2) 0F22H PUB BASEFIXUPSEXIST G(2) 0F0CH PUB BINDCONTROL
G(2) 0D26H PUB bNODEID G(2) 24EAH PUB BUFEASE
G(2) 0D28H PUB CLASHNODEID G(2) 0D5AH PUB COCONN
G(2) 0F00H PUB COMMENTSCONTROL G(2) 0F50H PUB CURRENTFILNUM
G(2) 0F1AH PUB CURRENTOVERLAYNU G(2) 0F8EH PUB CURRENTRECINDEX
-M

OVERLAY NAME = ROOT, MODULE NAME = ROOT

BASE OFFSET TYPE SYMBOL BASE OFFSET TYPE SYMBOL
G(2) 4A20H SYM MEMORY G(2) 0002H SYM COPYRIGHT
G(2) 0D00H SYM LASTNMNODEID G(2) 0D02H SYM FIRSTNMNODEID
G(2) 0D04H SYM LASTSGNODEID G(2) 0D06H SYM FIRSTSGNODEID
G(2) 0D08H SYM LASTIDNODEID G(2) 0D0AH SYM FIRSTIDNODEID
G(2) 0D0CH SYM LASTEXNODEID G(2) 0D0EH SYM FIRSTEXNODEID
G(2) 0D10H SYM LASTGRNODEID G(2) 0D12H SYM FIRSTGRNODEID
G(2) 0D14H SYM LASTOVNODEID G(2) 0D16H SYM FIRSTOVNODEID
G(2) 0D18H SYM LASTGNODEID G(2) 0D1AH SYM FIRSTBNODEID

OVERLAY NAME = ROOT, MODULE NAME = LIT

BASE OFFSET TYPE SYMBOL BASE OFFSET TYPE SYMBOL
G(2) 4A20H SYM MEMORY G(2) 003CH BAS SGNODE
G(2) 0F56H SYM LITBASE G(2) 0F58H SYM LITID
G(2) 0F56H BAS LITNODE G(2) 0F5AH SYM FIRSTNODEIDS
G(2) 0F64H SYM FIRSTNODE G(2) 0F6EH SYM CURRENTRECINDEX
G(2) 0F96H SYM TEMPLATE G(2) 0F89H SYM II
G(1) 016EH SYM GETLIT STACK 0006H SYM INDEX
STACK 0004H SYM I G(1) 0207H SYM SGLIT

```

Figure J-2. LINK86 Listing for Program with Overlays

```

1RMX 86 8086 LOCATOR, Vx.y

INPUT FILE: PROG.66
OUTPUT FILE: PROG
CONTROLS SPECIFIED IN INVOCATION COMMAND:
 RESERVE(OH TO 77FFH,0FC000H TO 0FFFFH)
DATE: MM/DD/YY TIME:

SYMBOL TABLE OF MODULE ROOT

BASE OFFSET TYPE SYMBOL BASE OFFSET TYPE SYMBOL
1034H 251CH PUB ACTUAL 1034H 0F0DH PUB ASSUMEROOTCONTRO
 -L
1034H 0F22H PUB BASEFIXUPSEXIST 1034H 0F0CH PUB BINDCONTROL
1034H 0D26H PUB BNODEID 1034H 24EAH PUB BUFBASE
1034H 0D28H PUB CLASHNODEID 1034H 0D5AH PUB COCONN
1034H 0F00H PUB COMMENTSCONTROL 1034H 0F50H PUB CURRENTFILNUM
1034H 0F1AH PUB CURRENTOVERLAYNU 1034H 0F8EH PUB CURRENTRECINDEX
 -M

```

```

OVERLAY = ROOT, MODULE = ROOT

BASE OFFSET TYPE SYMBOL BASE OFFSET TYPE SYMBOL
1034H 4A20H SYM MEMORY 1034H 0002H SYM COPYRIGHT
1034H 0D00H SYM LASTNMNODEID 1034H 0D02H SYM FIRSTNMNODEID
1034H 0D04H SYM LASTSGNODEID 1034H 0D06H SYM FIRSTSGNODEID
1034H 0D08H SYM LASTTDNODEID 1034H 0D0AH SYM FIRSTTDNODEID
1034H 0D0CH SYM LASTEXNODEID 1034H 0D0EH SYM FIRSTEXNODEID
1034H 0D10H SYM LASTGRNODEID 1034H 0D12H SYM FIRSTGRNODEID
1034H 0D14H SYM LASTOVNODEID 1034H 0D16H SYM FIRSTOVNODEID
1034H 0D18H SYM LASTBNODEID 1034H 0D1AH SYM FIRSTBNODEID
1034H 0D1CH SYM SGNODEID 1034H 0D1EH SYM GRNODEID

```

```

OVERLAY = ROOT, MODULE = LIT

BASE OFFSET TYPE SYMBOL BASE OFFSET TYPE SYMBOL
1034H 4A20H SYM MEMORY 1034H 003CH SYM SGNODE
1034H 0F56H SYM LITBASE 1034H 0F58H SYM LITLD
1034H 0F56H SYM LITNODE 1034H 0F5AH SYM FIRSTNODEIDS
1034H 0F64H SYM FIRSTNODE 1034H 0F6EH SYM CURRENTRECINDEX
1034H 0F96H SYM TEMPLATE 1034H 0F89H SYM II
0780H 016EH SYM GETLIT STACK 0006H SYM INDEX
STACK 0004H SYM I 0760H 0207H SYM SGLIT

```

```

MEMORY MAP OF MODULE ROOT

MODULE START ADDRESS PARAGRAPH = 14D6H OFFSET = 0006H
SEGMENT MAP

START STOP LENGTH ALIGN NAME CLASS OVERLAY
07800H 0B4E6H 3CE7H M CODE CODE ROOT
0B4E8H 0F9BAH 44D3H M CODE CODE PASS1
0B4E8H 0E0CEH 2BE7H M CODE CODE PASS2
0B4E8H 10337H 4E50H M CODE CODE PIC_PASS2

```

```

GROUP MAP

ADDRESS GROUP OR SEGMENT NAME
07800H CGROUP
 CODE\CODE\ROOT
 CODE\CODE\PASS1
 CODE\CODE\PASS2
 CODE\CODE\PIC_PASS2
 CODE\CODE\FASTLOAD
10340H DGROUP
 CONST\CONST\ROOT
 DATA\DATA\ROOT
 STACK\STACK\

```

Figure J-3. LOC86 Listing for Program with Overlays

## Example 4: Linking and Locating Programs with Overlays Without OVERLAY Control

It is harder to produce overlay modules without using the OVERLAY control. However, sometimes it is necessary to build programs in this way, for example, building a program for running under an operating system that does not support overlay modules contained in the same file as the root module.

But regardless of the reason, building overlays in this fashion places an extra burden on the programmer. He must do some of the work that would be left to LINK86 (and LOC86) if he were to use the OVERLAY control. In the following example we prepare a root and two overlay modules in separate files.

First we must compile all modules. Examples of the invocation lines are shown below:

```
-PLM86 :F1:ROOT.SRC SMALL<cr>
```

```
-PLM86 :F1:OV1.SRC SMALL<cr>
```

```
-PLM86 :F1:OV2.SRC SMALL<cr>
```

In the next step we must link the root module to resolve external symbols with a library and to obtain a link map:

```
-LINK86 :F1:ROOT.OBJ,USER.LIB MAP<cr>
```

We will need the link map for locating purposes. The link map, shown in figure J-4, shows the size of each segment in the root. Since the overlays are self-contained except for references to the root, we do not need a link map for them. The PL/M-86 listing files will show the size of each overlay's segments, as illustrated in figure J-5.

Note that the length of the root's code segment and OV1's code segment must fit within 64K. This means that the code for the overlays must be in a part of memory contiguous with the root (to avoid altering the CS register during execution). OV2's CONST and DATA segments are larger than OV1's so that the STACK segment must be placed to leave room for OV2's CONST and DATA segments. If the overlays share the STACK and MEMORY segments with the root, they must be located at the same address.

```

1RMX 86 8086 LINKER, V.x.y

INPUT FILES: :F1:ROOT.OBJ,USER.LIB
OUTPUT FILE: :F1:ROOT.LNK
CONTROLS SPECIFIED IN INVOCATION COMMAND:
MAP
DATE: MM/DD/YY TIME:

LINK MAP OF MODULE LOANER

LOGICAL SEGMENTS INCLUDED:
LENGTH ADDRESS ALIGN SEGMENT CLASS OVERLAY
8A9BH ----- W CODE CODE
0381H ----- W CONST CONST
0291H ----- W DATA DATA
0030H ----- W STACK STACK
0000H ----- W MEMORY MEMORY

INPUT MODULES INCLUDED:
:F1:ROOT.OBJ(ROOT)
:FO:USER.LIB(LOADER)
:FO:USER.LIB(EXIT)
:FO:USER.LIB(ERROR)
:FO:USER.LIB(TIME)

```

Figure J-4. LINK86 Map for Root File

```

 OV1's segment size information
MODULE INFORMATION:
 CODE AREA SIZE = 7531H 30001D this is the CODE segment
 CONSTANT AREA SIZE = 0081H 129D this is the CONST segment
 VARIABLE AREA SIZE = 0181H 385D this is the DATA segment
 MAXIMUM STACK SIZE = 0040H 64D this is the STACK segment
 918 LINES READ
 0 PROGRAM ERROR(S)
END OF PL/M-86 COMPILATION

```

```

 OV2's segment size information
MODULE INFORMATION
 CODE AREA SIZE = 1B9AH 7066D this is the CODE segment
 CONSTANT AREA SIZE = 0101H 257D this is the CONST segment
 VARIABLE AREA SIZE = 0454H 1108D this is the DATA segment
 MAXIMUM STACK SIZE = 0067H 103D this is the STACK segment
 918 LINES READ
 0 PROGRAM ERROR(S)
END OF PL/M-86 COMPILATION

```

Figure J-5. Module Information for Overlays

After computing the required location for the root's DGROUPE and STACK, we can locate the root module. The resulting file will not be executable, but it allows us to resolve references to the root's code and data symbols in the overlays. The following LOC86 invocation will leave room for the overlays' code segments and place the DGROUPE in the first unused memory location. (In the command line below, the DS register is initialized to 0FFCEH, and the CS register is initialized to 0.) The STACK and MEMORY segments will be located above OV2's DATA segment:

```

-LOC86 :F1:ROOT.LNK &<cr>
**ADDRESSES(GROUPS(CGROUPE(0H),DGROUPE(0FFCEH)), &<cr>
** SEGMENTS(CODE(0H),CONST(0FFCEH),STACK(10B34H))) &<cr>
**ORDER(SEGMENTS(CODE,CONST,DATA,STACK,MEMORY)) &<cr>
**SEGSIZE(STACK(100H))<cr>

```

Once the root is located, we can use it to resolve external references in the overlay modules. The overlay modules cannot call each other, since only one is resident in memory at any time. The link commands are shown below. The NOPUBLICS with the EXCEPT control is used to avoid conflicts when we use the located overlays to resolve external references in the root:

```

-LINK86 :F1:OV1.OBJ,PUBLICSONLY(:F1:ROOT) &<cr>
**NOPUBLICS EXCEPT(OV1CODE, OV1DATA)<cr>

-LINK86 :F1:OV2.OBJ,PUBLICSONLY(:F1:ROOT) &<cr>
**NOPUBLICS EXCEPT(OV2CODE, OV2DATA)<cr>

```

The PUBLICSONLY control resolves references to public symbols contained in the root.



After the overlays have been linked, they must be located. The code and data segments must be placed in the memory locations that were reserved when we first located the root. In this case the STACK and MEMORY segments must be the same for the overlays and the root:

```
-LOC86 :F1:OV1.LNK &<cr>
**ADDRESSES(GROUPS(CGROUP(0H),DGROUP(0FFCEH)), &<cr>
** SEGMENTS(CODE(8A9CH),CONST(105E0H),STACK(10B34H))) &<cr>
**ORDER(SEGMENTS(CODE,CONST,STACK,MEMORY)) &<cr>
**SEGSIZE(STACK(100H))<cr>
```

```
-LOC86 :F1:OV2.LNK &<cr>
**ADDRESSES(GROUPS(CGROUP(0H),DGROUP(0FFCEH)), &<cr>
** SEGMENTS(CODE(8A9CH),CONST(105E0H),STACK(10B34H))) &<cr>
**ORDER(SEGMENTS(CODE,CONST,DATA,STACK,MEMORY)) &<cr>
**SEGSIZE(STACK(100H))<cr>
```

The CGROUP and DGROUP base address must be specified in order to compute offset information. The final base address assigned to DGROUP by LOC86 will be rounded down to 0FFC0H.

Once the overlays are located, the root is linked and located into an executable form. The PUBLICSONLY control will resolve references to symbols in the overlay modules. Other than the addition of this input control, the LINK86 and LOC86 command must be identical to those used previously:

```
-LINK86 :F1:ROOT.OBJ,USER.LIB, &<cr>
**PUBLICSONLY(:F1:OV1,:F1:OV2)<cr>
```

```
-LOC86 :F1:ROOT.LNK &<cr>
**ADDRESSES(GROUPS(CGROUP(0H),DGROUP(0FFCEH)), &<cr>
** SEGMENTS(CODE(0H),CONST(0FFCEH),STACK(10B34H))) &<cr>
**ORDER(SEGMENTS(CODE,CONST,DATA,STACK,MEMORY)) &<cr>
**SEGSIZE(STACK(100H))<cr>
```

The executable forms of the root and its overlay files are contained in :F1:ROOT, :F1:OV1, and :F1:OV2. Figure J-6 shows the resulting layout of memory.

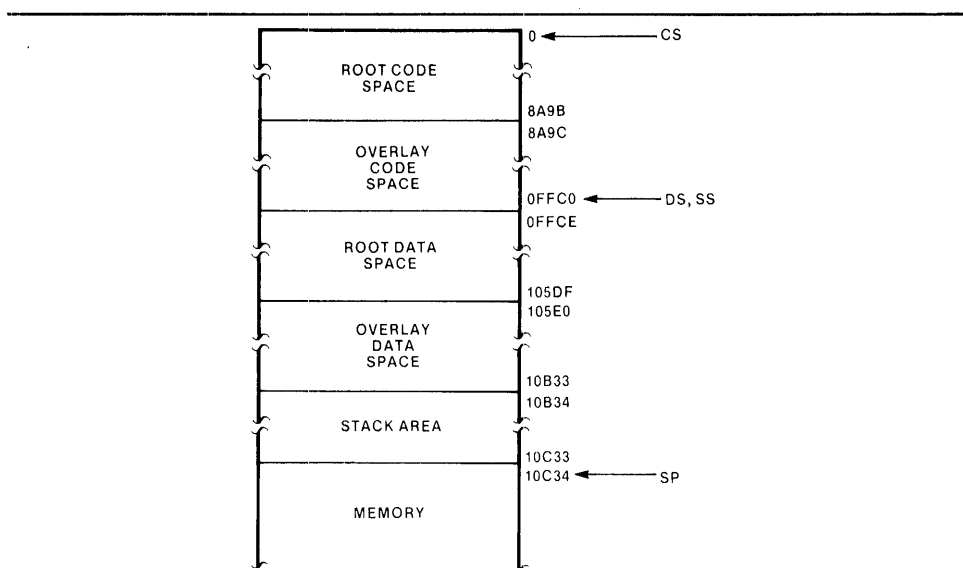

Figure J-6. Memory Organization for Example 4

121616-10

## Invocation Examples

The following foldout pages contain examples of the iAPX 86,88 Family utility controls and commands. The examples may be used in conjunction with syntax specifications given:

- In Chapter 2 for LINK86
- In Chapter 3 for CREF86
- In Chapter 4 for LIB86
- In Chapter 5 for LOC86

When using the directions in these chapters, fold out the page in this appendix containing examples of the command or control in which you are interested.

The following is a sample iRMX 86 OH86 invocation:

```
-OH86 :FD0:FINALPROGRAM to :FD0:FINISH.HEX<cr>
```

| Comments                                                                                                                                                                    | Control             | Examples                                                                                                                                                                                                                                                                                                                                                                                                                        |
|-----------------------------------------------------------------------------------------------------------------------------------------------------------------------------|---------------------|---------------------------------------------------------------------------------------------------------------------------------------------------------------------------------------------------------------------------------------------------------------------------------------------------------------------------------------------------------------------------------------------------------------------------------|
| This example defines two public symbols, VARONE and VARTWO, with absolute addresses 50H and 2000H, respectively.                                                            | ASSIGN              | <pre>-LINK86 FILE1, FILE2, FILE3 &amp;&lt;cr&gt; **ASSIGN (VARONE(50H), &amp;&lt;cr&gt; **VARTWO(2000))&lt;cr&gt;</pre>                                                                                                                                                                                                                                                                                                         |
| In this example, the root file is RTFILE, and LIB1 and LIB2 are library files.                                                                                              | ASSUMEROOT          | <pre>-LINK86 ROOT1.OBJ, ROOT2.OBJ, &amp;&lt;cr&gt; **LIB1, LIB2 TO RTFILE OVERLAY&lt;cr&gt;  -LINK86 OV11.OBJ, OV12.OBJ, &amp;&lt;cr&gt; **LIB1, LIB2 TO OV1.OBJ &amp;&lt;cr&gt; **OVERLAY ASSUMEROOT(RTFILE)&lt;cr&gt;  -LINK86 OV21.OBJ, OV22.OBJ, &amp;&lt;cr&gt; **LIB1, LIB2 TO OV2.OBJ &amp;&lt;cr&gt; **OVERLAY ASSUMEROOT(RTFILE)&lt;cr&gt;  -LINK86 RTFILE, OV1.OBJ, &amp;&lt;cr&gt; **OV2.OBJ TO PROG&lt;cr&gt;</pre> |
| This line creates an LTL module. The output object file is :FD0:TEST with no extension.                                                                                     | BIND/NOBIND         | <pre>-LINK86 :FD0:TEST.OBJ, &amp;&lt;cr&gt; **:PROG:LIBRARY/USER.LIB &amp;&lt;cr&gt; **BIND PRINT&lt;cr&gt;  -LINK86 :SYSTEM:GENERAL.OBJ &amp;&lt;cr&gt; **NOBIND&lt;cr&gt;</pre>                                                                                                                                                                                                                                               |
| This example specifies default to avoid ambiguity.                                                                                                                          | COMMENTS/NOCOMMENTS | <pre>-LINK86 :F1:SOURCE.OBJ &amp;&lt;cr&gt; **NOCOMMENTS&lt;cr&gt;  -LINK86 :WD0:SYSTEM/PROG.OBJ &amp;&lt;cr&gt; **TO :WD0:SYSTEM/TEMP.TST &amp;&lt;cr&gt; **COMMENTS&lt;cr&gt;</pre>                                                                                                                                                                                                                                           |
| Do not use the FASTLOAD control when producing code for an iRMX environment.                                                                                                | FASTLOAD/NOFASTLOAD | <pre>-LINK86 PROG.OBJ, LIB1, LIB2 &amp;&lt;cr&gt; **BIND FASTLOAD&lt;cr&gt;</pre>                                                                                                                                                                                                                                                                                                                                               |
|                                                                                                                                                                             | INITCODE            | <pre>-LINK86 :PROG:MYPROG INITCODE&lt;cr&gt;</pre>                                                                                                                                                                                                                                                                                                                                                                              |
| LINES is the default, so it need not be specified.                                                                                                                          | LINES/NOLINES       | <pre>-LINK86 :F1:TEST/RN.OBJ NOLINES&lt;cr&gt;  -LINK86 :F1:TEST/RN.OBJ LINES&lt;cr&gt;</pre>                                                                                                                                                                                                                                                                                                                                   |
| This MEMPOOL example will increase the minimum dynamic memory requirements by 20H bytes, and by default the maximum size will increase, if necessary, to equal the minimum. | MAP/NOMAP           | <pre>-LINK86 :F1:TESTER.OBJ MAP&lt;cr&gt;  -LINK86 :FD1:MAIN.OBJ, &amp;&lt;cr&gt; **:PROG:USER.OBJ, &amp;&lt;cr&gt; **PUBLICONLY(:FD0:8087.LOC) &amp;&lt;cr&gt; **NOMAP&lt;cr&gt;</pre>                                                                                                                                                                                                                                         |
| The minimum dynamic memory requirement is 100H. The maximum dynamic memory requirement is 300H.                                                                             | MEMPOOL             | <pre>-LINK86 :FD0:TEST.OBJ, &amp;&lt;cr&gt; **USER.LIB, PASCAL.LIB BIND &amp;&lt;cr&gt; **MEMPOOL(+20H)&lt;cr&gt;  -LINK86 :WD0:USER/TEST.OBJ &amp;&lt;cr&gt; **MEMPOOL(100H, +200H) BIND&lt;cr&gt;</pre>                                                                                                                                                                                                                       |

| Comments                                                                                              | Control           | Examples                                                                                                                                                                                                                                                                                                                                                                                                                                                                                                                                                                                                                                      |
|-------------------------------------------------------------------------------------------------------|-------------------|-----------------------------------------------------------------------------------------------------------------------------------------------------------------------------------------------------------------------------------------------------------------------------------------------------------------------------------------------------------------------------------------------------------------------------------------------------------------------------------------------------------------------------------------------------------------------------------------------------------------------------------------------|
| The LINK86 output module will have the name specified in parentheses in the control.                  | NAME              | <pre>-LINK86 :USER:TOM.LBJ, &amp;&lt;cr&gt; **/SYS.LIB NAME &amp;&lt;cr&gt; **(THIS IS A VERY LONG MODULE@NAME.)&lt;cr&gt;</pre>                                                                                                                                                                                                                                                                                                                                                                                                                                                                                                              |
| This example removes all debug and public records from the object file.                               | OBJECTCONTROLS    | <pre>-LINK86 :F1:SRC1.OBJ, &amp;&lt;cr&gt; **:F1:SRC2,OBJ, :WD0:USER.LIB &amp;&lt;cr&gt; **NAME(TEST 5.3)&lt;cr&gt;</pre> <pre>-LINK86 :F1:FINAL, &amp;&lt;cr&gt; **:FD1:USER.LIB, SYS.LIB &amp;&lt;cr&gt; **OBJECTCONTROLS(PURGE)&lt;cr&gt;</pre>                                                                                                                                                                                                                                                                                                                                                                                            |
| The EXCEPT in the NOPUBLICS overrides the PURGE.                                                      | ORDER             | <pre>-LINK86 :PROG:PASCL1.OBJ &amp;&lt;cr&gt; **OBJECTCONTROLS(PURGE, &amp;&lt;cr&gt; **NOPUBLICS EXCEPT(START, &amp;&lt;cr&gt; **DATA1, DATA2))&lt;cr&gt;</pre>                                                                                                                                                                                                                                                                                                                                                                                                                                                                              |
| This use of ORDER specifies the order of segments for two groups.                                     | OVERLAY/NOOVERLAY | <pre>-LINK86 :F1:PLMPRG.OBJ, &amp;&lt;cr&gt; **PLM.LIB, URXSM.LIB, &amp;&lt;cr&gt; **USER.LIB ORDER(DGROUP &amp;&lt;cr&gt; **(SEG1, SEG2\CLASS1, &amp;&lt;cr&gt; **SEG2\CLASS1\OVERLAY1), &amp;&lt;cr&gt; **CGROUP(CSEG1, CSEG2, &amp;&lt;cr&gt; **CSEG3))&lt;cr&gt;</pre> <pre>-LINK86 FILE1, FILE2, FILE3 &amp;&lt;cr&gt; **TO :FD0:OV1.LNK &amp;&lt;cr&gt; **OVERLAY(OVERLAY1)&lt;cr&gt;</pre> <pre>-LINK86 FILE4, FILE5, FILE6 &amp;&lt;cr&gt; **TO :FD0:OV2.LNK &amp;&lt;cr&gt; **OVERLAY(OVERLAY2)&lt;cr&gt;</pre> <pre>-LINK86 FILE7, FILE8, FILE9 &amp;&lt;cr&gt; **TO :FD0:ROOT.LNK OVERLAY &amp;&lt;cr&gt; **(ROOT)&lt;cr&gt;</pre> |
| This example will create an overlay record. The name of the overlay will be OVERLAY1.                 | PRINT/NOPRINT     | <pre>-LINK86 :FD0:ROOT.LNK, &amp;&lt;cr&gt; **:FD0:OV1.LNK, :FD0:OV2.LNK&lt;cr&gt;</pre> <pre>-LINK86 :FD0:USER/PROG.OBJ &amp;&lt;cr&gt; **TO :FD0:USER/TEMP1.TST &amp;&lt;cr&gt; **PRINT&lt;cr&gt;</pre> <pre>-LINK86 :F1:PROG.OBJ&lt;cr&gt;</pre> <pre>-LINK86 :PROG:PROG.OBJ, &amp;&lt;cr&gt; **:PROG:USER.LIB PRINT &amp;&lt;cr&gt; **(:F1:THE.MAP)&lt;cr&gt;</pre>                                                                                                                                                                                                                                                                       |
| First the constituent files must be linked to form overlays.                                          | PRINT CONTROLS    | <pre>-LINK86 :WD0:TEMP.OBJ BIND &amp;&lt;cr&gt; **PRINTCONTROLS(NOLINES, &amp;&lt;cr&gt; **NOCOMMENTS, NOSYMBOLS)&lt;cr&gt;</pre> <pre>-LINK86 :WD0:PASCL1.OBJ &amp;&lt;cr&gt; **PRINTCONTROLS(PURGE)&lt;cr&gt;</pre>                                                                                                                                                                                                                                                                                                                                                                                                                         |
| The print file is :FD0:USER/TEMP1.MP1.                                                                |                   |                                                                                                                                                                                                                                                                                                                                                                                                                                                                                                                                                                                                                                               |
| The print file is :F1:PROG.MP1.                                                                       |                   |                                                                                                                                                                                                                                                                                                                                                                                                                                                                                                                                                                                                                                               |
| The print file is :F1:THE.MAP.                                                                        |                   |                                                                                                                                                                                                                                                                                                                                                                                                                                                                                                                                                                                                                                               |
| This example removes information about line numbers, local symbols, and comments from the print file. |                   |                                                                                                                                                                                                                                                                                                                                                                                                                                                                                                                                                                                                                                               |
| This statement removes all but the segment information and error messages from the print file.        |                   |                                                                                                                                                                                                                                                                                                                                                                                                                                                                                                                                                                                                                                               |

| Comments                                                                                                                                     | Control                  | Examples                                                                                                                                                 |
|----------------------------------------------------------------------------------------------------------------------------------------------|--------------------------|----------------------------------------------------------------------------------------------------------------------------------------------------------|
| Public information concerning only DATA1, DATA2, LABEL3, and PROC4 is placed in the object file and print file.                              | <b>PUBLICS/NOPUBLICS</b> | -LINK86 :F1:TEST.OBJ, &<cr><br>**USER.LIB NOPUBLICS EXCEPT &<cr><br>**(DATA1, DATA2, LABEL3, PROC4)<cr>                                                  |
| All public symbol information will be included in the print file and output file.                                                            | <b>PUBLICSONLY</b>       | -LINK86 :F2:TEMP.OBJ, &<cr><br>**URXSML.LIB, USER.LIB PUBLICS<cr>                                                                                        |
| This example will produce a file containing only the absolute public symbol records from :F1:8087.LOC. The object file will be :F1:8087.LNK. | <b>PUBLICSONLY</b>       | -LINK86 PUBLICSONLY &<cr><br>**(:F1:8087.LOC)<cr>                                                                                                        |
| This will resolve the references in ROOT.OBJ to absolute public symbols in the separately linked and located overlays OV1 and OV2.           | <b>PUBLICSONLY</b>       | -LINK86 :F1:ROOT.OBJ, &<cr><br>**PUBLICSONLY(:F1:OV1, :F1:OV2)<cr>                                                                                       |
| This produces an object file containing no debug or public information.                                                                      | <b>PURGE/NOPURGE</b>     | -LINK86 :F1:INDEX.OBJ PURGE<cr>                                                                                                                          |
| This confirms that the line and symbol information should be kept in the print file.                                                         | <b>PURGE/NOPURGE</b>     | -LINK86 :WD0:FINAL.OBJ &<cr><br>**PRINTCONTROLS(NOPURGE)<cr>                                                                                             |
| This will change the translator-assigned name CGROUP to THE@CODE. A subsequent linkage would not combine THE@CODE with a group named CGROUP. | <b>RENAMEGROUPS</b>      | -LINK86 :F1:PLMPRG.OBJ &<cr><br>**RENAMEGROUPS(CGROUP TO <cr><br>**THE@CODE)<cr>                                                                         |
| This changes the name of the CODE group to CGROUP.                                                                                           | <b>RENAMEGROUPS</b>      | -LINK86 :WD1:ASMPRG.OBJ &<cr><br>**RENAMEGROUPS(CODE TO CGROUP)<cr>                                                                                      |
| This tells the loader that 15FFH bytes of code is the minimum requirement for MEMORY. The new maximum size of MEMORY is 35FFH.               | <b>SEGSIZE</b>           | -LINK86 :FD1:GEORGE.OBJ, &<cr><br>**USER.LIB, SYSTEM.LIB BIND &<cr><br>**SEGSIZE(MEMORY (15FFH, &<cr><br>**+2000H))<cr>                                  |
| This increments MEMORY's minimum size by 1FFH (7951D) bytes. The maximum size of MEMORY is equal to the old minimum size plus 3FEH (15902D). | <b>SEGSIZE</b>           | -LINK86 :WFD0:PROJECT.OBJ, &<cr><br>**:WD0:REST.LIB SEGSIZE &<cr><br>**(MEMORY(+1FF, +1FF))<cr>                                                          |
| The local symbol records will be included in the object file.                                                                                | <b>SYMBOLS/NOSYMBOLS</b> | -LINK86 :F1:TEMP.OBJ, &<cr><br>**:F1:USER.LIB NOSYMBOLS &<cr><br>**SYMBOLS<cr>                                                                           |
| PURGE is a shorthand for NOSYMBOLS, NOCOMMENTS, NOPUBLICS, NOTYPE, and NOLINES.                                                              | <b>SYMBOLS/NOSYMBOLS</b> | -LINK86 :FD0:TEST.OBJ, &<cr><br>**:FD1:SYSTEM/USER.LIB &<cr><br>**PURGE<cr>                                                                              |
| SYMBOLCOLUMNS has no effect, since BIND was not specified.                                                                                   | <b>SYMBOLCOLUMNS</b>     | -LINK86 :F1:TEST.OBJ &<cr><br>**SYMBOLCOLUMNS(1)<cr>                                                                                                     |
| The symbol table will be printed on a line printer.                                                                                          | <b>SYMBOLCOLUMNS</b>     | -LINK86 :F1:ROOT.LNK, &<cr><br>**:F1:OV1.LNK, :F1:OV2.LNK, &<cr><br>**PUBLICSONLY(:WD1:8087) &<cr><br>**SYMBOLCOLUMNS(4) BIND &<cr><br>**PRINT(:LP:)<cr> |
| LIBMOD will retain its type information.                                                                                                     | <b>TYPE/NOTYPE</b>       | -LINK86 :F1:LIBMOD.OBJ TYPE<cr>                                                                                                                          |

| Comments                                                                                                                                           | Control    | Examples                                                                                                                            |
|----------------------------------------------------------------------------------------------------------------------------------------------------|------------|-------------------------------------------------------------------------------------------------------------------------------------|
| The cross-reference listing will have 35 lines on each page.                                                                                       | PAGELENGTH | -CREF86 :F1:FILE1, FILE.LIB &<cr><br>**PAGELENGTH(35)<cr>                                                                           |
| The cross-reference listing will be 100 characters wide maximum per page.                                                                          | PAGEWIDTH  | -CREF86 :PROG:PROGRAM, &<cr><br>**:PROG:LIB(MOD1) &<cr><br>**PAGEWIDTH(100)<cr>                                                     |
| The pathname of the print file will be :FX1:MYFILE.                                                                                                | PRINT      | -CREF86 :FX1:FILES(MODULE1,MODULE2) &<cr><br>**PRINT(:FX1:MYFILE)<cr>                                                               |
| The message in the TITLE control must be placed on one line. If the message contains special characters, it must be enclosed in single quotes ('). | TITLE      | -CREF86 MYPROG,HISPROG,HERPROG, &<cr><br>**MYLIB,HISLIB,HERLIB TITLE &<cr><br>**('A CROSS-REFERENCE') &<cr><br>**PAGEWIDTH(105)<cr> |

| Comments                                                           | Control | Examples                                                                                                                                                                                                                          |
|--------------------------------------------------------------------|---------|-----------------------------------------------------------------------------------------------------------------------------------------------------------------------------------------------------------------------------------|
| Three object files are added to the USER.LIB.                      | ADD     | <pre>*ADD :F1:SIN,:F1:COS,:F1:TAN TO &amp;&lt;cr&gt; ** :F0:USER.LIB&lt;cr&gt;</pre>                                                                                                                                              |
| Three modules from the library LIB.ABC are added to :FD0:PROJ.TOM. |         | <pre>*ADD :FD0:LIB.ABC(MOD1, MOD2, MOD3) &amp;&lt;cr&gt; **TO :FD0:PROJ.TOM&lt;cr&gt;</pre>                                                                                                                                       |
| This command will produce an empty library file called TOMS.LIB.   | CREATE  | <pre>*CREATE :WD0:SYSTEM/TOMS.LIB&lt;cr&gt;</pre>                                                                                                                                                                                 |
|                                                                    |         | <pre>*CREATE :F0:USER.LIB&lt;cr&gt;</pre>                                                                                                                                                                                         |
| Four modules are deleted from the library USER.LIB.                | DELETE  | <pre>*DELETE :FX1:USER.LIB(TEMP1, &amp;&lt;cr&gt; **TEMP3, TEM_TMP,TEST?)&lt;cr&gt;</pre>                                                                                                                                         |
|                                                                    |         | <pre>*DELETE :F0:IO.LIB(FLOPPY, CRT, &amp;&lt;cr&gt; **PAPER_TAPE)&lt;cr&gt;</pre>                                                                                                                                                |
|                                                                    | EXIT    | <pre>*EXIT&lt;cr&gt;</pre>                                                                                                                                                                                                        |
|                                                                    | LIST    | <pre>*LIST USER.LIB&lt;cr&gt; USER.LIB TEMP TEST EXEC MAIN LOOP *LIST USER.LIB(TEMP,TEST)&lt;cr&gt; USER.LIB TEMP TEST *LIST USER.LIB,TEMP.LIB&lt;cr&gt; USER.LIB TEMP TEST EXEC MAIN LOOP TEMP.LIB MODULE1 MODULE3 MODULE4</pre> |

| Comments                                                                                                                                                                                                                                                                                                                                 | Control             | Examples                                                                                                                                                                       |
|------------------------------------------------------------------------------------------------------------------------------------------------------------------------------------------------------------------------------------------------------------------------------------------------------------------------------------------|---------------------|--------------------------------------------------------------------------------------------------------------------------------------------------------------------------------|
| If SEG1 is byte alignable, it will be located at 15FFH.<br>If SEG2 is byte or word alignable, it will be at 4F5AH.                                                                                                                                                                                                                       | ADDRESS             | -LOC86 :F01:COME.LNK TO WENT &<cr><br>**ADDRESSES(SEGMENTS(SEG1\CLASS2\ &<cr><br>**OVERLAY3(15FFH), SEG2(4F5AH))<cr>                                                           |
| Address assignment of groups, segments, and classes can be in any order, as long as addresses do not conflict with existing absolute addresses.                                                                                                                                                                                          | BOOTSTRAP           | -LOC86 :F1:IST.LNK TO LOCIST.RDY &<cr><br>**ADDRESSES(SEGMENTS(SEG1\CLASS1 &<cr><br>** (23H)), GROUPS(CGROUPE(00H), DGROUPE &<cr><br>** (10000H), CLASSES(MEMORY(15000H)))<cr> |
| A long jump to GO will be placed at location 0FFFF0H.                                                                                                                                                                                                                                                                                    | COMMENTS/NOCOMMENTS | -LOC86 :WD1:USER/TEST.LNK &<cr><br>**START(GO) BOOTSTRAP<cr>                                                                                                                   |
| The initialization code is placed at address 32768 decimal (8000H).                                                                                                                                                                                                                                                                      | INITCODE/NOINITCODE | -LOC86 :F1:SOURCE.LNK NOCOMMENTS<cr><br>-LOC86 :F1:TEMP.LNK COMMENTS<cr>                                                                                                       |
| No initialization code will be produced.                                                                                                                                                                                                                                                                                                 | LINES/NOLINES       | -LOC86 :FX1:PROGDIR/FORK.LNK &<cr><br>**INITCODE(32768)<cr>                                                                                                                    |
| LINES is the default, so it need not be specified.                                                                                                                                                                                                                                                                                       | MAP/NOMAP           | -LOC86 :F1:TEST.LNK NOINITCODE<cr><br>-LOC86 :F1:RUN.LNK NOLINES<cr>                                                                                                           |
| This statement removes all debug records from the object file, but keeps the information in the print file.                                                                                                                                                                                                                              | NAME                | -LOC86 :F1:TEST.LNK<cr>                                                                                                                                                        |
| NOPUBLICS is implied by PURGE, but PUBLICS overrides it.                                                                                                                                                                                                                                                                                 | OBJECTCONTROLS      | -LOC86 :F1:TESTER.LNK MAP<cr>                                                                                                                                                  |
| SEG@A of CLASS1 will be the first relocatable segment located. SEG@B will be next, followed immediately by any other segments contained within CLASS1. The extra segments in CLASS1 (and all of the segments in CLASS2) are located in the order in which they are encountered. Finally, the list in the SEGMENTS subcontrol is handled. | ORDER               | -LOC86 :FD0:GONE.LNK TO &<cr><br>**:FD0:HERMAF.OVY NOMAP<cr>                                                                                                                   |
|                                                                                                                                                                                                                                                                                                                                          |                     | -LOC86 :F4:SHORT.LNK NAME &<cr><br>** (THIS IS A VERY LONG:MODULE)<cr>                                                                                                         |
|                                                                                                                                                                                                                                                                                                                                          |                     | -LOC86 :F1:UPWARD.LNK &<cr><br>**OBJECTCONTROLS (NOLINES, &<cr><br>**NOCOMMENTS, NOSYMBOLS)<cr>                                                                                |
|                                                                                                                                                                                                                                                                                                                                          |                     | -LOC86 :F3:PASCAL1.LNK &<cr><br>**OBJECTCONTROLS (PURGE,PUBLICS)<cr>                                                                                                           |
|                                                                                                                                                                                                                                                                                                                                          |                     | -LOC86 :F0:SPCSEQ.LNK ORDER &<cr><br>** (CLASSES(CLASS1(SEG@A, SEG@B), &<cr><br>** CLASS2), SEGMENTS(SEG1\CLASS3 &<cr><br>** \OVERLAY1, SEG22, SEG10\CLASS5))<cr>              |



| Comments                                                                                                              | Control           | Examples                                                                       |
|-----------------------------------------------------------------------------------------------------------------------|-------------------|--------------------------------------------------------------------------------|
| The print file is :F1:TEMP1.MP2.                                                                                      | PRINT/NOPRINT     | -LOC86 :F1:PROG.LNK TO <cr><br>**F1:TEMP1.TST PRINT<cr>                        |
| The print file is :FDD0:INTERRUPT.MP2.                                                                                |                   | -LOC86 :FDD0:INTERRUPT.LNK<cr>                                                 |
| The print file is :F1:MAP.                                                                                            |                   | -LOC86 :WD0:PROG.LNK PRINT(:F1:MAP)<cr>                                        |
| Information about line numbers is removed from the print file.                                                        | PRINTCONTROLS     | -LOC86 :F1:LINEAR.LNK <cr><br>**PRINTCONTROLS(NOLINES)<cr>                     |
| All but the segment information is removed from the print file.                                                       |                   | -LOC86 :WD1:DIR1/SBDIR/PR.LNK <cr><br>**PRINTCONTROLS(PURGE)<cr>               |
| No public information is included in the output files (:USER:PRIVATE.MP2 and :USER:PRIVATE).                          | PUBLICS/NOPUBLICS | -LOC86 :USER:PRIVATE.LNK NOPUBLICS<cr>                                         |
| All public information will be included in both the print file and output file.                                       |                   | -LOC86 :PROG:TEXT.LNK <cr><br>**NOPUBLICS PUBLICS<cr>                          |
| The object file contains no public or debug information, and the symbol table does not appear in the print file.      | PURGE/NOPURGE     | -LOC86 :F3:PROJ5.LNK PURGE<cr>                                                 |
| The line and symbol information will be kept in the print file.                                                       |                   | -LOC86 :FX0:B0209.LNK PURGE <cr><br>**PRINTCONTROLS (NOPURGE)<cr>              |
| This control reserves the high-order 64K of memory.                                                                   | RESERVE           | -LOC86 :F1:LOWMEM.LNK RESERVE <cr><br>**(0F0000H TO 0FFFFFFH)<cr>              |
| A 200H and a 100H section of memory at the top and bottom of memory are reserved.                                     |                   | -LOC86 :F2:HUGOS.LNK RESERVE <cr><br>**(00H TO 0200H, 0FFF00H TO 0FFFFFFH)<cr> |
| The size of segment MEMORY will be increased by 2000 bytes.                                                           | SEGSIZE           | -LOC86 :WD1:DIREC/GROW.LNK SEGSIZE <cr><br>**(MEMORY(+2000))<cr>               |
| The size of segment MYSEG will be decreased by 511 bytes.                                                             |                   | -LOC86 SEGPROB.LNK SEGSIZE <cr><br>**(MYSEG(-1FFH))<cr>                        |
| The new segment size for XENDA is 7770 bytes.                                                                         |                   | -LOC86 :F1:RPLACE.LNK SEGSIZE <cr><br>**(XENDA(7770))<cr>                      |
| :FD1:AUTO will start at IGNITION.                                                                                     | START             | -LOC86 :FD1:AUTO.LNK START(IGNITION)<cr>                                       |
| :PROG:HALTS will start at location 200H.                                                                              |                   | -LOC86 :PROG:HALTS.LNK START <cr><br>**(00H, 200H)<cr>                         |
| This statement will include the local symbol records in the object file and the symbol information in the print file. | SYMBOLS/NOSYMBOLS | -LOC86 GESHTA.LNK SYMBOLS<cr>                                                  |
| PURGE is a shorthand for NOSYMBOLS, NOCOMMENTS, NOPUBLICS, and NOLINES.                                               |                   | -LOC86 :F3:TEST.LNK PURGE<cr>                                                  |
| The symbol table will be printed on a line printer. A line printer line can hold a four-column symbol table.          | SYMBOLCOLUMNS     | -LOC86 :F3:DIR2/TEST.LNK <cr><br>**SYMBOLCOLUMNS(1)<cr>                        |
|                                                                                                                       |                   | -LOC86 :USER.LINKED.LNK <cr><br>**SYMBOLCOLUMNS(4) PRINT(:LP:)<cr>             |



## Environmental Considerations

The iAPX 86,88 Family utilities run on the Series IV Microcomputer Development System. These utilities can be used to produce code for an 8086-based host; the code can be executed on the Series IV if the code is load-time locatable (LTL). Resulting code is also compatible with DEBUG-86 and DEBUG-88 debuggers (if it is LTL code) and with ICE-86 and ICE-88 emulators (if it is absolute code).

The following conventions of the Series IV operating system (iNDX) are encountered when running the utilities:

- Each of the utilities is invoked by entering the name of the file in which the utility resides:

```
> LINK86 MYPROG.OBJ, HERPRO.OBJ, HISPRO.OBJ TO OURPRO<cr>
>
```

```
> /SYSTEMDRIVE/LOC86 /WORKDRIVE1/PROG.LNK<cr>
>
```

- The Series IV pathname consists of path components, each preceded by a slash (/):

```
/SYSA/JOHN/FILE.ABC
```

- The directory-name is one or more path components consisting of 1 to 14 characters, inclusive. One of the directory-name path components may be a "logical name." A logical name must be the first path component in a pathname and not preceded by a slash:

```
SYSJOHN/FILE.ABC
```

- A logical name for some directory may be defined as a null string. Null logical names do not appear in the pathname:

```
FILE.ABC
```

Examples in this appendix employ all these pathname variations.

- Continuation lines are necessary when a command or invocation will not fit on one line. The following example illustrates the line-end conventions to use and continuation characters to expect:

```
> LINK86 MYPROG.OBJ, /WORKFILE1/PAS86/HERPRO.OBJ, &<cr>
>> /WORKFILE2/PAS86/HISPRO.OBJ, /WORKFILE3/FOR86/HERPRO.OBJ<cr>
```

Pathnames may not be split between lines.

- The LIB86 utility presents an exception to these prompt conventions. Because this program is interactive, it has its own prompts:

```
> LIB86<cr>
iNDX 8086 LIBRARIAN Vx.y
>*ADD LIB1/PLM/SEC.LNK, LIB1/PLM/CSC.LNK, &<cr>
**LIB1/PLM/TAN.LNK TO LIB1/PLM/TRIG.LIB<cr>
*
```

The following versions of the iAPX 86,88 Family utilities may be executed on the Series IV:

LINK86: V2.0 or later  
 CREF86: V1.0 or later  
 LIB86: V2.0 or later  
 LOC86: V2.0 or later  
 OH86: V1.0 or later

## Related Publications

The following manuals may be helpful during various aspects of your work with iAPX 86,88 utilities on the Series IV:

- *Intellec Series IV Microcomputer Development System Overview*, order number 121752
- *iAPX 86,88 User's Manual*, order number 210201
- *Intellec Series IV ISIS-IV User's Guide*, order number 121880
- *Intellec Series IV Operating and Programming Guide*, order number 121753
- *DEBUG-88 User's Guide*, order number 121758
- *PASCAL-86 User's Guide*, order number 121539
- *PL/M-86 User's Guide*, order number 121636
- *ASM86 Language Reference Manual*, order number 121703
- *ASM86 Macro Assembler Operator's Manual*, order number 121628
- *8089 Macro Assembler User's Guide*, order number 9800938
- *FORTTRAN-86 User's Guide*, order number 121570

## Program Development Examples

The following examples are programming problems solved by using one or more of the iAPX 86,88 utilities on the Series IV to develop code for an 8086-based host.

### Example 1: Preparing to Use DEBUG-88

There are only two steps to preparing your code for DEBUG-88 execution: translating the code, then linking it with BIND.

First you must translate your code. Any of the 8086 translators will work. An example of one such translation is shown below:

```
> PLM86 TEST.SRC DEBUG SMALL<cr>
```

Once the program has been translated, you must link the program with the BIND control. LINK86 with BIND produces an LTL module. The Series IV assigns addresses to LTL modules at load time. The invocation line for LINK86 when linking the program shown above might appear as follows:

```
> LINK86 TEST.OBJ, UTILS.OBJ, SMALL.LIB &<cr>
>> TO TEST.86 BIND<cr>
```

In the above example note that all of the symbol information (LINES, SYMBOLS, PUBLICS) is left in the output object file. This will aid you while debugging your program. DEBUG-88 uses the symbol information to produce diagnostic information on the program. This information is also included in the symbol table. Figure K-1 shows the print file from the invocation above.

The libraries specified resolve all of the external references in TEST.OBJ.

After the above linkage, the program can be executed with the following command to the Series IV:

```
> DEBUG TEST.86<cr>
```

```

INDX 0000 LINKER, V xy

INPUT FILES: TEST.OBJ, UTILS.OBJ, SMALL.LIB
OUTPUT FILE: TEST.86
CONIKGLS SPECIFIED IN INVOCATION COMMAND:
 BIND
DATE: MM/DD/YY TIME: HH-MM-SS

LINK MAP OF MODULE ROOT

LOGICAL SEGMENTS INCLUDED:
LENGTH ADDRESS ALIGN SEGMENT CLASS OVERLAY
037DH ----- W CODE CODE
0000H ----- W CONST CONST
0192H ----- W DATA DATA
03F8H ----- W STACK STACK
0000H ----- W MEMORY MEMORY
0000H ----- G ??SEG

INPUT MODULES INCLUDED:
TEST.OBJ(ROOT)
UTILS.OBJ(UTILITIES)
SMALL.LIB(DQATTACH)
SMALL.LIB(DQCLOSE)
SMALL.LIB(DQCREATE)

```

```

GROUP MAP

GROUP NAME: CGROUP
 OFFSET SEGMENT NAME
 0000H CODE

GROUP NAME: DGROUP
 OFFSET SEGMENT NAME
 0000H CONST
 0014H DATA
 01AAH STACK
 05A2H MEMORY

SYMBOL TABLE OF MODULE ROOT

BASE OFFSET TYPE SYMBOL BASE OFFSET TYPE SYMBOL
G(2) 0164H PUB BINDCONTROL G(2) 004AH PUB BNODEBASE
G(2) 0016H PUB BUFBASE G(2) 0014H PUB BUFLEN
G(2) 004CH PUB CLASHNODEBASE G(2) 005EH PUB COCONN
G(2) 0158H PUB COMMENTSCONTROL G(2) 016FH PUB CURRENTOVERLAYNU
-M
G(2) 0171H PUB DEBUGTOGGLE G(2) 00A5H PUB DEFAULTPRTFILENA
-ME

```

```

MODULE NAME = ROOT

BASE OFFSET TYPE SYMBOL BASE OFFSET TYPE SYMBOL
G(2) 05A2H SYM MEMORY G(2) 0000H SYM COPYRIGHT
G(2) 0014H SYM BUFLEN G(2) 0016H SYM BUFBASE
G(1) 00F7H SYM ERROR G(1) 00FEH SYM WARNING
G(2) 0018H SYM LASTNMNODEP G(2) 001AH SYM FIRSTNMNODEP
G(2) 001CH SYM LASTSGNODEP G(2) 001EH SYM FIRSTSGNODEP
G(2) 0020H SYM LASTTDNODEP G(2) 0022H SYM FIRSTTDNODEP
G(2) 0024H SYM LASTEXNODEP G(2) 0026H SYM FIRSTEXNODEP
G(2) 0028H SYM LASTGRNODEP G(2) 002AH SYM FIRSTGRNODEP

```

Figure K-1. LINK86 Print File for Bound Object Module

```

G(1) 00A8H LIN 141 G(1) 00B3H LIN 143
G(1) 00BEH LIN 144 G(1) 00C8H LIN 145
G(1) 00CFH LIN 146 G(1) 00D2H LIN 148
G(1) 00DDh LIN 149 G(1) 00E7H LIN 150
G(1) 00EEH LIN 152 G(1) 00F5H LIN 153

REFERENCES TO SEGMENT BASES EXIST IN INPUT MODULES:
ROOT

```

**Figure K-1. LINK86 Print File for Bound Object Module (Cont'd.)**

### Example 2: Preparing to Use an ICE System

Another way to test and debug software is using an in-circuit emulation (ICE) system. The ICE-86 or ICE-88 loader can load only absolute object modules. Therefore, you cannot use the output from LINK86 immediately; it must be located, too.

The whole process of preparing a program for ICE system execution takes three steps. In the first two, the program must be translated and linked:

```

> PLM86 ICETST.SRC SMALL<cr>
.
.
.
> LINK86 ICETST.OBJ, SMALL.LIB<cr>

```

The above example shows a straightforward linkage with no change to the default control setting. Note that NOOVERLAY and NOBIND, the defaults, are set. The ICE loader has no facility for dealing with overlay modules created by using the LINK86 OVERLAY control. In this case there are no unresolved external references in the object module. If the module did contain unresolved references, it could still be executed by the ICE system. However, as with execution under DEBUG-88, executing instructions that contain unresolved references will produce undefined results.

Figure K-2 shows the print file produced during the invocation shown above. LINK86 does not produce a symbol table when NOBIND is in effect.

The last step before ICE system execution is transforming the relocatable object module into an absolute object module with LOC86. The invocation line shown below would produce an object file that could be loaded and executed by an ICE-86 or ICE-88 system:

```

> LOC86 ICETST.LNK<cr>

```

This invocation line shows LOC86 invoked with the default control setting. Note that the INITCODE control is in effect by default.

```

INDX 8086 LINKER, V x.y

INPUT FILES: ICETST.OBJ, SMALL.LIB
OUTPUT FILE: ICETST.LNK
CONTROLS SPECIFIED IN INVOCATION COMMAND:
DATE: MM/DD/YY TIME: HH:MM:SS

LINK MAP OF MODULE LOANER

LOGICAL SEGMENTS INCLUDED:
LENGTH ADDRESS ALIGN SEGMENT CLASS OVERLAY
037DH ----- W CODE CODE
0000H ----- W CONST CONST
0192H ----- W DATA DATA
03F8H ----- W STACK STACK
0000H ----- W MEMORY MEMORY
0000H ----- G ?7SEG

INPUT MODULES INCLUDED:
ICETST.OBJ(LOANER)
SMALL.LIB(DQATTACH)
SMALL.LIB(DQCLOSE)
SMALL.LIB(DQCREATE)
SMALL.LIB(DQDETACH)
SMALL.LIB(DQEXIT)
SMALL.LIB(DQGETSYSTEMID)
SMALL.LIB(DQOPEN)
SMALL.LIB(DQOVERLAY)
SMALL.LIB(DQWRITE)
SMALL.LIB(SYSTEMSTACK)

```

Figure K-2. LINK86 Default Print File

### Example 3: Using CREF86

Figure K-3 illustrates a CREF86 cross-reference listing for an input list of 15 files, one of which contains several modules. The output print file pathname 1/OUT1 and a title for the listing were specified in the controls. Although PAGESIZE (PW) and PAGESLENGTH (PL) specifications were also noted in the controls, the numbers specified are the same as those provided by default.

```

CREF86 EXAMPLE OF CROSS REFERENCE USING CREF86 MM/DD/YY HH:MM:SS PAGE 1

INDX CREF86 Vx.y

INPUT FILES: 1/ROOT.OBJ 1/PARSE.OBJ 1/SIGNON.OBJ 1/STATE.OBJ 1/ERROR.OBJ 1/UTILS.OBJ 1/MEMMAN.OBJ
1/SCANNR.OBJ 1/PROCES.OBJ 1/SCUTIL.OBJ 1/LIST.OBJ 1/LSUTIL.OBJ 1/SORT.OBJ 1/UDSMA.LNK
0/COMPAC.LIB

OUTPUT FILE: 1/OUT1
CONTROLS SPECIFIED: PR(1/OUT1) TT(EXAMPLE OF CROSS REFERENCE USING CREF86) PW(120) PL(60)

MODULES INCLUDED:

FILE NAME MODULE NAME(S)

1/ROOT.OBJ: CREF86
1/PARSE.OBJ: PARSE
1/SIGNON.OBJ: SIGNON
1/STATE.OBJ: NEXTSTATE
1/ERROR.OBJ: ERROR
1/UTILS.OBJ: UTILITIES
1/MEMMAN.OBJ: MEMORYMANAGEMENT
1/SCANNR.OBJ: SCANMODULES
1/PROCES.OBJ: PROCESSRECORDS
1/SCUTIL.OBJ: SCANUTILITIES
1/LIST.OBJ: LISTOUTPUT
1/LSUTIL.OBJ: LISTUTILITIES
1/SORT.OBJ: SYMBOLSORT
1/UDSMA.LNK: OBJMAN
0/COMPAC.LIB: DQALLOCATE DQATTACH DQCHANGEEXTENSION DQCREATE DQDECODEEXCEPTION
DQDETACH DQEXIT DQFREE DQGETARGUMENT DQGETSYSTEMID
DQGETTIME DQOPEN DQREAD DQSEEK DQWRITE
SYSTEMSTACK

```

Figure K-3. CREF86 Cross-Reference Listing

| CREF86 EXAMPLE OF CROSS REFERENCE USING CREF86 |                     | MM/DD/YY                             | HH:MM:SS       | PAGE        | 2              |
|------------------------------------------------|---------------------|--------------------------------------|----------------|-------------|----------------|
| SYMBOL NAME                                    | SYMBOL TYPE         | DEFINING MODULE; REFERRING MODULE(S) |                |             |                |
| ACCESS_PAGE . . . . .                          | UNKNOWN             | OBJMAN                               |                |             |                |
| ALLOCATE . . . . .                             | UNKNOWN             | OBJMAN                               |                |             |                |
| APPENDNODE . . . . .                           | PROCEDURE NEAR      | UTILITIES                            |                |             |                |
| APPENDUDSMNODE . . . . .                       | PROCEDURE NEAR      | UTILITIES;                           | PARSE          | SCANMODULES | PROCESSRECORDS |
| ARRAYBASE . . . . .                            | POINTER             | SYMBOLSORT;                          | LISTOUTPUT     |             |                |
| ATOI . . . . .                                 | PROCEDURE WORD NEAR | UTILITIES;                           | PARSE          |             |                |
| BTOX . . . . .                                 | PROCEDURE WORD NEAR | UTILITIES;                           | LISTUTILITIES  |             |                |
| BUBBLESORTVARNAMES . . . . .                   | PROCEDURE NEAR      | SYMBOLSORT;                          | LISTOUTPUT     |             |                |
| BUMPLINECOUNT . . . . .                        | PROCEDURE NEAR      | LISTUTILITIES;                       | LISTOUTPUT     |             |                |
| CHECKHEADER . . . . .                          | PROCEDURE NEAR      | SCANUTILITIES;                       | SCANMODULES    |             |                |
| CHECKOVERLAY . . . . .                         | PROCEDURE NEAR      | SCANUTILITIES;                       | SCANMODULES    |             |                |
| CHECKVARTYPE . . . . .                         | PROCEDURE BYTE NEAR | SCANUTILITIES;                       | PROCESSRECORDS |             |                |

| CREF86 EXAMPLE OF CROSS REFERENCE USING CREF86 |                | MM/DD/YY          | HH:MM:SS       | PAGE           | 6          |
|------------------------------------------------|----------------|-------------------|----------------|----------------|------------|
| UNLOAD_PAGE . . . . .                          | UNKNOWN        | OBJMAN            |                |                |            |
| VARAREAP . . . . .                             | POINTER        | MEMORYMANAGEMENT; | PROCESSRECORDS | LISTOUTPUT     | SYMBOLSORT |
| VBLOCKLISTHEADER . . . . .                     | WORD           | PROCESSRECORDS;   | UTILITIES      | LISTOUTPUT     | SYMBOLSORT |
| WARNING . . . . .                              | PROCEDURE NEAR | ERROR;            | SCANMODULES    | PROCESSRECORDS |            |
| WRITEDATA . . . . .                            | PROCEDURE NEAR | LISTUTILITIES;    | ERROR          | UTILITIES      | LISTOUTPUT |
| WRITEINITLINEBUF . . . . .                     | PROCEDURE NEAR | LISTUTILITIES;    | ERROR          | UTILITIES      | LISTOUTPUT |
| WRITELINE . . . . .                            | PROCEDURE NEAR | LISTUTILITIES;    | LISTOUTPUT     |                |            |
| WRITENEWLINE . . . . .                         | PROCEDURE NEAR | LISTUTILITIES;    | UTILITIES      | LISTOUTPUT     |            |
| WRITETOCOMMANDBUF . . . . .                    | PROCEDURE NEAR | PARSE             |                |                |            |
| WRITETOFILE . . . . .                          | PROCEDURE NEAR | LISTUTILITIES;    | ERROR          | LISTOUTPUT     |            |
| ZERO . . . . .                                 | WORD           | UTILITIES         |                |                |            |

Figure K-3. CREF86 Cross-Reference Listing (Cont'd.)

### Example 4: Building and Using Library Files

A library is a file that contains object modules. Libraries allow you to collect commonly used pieces of software into one file. The library file can be included in a LINK86 invocation, and LINK86 will use the modules to resolve references.

You can add the output from a translator, LINK86, or LOC86 to a library. The modules added may be relocatable or absolute; they can have unresolved references or be completely linked.

Let's consider the following scenario—we have created six routines (SINE, COSINE, TANGENT, COSECANT, SECANT, and COTANGENT). We want to create a library file that will allow each routine to be linked to programs separately.

The first step necessary to create the library is to translate each routine separately. If we were to output them in a single source module, the translator would translate them into one module with six public symbols. We could add this module to a library, but when we tried to link one of the routines into a program, all six would be included.

Once the routines are translated, LIB86 can be used to create a library file and add modules. The LIST command is used to display the contents of the library and the publics contained within it:

```
> /SYSTEMDISK/FRED/LIB86<cr>
iNDX 8086 LIBRARIAN Vx.y
*CREATE /WORKDISK/FRED/TRIG.LIB<cr>
*ADD /WORKDISK/FRED/SIN.OBJ, /WORKDISK/FRED/COS.OBJ &<cr>
**TO /WORKDISK/FRED/TRIG.LIB<cr>
*LIST /WORKDISK/FRED/TRIG.LIB PUBLICS<cr>
 /WORKDISK/FRED/TRIG.LIB
 SIN
 SINE
 COS
 COSINE
*ADD /HISDISK/SEC.LNK, /HERDISK/CSC.LNK, &<cr>
** /WORKDISK/FRED/COT.LNK, /WORKDISK/NANCY/TAN.LNK, &<cr>
**TO /WORKDISK/FRED/TRIG.LIB<cr>
*LIST /WORKDISK/FRED/TRIG.LIB PUBLICS<cr>
 /WORKDISK/FRED/TRIG.LIB
 SIN
 SINE
 COS
 COSINE
 SEC
 SECANT
 CSC
 COSECANT
 COT
 COTANGENT
 TAN
 TANGENT
*EXIT<cr>
>
```

### Example 5: Creating Programs with Overlays Using OVERLAY Control

The easiest way to build an 8086 program that contains overlays is with LINK86's OVERLAY control. Overlay modules built with this control reside in the same file as the root. The operating system supplies routines that will load the overlays constructed in this way. See the *Intellec Series IV Operating and Programming Guide*.

After the program modules that will constitute the root and its overlays are translated, each of the overlays and the root must be linked separately. Then the root and all the overlays are linked together.

The example below shows the first step toward linking overlays—linking the root and all of the modules that will constitute each overlay separately.



```

> LINK86 OV1.OBJ,OV1A.OBJ,OV1B.OBJ OVERLAY(OVERLAY1)<cr>
> LINK86 /MYPROG/OV2A.OBJ, /THEPROG/LIB/PRO.OBJ &<cr>
>> TO OV2.LNK OVERLAY(OVERLAY2)<cr>
> LINK86 OV3.OBJ, OV3A.OBJ OVERLAY(OVERLAY3)<cr>
> LINK86 OV4.OBJ,OV4A.OBJ OVERLAY(OVERLAY4)<cr>
> LINK86 NROOT.OBJ,ROOTA.OBJ,ROOTB.OBJ,SMALL.LIB OVERLAY(ROOT)<cr>

```

Notice that all of the modules, including the root, are linked with the OVERLAY and NOBIND controls. The overlay name for the root is not as critical as is that for the overlays, since the overlay name is used when calling the loader.

Finally, the overlays and root must be linked together. Since any one of the files could be the root, LINK86 requires that for the final link, the file containing the root must be first in the input list. During this final linkage, the OVERLAY control is not used:

```

> LINK86 NROOT.LNK, OV1.LNK, OV2.LNK, OV3.LNK, &<cr>
>> OV4.LNK TO 1/PROG.86 BIND<cr>

```

In this invocation, the optional BIND control is specified. The resulting object file is executable on a Series IV.

Figure K-4 shows the LINK86 print file listing for the above invocation.

There is nothing special about the invocation line to LOC86 when locating a file that contains overlays or that has been bound:

```

> LOC86 1/PROG.86 TO PROG &<cr>
>> RESERVE (0H TO 77FFH,0FC000H TO 0FFFFFFH)<cr>

```

The RESERVE control prevents LOC86 from assigning memory addresses that the user wishes to reserve for the target system. Figure K-5 illustrates the printout from this invocation.

---

```

INDX 8086 LINKER, V x.y

INPUT FILES: NROOT.LNK, OV1.LNK, OV2.LNK, OV3.LNK, OV4.LNK
OUTPUT FILE:
CONTROLS SPECIFIED IN INVOCATION COMMAND:
 BIND
DATE: MM/DD/YY TIME: .H:MM:SS

LINK MAP OF MODULE ROOT

LOGICAL SEGMENTS INCLUDED:
LENGTH ADDRESS ALIGN SEGMENT CLASS OVERLAY
3CE7H ----- G CODE CODE ROOT
0D00H ----- G CONST CONST ROOT

```

Figure K-4. LINK86 Listing for Program with Overlays

---

```

INPUT MODULES INCLUDED:
ROOT.LNK(ROOT)
OV1.LNK(PARSE)
OV2.LNK(ILUDE)
OV3.LNK(PICILUDE)
OV4.LNK(FASTLOAD)

GROUP MAP

GROUP NAME: CGROUP
OFFSET SEGMENT NAME
0000H CODE\CODE\ROOT
3CE8H CODE\CODE\PASS1

```

```

SYMBOL TABLE OF MODULE ROOT

```

| BASE | OFFSET | TYPE | SYMBOL           | BASE | OFFSET | TYPE | SYMBOL           |
|------|--------|------|------------------|------|--------|------|------------------|
| G(2) | 251CH  | PUB  | ACTUAL           | G(2) | 0F0DH  | PUB  | ASSUMEROOTCONTRO |
|      |        |      |                  |      |        |      | -L               |
| G(2) | 0F22H  | PUB  | BASEFIXUPSEXIST  | G(2) | 0F0CH  | PUB  | BINDCONTROL      |
| G(2) | 0D26H  | PUB  | BNODEID          | G(2) | 24EAH  | PUB  | BUFBASE          |
| G(2) | 0D2BH  | PUB  | CLASHNODEID      | G(2) | 0D5AH  | PUB  | COCONN           |
| G(2) | 0F00H  | PUB  | COMMENTSCONTROL  | G(2) | 0F50H  | PUB  | CURRENTFILNUM    |
| G(2) | 0F1AH  | PUB  | CURRENTOVERLAYNU | G(2) | 0F8EH  | PUB  | CURRENTRECINDEX  |
|      |        |      | -M               |      |        |      |                  |

```

OVERLAY NAME = ROOT, MODULE NAME = ROOT

```

| BASE | OFFSET | TYPE | SYMBOL       | BASE | OFFSET | TYPE | SYMBOL        |
|------|--------|------|--------------|------|--------|------|---------------|
| G(2) | 4A20H  | SYM  | MEMORY       | G(2) | 0002H  | SYM  | COPYRIGHT     |
| G(2) | 0D00H  | SYM  | LASTNMNODEID | G(2) | 0D02H  | SYM  | FIRSTNMNODEID |
| G(2) | 0D04H  | SYM  | LASTSGNODEID | G(2) | 0D06H  | SYM  | FIRSTSGNODEID |
| G(2) | 0D08H  | SYM  | LASTIDNODEID | G(2) | 0D0AH  | SYM  | FIRSTIDNODEID |
| G(2) | 0D0CH  | SYM  | LASTEXNODEID | G(2) | 0D0EH  | SYM  | FIRSTEXNODEID |
| G(2) | 0D10H  | SYM  | LASTGRNODEID | G(2) | 0D12H  | SYM  | FIRSTGRNODEID |
| G(2) | 0D14H  | SYM  | LASTOVNODEID | G(2) | 0D16H  | SYM  | FIRSTOVNODEID |
| G(2) | 0D18H  | SYM  | LASTGNODEID  | G(2) | 0D1AH  | SYM  | FIRSTBNODEID  |

```

OVERLAY NAME = ROOT, MODULE NAME = LIT

```

| BASE  | OFFSET | TYPE | SYMBOL    | BASE  | OFFSET | TYPE | SYMBOL          |
|-------|--------|------|-----------|-------|--------|------|-----------------|
| G(2)  | 4A20H  | SYM  | MEMORY    | G(2)  | 003CH  | BAS  | SGNODE          |
| G(2)  | 0F56H  | SYM  | LITBASE   | G(2)  | 0F58H  | SYM  | LITID           |
| G(2)  | 0F56H  | BAS  | LITNODE   | G(2)  | 0F5AH  | SYM  | FIRSTNODEIDS    |
| G(2)  | 0F64H  | SYM  | FIRSTNODE | G(2)  | 0F8EH  | SYM  | CURRENTRECINDEX |
| G(2)  | 0F96H  | SYM  | TEMPLATE  | G(2)  | 0FB9H  | SYM  | II              |
| G(1)  | 016EH  | SYM  | GETLIT    | STACK | 0006H  | SYM  | INDEX           |
| STACK | 0004H  | SYM  | I         | G(1)  | 0207H  | SYM  | SGLIT           |

Figure K-4. LINK86 Listing for Program with Overlays (Cont'd.)

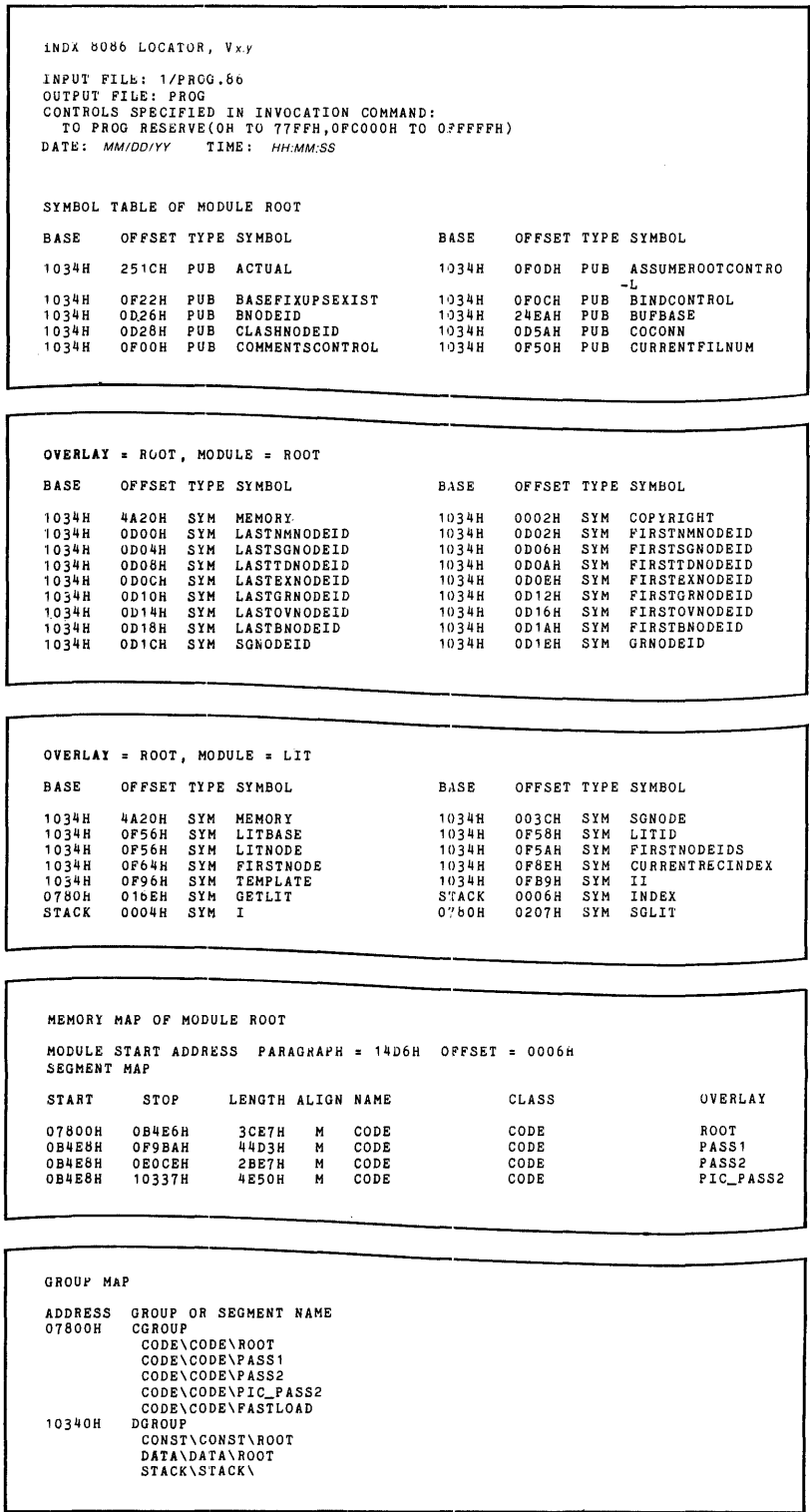

Figure K-5. LOC86 Listing for Program with Overlays

## Example 6: Linking and Locating Programs with Overlays Without OVERLAY Control

It is harder to produce overlay modules without using the OVERLAY control. However, sometimes it is necessary to build programs in this way, for example, for running under an operating system that does not support overlay modules contained in the same file as the root module.

But regardless of the reason, building overlays in this fashion places an extra burden on the programmer. He must do some of the work that would be left to LINK86 (and LOC86) if he were to use the OVERLAY control. In the following example we prepare a root and two overlay modules in separate files.

First we must compile all modules. Examples of the invocation lines are shown below:

```
> PLM86 ROOT.SRC SMALL<cr>
```

```
> PLM86 OV1.SRC SMALL<cr>
```

```
> PLM86 OV2.SRC SMALL<cr>
```

The next step is to link the root module to resolve external symbols with a library and to obtain a link map:

```
> LINK86 ROOT.OBJ, USER.LIB MAP<cr>
```

We will need the link map for locating purposes. The link map, shown in figure K-6, shows the size of each segment in the root. Since the overlays are self-contained except for references to the root, we do not need a link map for them. The PL/M-86 listing files will show the size of each overlay's segments, as illustrated in figure K-7.

```

INDX 8086 LINKER, Vx.y

INPUT FILES: ROOT.OBJ,USER.LIB
OUTPUT FILE: ROOT.LNK
CONTROLS SPECIFIED IN INVOCATION COMMAND:
MAP
DATE: MM/DD/YY TIME: HH:MM:SS

LINK MAP OF MODULE LOANER

LOGICAL SEGMENTS INCLUDED:
LENGTH ADDRESS ALIGN SEGMENT CLASS OVERLAY
8495H ----- W CODE CODE
0381H ----- W CONST CONST
0291H ----- W DATA DATA
0030H ----- W STACK STACK
0000H ----- W MEMORY MEMORY

INPUT MODULES INCLUDED:
ROOT.OBJ(ROOT)
USER.LIB(LOADER)
USER.LIB(EXIT)
USER.LIB(ERROR)
USER.LIB(TIME)

```

Figure K-6. LINK86 Map for Root File

```

 OV1's segment size information
MODULE INFORMATION:
 CODE AREA SIZE = 7531H 30001D this is the CODE segment
 CONSTANT AREA SIZE = 0081H 129D this is the CONST segment
 VARIABLE AREA SIZE = 0181H 385D this is the DATA segment
 MAXIMUM STACK SIZE = 0040H 64D this is the STACK segment
 918 LINES READ
 0 PROGRAM ERROR(S)
END OF PL/M-86 COMPILATION

```

```

 OV2's segment size information
MODULE INFORMATION:
 CODE AREA SIZE = 1B9AH 7066D this is the CODE segment
 CONSTANT AREA SIZE = 0101H 257D this is the CONST segment
 VARIABLE AREA SIZE = 0454H 1108D this is the DATA segment
 MAXIMUM STACK SIZE = 0067H 103D this is the STACK segment
 918 LINES READ
 0 PROGRAM ERROR(S)
END OF PL/M-86 COMPILATION

```

**Figure K-7. Module Information for Overlays**

Note that the length of the root's code segment and the larger overlay's (OV1's) code segment must fit within 64K. This means that the code for the overlays must be in a part of memory contiguous with the root (to avoid altering the CS register during execution). OV2's CONST and DATA segments are larger than OV1's so that the STACK segment must be placed to leave room for OV2's CONST and DATA segments. If the overlays share the STACK and MEMORY segments with the root, they must be located at the same address.

After computing the required location for the root's DGROUP and STACK, we can locate the root module. The resulting file will not be executable, but it allows us to resolve references to the root's code and data symbols in the overlays. The following LOC86 invocation will leave room for the overlays' code segments and place the DGROUP in the first unused memory location. (In the command line below, the DS register is initialized to 0FFCH, and the CS register is initialized to 0.) The STACK and MEMORY segments will be located above OV2's DATA segment:

```

> LOC86 ROOT.LNK &<cr>
>>ADDRESSES(GROUPS(CGROU(0H), DGROU(0FFCEH)), &<cr>
>>SEGMENTS(CODE(0H), CONST(0FFCEH), STACK(10B34H))) &<cr>
>>ORDER(SEGMENTS(CODE, CONST, DATA, STACK, MEMORY)) &<cr>
>>SEGSIZE(STACK(100H))<cr>

```

Once the root is located, we can use it to resolve external references in the overlay modules. The overlay modules cannot call each other, since only one is resident in memory at any time. The link commands are shown below. The NOPUBLICS with the EXCEPT control is used to avoid conflicts when we use the located overlays to resolve external references in the root:

```

> LINK86 OV1.OBJ, PUBLICSONLY(ROOT) &<cr>
>>NOPUBLICS EXCEPT(OV1CODE, OV1DATA)<cr>

> LINK86 OV2.OBJ, PUBLICSONLY(ROOT) &<cr>
>>NOPUBLICS EXCEPT(OV2CODE, OV2DATA)<cr>

```

The PUBLICSONLY control resolves references to public symbols contained in the root.

After the overlays have been linked, they must be located. The code and data segments must be placed in the memory locations that were reserved when we first located the root. In this case the STACK and MEMORY segments must be the same for the overlays and the root:

```
> LOC86 OV1.LNK &<cr>
>>ADDRESSES(GROUPS(CGROU(0H),DGROUP(0FFCEH)), &<cr>
>>SEGMENTS(CODE(8A9CH),CONST(105E0H),STACK(10B34H))) &<cr>
>>ORDER(SEGMENTS(CODE,CONST,STACK,MEMORY)) &<cr>
>>SEGSIZE(STACK(100H))<cr>

> LOC86 OV2.LNK &<cr>
>>ADDRESSES(GROUPS(CGROU(0H),DGROUP(0FFCEH)), &<cr>
>>SEGMENTS(CODE(8A9CH),CONST(105E0H),STACK(10B34H))) &<cr>
>>ORDER(SEGMENTS(CODE,CONST,DATA,STACK,MEMORY)) &<cr>
>>SEGSIZE(STACK(100H))<cr>
```

The CGROUP and DGROUP base address must be specified in order to compute offset information. The final base address assigned to DGROUP by LOC86 will be rounded up to 0FFD0H.

Once the overlays are located, the root is linked and located into an executable form. The PUBLICSONLY control will resolve references to symbols in the overlay modules. Other than the addition of this input control, the LINK86 and LOC86 command must be identical to those used previously:

```
> LINK86 ROOT.OBJ,USER.LIB, &<cr>
>>PUBLICSONLY (OV1,OV2)<cr>

> LOC86 ROOT.LNK &<cr>
>>ADDRESSES(GROUPS(CGROU(0H),DGROUP(0FFCEH)), &<cr>
>>SEGMENTS(CODE(0H),CONST(0FFCEH),STACK(10B34H))) &<cr>
>>ORDER(SEGMENTS(CODE,CONST,DATA,STACK,MEMORY)) &<cr>
>>SEGSIZE(STACK(100H))<cr>
```

The executable forms of the root and its overlay files are contained in ROOT, OV1, and OV2. Figure K-8 shows the resulting layout of memory.

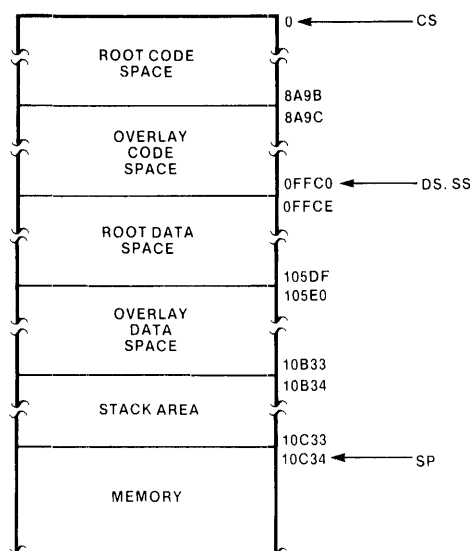

Figure K-8. Memory Organization for Example 6

121616-10

## Example 7: Linking 8089 Programs with 8086 Programs

The process of linking and locating 8086 programs with 8089 programs that use 8089 local memory is very similar to creating overlay modules in separate files.

Let us consider the following example. We have created an 8086 program and two 8089 program modules. The 8089 programs reference each other's symbols and public symbols in the 8086 program. In addition, one of the 8089 programs must be resident in 8089 local memory.

The first step is to translate the programs. The 8089 program modules must be translated separately, since they will be located in different 8089 address spaces. The following lines illustrate the invocation lines to the translators:

```
> ASM86 /JOE/ASM/PROG86.A89<cr>
> ASM89 /HARRIET/TASK1.A89<cr>
> ASM89 /STEVE/TASK2.A89<cr>
```

TASK2 should be linked and located first for 8089 local memory. This linkage will leave unresolved external references, but it is needed to resolve the references in TASK1:

```
> LINK86 /STEVE/TASK2.OBJ, 8089.LIB<cr>
> LOC86 /STEVE/TASK2.LNK RESERVE(10000H TO 0FFFFFFH)<cr>
```

The RESERVE control in the locate above is a precaution to avoid exceeding 64K.

The next step is to link and locate the object modules that will reside in the 8086's address space. The external references to the 8089 program module that is resident in 8089 local memory are resolved with the PUBLICSONLY control. The invocation lines for linking and locating the modules are:

```
> LINK86 /JOE/ASM/PROG86.OBJ, &<cr>
>>8086.LIB, /HARRIET/TASK1.OBJ, 8089.LIB, &<cr>
>>PUBLICSONLY(/STEVE/TASK2) TO 86N89.LNK<cr>
> LOC86 86N89.LNK<cr>
```

The file 86N89 contains an absolute object module that includes PROG86 and TASK1. It may be loaded and executed on an 8086-based system. However, the 8089 program to be located in 8089 local memory still has some unresolved external references. To resolve those references, we must relink with PUBLICSONLY and relocate. The invocation lines to LINK86 and LOC86 shown below are identical to those used earlier—to guarantee that the references resolved earlier are not invalidated:

```
> LINK86 /STEVE/TASK2.OBJ, 8089.LIB, &<cr>
>>PUBLICSONLY(86N89)<cr>
> LOC86 /STEVE/TASK2.LNK RESERVE(10000H TO 0FFFFFFH)<cr>
```

### NOTE

The example above makes many assumptions about the 8089 and 8086 code that it deals with. In most practical situations it is usually necessary to use a more complex LINK86 and LOC86 invocation. However, the example above illustrates the key linking and locating principles underlying ASM86/ASM89 module combination.

## Invocation Examples

The following foldout pages contain examples of the iAPX 86,88 Family utility controls and commands. The examples illustrate conventions you are likely to encounter while using the Series IV. They may be used in conjunction with syntax specifications given:

- In Chapter 2 for LINK86
- In Chapter 3 for CREF86
- In Chapter 4 for LIB86
- In Chapter 5 for LOC86

When using the directions in these chapters, fold out the page in this appendix containing examples of the command or control you are interested in.

The following is a sample Series IV OH86 invocation:

```
> /SYSTEM/CHARLIE/OH86 /MYCODE/DONE TO /MYCODE/FINI.HEX<cr>
```



| Comments                                                                                                                                                                    | Control             | Examples                                                                                                                                                                                                                                                                                                                                                                                                                                                                                                                                                                       |
|-----------------------------------------------------------------------------------------------------------------------------------------------------------------------------|---------------------|--------------------------------------------------------------------------------------------------------------------------------------------------------------------------------------------------------------------------------------------------------------------------------------------------------------------------------------------------------------------------------------------------------------------------------------------------------------------------------------------------------------------------------------------------------------------------------|
| This example defines two public symbols, VARONE and VARTWO, with absolute addresses 50H and 2000H, respectively.                                                            | ASSIGN              | <pre>&gt; LINK86 SYS/FILE1, WORKDISK/FILE2, &amp;&lt;cr&gt; &gt;&gt;FILE3 ASSIGN(VARONE(50H), &amp;&lt;cr&gt; &gt;&gt;VARTWO(2000))&lt;cr&gt;</pre>                                                                                                                                                                                                                                                                                                                                                                                                                            |
| In this example, the root file is RTFILE, and SYSTEM/LIB1, /SYSTEMB/LIB2, LIB1, and LIB2 are library files.                                                                 | ASSUMEROOT          | <pre>&gt; LINK86 CHARLES/ROOT1.OBJ, &amp;&lt;cr&gt; &gt;&gt;ROOT2.OBJ, SYSTEM/LIB1, &amp;&lt;cr&gt; &gt;&gt;/SYSTEMB/LIB2 TO RTFILE &amp;&lt;cr&gt; &gt;&gt;OVERLAY&lt;cr&gt;  &gt; LINK86 OV11.OBJ,OV12.OBJ,LIB1, &amp;&lt;cr&gt; &gt;&gt;LIB2 TO OV1.OBJ OVERLAY &amp;&lt;cr&gt; &gt;&gt;ASSUMEROOT(RTFILE)&lt;cr&gt;  &gt; LINK86 OV21.OBJ, WORK/OV22.OBJ, &amp;&lt;cr&gt; &gt;&gt;SYSTEM/LIB1, /SYSTEMB/LIB2 TO &amp;&lt;cr&gt; &gt;&gt;OV2.OBJ OVERLAY ASSUMEROOT(RTFILE)&lt;cr&gt;  &gt; LINK86 RTFILE, OV1.OBJ, OV2.OBJ &amp;&lt;cr&gt; &gt;&gt;TO PROG&lt;cr&gt;</pre> |
| This line creates an LTL module. The output object file is WORK/TEST with no extension.                                                                                     | BIND/NOBIND         | <pre>&gt; SYSTEM/LINK86 WORK/TEST.OBJ, &amp;&lt;cr&gt; &gt;&gt;USER.LIB BIND PRINT&lt;cr&gt;  &gt; SYSTEM/LINK86 WORK/GEN.OBJ NOBIND&lt;cr&gt;</pre>                                                                                                                                                                                                                                                                                                                                                                                                                           |
| This example specifies default to avoid ambiguity.                                                                                                                          | COMMENTS/NOCOMMENTS | <pre>&gt; LINK86 SOURCE.OBJ NOCOMMENTS&lt;cr&gt;  &gt; LINK86 PROG.OBJ TO TEMP.TEST &amp;&lt;cr&gt; &gt;&gt;COMMENTS&lt;cr&gt;</pre>                                                                                                                                                                                                                                                                                                                                                                                                                                           |
|                                                                                                                                                                             | FASTLOAD/NOFASTLOAD | <pre>&gt; SYSTEM/LINK86 PROG.OBJ, &amp;&lt;cr&gt; &gt;&gt;USERA/LIB1, LIB2 BIND FASTLOAD&lt;cr&gt;</pre>                                                                                                                                                                                                                                                                                                                                                                                                                                                                       |
|                                                                                                                                                                             | INITCODE            | <pre>&gt; LINK86 MYDISK/PLM/MYPROG INITCODE&lt;cr&gt;</pre>                                                                                                                                                                                                                                                                                                                                                                                                                                                                                                                    |
|                                                                                                                                                                             | LINES/NOLINES       | <pre>&gt; LINK86 RUN.OBJ NOLINES&lt;cr&gt;  &gt; LINK86 TEST.OBJ LINES&lt;cr&gt;</pre>                                                                                                                                                                                                                                                                                                                                                                                                                                                                                         |
| LINES is the default, so it need not be specified.                                                                                                                          | MAP/NOMAP           | <pre>&gt; /SYSTEM/LINK86 WORK/TESTER.OBJ &amp;&lt;cr&gt; &gt;&gt;MAP&lt;cr&gt;  &gt; /SYSTEM/LINK86 /WORK/MAIN.OBJ, &amp;&lt;cr&gt; &gt;&gt;/WORK/USER.OBJ, PUBLICONLY &amp;&lt;cr&gt; &gt;&gt;(8089.LOC) NOMAP&lt;cr&gt;</pre>                                                                                                                                                                                                                                                                                                                                                |
| This MEMPOOL example will increase the minimum dynamic memory requirements by 20H bytes, and by default the maximum size will increase, if necessary, to equal the minimum. | MEMPOOL             | <pre>&gt; SYSTEM/LINK86 TED/TEST.OBJ, &amp;&lt;cr&gt; &gt;&gt;USER.LIB, PASCAL.LIB BIND &amp;&lt;cr&gt; &gt;&gt;MEMPOOL(+20H)&lt;cr&gt;</pre>                                                                                                                                                                                                                                                                                                                                                                                                                                  |
| The minimum dynamic memory requirement is 100H. The maximum dynamic memory requirement is 300H.                                                                             |                     | <pre>&gt; LINK86 TESTED.OBJ MEMPOOL &amp;&lt;cr&gt; &gt;&gt;(100H,+200H) BIND&lt;cr&gt;</pre>                                                                                                                                                                                                                                                                                                                                                                                                                                                                                  |

| Comments                                                                                              | Control           | Examples                                                                                                                                                                                                                                                                                                                                               |
|-------------------------------------------------------------------------------------------------------|-------------------|--------------------------------------------------------------------------------------------------------------------------------------------------------------------------------------------------------------------------------------------------------------------------------------------------------------------------------------------------------|
| The LINK86 output module will have the name specified in parentheses in the control.                  | NAME              | <pre>&gt; /SYSTEM/LINK86 WORK/TOM.OBJ, &amp;&lt;cr&gt; &gt;&gt;/SYSTEM/SYSTEM.LIB NAME &amp;&lt;cr&gt; &gt;&gt;(THIS_IS_A_VERY_LONG@NAME)&lt;cr&gt;</pre>                                                                                                                                                                                              |
| This example removes all debug and public records from the object file.                               | OBJECTCONTROLS    | <pre>&gt; LINK86 SRC1.OBJ, SRC2.OBJ, &amp;&lt;cr&gt; &gt;&gt;USER.LIB NAME(TEST_5.3)&lt;cr&gt;  &gt; LINK86 TOM/FINAL,MARY/USER.LIB, &amp;&lt;cr&gt; &gt;&gt;EVERYONE/SYSTEM.LIB &amp;&lt;cr&gt; &gt;&gt;OBJECTCONTROLS(PURGE)&lt;cr&gt;</pre>                                                                                                         |
| The EXCEPT in the NOPUBLICS overrides the PURGE.                                                      | ORDER             | <pre>&gt; LINK86 PASCL1.OBJ &amp;&lt;cr&gt; &gt;&gt;OBJECTCONTROLS(PURGE,NOPUBLICS &amp;&lt;cr&gt; &gt;&gt;EXCEPT(START, DATA1, DATA2))&lt;cr&gt;</pre>                                                                                                                                                                                                |
| This use of ORDER specifies the order of segments for two groups.                                     | ORDER             | <pre>&gt; SYSTEM/LINK86 PLM/PROG.OBJ, &amp;&lt;cr&gt; &gt;&gt;PLM/PLM86.LIB, SMALL.LIB, &amp;&lt;cr&gt; &gt;&gt;USER.LIB &amp;&lt;cr&gt; &gt;&gt;ORDER(DGROUP(SEG1,SEG2\CLASS1, &amp;&lt;cr&gt; &gt;&gt;SEG2\CLASS1\OVERLAY1), &amp;&lt;cr&gt; &gt;&gt;CGROUP(CSEG1,CSEG2,CSEG3))&lt;cr&gt;</pre>                                                      |
| This example will create an overlay record, and the name of the overlay will be OVERLAY1.             | OVERLAY/NOOVERLAY | <pre>&gt; LINK86 FILE1, FILE2, FILE3 TO &amp;&lt;cr&gt; &gt;&gt;OV1.LNK OVERLAY(OVERLAY1)&lt;cr&gt;  &gt; LINK86 FILE4, FILE5, FILE6 TO &amp;&lt;cr&gt; &gt;&gt;OV2.LNK OVERLAY(OVERLAY2)&lt;cr&gt;  &gt; LINK86 FILE7, FILE8, FILE9 TO &amp;&lt;cr&gt; &gt;&gt;ROOT.LNK OVERLAY(ROOT)&lt;cr&gt;  &gt; LINK86 ROOT.LNK,OV1.LNK,OV2.LNK&lt;cr&gt;</pre> |
| The print file is WORKDISK/TEMP1.MP1.                                                                 | PRINT/NOPRINT     | <pre>&gt; SYSTEM/LINK86 PROG.OBJ TO &amp;&lt;cr&gt; &gt;&gt;WORKDISK/TEMP1.TST PRINT&lt;cr&gt;</pre>                                                                                                                                                                                                                                                   |
| The print file is PROG.MP1.                                                                           |                   | <pre>&gt; LINK86 PROG.OBJ&lt;cr&gt;</pre>                                                                                                                                                                                                                                                                                                              |
| The print file is THE.MAP.                                                                            |                   | <pre>&gt; LINK86 PROG.OBJ, USER.LIB &amp;&lt;cr&gt; &gt;&gt;PRINT(THE.MAP)&lt;cr&gt;</pre>                                                                                                                                                                                                                                                             |
| This example removes information about line numbers, local symbols, and comments from the print file. | PRINTCONTROLS     | <pre>&gt; SYSTEM/LINK86 MYDISK/TEMP.OBJ &amp;&lt;cr&gt; &gt;&gt;BIND PRINTCONTROLS(NOLINES, &amp;&lt;cr&gt; &gt;&gt;NOCOMMENTS, NOSYMBOLS)&lt;cr&gt;</pre>                                                                                                                                                                                             |
| This statement removes all but the segment information and error messages from the print file.        |                   | <pre>&gt; LINK86 PAS/PASCL1.OBJ &amp;&lt;cr&gt; &gt;&gt;PRINTCONTROLS(PURGE)&lt;cr&gt;</pre>                                                                                                                                                                                                                                                           |

| Comments                                                                                                                                                                | Control           | Examples                                                                                                                                                                                                    |
|-------------------------------------------------------------------------------------------------------------------------------------------------------------------------|-------------------|-------------------------------------------------------------------------------------------------------------------------------------------------------------------------------------------------------------|
| Public information concerning only DATA1, DATA2, LABEL3, and PROC4 is placed in the object file and print file.                                                         | PUBLICS/NOPUBLICS | <pre>&gt; LINK86 TEST.OBJ, USER.LIB &amp;&lt;cr&gt; &gt;&gt;NOPUBLICS EXCEPT(DATA1, DATA2, &amp;&lt;cr&gt; &gt;&gt;LABEL3, PROC4)&lt;cr&gt;</pre>                                                           |
| All public symbol information will be included in both the print file and the output file.                                                                              | PUBLICSONLY       | <pre>&gt; SYSTEM/LINK86 WORK/TEMP.OBJ, &amp;&lt;cr&gt; &gt;&gt;SYSTEM/SMALL.LIB, WORK/USER.LIB &amp;&lt;cr&gt; &gt;&gt;PUBLICS&lt;cr&gt;</pre>                                                              |
| This example will produce a file containing only the absolute public symbol records from 8089.LOC. The object file will be 8089.LNK.                                    | PUBLICSONLY       | <pre>&gt; LINK86 PUBLICSONLY(8089.LOC)&lt;cr&gt;</pre>                                                                                                                                                      |
| This example will resolve the references in WORK/PLM/ROOT.OBJ to absolute public symbols in the separately linked and located overlays WORK/PLM/OVL1 and WORK/PLM/OVL2. | PURGE/NOPURGE     | <pre>&gt; LINK86 WORK/PLM/ROOT.OBJ, &amp;&lt;cr&gt; &gt;&gt;PUBLICSONLY(WORK/PLM/OVL1, &amp;&lt;cr&gt; &gt;&gt;WORK/PLM/OVL2)&lt;cr&gt;</pre>                                                               |
| This example produces an object file containing no debug or public information.                                                                                         | PURGE/NOPURGE     | <pre>&gt; SYSTEM/LINK86 WORK/INDEX.OBJ, &amp;&lt;cr&gt;</pre>                                                                                                                                               |
| This confirms that the line and symbol information should be kept in the print file.                                                                                    | RENAMEGROUPS      | <pre>&gt; LINK86 FINAL.OBJ PRINTCONTROLS &amp;&lt;cr&gt; &gt;&gt;(NOPURGE)&lt;cr&gt;</pre>                                                                                                                  |
| This will change the translator-assigned name CGROUP to THE@CODE. A subsequent linkage would not combine THE@CODE with a group named CGROUP.                            | RENAMEGROUPS      | <pre>&gt; LINK86 PLMPRG.OBJ RENAMEGROUPS &amp;&lt;cr&gt; &gt;&gt;(CGROUP TO THE@CODE)&lt;cr&gt;</pre>                                                                                                       |
| This example changes the name of the CODE group to CGROUP.                                                                                                              | SEGSIZE           | <pre>&gt; LINK86 ASMPRG.OBJ &amp;&lt;cr&gt; &gt;&gt;RENAMEGROUPS(CODE TO CGROUP)&lt;cr&gt;</pre>                                                                                                            |
| This tells the loader that 15FFH bytes of code is the maximum requirement for MEMORY. The new maximum size of MEMORY is 35FFH.                                          | SEGSIZE           | <pre>&gt; SYSTEM/LINK86 WORK/GEORGE.OBJ, &amp;&lt;cr&gt; &gt;&gt;WORK/PETER/USER.LIB, &amp;&lt;cr&gt; &gt;&gt;SYSTEM/SYSTEM.LIB BIND SEGSIZE &amp;&lt;cr&gt; &gt;&gt;(MEMORY(15FFH,+2000H))&lt;cr&gt;</pre> |
| This example increments MEMORY's minimum size by 1FFH (7951D) bytes. The maximum size of MEMORY is equal to the old minimum size plus 3FEH (15902D).                    | SYMBOLS/NOSYMBOLS | <pre>&gt; LINK86 PROJCT.OBJ, &amp;&lt;cr&gt; &gt;&gt;REST.LIB SEGSIZE(MEMORY &amp;&lt;cr&gt; &gt;&gt;(+1FF,+1FF))&lt;cr&gt;</pre>                                                                           |
| The local symbol records will be included in the object file.                                                                                                           | SYMBOLS/NOSYMBOLS | <pre>&gt; LINK86 TEMP.OBJ, USER.LIB &amp;&lt;cr&gt; &gt;&gt;NOSYMBOLS SYMBOLS&lt;cr&gt;</pre>                                                                                                               |
| Purge is a shorthand for NOSYMBOLS, NOCOMMENTS, NOPUBLICS, NOTYPE, and NOLINES.                                                                                         | SYMBOLCOLUMNS     | <pre>&gt; SYSTEM/LINK86 USER/TEST.OBJ, &amp;&lt;cr&gt; &gt;&gt;SYSTEM/USER.LIB PURGE&lt;cr&gt;</pre>                                                                                                        |
| SYMBOLCOLUMNS has no effect, since BIND was not specified.                                                                                                              | SYMBOLCOLUMNS     | <pre>&gt; LINK86 TEST.OBJ SYMBOLCOLUMNS(1)&lt;cr&gt;</pre>                                                                                                                                                  |
| The symbol table will be printed on a line printer.                                                                                                                     | TYPE/NOTYPE       | <pre>&gt; LINK86 ROOT.LNK, OV1.LNK, &amp;&lt;cr&gt; &gt;&gt;OV2.LNK, PUBLICSONLY(8089) &amp;&lt;cr&gt; &gt;&gt;SYMBOLCOLUMNS(4) BIND PRINT(:LP) &lt;cr&gt;</pre>                                            |
| WORK/LIBMOD.OBJ will retain its type information.                                                                                                                       | TYPE/NOTYPE       | <pre>&gt; SYSTEM/LINK86 WORK/LIBMOD.OBJ TYPE&lt;cr&gt;</pre>                                                                                                                                                |

| Comments                                                                                                                                           | Control    | Examples                                                                                                                                                                                               |
|----------------------------------------------------------------------------------------------------------------------------------------------------|------------|--------------------------------------------------------------------------------------------------------------------------------------------------------------------------------------------------------|
| The cross-reference listing will have 35 lines on each page.                                                                                       | PAGELENGTH | > CREF86 FILE1, FILE.LIB &<cr><br>>>PAGELENGTH(35)<cr>                                                                                                                                                 |
| The cross-reference listing will be 100 characters wide maximum per page.                                                                          | PAGEWIDTH  | > SYSTEM/CREF86 WORK/PROG, &<cr><br>>>SYSTEM/LIB(MOD1) PAGEWIDTH(100)<cr>                                                                                                                              |
| The pathname of the print file will be MYFILE.                                                                                                     | PRINT      | > CREF86 FILES(MODULE1, &<cr><br>>>MODULE2) PRINT(MYFILE)<cr>                                                                                                                                          |
| The message in the TITLE control must be placed on one line. If the message contains special characters, it must be enclosed in single quotes ('). | TITLE      | > SYSTEM/CREF86 MINE/PROGA, &<cr><br>>>HIS/PROGB, HERS/PROGC, &<cr><br>>>LIBA/MYLIB, LIBB/HISLIB, &<cr><br>>>LIBC/HERLIB TITLE &<cr><br>>>('A COMBINED CROSS-REFERENCE') &<cr><br>>>PAGEWIDTH(105)<cr> |

| Comments                                                                  | Control | Examples                                                                                                                                                                                                                                                                  |
|---------------------------------------------------------------------------|---------|---------------------------------------------------------------------------------------------------------------------------------------------------------------------------------------------------------------------------------------------------------------------------|
| Three object files are added to the USER.LIB.                             | ADD     | *ADD SIN, COS, TAN TO USER.LIB<cr><br>*                                                                                                                                                                                                                                   |
| Three modules from the library WORK/LIB.ABC are added to SYSTEM/PROG.TOM. |         | *ADD WORK/LIB.ABC(MOD1, MOD2, &<cr><br>**MOD3) TO SYSTEM/PROG.TOM<cr><br>*                                                                                                                                                                                                |
| This command will produce an empty library file called SYSTEM/TOMS.LIB.   | CREATE  | *CREATE SYSTEM/TOMS.LIB<cr><br>*                                                                                                                                                                                                                                          |
|                                                                           |         | *CREATE WORK/USER.LIB<cr><br>*                                                                                                                                                                                                                                            |
| Four modules are deleted from the library USER.LIB.                       | DELETE  | *DELETE USER.LIB(TEMP1, TEMP3, &<cr><br>**TEMP_TMP, TEST?)<cr><br>*                                                                                                                                                                                                       |
|                                                                           |         | *DELETE WORK/IO.LIB(FLOPPY,CRT, &<cr><br>**PAPER_TAPE)<cr><br>*                                                                                                                                                                                                           |
|                                                                           | EXIT    | *EXIT<cr><br>>                                                                                                                                                                                                                                                            |
|                                                                           | LIST    | *LIST USER.LIB<cr><br>USER.LIB<br>TEMP<br>TEST<br>EXEC<br>MAIN<br>LOOP<br>*LIST USER.LIB(TEMP,TEST)<cr><br>USER.LIB<br>TEMP<br>TEST<br>*LIST USER.LIB,TEMP.LIB<cr><br>USER.LIB<br>TEMP<br>TEST<br>EXEC<br>MAIN<br>LOOP<br>TEMP.LIB<br>MODULE1<br>MODULE3<br>MODULETC<br>* |

**Comments**

If SEG1 is byte alignable, it will be located at 15FFH. If SEG2 is byte or word alignable, it will be at 4F5AH.

Address assignment of groups, segments, and classes can be in any order, unless they are absolute.

A long jump to GO will be placed at location 0FFFF0H.

The initialization code is placed at address 32768 decimal (8000H).

No initialization code will be produced.

Lines is the default, so it need not be specified.

This statement removes all debug records from the object file, but keeps the information in the print file.

NOPUBLICS is implied by PURGE, but PUBLICS overrides it.

SEG@A of CLASS1 will be the first relocatable segment located. SEG@B will be the next, followed immediately by any other segments contained within CLASS1. The extra segments in CLASS1 (and all of the segments in CLASS2) are located in the order in which they are encountered. Finally, the list in the SEGMENTS subcontrol is handled.

**Control****ADDRESSES****BOOTSTRAP****COMMENTS/NOCOMMENTS****INITCODE/NOINITCODE****LINES/NOLINES****MAP/NOMAP****NAME****OBJECTCONTROLS****ORDER****Examples**

```
> LOC86 COME.LNK TO WENT &<cr>
>>ADDRESSES(SEGMENTS(SEG1\CLASS2)&<cr>
>>OVERLAY3(15FFH), SEG2(4F5AH))<cr>

> LOC86 IST.LNK TO LOCIST.RDY &<cr>
>>ADDRESSES(SEGMENTS &<cr>
>>(SEG1\CLASS1(23H)), &<cr>
>>GROUPS(CGROU(00H), &<cr>
>>DGROUP(10000H)), &<cr>
>>CLASSES(MEMORY(15000H)))<cr>

> SYSTEM/LOC86 WORK/TEST.LNK &<cr>
>>START(GO) BOOTSTRAP<cr>

> LOC86 SOURCE.LNK NOCOMMENTS<cr>

> LOC86 TEMP.LNK COMMENTS<cr>

> SYSTEM/LOC86 HISDISK/PLM/FORK.LNK &<cr>
>>INITCODE(32768)<cr>

> LOC86 TEST.LNK NOINITCODE<cr>

> LOC86 RUN.LNK NOLINES<cr>

> LOC86 TEST.LNK<cr>

> SYSTEM/LOC86 WORK/TESTER.LNK MAP<cr>

> LOC86 GONE.LNK TO HERMAF.OVY NOMAP<cr>

> LOC86 SHORT.LNK NAME &<cr>
>>(THIS_IS_A_VERY_LONG_MODULE@NAME.)<cr>

> LOC86 UPWARD.LNK OBJECTCONTROLS &<cr>
>>(NOLINES,NOCOMMENTS,NOSYMBOLS)<cr>

> LOC86 PASCL1.LNK OBJECTCONTROLS &<cr>
>>(PURGE, PUBLICS)<cr>

> LOC86 SPCSEQ.LNK ORDER &<cr>
>>(CLASSES(CLASS1(SEG@A, SEG@B), &<cr>
>>CLASS2), SEGMENTS &<cr>
>>(SEG1\CLASS3\OVERLAY1, &<cr>
>>SEG22,SEG10\CLASS5))<cr>
```

| Comments                                                                                                              | Control                                                                                           | Examples                                                            |
|-----------------------------------------------------------------------------------------------------------------------|---------------------------------------------------------------------------------------------------|---------------------------------------------------------------------|
| The print file is TEMP1.MP2.                                                                                          | <b>PRINT/NOPRINT</b>                                                                              | > LOC86 PROG.LNK TO TEMP1.TST PRINT<cr>                             |
| The print file is WORK/INTERP.MP2.                                                                                    |                                                                                                   | > SYSTEM/LOC86 WORK/INTERP.LNK<cr>                                  |
| The print file is MAP.                                                                                                |                                                                                                   | > LOC86 PROG.LNK PRINT(MAP)<cr>                                     |
| Information about line numbers is removed from the print file.                                                        | <b>PRINTCONTROLS</b>                                                                              | > LOC86 LINEAR.LNK &<cr><br>>>PRINTCONTROLS(NOLINES)<cr>            |
| All but the segment information is removed from the print file.                                                       |                                                                                                   | > SYSTEM/HIS/LOC86 PLM/PROG.LNK &<cr><br>>>PRINTCONTROLS(PURGE)<cr> |
| No public information is included in the output files (PRIVAT.MP2 and PRIVAT).                                        |                                                                                                   | <b>PUBLICS/NOPUBLICS</b>                                            |
| All public symbol information will be included in both the print file and the output file.                            | > LOC86 TEXT.LNK NOPUBLICS PUBLICS<cr>                                                            |                                                                     |
| The object file contains no public or debug information, and the symbol table does not appear in the print file.      | <b>PURGE/NOPURGE</b>                                                                              |                                                                     |
| The line and symbol information will be kept in the print file and object file.                                       |                                                                                                   | > LOC86 80209.LNK PURGE &<cr><br>>>PRINTCONTROLS(NOPURGE)<cr>       |
| This control reserves the high order 64K of memory.                                                                   |                                                                                                   | <b>RESERVE</b>                                                      |
| A 200H and a 100H section of memory at the top and bottom of memory are reserved.                                     | > SYSTEM/LOC86 ASM/HUGOS.LNK &<cr><br>>>RESERVE(00H TO 0200H, &<cr><br>>>0FFF00H TO 0FFFFFFH)<cr> |                                                                     |
| The size of segment MEMORY will be increased by 2000 bytes.                                                           | <b>SEGSIZE</b>                                                                                    |                                                                     |
| The size of segment FREUD will be decreased by 511 bytes.                                                             |                                                                                                   | > LOC86 SHRINK.LNK SEGSIZE &<cr><br>>>(FREUD(-1FFH))<cr>            |
| The new segment size for XENDA is 7770 bytes.                                                                         |                                                                                                   | > SYSTEM/LOC86 SAL/RPLACE.LNK &<cr><br>>>SEGSIZE(XENDA(7770))<cr>   |
| AUTO will start at IGNITION.                                                                                          | <b>START</b>                                                                                      | > LOC86 AUTO.LNK START(IGNITION)<cr>                                |
| HALTS will start at location 200H.                                                                                    |                                                                                                   | > LOC86 HALTS.LNK START(00H, 200H)<cr>                              |
| This statement will include the local symbol records in the object file and the symbol information in the print file. | <b>SYMBOLS/NOSYMBOLS</b>                                                                          | > /SYS/LOC86 GERTIE/GESTA.LNK SYMBOLS<cr>                           |
| PURGE is a shorthand for NOSYMBOLS, NOCOMMENTS, NOPUBLICS, and NOLINES.                                               |                                                                                                   | > LOC86 TEST.LNK PURGE<cr>                                          |
| The symbol table will be printed on a line printer. A line printer line can hold a four-column symbol table.          | <b>SYMBOLCOLUMNS</b>                                                                              | > LOC86 LINKED.LNK SYMBOLCOLUMNS(4) &<cr><br>>>PRINT(:LP:)<cr>      |

- absolute object file formats, A-1
  - absolute object modules, 1-2
  - AD, 5-3
  - address,
    - in ADDRESSES control, 5-3
    - in ASSIGN control, 2-4
    - in INITCODE control, 5-6
    - in RESERVE control, 5-16
  - ADDRESSES, 5-3
  - addressing,
    - A, 4-2
    - absolute, 1-4, 2-4
    - ADD, 4-2
    - 8086, 1-5
    - relative, 1-4
  - alignment,
    - boundaries, 1-8
    - of segments, 1-7
  - AR, 2-5
  - AS, 2-4
  - ASSIGN, 2-4
  - available memory, effect of, C-1
- 
- BI, 2-6
  - BIND, 2-6
  - BOOTSTRAP, 5-4
  - bound modules (*see LTL modules*)
  - BS, 5-4
- 
- C, 4-3
  - class, 8086, 1-9
  - CLASSES, 5-3, 5-11
  - class name,
    - in ADDRESSES control, 5-3
    - in ORDER control,
      - LINK86, 2-15
      - LOC86, 5-11
    - in SEGSIZE control,
      - LINK86, 2-23
      - LOC86, 5-17
  - CM, 2-7
  - COMMENTS,
    - in OBJECTCONTROLS,
      - LINK86, 2-14
      - LOC86, 5-10
    - in PRINTCONTROLS,
      - LINK86, 2-18
      - LOC86, 5-13
    - LINK86 control, 2-7
    - LOC86 control, 5-5
  - control summary,
    - CREF86, E-1
    - LIB86, F-1
    - LINK86, D-1
    - LOC86, G-1
  - CREATE, 4-3
  - CREF86,
    - controls,
      - PAGELength, 3-3
      - PAGEWIDTH, 3-4
      - PRINT, 3-5
      - TITLE, 3-6
    - control summary, 3-2
    - error messages, E-1
    - in development process, 1-1
    - input, 3-1
    - invocation, 3-2
    - iRMX 86 invocation examples, J-19/J-20
    - output, 3-1
    - print file, 3-7
    - Series III invocation examples, I-23/I-24
    - Series IV invocation examples, K-23/K-24
    - use of libraries, 1-3
  - cross-reference listing, 3-7
  - CS, 5-3, 5-11
- 
- D, 4-3
  - data records, 8086, A-3
  - debug records,
    - LINK86, 2-21
    - LOC86, 5-15
  - DELETE, 4-3
- 
- E, 4-4
  - ENDREC, A-7
  - error messages,
    - CREF86, E-1
    - LIB86, F-1
    - LINK86, D-2
    - LOC86, G-2
    - OH86, H-1
  - examples, iRMX 86
    - invocation,
      - CREF86, J-19/J-20
      - LIB86, J-21/J-22
      - LINK86, J-13/J-14
      - LOC86, J-23/J-24
      - OH86, J-12
    - program development
      - CREF86, J-3
      - LIB86, J-5
      - LINK86, J-6, J-9
      - LOC86, J-10
  - examples, Series III,
    - invocation,
      - CREF86, I-23/I-24
      - LIB86, I-25/I-26
      - LINK86, I-17/I-18
      - LOC86, I-27/I-28
      - OH86, I-15
    - program development,
      - CREF86, I-6
      - LIB86, I-7
      - LINK86, I-2, I-5, I-8, I-11, I-14
      - LOC86, I-4, I-5, I-8, I-12



- examples, Series IV
  - invocation,
    - CREF86, K-23/K-24
    - LIB86, K-25/K-26
    - LINK86, K-17/K-18
    - LOC86, K-27/K-28
    - OH86, K-15
  - program development,
    - CREF86, K-5
    - LIB86, K-6
    - LINK86, K-2, K-4, K-8, K-11, K-12, K-14
    - LOC86, K-4, K-8, K-12
- EXIT, 4-4
- external references,
  - cross-reference listing, 3-7
  - definition of, 1-2
  - resolution of, 1-3
- FASTLOAD, 2-8
- FL, 2-8
- GR, 5-3
- group,
  - addressing, 1-9
  - 8086, 1-9
- group map, 2-27
- group name,
  - in ADDRESSES control, 5-3
  - in LINK86 ORDER control, 2-15
  - in LINK86 RENAMGROUP control, 2-22
- GROUPS, 5-3
- hexadecimal-decimal conversion, B-1
- hexadecimal object file format,
  - conversion to, 6-1
  - records of,
    - data, A-13
    - end of file, A-15
    - extended address, A-12
    - start address, A-14
- IC,
  - LINK86, 2-9
  - LOC86, 5-6
- INITCODE,
  - LINK86, 2-9
  - LOC86, 5-6
- initialization code,
  - LINK86, 2-9
  - LOC86, 5-6
- input list control, 2-20
- iRMX 86 information,
  - continuation-line characters, J-2
  - environmental conditions, J-1
  - examples, J-12
  - file-naming conventions, J-2
  - generation of code, J-3
  - invocation, J-1
  - memory requirements, J-1
  - program development examples, J-3
  - prompts, J-2
  - related publications, J-2
- L, 4-6
- LHEADR, A-6
- LI,
  - LINK86, 2-10
  - LOC86, 5-7
- LIB86,
  - commands,
    - ADD, 4-2
    - CREATE, 4-3
    - DELETE, 4-4
    - EXIT, 4-5
    - LIST, 4-6
  - command summary, 4-1, F-1
  - error messages, F-1
  - in development process, 1-1
  - input, 4-1
  - invocation, 4-1
  - iRMX 86 invocation examples, J-21/J-22
  - Series III invocation examples, I-25/I-26
  - Series IV invocation examples, K-25/K-26
- librarian (see *LIB86*)
- libraries,
  - adding to, 4-2
  - creating, 4-3
  - deleting from, 4-4
  - listing contents of, 4-6
  - use of by CREF86, 1-3
  - use of by LINK86, 1-3
- line number control,
  - LINK86, 2-10
  - LOC86, 5-7
- LINES,
  - in OBJECTCONTROLS,
    - LINK86, 2-14
    - LOC86, 5-10
  - in PRINTCONTROLS,
    - LINK86, 2-18
    - LOC86, 5-13
  - LINK86, 2-10
  - LOC86, 5-7
- link map, 2-27
- linkage (see *LINK86*)
- LINK86,
  - and LOC86, 1-4
  - controls,
    - ASSIGN, 2-4
    - ASSUMEROOT, 2-5
    - BIND, 2-6
    - COMMENTS, 2-7
    - FASTLOAD, 2-8
    - INITCODE, 2-9
    - LINES, 2-10
    - MAP, 2-11
    - MEMPOOL, 2-12
    - NAME, 2-13
    - NOBIND, 2-6
    - NOCOMMENTS, 2-7
    - NOFASTLOAD, 2-8
    - NOLINES, 2-10
    - NOMAP, 2-11
    - NOOVERLAY, 2-16
    - NOPRINT, 2-17
    - NOPUBLICS, 2-19
    - NOPURGE, 2-21

- NOSYMBOLS, 2-24
- NOTYPE, 2-26
- OBJECTCONTROLS, 2-14
- ORDER, 2-15
- OVERLAY, 2-16
- PRINT, 2-17
- PRINTCONTROLS, 5-12
- PUBLICS, 2-19
- PUBLICSONLY, 2-20
- PURGE, 2-21
- RENAMEGROUPS, 2-22
- SEGSIZE, 2-23
- SYMBOLCOLUMNS, 2-25
- SYMBOLS, 2-24
  - TYPE, 2-26
- control summary, 2-2, D-1
- error messages, D-2
- in development process, 1-1
- input, 1-4, 2-1, 2-20
- invocation, 2-1
- iRMX 86 invocation examples, J-13/J-14
- output, 1-4, 2-1
- print file, 2-27
- segment combination, 1-7
- Series III invocation examples, I-17/I-18
- Series IV invocation examples, K-17/K-18
- use of libraries, 1-3
- LIST, 4-6
- load-time-locatable module (*see LTL module*)
- location (*see LOC86*)
- location algorithm,
  - for modules with overlays, 5-25
  - for segments, 5-24
- LOC86,
  - and LINK86, 1-4
  - controls,
    - ADDRESSES, 5-3
    - BOOTSTRAP, 5-4
    - COMMENTS, 5-5
    - INITCODE, 5-6
    - LINES, 5-7
    - MAP, 5-8
    - NAME, 5-9
    - NOCOMMENTS, 5-5
    - NOINITCODE, 5-6
    - NOLINES, 5-7
    - NOMAP, 5-8
    - NOPRINT, 5-12
    - NOPUBLICS, 5-14
    - NOPURGE, 5-15
    - NOSYMBOLS, 5-19
    - OBJECTCONTROLS, 5-10
    - ORDER, 5-11
    - PRINT, 5-12
    - PRINTCONTROLS, 5-13
    - PUBLICS, 5-14
    - PURGE, 5-15
    - RESERVE, 5-16
    - SEGSIZE, 5-17
    - START, 5-18
    - SYMBOLS, 5-19
    - SYMBOLCOLUMNS, 5-19
  - control summary, 5-2, G-1
  - error messages, G-2
  - in development process, 1-1
  - input, 1-4, 5-1
  - invocation, 2-1
  - iRMX 86 invocation examples, J-23/J-24
  - output, 1-4, 5-1
  - print file, 5-21
  - Series III invocation examples, I-27/I-28
  - Series IV invocation examples, K-27/K-28
- LTL controls,
  - BIND, 2-6
  - FASTLOAD, 2-8
  - MEMPOOL, 2-12
  - ORDER, 2-15
  - PRINTCONTROLS, 2-18
  - SEGSIZE, 2-23
  - SYMBOLCOLUMNS, 2-25
- LTL modules, 1-2, 1-4, 1-10
- MA,
  - LINK86, 2-11
  - LOC86, 5-8
- MAP,
  - LINK86, 2-11
  - LOC86, 5-8
- maximum-size,
  - in MEMPOOL control, 2-12
  - in SEGSIZE control, 2-23
- memory,
  - configuration with overlays, 1-10
  - 8086, 1-5
- memory map, 5-23
- memory requirements controls,
  - LINK86 MEMPOOL, 2-12
  - SEGSIZE,
    - LINK86, 2-23
    - LOC86, 5-17
- MEMPOOL, 2-12
- minimum-size,
  - in MEMPOOL control, 2-12
  - in SEGSIZE control, 2-23
- MODEND, A-9
- module attributes, A-2
- module identification, A-2
- module name,
  - in LINK86 NAME control, 2-13
  - in LOC86 NAME control, 5-9
- MP, 2-12
- NA,
  - LINK86, 2-13
  - LOC86, 5-9
- NAME
  - LINK86, 2-13
  - LOC86, 5-9
- naming output module,
  - LINK86, 2-13
  - LOC86, 5-9
- NOBI, 2-6
- NOBIND, 2-6
- NOCM, 2-7

- NOCOMMENTS,
  - in OBJECTCONTROLS,
    - LINK86, 2-14
    - LOC86, 5-10
  - in PRINTCONTROLS,
    - LINK86, 2-18
    - LOC86, 5-13
  - LINK86, 2-7
  - LOC86, 5-5
- NOFASTLOAD, 2-8
- NOFL, 2-8
- NOIC, 5-6
- NOINITCODE, 5-6
- NOLI,
  - LINK86, 2-10
  - LOC86, 5-7
- NOLINES,
  - in OBJECTCONTROLS,
    - LINK86, 2-14
    - LOC86, 5-10
  - in PRINTCONTROLS,
    - LINK86, 2-18
    - LOC86, 5-13
  - LINK86, 2-10
  - LOC86, 5-7
- NOMA,
  - LINK86, 2-11
  - LOC86, 5-8
- NOMAP
  - LINK86, 2-11
  - LOC86, 5-8
- NOOV, 2-16
- NOOVERLAY, 2-16
- NOPL,
  - LINK86, 2-19
  - LOC86, 5-14
- NOPR,
  - LINK86, 2-17
  - LOC86, 5-12
- NOPRINT,
  - LINK86, 2-17
  - LOC86, 5-12
- NOPU,
  - LINK86, 2-21
  - LOC86, 5-15
- NOPUBLICS,
  - in OBJECTCONTROLS,
    - LINK86, 2-14
    - LOC86, 5-10
  - in PRINTCONTROLS,
    - LINK86, 2-18
    - LOC86, 5-13
  - LINK86, 2-19
  - LOC86, 5-14
- NOPURGE,
  - in OBJECTCONTROLS,
    - LINK86, 2-14
    - LOC86, 5-10
  - in PRINTCONTROLS,
    - LINK86, 2-18
    - LOC86, 5-13
  - LINK86, 2-21
  - LOC86, 5-15
- NOSB,
  - LINK86, 2-24
  - LOC86, 5-19
- NOSYMBOLS,
  - in OBJECTCONTROLS,
    - LINK86, 2-14
    - LOC86, 5-10
  - in PRINTCONTROLS,
    - LINK86, 2-18
    - LOC86, 5-13
  - LINK86, 2-24
  - LOC86, 5-19
- NOTY, 2-26
- NOTYPE,
  - in OBJECTCONTROLS, 2-14
  - in PRINTCONTROLS, 2-18
  - LINK86, 2-26
- OBJECTCONTROLS,
  - LINK86, 2-14
  - LOC86, 5-10
- object module format, 1-4, A-1
- OC,
  - LINK86, 2-14
  - LOC86, 5-10
- OD,
  - LINK86, 2-15
  - LOC86, 5-11
- offset, 5-18
- OH86,
  - error messages, H-1
  - in development process, 1-1
  - input, 6-1
  - invocation, 6-1
  - iRMX 86 invocation examples, J-12
  - output, 6-1
  - Series III invocation example, I-15
- ORDER,
  - LINK86, 2-15
  - LOC86, 5-11
- OV, 2-16
- OVERLAY, 2-16
- overlay controls,
  - ASSUMEROOT, 2-5
  - OVERLAY, 2-16
- overlay, 8086, 1-10
- overlay name,
  - ADDRESSES, 5-3
  - LINK86 ORDER control, 2-15
  - LINK86 OVERLAY control, 2-16
  - SEGSIZE,
    - LINK86, 2-23
    - LOC86, 5-17
- overlays and location, 5-25
- OVLDEF, A-7
- PAGELength, 3-3
- PAGEWIDTH, 3-4
- paragraph, 5-18

- pathname,
  - in ASSUMEROOT control, 2-5
  - in LIB86 commands, 4-1
  - in PRINT control,
    - LINK86, 2-17
    - LOC86, 5-12
  - in PUBLICSONLY control, 2-20
- PC,
  - LINK86, 2-18
  - LOC86, 5-13
- PEDATA, A-10
- performance-memory relationship, C-1
- PIC, 1-10
- PIDATA, A-10
- PL,
  - CREF86, 3-3
  - LINK86, 2-19
  - LOC86, 5-14
- PO, 2-20
- position-independent code (see PIC)
- PR,
  - CREF86, 3-5
  - LINK86, 2-17
  - LOC86, 5-12
- PRINT,
  - CREF86, 3-5
  - LINK86, 2-17
  - LOC86, 5-12
- PRINTCONTROLS,
  - LINK86, 2-18
  - LOC86, 5-13
- print file,
  - controls,
    - CREF86, 3-2
    - LINK86, 2-18
    - LOC86, 5-13
  - CREF86,
    - cross-reference information, 3-8
    - header, 3-7
    - module list, 3-8
    - warnings, 3-7
  - LINK86,
    - error messages, 2-30
    - group map, 2-28
    - header, 2-27
    - link map, 2-11, 2-27
    - symbol table, 2-29
  - LOC86,
    - errors and warnings, 5-24
    - memory map, 5-23
    - symbol table, 5-21
- print file name,
  - LINK86, 2-17
  - LOC86, 5-12
- program development, 1-1
- PU,
  - LINK86, 2-21
  - LOC86, 5-15
- PUBLICS,
  - in LIB86 LIST control, 4-6
  - in OBJECTCONTROLS,
    - LINK86, 2-14
    - LOC86, 5-10
- in PRINTCONTROLS,
  - LINK86, 2-18
  - LOC86, 5-13
- LINK86, 2-19
- LOC86, 5-14
- PUBLICSONLY, 2-20
- public symbol, 1-2, 5-18
- public symbol cross-references, 3-7
- public symbol records,
  - in libraries, 4-6
  - LINK86,
    - PUBLICS/NOPUBLICS, 2-19
    - PUBLICSONLY, 2-20
  - LOC86, 5-14
- PURGE,
  - in OBJECTCONTROLS,
    - LINK86, 2-14
    - LOC86, 5-10
  - in PRINTCONTROLS,
    - LINK86, 2-18
    - LOC86, 5-13
  - LINK86, 2-21
  - LOC86, 5-15
- PW, 3-4
- record formats,
  - end, A-7
  - L-module header, A-6
  - module end, A-9
  - overlay definition, A-7
  - physical enumerated data, A-10
  - physical iterated data, A-10
  - register initialization, A-8
  - R-module header, A-6
  - sample, A-4
  - T-module header, A-5
- record syntax, A-3
- REGINT, A-8
- register initialization, 2-9, 5-6, A-8
- relocatable object module, 1-2
- relocation (see *LOC86*)
- RENAMEGROUPS, 2-22
- RESERVE, 5-16
- RG, 2-22
- RHEADR, A-6
- RS, 5-16
- SAMREC, A-4
- SB,
  - LINK86, 2-24
  - LOC86, 5-19
- SC,
  - LINK86, 2-25
  - LOC86, 5-20
- segment,
  - alignment, 1-7, 2-28
  - combining, 1-8

- 8086, 1-6, A-2
- locating, 1-8, 5-24
- memory, 1-8, 2-23, 5-17
- ordering,
  - LINK86, 2-15
  - LOC86, 5-11, 5-24
- stack, 1-8
- segment addressability, A-2
- segment location algorithm,
  - absolute segments, 5-24
  - relocatable segments, 5-25
- segment ordering, 5-24
- segment map, 2-29
- segment name,
  - in ADDRESS control, 5-3
  - in ORDER control,
    - LINK86, 2-15
    - LOC86, 5-11
  - in SEGSIZE control,
    - LINK86, 2-23
    - LOC86, 5-17
- SEGMENTS, 5-3
- SEGSIZE,
  - LINK86, 2-23
  - LOC86, 5-17
- Series III information,
  - continuation-line characters, I-1
  - environmental considerations, I-1
  - ISIS-II conventions, I-1
  - program development examples, I-2
  - prompts, I-1
  - related publications, I-2
  - software version compatibilities, I-1
- Series IV information,
  - continuation-line characters, K-1
  - environmental considerations, K-1
  - iNDX conventions, K-1
  - pathnames, K-1
  - program development examples, K-2
  - prompts, K-1
  - related publications, K-2
  - software version compatibilities, K-2
- size, 5-17
- SM, 5-3, 5-11
- SS,
  - LINK86, 2-23
  - LOC86, 5-17
- ST, 5-18
- START, 5-18
- start address, 5-4, 5-18
- SYMBOLCOLUMNS,
  - LINK86, 2-25
  - LOC86, 5-20
- SYMBOLS,
  - in OBJECTCONTROLS,
    - LINK6, 2-14
    - LOC86, 5-10
  - in PRINTCONTROLS,
    - LINK86, 2-18
    - LOC86, 5-13
  - LINK86, 2-24
  - LOC86, 5-19
- symbol table,
  - LINK86, 2-25, 2-29
  - LOC86, 5-20, 5-21
- THEADR, A-5
- TITLE, 3-6
- TT, 3-6
- TY, 2-26
- TYPE,
  - in OBJECTCONTROLS, 2-14
  - in PRINTCONTROLS, 2-18
  - LINK86 control, 2-26
- type checking, 2-26
- variable name, 2-4



## REQUEST FOR READER'S COMMENTS

Intel's Technical Publications Departments attempt to provide publications that meet the needs of all Intel product users. This form lets you participate directly in the publication process. Your comments will help us correct and improve our publications. Please take a few minutes to respond.

Please restrict your comments to the usability, accuracy, readability, organization, and completeness of this publication. If you have any comments on the product that this publication describes, please contact your Intel representative. If you wish to order publications, contact the Intel Literature Department (see page ii of this manual).

1. Please describe any errors you found in this publication (include page number).

---

---

---

---

---

---

2. Does the publication cover the information you expected or required? Please make suggestions for improvement.

---

---

---

---

---

---

3. Is this the right type of publication for your needs? Is it at the right level? What other types of publications are needed?

---

---

---

---

---

---

4. Did you have any difficulty understanding descriptions or wording? Where?

---

---

---

---

---

---

5. Please rate this publication on a scale of 1 to 5 (5 being the best rating).

NAME \_\_\_\_\_ DATE \_\_\_\_\_  
TITLE \_\_\_\_\_  
COMPANY NAME/DEPARTMENT \_\_\_\_\_  
ADDRESS \_\_\_\_\_  
CITY \_\_\_\_\_ STATE \_\_\_\_\_ ZIP CODE \_\_\_\_\_  
(COUNTRY)

Please check here if you require a written reply.

**WE'D LIKE YOUR COMMENTS ...**

This document is one of a series describing Intel products. Your comments on the back of this form will help us produce better manuals. Each reply will be carefully reviewed by the responsible person. All comments and suggestions become the property of Intel Corporation.



**NO POSTAGE  
NECESSARY  
IF MAILED  
IN U.S.A.**



**BUSINESS REPLY MAIL**  
FIRST CLASS PERMIT NO. 1040 SANTA CLARA, CA

POSTAGE WILL BE PAID BY ADDRESSEE

**Intel Corporation  
Attn: Technical Publications M/S 6-2000  
3065 Bowers Avenue  
Santa Clara, CA 95051**





**INTEL CORPORATION, 3065 Bowers Avenue, Santa Clara, California 95051 (408) 987-8080**

Printed in U.S.A.

**MICROPROCESSORS**