

NCDware XRemote User's Manual

XRemote Version 2.3

Part Number 9300137

June 1991

Network Computing Devices, Inc.

350 North Bernardo Avenue

Mountain View, California 94043

(415) 694-0650

FAX: (415) 961-7711

Email: support@ncd.com

Notice

The information contained in this document is subject to change without notice.

Network Computing Devices, Inc. shall not be liable for errors contained herein or for incidental or consequential damages in connection with the furnishing, performance, or use of this material.

This document contains information which is protected by copyright. All rights are reserved. No part of this document may be photocopied, reproduced, or translated to another language without the prior written consent of Network Computing Devices, Inc.

Copyright © 1991 by Network Computing Devices, Inc.

Printed in U.S.A.

Trademarks

NCD14c, NCD15b, NCD16, NCD16e, NCD17c, NCD19, NCD19b, NCDnet, NCDware, and XRemote are trademarks of Network Computing Devices, Inc.

X Window System, X, and X11 are trademarks of the Massachusetts Institute of Technology.

DECnet, DECwindows, VMS, VAX, VT, and ULTRIX are trademarks of Digital Equipment Corporation.

Ethernet is a trademark of Xerox Corporation.

UNIX is a registered trademark of AT&T.

Sun Workstation and SunOS are trademarks of Sun Microsystems, Inc.

PS/2 and PC/AT are trademarks of IBM.

MS/DOS is a trademark of Microsoft Corporation.

LANCE is a trademark of Advanced Micro Devices, Inc.

SIMM is a trademark of Wang Laboratories, Inc.

Revision History

Part Number	Date	Description
9300056	April, 1990	First version of this manual. For XRemote software version 2.1.
9300098	October, 1990	For XRemote software version 2.2. Changes in setup menus; added information about X Window System; added information about troubleshooting; added reference manual pages for XRemote and <i>xinitremote</i> .
9300137	June, 1991	For XRemote software version 2.3. Changes in setup menus; window manager information revised; support of XRemote on VMS systems

Table of Contents

Preface	i
Organization of this Manual	i
Conventions.....	ii
Suggestions for Further Reading.....	iii
Chapter 1: Overview	1
Taking Inventory	1
Introduction.....	2
How XRemote Works.....	3
Software Components.....	4
Cable Requirements	4
Modem Requirements.....	5
Chapter 2: Setup Menus	7
Introduction.....	7
Main Menu.....	12
Sessions.....	14
Local Client.....	18
User Preferences	18
Configuration Menus.....	19
Information Menus.....	29
Memory Warnings.....	32

Chapter 3: Procedures	35
Serial Port Considerations.....	35
Setting up a Modem.....	37
Setting up a Direct Host Connection.....	38
Booting.....	39
Configuring a Display Station for XRemote.....	40
Dialing in from the Serial Session.....	43
Starting XRemote.....	44
Checking Diagnostics.....	45
Quitting XRemote.....	46
Chapter 4: The Window Manager	47
Window Manager Access.....	48
Window Functional Areas.....	48
Window Button Operations.....	51
Window Menu.....	54
Chapter 5: Troubleshooting	57
Interpreting Boot Monitor Messages.....	59
Troubleshooting the Serial Session.....	59
Troubleshooting Peripherals.....	60
Appendix A: Network Connection	61
Appendix B: Using a FastComm Modem	63
Appendix C: New Features	65
Support for VMS.....	65
Local Window Manager.....	65
Setup Menu Changes and Additions.....	66
Memory Requirements.....	66

Appendix D: Advanced User	67
XRemote vs. the Normal X Server.....	67
How XRemote Works.....	68
The XRemote Protocols.....	69
XRemote Tapes	70
Modems.....	70
Built-In Fonts.....	71
UNIX Host Configuration.....	73
VMS Host Configuration.....	76
Appendix E: UNIX Man Pages	83
Glossary	85

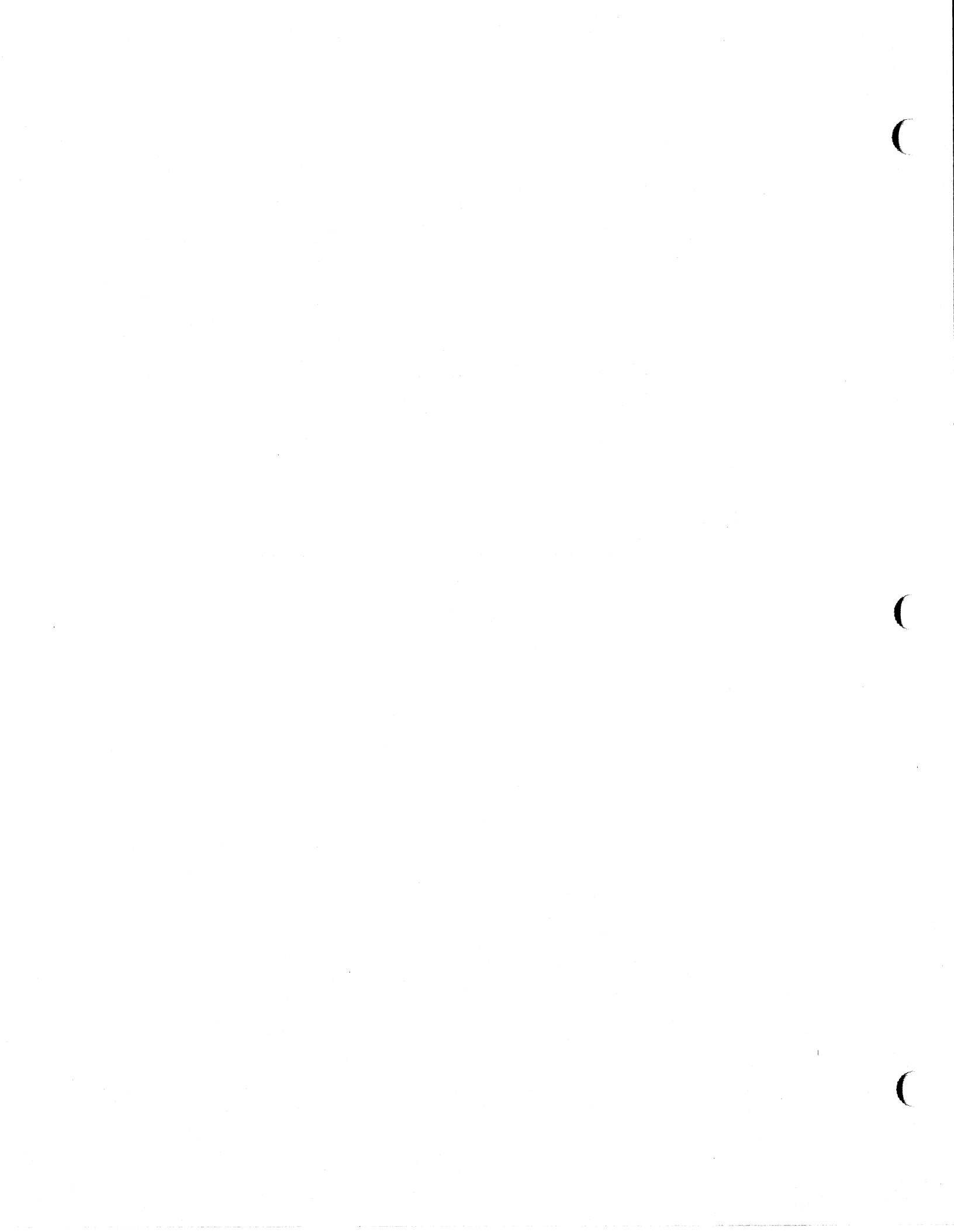

Preface

This manual tells you how to run NCD's XRemote software on your NCD network display station. XRemote lets NCD display stations communicate over serial lines with hosts running XRemote host software. You can use XRemote to run the X Window System on a host accessed directly over RS-232C cables or via modems.

This manual describes Version 2.3 of XRemote, which runs on all NCD network display stations.

Organization of this Manual

Chapter 1 — Overview gives a functional description of XRemote and describes its hardware and software components.

Chapter 2 — Setup Menus describes the XRemote setup menus used to configure your network display station for XRemote and monitor its performance.

Chapter 3 — Procedures tells you how to configure your display station for use with XRemote and how to run XRemote.

Chapter 4 — The Window Manager describes the mouse and keyboard commands available with NCDwm.

Chapter 5 — Troubleshooting offers tips for tracking down problems.

Appendix A — Network Connection explains how to connect an XRemote Display Station to a Network.

Appendix B — Using a FastComm Modem provides configuration information for attaching the modem to XRemote.

Appendix C — New Features lists what's new in this version of the software.

Appendix D — Advanced User provides extended information for users who want to configure their systems or require a better understanding of XRemote.

Appendix E — UNIX Man Pages contains system reference pages for XRemote and some of its NCD clients.

Glossary

We welcome any comments you may have concerning this manual. Address information including electronic mail and FAX is on the inside front cover.

Conventions

The following text formatting conventions are used in this document:

- Examples are indented from the surrounding text and set in smaller type. Terminal output is displayed in a constant-width font, and input is displayed in a bold font. For example, the `date` command and its output would look like:

```
% date
```

```
Mon Aug 7 10:19:12 PDT 1989
```

- References to commands and manual pages are set in bold italics. For example, the *`date(1)`* command was used above.
- References to directories and files appear in bold type; for example **Xncd16**.
- References to variable values are shown in italics; for example, *Xncdmmm*, where *mmm* may be any of the NCD models.
- References to other sections or chapters in this document appear inside double quotes; for example, this "Conventions" section.
- References to other NCD publications appear in italics; for example, *NCDware X Server User's Manual*.

Suggestions for Further Reading

NCD Documentation

NCD hardware manuals— Named after the display station it describes, each NCD hardware manual tells how to unpack, set up and boot an NCD network display station. Currently, the following manuals are available:

NCD14c User's Manual

NCD15b User's Manual

NCD16 User's Manual

NCD16e User's Manual

NCD17c User's Manual

NCD19 User's Manual

NCD19b User's Manual

For system administration information, see:

XRemote Tape Installation Instructions for UNIX Systems

XRemote Tape Installation Instructions for VAX/VMS

General X Documentation

The books listed below describe X in more detail. Several tell how to write applications for X. *X Window System, C Library and Protocol Reference*.

Robert W. Scheifler, James Gettys, Ron Newman. Digital Press.

"X Reference Set"

- *X Library Reference Guide*.
Ira Chayut and Camille Cook. A System Publications, Inc.
- *X User Reference Guide*.
Ira Chayut, Camille Cook, Anatole Olczak. A System Publications, Inc.
- *X Tool Kit Reference Manual*.
Ira Chayut. A System Publications, Inc.

"The Definitive Guides to the X Window System"

O'Reilly and Associates, Inc. has published a series of books on the X Window System. Their *X Window System User's Guide for Version 11*, by Tim O'Reilly, Valerie Quercia, and Linda Lamb, provides a thorough introduction to X for novices. The O'Reilly books are available at most computer book stores.

- *Volume Zero: X Protocol Reference Manual*.
Robert W. Scheifler. O'Reilly & Associates, Inc.
- *Volume One: Xlib Programming Manual*.
Adrian Nye. O'Reilly & Associates, Inc.
- *Volume Two: Xlib Reference Manual*.
Adrian Nye. O'Reilly & Associates, Inc.
- *Volume Three: X Window System User's Guide*.
Tim O'Reilly, Valerie Quercia, Linda Lamb. O'Reilly & Associates, Inc.

- *Volume Four: X Toolkit Intrinsic Programming Manual*
Adrian Nye and Tim O'Reilly. O'Reilly & Associates, Inc.
- *Volume Five: X Toolkit Intrinsic Reference Manual*
O'Reilly & Associates, Inc.

Introduction to the X Window System.

Oliver Jones. Prentice Hall, Inc.

X/Open Portability Guide; Window Management.

X/Open Company, Ltd. Prentice Hall.

X Window Systems: Programming and Applications with Xt.

Douglas A. Young. Prentice Hall.

X Manual Set (boxed 3-volume set).

A System Publications, Inc.

X Window Applications Programming.

Eric F. Johnson, Kevin Reichard. Management Information Source, Inc.

X Window Toolkit Programming.

Cimarron Taylor, Peter Shipley, Mark Yatabe, John Muster. Lurnix.

X Window System Toolkit

Paul J. Asente and Ralph R. Swick



Chapter 1: Overview

Taking Inventory	1
Introduction.....	2
How XRemote Works.....	3
Software Components.....	4
Cable Requirements	4
Modem Requirements.....	5

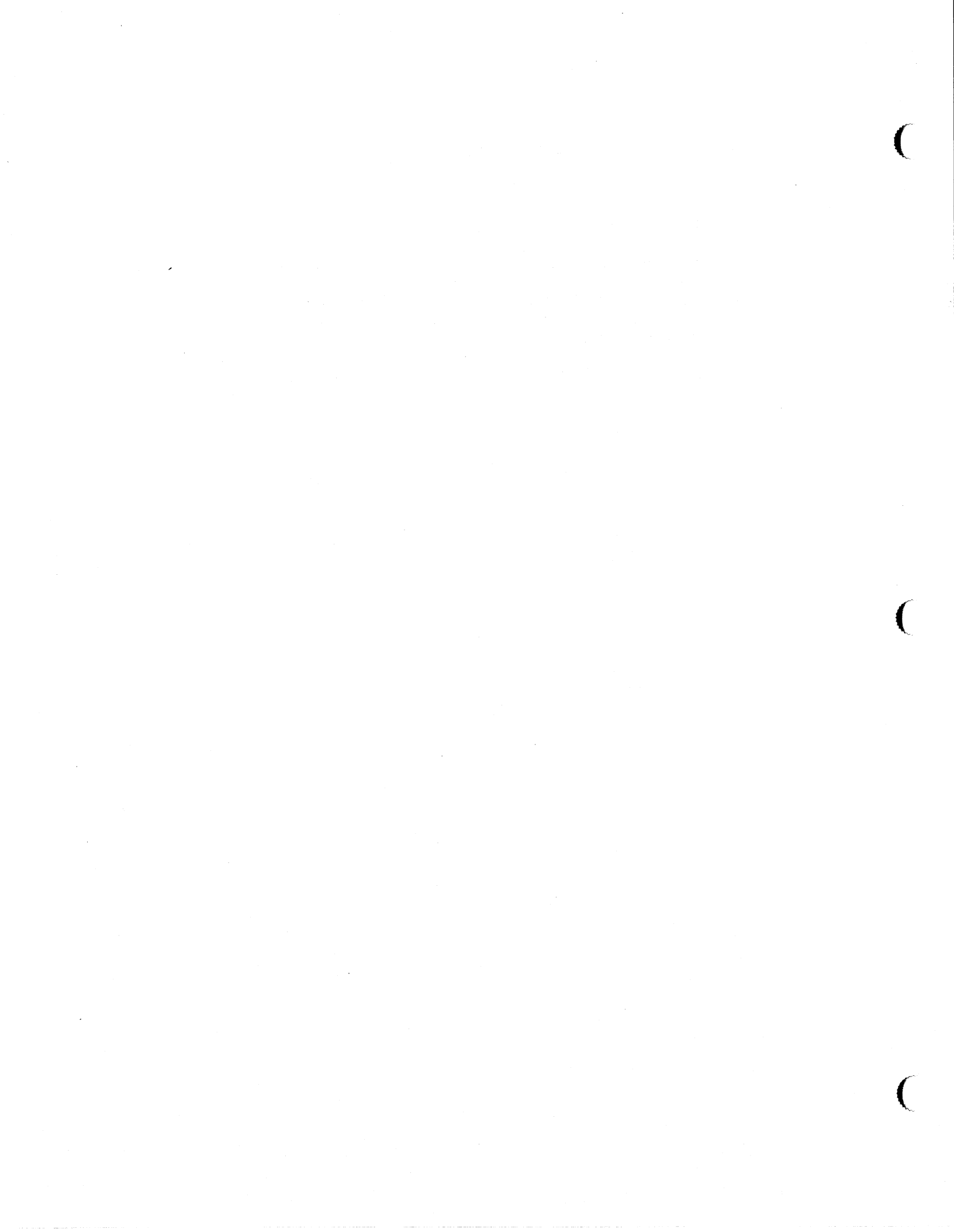

Chapter 1: Overview

The first three chapters of this manual are organized to give the new user the essentials of operating XRemote. Chapter 1 gives you a functional description, Chapter 2 describes the setup menus, and Chapter 3 explains the operating procedures. It is advised that you at least browse through Chapter 2 before attempting to perform any of the procedures in Chapter 3. Chapters 4 and 5 explain the window manager operation, and provide troubleshooting tips. The Appendices tell you how to connect to a network, describe how to utilize a FastComm modem on the XRemote system, tell what's new in this software version, add information for the advanced user, and provide Man Pages for XRemote and its clients. Other relevant information can be found in the manuals listed in the Preface.

Taking Inventory

If you purchased a network display station with XRemote already installed, you should have the following:

- a user's manual that describes your display station (for example, the *NCD16 User's Manual*) and tells you how to unpack it and set it up

You also need

- either a modem with modem cable or a cable for direct serial connection
- access to a host running XRemote host software

If you purchased XRemote separately, you should have an XRemote package, which consists of:

- XRemote host software tape with installation instructions (only one tape is needed per site)
- XRemote PROMs with installation instructions

Introduction

NCD's XRemote software enables NCD network display stations to communicate over serial lines with higher performance than protocols such as SLIP (Serial Line Internet Protocol). XRemote users can log in to remote hosts over modems or to local hosts over RS-232C cables. Once logged in, they can run the same X clients remotely that they're used to running locally on Ethernet based NCD network display stations. The XRemote product provides a fully functional X Window System (or X) environment and offers X users the versatility and convenience of using X in remote locations. By reading startup files, XRemote can start clients automatically when users log in.

XRemote is an enhanced implementation of the X Version 11 Release 4 server designed to operate over serial communication lines instead of a local area network. XRemote is always contained in PROMs; it cannot be downloaded.

XRemote requires a host-resident helper process that must be installed on the system to which your modems are connected. This helper process is provided on an XRemote tape, which must be installed by a system administrator or system manager.

How XRemote Works

There are two basic parts of XRemote. One part, consisting of the X server and boot monitor, resides in PROMs installed on the display station. This part is responsible for booting the display station, managing local processes, and handling communication with the host. The other part, the helper process, runs on the host computer with which the display station is connected over a serial line. The helper process allows the XRemote display station to communicate, through the host running the helper process, with other hosts (including other NCD display stations) on the network.

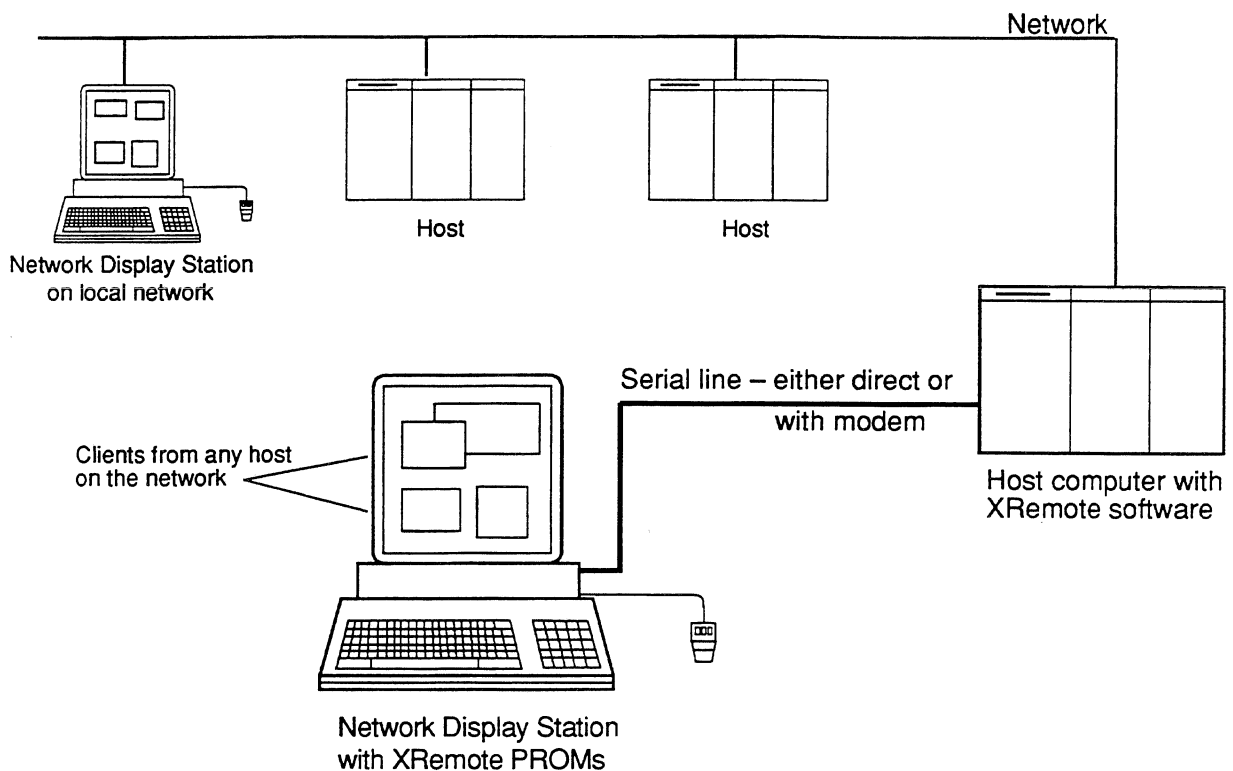

Figure 1-1. An XRemote System

Software Components

To use XRemote, you need an NCD display station with XRemote PROMs, connected via a serial line (modem or direct) with a host running XRemote host software. XRemote software consists of the following components:

- the Boot Monitor, a module that loads and boots the X Server
- the X Server, an executable module containing the X11 server, operating system, and communications protocols
- host software, including the helper programs, host-loaded fonts, binary and UNIX or VMS specific software appropriate to set up a useable operating environment.

XRemote software is distributed as follows:

Component	Distributed as ...
Boot Monitor and X Server	PROMs
XRemote host software in binary or source form (Sun3, Sun 4, RISC ULTRIX 4.0, or VAX ULTRIX 3.1)	tape (one of the following): QIC-24 cartridge 1/2-inch reel-to-reel tape (1600 bpi) TK-50 cartridge
VMS XRemote host software	TK-50 cartridge or 1/2 inch reel-to-reel tape (1600 bpi)

Cable Requirements

If you are connecting your display station to a local host over a serial line, you will need an RS-232C cable long enough to reach the host. If you are connecting your display station to a modem, you will need a short RS-232C cable to connect to the modem. Some modems include such a cable. These cables are not provided with XRemote. For details about cables, see Chapter 2.

Modem Requirements

From testing various modems, we have learned that some are better suited for use with XRemote than others. Please consider the following guidelines when selecting a modem.

- The modem should provide full-duplex transmission at 9600 baud (or faster). Although XRemote works with modems slower than 9600, performance is significantly degraded. Half-duplex modems (such as the Telebit Trailblazer) are **not** advised for use with XRemote.
- The modem should comply with the CCITT V.32 standard or V.32 bis for data communications.
- The modem should incur minimal delays in round-trip transmissions, even when transmitting small packets.
- A modem that compresses data must have this feature disabled. While compression reduces the size of the packets transmitted, it delays each transmission cycle. This added time more than negates any benefits derived from compressing the data. Because the data is already compressed, the modem's compression doesn't help.
- While NCD does not exclusively endorse the use of FastComm modems, we have found that the FastComm FDX Series 9696 modem provides excellent service for XRemote. Appendix B of this manual tells how to configure FastComm modems for use with XRemote.
- Flow control is not required. If you must use a flow control mechanism, hardware flow control is recommended (either RTS/CTS or DTR/DSR). Software flow control is **not recommended** because a noisy modem line can interject spurious XOFF characters, causing the connection to hang.
- Multiplexing modems or any other data communication equipment that add delay to the signal path will slow XRemote performance.



Chapter 2: Setup Menus

Introduction.....	7
Session Menus.....	7
Local Clients.....	7
User Preferences.....	7
Configuration Menus.....	8
Information Menus.....	8
The Setup Key.....	9
Menu Areas.....	10
Buttons and Fields.....	10
Control Buttons.....	10
Setup Menus and the X Session.....	11
Moving from One Menu to Another.....	11
Exiting the Setup Menus.....	11
Main Menu.....	12
Control Buttons.....	13
Sessions.....	14
Serial Session.....	14
Control Buttons.....	15
Diagnostic Session.....	16
Control Button.....	17
Local Client.....	18
Window Manager.....	18
User Preferences.....	18

Configuration Menus.....	19
X Server Parameters.....	19
Menu Control Buttons.....	22
Network Parameters Menu.....	23
Menu Control Buttons.....	24
Serial Port Parameters Menu.....	25
Menu Control Buttons.....	27
Utilities.....	28
Information Menus.....	29
Network Statistics.....	29
Menu Control Buttons.....	30
XRemote Statistics.....	31
Menu Control Buttons.....	31
Memory Warnings.....	32

Chapter 2: Setup Menus

Your NCD Network Display Station uses a set of parameter menus to control its behavior. This chapter describes how to use these menus. Some of the parameters can be saved in Non-Volatile Random Access Memory (NVRAM) to effect behavior on power-up, while other parameters are used only temporarily. The setup menus are used to modify these parameters. They also provide you with access to informational screens, local clients, and a terminal session.

This chapter also explains management of the pop-up error messages displayed when clients consume too much memory.

Introduction

You should be aware that entering any of the setup menus or sessions suspends operation of X clients. They resume when you exit setup.

Session Menus

Session menus function like terminals.

Serial Session	Selects an ANSI terminal emulation session using the auxiliary RS-232C port.
Diagnostic Session	Selects the console output window, which displays system messages and diagnostic output, including memory usage and version information.

Local Clients

A local client is like any other client, but it executes within the display station rather than on a host. Running a local client does not interfere with other clients.

Local Window Manager	Starts the window manager
-----------------------------	---------------------------

User Preferences

These selections effect the appearance of the Setup Menus and the keyboard LEDs.

Configuration Menus

These submenus control configuration parameters that may be stored in NVRAM)

X Server Parameters	Controls server options such as backing store and keyboard type.
Network Parameters	Controls the source of server code and the booting of X at reset.
Serial Parameters	Controls the auxiliary port parameters, such as parity and baud rate.
Utilities	Controls the screen lock.

Information Menus

These submenus pertain to network management.

Network Statistics	Displays statistics about character transmission, framing, parity, and breaks.
XRemote Statistics	Displays statistics about XRemote traffic and transmission errors.

The Setup Key

The keyboard's Setup key provides access to these menus and sessions. (The VT220 and N-108-style keyboards do not include a Setup key. To simulate the function of the Setup key on a VT220-style keyboard, press the Compose and F3 keys simultaneously; on an N-108 keyboard, press the left Alt and F3 keys simultaneously.)

When the screen is displaying an X session, pressing the Setup key displays the Main Menu. Pressing the Setup key again causes the displayed menu or session to be removed from the screen.

When the screen is displaying an X session, and the Setup key is pressed in conjunction with the Shift key, the last displayed menu or session is displayed again. In this way you can toggle between X and one of the setup menus or built-in sessions. Pressing both keys while in a menu has the same effect as pressing the Setup key alone — you return from the current menu or session.

Menu Areas

Each of the Setup Menus is organized into functional areas and has specific parameter selection, entry, and modification capabilities. The following directions apply to all the menus.

Buttons and Fields

The values displayed in the screens are the operational values used by the server. Some of these values come from NVRAM. To change the value displayed in a button (an oval boundary area), click the mouse while the pointer is positioned in the button. Continue to click until the choice you want is displayed. Clicking the left mouse button cycles through the button choices in one direction; clicking the middle or right button cycles through the choices in the opposite direction.

To enter information in a field (which looks like an empty button), move the mouse pointer into the field, click, and type the appropriate value.

If you change the setting of a button that is only read at boot time, the message

To apply change, save power-on values and reboot.

appears at the bottom of the window. If this message does not appear, the change takes effect upon exit from the menus. To put into effect changes to settings only read at boot time, click on the Save Power-On Values button in the Main Menu and reboot the display station.

Control Buttons

At the bottom of each menu is a button or set of buttons that perform special functions. All menus include a button to return you to the Main Menu. The Main Menu's control buttons let you save settings in NVRAM (Save Power-On Values), read settings from NVRAM (Read Power-On Values), and reset the server.

Setup Menus and the X Session

Displaying the setup menus interrupts your X session. If you display setup menus for too long (length depends on site configuration parameters, but typically ten minutes is too long) the X clients connected may time out.

Moving from One Menu to Another

There are two ways to move from menu to menu. You can return to the Main Menu, then click on the name of the next menu you want to display. Or, you can click on a menu name in a button at the bottom of the currently displayed menu. These "shortcut" buttons don't appear on every menu.

Exiting the Setup Menus

To exit the setup menus, press the Setup Key (or the combination of keys you used to display the setup menus). You can also exit the setup menus by clicking the Done button on the Main Menu.

Main Menu

The Main Menu displays submenu groups and User Preferences in separate areas of the screen. Control buttons at the bottom of the screen provide command operations. To display the Main Menu, press the Setup Key (on the VT220, keyboard press Compose - F3; on the N-108 keyboard, press left Alt - F3).

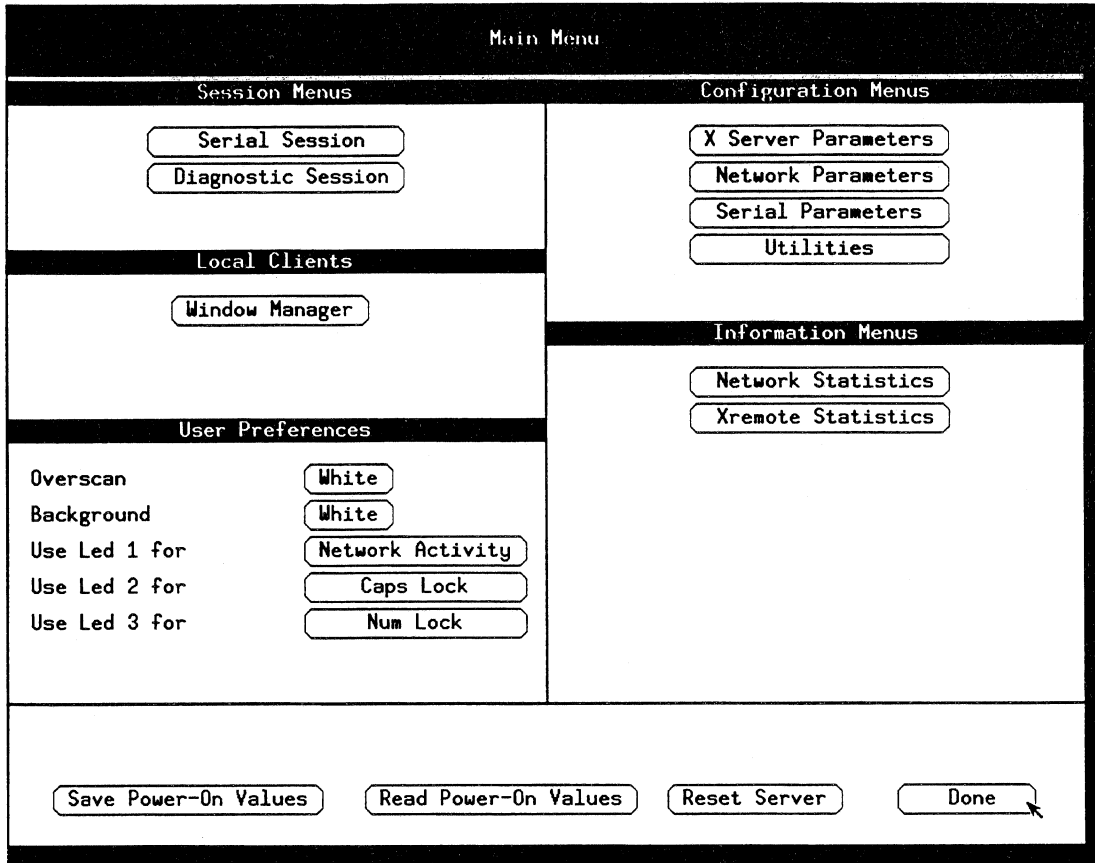

Figure 2-1. Main Menu

Control Buttons

Save Power-On Values	Stores in NVRAM the values currently displayed in the User Preference area. Clicking on this field displays "Configuration values saved for power-on" in the area above this button.
Read Power-On Values	Loads NVRAM values into operational memory, which is displayed on the screen. Clicking on this field overrides values delivered by the network.
Reset Server	Restarts the unit; a second click is required to confirm the reset.
Done	Exits the setup menu.

Sessions

Serial Session

This session provides an ANSI X3.64 terminal emulation using the auxiliary serial port. The Serial Parameters menu enables the serial port. When configured for XRemote, the display station will display the serial session at power up, or when the XRemote session has been shut down. In the latter case, you may see apparent garbage characters displayed. Just ignore them; they are caused by the XRemote startup sequence that causes the serial session to disappear when the XRemote session was initiated.

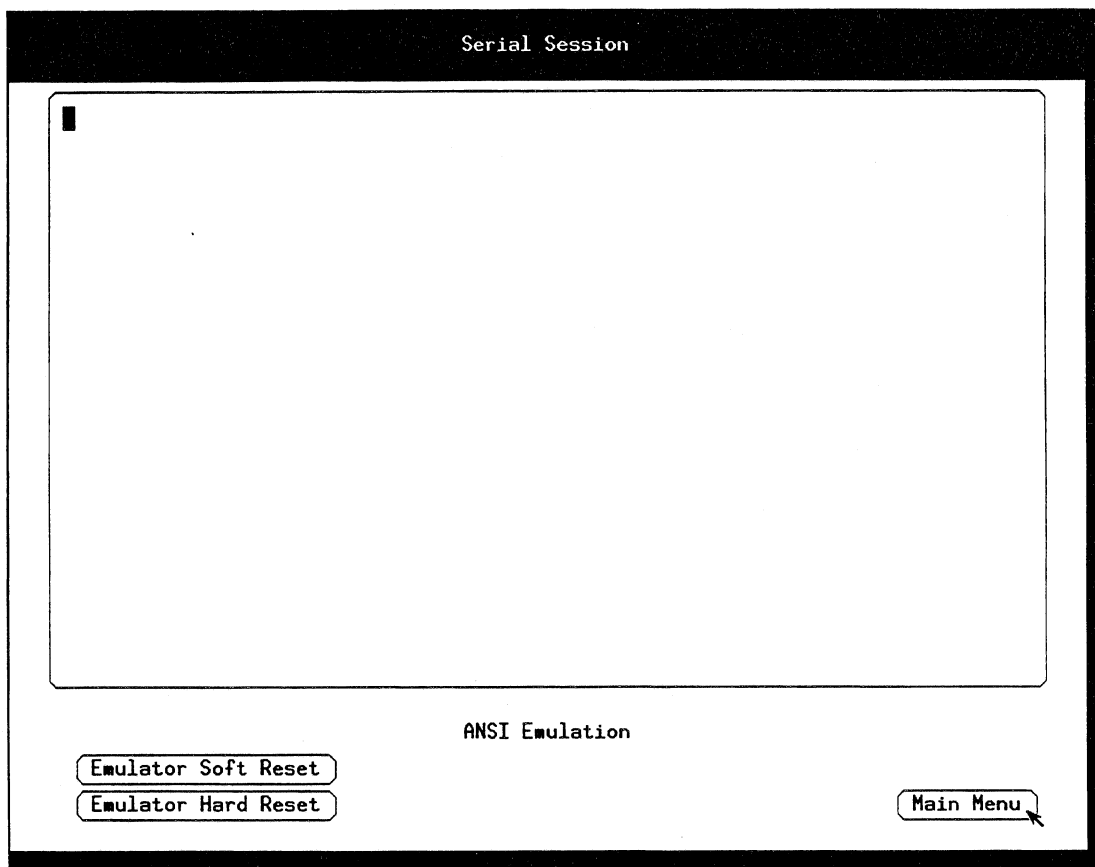

Figure 2-2. Serial Session

Control Buttons

Emulator Soft Reset	Resets the scroll region to the entire session window and character set to their default values.
Emulator Hard Reset	Resets the scroll region to the entire session window and the character set to default, resets the cursor to upper left, and clears screen.
Main Menu	Returns to the Main Menu.

Diagnostic Session

The diagnostic session is an output-only screen. The larger portion of the screen is used for console output by the server.

If the Font Diagnostics parameter in the X Server Parameters menu is set to "Yes," font specifications used by X clients and the disposition of font lookups are displayed in this screen.

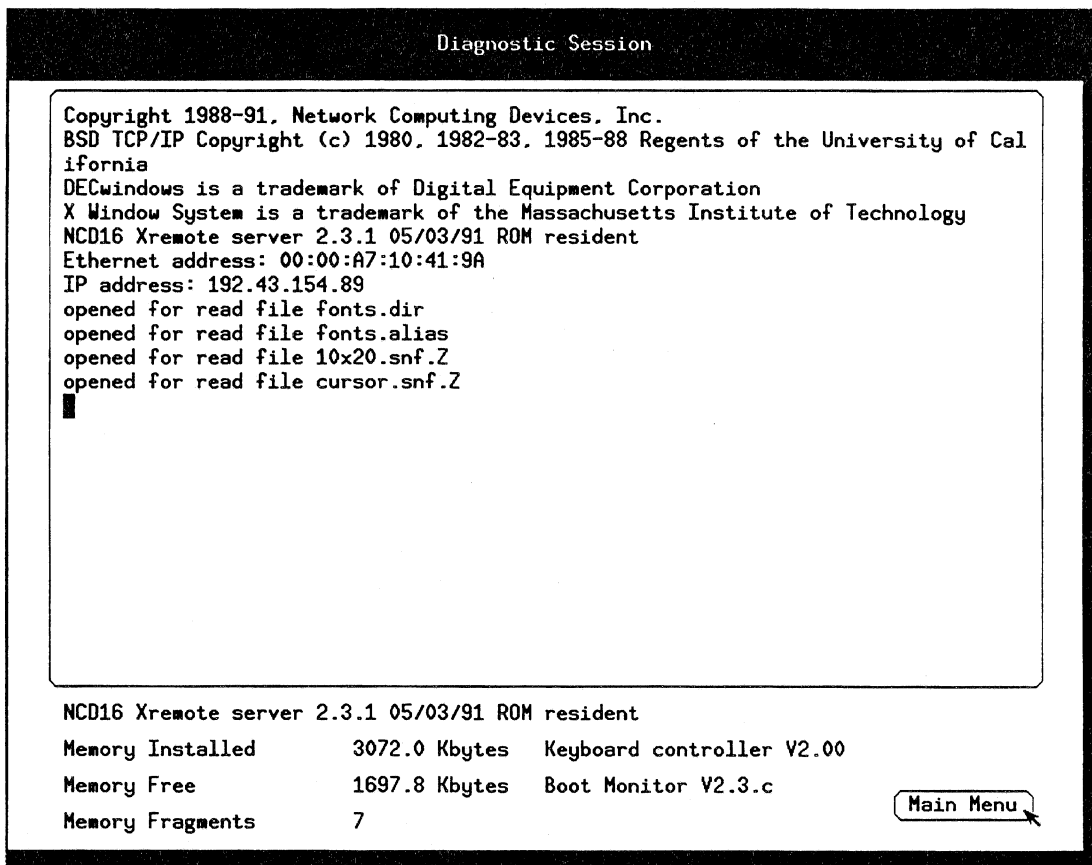

Figure 2-3 Diagnostic Session

The following information is displayed at the bottom of the screen.

NCDxx XRemote Server	Version, date, and location of the server
Keyboard Controller	Version of the keyboard firmware
Memory Installed	Size of main memory.
Memory Free	Currently available memory.
Boot Monitor	Version of boot software
Memory Fragments	This is the number of pieces of free memory that cannot be joined together.

Control Button

Main Menu	Returns to the Main Menu.
------------------	---------------------------

Local Client

Window Manager

Click on Window Manager to start *NCDwm*, a window manager that runs locally on the terminal. For a complete description, see Chapter 4, "The Window Manager".

User Preferences

These are operator environment selections available on the Main Menu. Changes made here can be stored in NVRAM by clicking Save Power-On Values in the Main Menu. These buttons cycle through a series of options. The first option displayed is the current setting. Each option change goes into effect immediately when the button is clicked, allowing you to assess the change before saving in NVRAM.

Overscan	On or Off Sets the screen border to white or black. (This option is available only on the NCD16 and NCD16e.)
Background	White or Black Sets setup menus to black characters on a white background or a black background or white characters on a black background.
Use Led 1 for	Network Activity, Caps Lock, X Led 1, Warning, or Num Lock Assigns the function of LED 1 on the keyboard to report network activity, indicate when the Caps Lock key is pressed, warn about low memory, indicate when the Num Lock key is pressed, or remain available for use by clients.
Use Led 2 for	Caps Lock, X Led 2, Warning, Num Lock, or Network Activity Assigns the function of LED 2 on the keyboard to indicate when the Caps Lock key is pressed, warn about low memory, indicate when the Num Lock key is pressed, report network activity, or remain available for use by clients.
Use Led 3 for	Num Lock, Network Activity, Caps Lock, X Led 3, or Warning Assigns the function of LED 3 on the keyboard to indicate when the Num Lock key is pressed, report network activity, indicate when the Caps Lock key is pressed, warn about low memory, or remain available for use by clients.

Configuration Menus

X Server Parameters

This menu controls server options such as keyboard type and backing store. All fields in this menu cycle through a selection of options. The first option displayed is the factory setting. Changes made here can be stored in NVRAM by clicking Save Power-On Values in the Main Menu. If you have made changes, but wish to restore the values that were present when the screen first appeared, click Load Previous Values.

The screenshot displays the 'X Server Parameters' menu. It features a title bar at the top, followed by a grid of settings. Each setting has a corresponding button or text field. Below the settings is a 'Restart Session' button. At the bottom, there are three navigation buttons: 'Load Previous Values', 'Network Parameters', and 'Main Menu'.

X Server Parameters			
Retain X Settings	No	Permit Old X Bugs	Yes
Backing Store	Auto. When Mapped	Disable Error Popup	No
Keyboard Type	N-97	Virt. Term. at Reset	Serial
DW Compatibility	Yes	Window Mgr. at Reset	Yes
		Font Diagnostics	No

Restart Session

Load Previous Values Network Parameters Main Menu

Figure 2-4. X Server Parameters Menu

Retain X Settings

Yes or No

This field directs the X server to retain or discard various X server default parameters when the last X client disconnects from the X server. If set to Yes, the X server's font path, resource data base, keyboard parameters, pointer control parameters, and screen saver parameters are retained.

Backing Store

By Request, Disabled, or Auto. When Mapped

Sets the server default for backing store to the selected value. Backing store is an off-screen image of a window that will improve the performance of redrawing the window when it is exposed. Using backing store consumes more memory.

Selecting Disabled turns backing store off. Selecting By Request causes the server to provide backing store if requested by the application. Selecting Auto. When Mapped causes the server to provide backing store for a window when that window is mapped, even if the application did not request backing store.

Selecting Disabled is suggested if memory consumption is an issue. Any change you make to your display station's backing store setting takes effect immediately. For example, changing to Disabled discards any backing store that may currently be in use.

We suggest you select Auto. When Mapped for use with overlapping windows on XRemote unless memory is tight.

Many VMS clients currently do not work correctly when Backing Store is enabled. If you have problems, disable this feature.

Keyboard Type

N-97, N-101, N-108, VT220 VMS, VT220 ULTRIX, IBM PS/2, Belgium, Canadian, Danish, French, German, Italian, Norwegian, Portuguese, Spanish, Swedish, Finnish, Swiss, or UK

Indicates the type of keyboard in use. When your display station is reset using the Boot Monitor's *rs* command, or upon power-up, the identifier is read from the keyboard. This button allows you to choose between different keyboards that report the same identifier. If you change keyboards, you may need to reset the display station to force it to re-read the keyboard identifier.

The following table lists the currently supported keyboards:

NCD Keyboard	Choices
NCD-101-style	N-101, IBM PS/2, or Cherry International keyboards (Belgian, Canadian, Danish, French, German, Italian, Norwegian, Portuguese, Spanish, Swedish/Finnish, Swiss, UK)
VT220-style	VT220 VMS or VT220 ULTRIX
UNIX-style	N-97
Kana-style	Kana
N-108	N-108

DW Compatibility

Yes or No

Causes all modifiers (control, shift, alt, etc.) to be presented to applications as if they were left modifiers (for example, the right shift key is reported as Shift_L). Set to Yes if you use DECwindows. This also provides DECwindows print screen compatibility.

Permit Old X Bugs

Yes or No

If Yes, allows certain erroneous behavior from past releases of X. Same as the *-bc* flag of MIT *xset*.

Disable Error Pop-up	Yes or No This pop-up is used to report errors and memory shortages to the user. If Yes, the error notification pop-up will be disabled and errors will be logged only to the Diagnostic Session.
Virt. Term. at Reset	Serial or None Selects the action to be taken at server reset.
Window Mgr. at Reset	Yes or No Selects the action to be taken at server reset.
Font Diagnostics	Yes or No If Yes, the server displays information about font selections in the Diagnostic Session, including the font specifications used by X clients in their font requests and the disposition of font lookups—whether the font was found and whether it was in the font cache.
Restart Session	Kills all clients, then resets the display station according to the setting of the Virt. Term. at Reset parameter.

Menu Control Buttons

Load Previous Values	Resets the menu parameters to the values they were displaying when you selected this menu.
Network Parameters	Displays the Network Parameters menu.
Main Menu	Returns to the Main Menu.

Network Parameters Menu

The only function controlled by the Network Parameters menu is booting. All fields on this menu cycle through a selection of options. The first option displayed is the current setting. Changes made here can be stored in NVRAM by clicking on Save Power-On Values in the Main Menu. If you have made changes, but wish to restore the values that were present when the window first appeared, click on Load Previous Values.

The screenshot displays the 'Network Parameters' menu. At the top, it shows 'Active Ethernet Address 00:00:A7:10:41:9A' and 'Static Ethernet Address 00:00:A7:10:41:9A'. Below this, there are two rows of settings: 'Server Code' with a dropdown menu set to 'In PROM', and 'Boot X at Reset' with a dropdown menu set to 'Yes'. At the bottom of the menu, there are three buttons: 'Load Previous Values', 'Serial Parameters', and 'Main Menu' (with a mouse cursor pointing to it).

Network Parameters	
Active Ethernet Address 00:00:A7:10:41:9A	Static Ethernet Address 00:00:A7:10:41:9A
Server Code	In PROM
Boot X at Reset	Yes
Load Previous Values Serial Parameters Main Menu	

Figure 2-5. Network Parameters Menu

Active Ethernet Address	This address is not used by XRemote.
Static Ethernet Address	This address is not used by XRemote.
Server Code	From TCP/IP Net, From NCDnet, or In PROM This field tells the Boot Monitor where to find the server code at boot time. If you select From TCP/IP Net, the Boot Monitor attempts to load the server from the Ethernet using the TCP/IP boot protocols BOOTP, RARP, and TFTP. Selecting From NCDnet causes the Boot Monitor to attempt to load the server from the Ethernet using the DECnet MOP protocol. Selecting In PROM causes the Boot Monitor to load the server from PROM.
Boot X at Reset	Yes or No This field directs the Boot Monitor to load or not load the server image. If this field is set to No, the Boot Monitor stops at the Boot Monitor prompt (>) at reset time. If set to Yes, the Boot Monitor attempts to run the server according to the setting of the Server Code field described above.

Menu Control Buttons

Load Previous Values	Restores all of the parameters in this menu to the values present when the menu was first entered.
Serial Parameters	Returns you to the Serial Parameters menu.
Main Menu	Returns to the Main Menu.

Serial Port Parameters Menu

The Serial Parameters menu controls the serial RS-232C port. All fields on this menu cycle through a selection of options. The first option displayed is the current setting. Changes made here can be stored in NVRAM by clicking on Save Power-On Values in the Main Menu. If you have made changes, but wish to restore the values that were present when the window first appeared, click on Load Previous Values.

The serial RS-232C port is labeled AUXILIARY on the base unit rear panel. To use XRemote, attach a serial line or a modem to this port.

The screenshot displays the 'Serial Port Parameters' menu. At the top, the title 'Serial Port Parameters' is centered. Below it, a sub-header 'Auxiliary Port Parameters' is displayed. The menu contains the following settings:

Data Bits	8
Stop Bits	1
Parity	None
Handshake	None
Use Port for	Terminal Session
Baud Rate	9600

At the bottom of the menu, there are three buttons: 'Load Previous Values', 'X Server Parameters', and 'Main Menu'. A mouse cursor is pointing at the 'Main Menu' button.

Figure 2-6. Serial Port Parameters Menu

Data Bits	7 or 8
	Selects the number of data bits. XRemote requires that this field be set to 8.
Stop Bits	1 or 2
	Selects the number of stop bits. This field should be set to agree with the equipment connected to the Auxiliary port.
Parity	None, Space, Mark, Odd, or Even.
	Selects the form of parity generated and expected. This field should be set to agree with the equipment connected to the Auxiliary port.
Handshake	None, RTS/CTS, DTR/DSR, or XON/XOFF
	This field controls the type of flow control handshaking used on the auxiliary serial port.
	Selecting None disables flow control; this is the suggested setting for use with XRemote.
	Selecting RTS/CTS causes the unit to raise the RTS signal when input space is available, and to lower RTS when the input buffers are nearly full. In addition, the DCE must raise CTS when it can accept data from the unit, and the unit will stop sending data when the DCE lowers CTS.
	Selecting DTR/DSR causes the unit to raise the DTR signal when input space is available, and to lower DTR when the input buffers are nearly full. Additionally, the DCE must raise DSR when it can accept data from the unit, and the unit will stop sending data when the DCE lowers DSR.
	Selecting XON/XOFF causes the unit to send an XOFF (^S) character signal when input space is low, and to send an XON (^Q) character when input space is available. In addition, the DCE must send an XOFF (^S) to the unit to stop the unit's data transmission, and must send an XON (^Q) to re-enable output from the unit. The use of XON/XOFF is not recommended because noise on the communication line can introduce spurious XOFF characters that may cause the transmitter to stop, thus freezing the line.

Use Port For	<p>Terminal Session or Network Interface</p> <p>This field controls the use of the serial port. Selecting Terminal Session configures the port for use as a serial ANSI terminal session, typically connected to a modem, host computer, or terminal multiplexer. Set this parameter to Terminal Session to begin using XRemote.</p> <p>XRemote changes the Use Port For to Network Interface when XRemote is started.</p> <p>Changing this entry from Network Interface to Terminal Session causes the XRemote protocol to shut down and can be used to forcibly terminate an XRemote session from the XRemote menus.</p>
Baud Rate	<p>A range is available from 50 to 38400, including 50, 75, 110, 134.5, 150, 200, 300, 600, 1050, 1200, 1800, 2000, 2400, 4800, 7200, 9600, 19200 and 38400 baud. Set this field to match the baud rate of the equipment you are using.</p>
	<p style="text-align: center;">Menu Control Buttons</p>
Load Previous Values	<p>Restores all fields in this menu to the values found when initially entered.</p>
X Server Parameters	<p>Selects X Server Parameters menu, as a shortcut.</p>
Main Menu	<p>Returns to the Main Menu.</p>

Utilities

This menu controls screen locking, which provides a secure way to prevent others from using the terminal while allowing host access to the display station. Although applications can perform operations while the screen is locked, the results are not displayed until it is unlocked. New applications cannot connect to the server while the screen is locked. If all clients disconnect, screen locking is shut down.

To lock the screen, click on the Lock Screen button and then click again to confirm the request. A password field is presented; repeat the password entry when requested. If the same password is entered two times in succession, the screen will be locked. If a different password is entered the second time, you will be given a chance to try again or acknowledge the failure. In the latter case, the lock screen utility will exit.

To unlock the screen, enter the password again. If you forget the password, you must reset the terminal.

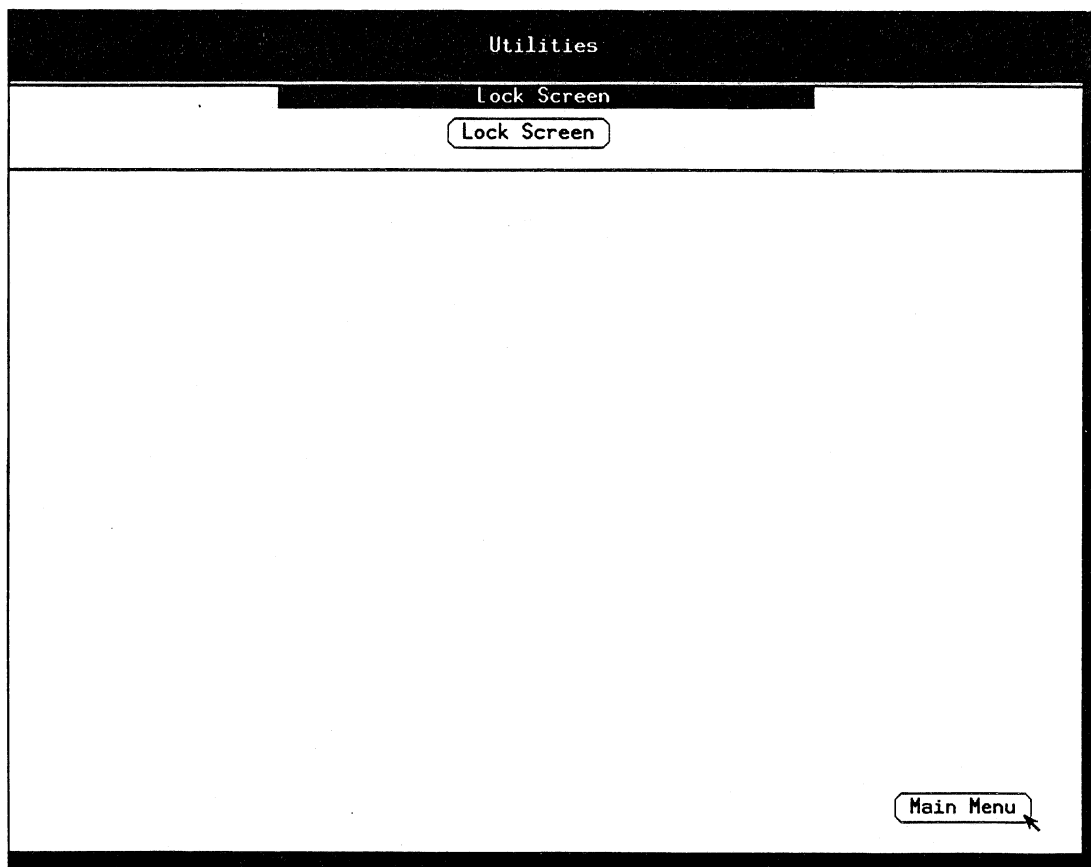

Figure 2-7. Utilities Menu

Main Menu

Returns to the Main Menu.

Information Menus

Network Statistics

The Network Statistics menu displays Ethernet and serial port traffic and errors. These statistics are gathered directly from the serial hardware.

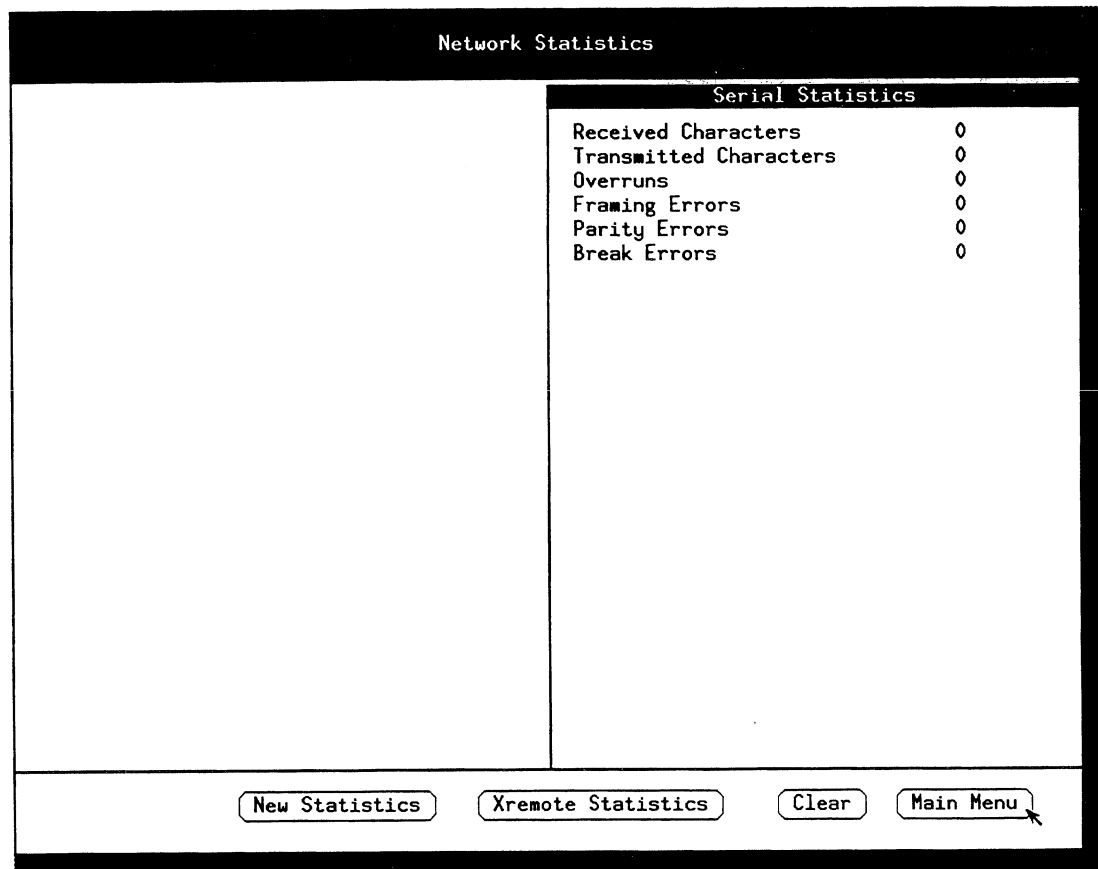

The screenshot shows a terminal window titled "Network Statistics". The window is divided into two main sections. The top right section is titled "Serial Statistics" and contains a table of statistics. The bottom section contains four buttons: "New Statistics", "Xremote Statistics", "Clear", and "Main Menu". A mouse cursor is pointing at the "Main Menu" button.

Serial Statistics	
Received Characters	0
Transmitted Characters	0
Overruns	0
Framing Errors	0
Parity Errors	0
Break Errors	0

Buttons: New Statistics, Xremote Statistics, Clear, Main Menu

Figure 2-8. Network Statistics Menu

New Statistics

Updates this menu with the most-recently collected statistics.

Clear

All statistical information is reset. Statistics are kept since the server was reset or this button was clicked.

Menu Control Buttons

XRemote Statistics

Selects the XRemote Statistics menu.

Main Menu

Returns to the Main Menu.

XRemote Statistics

This menu displays statistics for XRemote communications.

Item	Value
Xremote version	3
state	Closed
xmtPackets	0
xmtErrors	0
xmtRetransmissions	0
rcvPackets	0
rcvErrors	0
rcvOutOfSequence	0
roundTripTime	500
retransInterval	0
xmtWin	0
xmtNext	0
xmtUnacked	0
xmtMax	0
rcvWin	0
rcvNext	0
rcvUnacked	0

At the bottom of the menu, there are four buttons: **New Statistics**, **Network Statistics**, **Clear**, and **Main Menu**. A mouse cursor is pointing at the **Main Menu** button.

Figure 2-9. XRemote Statistics Menu

Menu Control Buttons

New Statistics	Updates this menu with the most-recently collected statistics.
Clear	All statistical information is reset. Statistics are kept since the server was reset or this button was clicked.
Network Statistics	Selects the Network Statistics menu, as a shortcut.
Main Menu	Returns to the Main Menu.

Memory Warnings

Your network display station displays warning messages when X clients consume too much of its memory. The first warning message is displayed only if backing store is enabled.

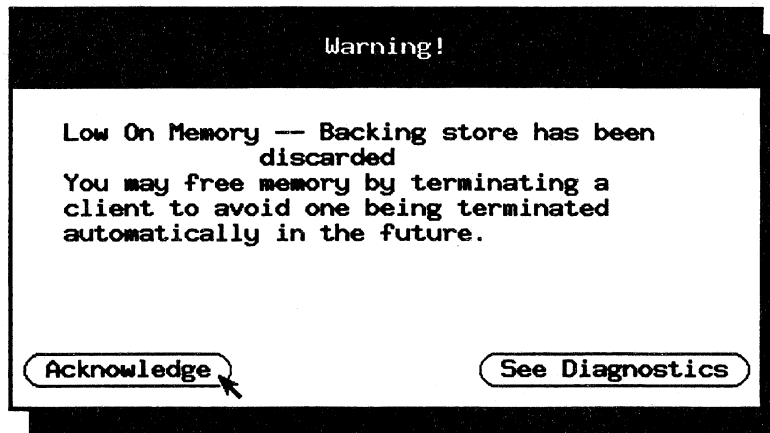

Figure 2-10. First Low on Memory Warning

This warning message contains two buttons: Acknowledge, and See Diagnostics. Click on Acknowledge to return to your window manager. Select See Diagnostics to display the diagnostics screen in the setup menus. The second and third warning messages also contain these buttons.

If your X clients consume still more memory, the display station displays a second message, whether or not backing store is enabled.

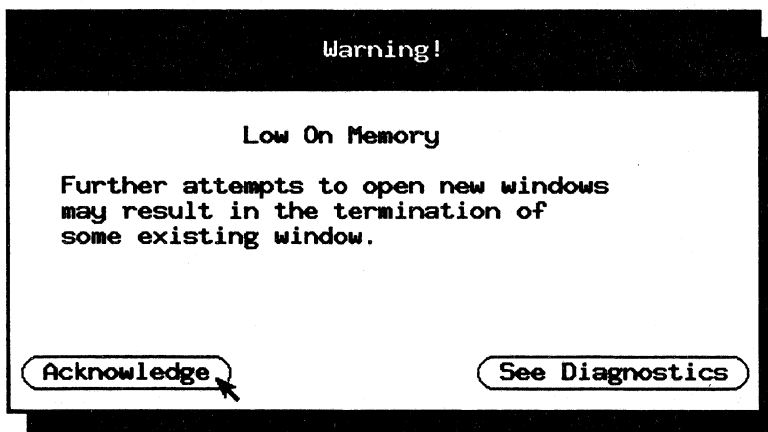

Figure 2-11. Second Low on Memory Warning

If, after the second message has been displayed, clients continue to consume more memory, the display station outputs a third message.

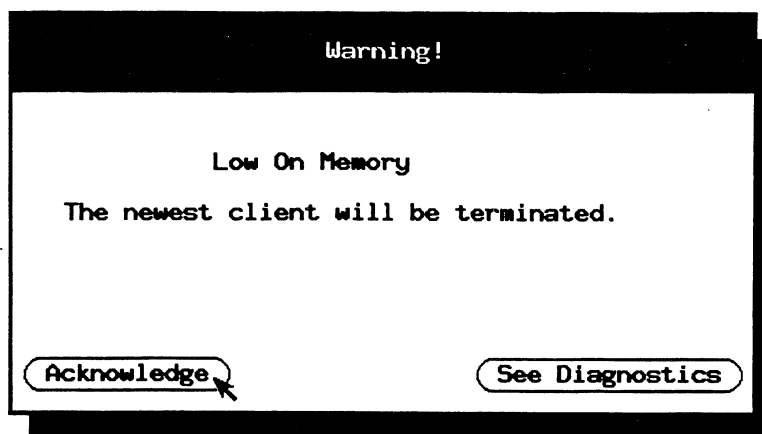

Figure 2-12. Third Low on Memory Warning

You can prevent these warning messages from being displayed by selecting Disable Error Pop-up in the X Server Parameters setup menu. If these messages appear regularly, you should consider installing more memory in your display station.



Chapter 3: Procedures

Serial Port Considerations.....	35
Setting up a Modem.....	37
Setting up a Direct Host Connection	38
Booting	39
Configuring a Display Station for XRemote.....	40
Requesting an Automatic Serial Session.....	40
Requesting an Automatic Local Window Manager.....	40
Configuring the Network Parameters.....	41
Configuring the Serial Port.....	41
Saving the Configuration in NVRAM.....	42
Dialing in from the Serial Session.....	43
Starting XRemote.....	44
On UNIX.....	44
Checking Diagnostics.....	45
UNIX.....	45
VMS.....	45
Quitting XRemote.....	46
UNIX.....	46
VMS.....	46



Chapter 3: Procedures

This chapter provides all the procedures necessary to connect, configure, run, and exit an XRemote session. Instructions are also given for checking performance and statistics. The menus referenced in the procedures are detailed in Chapter 2.

Serial Port Considerations

Before attempting to make connections described in the next two sections of this chapter, some relevant factors need to be noted:

- The serial port on your NCD Display Station (the AUXILIARY connector) is a standard RS 232C interface. Two types of configuration are available with this interface: Data Communications Equipment (DCE), and Data Terminal Equipment (DTE). DCE is generally used for modem equipment; DTE is found on host computers and terminals. These two configurations of RS 232C require different pin connection schemes in the interconnecting cables (described in the next two sections). Your NCD Display Station is configured as a DTE.
- Two cable types are used, serial (straight-through pin-to-pin connections), and null modem. Serial cables (described in "Setting Up a Modem") are used when connecting to a modem, or DTE to DCE. Null Modem cables (described in "Setting Up a Direct Host Connection" are used when connecting from DTE to DTE; for example, display station to host computer. A serial cable can be converted to a null modem cable by using a Null Modem Adapter, readily available at electronic equipment or computer stores.
- When making serial port connections, you must be aware of the connector genders. The AUXILIARY port is a DB-25 (25 pin) female connector. The cable must have a male connector at the display station end to mate with the serial port. For most modem connections a male-to-male cable is required. If your cable is not gender correct, low-cost adapters can be purchased at electronic equipment stores to adapt your cable to the desired gender. DEC systems and terminal servers use male connectors. Sun systems need a male-to-male null modem cable.

Some equipment has more than one DB-25 connection. Video and printer cables sometimes use this arrangement. Be sure you are plugging in to the correct connector.

- After making the required connections, configure your port with the "Configuring the Serial Port" procedure in this chapter. Enter the serial session and try typing a sequence of characters that the modem will respond to. For example, try typing AT and Return. If the modem does not respond, you may need to change your cable configuration (from serial to null modem, for example).

Setting up a Modem

For a description of modem requirements for XRemote, refer to Chapter 1.

Follow your modem's user manual for unpacking and setup. It should also have instructions for signal disabling and enabling hardware flow control performed in steps 3 through 5 below. Set the flow control in the Serial Parameters menu to match what you have done in these setup steps.

1. Connect one end of a short serial line to the serial port of your display station.
2. Connect the other end of the cable to your modem.

The serial line must be an RS-232C cable configured as shown below. Most modems have female connectors, requiring a male cable end. The DB connector on an NCD display station is female, also requiring a male cable end.

	Modem		N C D
Chassis Ground	1	_____	1
Transmit Data	2	_____	2
Receive Data	3	_____	3
Request to Send	4	_____	4
Clear To Send	5	_____	5
Data Set Ready	6	_____	6
Signal Ground	7	_____	7
Data Carrier Detect	8	_____	8
Data Terminal Ready	20	_____	20

3. Disable the CD and DTR signals on your modem.
4. Disable any compression algorithms used by the modem. These algorithms delay XRemote transmissions and degrade performance. Consult your modem's user manual for instructions on disabling compression and the Microcom Networking Protocol (MNP) (or any other error correction).
5. Be sure to disable XON/XOFF flow control for the modem. If you desire flow control, enable hardware flow control using either RTS/CTS or DTR/DSR.

Setting up a Direct Host Connection

XRemote can be used to connect an NCD display station directly to a local host over a serial line. The serial line must be an RS-232C cable configured as described below.

Your network display station functions as a DTE device. If you are connecting to a DCE host, see the previous section, "Setting Up a Modem". If you are connecting to a DTE device (such as a local host or a terminal switchbox), use an RS-232C cable configured as shown below (sometimes referred to as a Null Modem cable).

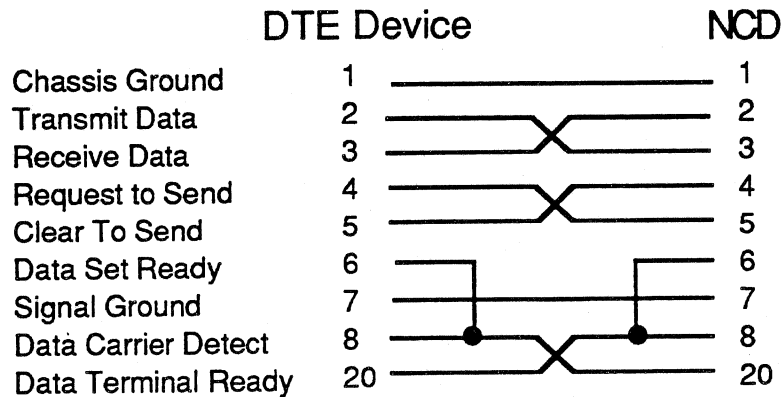

To set up a direct RS-232C connection, follow these steps:

1. Connect one end of the cable to the Auxiliary Serial port of your display station.
2. Connect the other end of the cable to your local host, or, if you are using terminal switch boxes, connect it to the local terminal switch box.
3. Use the documentation for your host or terminal switch box to configure it for 8 data bits, 1 stop bit, and no parity.

Booting

Once you've connected a modem line or an RS-232C cable, you can boot your display station from the XRemote PROMs.

If your display station normally boots from PROMs (the Server field in the Network Parameters menu should read In PROM), or if XRemote was installed in your display station at the factory, you can boot XRemote by following these steps:

1. Turn your network display station on.

The Boot Monitor displays a series of messages, beginning with a message similar to:

```
Unpacking data ... done.
```

Some NCD display stations also display an unpacking code message. Other messages identify the font files the server is loading. When the display station has finished booting it clears the screen, displays the root weave (a grey pattern that fills the screen), and begins running X.

2. If you don't see the Serial Session, press the Setup key, then click on the Serial Session button.

If your display station does not normally boot from PROM, follow these steps to boot XRemote:

1. Turn your network display station on.
2. If the Boot Monitor prompt (>) is not visible after step 1, press the Escape key twice to prevent the display station from attempting to boot over the network.

The display station should now display a Boot Monitor prompt.

3. At the Boot Monitor prompt, type the command *bp*, then press Return.

The Boot Monitor displays a series of messages, beginning with a message similar to the one shown below.

```
> bp
Unpacking data ... done.
```

Some models of NCD display stations also display an unpacking code message. Other messages identify the font files the server is loading. When the display station has finished booting, it clears the screen, displays the root weave (a grey pattern that fills the screen), and begins running X.

4. If you don't see the Serial Session, press the Setup key, then click on the Serial Session button.

Configuring a Display Station for XRemote

You configure a display station for XRemote by setting parameters in the display station's setup menus. These setup menus can be used to configure your display station, check statistics about its performance, and read diagnostic messages produced by the server and its X clients. You display these menus by pressing the Setup key on your keyboard (see Chapter 2 for details).

Requesting an Automatic Serial Session

To have XRemote bring up the Serial Session automatically whenever you boot from XRemote PROMs, do the following:

1. Display the Main Menu by pressing the Setup key or by clicking the Main Menu button of some other setup menu.
2. Select the X Server Parameters menu.
3. Click on the Virt. Term. at Reset. button until it displays Serial.
4. Return to the Main Menu
5. Click the Save Power-On Values button to save the current settings in memory.

Requesting an Automatic Local Window Manager

To have XRemote bring up the Local Window Manager automatically when booting from XRemote PROMS:

1. Display the Main Menu with the Setup key or click it from another menu if one is already displayed.
2. Select the X Server Parameters menu.
3. Click on the Window Manager at Reset button until it displays Yes.
4. Return to the Main Menu.
5. Click the Save Power On Values button to save the current settings in memory.

Configuring the Network Parameters

To configure your display station's network parameters for use with XRemote, do the following:

1. In the Main Menu, select the Network Parameters button.
2. Set Server Code to In PROM.
3. Set Boot X at Reset to Yes.
4. To return to the Main Menu, click the Main Menu button.
5. Click the Save Power-On Values button to save the current settings in memory.

Configuring the Serial Port

To configure your display station's serial port for use with XRemote, do the following:

1. In the Main Menu, select the Serial Parameters button. XRemote displays the Serial Port Parameters setup menu.
2. Set the following parameters:
 - Data Bits to 8.
 - Stop Bits to 1.
 - Parity to None.
 - Handshake to None.
 - Use Port For to Terminal Session.
 - Baud Rate to 9600 (or the actual speed of your modem or serial line, if different).
3. Return to the Main Menu.
4. Click the Save Power-On Values button to save the current settings in memory.

Saving the Configuration in NVRAM

After changing any of your display station's configuration values, be sure to save the configuration in Non-Volatile Random Access Memory (NVRAM) so the display station can use your configuration values when it reboots. To confirm that your settings have been saved, follow these steps:

1. Turn your display station off.
2. Wait a moment, then turn it on again.
3. Follow the instructions in the "Booting" section for booting from PROMs.

If you've configured your display station as described in this section, it should automatically display the Serial Session upon booting.

Dialing in from the Serial Session

In the Serial Session, type the commands the modem needs to dial in to your remote host. These commands vary from modem to modem. Consult your modem's documentation to determine exactly what you should enter. (Appendix B includes instructions for dialing in with a FastComm 9696 modem).

When you have successfully dialed in, the host displays its standard login message. Log in as you normally do.

XRemote sets your environment's DISPLAY variable automatically, so make sure this variable isn't set in your login environment (`.login`, `.cshrc`, `.profile`, or the VMS `LOGIN.COM` file).

Starting XRemote

Once you've logged in to the host, you can start XRemote by entering the command *xinitremote*. (Use this command whether or not you've set up an XRemote startup file). This starts the host side of XRemote, and the display station automatically leaves the Serial Session.

Note that any customization performed while using XRemote will only apply to the use of XRemote with your account.

On UNIX

XRemote clears the screen and displays the root weave. It runs the commands in your XRemote startup file, if you have set one up. If you haven't set up a startup file, XRemote starts a single xterm window in the upper left corner of the screen.

If you can't execute *xinitremote*, your system administrator may need to add it to your searchpath. Usually, XRemote resides in the directory `/usr/local/bin/X11`.

On VMS

Invoking the *xinitremote* command will announce the XRemote version along with the proxy server number that has been established, and then proceed to clear the screen and establish your DECwindows environment.

Checking Diagnostics

Your NCD network display station makes it easy for you to display diagnostic messages and monitor network traffic. To check diagnostics:

1. Press the Setup key.
2. Select one of the following:
 - **Diagnostic Session**
Displays diagnostic messages printed by the server and optional information about font selections. It reports on memory usage and identifies the release numbers of the server, keyboard controller, and Boot Monitor.
 - **Network Statistics**
Reports how many characters have been transmitted and received, and how many overruns or other network errors have occurred.
 - **XRemote Statistics**
Displays statistics about XRemote traffic, including the number of packets transmitted, the number of transmission errors, and the round trip time for transmissions.
3. Return to the Main Menu or press the Setup key to return to your X session.

If you encounter a problem using XRemote, review the information shown in the Diagnostic and Statistics sessions and in the host's XRemote log file on UNIX before contacting NCD. See Chapter 5 for some additional troubleshooting tips.

UNIX

The XRemote software on the host also produces diagnostic messages, which it writes in a file called `/usr/tmp/XRemoten`, where *n* is the number of your display. (This number is assigned by XRemote). If other users on the host are running XRemote, the `/usr/tmp` directory will have many `XRemoten` files. You can tell which is yours by finding the file named for your display or by running the UNIX command `ls -l`, which lists the owners of each file in the directory. The `XRemoten` file owned by you will contain the diagnostics produced by your XRemote session.

VMS

Under VMS, the XRemote software on the host places diagnostic messages in a file called `SY$LOGIN:NCD_XREMOTE.LOG`.

Quitting XRemote

You can forcibly terminate an XRemote session by going to the X Server Parameters Menu and click on Restart Session, or you can display the Serial Parameters setup menu and click on the Use Port For field, then click on Main Menu and Done. You will be returned to the Serial Session if you have configured your Setup menus for an automatic Serial Session. Once the session is terminated, the Serial Session of the NCD will return you to the normal user interactive environment, where you can logout.

The NCD network will only fall back to the Serial Session if you have set Virtual Terminal at Reset to Serial (see "Requesting an Automatic Serial Session" in Chapter 3). If you have not configured this way, you must go into setup and select the Serial Session to logout.

UNIX

You quit XRemote as you would quit any X session. If you have set up a startup file like that described in "Setting up an XRemote Startup File," you can quit XRemote by quitting or killing the last client listed in the startup file.

VMS

The standard VMS Session Manager provides a pull-down menu which is used to terminate the XRemote session.

Chapter 4: The Window Manager

Window Manager Access.....	48
Window Functional Areas.....	48
The Window Area.....	49
Title Bar.....	49
Menu Button	49
Minimize (Iconify) Button.....	49
Maximize Button.....	49
Borders and Corners.....	49
Pointers.....	50
Window Button Operations.....	51
Iconifying a Window	51
Restoring a Window.....	51
Maximizing a Window.....	51
Moving a Window	51
Moving an Icon.....	52
Raising a Window.....	52
Lowering a Window.....	52
Resizing a Window.....	52
Closing a Window or Icon.....	53
Window Menu.....	54
Restore	54
Lower	54
Shortcuts.....	55

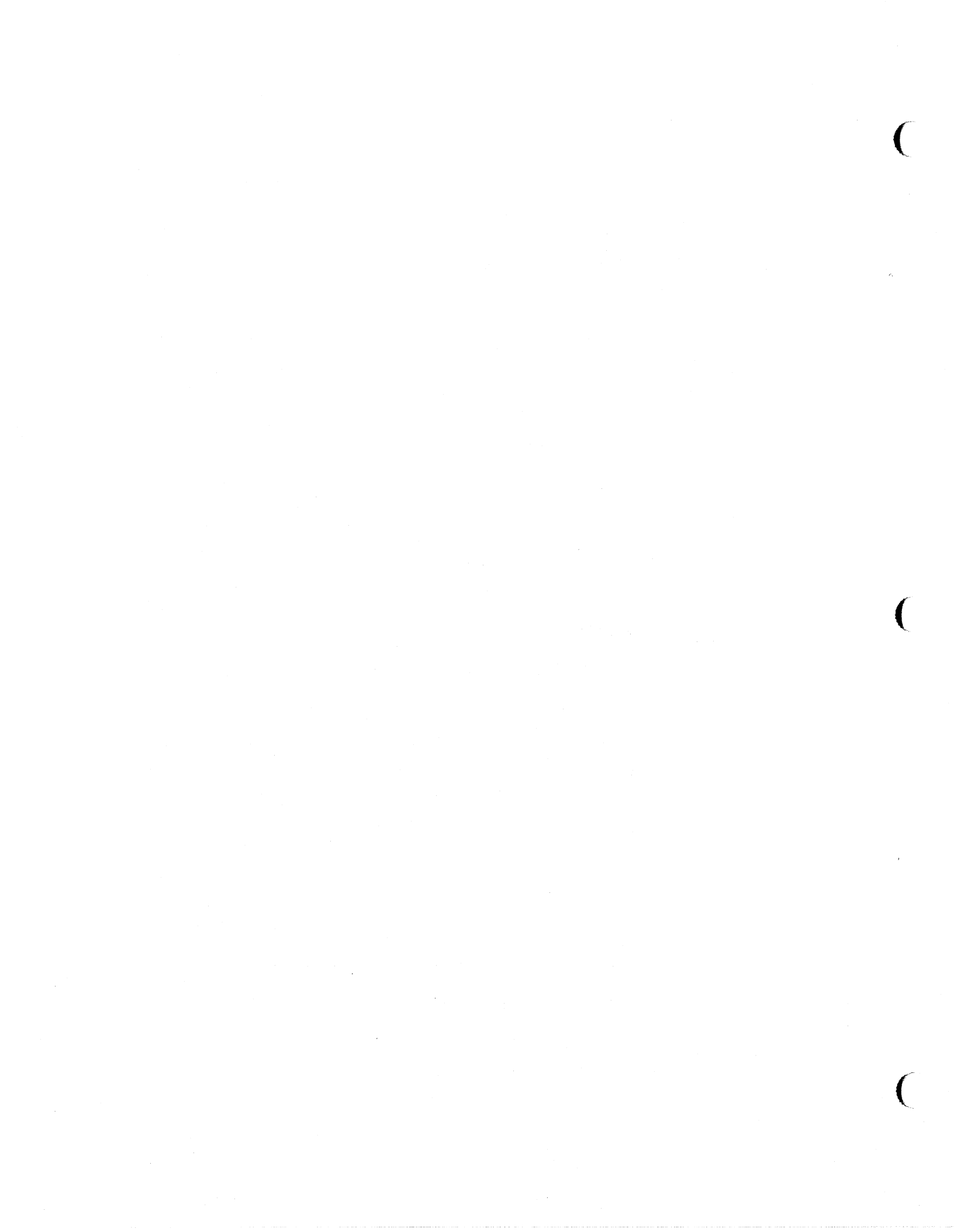

Chapter 4: The Window Manager

A window manager is a special client used to move, resize, and manipulate windows on the screen. There are many window managers available for use on NCD display stations. Some popular ones that run on a host computer are *twm* (Tom's Window Manager), *mwm* (OSF/Motif), and *olwm* (OpenLook). The NCD XRemote server includes *NCDwm*, which looks like *mwm*, and runs entirely from within the terminal.

Window managers that run on a host usually include some form of root window menu to control applications. *NCDwm*, for network security reasons, does not provide such a facility. However, there is a root window menu facility provided for this purpose on most NCD host tapes. See your system manager or Appendix D for details.

Window managers can be customized. For details see the appropriate window manager documentation. *NCDwm* documentation is provided on the XRemote host tape and in Appendix D.

Window Manager Access

To turn on the window manager go to the Main Menu, select Window Manager in the Local Clients menu area, and click through the access requests. To terminate the window manager go to the same menu selections and click through the exit requests.

Window Functional Areas

A typical window, as displayed by the local window manager, is shown below. One or many windows can appear on a single NCD display. The following is a description of each of its functions.

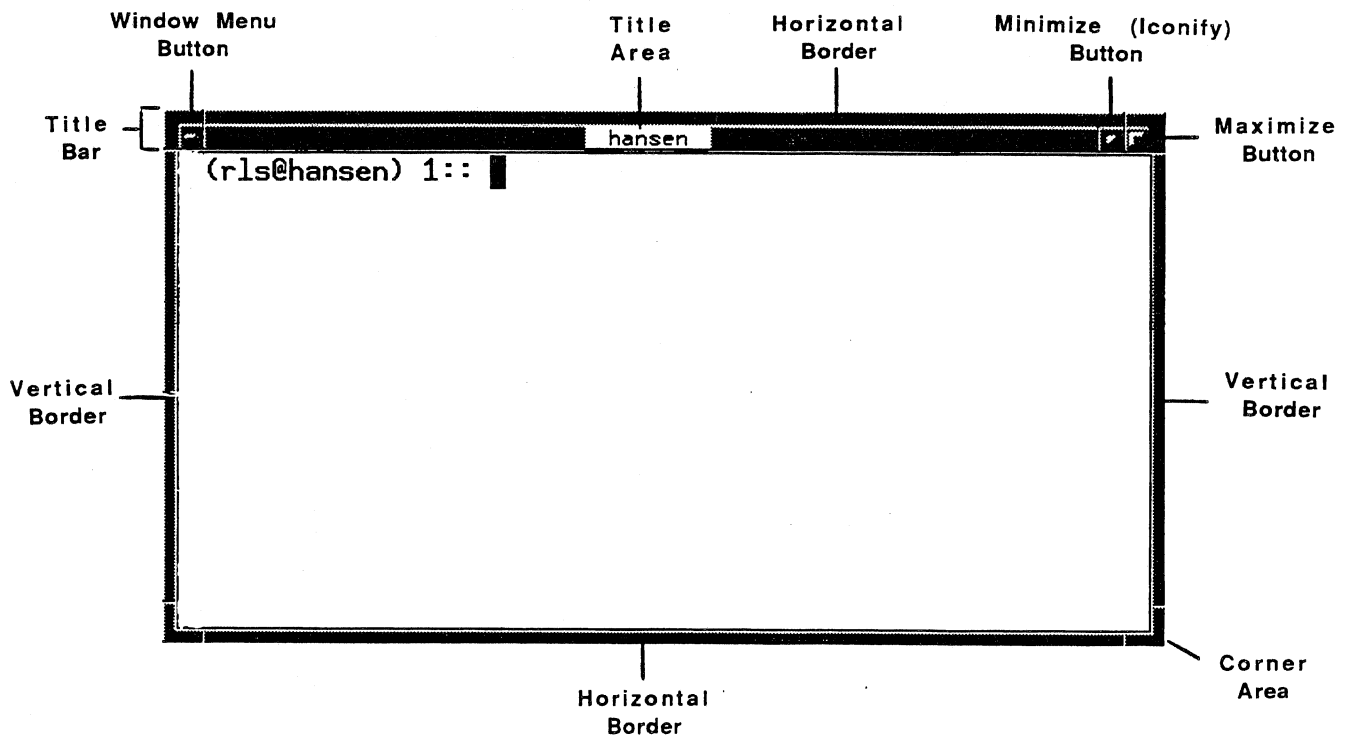

Figure 4-1 A Typical Window

The Window Area

When the window is selected, an arrow pointer appears in the window or focus area inside the borders. This is where input is received from the keyboard. The title bar and borders display a different color or gray shade from the background root window to indicate this is the selected, or active window.

To select a window, move the pointer into that window. If the display does not change color or shade, click the left mouse button. The window should now be the active window.

Title Bar

This bar extends across the top of the window. The center of the bar displays the window's title. The menu, minimize, and maximize buttons are located in the title bar area.

Menu Button

This is the left button on the title bar, and is shaped like a dash. It displays a menu of operations if clicked once anywhere in the button box area. Double-clicking the menu button terminates the window.

Minimize (Iconify) Button

This button is located on the right side of the title bar, to the left of the maximize button, and is shaped like a small box. It is used to replace an active window with an icon, or small labeled figure, which can be restored to active window status at a later time.

Maximize Button

This is the right-most button on the title bar, and is used (mostly with graphics applications) to expand the active window to display over the entire display station screen, or root window.

Borders and Corners

The borders at the top of the title bar and on the other three sides of the window can be selected and manipulated to change the size of the window. Any of the four corner areas may also be selected to vary the window's size.

Pointers

One of several different pointers may appear, depending on the operation being performed:

- For normal operations an arrow pointer appears.
- During window move operations a cross-arrow move pointer is supplied.
- When resizing borders a resizing pointer, which looks like an arrow pointing to a small vertical or horizontal bar (depending on which border is selected), is used.
- When stretching borders (moving two borders simultaneously from a corner), a resizing pointer, which looks like the corner selected with an arrow in it, is utilized.

Window Button Operations

The following paragraphs describe some of the most frequent operations performed when operating with windows. In the following descriptions, all mouse clicks are performed with the left button unless otherwise specified.

Iconifying a Window

To remove a window from the display (to emphasize some other window or make room for other activities) without terminating it, you can iconify or minimize it.

- Click on the iconify button — an icon with the proper label will appear at one edge of the screen.

Restoring a Window

There are three methods for restoring a window to its previous state:

1. To return to its previous size and location from an icon, double-click the icon or click once with the middle mouse button.
2. To restore a maximized window to its previous size and place, click the maximize button.
3. To restore a window to its previous size or place after resizing or moving it, see "Window Menu".

Maximizing a Window

To expand the window to full screen:

- Click on the maximize button

Moving a Window

To move a window anywhere on the screen:

1. Click and hold on the title bar — the cross-arrow pointer appears. A box also appears in the middle of the screen with the current location parameters
2. Still holding the mouse button down, drag the "outline figure" to the desired position, and release the mouse button. The parameter box can be referred to for precision placement.

This is the new placement for this window. If it is iconified, then restored, it will return to this place on the screen.

Moving an Icon

To move an icon to another position on the screen:

1. Click and hold on the icon — the move cursor appears.
2. Move the icon to the desired position, then release the mouse button.

Note that icons are held to an invisible grid. The icon may move slightly when released to snap into the closest grid position.

Raising a Window

If the window you want to access is overlapped by others, to raise it to the top:

- Click on any exposed portion of the window you want to raise — the borders, corners, title bar, or working area

Lowering a Window

To bury a window that is in your way:

- Click the right mouse button on the title bar.

Resizing a Window

To change the size of a window:

1. Click and hold on any border or corner — a resizing pointer and a size parameter box will appear
2. Move the border or corner in the direction of the resizing pointer, or its opposite direction, until you have the required size, then release the mouse button. The size parameter box can be used for precision sizing

This is the new size for this window. If it is iconified, then restored, it will return to this size.

Closing a Window or Icon

To terminate a window:

- Double-click the menu button - the process is exited,
- or -
- Press on the menu button or on an icon and select the Close Menu entry,
- or -
- Terminate the application that created that window. Many applications contain an application specific menu item or button to terminate the application. Doing so will lose the window.

Window Menu

This menu provides an alternate way to perform the previously discussed operations. To access the menu, press and hold on the menu button, drag the pointer to the command you want, and release the mouse button. If you select the menu and change your mind, just drag the pointer off the menu or press the Escape Key to remove the menu. You can also make a selection by keying in the abbreviation indicated (see "Shortcuts").

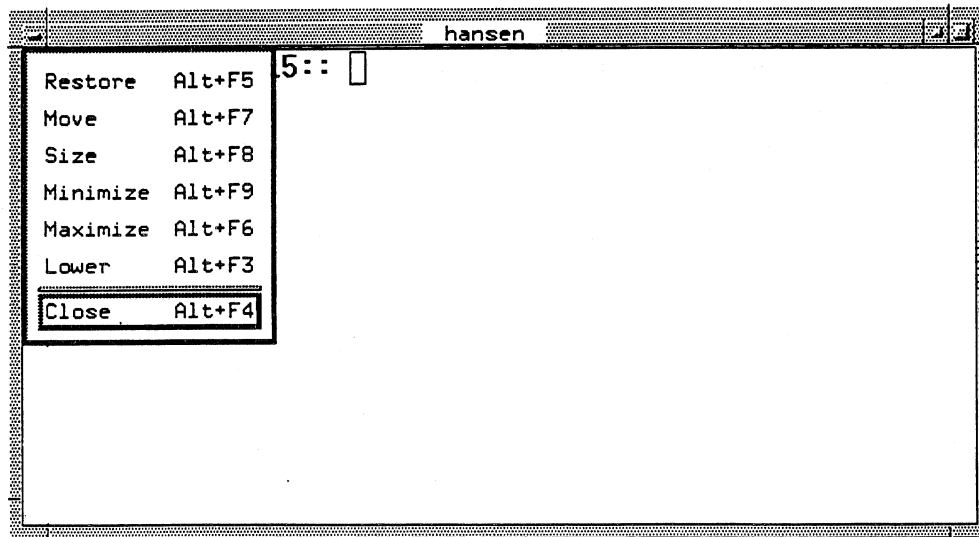

Figure 4-2 The Window Menu

Restore

To restore a window to its original size (something like an "undo" command) after resizing it:

- Press and hold the menu button, then drag the pointer to Restore and release the mouse button

Lower

To lower a window to the bottom of the window stack without changing its size or shape:

- Click and hold the menu button, then drag the pointer to Lower and release the mouse button.

Shortcuts

For operations that are keyboard intensive, or if you are just looking for a faster way to do things, the menu (see Figure 4-2) has shortcuts for each of the previously described commands. The mouse will still be required for the Size and Move commands. These shortcuts only work on the active window.



Chapter 5: Troubleshooting

Interpreting Boot Monitor Messages	59
Troubleshooting the Serial Session.....	59
Troubleshooting Peripherals.....	60
The Keyboard.....	60
The Monitor.....	60
The Mouse.....	60

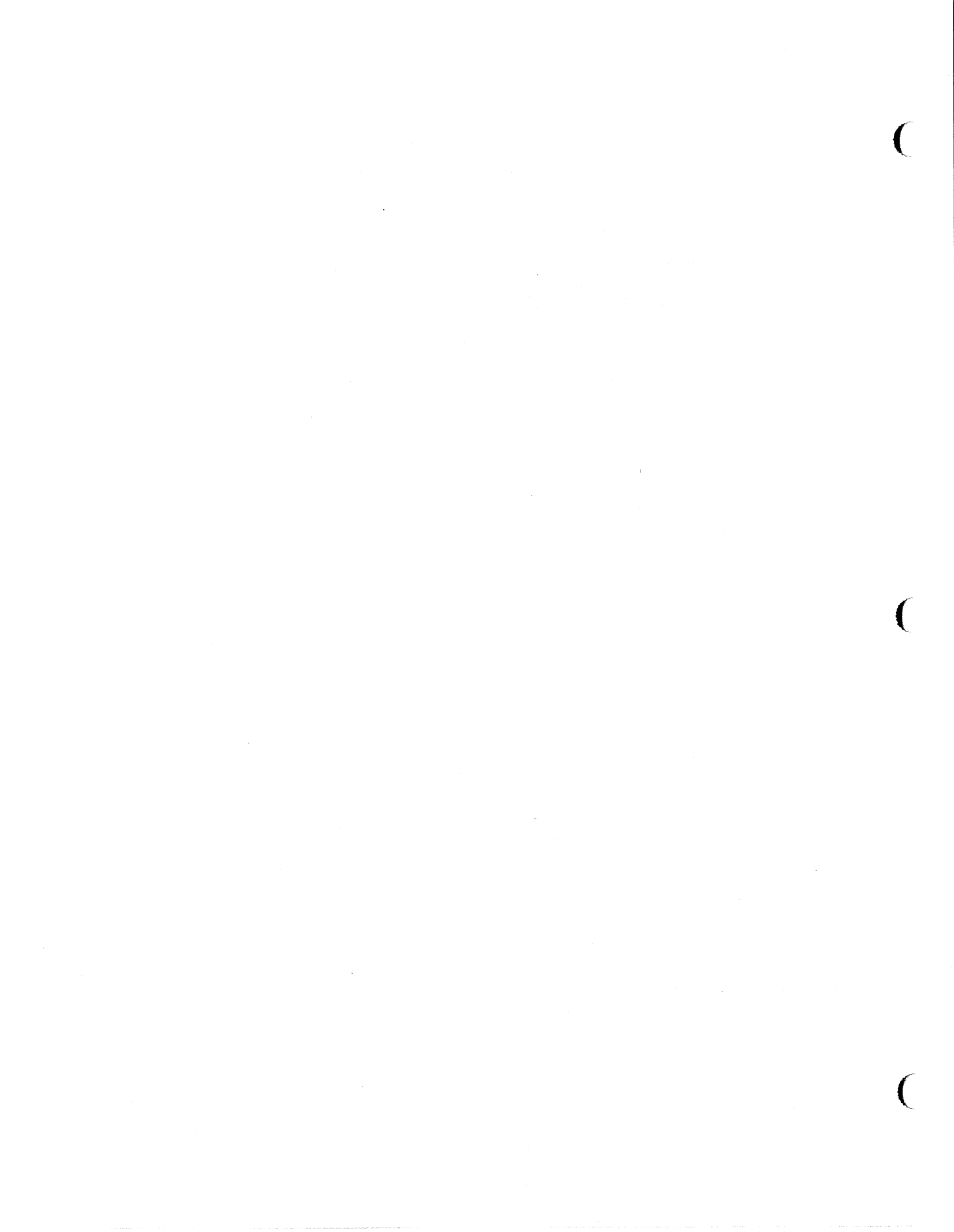

Chapter 5: Troubleshooting

This chapter offers tips for tracking down problems. If you are unable to solve a problem by applying the information provided in this chapter, please contact NCD through electronic mail or by phone. To report a problem, use the blank form found in the examples directory of the XRemote tape. Fill out the form and mail it to either of these electronic mail addresses:

`support@ncd.com`

`lupine!support@uunet.uu.net`

You can also reach NCD by calling (415) 694-0650 and asking for Technical Support.

Before reporting problems, please make the quick checks described below. If you have this information ready before calling Technical Support, you will make it easier for NCD to get your display station working again as quickly as possible.

- Does the pointer still track mouse motion?
- Do some client windows still accept keyboard input?
- Can window manager pop-up menus still be activated?
- Can you refresh the display screen to a correct state by using a window manager?
- Press the Setup key (Compose - F3 on a VT220-compatible keyboard; left Alt - F3 on an N-108 compatible keyboard). If the server displays the Main Menu, click on the Diagnostic Session button and note any errors reported in the Diagnostic Session window.
- If the display station presents a panic message, carefully note the text of the message. Knowing the exact text of the message can help Tech Support track down the source of the panic.
- What version of Boot Monitor or XRemote PROMs are you using? What is the version of the host-resident helper? The Boot Monitor and XRemote version numbers are displayed in the Diagnostic Session menu. You can use the UNIX `what(1)` command to display the version number of the helper. For example, on SunOS:

Chapter 5: Troubleshooting

```
% what xinitremote Xremote  
xinitremote
```

```
Copyright 1991 Network Computing Devices, Inc. All rights reserved.  
xinitremote version 2.3.0  
etc.
```

```
Xremote
```

```
Copyright 1991 Network Computing Devices, Inc. All rights reserved.  
Xremote version 2.3.0  
etc.
```

For VMS:

```
$TYPE SYS$LOGIN:NCD_XREMOTE.LOG
```

Interpreting Boot Monitor Messages

If the Boot Monitor displays the following message, take the corrective action shown:

If you see this message ...	do this ...
Server PROMs not installed	You need to install Server PROMs in your display station base before you can boot XRemote with the <i>bp</i> command. Refer to your display station's <i>User's Manual</i> for instructions for installing PROMs.

Troubleshooting the Serial Session

Serial Session:troubleshootingf keys typed on the keyboard are not reflected back to the modem or terminal interface:

1. Verify the Serial Parameters setup menu has Use Port For set to Terminal Session
2. Verify your cable is transmitting pins 2 and 3 correctly. If not, you may need to change cable types (see "Setting Up a Modem" and "Setting Up a Direct Host Connection" in Chapter 3).

Troubleshooting Peripherals

The Keyboard

The keyboard runs a self-test when the server is reset. If this test fails, check the keyboard connector and cable for damage.

The Monitor

If a display is out of focus, too bright, or too dark, adjust the monitor's brightness and contrast knobs. The display station's *User's Manual* describes the proper settings.

The Mouse

Most mouse problems are caused by a dirty mouse-ball or a loose connection between the mouse cable and the display station base. If you encounter difficulties using your mouse, do the following:

1. Check the mouse cable connector. Make sure it is firmly connected to the base's mouse connector.
2. Turn the mouse upside down and remove the ball. Clean the ball and its socket, then reassemble the mouse. Your display station's *User's Manual* contains instructions for cleaning your mouse.
3. Clean your mouse pad or the area of the desk your mouse sits on.

Appendix A: Network Connection

You can connect an XRemote display station to a local Ethernet by following the steps below. To boot the display station on the Ethernet, you must connect to a host from which you can download an NCD X Server into the display station's memory.

To connect an XRemote display station to an Ethernet network, follow these steps:

1. Attach an Ethernet cable to the Ethernet connector on the base of the display station, following the instructions in the display station *User's Manual*.
2. Turn the display station ON.
3. If your display station is **not** set to boot from PROMs at reset, type *bp* at the Boot Monitor prompt and press Return. Otherwise, just let the display station boot.

Your display station will boot X automatically at reset if the Network Parameters setup menu's Server Code field reads In PROM and its Boot X at Reset field reads Yes.

4. If the setup menus (specifically the Serial Session) haven't appeared once the display station boots, press the Setup key (Compose and F3 on a VT-220 style keyboard, or the left Alt and F3 keys on an N-108 style keyboard).
5. In the Network Parameters setup menu, make sure the Server Code field is set to either From TCP/IP Net or From NCDnet, according to the protocol supported on your local network.
6. In the Main Menu, click on Save Power-On Values.
7. Reboot the display station using the Reset Server button in the Main Menu and it should load a server containing TCP/IP or NCDnet protocols.

If you have an NCD15b or NCD19b display station with 1 megabyte of RAM, you will need to add more RAM to download a server.

Refer to your display station *User's Manual* and the *NCDware X Server User's Manual* for more information about using an NCD display station on a local network.

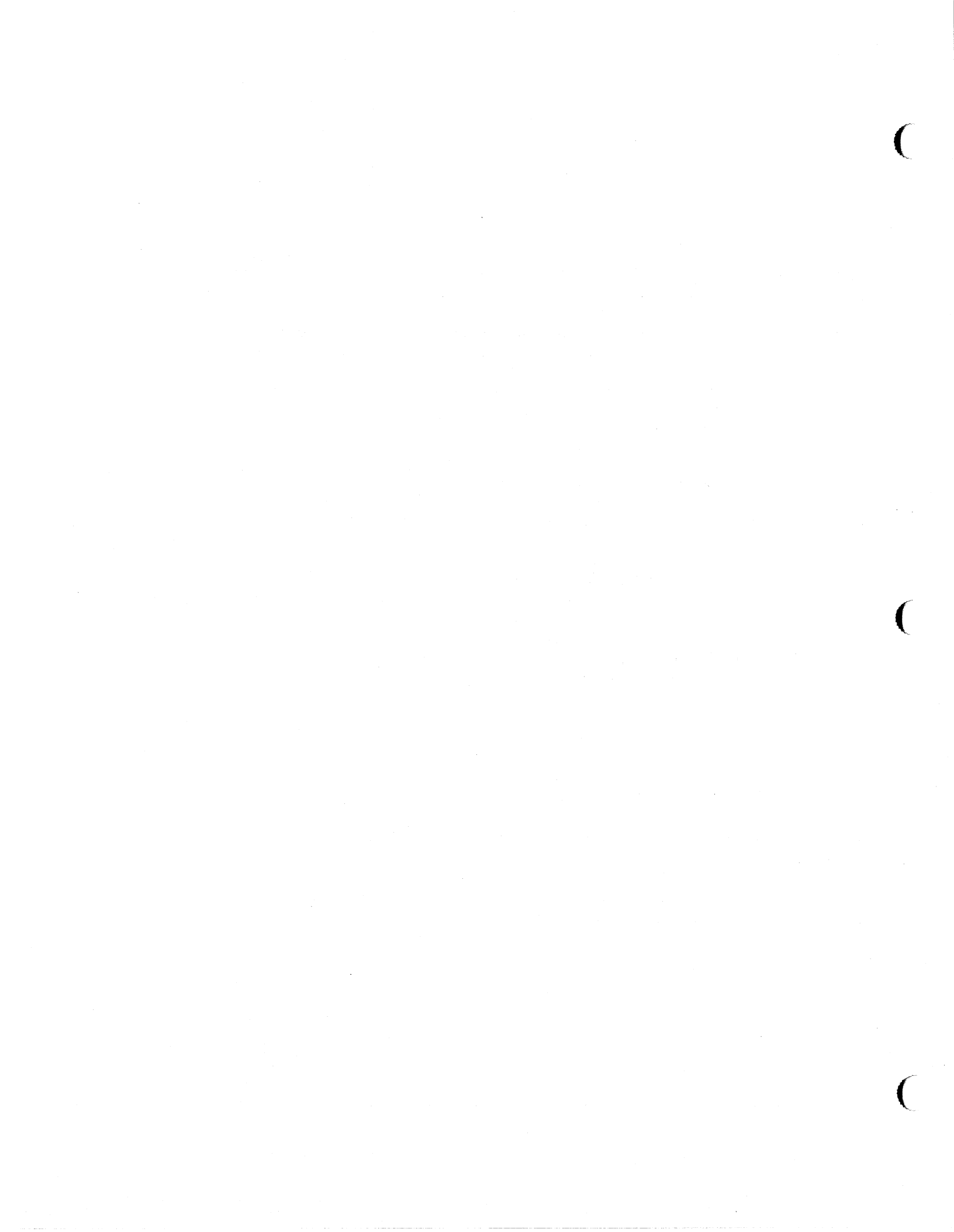

Appendix B: Using a FastComm Modem

The FastComm FDX Series 9696 modem meets all the requirements of an XRemote modem. This appendix describes how to configure a FastComm modem for use with XRemote.

1. Unpack the modem and set it up following the instructions in the FastComm manual.
2. On the back of the modem, set switches 1 - 6 OFF (open) and switches 7-8 ON (closed).
3. Follow the directions in Chapter 2 of this manual to boot XRemote and display a Serial Session window.
4. In the Serial Session, type AT and press Return.

The modem displays the message OK.

5. Disable the FastComm's Microcom Networking Protocol (MNP) features by typing the command AT&M0 and pressing Return.

The modem displays the message OK.

6. Store the current settings in the modem's NVRAM by typing AT&W and pressing Return.

The modem displays the message OK.

7. Type ATDT followed by the phone number of the remote host.

For example: ATDT5551132.

To instruct the modem to pause when dialing, insert a comma in the phone number. For example: the command ATDT9,5551132 instructs the modem to pause (usually long enough for a second dial tone) after first dialing 9.

After you enter the ATDT command, the modem should display the message:

```
REMOTE RING
CONNECT 9600/BUFF-96
```

Appendix B: Using a FastComm Modem

If, instead, you see the message:

```
CONNECT 9600/RELC-96
```

your modem is running in MNP mode, which will degrade XRemote performance.

Next the modem should display the host's login message. If you don't see the login message, try pressing Return.

If the line is busy, the modem should display this message instead of a connect message:

```
BUSY
```

If the line is busy, try repeating this step in a few moments.

8. Once your host displays the login message, log in and run the *xinitremote* command described in "Starting XRemote" in Chapter 3
9. In the Serial Session, you can save a phone number in the modem's NVRAM by entering the command `AT&Z0=phone_number`.

For example: `AT&Z0=9,5551132`.

Enter the command `ATDS0` to redial the number.

Appendix C: New Features

This is a summary of the new features and changes in XRemote version 2.3. Further information about the new features have been included in other parts of this manual.

Support for VMS

This is the first release of XRemote for the VMS operating system.

Local Window Manager

Version 2.3 XRemote PROMs contain a local window manager, *ncdwm* (1). The local window manager provides the appearance and behavior of the OSF/Motif window manager, ICCCM compliance, fast startup time, low memory usage, click-to-type and pointer-driven input models, window frames, non-rectangular windows, icons that stack along the edge of the screen, and multiple color maps.

The window manager can be configured by using *xrdb* (1) to load resources from a resources file, such as *.Xdefaults*.

An accompanying X client, *ncdlauncher* (1), works with *ncdwm* to provide the application startup menus that are built into most window managers. The launcher can be configured from a *.launchrc* file in the user's home directory.

Another X client, *ncdrestartwm* (1), restarts the local window manager and is designed to be used within a startup script, such as a *.xinitremoterc*. This client is useful when the user has set the Window Mgr. at Reset parameter (described in the next section) to "Yes" and wishes to configure window manager resources. When the window manager starts, it will not find any resources in the server's resource database. For resource settings to take effect, the window manager must be restarted after *xrdb* has been run.

Setup Menu Changes and Additions

The following changes were made in the XRemote setup menus:

- There is a new button, Window Manager, in the Local Clients region of the Main Menu. If no other window manager is running, clicking on this button starts up the local window manager.
- There is a new button, Window Mgr. at Reset, in the X Server Parameters menu. If this is set to "Yes," the local window manager starts automatically after the terminal is reset if the Virt. Term. at Reset button is set to "Serial" or "none." The choices are:
 - Yes The local window manager starts automatically after reset.
 - No The local window manager does not start automatically after reset.
- In the Diagnostic Session, the words "Boot PROM" were changed to "Boot Monitor"

Memory Requirements

The code and data for 2.3 XRemote are larger than 2.2 XRemote because of the major functional additions. The following table shows the minimum memory requirements for each model.

Display Station Model	Minimum RAM Requirement
NCD14c	> 2 Mbytes
NCD15b	2 Mbytes
NCD16	1.5 Mbytes
NCD16e	> 2 Mbytes
NCD17c	> 2 Mybtes
NCD19	> 2 Mybtes
NCD19b	2 Mbytes

Appendix D: Advanced User

This information is for the system administrator or advanced user who needs a more extensive understanding of XRemote or who must configure XRemote, the local window manager, or the launcher for users.

XRemote vs. the Normal X Server

XRemote is available only in PROMs; there is no downloadable XRemote server. Like other server PROMs, XRemote PROMs contain the boot monitor and the server. XRemote helper software must be installed on the host to which the RS-232 C lines or modems are attached. XRemote will not run without this helper daemon process.

XRemote has no method built into the server for accessing remote configuration files; therefore, it has no remote configuration ability.

XRemote setup menus are similar to those of the regular X server; however, there are fewer menus and the contents of most menus are different.

XRemote does not have the terminal emulation clients of the regular X server; the only local client is the window manager.

How XRemote Works

XRemote is an enhanced implementation of the X Version 11 Release 4 server designed to operate over serial communications lines instead of a local area network. The XRemote server consists of two parts. The X server and boot monitor reside in the XRemote PROMs, while the helper process resides on the host computer to which the display station is connected over a serial line. The helper process handles communication on one end with X clients and on the other end with the X server running in the display station.

Clients communicate directly with TCP/IP or DECnet in a non-XRemote environment. In XRemote, on the other hand, the helper takes the place of and mimics TCP/IP or DECnet, so the client perceives no difference.

The helper process on the host connects to the server running on the display station using a fully reliable, full-duplex stack of protocols. See the "XRemote Protocols" section for a more detailed explanation of the protocols.

When the display station is booted, the user logs in through the built-in Serial Session. To run X, the user invokes *xinitremote*, which sends data to the display station server, switching the display station into XRemote mode. At that point, the Serial Session disappears and is no longer useable for the duration of the XRemote session, although it remains visible in setup mode.

On the UNIX operating system, *xinitremote* starts up the server and the XRemote helper. A user's home directory may contain two shell scripts for customizing XRemote: *.xserverrc*, which specifies the server to run, and *.xinitremoterc*, which specifies the X clients to run. By default, *xinitremote* starts the XRemote server and one *xterm*.

On the VMS operating system, the helper process looks for a special XRemote environment. If the environment is not found, a normal DECwindows environment is started. Any customization done by the user in DECwindows (for example, to minimize host involvement and downloading) is saved as a special XRemote environment that doesn't affect the user's normal Ethernet-based DECwindows environment.

When the last client closes its X connection to the server, the display station side and helper side synchronize by exchanging data. The Serial Session reappears on the display. At that point, the user can log out or start another X session. XRemote can also be terminated by clicking on the Restart Session button in the X Server Parameters menu or by switching the Use Port for button in the Serial Parameters menu.

The XRemote Protocols

The XRemote protocol stack consists of three layers.

The Lower Layer

The lower layer of the XRemote protocol stack is a datagram service. Outgoing datagrams have a CRC16 frame-check sequence computed and attached, and the resulting bytes are sent with a frame character added. The frame character and other characters in the datagram are escaped as in the IETF PPP recommendation. Incoming datagrams are assembled up to the framing character and escaped special characters are converted. The CRC16 frame-check sequence is verified, and the resulting datagram is delivered upstream if the CRC16 check is correct or discarded if it is not.

The Middle Layer

The middle layer provides sequenced packet service with general-purpose data compression and retransmission. A sliding window scheme deploys multiple packets and tracks acknowledgment of delivery at the other end. Each packet has a header that includes its sequence number, the sequence number of the last correctly received packet, and an indication of how many more packets can be received. The header also indicates whether the packet's contents are compressed. An escape bit in the header allows non-sequenced data to be transmitted and received. XRemote uses this bit when establishing a session, ending a session, and accessing fonts.

The Upper Layer

The upper layer provides X data transport and X connection services, as well as another level of compression. As each new client is accepted by the helper process, a connection request is passed over the XRemote line. The X server in the display station creates a new client context, and this client becomes the "current" client at this layer.

Commands in the data stream allow switching between multiple client connections for both X requests (X client to X server) and X replies and events (X server to X client). The upper layer uses a special technique to compress consecutive keypress and motion events to a fraction of their full X representation.

XRemote Tapes

An XRemote tape contains the host-resident helper and must be installed on the system to which the serial lines or modems are attached. Tapes come in binary or source form for the UNIX operating system and the VMS operating system. XRemote tapes also contain downloadable fonts and the local clients. For UNIX systems, the tape includes an *xterm* optimized for use over serial lines. The *XRemote Tape Installation Instructions for UNIX Systems* and *XRemote Tape Installation Instructions for VAX/VMS* contain information about tape formats and tape installation instructions.

Modems

The modem used for XRemote must provide full-duplex communications between the host and the NCD network display station. A V.32 modem is strongly recommended; however, XRemote has been tested successfully with modems as slow as 2400 baud. If you have a FastComm FDX9696 modem, see Appendix B for configuration instructions.

In general, the modem and host port must be configured to allow transfer of 8-bit characters. Flow control is not required; if you must use a flow-control mechanism, hardware flow control is recommended (either RTS/CTS or DTR/DSR). Software flow control is not recommended because noisy modem lines can interject spurious XOFF characters, causing the connection to hang. The modem should also be set to run at 9600 baud and should have all MNP or PEP (or other error correction and compression) turned off. Multiplexing modems or any other data communication equipment that adds delay to the signal path will slow XRemote performance.

If you want the modem to perform dynamic speed conversions, you should use some form of flow control; we recommend RTS/CTS. For example, you would need to use flow control if the host modem port is fixed at 19200 bps and a connection is made at 9600 bps.

Built-In Fonts

The XRemote server stores a number of fonts internally to assist with initial start-up or in case downloaded fonts are not available from a local host. The number and type of fonts differs by product. There is a core set of 7 built-in fonts plus 2 or 3 additional fonts, depending upon the display station model.

Built-In Fonts for All Models

The following table lists the built-in fonts available in all display stations, along with their aliases (for an explanation of font aliases, and other aspects of font management, see the *NCDware Advanced User's Guide*).

Font Name	Aliases
-misc-fixed-medium-r-normal--10-100-75-75-c-60-iso8859-1	6x10
-misc-fixed-medium-r-normal--13-120-75-75-c-80-iso8859-1	8x13, vtsingle
-misc-fixed-medium-r-normal--15-140-75-75-c-90-iso8859-1	9x15
-misc-fixed-medium-r-normal--20-200-75-75-c-100-iso8859-1	10x20
-misc-fixed-medium-r-semicondensed--13-120-75-75-c-60-iso8859-1	6x13, fixed
cursor	(none)
fg-22	(none)

Built-In Fonts By Product

NCD14c and NCD15b XRemote servers have three additional built-in fonts:

Font Name:	-misc-fixed-bold-r-normal--15-140-75-75-c-90-iso8859-1
Alias:	9x15 bold
Font Name:	-ncd-terminal-medium-r-normal--14-140-100-100-c-110-iso8859-1
Alias:	-dec-terminal-medium-r-normal--14-140-75-75-c-80-iso8859-1
Font Name:	-adobe-helvetica-bold-r-normal--17-120-100-100-p-92-iso8859-1
Alias:	(none)

Appendix D: Advanced User

NCD16, NCD16e, and NCD19 XRemote servers have two additional built-in-fonts:

Font Name:	-ncd-terminal-medium-r-normal--14-140-100-100-c-110-iso8859-1
Alias:	-dec-terminal-medium-r-normal--14-140-75-75-c-80-iso8859-1
Font Name:	-adobe-helvetica-bold-r-normal--17-120-100-100-p-92-iso8859-1
Alias:	(none)

NCD19b and NCD17c XRemote servers have three additional built-in-fonts:

Font Name:	-misc-fixed-bold-r-normal--15-140-75-75-c-90-iso8859-1
Alias:	9x15 bold
Font Name:	-ncd-terminal-medium-r-normal--14-140-75-75-c-110-iso8859-1
Alias:	(none)
Font Name:	-adobe-helvetica-bold-r-normal--12-120-75-75-p-70-iso8859-1
Alias:	(none)

UNIX Host Configuration

User Searchpath

The user's PATH environment variable should be enhanced to include the directory in which *xinitremote* resides. Usually, this is `/usr/local/bin/X11`.

User Startup File

Upon starting up, the XRemote server starts the clients listed in a startup file in the user's home directory. XRemote attempts to execute whichever of the following files it finds first:

- a file referenced by the environment variable XINITRC
- the file `.xinitmoterc` in the user's home directory
- the file `.xinitrc` in the user's home directory (for backward compatibility with older versions of *xinitremote*)

If none of these files exist, XRemote starts by running the command:

```
xterm -geometry +1 +1 -n login
```

If you are creating a startup file, enter commands to start clients for XRemote to run automatically when it starts. Use the following guidelines:

- Use the same syntax you would use to start the clients from the shell.
- Run all but the last client in the background, except for the commands described in the "Local Window Manager Configuration" section.
- Run the last client in the foreground. When this client exits, the XRemote server stops running X and displays the Serial Session, if the user's setup menus are so configured.

The sample startup file shown below starts the *twm* (1) window manager and three clients.

```
#!/bin/csh
twm &
xclock -g =80x80-0+0 -update 60 -display $DISPLAY &
xbiff -g 40x40-83+0 -display $DISPLAY &
#This xterm is left in the foreground to keep XRemote running
xterm -display $DISPLAY -i -g 80x24-3+350 -T XRemote -e /bin/csh
```

If the user normally logs in on a local display station that runs XDM, you can make the remote environment identical to the local environment by copying the user's `.xsession` file as the startup file for XRemote or by setting the XINITRC variable to point to the `.xsession` file.

Local Window Manager Configuration

The local window manager, *ncdwm*(1), uses the resource database in the X server to control configuration and operational features such as click-to-focus vs. pointer-focus, icon geometries, and so on. When the local window manager resets, it queries the server for the resource database and acts according to the current contents of the database. In XRemote, with Window Mgr. at Reset enabled in the setup menus, the window manager finds an empty database because no client has been run to make settings in the database. It is necessary to restart the window manager for the resource settings to take effect. A new NCD client, *ncdrestartwm* (1), makes this easier. The following example shows how you can use this command in a user's *.xinitremoterc* file.

```
# load a resource file containing only window manager
# resources into the X server
xrdb -load $HOME/.Xres.wm
# restart the window manager so the newly-loaded
# database will be reexamined
ncdrestartwm
# remove the database from the X server so that subsequent clients
# will consult the .Xdefaults file for configuration information
xrdb -remove
```

Instead of removing the database from the server in the last command shown above, you could run *xrdb* to load a file containing resources for all clients except the window manager.

Note that none of the commands should be run in the background (using the "&" qualifier) because they are meant to run in the order in which they are shown.

Font Downloading

XRemote supports font downloading; however, downloading fonts will result in some noticeable delays.

The default font path for XRemote includes only the server's built-in fonts. To include other font directories in the font path, use the *xset* (1) command; for example:

```
xset fp built-ins,/usr/lib/X11/ncd/fonts/misc,/usr/lib/X11/ncd/fonts/100dpi
```

You can put this command in the user's *.xinitremoterc* file.

Log File

The XREMOTE_TMPDIR variable can be set to the directory for the log file for all *stdio* library output from the XRemote helper and all the clients run by the *.xinitremoterc* script. The log file's name is *Xremotedigits* (*digits* is the display number).

If there is no XREMOTE_TMPDIR variable, the TMPDIR variable is consulted for the name of the directory in which to create the log file. If neither variable is present, the log file is created in the */usr/tmp* directory.

NCD's Optimized xterm

Included with the XRemote host software is a version of *xterm* that has been optimized for use over a serial line. The binary and patches for this *xterm* can be found in the *binSun3*, *binSun4*, *binRiscUltrix*, and *binVaxUltrix* directories on the release tape. The source is provided in the directory *src/xterm*. We recommend that you use this *xterm* instead of the standard version, particularly if you use the *vi* (1) text editor. Using the *xterm* from MIT results in some inefficient text drawing.

VMS Host Configuration

Transport Modules

The logical name `NCD_XREMOTE_SERVER_TRANSPORTS` is a list of VMS DECwindows transport modules initialized by the XRemote helper when starting up. If this logical is undefined, only the *local* transport will be initialized. By default, the name is defined to include the DECnet transport as part of the `NCD_ROOT:[BIN]NCD_XREMOTE_INSTALL.COM` procedure file, which is invoked during system startup.

Invoking XRemote

To use XRemote on VMS, the proper command must be defined. This is usually accomplished by having the following lines in the system login command file `SY$MANAGER:SYLOGIN.COM`:

```
$IF F$SEARCH("NCD_ROOT:[BIN]NCD_USERCMDS.COM").nes.""  
    THEN @NCD_ROOT:[BIN]NCD_USERCMDS.COM
```

This may also be defined in each individual user's `SY$LOGIN:LOGIN.COM` file if only a few users on the system will be using XRemote.

Log File

The file `SY$LOGIN:NCD_XREMOTE.LOG` logs useful messages along with debugging information for each session.

Font Path

If the logical name `NCD_XREMOTE_FONTPATH` is defined, the list of translations will be used as the font path for an XRemote session. If no such name is defined, the files `NCD_ROOT:[CONFIGS]NCD_XREMOTE-xxDPI.FONTPATH` will be used. (*xx* is either 75 or 100, depending on the resolution of the display station from which you are connecting).

Starting the Local Window Manager

For users who want to use the NCD local client window manager instead of the default DECwindows window manager, do the following:

1. Disable the DEC window manager in the Session Manager "Customize" menu under the "Window ..." option.

At the Window Manager prompt, enter the following system logical name:

```
NCD_LOCALWM_EXE
```

Exit from the window by selecting OK.

2. Save the current Session Manager configuration using the "Save Current Settings" option in the "Customize" menu.
3. Log out and log in again. The local window manager should now be running.

Running Clients on Alternate Remote Hosts

This section describes how to configure the network so users can run clients on hosts other than the XRemote host (the host with the XRemote software installed). Additional transport names must be added and a display variable created.

By default, the LOCAL and DECNET transports are supported by XRemote. If additional transports are to be used, any additional transport names (for example, "tcpip" for UCX and Multinet or "wintcp" for Wollongong) must be appended to the list of defined (that is, "listened to") transports in the file `NCD_ROOT:[BIN]NCD_XREMOTE_INSTALL.COM`. By default, the relevant line reads as follows:

```
$ define/system/exec ncd_xremote_server_transports local,decnet
```

For example, if Multinet is in use on the network and will be used to carry X clients from a remote host to an XRemote host and thence to an NCD unit running XRemote, the line would read:

```
$ define/system/exec ncd_xremote_server_transports local,decnet,tcpip
```

If this file is modified, it must either be executed or the system must be rebooted for the changes to take effect.

The next step is to create a display variable that will direct a client running on a remote host to send its output to the NCD unit via the XRemote helper. The helper appears, logically, as an additional server on the XRemote host. The server number (a number incremented for each XRemote user on the host) is displayed by the XRemote process after the *xinitremote* command is issued and is visible in the NCD's Serial Session before the NCD switches to XRemote mode. It is visible after the NCD is in XRemote mode if you enter the Setup menus and select the Serial Session.

In the following example, the XRemote server supporting the NCD appears as server number 12:

```
13-JUN-1991 08:49:17.29 X server Transport initialized for Server 12
```

The server number is then used in a SET DISPLAY command to direct a client's display to the NCD via XRemote. For example:

```
$ SET HOST REMVAX
```

```
Welcome to VAX/VMS V5.4-1 on node REMVAX
```

```
#! Here we are logged into REMVAX inside a DECterm running on NCDVAX
#! We create a display variable in whose context we will run a client on
#! REMVAX and the display will be directed at this NCD.
$ SET DISPLAY/CREATE/NODE=NCDVAX/SERVER=12/TRANSPORT=DECNET
$ SHOW DISPLAY
```

```
Device:      WSA4:      [super]
Node:        NCDVAX
Transport:   DECNET
Server:      12
Screen:      0
```

```
#! At this point, we can start a client on this display device
$ RUN SYS$SYSTEM:DECW$BOOKREADER
```

This example is of limited utility, because the DECterm from NCDVAX is wasted running the Bookreader on REMVAX. A more effective method is a command procedure that you could submit to REMVAX's batch queue. In the procedure, the display variable is created with information provided as parameters to the batch job. An example follows.

Appendix D: Advanced User

```
#! CLIENT_STARTER.COM -- sample DCL command procedure to start clients on
#! remote nodes. This procedure supports NCDs, VAXstations, NCDs running
#! XRemote, etc. Perhaps the most appropriate use of this command
#! procedure is as a batch command procedure. For example, a DCL
#! symbol defined as follows is useful:
#!
#!      CS== "submit sys$login:client_starter /ident/noti/noprint/para="
#!
#! and the symbol is used interactively as follows:
#!
#!      $ cs (decterm, ncdul21, "/transport=tcpip")
#!
#! In this example, a DECTERM is started on the NCD whose IP "host name"
#! is "ncdul21" and the transport (tcpip) is defined as shown.
#!
#!=====
#!
#! P1 = client to start; values parsed via "goto"; this is VERY
#!      unreliable.
#! P2 = node on which to run client
#! P3 = additional qualifiers for SET DISPLAY command
#! Defaults below; set defaults as appropriate for site or user.
#! Set defaults for each parameter.
$ if p1 .eqs. "" then p1 = "decterm"
$ if p2 .eqs. "" then p2 = "ncdl30:."
$ if p3 .eqs. "" then p3 = "/transport=decnet/executive"
#!
#!
#! Create a display variable using the relevant parameters
$ set display/create/node='p2''p3'
#!
#! And now jump to the tag of the desired client
#! Don't bother to parse for an error, since if the goto fails due to
#! the lack of an existing tag, the procedure will fail and SUBMIT/NOTIFY
#! will pass the error code back in a broadcast.
$ goto 'p1'
#!
$
```

Appendix E: UNIX Man Pages

This appendix provides UNIX operating system reference pages for XRemote and three NCD clients that are useful with XRemote. The following man pages are provided:

- *ncdlauncher*(1) — application launcher
- *ncdrestartwm* (1) — restart NCD local window manager
- *ncdwm*(1) — local X window manager for NCD display stations
- *xinitremote* (1) — X Window System initializer
- *Xremote* (1) — X protocol interpreter for serial lines

NAME

`ncdlauncher` – application launcher

SYNTAX

`ncdlauncher [-display displayname] [-f initfile]`

DESCRIPTION

The *ncdlauncher* program works with *ncdwm* to provide the application startup built in to most window managers.

OPTIONS

ncdlauncher accepts the following command line options:

-display *displayname*

This option specifies which NCD display to use.

-f *filename*

This option specifies the name of the startup file to be used. By default, *ncdlauncher* will look in the user's home directory for the file named *.launchrc*.

CUSTOMIZATION

ncdlauncher's behavior is controlled by providing an init file, *.launchrc*, describing button and key bindings.

ncdlauncher init files contain two types of specifications: *Bindings* and *Menus*. The *Bindings* section usually comes first and is used to specify the functions that should be invoked when keys or pointer buttons are pressed in the root window. The *Menus* section specifies any user-defined menus containing functions to be invoked or commands to be executed.

Keywords are case-insensitive. Strings must be surrounded by double quotes and are case-sensitive. A pound sign (#) outside a string causes the remainder of the line to be treated as a comment.

BINDINGS

Key and pointer button specifications must give the modifiers to press and the function to be invoked. Keys are given as strings containing the appropriate keysym name; buttons are given as the keywords **Button1**, **Button2**, and **Button3**:

```
"FP1"          = modlist : function
Button1      = modlist : function
```

The *modlist* is any combination of the modifier names **shift**, **control**, **lock**, **meta**, **mod1**, **mod2**, **mod3**, **mod4**, or **mod5** (which may be abbreviated as **s**, **c**, **l**, **m**, **m1**, **m2**, **m3**, **m4**, **m5**, respectively) separated by a vertical bar (|).

The *function* is any of the **f.** keywords described below. For example, the default startup file contains the following binding:

```
Button1 =      : f.menu "Menu"
```

FUNCTIONS

!*string* This is an abbreviation for **f.exec** *string*.

f.exec *string*

This function passes the argument *string* to */bin/sh* for execution.

f.line This function causes a line to be drawn inside a menu.

f.menu *string*

This function invokes the menu specified by the argument *string*. Cascaded menus may be built by nesting calls to **f.menu**.

f.nop This function does nothing and is typically used to introduce blank lines in menus.

f.quit This function quits *ncdlauncher*.

f.restart This function kills and restarts *ncdlauncher*. Typically, this is used when the *.launchrc* file has been modified and you want to see the changes.

f.title *string*

This function causes a title string to be placed in a menu.

MENUS

Functions may be grouped and interactively selected using pop-up menus. Each menu specification contains the name of the menu as it is referred to by the **f.menu** function, the menu title, and the list of item names and the functions invoked by the names or the **f.line** function.

```
Menu "menuname"
{
    string  f.title
    string1 function1
    f.line
    string2 function2
}
```

The *menuname* is case-sensitive. The *string* portion of each menu entry is the text that will appear in the menu.

X DEFAULTS

ncdlauncher understands the following resources, when attached to the root window RESOURCE_MANAGER property (using the *xrdb(1)* host utility or the **initial-x-resources** remote configuration option). The instance of name of the **ncdlauncher** is *ncdlauncher* and the class name is *NCDlauncher*. String values are

quoted in the description only to make them visible; the quotation marks should **not** be included in the resource.

font (class **Font**)

This string specifies the name of the font to use for the title bar and menus. The default is "variable."

forceMono (class **ForceMono**)

This boolean specifies whether or not *ncdlauncher* should pretend it is running on a monochrome screen even if it is not. This will conserve colors in the default colormap. The default is "false."

background (class **Background**)

On color displays, the color of the menu backgrounds. The default is NCD green (#58d2a6).

EXAMPLES

Commonly used resources include:

```
NCDlauncher*font: -adobe-helvetica-bold-r-normal--*-120-*-*-p*-iso8859-1
```

FILES

\$HOME/launchrc

ENVIRONMENT VARIABLES

DISPLAY This variable determines which X server to use. It is also set during *f.exec* so that programs come up on the proper screen.

HOME This variable is used as the prefix for locating the *ncdlauncher* init file.

SEE ALSO

ncdwm(1), X(1)

COPYRIGHT

Copyright 1990, Network Computing Devices, Inc. All rights reserved.

BUGS

Cyclic menus will cause problems.

AUTHOR

Dave Lemke, Network Computing Devices, Inc.

Appendix D: Advanced User

```
$ xtelnet: lc_exec xtelnet
$ exit
$
$ xlat_manager:
$ lat_manager:
$ xlat_prompter:
$ xlat_mgr: lc_exec xlat_prompter
$ exit
$!
$! ===== end of CLIENT_STARTER.COM =====
```

```
$ dt: decterm: create/terminal/detached
$ exit

$ eve: edit/tpu/display=decwindows/noinitial
$ exit

$ fileview: run sys$system:vue$master
$ exit

$ sm: session: run sys$system:decw$session
$ exit

$ clock: run sys$system:decw$clock
$ exit

$ wm: window: run sys$system:decw$winmgr
$ exit

$ paint: run sys$system:decw$paint
$ exit

$ book: run sys$system:decw$bookreader
$ exit

$! LC_EXEC is a command defined by a proper NCD installation; if the
$! command is not present, we'll let the procedure die and see the
$! error message.
$ ncdwm:
$ localwm: lc_exec wm
$ exit
$
$ xlat: lc_exec xlat
$ exit
$
```

NAME

`ncdrestartwm` – restart NCD local window manager

SYNOPSIS

`ncdrestartwm` [`-display` *displayname*]

DESCRIPTION

The `ncdrestartwm` command sends a message to the NCDwm window manager that runs inside NCD Display Stations telling it to restart itself. This is typically done in `.xinitremoterc` startup files after loading window manager resources with the `xrdb` command.

OPTIONS

`-display` *displayname*

This option specifies the NCD Display Station whose NCDwm window manager should be restarted.

SEE ALSO

`Xremote(1)`, `xinitremote(1)`, `ncdwm(1)`, `xrdb(1)`

COPYRIGHT

Copyright 1991, Network Computing Devices.

AUTHOR

Jim Fulton, Network Computing Devices

NAME

`ncdwm` – local X window manager for NCD Display Stations

DESCRIPTION

The `ncdwm` program is a window manager built into NCD Display Stations. It provides OSF/Motif appearance and behavior, ICCCM-compliance, fast startup time, low memory usage, click-to-type and pointer-driven input models, window frames, non-rectangular windows, icons that stack along the edge of the screen, and multiple colormaps. It is most useful in environments where host-based window managers are not available or are too much of a load on the host.

STARTING AND STOPPING NCDWM

`ncdwm` may be started in several ways:

Setup menus

After pressing the **Setup** key (or **Alt+F3** on VT keyboards), double-click on the **Window Manager** button in the **Local Clients** section of the main menu.

rsh

On most versions of the UNIX operating system, the command `rsh ncdname wm` (`rsh` is sometimes called `remsh` on System V). Simply replace `ncdname` with the name of the NCD Display Station. Note that this command returns immediately rather than waiting for the window manager to exit, so it must not be used as the last client in your `.xsession` file.

LC_EXEC or NCD_LOCALWLM_EXE

On the VMS operating system, the local window manager will be started automatically if the user has set the **Window Manager** entry in the **Session Manager's Customize** menu to the system logical name `NCD_LOCALWLM_EXE`. Alternatively, the window manager can be started by hand using the `@NCD_ROOT:[BIN]LC_EXEC` command.

remote configuration

If the remote configuration `window-manager-at-reset` parameter is set to "yes" and the `virtual-terminal-at-reset` parameter is set to "telnet-client," "serial-client," "lat-manager," or "none," the window manager will be started whenever the NCD Display Station boots or is reset.

`ncdwm` may be shut down in 3 ways:

Setup

After pressing the **Setup** key (or **Alt+F3** on VT keyboards), triple click on the **Window Manager** button in the **Local Clients** section of the main menu.

f.killncdwm

Use the `f.killncdwm` action in the `ncdlauncher` command.

Control+Alt+KeypadDecimal

Hold down the **Control** and **Alt** keys and press the **Decimal** key on the numeric keypad.

USING NCDWM

ncdwm is a workalike for the OSF/Motif[™] window manager. Most common operations are done through the pointer and its buttons. Unless they have been changed with the *xmodmap* program, **Button1** refers to the left button, **Button2** refers to the middle button, and **Button3** refers to the right button. Clicking **Button1** over a window with click-to-type keyboard focus policy causes that window to be raised and sent all key strokes until another window is given focus.

Windows typically have title bars containing the following items:

Window Menu Button

Pressing and holding the rectangular button on the left brings up a menu for manipulating the window itself. The individual entries are described below. Double-clicking on the button will invoke the **Close** action, removing the window from the screen (often causing the application to exit if this is its only window). To abort the menu, click outside the menu and the button or press the **Escape** key.

Title Button

The long button in the center of the title bar contains the name of the window. Clicking this button with **Button1** raises the window above all other windows. Clicking with **Button3** lowers the window (but keeps the focus in click-to-type keyboard focus). Pressing and dragging with **Button1** will cause an outline of the window to appear and move until the button is released. To abort a move, press the **Escape** key.

Minimize Button

Clicking the button with the small square (second from the right) replaces the window with an icon. Double-clicking with **Button1** on the icon restores the window.

Maximize Button

Clicking the button with the large square (on the right) enlarges the window to the side of the screen (or less if the client specified a smaller maximum size). Dimensions that are already larger than the screen will not be made any larger. To restore the window to its regular size, click again on the button.

Windows are resized by pressing on one of the 8 sections of the frame surrounding the window with **Button1**, dragging in the desired direction, and then releasing the button. As the edge is dragged, an outline of the window will show where the edges of the

window will be. To abort a resize, press the **Escape** key. Clicking **Button3** on a resize handle lowers the window (without changing focus under click-to-type keyboard focus policy).

Pressing on the left-most button in the title bar (the one with a picture of a horizontal stripe) or on an icon brings up a menu for manipulating the window. Keyboard accelerators for the actions for each entry are shown on the right side of the menu and may be used by holding down the **Alt** key and pressing the indicated function key. The entries are:

Restore (Alt+F5)

From a window, this changes the window back to its previous size and location. From an icon, this removes the icon and brings back the window. Icons may also be restored by clicking **Alt+Button2** over the icon.

Move (Alt+F7)

This starts a move operation as if the title button or icon had been pressed and dragged. Move the pointer to the desired location and click. To abort, press the **Escape** key.

Size (Alt+F8)

From a window, this begins a resize operation as if one of the resize handles along the edge of the window had been dragged. Move the pointer across the edge to be changed and click to change the size. To abort, press the **Escape** key. This action may not be selected from an icon.

Minimize (Alt+F9)

From a window, this replaces the window with its icon. This action may not be selected from an icon. This may also be done by pressing **Alt+Button2** over the window.

Maximize (Alt+F6)

From a window, this enlarges the window to its largest size (as described above). From an icon, the window is restored and then enlarged.

Lower (Alt+F3)

This lowers the window or icon beneath other windows and icons (without changing the focus with click-to-type keyboard focus policy). This may also be done by clicking **Alt+Button3** over the window.

Close (Alt+F4)

This instructs the application that the corresponding window should be removed. If the application supports the WM_DELETE_WINDOW client message, that will be used the first time this window is closed. If the application does not remove the window, immediately pressing **Close** several more times will eventually force the application's connection to the X server to be severed.

Recolor (Alt+F12)

On a color display, this causes windows with alternate colormaps (specified by the WM_COLORMAP_WINDOWS property) to cycle to the next colormap. Whenever the window receives focus, this colormap will be installed.

Non-rectangular windows (such as *oclock* or *xeyes*) are not given title bars. The keyboard equivalents described above (particularly **Alt+F7** for move and **Alt+F8** for resize) must be used instead.

SPECIAL KEYS

When the **Alt** key (or other key specified by the **modifier** resource) is held down, several function keys may be used to manipulate the application window or icon that currently has the keyboard focus (useful if the window has no titlebar):

Alt+F2 Raise. This raises the window to the top of the top of the stack of windows on the screen and is equivalent to clicking **Button1** on the titlebar or resize handles.

Alt+F3 Lower. This is equivalent to the *Lower* window menu entry.

Alt+F4 Close. This is equivalent to the *Close* window menu entry.

Alt+F5 Restore. This is equivalent to the *Restore* window menu entry.

Alt+F6 Maximize. This is equivalent to the *Maximize* window menu entry.

Alt+F7 Move. This is equivalent to the *Move* window menu entry.

Alt+F8 Size. This is equivalent to the *Size* window menu entry.

Alt+F9 Minimize. This is equivalent to the *Minimize* window menu entry.

Alt+F12 Recolor. This is equivalent to the *Recolor* window menu entry.

Ctrl+Alt+KeypadDecimal

Exit. This is equivalent to triple-clicking on the **Window Manager** button in the **Setup** menu or invoking the `f.killncdwm` function in `ncdlauncher`.

POSITIONING WINDOWS

If the **USPosition** or **PPosition** flags are specified in the WM_NORMAL_HINTS property on a window, `ncdwm` will leave the window where it was placed by the application (adjusted for the title bar). Otherwise, it is placed in one of several positions in the upper

left corner. In both cases, the position is adjusted so that at least **keepOnScreen** pixels (see below) of the window are visible on the screen.

X DEFAULTS

ncdwm understands the following resources, when attached to the root window **RESOURCE_MANAGER** property [using the *xrdb(1)* host utility or the **initial-x-resources** remote configuration parameter]. The instance of name of the window manager is *ncdwm* and the class name is *NCDwm*. String values are quoted in the description only to make them visible; the quotation marks should **not** be included in the resource value. Also, avoid any trailing spaces.

keyboardFocusPolicy (class **KeyboardFocusPolicy**)

This string specifies the style of keyboard input focus desired. If value is "click" (without the quotation marks), all keystrokes will be directed to the window last clicked with the pointer. If the value is "pointer," input will be sent to the window containing the pointer. The default is "click."

frameBorderWidth (class **FrameBorderWidth**)

This number specifies the default width for frame borders that are wrapped around all windows. Individual border widths may be specified using the ***.borderWidth** subresource described below. The default is 9.

shadowWidth (class **ShadowWidth**)

This number specifies the width of the various shadows used in buttons, menus, and icons. For the best appearance, this should be a very small number. The default is 1.

highlightWidth (class **ShadowWidth**)

This number specifies the width of the various rectangles that highlight menu entries. If zero is specified, a value slightly larger than the shadow size is used. Otherwise, this should be set to a small, positive number (such as 2). The default is 0.

font (class **Font**)

This string specifies the name of the font to use for the title bar and menus. The default is "variable."

iconFont (class **Font**)

This string specifies the name of the font to use for text displayed in icons. This is often set to a small font to allow more characters to be displayed. The default is to use the same font that is shown in the title bar and menus.

moveThreshold (class **MoveThreshold**)

This number specifies the distance in pixels that must be moved when pressing in a title bar before the object is actually moved. Increasing

this number (to a maximum of 10) makes it easier to click on things without accidentally moving them. The default is 4.

modifier (class **Modifier**)

This string specifies the modifier(s) that must be held down to use the accelerator keys F2-F12 and to shut down the window manager. It may contain any of the following strings (without the quotation marks) or combinations of them separated by a vertical bar (|): "shift" or "s" for the Shift key; "lock" or "l" for the Lock key; "control," "ctrl," or "c" for the Control key; "m1-m5" for Mod1-Mod5; "alt" for the Alt key; or "meta" for the Meta key. This is typically used on keyboards in which the combination Alt+F3 is used to bring up the Setup screens. The default is "alt."

keepOnScreen (class **KeepOnScreen**)

This number specifies the number of pixels in the client window that should be kept on the screen in each dimension. A negative value indicates that the whole window should be kept on the screen. The default is 10.

iconDirection (class **IconDirection**)

This string specifies the corner (northwest, northeast, southeast, or southwest) and direction (horizontal or vertical) from which icons should be stacked. Valid strings (without quotation marks) include: "nw-v," "nw-h," "ne-v," "ne-h," "se-v," "se-h," "sw-v," and "sw-h." The default is "sw-h."

flashBorders (class **Flash**)

This boolean specifies whether or not frame borders should change color on monochrome displays when the window has focus. The default is "true" and may not be overridden on color displays.

flashUnmap (class **Flash**)

This boolean specifies whether or not client windows that are being withdrawn (such as when the application exits) should flash as the background is painted. This can be somewhat distracting, but requires slightly less memory. The default is "false."

backingStore (class **BackingStore**)

This boolean specifies whether or not BackingStore should be requested for the window frame. Because the window frame is always at least as large as the client window, this can consume large amounts of memory. The default is "false."

raiseFocus (class **AutoRaise**)

This boolean specifies whether or not windows should be raised as they receive the focus. This is useful in the click-to-type style of

input focus, but can be distracting in the pointer-driven style. The default is “true” for click-to-type and “false” for pointer-driven.

activeBackground (class ActiveBackground)

This string specifies the name or RGB value of the color to be used as the background of the window frame or icon that currently has the keyboard focus. For best results, this color should be a pastel that is neither too bright in window frames nor too dark in menus or icons. The default is a gentle green (“#00c4a8”) and may only be overridden on color displays (the light blue “#69b9cd” also looks very nice).

inactiveBackground (class InactiveBackground)

This string specifies the name or RGB value of the color to be used as the background of window frames or icons that currently do not have the keyboard focus. For best results, this color should be a shade of gray. The default is “#bababa” and may only be overridden on color displays.

packIcons (class PackIcons)

This boolean specifies whether or not a window’s icon should always try to pack itself tightly into the grid when the window is minimized. Normally, the icon will be sent to its previous position. The default is “false.”

stippleIcons (class Stipple)

This boolean specifies whether or not icon images should be stippled onto the gray background or not. This resource *does not* apply to color displays. If this option is set to false, a white background will be painted behind the icon. The default is “true.”

gridMoveIcons (class gridMoveIcons)

This boolean specifies whether or not icon outlines that are being dragged on the screen should keep to the grid location where they would end up. If this option is set to true, icon outlines will appear in their proper places. Otherwise, the outlines will move smoothly but will “jump” to their final location. The default is “false” to match Motif.

iconBitmapWidth (class IconBitmapSize)

This integer specifies the width in pixels of bitmaps or client-supplied windows in icons. This is typically set when applications with unusually large icon windows or bitmaps are used. The default is 48.

iconBitmapHeight (class IconBitmapSize)

This integer specifies the height in pixels of bitmaps or client-supplied windows in icons. This is typically set when applications with

unusually large icon windows or bitmaps are used. The default is 48.

blurShadows (class **BlurShadows**)

This boolean specifies whether or not the white and black shadows in buttons, menus, and icons should be blurred to blend in with the active and inactive background colors. This option causes the window manager to allocate several more colormap slots, but may be more pleasing to the eye. The default is "true" and may only be overridden on color displays.

focusLenience (class **Lenience**)

This boolean specifies whether or not all windows should be allowed to receive focus in click-to-type mode. When a window is first mapped, or when the currently-focused window is iconified or closed, the window manager will set the focus to the most recently focused window. If this option is set to False, only those windows whose WM_HINTS input field is set to True will be eligible for this automatic focusing. Unfortunately, many older applications (particularly DECwindows) do not set the input hint properly. If this option is set to True, the input will be ignored and all windows will be allowed to have focus. The default is "false."

sizeLenience (class **Lenience**)

This boolean specifies whether or not applications should be allowed to request window sizes that don't correspond to the base size, increment size, and aspect ratios specified in the WM_NORMAL_HINTS property. This is useful for older applications that accidentally set invalid size hints properties (such as the R4 xterm from MIT). If this option is set to True, application size requests are honored even if they are incorrect. The default is "true."

propertyLenience (class **Lenience**)

This boolean specifies whether or not applications should be allowed to set the type of the WM_PROTOCOLS property incorrectly. This is useful for older applications that set the property by hand instead of using the library routine `XSetWMProtocols`. If this option is set to True, the window manager will ignore the invalid type. The default is "true."

disableClose (class **DisableClose**)

This boolean specifies whether or not the *Close* entry in frame and icon menus (as well as double-clicking in the frame menu button) should be disabled. In VMS 5.4 and below, closing a window from the window manager can cause all copies of the application (such as DECterm) to shutdown rather than just the desired one. The **Alt+F4** key sequence may still be used to force the window to disappear.

xorValue (class XorValue)

This number specifies the pixel value to be used when drawing rubberbanded lines. This is used on color displays to set the bits that should be toggled when drawing temporary lines and is only necessary when the colors in the upper parts of the colormap are hard to distinguish from backgrounds of windows on the screen. In general, this option should be set to a small number (such as 1 or 2) or the default 0 (which indicates that all available bits in a pixel should be toggled).

menuDelay (class MenuDelay)

This number specifies the amount of time in milliseconds (to a maximum of 1000) that the window manager should wait before displaying window or icon menus. This is useful for preventing the menu from coming up when double-clicking. The default is 100.

In addition, the following subresources may be set to control each client window frame (which has the instance and class name specified in the WM_CLASS property on the client window):

titlebar (class Titlebar)

This boolean specifies whether or not the window should have a title bar. Non-rectangular windows are never given title bars. The default is "true."

borderWidth (class BorderWidth)

This number specifies the size of the frame border to be shown around the window. If -1 is given, the border width specified by the actual client window is used. A value of 0 will turn off borders for this window. The default is to use the width given by the **frameBorderWidth** resource.

EXAMPLES

The following X defaults are commonly used with *ncdwm*:

```
NCDwm.Flash: off
NCDwm.keepOnScreen: -1
NCDwm.gridMoveIcons: on
NCDwm.iconDirection: se-v
NCDwm.xterm.borderWidth: 4
NCDwm.font: -adobe-helvetica-bold-r-normal--*-120-*-*-p*-iso8859-1
NCDwm.iconFont: -adobe-helvetica-bold-r-normal--*-80-*-*-p*-iso8859-1
NCDwm.XClock.titlebar: off
NCDwm.XClock.borderWidth: 0
NCDwm.XBiff.titlebar: off
NCDwm.XBiff.borderWidth: 0
```

NCDwm.XLogo.titlebar: off
 NCDwm.XLogo.borderWidth: 0

To work around problems with older DECwindows not setting the WM_HINTS input field, you can set the following resource:

NCDwm.focusLenience: on

Also, the following resource is useful in DECwindows environments on VMS 5.4 and below because it prevents applications from accidentally being closed from the title bar (which causes all DECterms to be closed):

NCDwm.disableClose: on

In OpenWindows environments, the following resource makes icons large enough to hold the standard-size application-supplied icon windows.

NCDwm.IconBitmapSize: 64

Interesting active background colors include:

NCDwm.ActiveBackground: #00c4a8 (NCD logo green)
 NCDwm.ActiveBackground: #69b9cd (light blue)
 NCDwm.ActiveBackground: #c9b7e5 (mauve)
 NCDwm.ActiveBackground: #f0ca89 (sandy brown)

REMOTE CONFIGURATION PARAMETERS

ncdwm is affected by the following remote configuration parameters:

window-manager-at-reset, virtual-terminal-at-reset

If **window-manager-at-reset** is set to "yes" and **virtual-terminal-at-reset** is set to "none," "telnet-client," "serial-client," or "lat-manager," the window manager will be started automatically whenever the NCD Display Station is booted or reset.

initial-x-resources

The X resources described above may be set using this parameter. This sets the root window RESOURCE_MANAGER property so that the resources may be manipulated or overridden with the *xrdb*(1) program.

enable-local-launcher

If this parameter is set to **yes**, a root menu for starting local clients and for shutting down the window manager is provided whenever *ncdwm* is started. User-defined root menus can be created by setting this parameter to **no** and running the *ncdlauncher* program.

MWM COMPATIBILITY NOTES

To keep the window manager small, several features of *mwm* were left out of this release:

Root Menus

Because of the lack of session managers, many window managers have historically provided user-definable popup menus that can be used to start applications. Because *ncdwm* runs inside the NCD Display Station rather than on the host, it does not have built-in root menus (except when the **Enable Local Launcher** option is set). Instead, a host-side program called *ncdlauncher* may be used to start programs.

_MOTIF_WM_HINTS

The private property `_MOTIF_WM_HINTS`, used to manipulate window decorations and application- and system-modal operation, is currently not supported.

Groups and Transients

Window group and transient-related operations (such as group moving, raising, or iconifying) are currently not supported.

Icon Boxes

Icon boxes are not supported.

Keyboard Traversal

General keyboard traversal is not supported.

Feedback Control

Confirmation boxes and changes in how moving and resizing boxes are displayed are not supported.

Color Defaults

The colors used for highlighting and unhighlighting windows to show keyboard focus may be overridden only on color displays.

SEE ALSO

ncdlauncher(1), *X*(1), *xrdb*(1), *xdm*(1)

COPYRIGHT AND TRADEMARKS

Copyright 1991, Network Computing Devices, Inc. All rights reserved. NCD Display Station is a trademark of Network Computing Devices, Inc. OSF/Motif is a trademark of the Open Software Foundation. DECwindows and VMS are trademarks of Digital Equipment Corporation. OpenWindows is a trademark of Sun Microsystems. X Window System is a trademark of MIT.

AUTHOR

Jim Fulton, Network Computing Devices, Inc.

NAME

xinitremote - X Window System initializer

SYNOPSIS

xinitremote [[*client*] *options*] [-- [*server*] [*display*] *options*]

DESCRIPTION

The *xinitremote* program is used to start the X Window System server and a first client program (usually a terminal emulator) on systems that cannot start X directly from */etc/init* or in environments that use multiple window systems. When this first client exits, *xinitremote* will kill the Xremote server and then terminate.

When running *xinitremote*, the *Xremote* program acts as a proxy for display *n* on the current host. The display number (*n*) is chosen dynamically by the *Xremote* program, and the chosen number is given back to *xinitremote*, and then placed into the environment before the client is executed.

If no specific client program is given on the command line, *xinitremote* will look for a file in the user's home directory called *xinitremoterc* to run as a shell script to start up client programs. If no such file exists, *xinitremote* will use the following as a default:

```
xterm -geometry +1+1 -n login
```

If no specific server program is given on the command line, *xinitremote* will look for a file in the user's home directory called *xserverrc* to run as a shell script to start up the server. If no such file exists, *xinitremote* will use the following as a default:

```
Xremote
```

Note that this assumes that there is a program named *Xremote* in the current search path. However, servers are usually named *Xdisplaytype* where *displaytype* is the type of graphics display which is driven by this server. The site administrator should, therefore, make a link to the appropriate type of server on the machine, or create a shell script that runs *xinitremote* with the appropriate server.

An important point is that programs which are run by *xinitremote* and by *xserverrc* should be run in the background if they do not exit right away, so that they don't prevent other programs from starting up. However, the last long-lived program started (usually a window manager or terminal emulator) should be left in the foreground so that the script won't exit (which indicates that the user is done and that *xinitremote* should exit).

An alternate client and/or server may be specified on the command line. The desired client program and its arguments should be given as the first command line arguments to *xinitremote*. To specify a particular server command line, append a double dash (--) to the *xinitremote* command line (after any client and arguments) followed by the desired server command.

Both the client program name and the server program name must begin with a slash (/) or a period (.). Otherwise, they are treated as an arguments to be appended to their

respective startup lines. This makes it possible to add arguments (for example, foreground and background colors) without having to retype the whole command line.

If an explicit server name is not given and the first argument following the double dash (--) is a colon followed by a digit, *Xremote* will use that number as the display number instead of its initial default of one. All remaining arguments are appended to the server command line.

EXAMPLES

Below are several examples of how command line arguments in *xinitremote* are used.

xinitremote

This will start up a server named *Xremote* and run the user's *xinitmoterc*, if it exists, or else start an *xterm*.

xinitremote -geometry =80x65+10+10 -fn 8x13 -j -fg white -bg navy

This will start up a server named *Xremote*, and will append the given arguments to the default *xterm* command. It will ignore *xinitmoterc*.

Below is a sample *xinitmoterc*

that starts a clock, several terminals, and leaves the window manager running as the "last" application. Assuming that the window manager has been configured properly, the user then chooses the "Exit" menu item to shut down X.

```
xrdb -load $HOME/.Xres
xsetroot -solid gray &
xclock -g 50x50-0+0 -bw 0 &
xload -g 50x50-50+0 -bw 0 &
xterm -g 80x24+0+0 &
xterm -g 80x24+0-0 &
uwm
```

Sites that want to create a common startup environment could simply create a default *xinitmoterc* that references a site-wide startup file:

```
#!/bin/sh
./usr/local/lib/site.xinitmoterc
```

Another approach is to write a script that starts *xinitremote* with a specific shell script. Such scripts are usually named *x11*, *xstart*, or *startx* and are a convenient way to provide a simple interface for novice users:

```
#!/bin/sh
xinitremote /usr/local/bin/startx
```

ENVIRONMENT VARIABLES**DISPLAY**

This variable gets set to the name of the display to which clients should connect.

XINITRC

This variable specifies an init file containing shell commands to start up the initial windows. By default, *.xinitmoterc* in the home directory will be used.

XREMOTETMPDIR

This variable is used as the directory for the log file containing all stdio library output from the Xremote helper and all the clients run by the *.xinitmoterc* script. A file in this directory with the name "Xremotedigits," where *digits* is the display number, contains the output from the session.

TMPDIR

If there is no *XREMOTETMPDIR* variable, then the *TMPDIR* variable is consulted for the name of the directory in which to leave the log file. If neither of these variables is present, the log file is left in the */usr/tmp* directory.

FILES

<i>/usr/tmp/Xremote*</i>	Contains redirected standard out and standard error streams from the <i>Xremote</i> server. The numerical suffix of this file name is the display number which was established by the <i>Xremote</i> server.
<i>/dev/tty</i>	Default line on which to run the <i>Xremote</i> server. See the manual page for <i>Xremote</i> for further details.
<i>~/.xinitmoterc</i>	This file is the script describing the clients to start when the Xremote session is initiated.
<i>~/.xinitrc</i>	For backward compatibility with older versions of <i>xinitremote</i> , this file will be used as the startup script if the <i>.xinitmoterc</i> file is not present.

SEE ALSO

X(1), Xremote(1), xterm(1), xrdb(1), tempnam(3s)

COPYRIGHT

Copyright 1990, Network Computing Devices, Inc.
 Copyright 1988, Massachusetts Institute of Technology.
 See *X(1)* for a full statement of rights and permissions.

AUTHOR

Dave Cornelius, Network Computing Devices, Inc.
 Bob Scheifler, MIT Laboratory for Computer Science

NAME

Xremote - X Protocol interpreter for serial lines

SYNOPSIS

Xremote [: *n*] [-line /dev/ttyxxx] [-speed *rate*] [-scanbase *n*] [-scanmax *n*]
[-report *fd*]

DESCRIPTION

Typically, the *Xremote* program is invoked by *xinitremote*, which will also initiate one or more X Window System client programs.

The *Xremote* program is a protocol interpreter that acts as the endpoint of a TCP-domain X-windows connection, and communicates over a serial line to an appropriately configured NCD X-server. It listens on TCP port 6000+*n* on the host for incoming connections from X clients on the network and multiplexes all these clients' X-wire data over the serial line to the NCD. The *Xremote* program starts looking for available TCP ports at its default base of 6001, which corresponds to X display 1, and attempts to bind to successive ports up to 6051.

On HP-UX systems, *Xremote* also opens the UNIX-domain socket that corresponds to the display number obtained by the scan for free TCP ports. This allows *xinitremote* to set the environment variable *\$DISPLAY* to *hostname:1*, which is interpreted by HP-UX's *Xlib* in a fashion similar to *unix:1* on other implementations of *Xlib*.

A full-duplex, three-layer protocol stack is used by *Xremote* to connect the helper process on the host machine to the server code running in the NCD.

The lowest layer of the *Xremote* protocol is a datagram service. Each datagram is protected by a 16-bit CRC frame check sequence. A character-stuffing mechanism is used to mark datagram boundaries, and to escape certain special characters in the data stream.

A second level implements a reliable, full-duplex data stream, which allows multiple in-flight packets, handles packet retransmission, and utilizes a general purpose data compression mechanism.

The highest level provides additional X-wire specific data compression, as well as X-connection and X-wire data transport services.

OPTIONS

- line /dev/ttyxxx
Use the specified device name for running the serial protocol. The default is /dev/tty.
- speed *rate*
Set the baud rate on the line to the given rate. The default is to use whatever

rate is currently set.

-scanbase *n*

Set the base for the display scanning. The default is 1. This number is added to 6000 to generate the TCP port number upon which the *Xremote* process will listen for incoming X connections.

:*n* Same as **-scanbase *n***. Used for compatibility with other *xinitremote*-style startup sequences.

-scanmax *n*

Limits the number of TCP ports that will be scanned before giving up. The default is 1 if the **-report** option is not specified, and 50 if **-report** is specified.

-report *fd*

Emit the display number obtained by the TCP port scan on inherited file descriptor *fd* as a decimal number. Typically, this file descriptor is the writable side of a pipe into the parent process. This argument is supplied automatically when *xinitremote* invokes *Xremote*. The file descriptor is closed immediately after the display number is written.

SIGNALS

When the *Xremote* process is ready to accept connections, it will send a *SIGUSR1* signal to its parent process.

FILES

/dev/tty Default line on which to run the *Xremote* server.

SEE ALSO

X(1), *xinitremote*(1)

COPYRIGHT

Copyright 1990, Network Computing Devices, Inc.

AUTHOR

Dave Cornelius, Network Computing Devices, Inc.

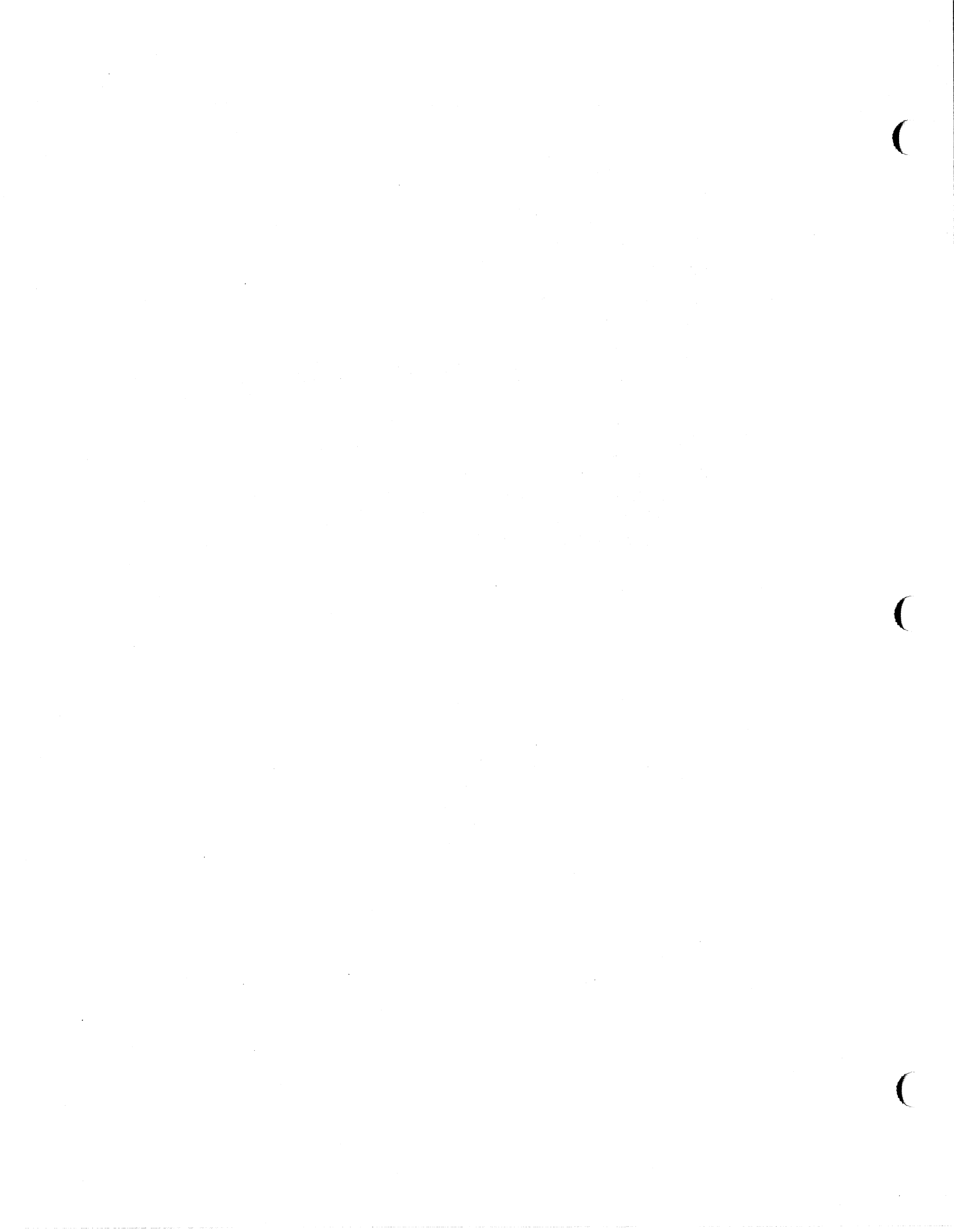

Glossary

ANSI	American National Standards Institute
ANSI X3.64	a VT100-like terminal emulation standard
Application clients	application programs that can be run under the X Window System
Boot Monitor	a program in display station PROMs that monitors the download
Client	an X Window System application program
DCE	Data Communications Equipment; an RS-232C connection standard used mostly by modems
DTE	Data Terminal Equipment; an RS-232C connection standard used by most hosts and terminal servers. The NCD Display Station is always wired as DTE
Ethernet	a network protocol (IEEE 802.3) for transmitting data at 10 Mbits/second over coaxial cable (thin or thick), twisted pair cable, or fiber optic cable.
Ethernet Address	an address identifying a module on an Ethernet network

Glossary

NCDnet	A software option that allows an NCD display station to fully participate in a DECnet network
NVRAM	Non-Volatile Random Access Memory; retains entries after power is removed
OSF/Motif	Graphical User Interface designed by the Open Software Foundation and used with the NCD window manager
PROM	Programmable Read-Only Memory
Root Weave Window	the window that fills the screen during an X session; all windows opened by clients appear on top of the root weave window
RS-232C	an interface standard for asynchronous serial data communication
Serial Session	a program that allows an NCD network display station to emulate an ANSI X3.64 terminal
Server	1. a station on a network providing a service, such as making a file or printer available. 2. an X server
SIMM	Single In-Line Memory Module
SLIP	Serial Line Internet Protocol, a protocol that allows a display station to be used over an asynchronous RS-232C port

TCP	Transmission Control Protocol, an Internet protocol used by the X Window System to provide reliable data communication
TCP/IP	Transmission Control Protocol/Internet Protocol, a common name for the Internet protocol family
X server	An executable module that obeys the X window system protocol
X Window System	a set of network protocols developed by MIT for display of windows in a network; also called X or X11

C

C

C

INDEX

- auxiliary port 25
- backing store 20
- baud rate 27
- Boot Monitor
 - error messages 59
- booting
 - Boot X at Reset parameter 24
 - from PROMs 39
 - over Ethernet 61
 - selecting the server 24
- border color 18
- borders and corners 49
- Built-In Fonts 71
- cables
 - direct connection 38
 - modem 37
 - null modem 35
 - required 4
 - serial cable pinouts 37
 - straight-through 35
- Caps Lock LED 18
- compatibility with past releases of X 21
- Configuration Menus
 - Network Parameters 23
 - Serial Port Parameters 25
 - Utilities 28
- X Server Parameters 19
- configuring the display station
 - booting method 39
 - saving settings in NVRAM 42
 - setting up the serial connection 38
 - setting XRemote parameters 40
- data bits 26
- DB-25 connector 35
- DECwindows modifier keys 21
- diagnostic messages
 - file 45
 - menus 45
- Diagnostic Session
 - about 45
- dialing in 43
- DISPLAY variable 43
- documentation
 - X Window System iv
- DTE devices 38
- error notification popup 22
- Ethernet
 - addresses 24
 - connecting to 61
- FastComm modem settings 63
- flow control 26
- font downloading 74
- fonts
 - diagnostics 22

- handshake 26
- icon
 - closing 53
 - moving 52
- Information Menus
 - Network Statistics 29
 - XRemote Statistics 31
- keyboards
 - LED functions 18
 - list of supported keyboards 21
 - setting the type 21
 - troubleshooting 60
- Local Client 18
 - Window Manager 18
- Log File 75
- logging in to a host 43
- Main Menu 12
- Maximize Button 49
- memory
 - displaying information about 17
 - warnings 32
- memory requirements 66
- Menu Button 49
- Menus
 - overview 7
- Minimize (Iconify) Button 49
- modem requirements 70
- modems
 - cable 37
 - FastComm 5, 63
 - guidelines 5
 - setting up 37
- modifier keys
 - in DECwindows 21
- monitor controls 60
- mouse
 - troubleshooting 60
- NCD Documentation iii
- ncdlauncher 83
- ncdrestartwm 83
- ncdwm 83
- NCDwm, 47
- network
 - activity LED 18
 - setting parameters 41
- Network Parameters Menu
 - settings for XRemote 41
- Network Statistics Menu
 - about 45
- Num Lock LED 18
- NVRAM 7, 8, 25, 42, 63, 64
- overscan 18
- parity 26
- pointers 50
- PROMs 4

-
- Read Power-On Values button 13
 - remote hosts 78
 - Reset Server button 13
 - resetting the server 22
 - RS-232C
 - direct connection cable 38
 - modem cable 37
 - Save Power-On Values button 13
 - screen lock 28
 - serial cable 37
 - Serial Parameters menu
 - parameters 26
 - serial port
 - configuring 25, 27, 41
 - serial port considerations 35
 - Serial Port Parameters menu
 - settings for XRemote 41
 - Serial Session
 - automatic 40
 - dialing in from 43
 - troubleshooting 59
 - server
 - default parameters 20
 - displaying version 16
 - location of 24
 - server differences 67
 - Sessions
 - Diagnostic Session 16
 - Serial Session 14
 - Setup Key 9
 - N-108 9
 - VT220 9
 - Setup Menu Changes and Additions 66
 - setup menus
 - background color 18
 - buttons and fields 10
 - displaying 9
 - exiting 11
 - interruption of X session 11
 - loading values 13
 - moving between 11
 - saving values 13
 - starting the server 39, 44
 - stop bits 26
 - tapes 70
 - Technical Support 57
 - title bar 49
 - UNIX Host Configuration 73
 - User Preferences 18
 - VMS Font Path 76
 - VMS Host Configuration 76
 - VMS Log File 76
 - warning LED 18
 - window
 - closing 53
 - iconifying 51
-

Index

- lowering 52
- maximizing 51
- moving 51
- raising 52
- resizing 52
- restoring 51
- window area 49
- window button operations 51
- Window Manager
 - access 48
 - automatic 40
 - clients 65
 - configuration 74
 - functional areas 48
 - introduction 47
- Window Manager, VMS
 - starting 77
- Window Menu 54
- xinitremote 83
 - starting XRemote 44
- XON/XOFF 26
- XRemote 83
 - basic operation 3
 - components 4
 - how it works 68
 - PROMs 4
 - protocol stack 69
 - quitting 46
 - starting 44
 - tapes 4
 - XRemote Statistics
 - about 45
 - xterm 75