

data acquisition systems

1 ST LINE NUCLEAR DATA, INC.
2 ND LINE Golf and Meacham Roads
Schaumburg, Illinois 60196

May, 1977

OPERATOR'S INSTRUCTION MANUAL
ND600 MULTIPLE INPUT ZERO DEAD TIME
MULTICHANNEL SCALING MODULE (88-0583)

Copyright 1977, by Nuclear Data, Inc.
Printed in U.S.A.

ND600 MULTIPLE INPUT ZERO DEAD TIME MULTICHANNEL SCALING MODULE (88-0583)

DESCRIPTION

The ND600 Multiple Input Zero Dead Time Multichannel Scaling Module provides full time data input to the ND600 from up to two/four inputs, virtually eliminating dead time. Input count rates to 16 MHz may be processed on each input. Front panel controls are provided for selecting the number of inputs, group size per input, dwell time, single or recurrent sweeps and forward or forward/reverse sweep modes.

All module circuitry is contained in a 4-wide NIM module. Interconnections to the ND600 system are made through one 50-pin ribbon cable (data) and one 20-pin ribbon cable (address and control). Basic module circuitry includes an address scaler, crystal controlled time base, and separate (20 binary bit) buffer/scalers for each input. The buffer/scalers accumulate counts independently.

Dwell time in microseconds is selected by two front-panel switches; seven decade multiplier's with digit selections from 1 to 9, or external. The number of inputs and group size per input are also front-panel switch selectable, and should correspond to actual memory size. Acquisition is performed in the ND600 PHA mode.

All acquisition and display functions are controlled by the ND600. During acquisition, input events are accumulated in a set of buffer scalars for the selected dwell time. At the end of the dwell time a second set of buffers are activated, and the buffered data is routed to the ND600 and added to or subtracted from the contents of the respective memory locations as specified by the ND600 storage mode. Count storage is inhibited in the first and last channels of each memory group.

TECHNICAL SPECIFICATIONS

Number of Inputs: Two standard; four with option 84-0273.

Buffer Capacity: $2^{20} - 1$ per input.

Count Rate: Up to 16 MHz at each input with pulse pair resolution of 60 nsec.

Time Base: Internal 10-MHz crystal controlled oscillator, or external time base.

Dwell Time: Switch selectable in microseconds; 7 decade multipliers with digit selection from 1 to 9, or external.

Storage Format: Sequential, e.g. input 1, input 2, input 3 and input 4.

Power Requirements (supplied by separate NIM bin/power supply): +6 Vdc @ 2.5 A (two inputs). +6 Vdc @ 3.8 A (four inputs). -12 Vdc @ 25 mA.

Dimensions: 8.71 in. h. x 5.36 in. w. x 9.7 in. d. (NIM compatible four width module).

Part Number: 88-0583. Four-Input Option - 84-0273.

INSTALLATION

Prior to installing the Multiple Input Zero Dead Time (ZDT) Multichannel Scaling (MCS) Module and the additional equipment required for its operation, refer to Chapter II of the ND600 Operators Instruction Manual, noting the rear board housing of the ND600 Electronics Enclosure. The ZDT MCS Module and the additional equipment required for its operation (NIM bin and power supply) are installed as follows:

1. Carefully unpack the ZDT MCS Module and NIM bin and power supply, saving the shipping carton for possible re-shipment. Thoroughly inspect the equipment after its removal from the shipping cartons. Examine the front and rear panels for possible damage to controls, indicators and connectors. If damage incurred during transit is apparent, notify the delivering carrier and then notify the nearest Nuclear Data representative or the Nuclear Data home office.

NOTE: The delivering carrier must be notified within 24 hours after receipt of the equipment to ensure reimbursement for any damages incurred during transit.

2. Locate the NIM bin and power supply adjacent to the ND600 Electronic Enclosure.

NOTE: The ZDT MCS Module is normally inserted into the NIM bin prior to shipment from the factory. If the ZDT MCS Module is to be installed into an existing NIM bin, ascertain that the bin power supply used is capable of providing the power requirements of the ZDT MCS Module (see Technical Specifications) in addition to any other modules in the NIM bin being used. The ZDT MCS Module is installed in the NIM bin as follows:

3. Lead the two ribbon interface cables at the rear of the ZDT MCS Module through the rear of the NIM bin and insert the module into the NIM bin in such a manner as to mate the 42-pin male power connector on the rear of the module to a 42-pin female power connector at the rear of the NIM bin.

4. Fasten the ZDT MCS Module to the front of the NIM bin with the two retaining screws on the module front panel.
5. Remove ac power from the ND600 Electronics Enclosure by setting the rear panel POWER rocker switch to OFF.
6. Remove ND600 rear cover retaining screws and remove rear cover.
7. Pull the ACT board half way out of the rear board housing.
8. Interconnect the ZDT MCS Module to the ACT board as follows:
 - a. Insert the 20-pin female connector on the ribbon cable from the ZDT MCS Module into the 20-pin male connector designated BDC on the ACT board such that the color mark on the ribbon cable is at the right.
 - b. Insert the 50-pin female connector on the ribbon cable from the ZDT MCS Module into the 50-pin male connector designated DXT on the ACT board such that the color mark on the ribbon cable is at the right.
- NOTE: The ribbon cable with the 50-pin female connector is connected through the cable clamp to the board in location 103 of the ZDT MCS Module and the ribbon cable with the 20-pin female connector connects to the board in location 101.
9. Push the ACT board back into the rear board housing until it is firmly seated.
10. Carefully replace the rear cover on the ND600 Electronics Enclosure, pulling up slack in the ribbon cables and replace retaining screws.
11. Connect the ac line cord from the Bin Power Supply to a conveniently located ac outlet.
12. Set NIM bin POWER switch up to light POWER indicator.
13. Return ac power to the ND600 Electronics Enclosure by setting the rear panel POWER rocker switch to ON. The ZDT MCS Module is now operational and ready for use.

CONTROL AND CONNECTOR DESCRIPTIONS

Front-Panel Controls

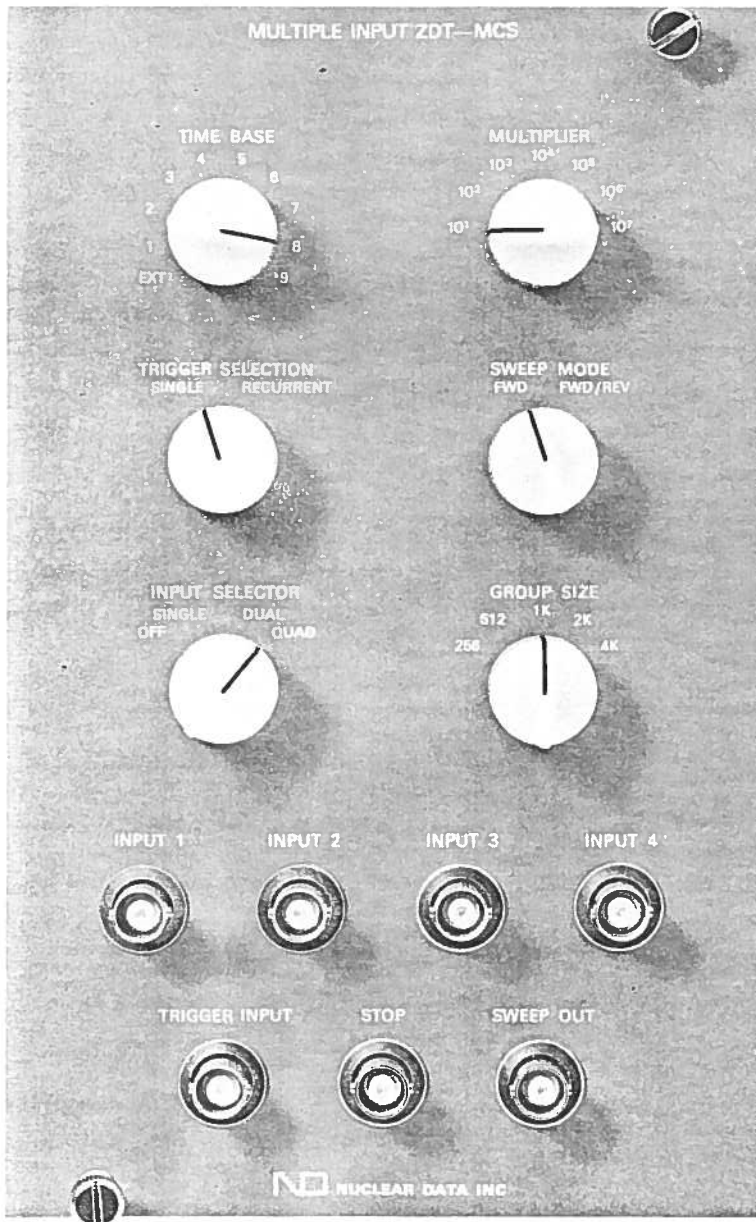

INPUT SELECTOR - Four position rotary switch selects number of inputs. OFF, SINGLE, DUAL and QUAD positions. (If the module is not being used, switch should be in OFF position.)

GROUP SIZE - Five position rotary switch specifies memory storage group size per input. 256, 512, 1K, 2K and 4K positions.

SWEEP MODE - Two position rotary switch selects forward or forward/reverse address scaling. FWD and FWD/REV positions.

TIME BASE - Ten position rotary switch selects digit portion of dwell time or specifies external control of dwell time. 1 through 9 and EXT positions.

MULTIPLIER - Seven position rotary switch selects multiplier portion of dwell time in microseconds. Multiplier is an integer power of 10. 10^1 through 10^7 positions. The minimum dwell time is 50 microseconds for one input, 100 microseconds for two inputs, and 200 microseconds for four inputs.

TRIGGER SELECTION - Two position rotary switch selects single or multiple sweeps through memory. SINGLE and RECURRENT positions.

Front Panel Connectors

INPUT 1, INPUT 2, INPUT 3, INPUT 4 (BNC connectors) - Require positive pulses (+2.4 to +5 Vdc in amplitude) with minimum durations of 30 nsec. Impedance is 75 ohms to ground.

SWEEP OUT (BNC connector) - Provides a +3 to 0 Vdc output pulse at the start of each sweep with a minimum duration of 0.5 μ sec. The first output pulse is in response to a trigger input.

TRIGGER INPUT (BNC connector) - Input signal used to start a multichannel scaling pass. Requires a +3 to 0 Vdc pulse with minimum duration of 0.5 μ sec. (Start occurs on negative transition of the pulse.) Impedance is 1000 ohms to +5V. Time base throughput delay from trigger input is 400 (+50, - 30) nsec for the 10^1 position of the MULTIPLIER switch; 800 (+50, - 30) nsec for the 10^2 through 10^7 positions.

STOP (BNC connector) - Input signal which automatically terminates sweep. Requires a +3 to 0 Vdc pulse with minimum duration of 0.5 μ sec. (Stop occurs on negative transition of the pulse.) Impedance is 1000 ohms to +5 V.

Rear Panel Connectors

Standard NIM bin power connector.

EXT TIME BASE (BNC connector) - Input for external time base generator. Requires a 0 to +3 Vdc pulse with minimum duration of 0.5 μ sec. (Advance occurs on negative transition of the pulse.) Impedance is 1000 ohms to +5V.

OPERATION

All multichannel scaling acquisition and display functions are controlled by the ND600, with acquisition performed in the ND100 PHA mode.

Dwell time in microseconds is selected by the front panel TIME BASE and MULTIPLIER switches on the ZDT MCS Module, 50 microseconds minimum per channel per input. The number of inputs (one, two or four) are selected at the front panel INPUT SELECTOR switch on the ZDT MCS Module. The group size per input is selected by the front panel GROUP SIZE switch on the ZDT MCS Module. If an ADC module and the ZDT MCS Module is used, the ADC module must be disabled either by disconnecting all input BNC cables to the ADC or by setting the ADC ACQ/OFF/STRB switch to OFF. Similarly, if the ADC is used, the ZDT MCS Module must be disabled by setting INPUT SELECTOR switch to OFF.

During acquisition from the ZDT MCS Module, input events are accumulated in a set of buffer scalers for the selected dwell time. At the end of the dwell time a second set of buffers are activated, and the buffer data is routed to the ND600 memory and added to or subtracted from the contents of the respective memory location as specified by the ND600 storage mode. Count storage is inhibited in the first and last channels of each memory group.

The ZDT MCS Module contains an address register and address routing logic which allows assigning memory storage space to the corresponding scaling inputs. For example, the first input (INPUT 1) can address the first 256 data channels up to 2048 data channels (4096 if the basic ND600 is expanded to 4096 channels of memory). The following are the storage configurations possible.

One input (INPUT 1): 1 x 256 to 1 x 4096.

Two inputs (INPUT 1 and INPUT 2): 2 x 256 to 2 x 2048.

Four inputs (INPUT 1, INPUT 2, INPUT 3 and INPUT 4): 4 x 256 to 4 x 1024.

NOTE: INPUT 3 and INPUT 4 require that the ZDT MCS Module be equipped with option 84-0273. Since a hardware "lock-up" will occur if the ZDT MCS Module addresses non-existent memory space, storage configurations requiring 4096 data channels cannot be used unless the basic ND600 is expanded to 4096 channels of memory. ←

The following operating procedure describes data acquisition using the ZDT MCS Module. When performing this procedure, either one, two or four count inputs are applied to the front panel BNC's (INPUT 1, INPUT 2, INPUT 3, INPUT 4) with an appropriate start input applied to the front panel TRIGGER INPUT BNC. Recurrent multichannel scaling forward/reverse scans will be performed through a 2048 channel memory group at a dwell time of 10 msec per channel. Each multichannel scaling scan is initiated by a +3 to 0V start pulse applied to the TRIGGER INPUT BNC.

1. Apply appropriate input signals to the front-panel input BNC's.
2. Select a memory storage group of 2048 channels.
 - a. Select Status Page 1.
 - b. Set the display cursor to the GSIZ parameter using the CRSR pushbutton.
 - c. Enter 2048 at the operand pushbutton array and depress the ENTER pushbutton.

NOTE: The display group (DGRP) and acquire group (AGRP) parameters (Status Pages 1 and 2, respectively) are initialized to 1 when power is applied.

3. Select the ZDT MCS mode.
 - a. Select Status Page 2.
 - b. Set the display cursor to the MODE parameter using the CRSR pushbutton.
 - c. Select either the PHAL or PHAC mode using the NXTV pushbutton.
4. Select subtract operation, if desired.
 - a. Set the display cursor to the AGRP parameter using the CRSR pushbutton.
 - b. Depress the minus (-) pushbutton, enter 1 at the operand pushbutton array and depress the ENTER pushbutton.
5. Set the TBASE parameter to 1 and the TMULT parameter to 1S.
 - a. Set the display cursor to the TBASE parameter using the CRSR pushbutton.
 - b. Enter 1 at the operand pushbutton array and depress the ENTER pushbutton.
 - c. Set the display cursor to the TMULT parameter using the CRSR pushbutton.
 - d. Select a time multiplier of 1S using the NXTV pushbutton.
6. Select values other than 0 for the PTIM, PTOT and PLEV parameters as desired.

NOTE: Acquisition can be terminated under control of the PTOT or PLEV parameters as desired. The PTIM parameter allows selection of a preset number of passes but can only be used when the SWEEP MODE switch on the ZDT MCS Module is set to FWD. Acquisition is terminated upon completion of the pass in which the selected preset parameter is reached or exceeded.

7. Erase the selected memory group by simultaneously depressing both ERASE pushbuttons.
8. Select the number of count inputs by setting the INPUT SELECTOR switch on ZDT MCS Module to SINGLE (1 input), DUAL (2 inputs) or QUAD (4 inputs).
9. Select a dwell time of 10 msec per channel per input by setting the TIME BASE switch on ZDT MCS Module to 1 and MULTIPLIER switch to 10^4 .
10. Select the group size per input by setting the GROUP SIZE switch on ZDT MCS Module to 2K if 1 input is selected; 1K if 2 inputs are selected; or 512 if 4 inputs are selected. This selects the size of the multichannel scaling group per input relative to the size of the memory group selected (2048 channels).
11. Select recurrent multichannel scaling sweeps by setting the TRIGGER SELECTION switch on ZDT MCS Module to RECURRENT.

NOTE: If single multichannel scaling sweeps were selected (TRIGGER SELECTION switch set to SINGLE), a start pulse must be applied to the TRIGGER INPUT to initiate each multichannel scaling sweep.

12. Select forward/reverse multichannel scaling sweeps by setting the SWEEP MODE switch on ZDT MCS Module to FWD/REV.

NOTE: If an ADC Module is connected to the ND600 Analyzer System, it must be disabled during multichannel scaling operation (set ADC ACQ/OFF/STRB switch to OFF).

13. Start multichannel scaling data acquisition by depressing the minus (-) pushbutton and then the ACQ pushbutton twice. The first multichannel scaling sweep in the forward direction is initiated when the start pulse is applied. Upon completion of the forward sweep, a second sweep (this time in the reverse direction) is initiated. Each subsequent sweep is initiated upon completion of the previous sweep. The first sweep is in the forward direction (first channel to last channel), the second sweep is in the reverse direction (last channel to first channel), the third is forward, the fourth is reverse, etc. The counts obtained on each subsequent sweep are added to those stored in the selected memory group on the previous sweeps.

8. Observe and count the number of sweeps on the oscilloscope. When the last of the desired number of sweeps is completed, depress the ACQ again, set the CFS parameter (Status Page 1) to the desired viewing level using the CFS pushbutton and view resultant spectrum on the oscilloscope. If 1 input is selected, a single spectrum representing the data acquired from input 1 is observed. If 2 inputs are selected, separate spectra representing the data acquired from input 1 and 2 are observed in the first and second halves of the display, respectively. If 4 inputs are selected, separate spectra representing the data acquired from inputs 1, 2, 3 and 4 are observed in the first, second, third and fourth quadrants of the display, respectively.

TIME-BAS
- SWITCH

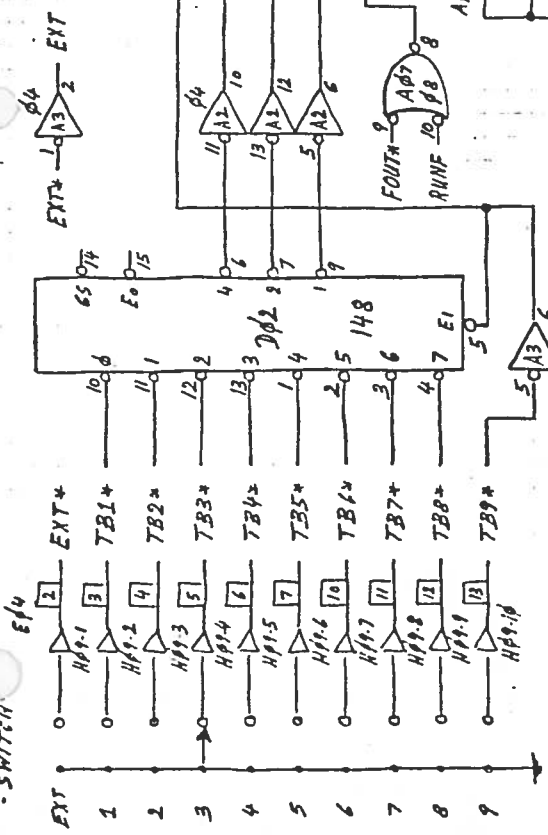

MULTIPLIER
- SWITCH

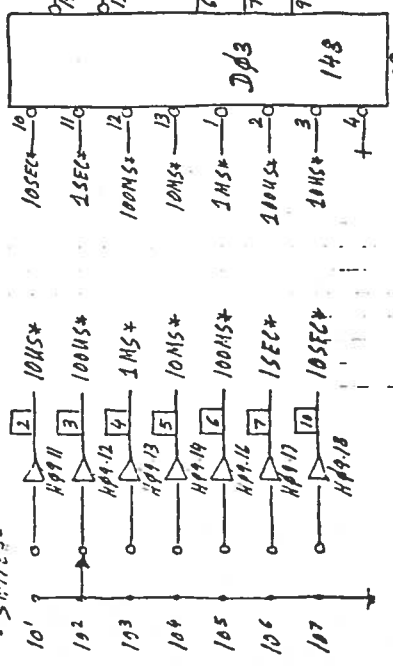

INPUT-SELECTOR
- SWITCH

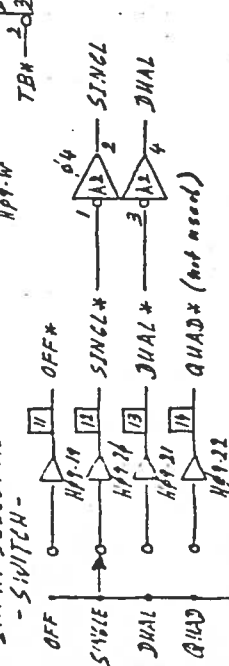

SWEEP-SELECTOR
- SWITCH

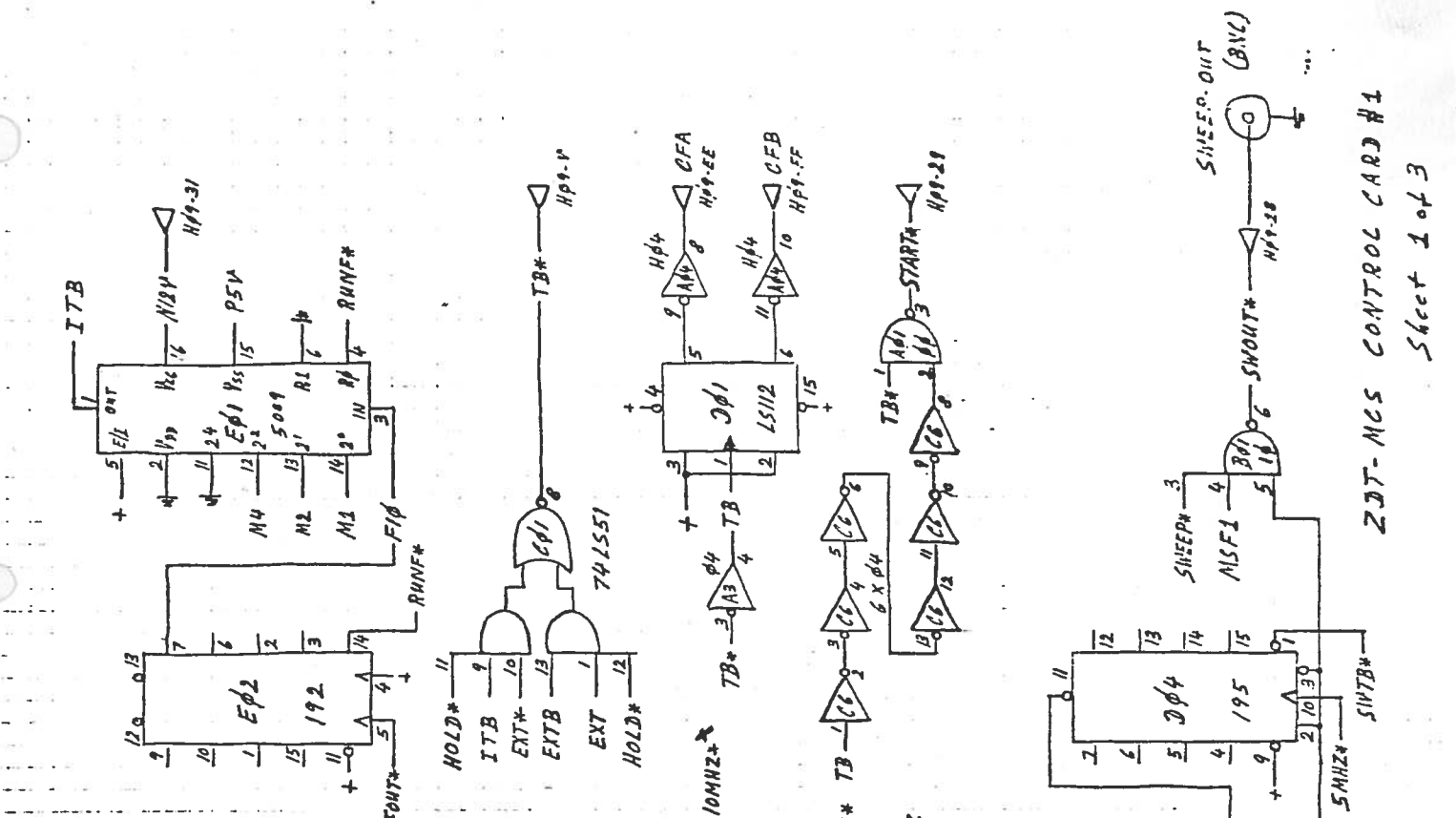
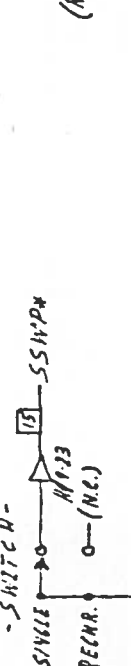

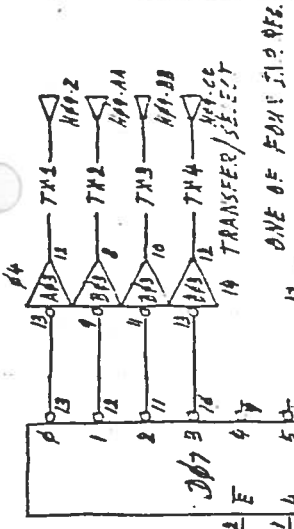

ONE OF FOUR J10 PPS.

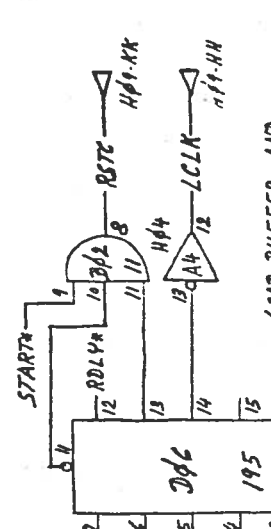
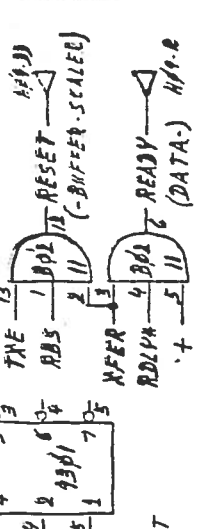

LOAD BUFFER AND
RESET SCALER WITHIN 1µsec

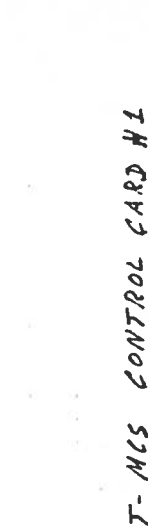
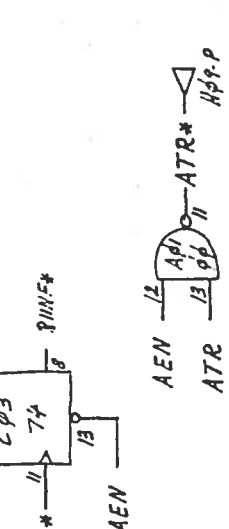
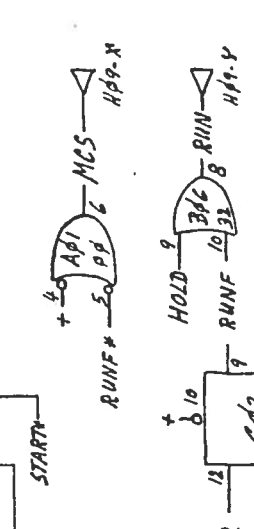

ZDT-MCS CONTROL CARD #1
Sheet 2 of 3

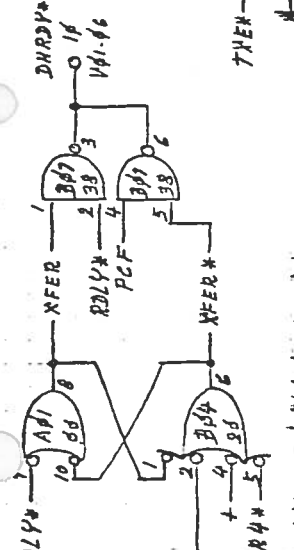

TRANSFER/READY TO 3.H.

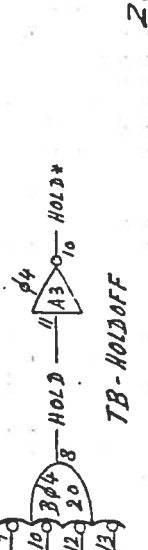
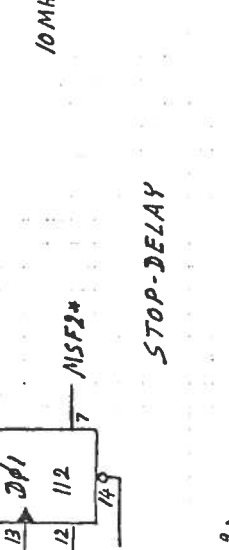
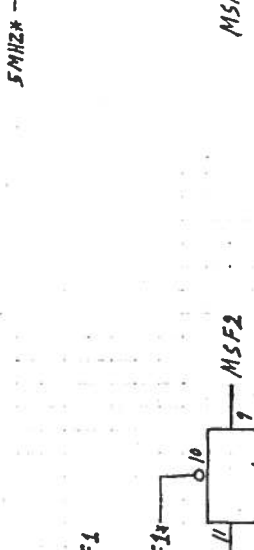
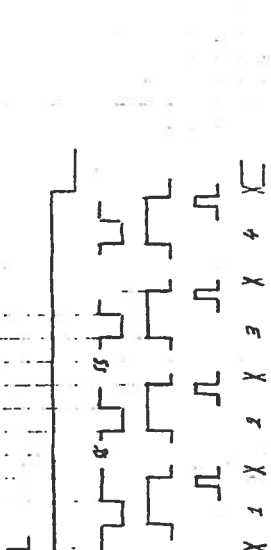
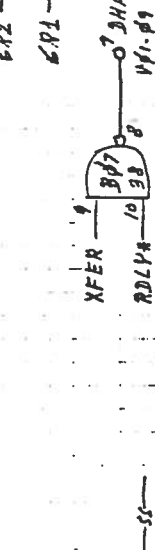

STOP-DELAY
TB-HOLDOFF

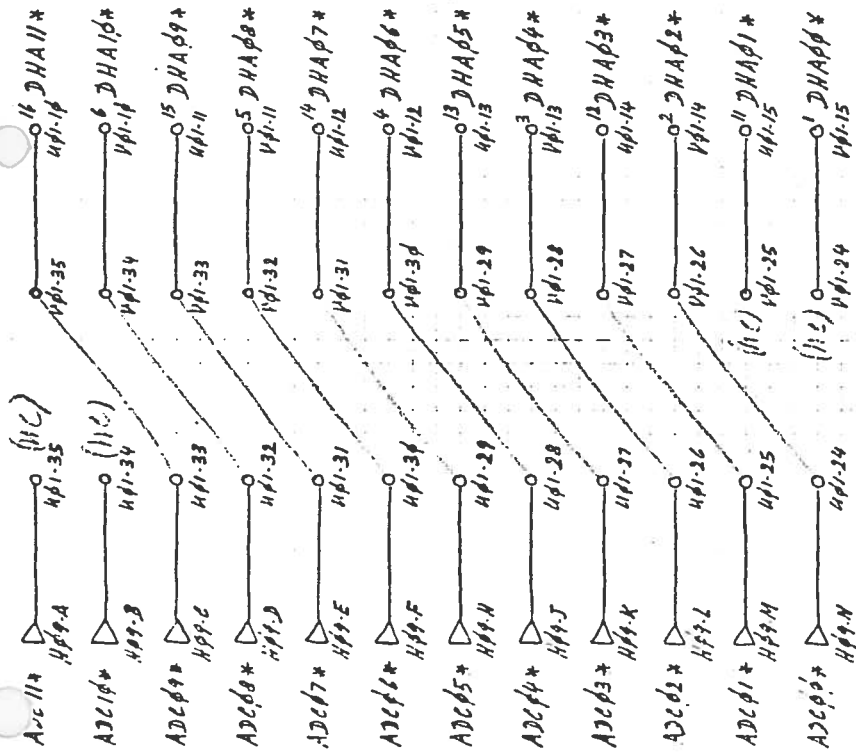

ADC-BIT-STRAPPING FOR MEMORY-SIZE 1K

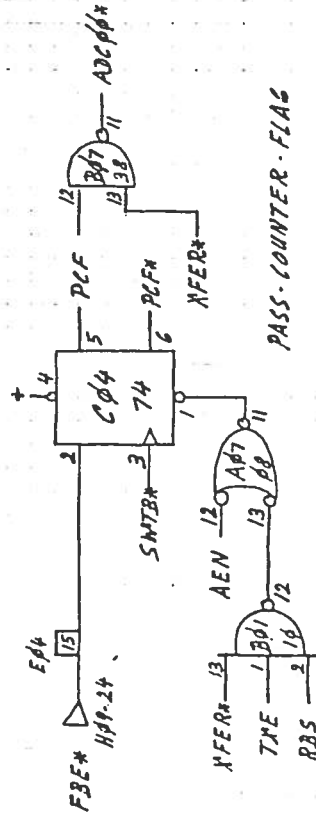
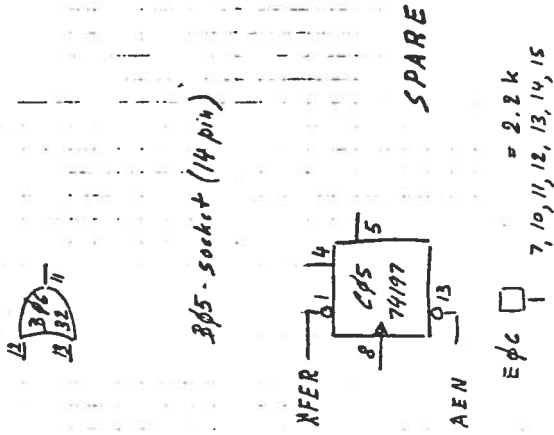

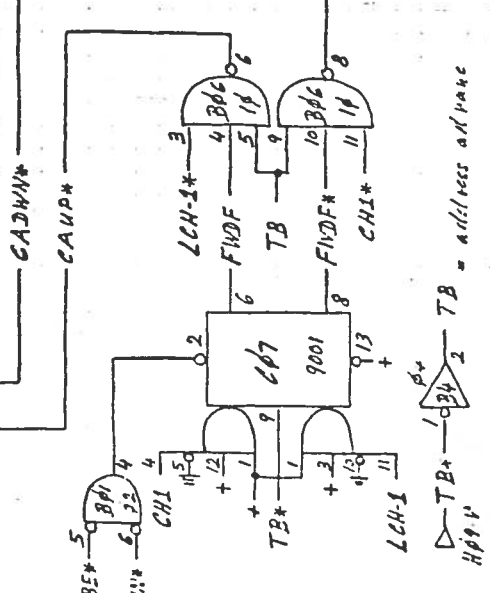
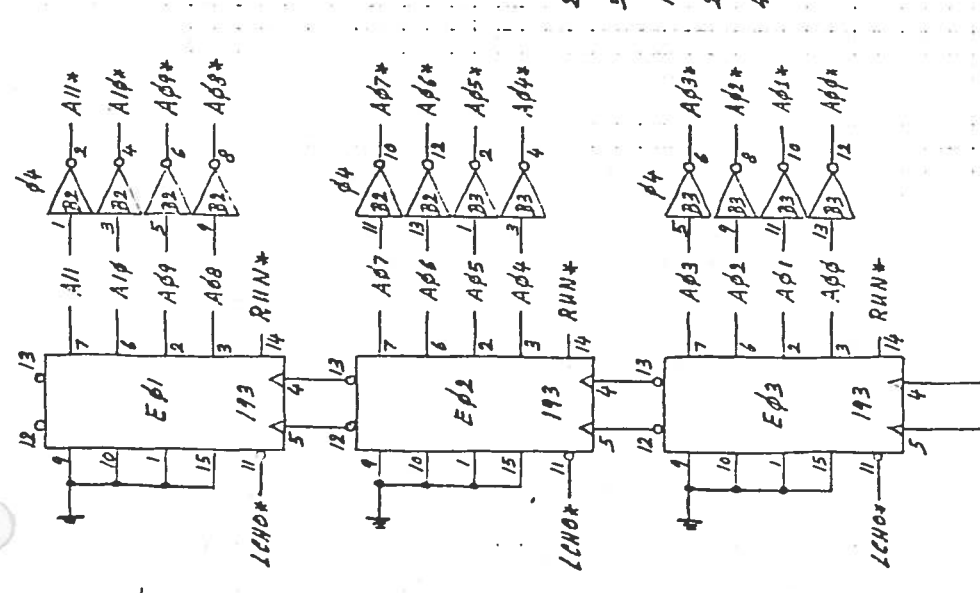
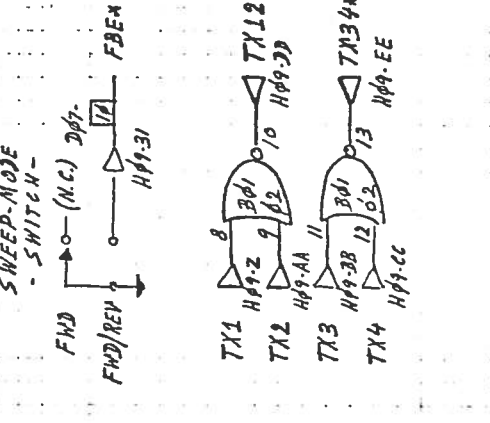
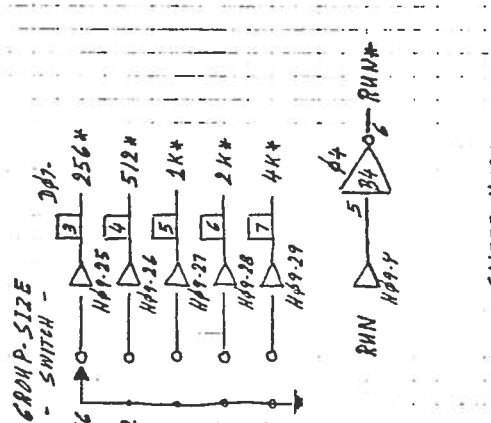
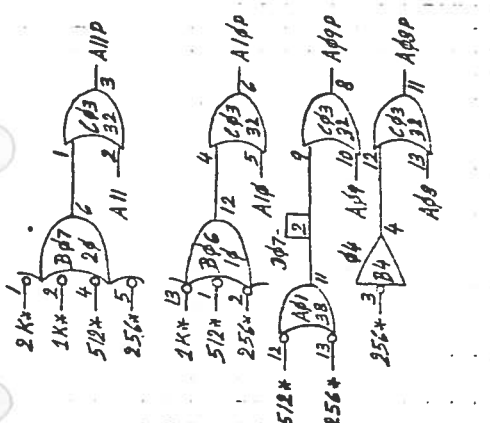
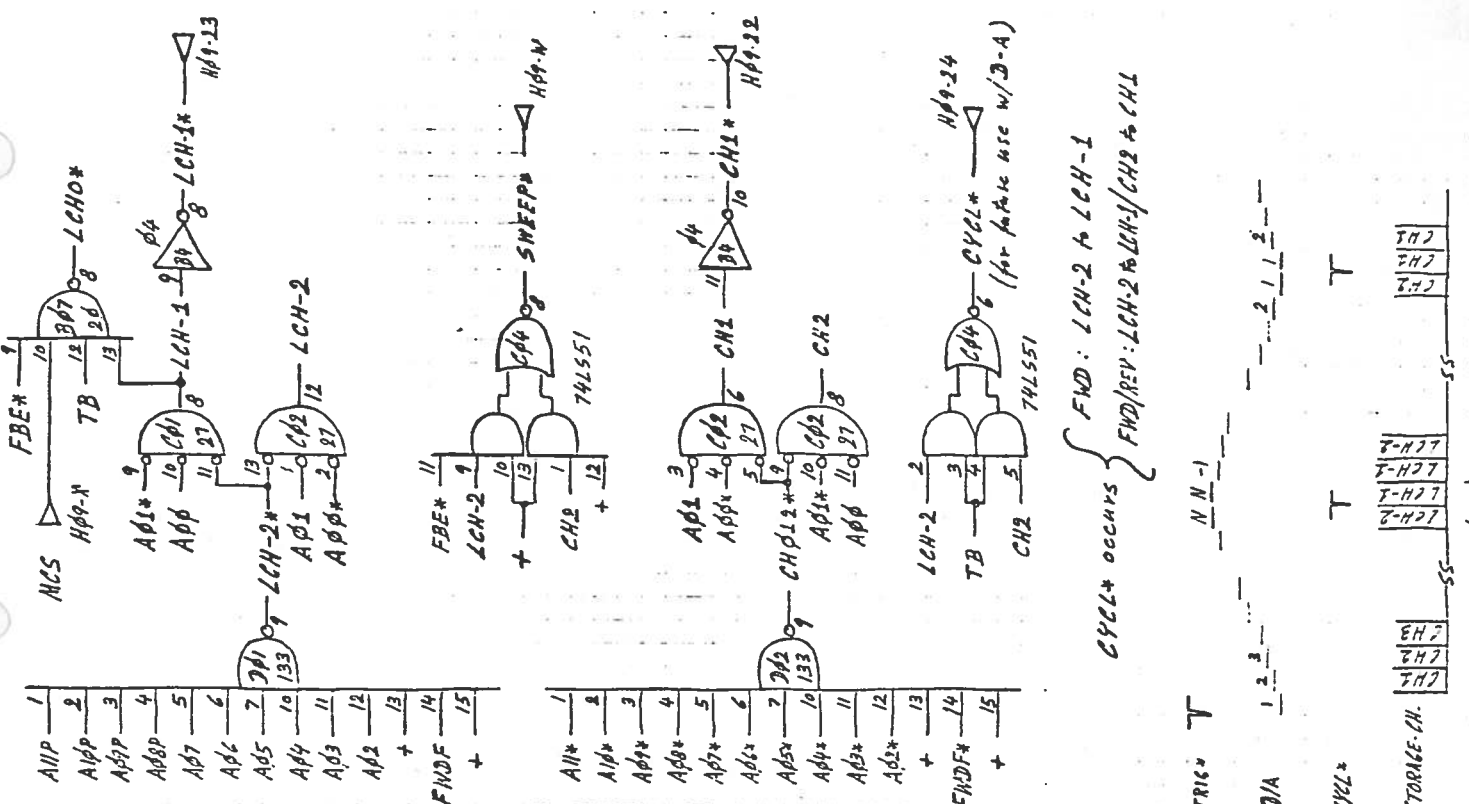

ZDT-MCS CONTROL CARD #2

forward only!

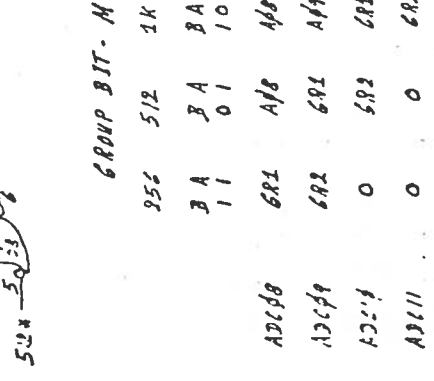
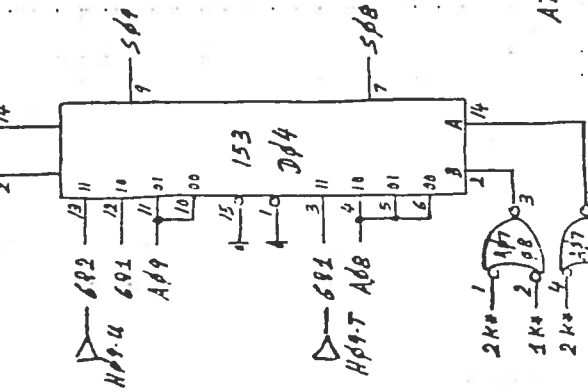
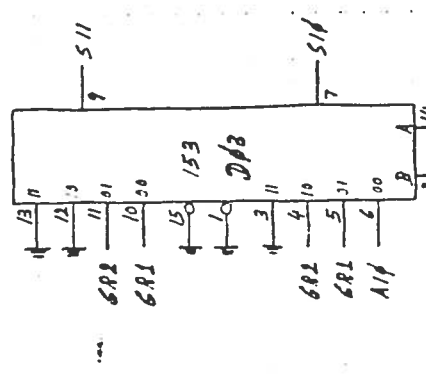
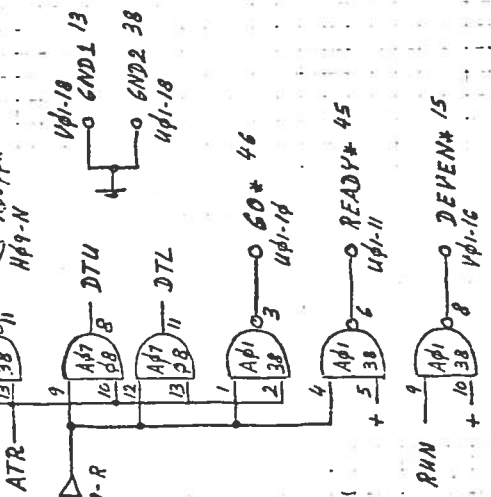
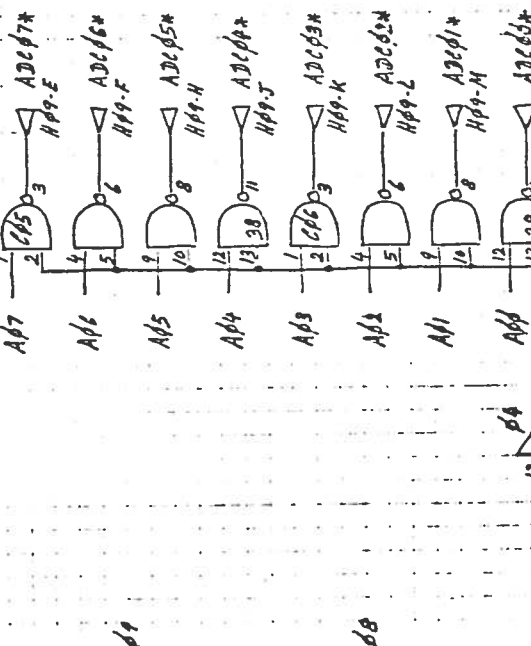
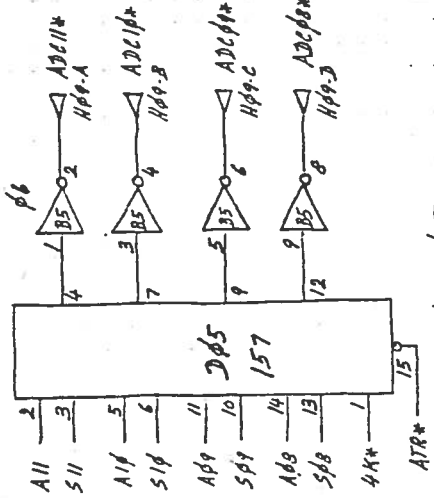
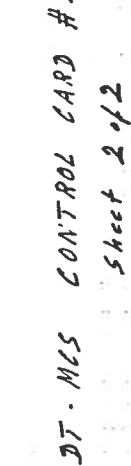
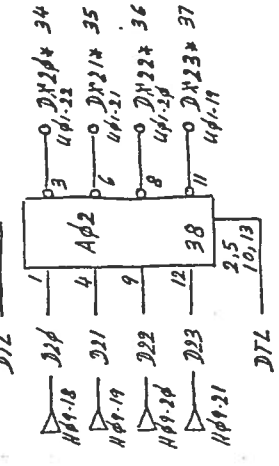
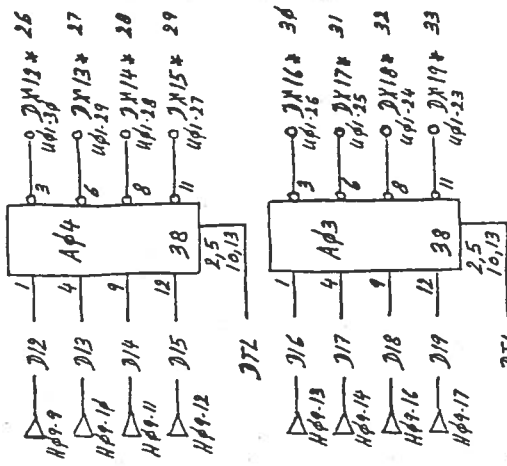
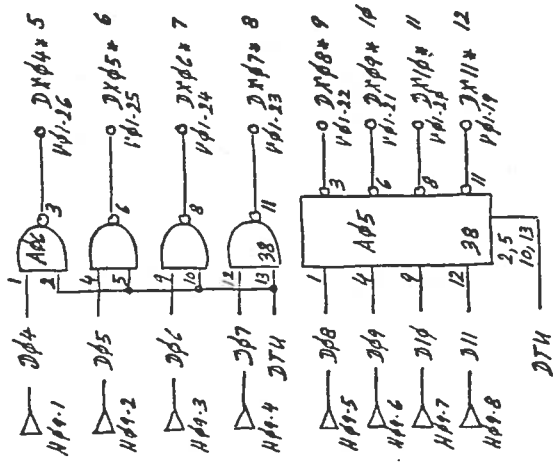
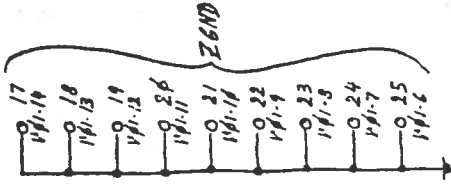
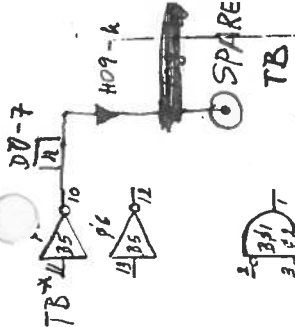

GROUP BIT - MUX

252	512	1K	2K	4K
BA	BA	BA	BA	BA
11	01	10	00	
Aφ28	Aφ8	Aφ8	Aφ8	Aφ8
Aφ29	Aφ9	Aφ9	Aφ9	Aφ9
Aφ30	Aφ10	Aφ10	Aφ10	Aφ10
Aφ31	Aφ11	Aφ11	Aφ11	Aφ11

ZDT - MGS CONTROL CARD #2
Sheet 2 of 2

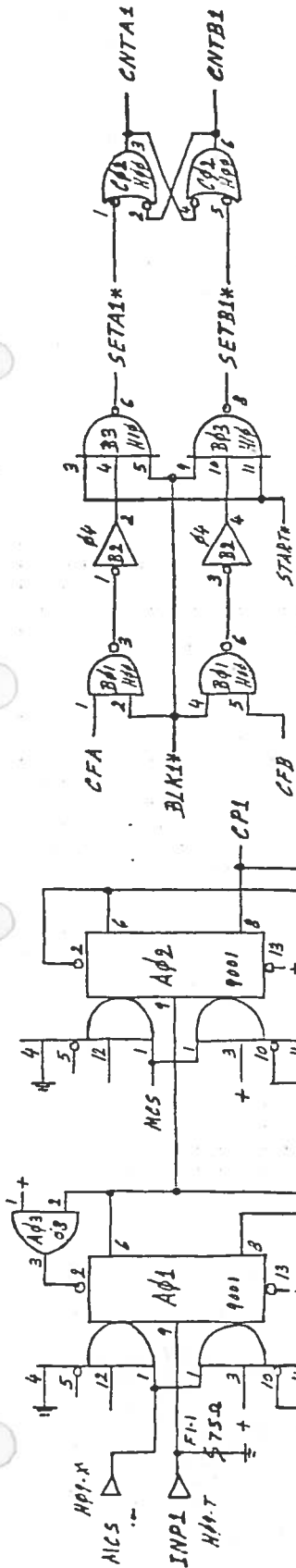

K 500A von Imp 4 (Sobald Aφ6 defekt (nicht mehr lieferbar!))

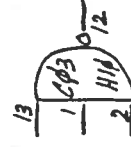
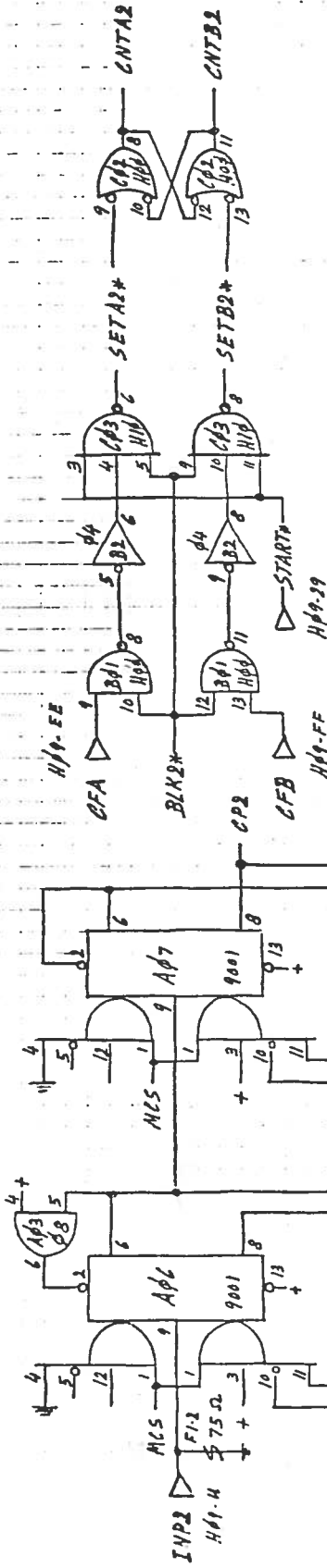

SPARE

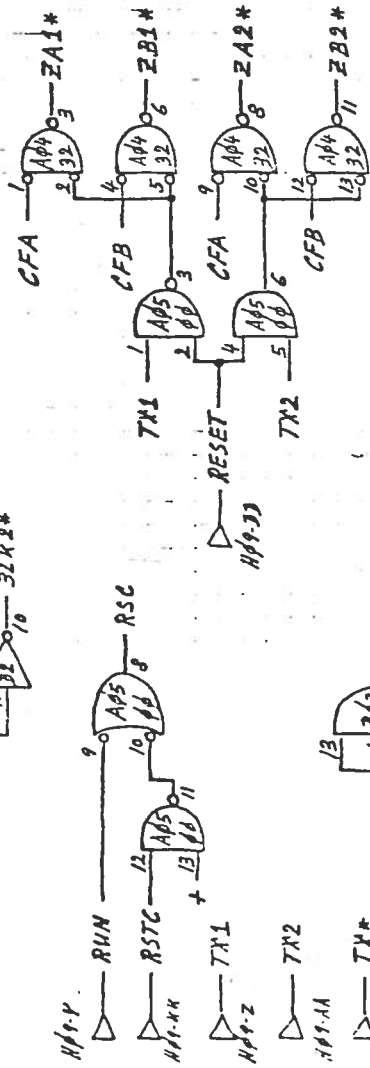

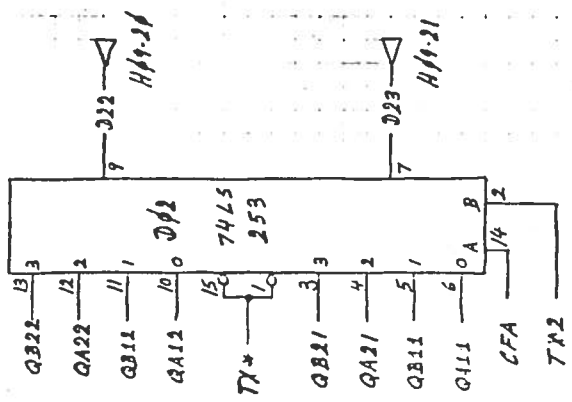
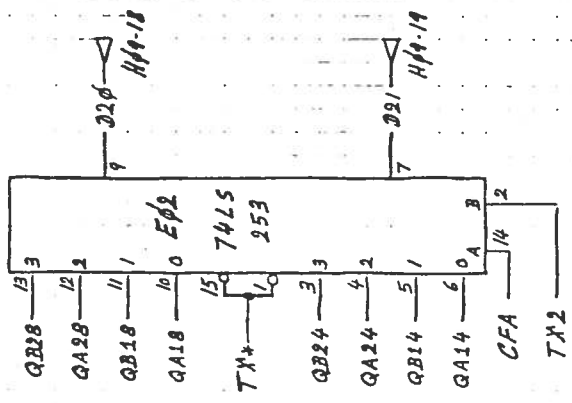
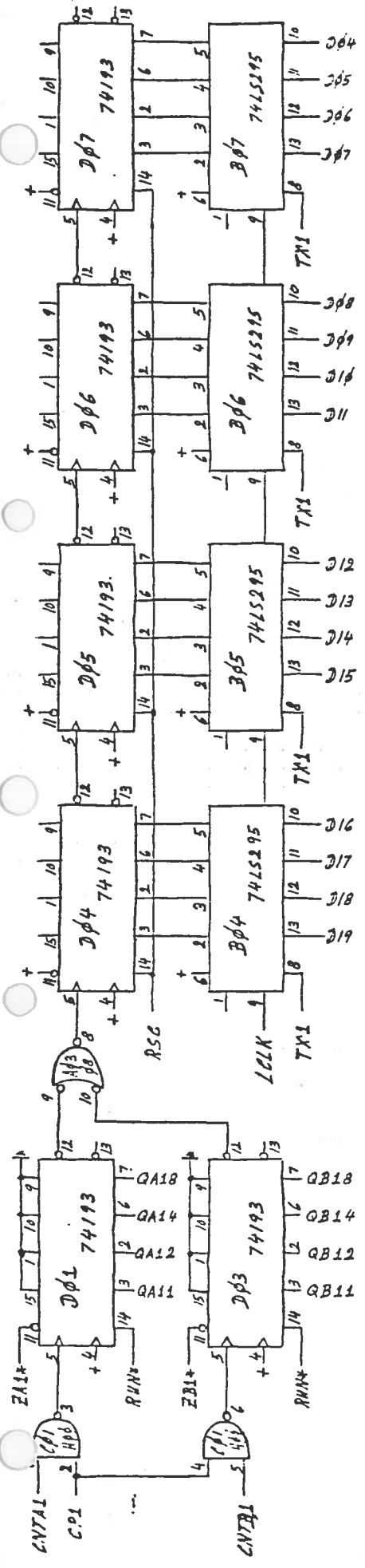

ZDT-MCS SCALER
Sheet 2 of 2

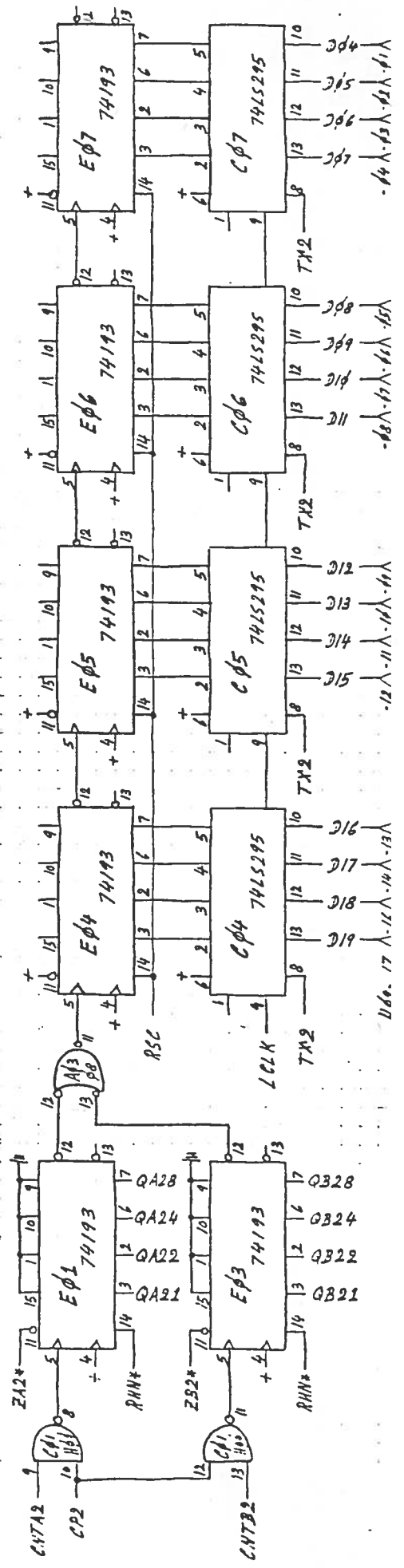

EXT*	1 A	ADCI1*	004	1 A	ADCI1*	004	1 A	004	1 A	004	
TB1*	2 B	ADCI2*	005	2 B	ADCI2*	005	2 B	005	2 B	005	
TB2*	3 C	ADCI3*	006	3 C	ADCI3*	006	3 C	006	3 C	006	
TB3*	4 D	ADCI4*	007	4 D	ADCI4*	007	4 D	007	4 D	007	
TB4*	5 E	ADCI5*	008	5 E	ADCI5*	008	5 E	008	5 E	008	
TB5*	6 F	ADCI6*	009	6 F	ADCI6*	009	6 F	009	6 F	009	
TB6*	7 H	ADCI7*	010	7 H	ADCI7*	010	7 H	010	7 H	010	
TB7*	8 J	ADCI8*	011	8 J	ADCI8*	011	8 J	011	8 J	011	
TB8*	9 K	ADCI9*	012	9 K	ADCI9*	012	9 K	012	9 K	012	
TB9*	10 L	ADCI10*	013	10 L	ADCI10*	013	10 L	013	10 L	013	
10H15*	11 M	ADCI11*	014	11 M	ADCI11*	014	11 M	014	11 M	014	
10H15*	12 N	ADCI12*	015	12 N	ADCI12*	015	12 N	015	12 N	015	
1M15*	13 P	ATR*	016	13 P	ATR*	016	13 P	016	13 P	016	
10M15*	14 R	READY	017	14 R	READY	017	14 R	017	14 R	017	
GND	15 S	GND	GND	15 S	GND	GND	15 S	GND	15 S	GND	
1004S*	16 T	GR1	018	16 T	GR1	018	16 T	018	16 T	018	
15EC*	17 U	GR2	019	17 U	GR2	019	17 U	019	17 U	019	
101EC*	18 V	TB*	020	18 V	TB*	020	18 V	020	18 V	020	
OFF*	19 W	SWEEP*	021	19 W	SWEEP*	021	19 W	021	19 W	021	
SAN1*	20 X	MCS	022	20 X	MCS	022	20 X	022	20 X	022	
JUAL*	21 Y	RHN	023	21 Y	RHN	023	21 Y	023	21 Y	023	
AKAD*	22 Z	TX1	CH1*	22 Z	TX1	CH1*	22 Z	TX1	22 Z	TX1	
SSWMP*	23 AA	TX2	LCH-2*	23 AA	TX2	LCH-2*	23 AA	TX2	23 AA	TX2	
FBE*	24 BB	TX3	CH2*	24 BB	TX3	CH2*	24 BB	TX3	24 BB	TX3	
(BNC) EXT B	25 CC	TX4	25C*	25 CC	TX4	25C*	25 CC	TX4	25 CC	TX4	
(BNC) TRIG*	26 DD	RESET	512*	26 DD	RESET	512*	26 DD	RESET	26 DD	RESET	
(BNC) STOP*	27 EE	CFA	1K*	27 EE	CFA	1K*	27 EE	CFA	27 EE	CFA	
(BNC) SNAIT*	28 FF	CFB	2K*	28 FF	CFB	2K*	28 FF	CFB	28 FF	CFB	
START*	29 HH	LLK	4K*	29 HH	LLK	4K*	29 HH	LLK	START*	29 HH	LLK
P5V	30 JJ	P5V	P5V	30 JJ	P5V	P5V	30 JJ	P5V	P5V	30 JJ	P5V
N12V	31 KK	R5TC	FBE*	31 KK	R5TC	FBE*	31 KK	R5TC	N12V	31 KK	R5TC

103
 CTRL #1 "ZCT"
 CTRL #2 "ZCC"
 105
 SCALER #1 "ZBB"
 SCALER #2 "ZBB" . 8 0273

107
 1 1 A
 2 B
 3 C
 4 D
 5 E
 6 F
 7 H
 8 J
 9 K
 10 L
 11 M
 12 N
 13 P
 14 R
 15 S
 GND
 16 T
 17 U
 18 V
 19 W
 20 X
 21 Y
 22 Z
 23 AA
 24 BB
 25 CC
 26 DD
 27 EE
 28 FF
 START* 29 HH
 P5V 30 JJ
 N12V 31 KK

107
 1 1 A
 2 B
 3 C
 4 D
 5 E
 6 F
 7 H
 8 J
 9 K
 10 L
 11 M
 12 N
 13 P
 14 R
 15 S
 GND
 16 T
 17 U
 18 V
 19 W
 20 X
 21 Y
 22 Z
 23 AA
 24 BB
 25 CC
 26 DD
 27 EE
 28 FF
 START* 29 HH
 P5V 30 JJ
 N12V 31 KK

107
 1 1 A
 2 B
 3 C
 4 D
 5 E
 6 F
 7 H
 8 J
 9 K
 10 L
 11 M
 12 N
 13 P
 14 R
 15 S
 GND
 16 T
 17 U
 18 V
 19 W
 20 X
 21 Y
 22 Z
 23 AA
 24 BB
 25 CC
 26 DD
 27 EE
 28 FF
 START* 29 HH
 P5V 30 JJ
 N12V 31 KK

109

W/A-OPTION, (EMPTY)

1 A

2 B

3 C

4 D

5 E

6 F

7 H

8 J

9 K

~~10 L~~

(3V6) SPARE

11 M

12 N

13 P

14 R READY

15 S GND

16 T

17 U

18 V TB*

19 W SWEEP*

20 X MGS

21 Y PHN

22 Z CH1*

23 AA LCH-1*

24 BB CYCL*

25 CC 256*

26 DD 512*

27 EE 1K*

28 FF 2K*

29 HH 4K*

30 JJ PSV

31 KK FBE*



NUCLEAR DATA, INC.

Home Office:

Nuclear Data, Inc.
Golf and Meacham Roads
Schaumburg, Illinois 60196
Tel: 312/884-3600

Southern Regional Office:

Nuclear Data, Inc.
3782 Citation Drive
Decatur, Georgia 30034
Tel: 404/284-1747

Western Regional Office:

Nuclear Data, Inc.
48 Brubaker Court
Walnut Creek, California 94596
Tel: 415/483-9200

European Offices:

Nuclear Data, GmbH
Bonameser Strasse 44
6000 Frankfurt/Main 50
Federal Republic of Germany
Tel: 529952

Nuclear Data, Inc. (U.K.)
Rose Industrial Estate
Cores End Road
Bourne End, Bucks., England
Tel: 22733, 25357

Nuclear Data Instruments AB
Eriksbergsvägen 9
S-752 39 Uppsala, Sweden
Tel: (018) 15-25-15