

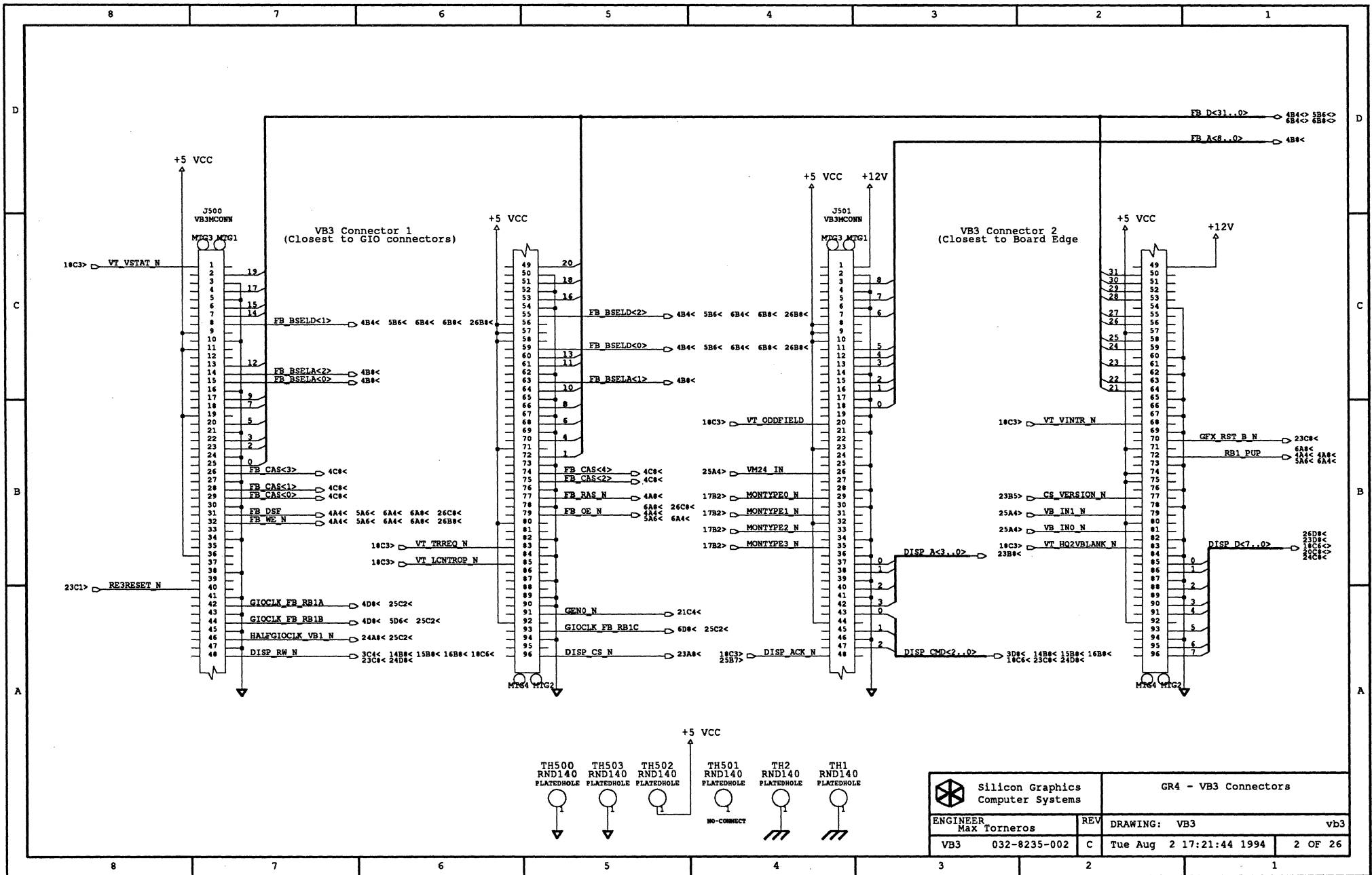

VB3 INDY XZ Graphics

Table of Contents	1
GR4 Connectors	2
Corona Connectors	3
RB1s	4
RB1s, Cont.	5
RB1s, Cont.	6
Frame Buffer Memory	7
Frame Buffer Memory, Cont.	8
XMAP LUT Channel A	9
XMAP LUT Channel B	10
XMAP LUT Channel C	11
XMAP LUT Channel D	12
XMAP LUT Channel E	13
RED DAC	14
GREEN DAC	15
BLUE DAC	16
Video Output	17
VC1 and VC1 SRAM	18
Asst. Clocks and Flops	19
Pixel Clock: ICS1562	20
Genlock	21
Pixel Clock: BT438	22
Display Bus Decode	23
Display Bus FIFO	24
Pullup/down & Termination	25
VRAM Bypass Caps	26

 Silicon Graphics Computer Systems - Digital Sight & Sound					
APPROVALS		DATE		<div style="text-align: center; font-size: 2em; font-weight: bold;">VB3</div>	
DRW	Max Torneros	09/23/93			
CHK	xxx	xxx			
		NP00		vb3	
RLS	xxx	xxx		DRAWING	REV
RLS	xxx	032-8235-002		C	DATE
				Tue Aug 2 17:21:18 1994	SHEET
				1	OF 26



 Silicon Graphics Computer Systems		GR4 - VB3 Connectors	
ENGINEER Max Tornos	REV	DRAWING: VB3	vb3
VB3 032-8235-002	C	Tue Aug 2 17:21:44 1994	2 OF 26

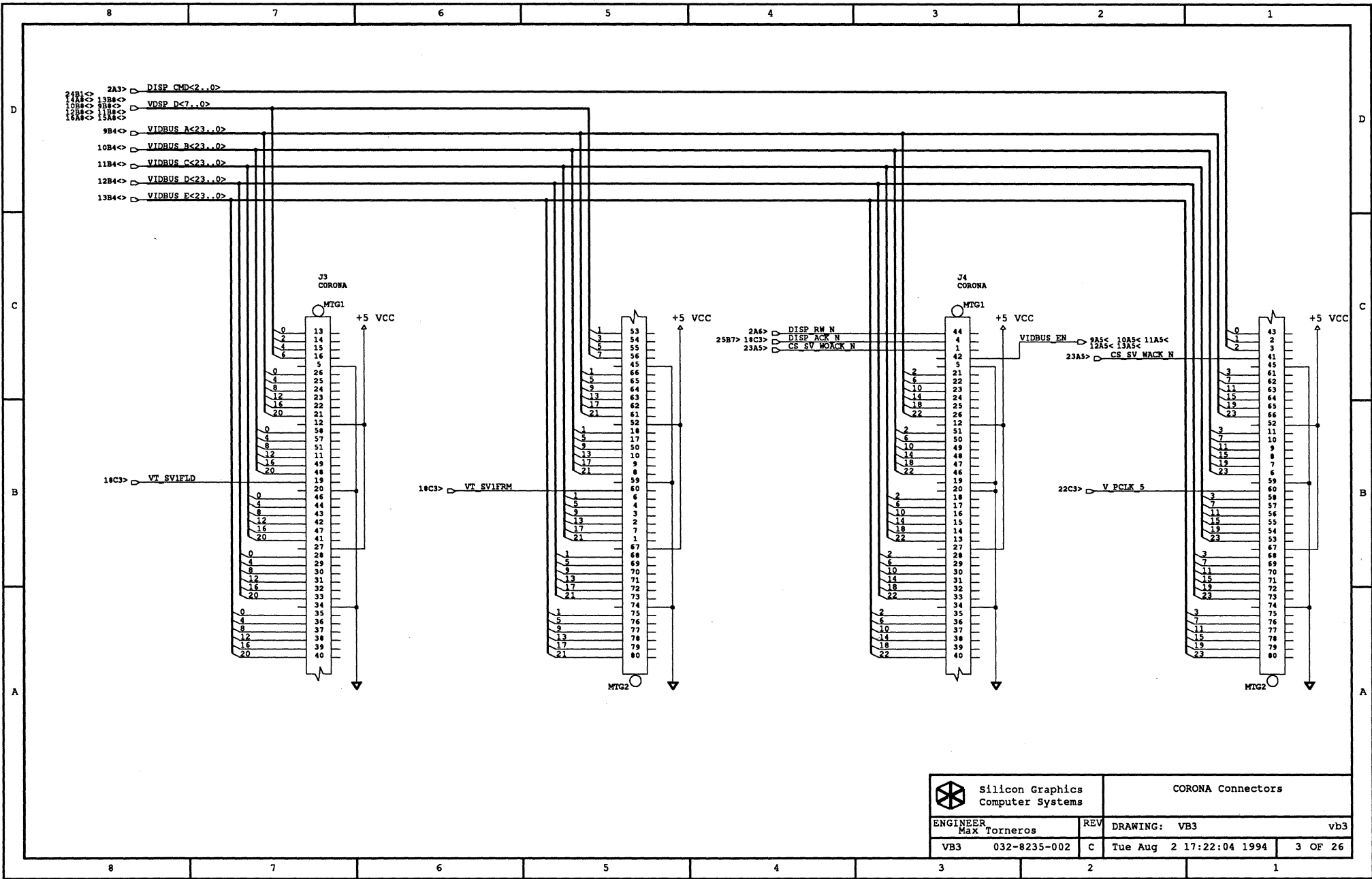

 Silicon Graphics Computer Systems		CORONA Connectors	
ENGINEER Max Torneros	REV	DRAWING: VB3	vb3
VB3 032-8235-002	C	Tue Aug 2 17:22:04 1994	3 OF 26

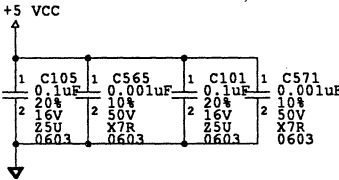
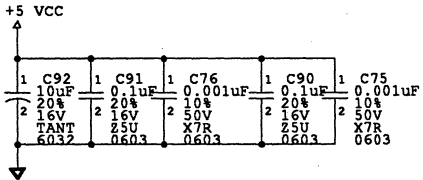
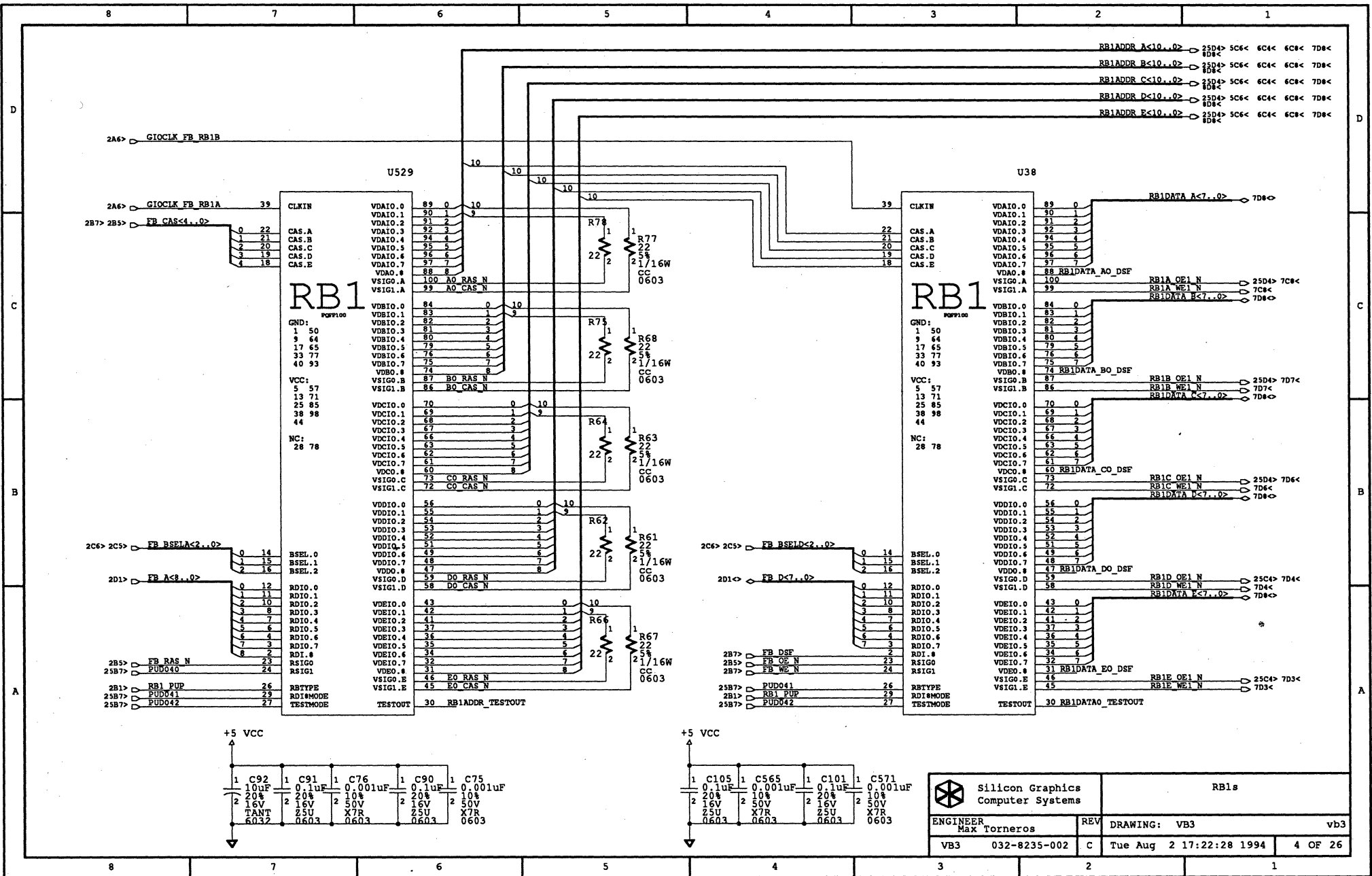

Silicon Graphics Computer Systems		RB1s	
ENGINEER Max Torneros	REV	DRAWING: VB3	vb3
VB3 032-8235-002	C	Tue Aug 2 17:22:28 1994	4 OF 26

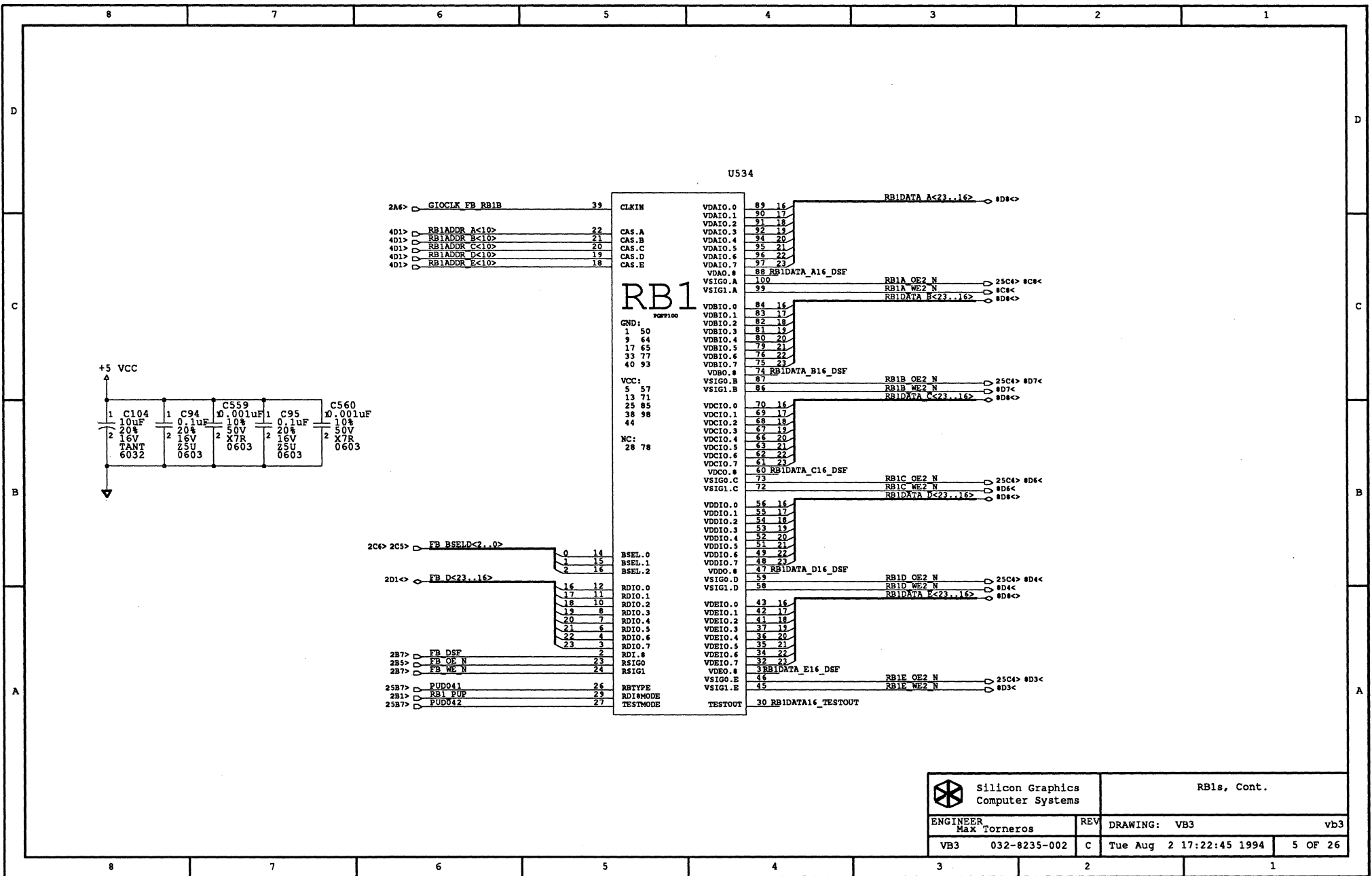

 Silicon Graphics Computer Systems		RB1s, Cont.		
		ENGINEER Max Torneros	REV	DRAWING: VB3
VB3	032-8235-002	C	Tue Aug 2 17:22:45 1994	5 OF 26

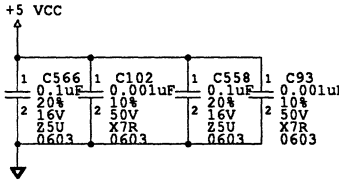
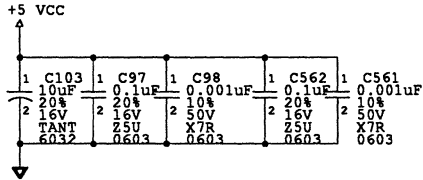
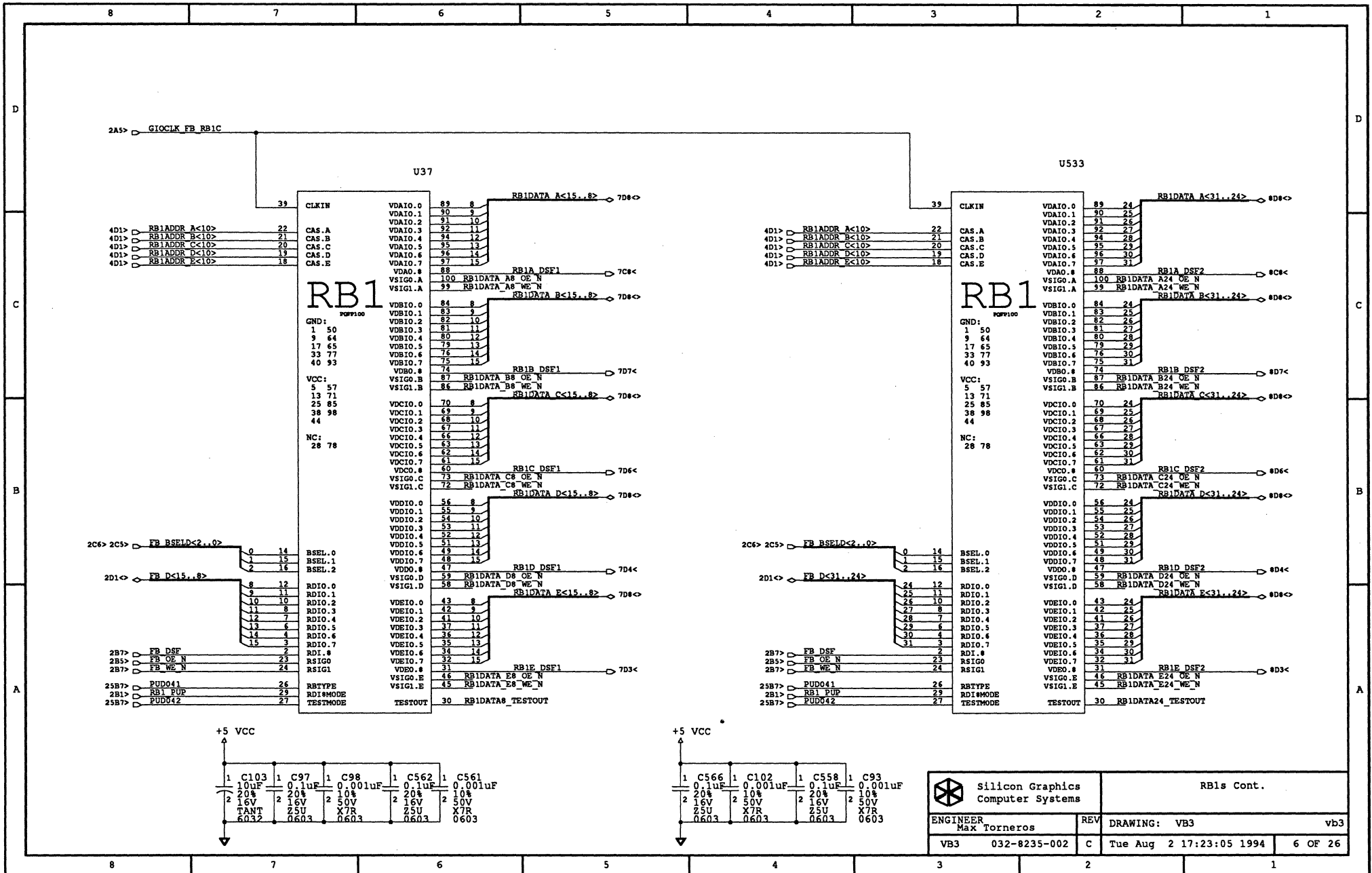

Silicon Graphics Computer Systems		RB1s Cont.		
				ENGINEER Max Torneros
VB3 032-8235-002		C	Tue Aug 2 17:23:05 1994	6 OF 26

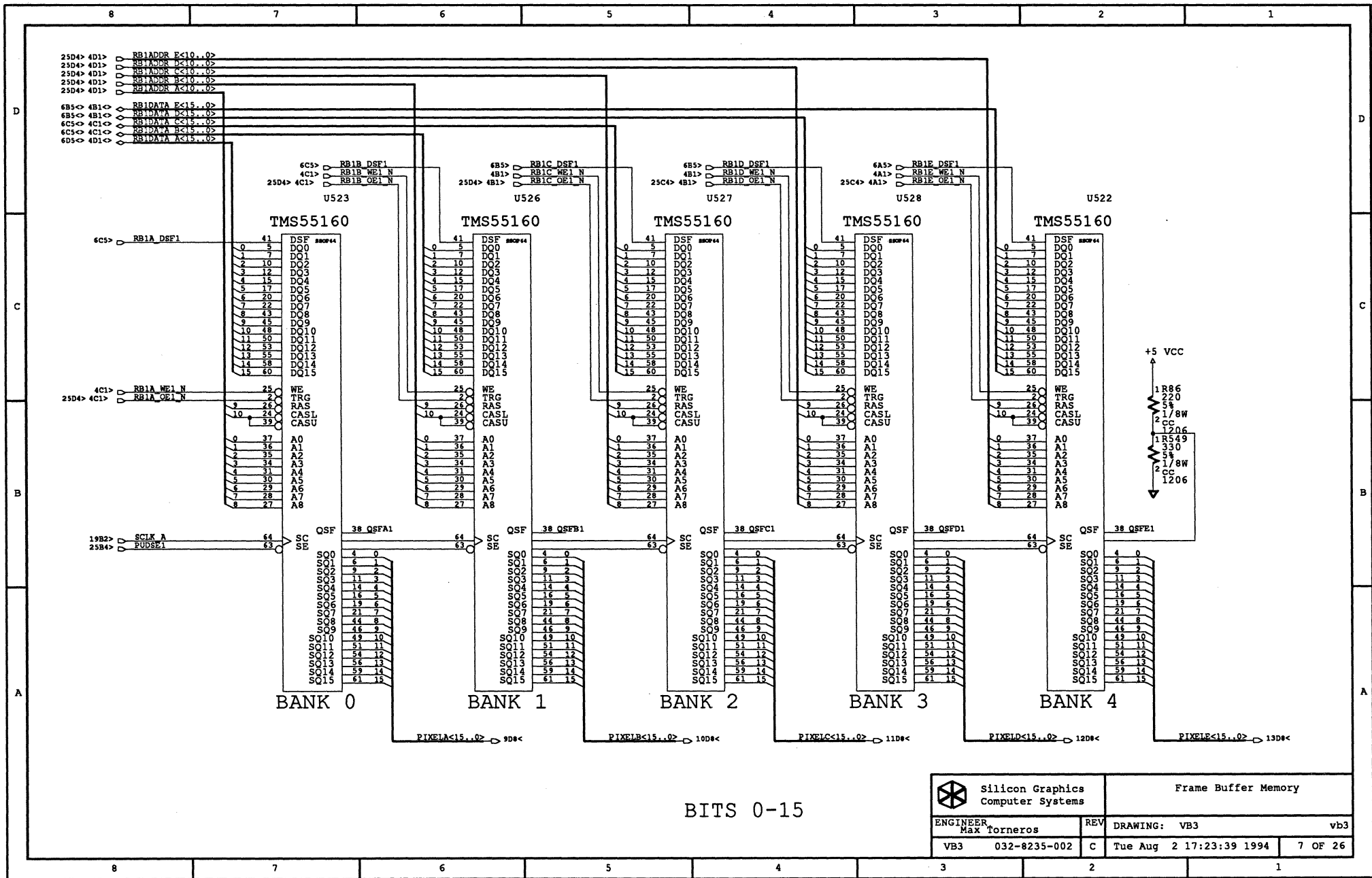

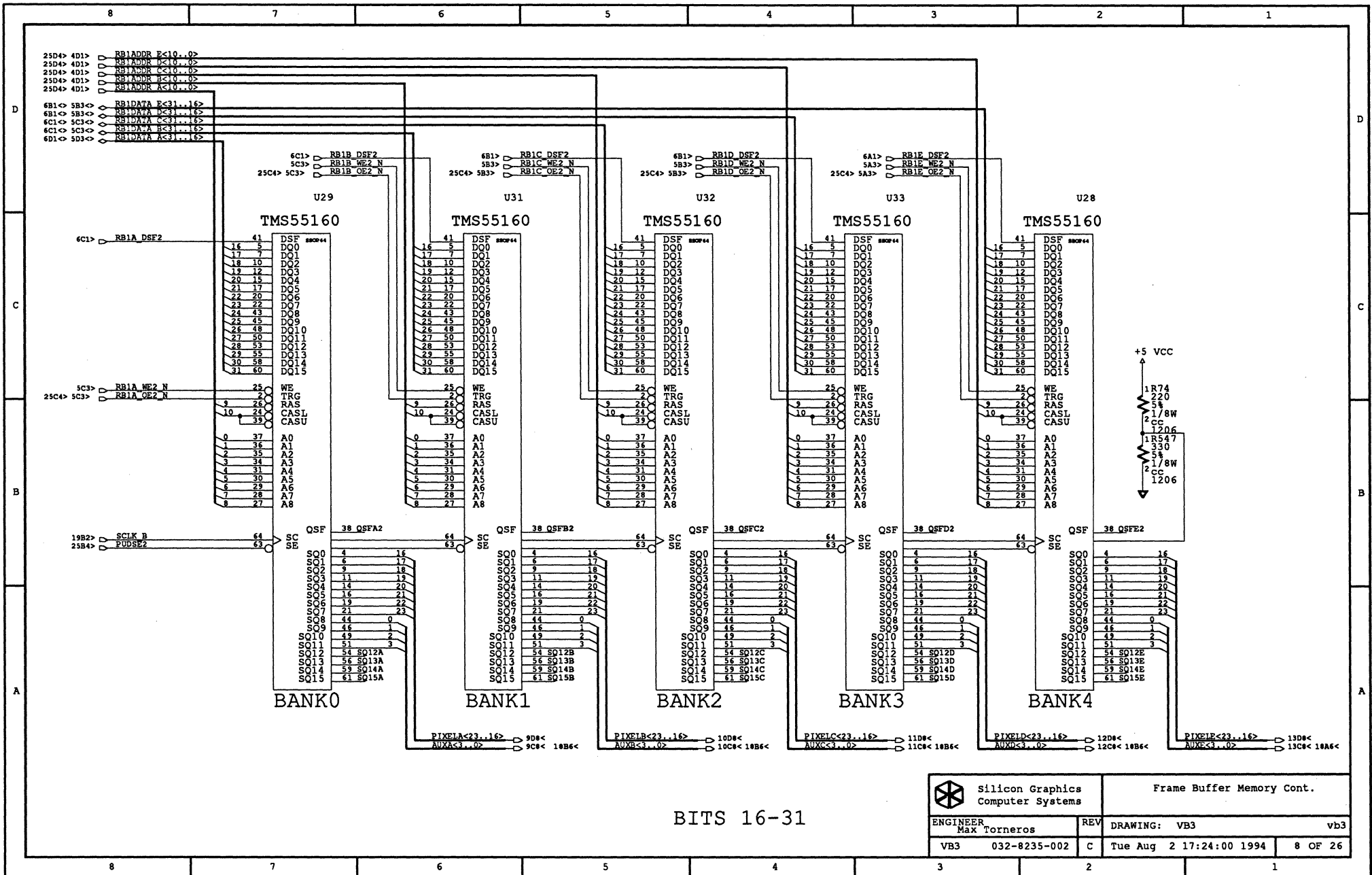

BITS 16-31

		Frame Buffer Memory Cont.	
		ENGINEER Max Torneros	REV DRAWING: VB3
VB3 032-8235-002		C	Tue Aug 2 17:24:00 1994
			8 OF 26

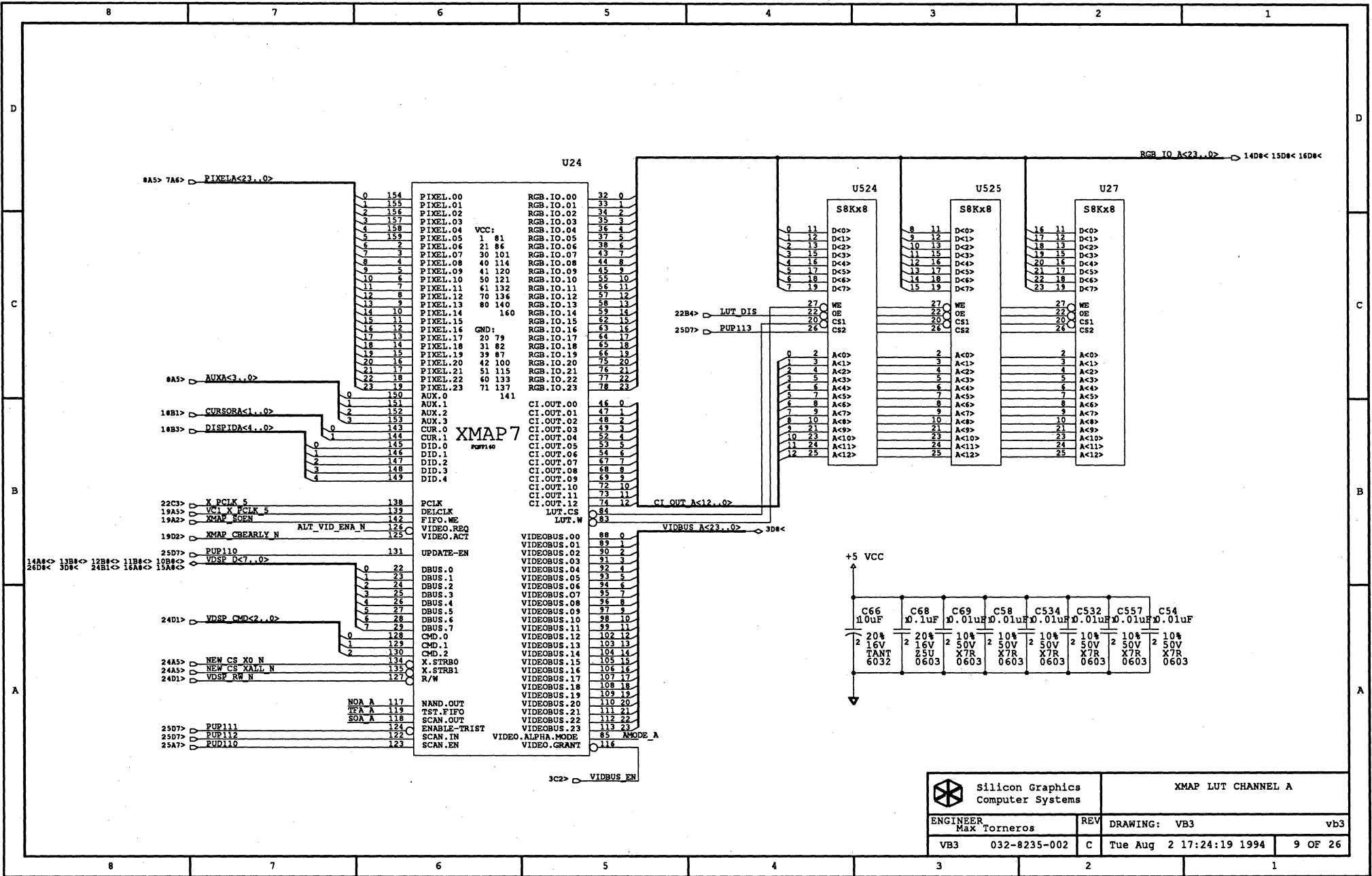

		XMAP LUT CHANNEL A	
		ENGINEER Max Torneros	REV DRAWING: VB3
VB3	032-8235-002	C	Tue Aug 2 17:24:19 1994
			9 OF 26

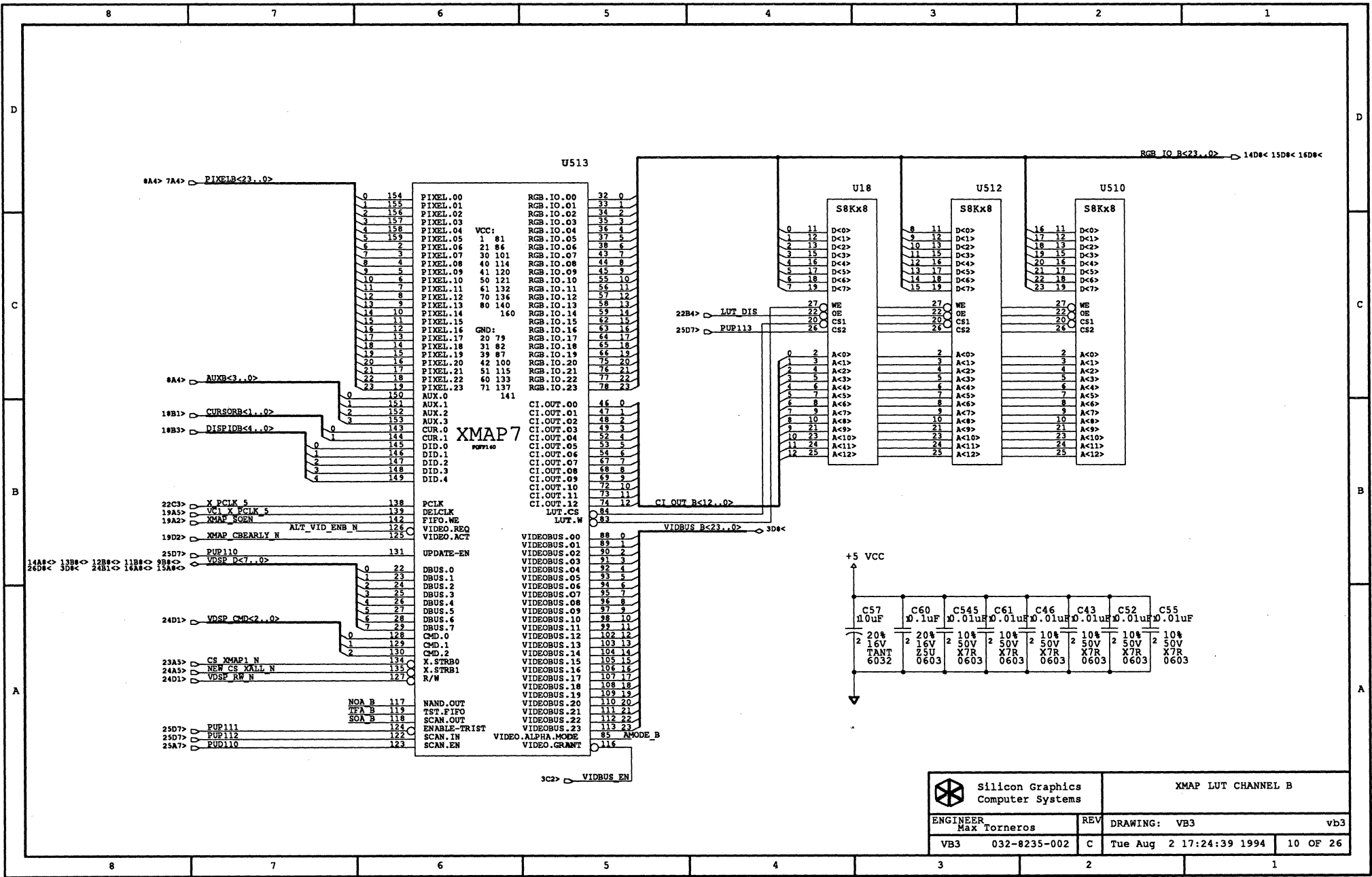

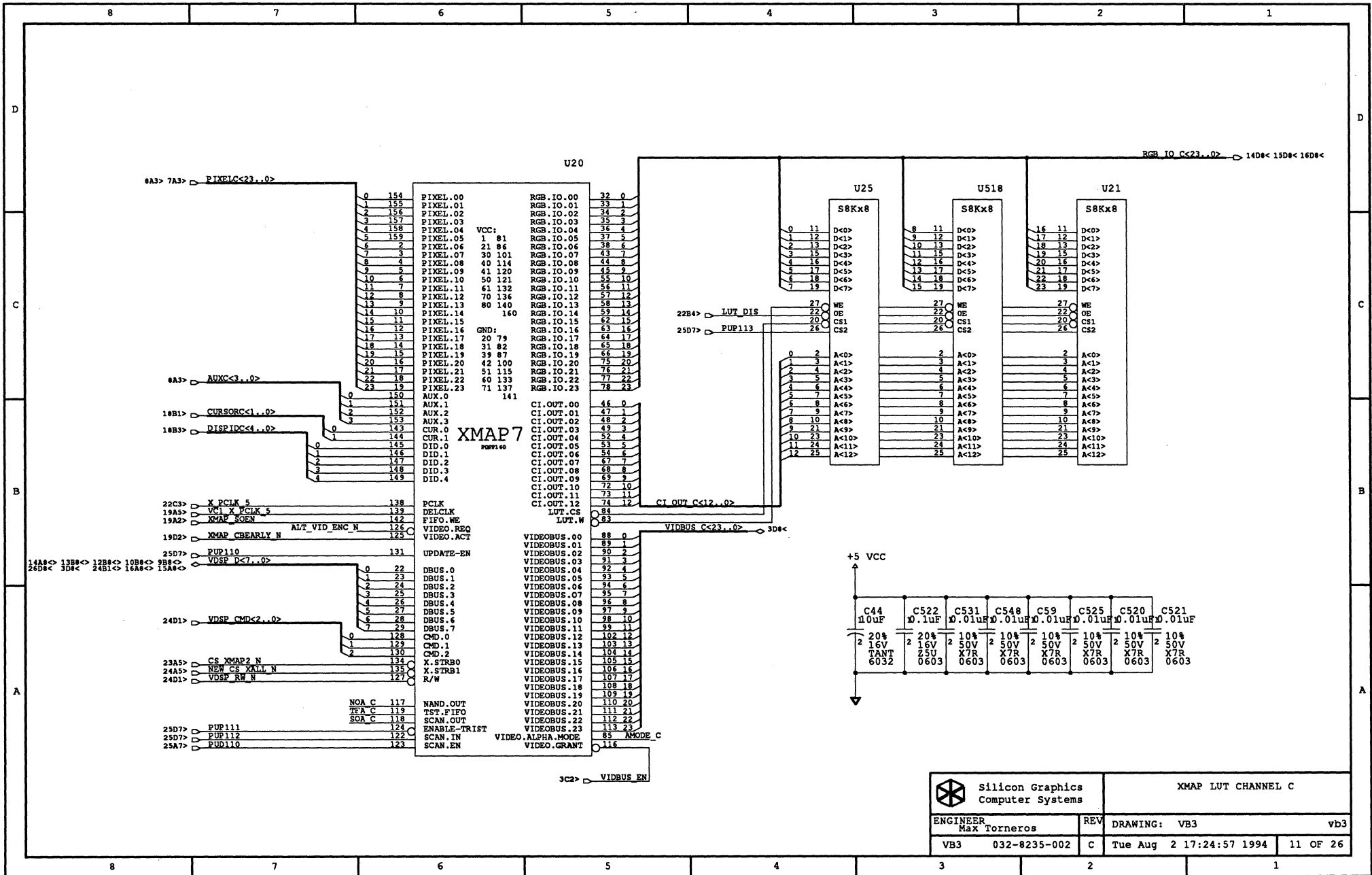

		XMAP LUT CHANNEL C	
ENGINEER Max Torneros	REV	DRAWING: VB3	vb3
VB3	032-8235-002	C	Tue Aug 2 17:24:57 1994 11 OF 26

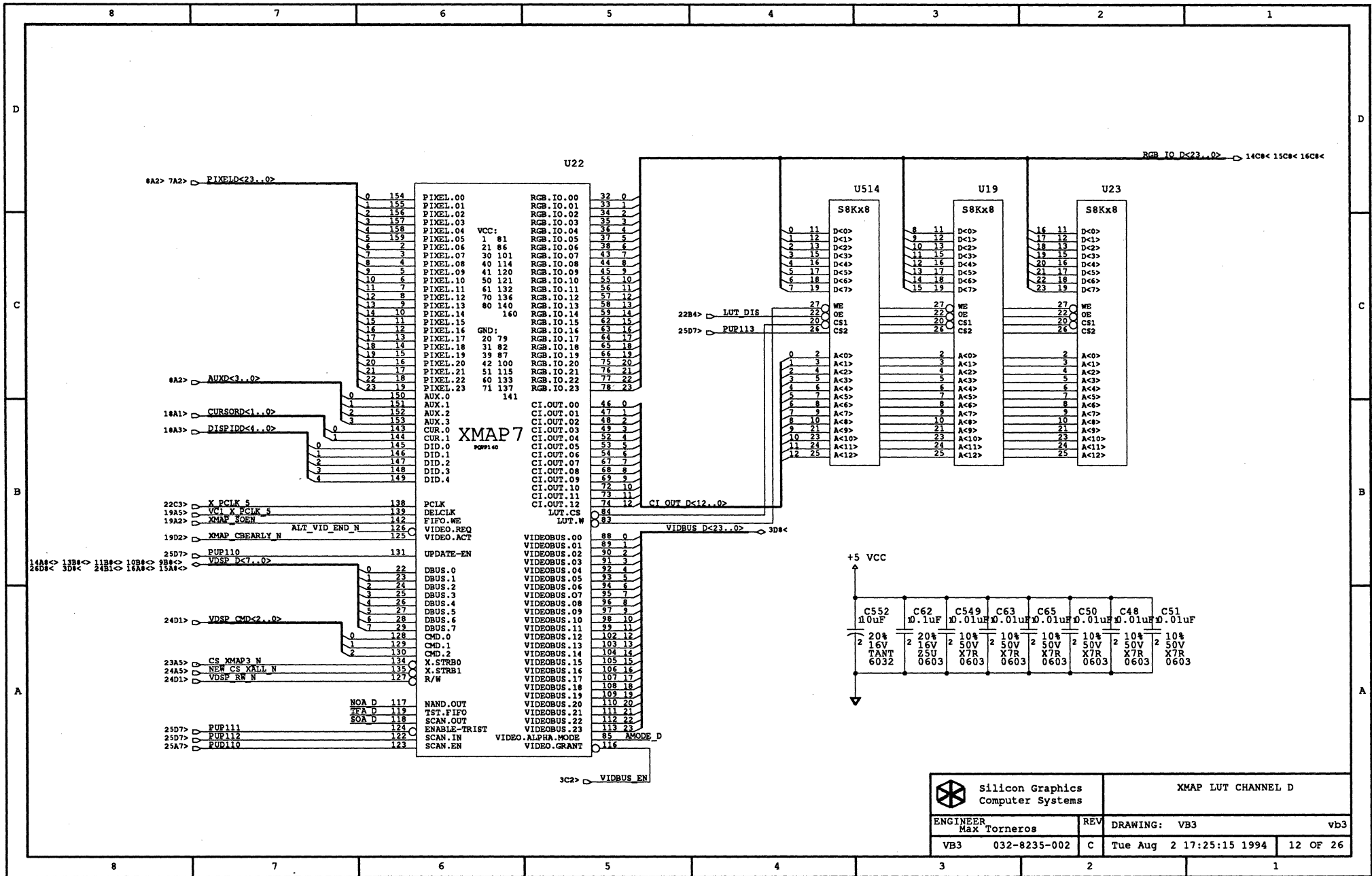

silicon Graphics Computer Systems		XMAP LUT CHANNEL D	
ENGINEER Max Torneros	REV	DRAWING: VB3	vb3
VB3	032-8235-002	C	Tue Aug 2 17:25:15 1994 12 OF 26

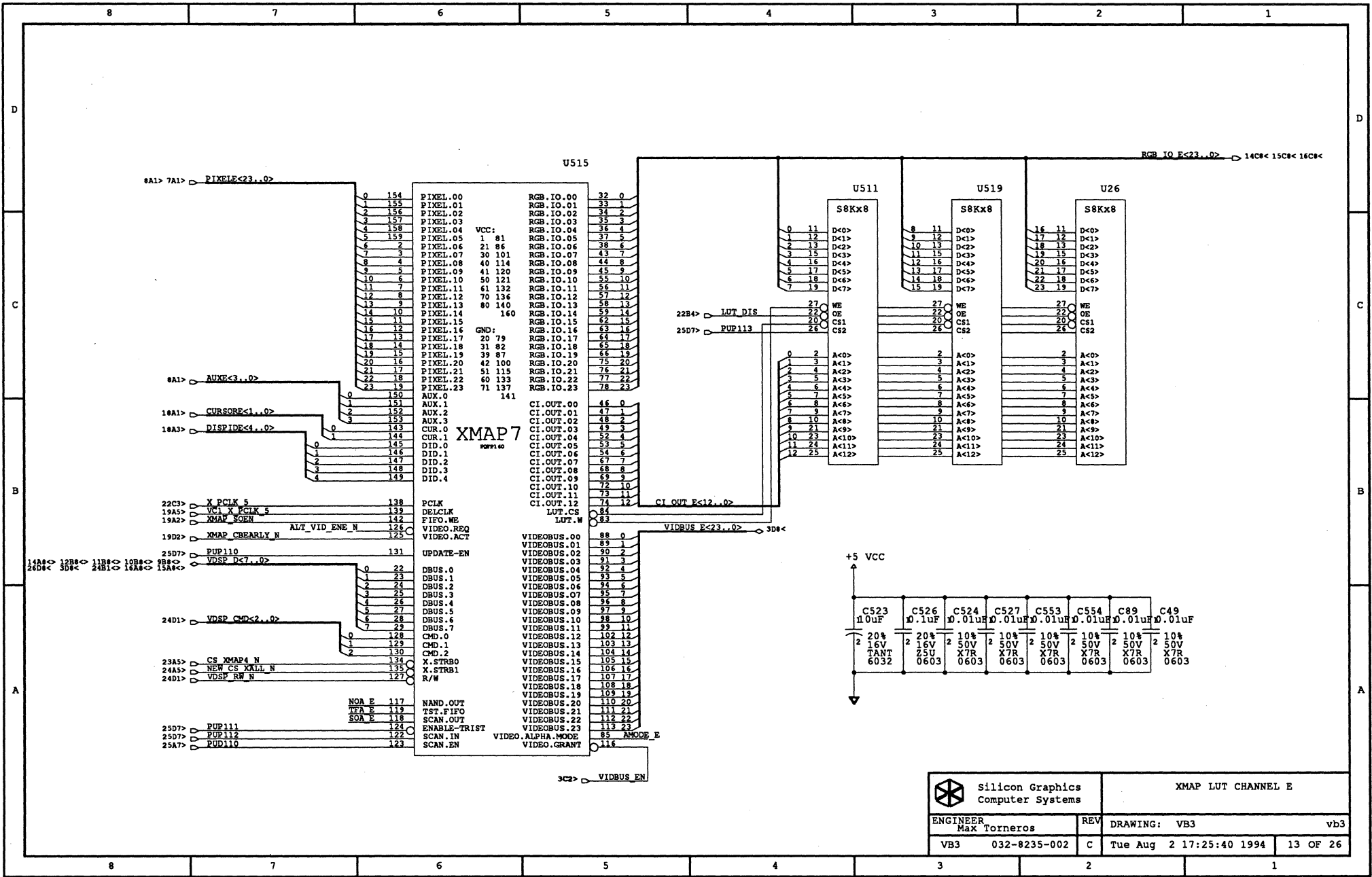

Silicon Graphics Computer Systems		XMAP LUT CHANNEL E	
ENGINEER Max Torneros	REV	DRAWING: VB3	vb3
VB3 032-8235-002	C	Tue Aug 2 17:25:40 1994	13 OF 26

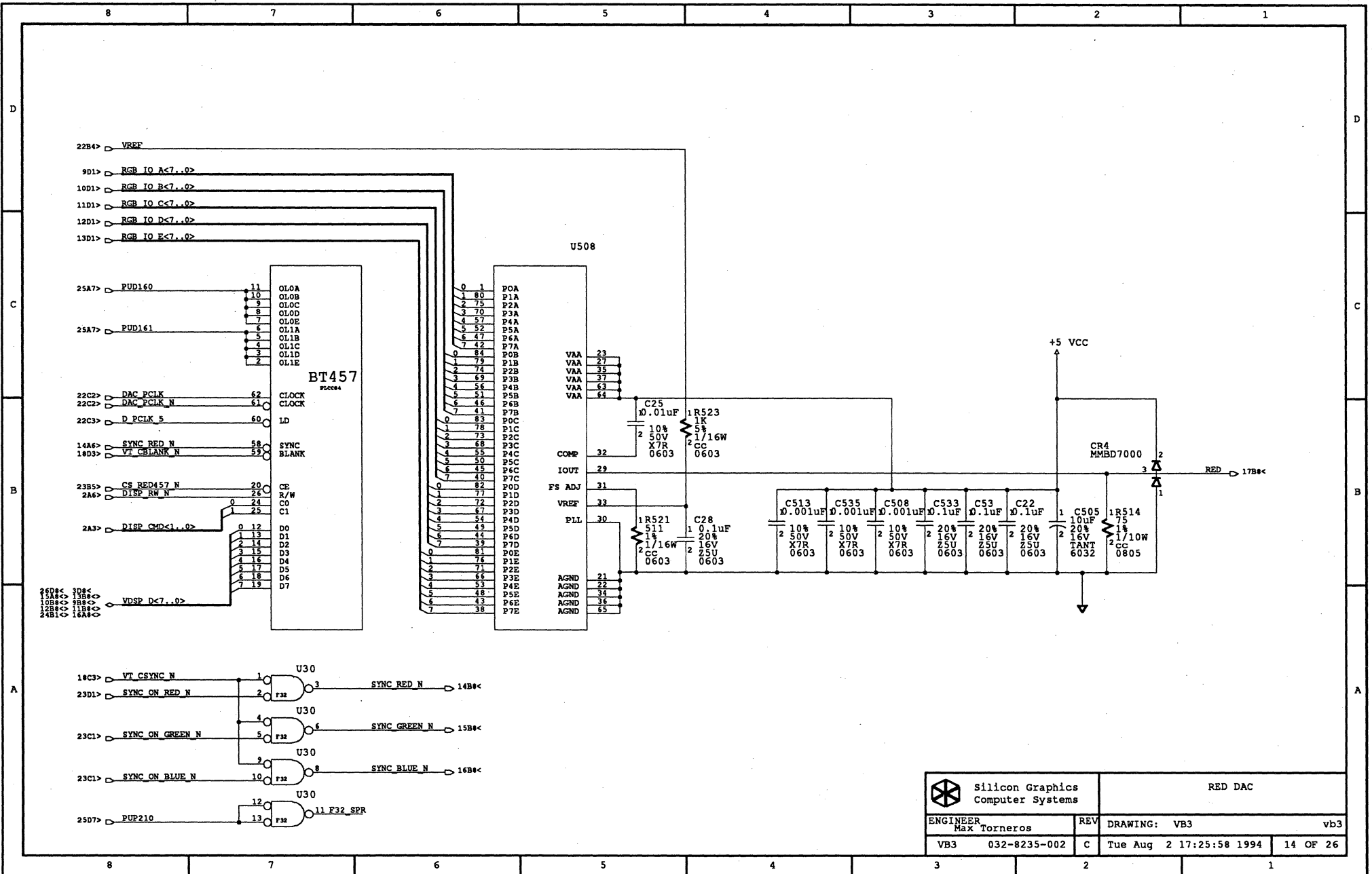

		RED DAC	
		ENGINEER Max Torneros	REV DRAWING: VB3
VB3	032-8235-002	C	Tue Aug 2 17:25:58 1994
			14 OF 26

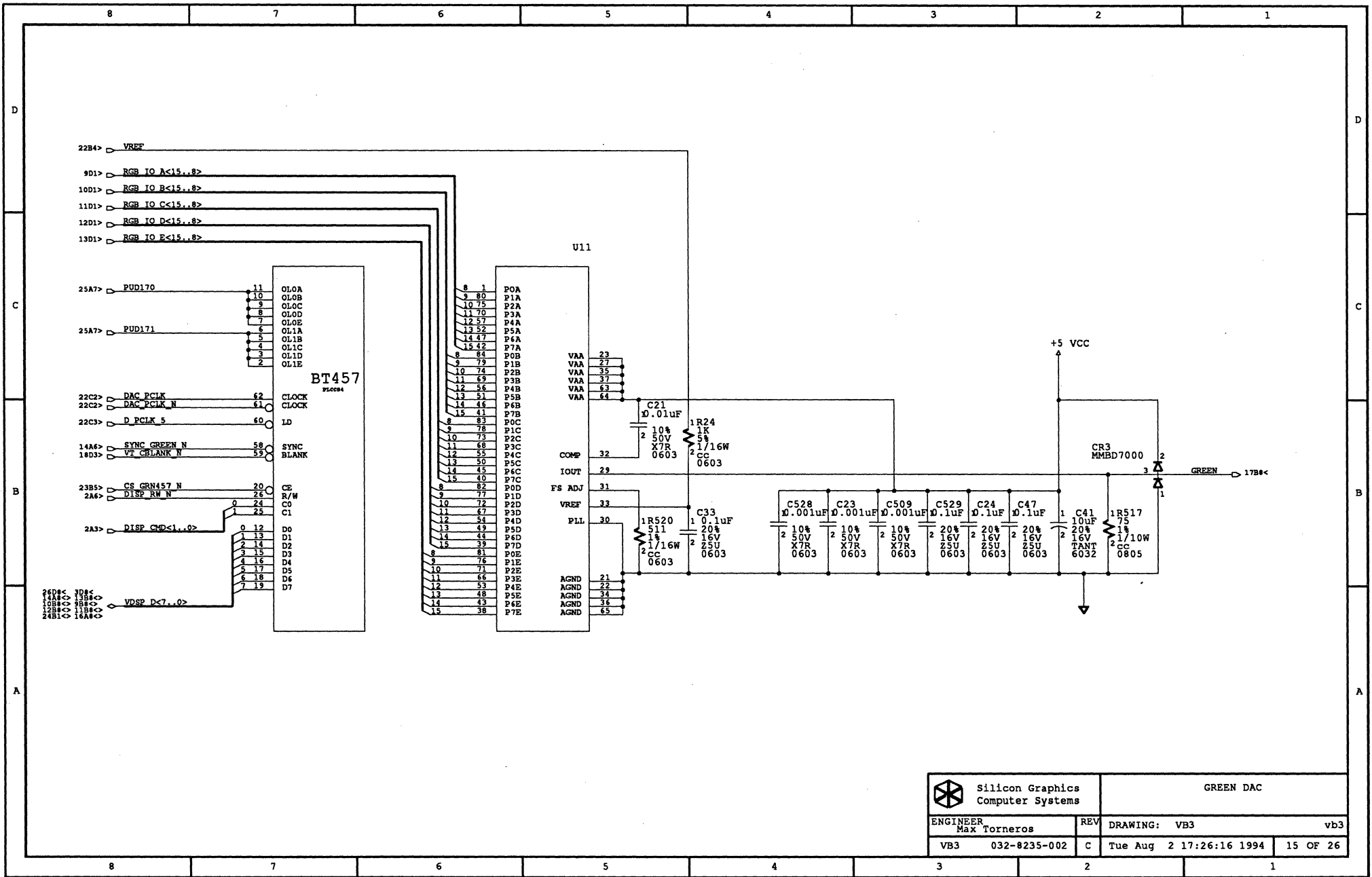

 Silicon Graphics Computer Systems		GREEN DAC	
ENGINEER Max Torneros	REV	DRAWING: VB3	vb3
VB3 032-8235-002	C	Tue Aug 2 17:26:16 1994	15 OF 26

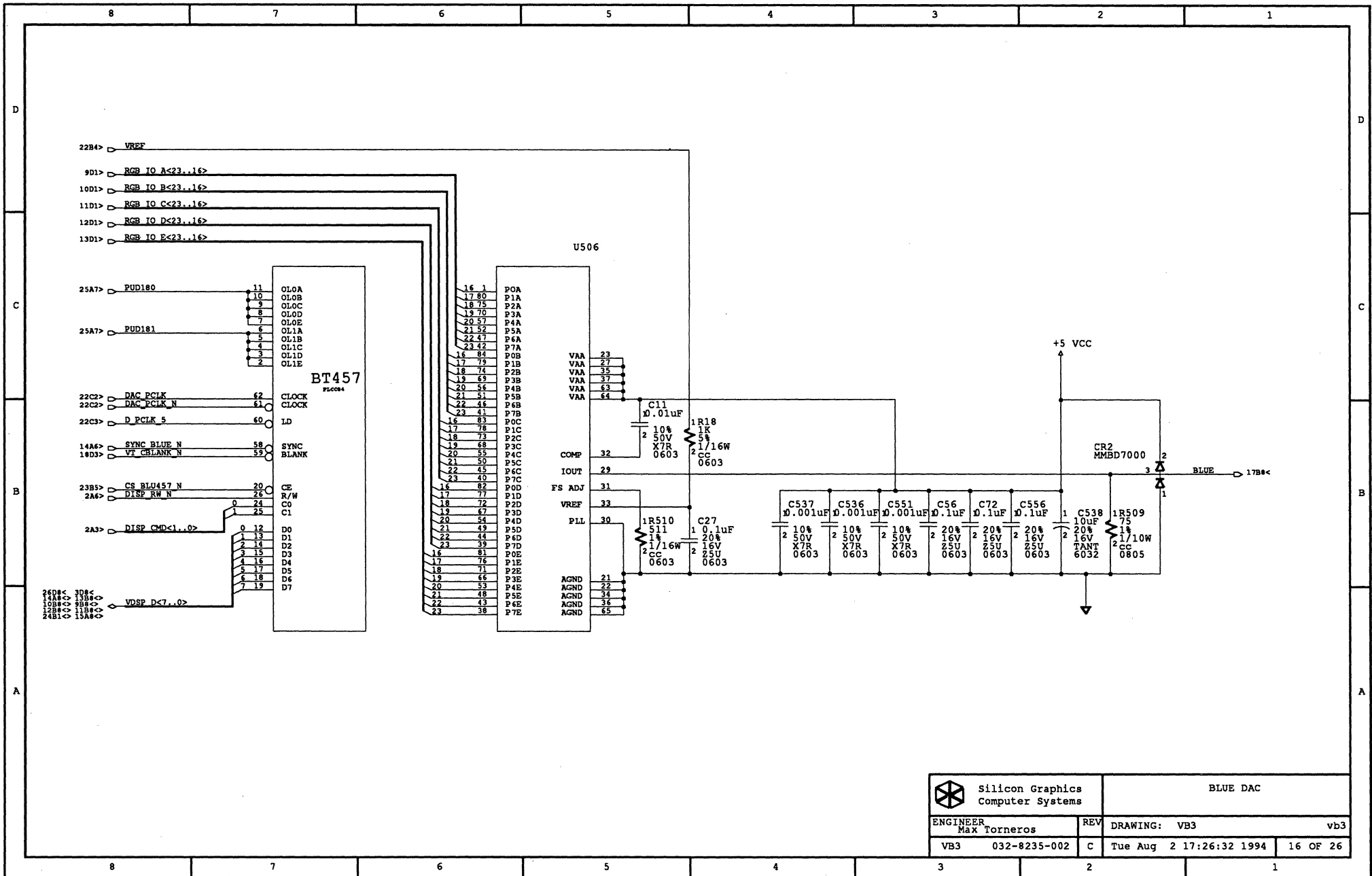

 Silicon Graphics Computer Systems		BLUE DAC	
ENGINEER Max Torneros	REV	DRAWING: VB3	vb3
VB3 032-8235-002	C	Tue Aug 2 17:26:32 1994	16 OF 26

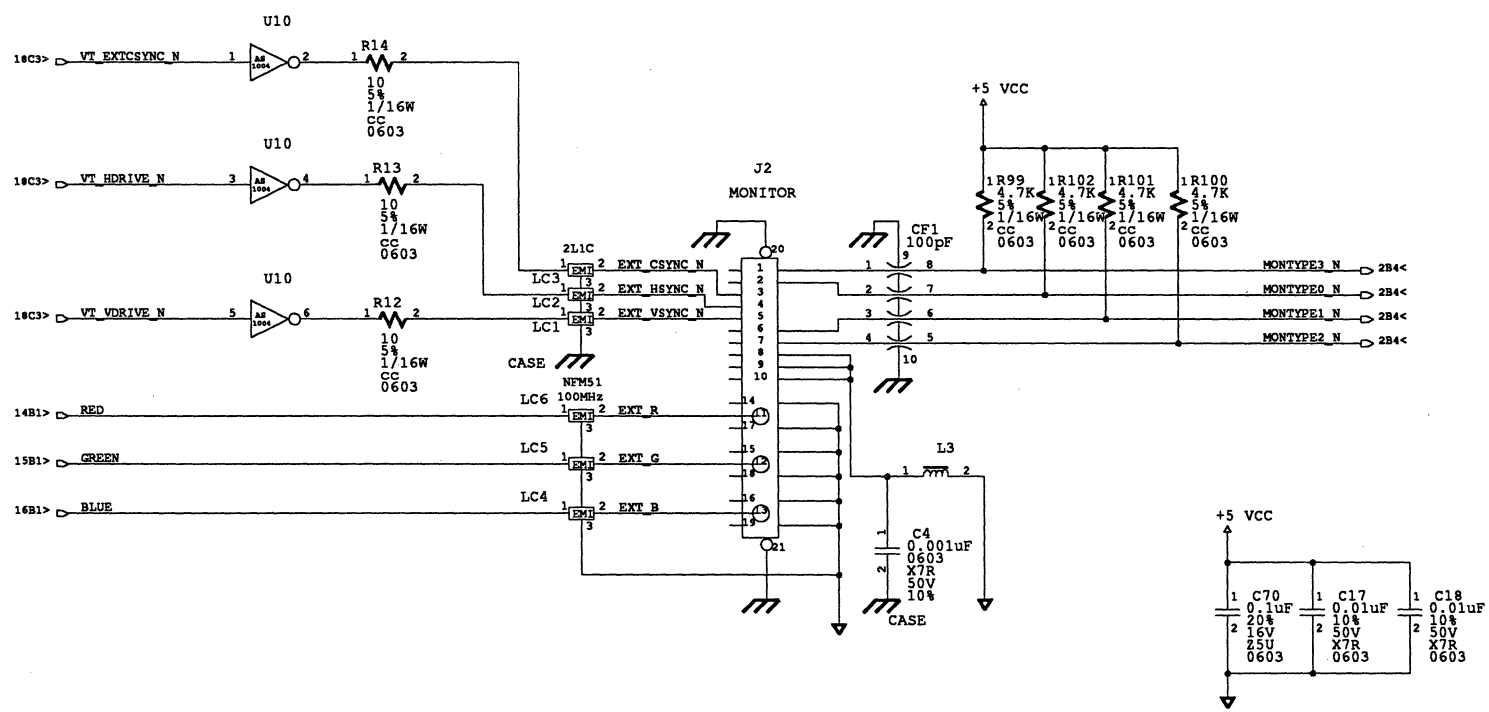

		Video Output		
				ENGINEER Max Torneros
VB3	032-8235-002	C	Tue Aug 2 17:26:50 1994	17 OF 26

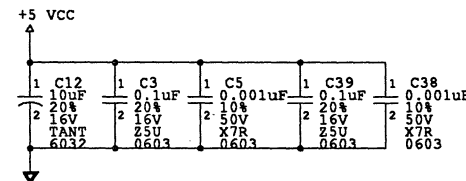
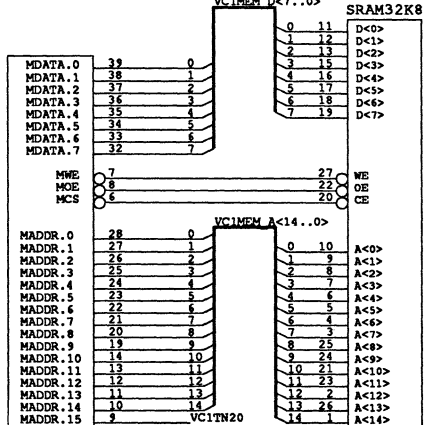
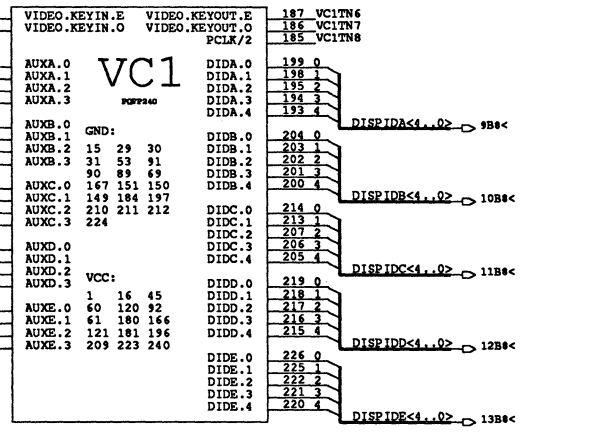
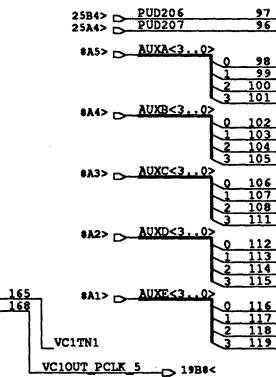
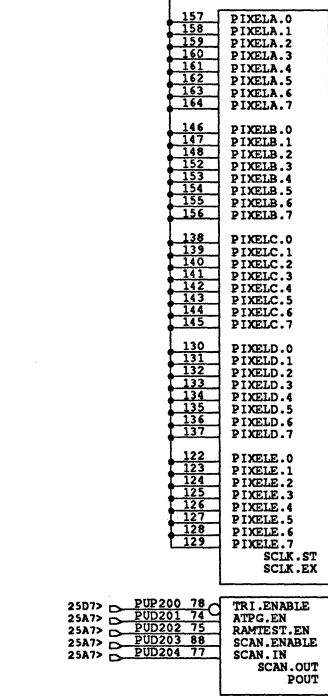
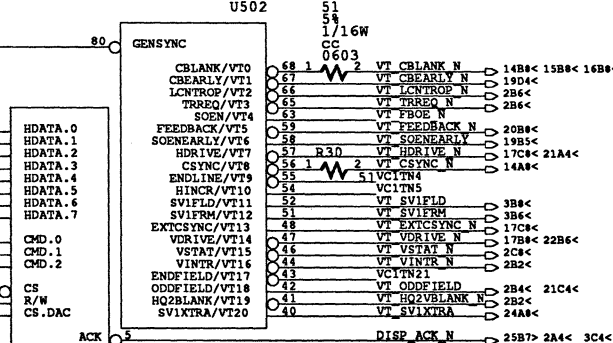
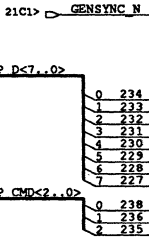
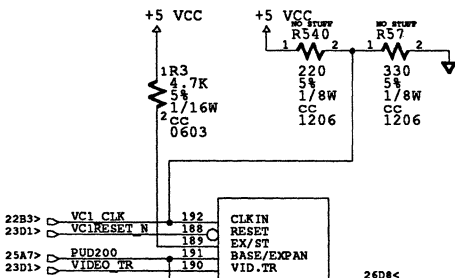

Silicon Graphics Computer Systems		VC1 and VC1 SRAM		
		ENGINEER Max Torneros	REV C	DRAWING: VB3
VB3	032-8235-002	C	Tue Aug 2 17:27:10 1994	18 OF 26

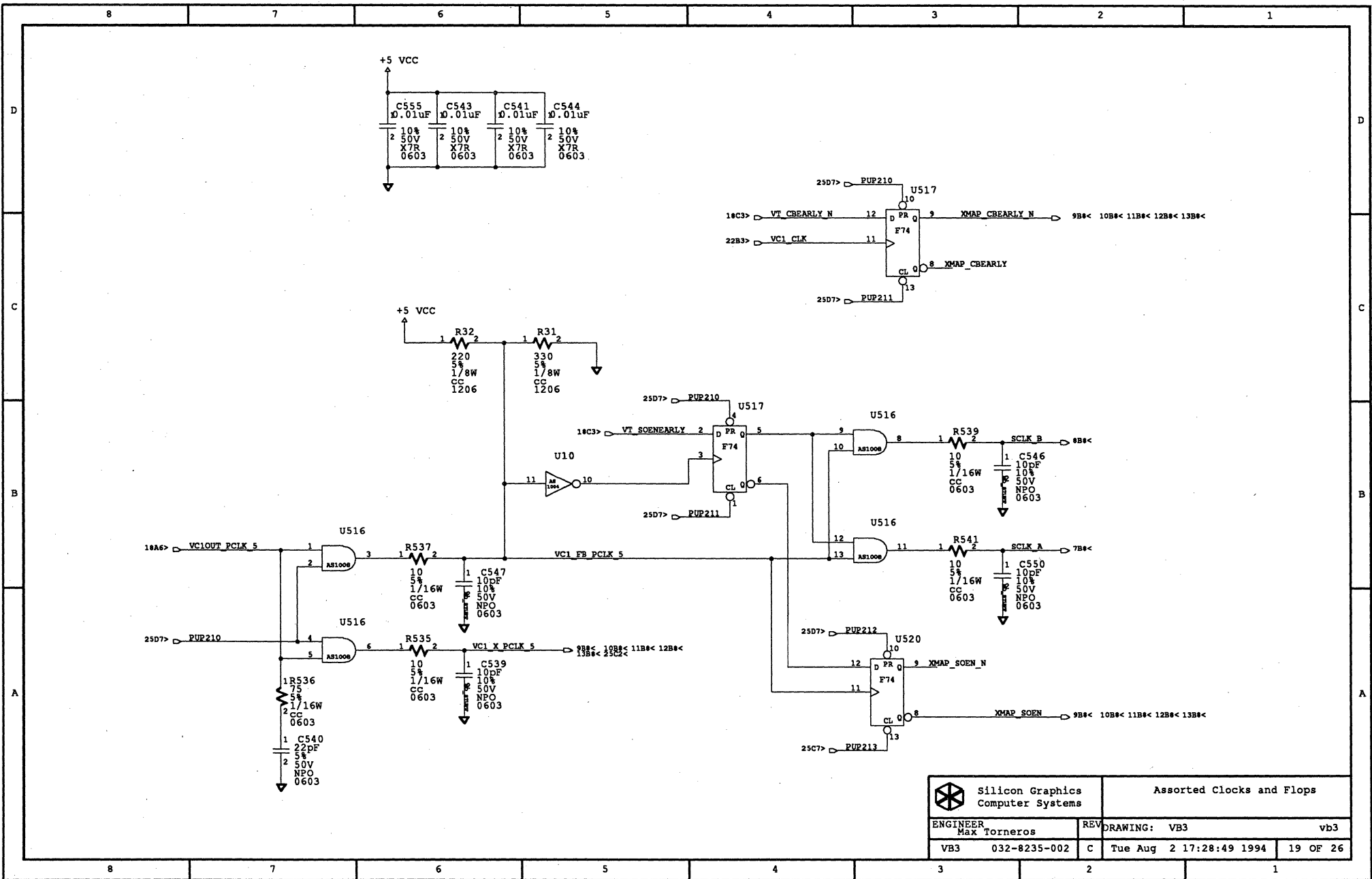

 Silicon Graphics Computer Systems		Assorted Clocks and Flops	
ENGINEER Max Torneros	REV	DRAWING: VB3	vb3
VB3	032-8235-002	C	Tue Aug 2 17:28:49 1994 19 OF 26

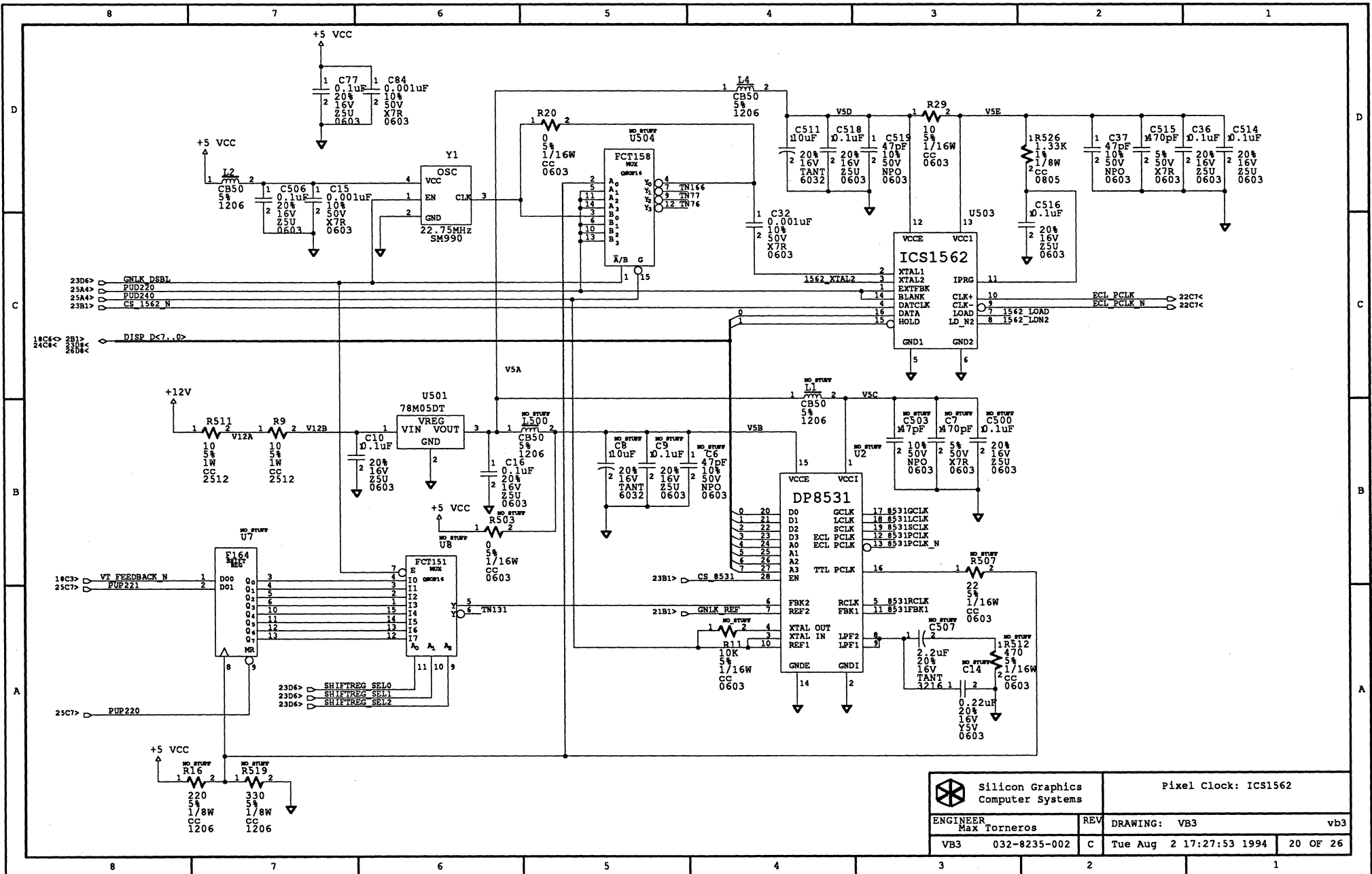

		Pixel Clock: ICS1562	
		ENGINEER Max Torneros	REV DRAWING: VB3
VB3	032-8235-002	C	Tue Aug 2 17:27:53 1994
			20 OF 26

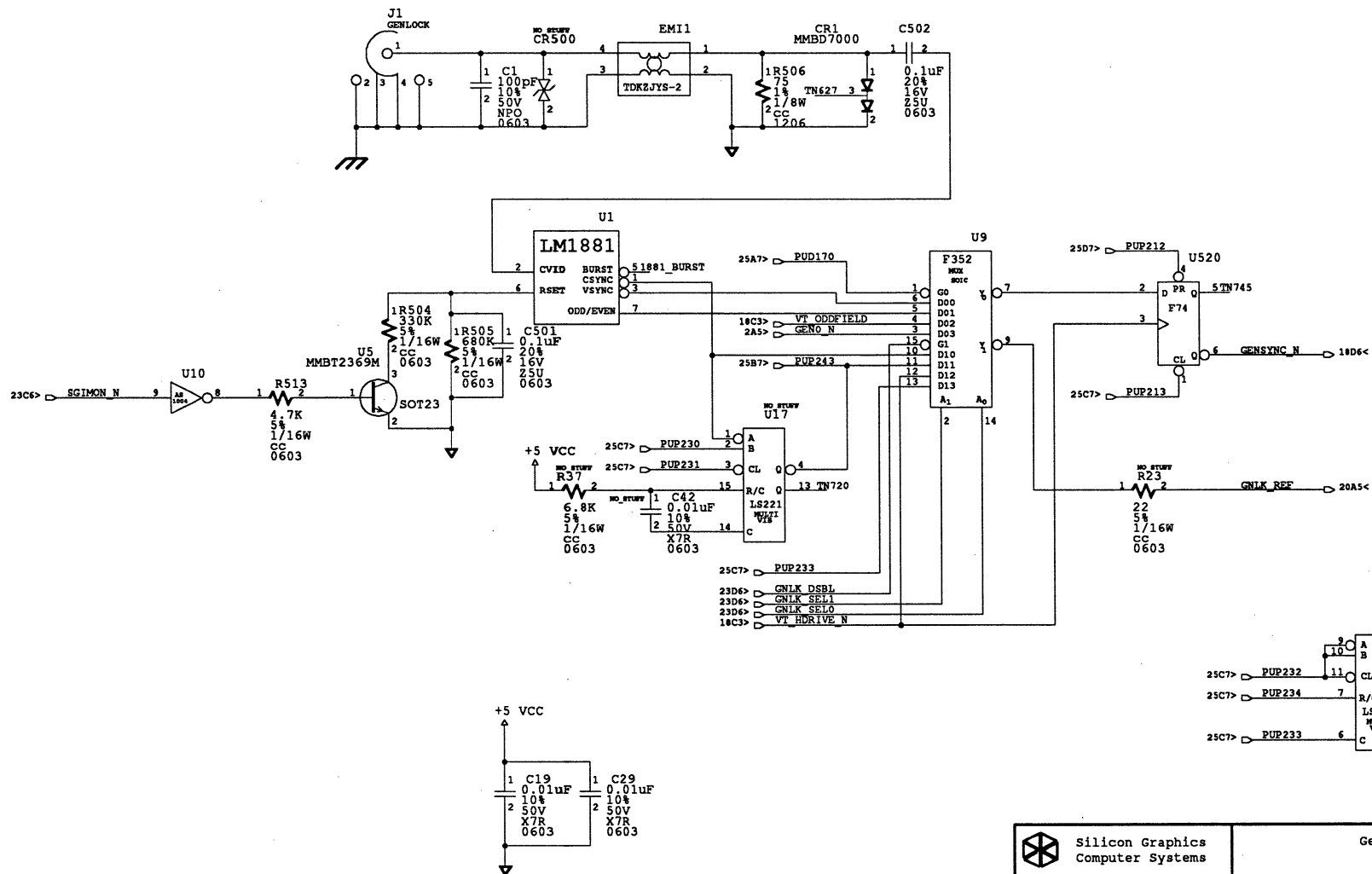

 Silicon Graphics Computer Systems		Genlock		
				ENGINEER Max Torneros
VB3	032-8235-002	C	Tue Aug 2 17:29:08 1994	21 OF 26

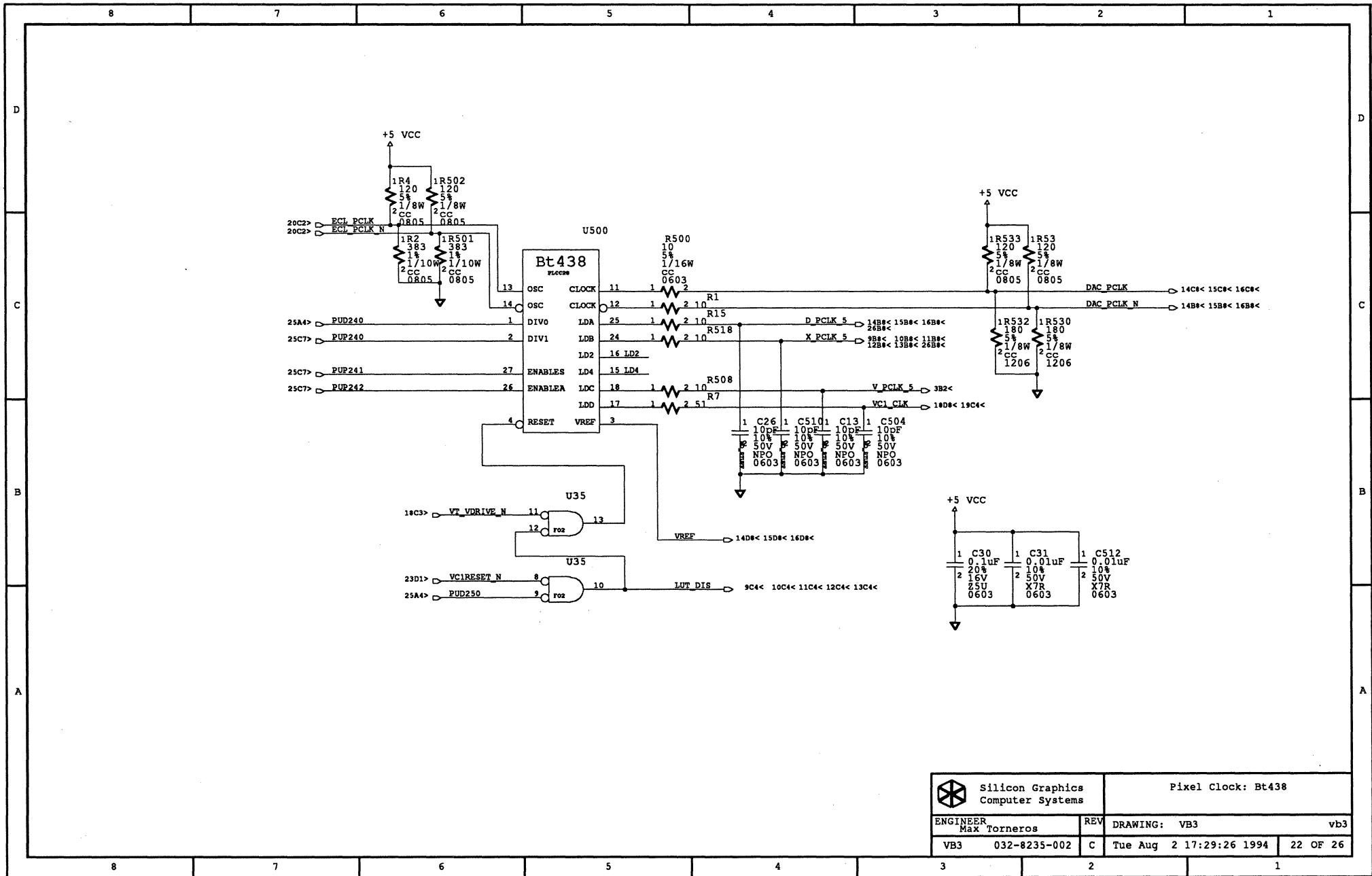

 Silicon Graphics Computer Systems		Pixel Clock: Bt438	
ENGINEER Max Torneros	REV	DRAWING: VB3	vb3
VB3	032-8235-002	C	Tue Aug 2 17:29:26 1994 22 OF 26

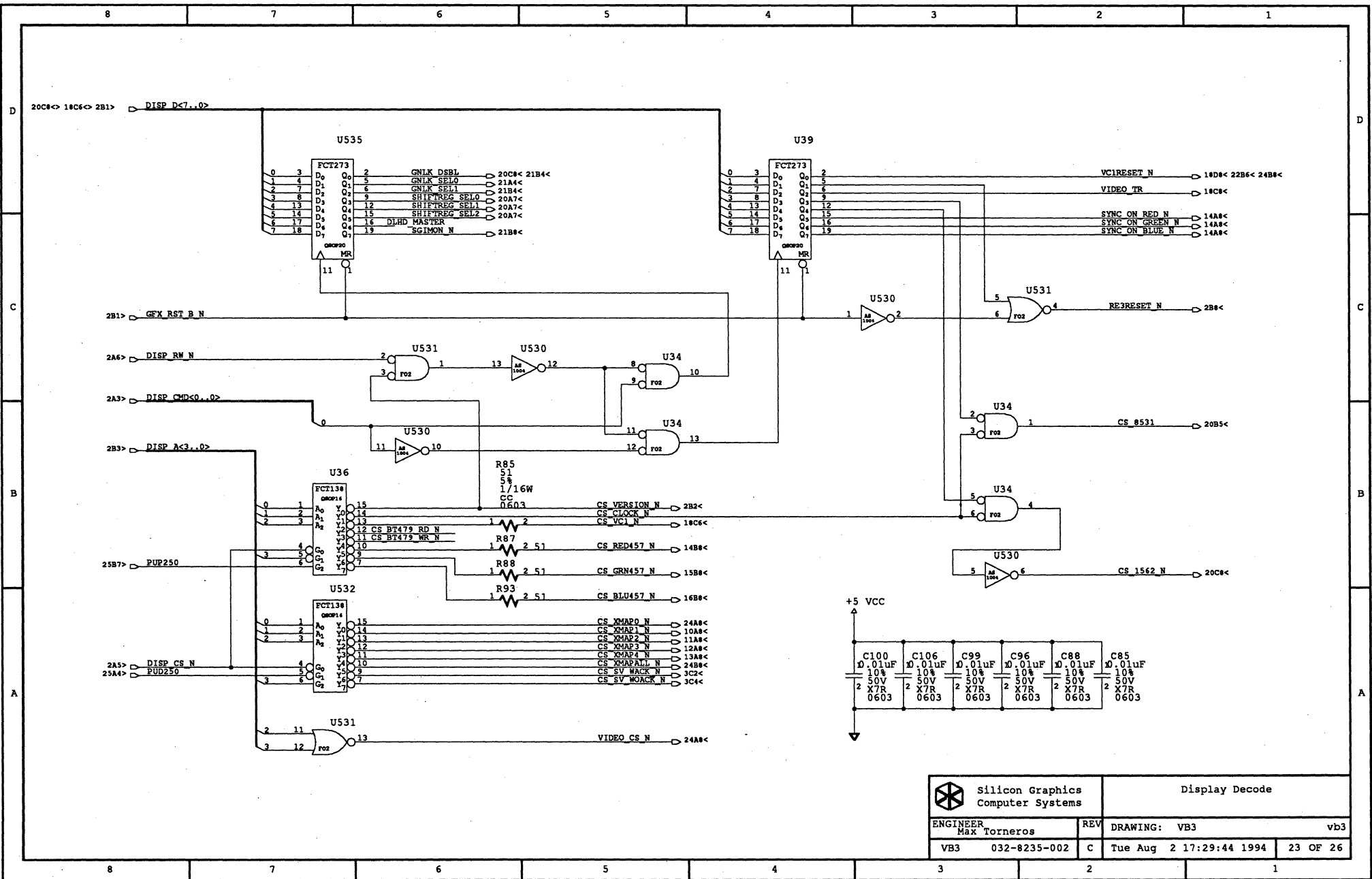

		Display Decode		
				ENGINEER Max Torneros
VB3	032-8235-002	C	Tue Aug 2 17:29:44 1994	23 OF 26

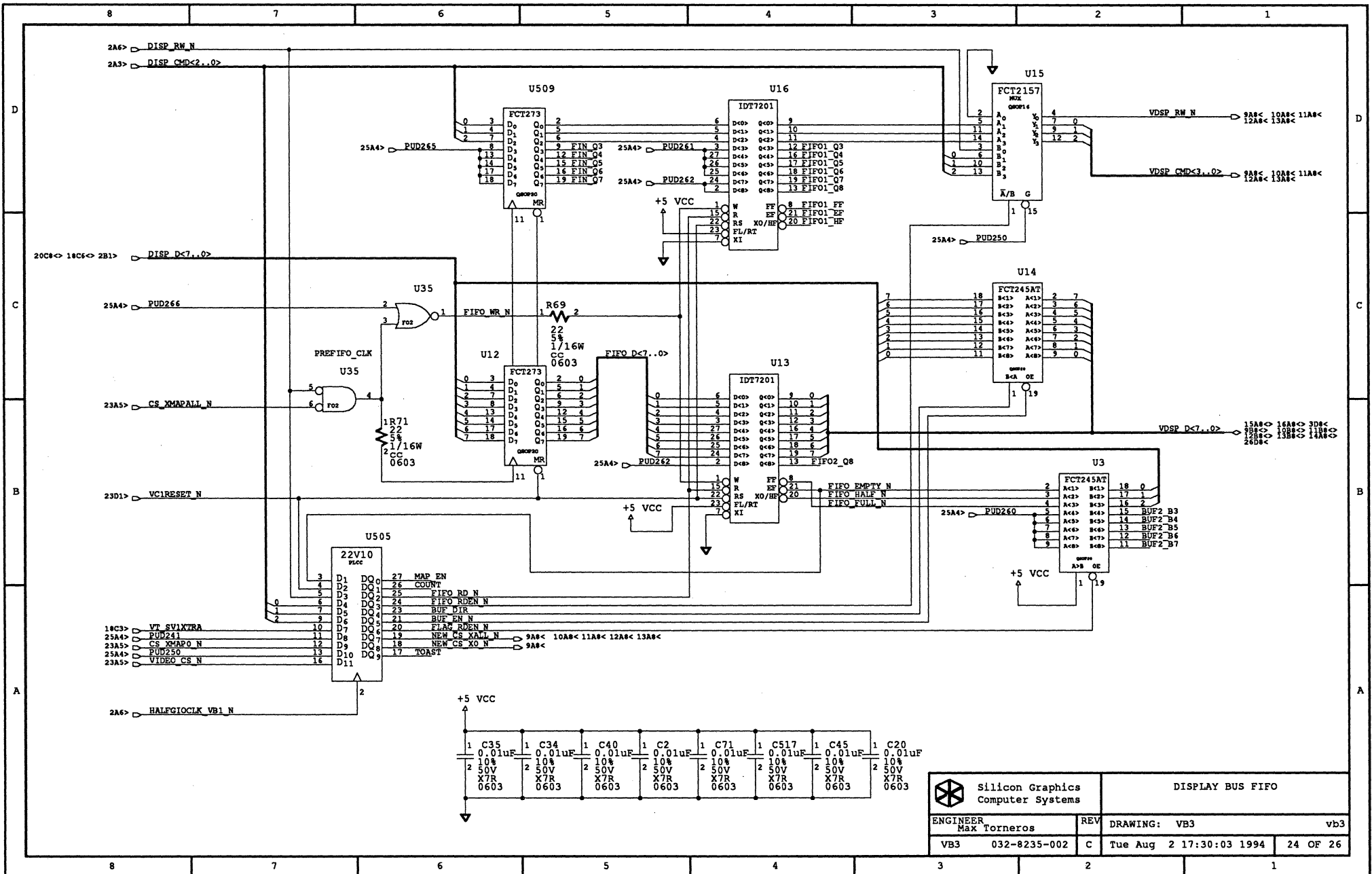

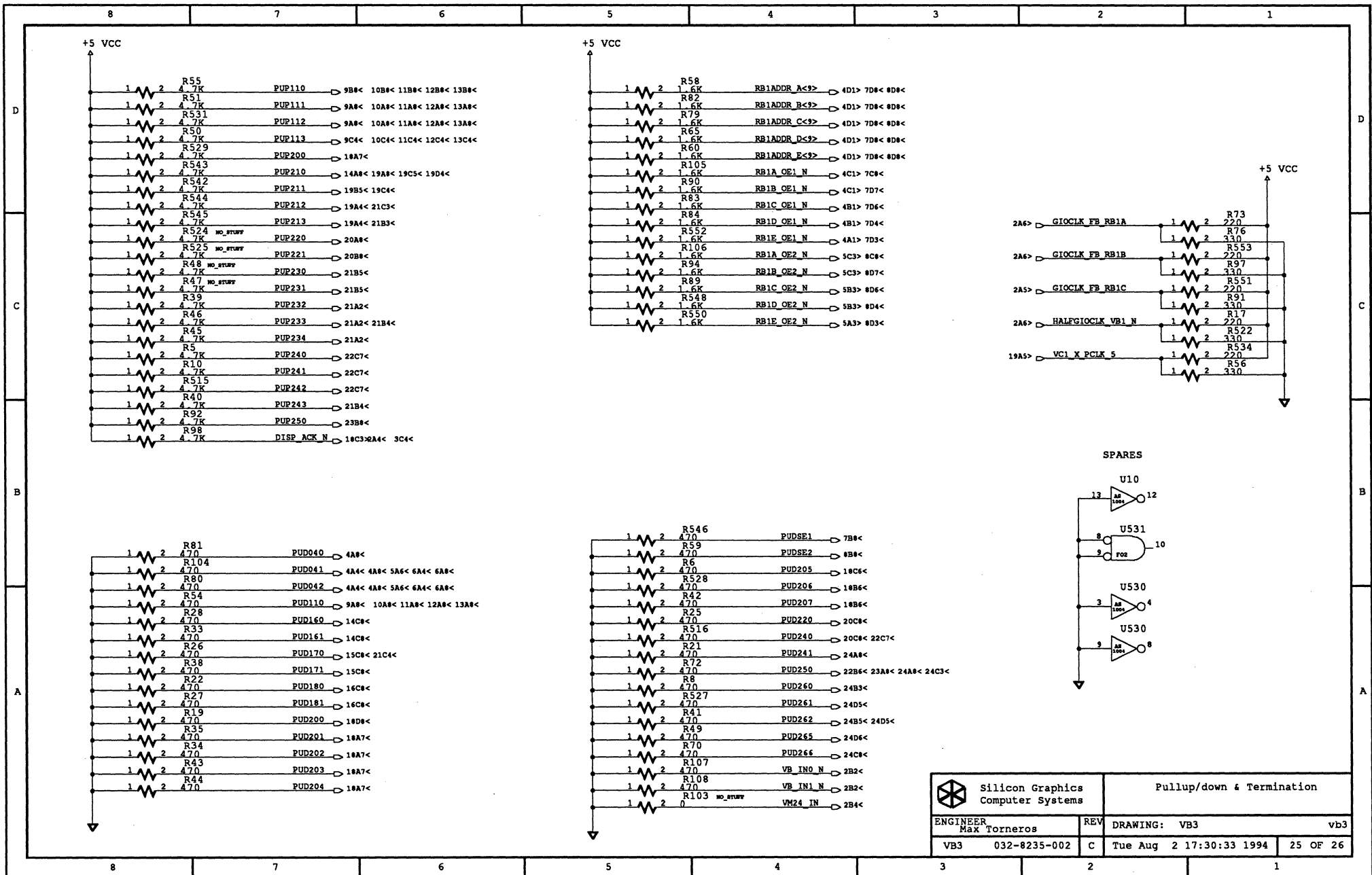

Silicon Graphics Computer Systems		Pullup/down & Termination	
		ENGINEER Max Torneros	REV C
VB3 032-8235-002		Tue Aug 2 17:30:33 1994 25 OF 26	

