

4500
600

3900
3300
2700.
2100.



Phase IV Systems

Oakfield House, Oakfield Industrial Estate,
Stanton Harcourt Road, Eynsham,
Oxon OX8 1TH, England
Tel: 0865 883355 · Tlx: 83228 Phase
Fax: 0865 883352

THE VIKING SERIES

SCSI HOST ADAPTERS
FOR
DEC Q-BUS AND UNIBUS SYSTEMS

INSTALLATION GUIDE

3

TD SYSTEMS
INCORPORATED

THE HOST ADAPTER COMPANY

VIKING INSTALLATION GUIDE

P/N 900-00036

2nd Edition, April 1989

1st Edition, July 1988

Copyright (C) 1988,89 by TD Systems, Incorporated
All Rights Reserved.
Printed in the U.S.A.

The material in this manual is intended for informational purposes. TD Systems assumes no responsibility for errors in this manual, and reserves the right to make changes in this manual and the described product without prior notice.

TD Systems welcomes questions and comments from the reader concerning its products and the material in this manual.

TD SYSTEMS, INC.
24 Payton Street
Lowell, MA 01853

TEL: (508) 937-9465

FAX: (508) 458-1820

DEC, Q-Bus, Unibus, VAX, MicroVAX, MicroPDP, RSTS, RSX, VMS
are trademarks of the
Digital Equipment Corporation.

TABLE OF CONTENTS

SECTION 1:	INTRODUCTION	1
SECTION 2:	INSTALLATION	2
2.1	Determine CSR Address	
2.2	Set CSR Address Jumpers	
2.3	Q-Bus Installation	
2.4	Unibus Installation	
2.5	SCSI Installation	
SECTION 3:	OPERATION	8
3.1	Power-up	
3.2	Auto-configuration	
3.3	Model QDA Bootstrap	
3.4	Running the Onboard Utilities	
3.5	Configuration Options	
SECTION 4:	PROBLEM SOLVING	13
4.1	General	
4.2	Debugging Tools	
4.3	Configuration Problems	
4.4	Device Errors or Erratic Operation	
4.5	Viking Affects Other Devices in System	
PENDIX A:	VMS NOTES	17
A1	VMS Sysgen Procedure	
A2	VMS Backup Command Switches	
A3	Persistent Tape Initialization Errors	
A4	VMS Console Error Messages	
A5	Setting Disk Cluster Size	
PENDIX B:	ALTERNATE ADDRESS OPTION CHIPS	21

TABLE 1: VIKING MODELS AND SUPPORTED SCSI DEVICES

MODEL	INTERFACE	EMULATION	LOGICAL UNITS	PHYSICAL DEVICES	COMMENTS
QDO	Q-BUS: DUAL-WIDE Q22 SLOT	ONE MSCP DISK PORT	8 'DU' UNITS MAXIMUM	SCSI: 7 MAX DISKS: 8 MAX	Auto-configures with SCSI Common Command Set (CCS) disks. Diagnostic utilities allow manual configuration, disk formatting, and verification through the on-board serial port (requires optional cable adapter panel).
UDO	UNIBUS: QUAD-WIDE SPC SLOT				
QDA	Q-BUS: DUAL-WIDE Q22 SLOT	ONE MSCP DISK PORT & BOOTSTRAP	8 'DU' UNITS MAXIMUM	SCSI: 7 MAX DISKS: 8 MAX	The QDA combines the features of the QDO with a bootstrap for LSI-11 and MicroPDP systems.
QTO	Q-BUS: DUAL-WIDE Q22 SLOT	ONE MSCP TAPE PORT	8 'MU' UNITS MAXIMUM	SCSI: 7 MAX TAPES: 8 MAX	This model works with almost all SCSI tape drives. It auto-configures, so drive types may be mixed. Specify the 'A' version for half-inch and other variable block drives, or the 'F' version for fixed block cartridge drives.
UTO	UNIBUS: QUAD-WIDE SPC SLOT				
QDT	Q-BUS: DUAL-WIDE Q22 SLOT	ONE MSCP DISK PORT AND ONE MSCP TAPE PORT	8 'DU' UNITS MAXIMUM AND 4 'MU' UNITS MAXIMUM	SCSI: 7 MAX DISKS: 8 MAX TAPES: 4 MAX	A two-port board that combines disk MSCP emulation on port A with tape MSCP emulation on port B. The disk port has the same features as the QDO/UDO while the tape port has the same features as the QTO/UTO.
UDT	UNIBUS: QUAD-WIDE SPC SLOT				
QDD	Q-BUS: DUAL-WIDE Q22 SLOT	TWO MSCP DISK PORTS 'A' AND 'B'	8 'DU' UNITS MAX PORT A AND 4 'DU' UNITS MAX PORT B	SCSI: 7 MAX DISKS: 12 MAX	A two-port board with the same features as the QDT/UDT, but the second port is a disk port. This model is appropriate for applications that combine disk MSCP emulation on port A with direct SCSI on port B.
UDD	UNIBUS: QUAD-WIDE SPC SLOT				

**DISK DRIVES SUPPORTED,
EMBEDDED SCSI:**

CDC • CONNORS • DTC
FUJITSU • HITACHI • IOMEGA
KODAK • MAXTOR
MICROPOLIS • MICROSCIENCE
NEC • PRIAM • QUANTUM
RICOH • RODIME • SEAGATE
SIEMENS • SONY • TOSHIBA

**TAPE DRIVES SUPPORTED,
'A' FIRMWARE:**

CALIPER* • CDC • CIPHER
DDC/PERTEC • EXABYTE
KENNEDY • FUJITSU • STC

'F' FIRMWARE:

ARCHIVE • CIPHER • EXABYTE
TANDBERG • WANGTEK

DISK CONTROLLERS:

ADAPTEC • DPT • SMS-OMTI
WESTERN DIGITAL*

TAPE CONTROLLERS:

EMULEX • NCR • WESTERN
DIGITAL*

* Under evaluation.

TABLE 2: VIKING SPECIFICATIONS AND CONNECTOR PINOUTS

SPECIFICATIONS:	Q-BUS MODELS
Identification:	Models QDA, QDO, QTO, QDT, QDD: Assembly no. 210-00031.
Board Size:	Standard DEC dual: 5.2 wide x 8.8 high including handles.
Bus Slot Required:	Standard DEC Q22
Power Required:	+5VDC +/- 5% at 2.8A maximum.
Bus Loads:	2 AC, 1 DC.
Interrupt Vector:	Programmable, set by Host.
Interrupt Priority:	Level 4 (single-level).
DMA Data Rate:	2.5 MByte/second peak, block mode.
SPECIFICATIONS:	UNIBUS MODELS
Identification:	Models UDO, UTO, UDT, UDD: Assembly no. 210-00036.
Board Size:	Standard DEC quad: 10.4 wide x 8.8 high including handles.
Bus Slot Required:	Standard DEC SPC
Power Required:	+5VDC +/- 5% at 2.8A maximum.
Bus Loads:	2 AC, 1 DC.
Interrupt Vector:	Programmable, set by Host.
Interrupt Priority:	Level 5 fixed.
DMA Data Rate:	2.0 MByte/second peak, burst mode.
SPECIFICATIONS:	SCSI, ALL MODELS
SCSI Devices:	8 maximum (Viking is one).
Drives / SCSI Controller:	2 maximum.
Data Rate:	Greater than 1.25 MByte/second asynchronous.
Interface:	Single-ended.
Connector:	50-pin flat ribbon cable header, shrouded and center-keyed.
Termination:	220/330 ohm permanent.
Terminator Power:	Fused +5v available on pin 26.
Cable Length:	6 meters (18 feet) maximum.

PINOUTS: VIKING SCSI CONNECTOR (J1)

PIN	SIGNAL	PIN	SIGNAL
2	-DB(0)	1	GROUND
4	-DB(1)	3	GROUND
6	-DB(2)	5	GROUND
8	-DB(3)	7	GROUND
10	-DB(4)	9	GROUND
12	-DB(5)	11	GROUND
14	-DB(6)	13	GROUND
16	-DB(7)	15	GROUND
18	-DB(P)	17	GROUND
20	CON TX (RS232) *	19	GROUND
22	CON RX (RS232) *	21	GROUND
24	GROUND	23	GROUND
26	+5V FUSED	25	(OPEN)
28	FP TX (RS232)	27	GROUND
30	FP RX (RS232)	29	GROUND
32	-ATN	31	GROUND
34	GROUND	33	GROUND
36	-BSY	35	GROUND
38	-ACK	37	GROUND
40	-RST	39	GROUND
42	-MSG	41	GROUND
44	-SEL	43	GROUND
46	-C/D	45	GROUND
48	-REQ	47	GROUND
50	-I/O	49	GROUND

PINOUTS: ADAPTER BOARD TO SCSI DEVICE

PIN	SIGNAL	PIN	SIGNAL
1	GROUND	1	GROUND
3	GROUND	3	GROUND
5	GROUND	5	GROUND
7	GROUND	7	GROUND
9	GROUND	9	GROUND
11	GROUND	11	GROUND
13	GROUND	13	GROUND
15	GROUND	15	GROUND
17	GROUND	17	GROUND
19	GROUND	19	GROUND
21	GROUND	21	GROUND
23	GROUND	23	GROUND
25	(OPEN)	25	(OPEN)
27	GROUND	27	GROUND
29	GROUND	29	GROUND
31	GROUND	31	GROUND
33	GROUND	33	GROUND
35	GROUND	35	GROUND
37	GROUND	37	GROUND
39	GROUND	39	GROUND
41	GROUND	41	GROUND
43	GROUND	43	GROUND
45	GROUND	45	GROUND
47	GROUND	47	GROUND
49	GROUND	49	GROUND

SECTION 2: INSTALLATION

The Viking installation procedure consists of five steps, which are explained in detail in the following paragraphs:

Step 1. Determine the correct Viking CSR base address for your system.

Step 2. Set the Viking address jumpers.

Step 3. Select and prepare a backplane slot for the Viking.

Step 4. Install the Viking in your system.

Step 5. Connect the SCSI devices to the Viking

2.1 DETERMINE CSR ADDRESS

The correct CSR address for a Viking port is the one that the operating system will recognize when it configures the target system. In all its operating systems DEC assigns standard addresses in system I/O space to the first port of each mass-storage device type: 772150 octal for the first disk MSCP controller and 774500 octal for the first tape MSCP controller. When the Viking is the first device of its type in the system, use the standard (default) address option.

When the Viking is installed in a system that already has one or more of the same device type, then the Viking's CSR address will have to be set to a value in 'floating' I/O space. If the operating system is VMS, use the SYSGEN procedure described in Appendix A. For PDP-11 systems, refer to the PDP-11 Architecture Handbook (DEC EB-23657-18) or use the FLOAT utility run from the XXDP+ Diagnostic Supervisor to determine the correct address. Be aware, however, that some PDP-11 operating systems have no built-in provisions for additional devices, and will have to be re-SYSGENed to accommodate the Viking. For details, refer to the system generation manual for the particular O/S used on your system.

2.2 SET CSR ADDRESS JUMPERS

The Viking's MSCP port CSR addresses are set by a group of four option jumper plugs in the arrangement shown below. Refer to either Figure 1 (Q-Bus) or Figure 2 (Unibus) for the location of the option jumpers on your Viking. The range of available port addresses and the exact function of each option jumper depend on which Viking model you have. The models and their jumper options are listed below.

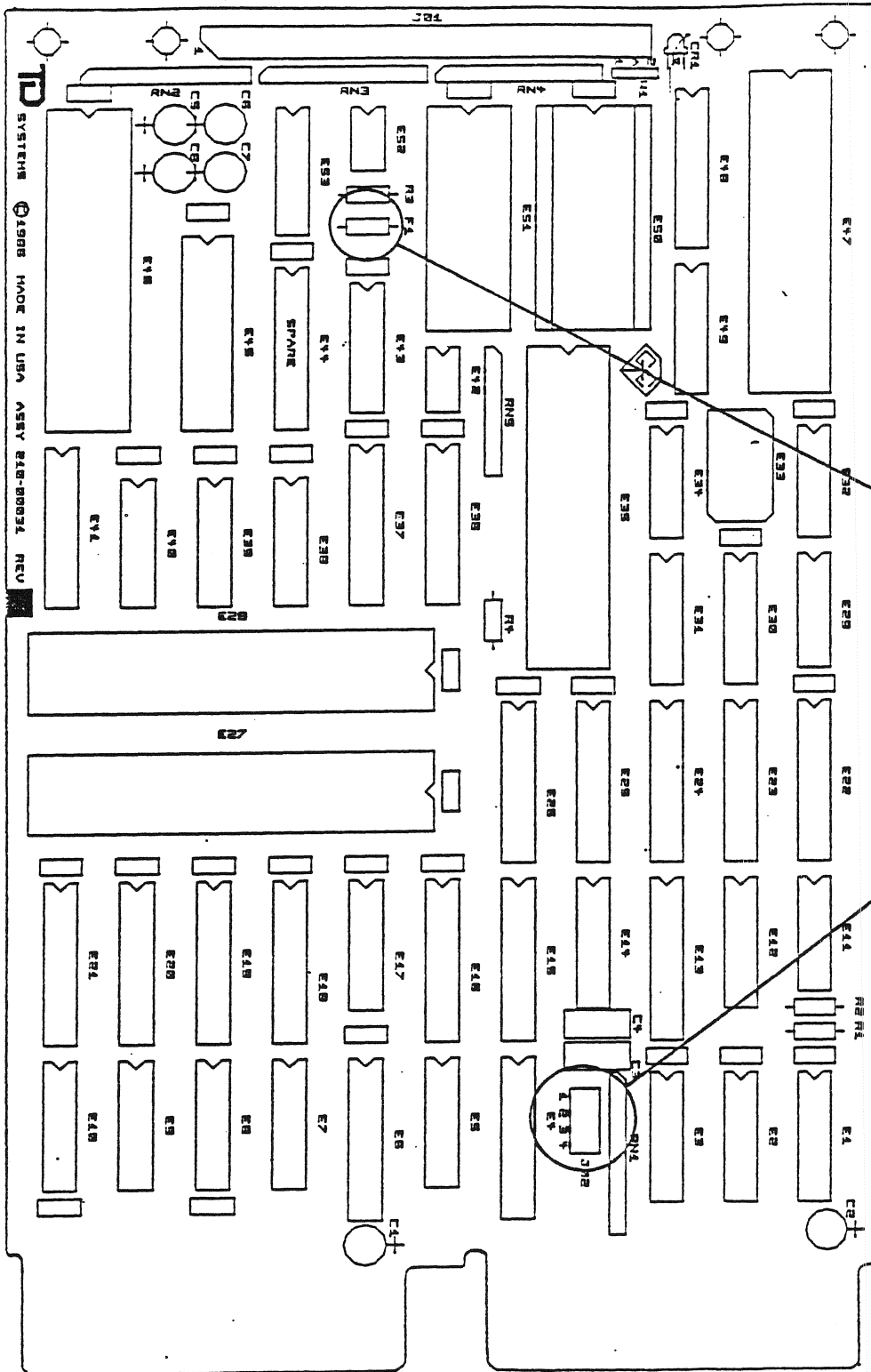

Terminator power fuse

Option plug

Figure 1

Terminator Power Fuse

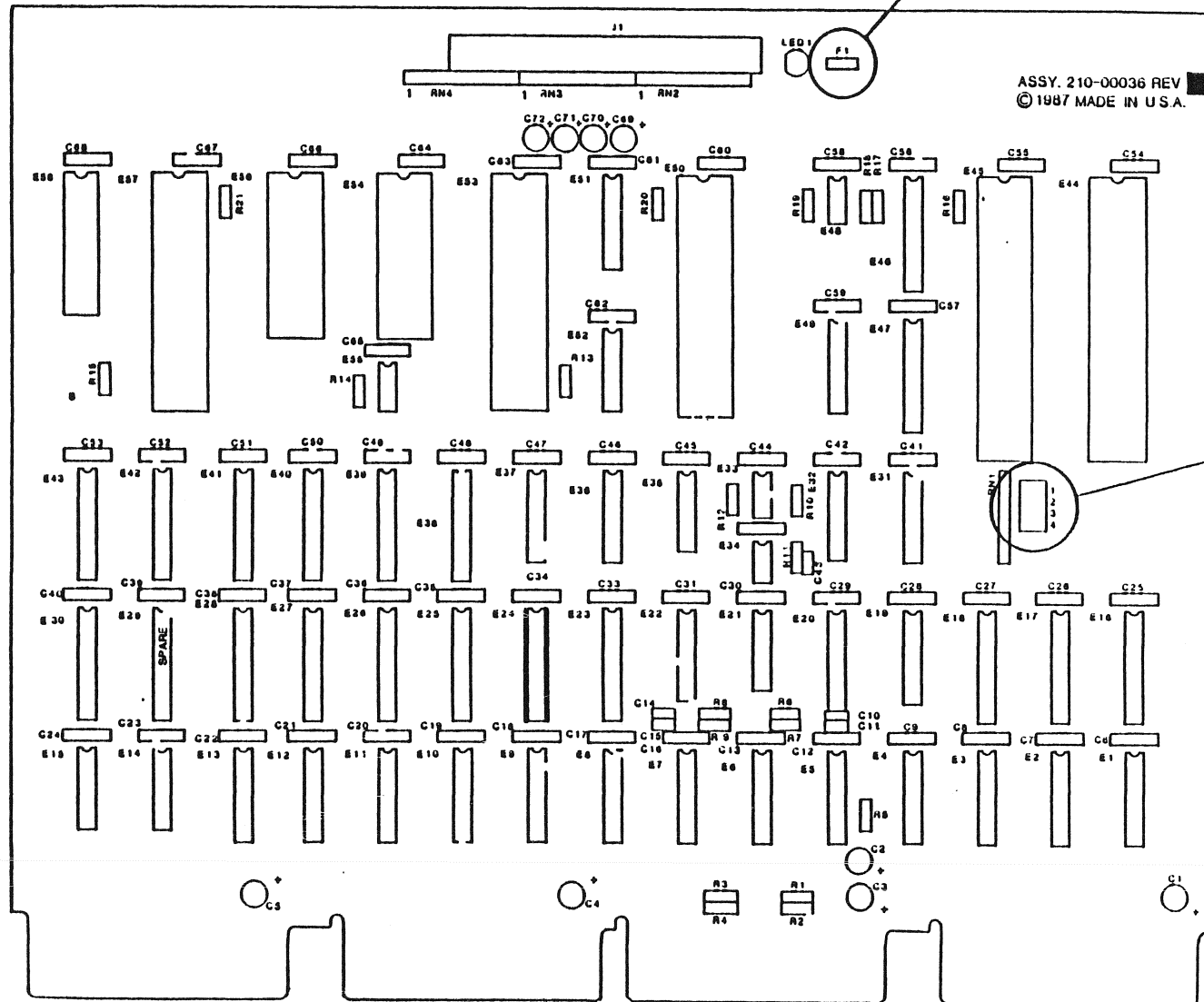

Option Plugs

Figure 2

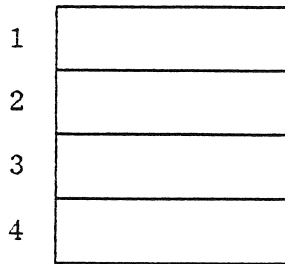

OPTION JUMPER ARRANGEMENT

IN = Installed

OUT = Removed

2.2.1 Models QDO and UDO

Viking models QDO and UDO appear to the Host computer as one mass-storage port, implementing DEC's Disk MSCP protocol. The port works with SCSI magnetic disks, which appear to the Host system as 'DU' devices. The following port address options are available:

PLUGS	1	2	3	DISK PORT ADDRESS
IN	IN	IN		772150 (Standard)
IN	IN	OUT		760334 (Floating device)
IN	OUT	IN		760340 (Floating device)
IN	OUT	OUT		760344 (Floating device)
OUT	IN	IN		772150 (Standard)
OUT	IN	OUT		760350 (Floating device)
OUT	OUT	IN		760354 (Floating device)
OUT	OUT	OUT		760360 (Floating device)

(PLUG 4 is not used and may be IN or OUT)

2.2.2 Models QTO and UTO

Viking models QTO and UTO appear to the Host computer as one mass-storage port, implementing DEC's Tape MSCP protocol. The port works with SCSI magnetic tapes, which appear to the Host system as 'MU' devices. The following port address options are available:

PLUGS	1	2	3	TAPE PORT ADDRESS
IN	IN	IN		774500 (Standard)
IN	IN	OUT		760404 (Floating device)
IN	OUT	IN		760444 (Floating device)
IN	OUT	OUT		760504 (Floating device)
OUT	IN	IN		774500 (Standard)
OUT	IN	OUT		760544 (Floating device)
OUT	OUT	IN		760604 (Floating device)
OUT	OUT	OUT		760644 (Floating device)

(PLUG 4 is not used and may be IN or OUT)

2.2.3 Models QDT and UDT

Viking models QDT and UDT appear to the Host computer as TWO mass-storage ports, one a disk port, and the other a tape port. Both ports implement DEC's MSCP protocol. The disk port emulates DEC's 'DU' devices, while the tape port emulates one or more TK50's with Tape MSCP. The following port address options are available:

PLUGS:	1	2	DISK PORT ADDRESS
	IN	IN	772150 (Standard)
	IN	OUT	760334 (Floating device)
	OUT	IN	760354 (Floating device)
	OUT	OUT	760374 (Floating device)

PLUGS:	3	4	TAPE PORT ADDRESS
	IN	IN	774500 (Standard)
	IN	OUT	760404 (Floating device)
	OUT	IN	760444 (Floating device)
	OUT	OUT	760504 (Floating device)

2.2.4 Models QDD and UDD

Viking models QDD and UDD appear to the Host computer as TWO mass-storage ports, both implementing DEC's MSCP protocol. Port 'A' works with SCSI magnetic disks, while Port 'B' works with SCSI optical disks. Both types of disks appear to the Host system as 'DU' devices. The following port address options are available:

PLUGS:	1	2	DISK PORT 'A' ADDRESS
	IN	IN	772150 (Standard)
	IN	OUT	760334 (Floating device)
	OUT	IN	760354 (Floating device)
	OUT	OUT	760374 (Floating device)

PLUGS:	3	4	DISK PORT 'B' ADDRESS
	IN	IN	772154 (Standard)
	IN	OUT	763000 (Floating device)
	OUT	IN	763100 (Floating device)
	OUT	OUT	763200 (Floating device)

2.2.5 Model QDA

Viking model QDA appears to the Host computer as one mass-storage port, implementing DEC's Disk MSCP protocol. The port works with SCSI magnetic disks, which appear to the Host system as 'DU' devices. Port B on the QDA, when enabled, provides a Bootstrap routine for MicroPDP Q-Bus systems ONLY. The Bootstrap address may be set to either 773000 (DEC standard) or 771000 (alternate).

NOTE: If the on-board bootstrap is to be enabled, make sure that all other bootstraps are disabled or do not conflict with the selected bootstrap address.

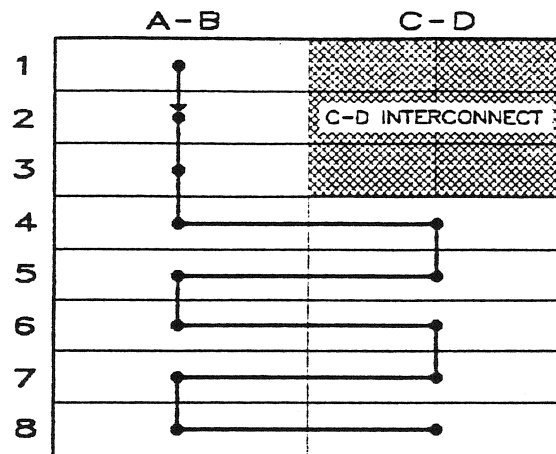

FIGURE 3
Q-BUS DMA GRANT ROUTING
(H9278 BACKPLANE)

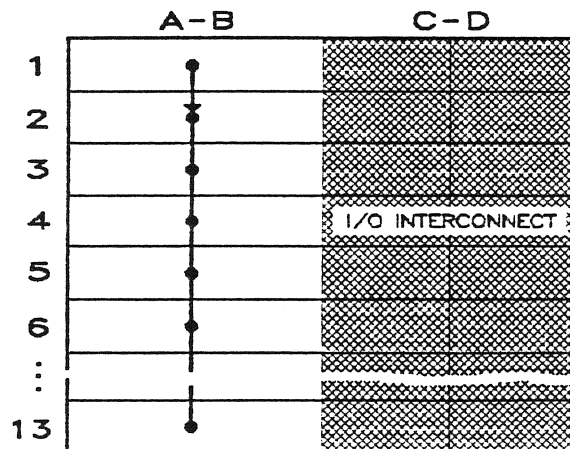
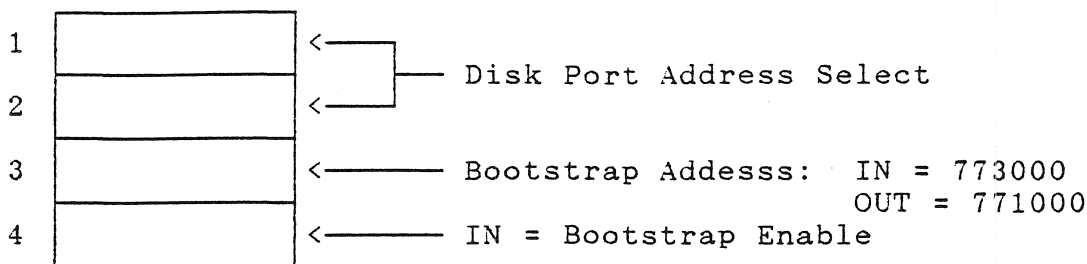

FIGURE 4
Q-BUS DMA GRANT ROUTING
MICROVAX 3xxx



PLUGS	1	2	3	4	DISK PORT ADDRESS	
	IN	IN	-	IN	772150	(Standard)
	IN	OUT	-	IN	763000	(Floating device)
	OUT	IN	-	IN	763100	(Floating device)
	OUT	OUT	-	IN	763200	(Floating device)
	IN	IN	-	OUT	772150	(Standard)
	IN	OUT	-	OUT	760334	(Floating device)
	OUT	IN	-	OUT	760354	(Floating device)
	OUT	OUT	-	OUT	760374	(Floating device)

2.3 Q-BUS INSTALLATION

Viking Q-Bus models require a single dual-wide Q22 slot in the Q-Bus backplane. Because the Viking system is fully buffered, DMA priority is not critical. The Viking supports only single-level interrupt priority, so it should be placed AFTER any multi-level interrupting devices on the Q-Bus.

2.3.1 Installation in a BA23/123 Cabinet

The Viking may be installed in any Q22 slot. Figure 3 shows a typical BA23/123 backplane. Note that the C-D connectors in the first 3 slots are not Q22 compatible. Also, the DMA Grant daisy chain must be continuous from the processor in slot 1 to the last board in the backplane; there can be no empty Q22 slots between boards.

NOTE: The old DEC RQDX1 (RX50/RD50/RD51) controller does NOT pass DMA grants. The Viking must be installed AHEAD of the RQDX1 in the backplane.

2.3.2 Installation in a MicroVAX 3xxx

The MicroVAX 3000 series have a new cabinet (the BA200 series) and backplane layout. The backplane has 13 quad-width slots, but only the A-B connectors have Q22 signals. The C-D connectors are unwired. The Viking can only be installed in the A-B connectors. DMA Grant routing is straightforward, as shown in Figure 6.

Due to the new design, however, additional hardware is required to maintain the cabinet's EMI shielding and airflow characteristics. DEC sells the hardware pieces either individually or in a kit. The kit is DEC model number H3651. It includes a handle with dual I/O cutouts and the necessary filler panels.

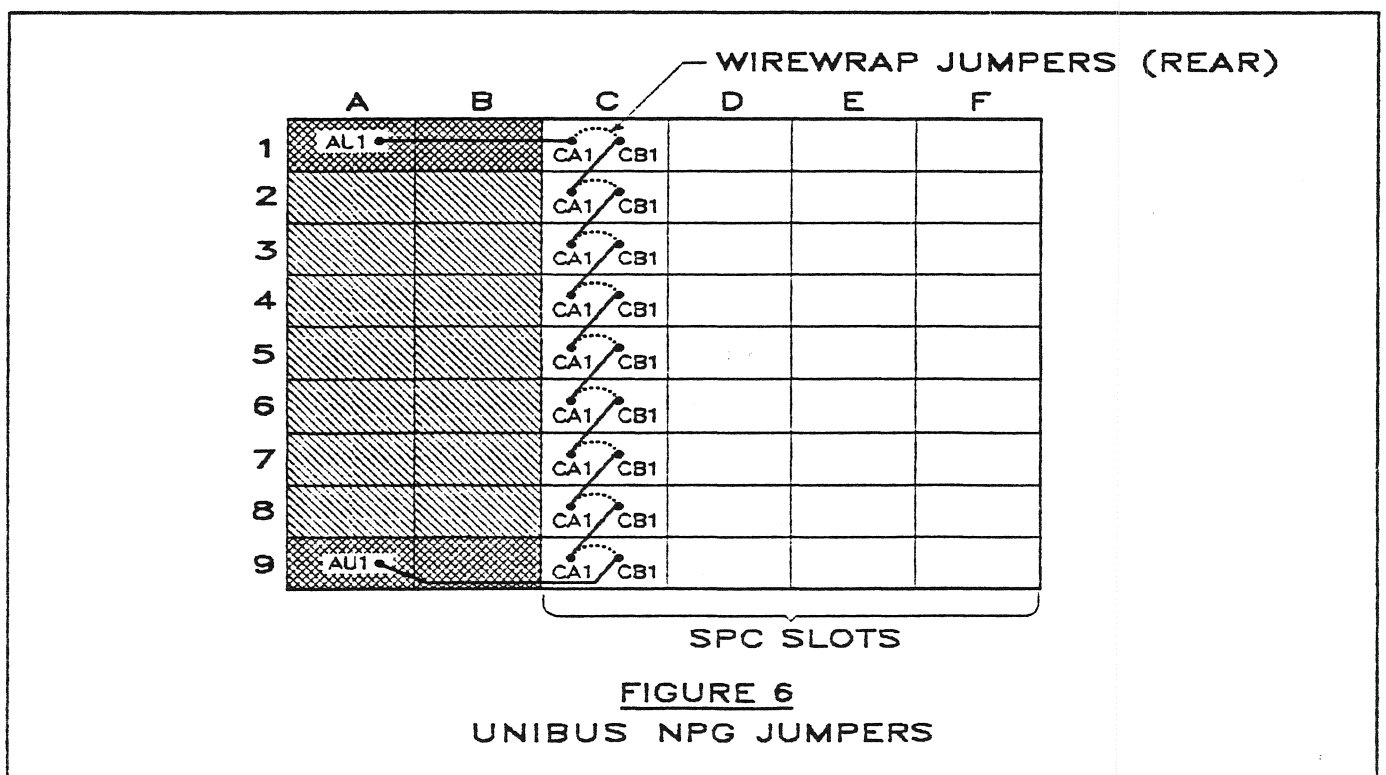
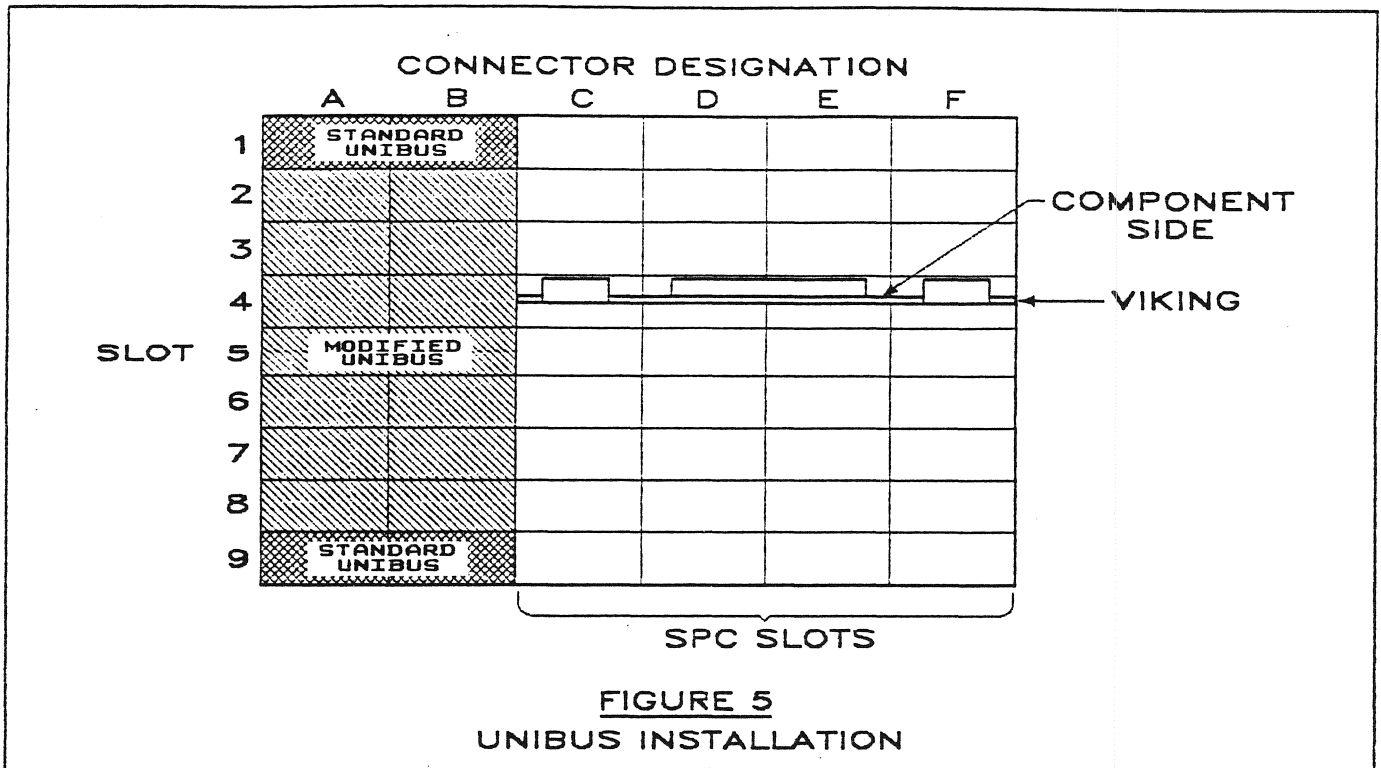

2.4 UNIBUS INSTALLATION

2.4.1 Backplane Requirements

The Unibus Viking models require a single quad-wide SPC slot in a Small Peripheral Controller (SPC) backplane. The backplane must be wired to 'SPC PRIME' specifications: that is, it must accommodate DMA peripherals. All new backplanes, VAX Unibus adapters, and most other Unibus backplanes currently in service meet this requirement. If in doubt, verify that other DMA peripherals are installed, or contact your DEC Field Engineer.

The Viking is fully buffered, so its DMA (NPR) priority is not critical, and it may be placed anywhere in the backplane. Its BR level is fixed at Level 5, so its interrupt priority may only be altered by repositioning it in the backplane. Figure 5 shows a typical Unibus backplane with the Viking installed.

2.4.2 Slot Preparation

Select an unused slot in the backplane and remove the grant continuity card from it. If the grant card is a full-height card mounted in connectors C and D, no further preparation is necessary.

If the grant card is the small G727A model installed in connector D, the NPG jumper also must be removed from between pins CA1 and CB1 of the selected slot. This jumper is found on the wiring side of the backplane. Figure 6 shows the NPG wiring as it would appear from the top of the backplane if you had x-ray vision.

2.4.3 Installation

The Viking is inserted into connectors C-D-E-F of the prepared slot, with its component side facing slot 1 as shown in Figure 5.

NOTE: Under NO circumstances should the Viking be inserted into connector A or B, as there are voltages present on these connectors that will damage the Viking.

2.5 SCSI INSTALLATION

2.5.1 General Rules

The following is a brief summary of the rules for connecting SCSI devices to the Viking. See Figure 7. Refer also to the manuals for the devices to be installed for additional information.

Maximum Number of Devices. No more than eight SCSI devices may be connected together on the SCSI Bus. The Viking represents one device. Each device must have a unique SCSI ID (address) in the range 0-7. Most SCSI devices have jumpers or DIP switches to set their SCSI ID. The Viking is shipped with its SCSI ID=7. This may be changed if necessary by using the on-board utilities accessed via the Viking's serial port. Refer to the Viking Technical Manual (900-00031) for more details.

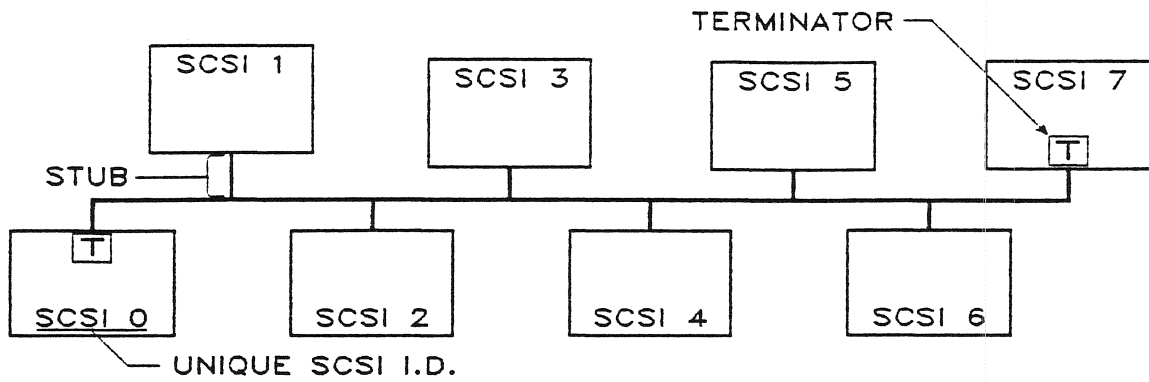

FIGURE 7
MAXIMUM SCSI CONFIGURATION

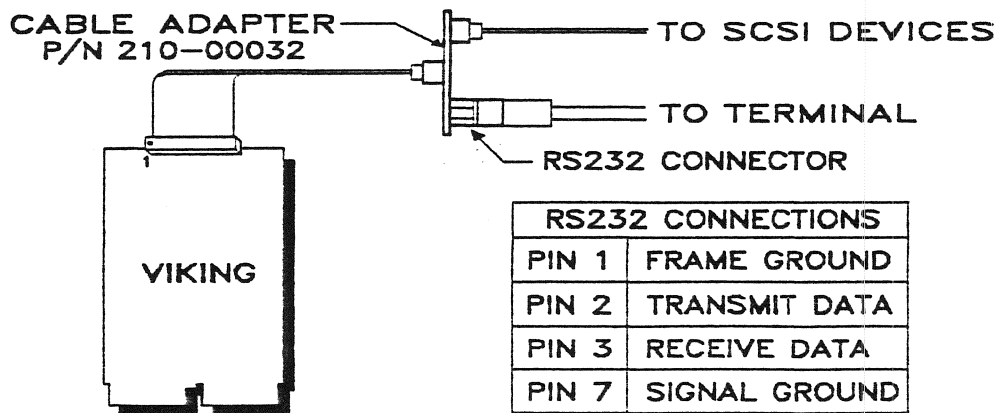

FIGURE 8
SERIAL PORT CABLE ADAPTER

Cable Type. SCSI devices are connected together by a 50-conductor 'daisy-chain' cable. Most SCSI devices have connectors that accept mass-terminated flat cable. This cable may be shielded or unshielded. Shielded cable is preferred when the cable length is long, or when operating in an electrically noisy environment.

Cable Length. The maximum length for a SCSI single-ended cable is 6 meters (18 feet). In general 'the shorter the better' is a good rule to follow, as this minimizes cable delays and noise pickup.

Stub Length. SCSI requires that the 'stub' length (see Figure 7) of any connection be less than 0.1M (3.6 in). Excessive stub length will adversely affect the electrical characteristics of the SCSI bus, often causing erratic operation and random data errors.

Termination. Each end of the SCSI cable must be terminated with a resistor network. This means that the devices connected to the middle of the cable must have their terminators (if any) removed. It is recommended that the Viking be at one end of the cable because its terminators are non-removable.

Terminator Power. The terminating resistor networks require +5V. The Viking's terminators are powered directly by the Host system's +5V supply. Fused +5V is available on pin 26 of the Viking SCSI connector for powering external terminations. The fuse may be removed for applications that don't require the +5V.

2.5.2 Cabling with an Optional Adapter Panel

An optional adapter panel (Part no. 210-00032) is available. This panel accomplishes two things: 1) allows for easier cabling to external mass storage subsystems, and 2) provides a serial RS232 connector for access to the Viking's diagnostic and utility programs. The panel may be permanently mounted in one of the small I/O cutouts of a DEC BA23 or BA123 cabinet.

To connect the Viking to a controller with the adapter panel, simply run one cable from the Viking 50-pin connector to the 50-pin connector on the rear of the adapter panel. This is the connector on the side OPPOSITE the RS232 connector. The controller may now be cabled to the 50-pin connector on the front of the adapter. Refer to Figure 8.

Fused terminator power with a series diode is provided on pin 26 of the controller connector. If terminator power is not desired, the diode may be removed. It is located on the rear of the adapter panel.

The serial RS232 port will work with any terminal that is set up to support asynchronous serial communications with the following characteristics: 9600 baud, 8 data bits, one stop bit, no parity. The RS232 pinouts are given in Figure 8. Generally, a 'null modem' cable is required to connect to the terminal. This is simply a cable that that connects the transmit data signal on one end to the receive data signal on the other, and vice versa. Check your terminal's manual for specifics.

SECTION 3: OPERATION

3.1 POWER-UP

On power-up the Viking executes a series of self-tests and displays the results via its LED. The LED is beside the 50 pin SCSI connector.

3.1.1 Self-test Sequence

ROM test: A ROM checksum test is performed to verify ROM contents and processor functions.
RAM test: The on-board RAM is thoroughly tested.
Buffer and I/O: The high-speed buffer RAM is tested, the SCSI interface chip is initialized and tested.

3.1.2 Normal LED Power-on Sequence

ON 1 second: ROM test.
OFF 1/2 second: RAM test.
ON 1/4 second: Buffer and I/O test.
ON DIM: Tests passed, waiting for Host initialization.

3.1.3 LED Failure Indications

Always OFF: Board dead.
1 FLASH/sec: ROM failure.
2 FLASH/sec: RAM failure.
4 FLASH/sec: Buffer or SCSI failure.

3.1.4 Normal LED Indications after Self-Test

ON DIM: Offline, waiting for Host initialization.
OFF: Online, inactive.
ON BRIGHT: SCSI activity.

3.2 AUTO-CONFIGURATION

In its default auto-configure mode, each Viking port assigns MSCP unit numbers to SCSI devices based on the following auto-configure method, starting with unit 0 or the user-selected beginning unit number (see Paragraph 3.5) on each port:

- 1) Find the first SCSI controller that responds to device selection. Start with SCSI address 0 and work up to 7. Skip the Viking's host adapter address (normally=7).
- 2) Determine if the first drive on a responding controller is an appropriate device type: that is it exists, is a disk (or tape) and is a full SCSI implementation.
- 3) If the device is configurable, assign it the next unit number. Test the device to determine if it supports parity and disconnect. Enable/disable accordingly.
- 4) Advance the unit number, repeat steps 2 and 3 for the next device on the controller. If the next device doesn't exist, advance to the next SCSI address and repeat step 1.

There are several constraints on this auto-configure method:

- 1) The SCSI devices must support the following commands:
 - Request sense (extended)
 - Inquiry
 - Read capacity (disks)
 - Read block limits (tape)
 - Mode sense/select (tape)
- 2) A maximum of two drives per controller is allowed.
- 3) A disk port can support a maximum of eight (8) units.
- 4) A tape port can support a maximum of eight (8) units unless the Viking is a disk/tape model, in which case the maximum is four (4) units.
- 5) No disk partitioning is supported.

3.3 MODEL QDA BOOTSTRAP

An optional onboard bootstrap is implemented on the Viking QDA. It may be enabled by installing option plug 4 (described in Paragraph 2.2.5 above). Once enabled, one of two boot addresses may be selected with option plug 3. The following limitations apply:

- 1) If the host system has an LSI-11, 11/23, or 11/73 processor, either Viking boot address may be selected. Make sure that the selected address does not conflict with existing bootstraps on other boards.
- 2) If the Host system has a processor with an internal bootstrap (an 11/23+, 11/53, or 11/83), the Viking boot address must be set to 771000.
- 3) The Viking disk port address MUST be set to DEC's standard 'DU' address (772150). Other bus addresses will not boot.
- 4) Bootstrap routines are provided for 'DU' and 'DL' devices only. The DL controller must be set to its standard address (774400).

3.3.1 Running the Onboard Bootstrap

The onboard bootstrap may be started automatically on power-up (refer to the DEC processor manual for power-up options), with a front panel 'BOOT' switch, or manually by halting the processor and restarting it at the selected bootstrap address. Once started, the bootstrap program displays a countdown message and then attempts to boot from DU0.

```
3.....2.....1.....  
Booting from DU0
```

If any key is struck during the countdown, the boot prompt will be displayed. The user may now enter the desired DU or DL unit to boot from by typing 'DUn<CR>' or 'DLn<CR>'.

3.3.2 Running DMON from the Bootstrap

The Diagnostic Monitor (DMON) may also be started from bootstrap. Simply type 'V<CR>' in response to the bootstrap prompt, then another <CR> to get the DMON prompt.

3.4 RUNNING THE ONBOARD UTILITIES

The Diagnostic Monitor (DMON) is a set of programs that are resident in the Viking and provide the user with the tools necessary to configure the Viking, set up SCSI devices that are attached to it, and format/verify disk drives. DMON may be run either offline with any RS232 serial terminal, or with the QDA on MicroPDP/LSI-11 systems, directly through the system console.

3.4.1 Offline with an RS232 Terminal

Connect the terminal to the RS232 connector of the breakout panel. Refer to Paragraph 2.5.2 and Figure 8 for connector pinouts and cabling information. Power the system up and verify that the Viking has passed its self-tests. Now press any key on the terminal. The screen will display the DMON sign-on message with Viking model and serial number followed by the DMON prompt.

3.4.2 Using the System Console (Viking QDA Only)

The Diagnostic Monitor (DMON) may also be started from bootstrap. Simply type 'V<CR>' in response to the bootstrap prompt, then another <CR> to get the DMON prompt.

3.4.3 DMON Commands

Typing H<CR> in response to the DMON prompt will display a brief menu of commands:

```
Command list:
  A  Abort MSCP
  C  Display configuration
  D  Display SCSI devices
  F  Format unit
  M  Mode sense/select
  R  Read block
  S  SCSI command
  T  Test menu
  V  Verify unit
  W  Write block
  X  Cold start exit
```

All DMON commands are initiated by typing a single letter followed by a Carriage Return <CR>. Letters may be either upper or lower case. When typing a command or any other input to DMON, the following special characters are recognized:

```
Control C <CTL C>  Aborts the command and returns to
                   the DMON prompt.
Delete <DEL>       Deletes the last character typed.
```

When DMON requests a numerical value during a command, it may need either a decimal (D) value or a hexadecimal (X) value and will so indicate:

```
Enter cylinder (D)= 12345
Enter command byte (X)=
```

In the decimal case above, responding with just a <CR> will preserve the current value '12345'. In the hexadecimal case where no current value is displayed, just a <CR> will enter the value '0'. This is true for both decimal and hex values.

When the command is one that references a SCSI controller and drive, DMON will first ask for the target ID (SCSI address) of the controller, and then for the LUN (SCSI logical unit number, usually the same as the drive number) of the drive. For devices with embedded SCSI controllers, this value will be 0.

Most of the commands are self-explanatory. Note that the Read/Write Block, Verify, and Format commands apply only to disk drives. Refer to the Viking Technical Manual (900-00031) for detailed information on commands and Viking configuration options.

3.5 CONFIGURATION OPTIONS

Two configuration options are available for all Viking models. The options are accessed via the DMON utility using the 'C' command.

3.5.1 First Unit Offset

This option allows the user to specify the unit number of the first unit on the selected port. The offset may be set to any value from 0 to 7. A different offset may be specified for each port of a two-port board (QDT or UDT). Normally this feature is used in the Autoconfigure mode to accommodate installations in which the operating system requires sequential (or unique) unit numbers over several controllers. When used with Autoconfigure, any additional units would be assigned unit numbers in ascending sequential order. Example: if the first unit is selected to be Unit 6, the second unit would be unit 7, etc. Once set, the starting unit number is saved in non-volatile memory and retrieved on subsequent power-ups.

Example: The following is a description of how you would enter a unit offset of 3, but leave the port in Autoconfigure mode. The first drive on the SCSI bus will appear as Unit 3 to the Host system, and any additional drives will be numbered in sequence (4, 5, etc.). Start by getting the onboard diagnostics running. Then do a 'C' command. After the current configuration is displayed, enter the following answers in response to the questions shown:

Change host adapter parameters? (Y/N) N

Change port configuration? (Y/N) Y

Enter unit number (0-7) of first unit= 3

Autoconfigure? (Y/N) Y

Save new configuration? (Y/N) Y

The new configuration will take affect after the next power-up, or you can type 'X' to restart the Viking.

3.5.2 Manual Configuration of Ports

Both tape and disk ports may also be manually configured. This option disables Autoconfigure mode and lets the user force the Viking to configure units at specific SCSI addresses and LUN's. Furthermore, a manually configured port will always report the units as existing, even if they are not physically attached to the SCSI bus.

Up to eight units may be manually configured on single-port boards (Viking models QTO, UTO, QDO, QDA and UDO). On disk/tape models (QDT and UDT) the limit is four units on either port. Once entered, the manual configuration is saved in non-volatile memory and will always appear to the Host system, even if the target drives are not attached. Manual configuration may be combined with a first unit offset to configure unit numbers from 0-10.

Example: The following is a description of how you would enter a fixed tape port configuration if you have one tape drive set to SCSI ID 0 and you wish to have it appear as unit 10. Start by getting the onboard diagnostics running. Then do a 'C' command. After the current configuration is displayed, enter the following answers in response to the questions shown:

Change host adapter parameters? (Y/N) N

Change port configuration? (Y/N) Y

Enter unit number (0-7) of first unit= 7

Autoconfigure? (Y/N) N

MU7 exist? (Y/N) N

MU8 exist? (Y/N) N

MU9 exist? (Y/N) N

MU10 exist? (Y/N) Y

Controller ID (D) = 0 (The SCSI address of the tape controller)

LUN (D) = 0 (The SCSI drive number of the tape drive)

Enable disconnect? (Y/N) Y (Normally enabled)

Enable parity? (Y/N) Y (Normally enabled)

Enable unbuffered mode? (Y/N) N (Normally buffered mode is enabled)

Save new configuration? (Y/N) Y

SECTION 4: PROBLEM SOLVING

4.1 GENERAL

The intent of this section is to aid you, the user, in dealing with problems that may occur with the Viking or associated equipment. It is not intended as a complete technical reference, but rather as a guide to approaching problems in a logical manner with the resources at hand. The section is written with VMS as a model, but the same procedure is applicable to any operating system.

If, after following the procedures suggested in this section, you still haven't solved the problem, contact your subsystem supplier or TD Systems for technical assistance. It will be of great help if you have the following information at hand:

1. Viking model, serial number and firmware version.
2. SCSI devices installed: manufacturers and models.
3. Operating system and version.
4. List of symptoms including console error messages.
5. Applicable error log entries.

4.2 DEBUGGING TOOLS

The following is a brief list of VMS commands that are useful in debugging problems with the Viking. DCL commands are shown prefaced with a '\$', while SYSGEN commands start with the SYSGEN> prompt.

\$ SHOW DEVICE

MSCP devices show up in two places in a SHOW DEVICE command. The 'port' devices PU (disk) and PT (tape) are the low-level MSCP ports accessed by the PUDRIVER. DU (disk) and MU (tape) devices are the actual mass-storage units controlled by the DUDRIVER and TUDRIVER respectively. SHOW DEVICE lists each device, its online/offline state, and its current error count. Port devices normally show an error count of one, corresponding to the first initialization. The online/offline status indicates whether the unit/port is available or not. It does not indicate the 'ready' state of the device.

\$ ANALYZE /ERROR

The error log utility allows the operator to obtain additional information on most types of port and unit errors. Adding the /INCLUDE= modifier restricts the display to certain classes of errors. Besides the obvious /INCLUDE=(DU,MU,PU,PT) options, two other error classes are of interest: /INCLUDE=UNSOLICITED and /INCLUDE=UNKNOWN.

SYSGEN> SHOW /UNIBUS

Lists all the I/O locations that respond to the processor and displays their contents. This is particularly useful in determining whether device addresses are correctly set.

4.3 CONFIGURATION PROBLEMS

This subsection outlines a debugging procedure to be used when devices attached to the Viking fail to appear in your system configuration. The procedure concentrates on new installations where there is a probability that the problem is a result of incorrect setup or installation. Sudden problems with existing installations are usually the result of a Viking or SCSI device failure, but the possibility of a bad cable or connector should not be overlooked, particularly if the problems cropped up after devices were moved or rearranged.

Power-up the system:

Viking passes self-tests? (see Paragraph 3.1)

NO: Viking failed.

SCSI devices pass self-tests (if applicable)?

NO: SCSI device failed.

Boot system, log into system manager account.

Run SYSGEN

Do SHOW /UNIBUS

Viking CSR at selected address?

NO: Recheck Viking address jumpers.

If jumpers OK, Viking failed.

CSR contents = Viking firmware version?

NO: Viking failed.

Exit SYSGEN

Do SHOW DEVICE P

Viking port in configuration?

NO: Problem is either that the CSR address is not correct for the system configuration or the system startup file does not configure the Viking devices. Redo the SYSGEN procedure described in Appendix A1 to verify the CSR address, and then examine the system startup file (usually SYS\$SYSTEM:STARTUP.COM) to make sure that the AUTOCONFIGURE ALL statement is being executed. If AUTOCONFIGURE ALL includes a /SELECT= modifier, add PU (disk) or PT (tape) as appropriate to the select list.

Viking port online?

NO: Error count incrementing every 30 seconds?

NO: Viking initialize error. Check for DMA grant continuity. On Q-Bus systems, make sure that Viking is positioned after any multi-level interrupt devices. If OK, Viking failed.

YES: Viking can find no devices to configure or is detecting a fatal SCSI bus error. Check SCSI cabling, SCSI device ID's, power.

Do SHOW DEVICE DU (disk) or MU (tape)

Expected unit(s) appear in configuration?

NO: Possible SCSI device failure or incompatible

device. Check SCSI cabling, SCSI device ID's, power.

4.4 DEVICE ERRORS OR ERRATIC OPERATION

Excessive device errors or erratic operation may be caused by a marginal component (Viking or SCSI device), or by 'environmental' problems such as heat, electrical noise, excessive cable length, improper termination, or poor power supplies. It is best to eliminate any environmental problems before proceeding further:

- Step 1. Check the power to your SCSI devices to make sure that it is within specification. Measure it while the device is actually operating, if possible.
- Step 2. Verify that your SCSI cable is properly terminated at each end, and that no other terminators are installed if there are more than two SCSI devices (including the Viking). Check the Viking's terminators to make sure that they are not cracked. Check socketed terminators to make sure that the resistor packs are securely inserted with no bent leads. Make sure that all terminators have terminator power applied.
- Step 3. Check that your drives are operating within their temperature rating. Remember that magnetic media are particularly susceptible to temperature extremes: most drives are rated for operation at 50°C (122°F) maximum.
- Step 4. Make sure that your SCSI cable is as short as possible, and dressed away from any electrically noisy components. This is particularly important with the older VAXs such as 11/780's and 785's which are fierce generators of EMI. Shielded cable is strongly recommended in all cases where an external SCSI connection must be made,

Having eliminated environmental problems as a cause, the easiest way to isolate faulty components is to swap them with known good ones. If this is impossible, gather as much information as you can (see the list in subsection 4.1) and contact your subsystem supplier or TD Systems for technical assistance.

4.5 VIKING AFFECTS OTHER DEVICES IN SYSTEM

Here we have two basic possibilities: one is that the Viking's CSR address or vector is conflicting with the other device's. The second is that the Viking's DMA rate results in 'Data Late' type errors from other devices.

4.5.1 Address or Vector Conflict

Redo the SYSGEN procedure described in Appendix A1 again. Do it first without including the Viking port(s), then again with the Viking port(s). Make careful notes of the changes in addresses AND vectors required to add the Viking. Often other devices will retain their original CSR addresses, but require that their vectors be changed.

For example, when adding a Viking QTO as the second 'TU81' in a Q-Bus system with DHV-11's, the DHV-11 CSR addresses will remain the same, but their vectors will change, requiring that the boards be removed from the system and their DIP switches reset. If this is not done, the system will configure the DHV's (because their CSR's are correct), but users will quickly complain that their terminals don't respond to keystrokes, because the DHV's vectors are assigned to the Viking.

4.5.2 Data Late Errors from Other Devices

Some I/O devices are quite sensitive to DMA latency (the amount of time from the point at which the device requests the bus to the point when it gains control of the bus), and will report errors if the latency is too long. For example, Unibus Ethernet controllers (DUENA's) are sensitive to Unibus NPR latency, and the Unibus Adapter tends to be somewhat slow in this area. Add to this a Viking doing a lot of data transfers, and occasionally the DEUNA may log errors. The same holds true of some older disk and tape controllers that have small data buffers.

The first step in solving this problem is to make sure that the Viking is installed AFTER these devices in the backplane, that is in a higher numbered slot. If this doesn't work, then the Viking's DMA burst count will have to be reduced. Refer to the Viking Technical Manual (900-00031) for details.

APPENDIX A: VMS NOTES

A1. VMS SYSGEN PROCEDURE

Each time a VMS system is booted, the VMS 'SYSGEN' utility is invoked to determine what physical I/O devices are present and to bring them online and attach their drivers. If the Viking is optioned with the correct port address(es), VMS will automatically detect and configure it. To determine the proper addresses for a Viking board in a VMS system, the user should use the SYSGEN 'CONFIGURE' utility:

1. On a running VAX/VMS system, log onto the system manager queue and run the SYSGEN utility:

```
$ MCR SYSGEN <CR>
SYSGEN>
```

2. Enter the CONFIGURE facility of SYSGEN as follows:

```
SYSGEN> CONFIGURE <CR>
DEVICE>
```

3. At the DEVICE prompt, enter the list of Q-Bus or Unibus options present in the VAX system. Make sure that each device count is correct and that MSCP disk and tape device counts include both existing devices and the new Viking MSCP ports. Refer to the table below for a list of common options and their DEVICE names.

For example, suppose you are installing a Viking QDT in a MicroVAX system with a TK50, an RD54, a DZV11, and a DEQNA Ethernet controller. The Viking QDT represents one 'UDA' disk port and one 'TU81' tape port, no matter how many drives are attached to it. Adding these to the existing devices, enter:

```
DEVICE> QNA          (one DEQNA)
DEVICE> DZ11         (one DZV11)
DEVICE> UDA 2        (two MSCP disk ports including Viking)
DEVICE> TU81 2       (two MSCP tape ports including Viking)
```

3. When all devices have been entered, press CTRL Z to end the input session and display the results. Each device will be listed along with its port name, CSR address, interrupt vector, and driver support status. The new Viking ports will be the last device of each type listed. For the Viking QDT in the above example, SYSGEN will display:

```
Device: UDA   Name: PUA   CSR:772150   etc.
Device: TU81  Name: PTA   CSR:774500   etc.
Device: QNA   Name: XQA   CSR:774440   etc.
Device: DZ11  Name: TTA   CSR:760100   etc.
Device: UDA   Name: PUB   CSR:760354   etc.
Device: TU81  Name: PTB   CSR:760444   etc.
```

4. The Viking may now be optioned for the correct address and installed in the system. Again using the example of a Viking QDT, the correct addresses are shown below. Note that the Viking's interrupt vectors are programmable and not selected by option jumpers.

Viking disk port: Address= 760354
 Viking tape port: Address= 760444

SYSGEN DEVICE TABLE:

	Physical Device Name	VMS Device Name	Sysgen 'DEVICE' Name
Disk:	Viking	DU	'UDA'
	RQDXn	DU	'UDA'
	UDA50	DU	'UDA'
	KDA50	DU	'UDA'
	RRD50	DU	'UDA'
	RL11,RLV11/12	DL	'RL11'
	RX11,RXV11	DX,DY	'RX211'
	RK06	DM	'RK611'
Tape:	Viking	MU	'TU81'
	TU81	MU	'TU81'
	TK50	MU	'TU81'
	TS11,TSV11	MS	'TS11'
	TU58	DD	'TU58'
Comm:	DEUNA	XE	'UNA'
	DEQNA	QE	'QNA'
	DZ11,DZV11	TT	'DZ11'
	DH11	YH	'DH11'
	DHV11	TX	'DHV11'
	DMF32	TX	'DMF32'
	LP11	LP	'LP11'
	CR11	CR	'CR11'
	DR11W	XA	'DR11W'

A2. VMS BACKUP COMMAND SWITCHES

BACKUP QUALIFIERS:

/IMAGE

Produces a functionally equivalent copy of the input volume on the output volume. Copies all the files on the input volume... no file selection qualifiers are permitted. Output volume must be mounted /FOREIGN. BACKUP/IMAGE to a disk will initialize the destination disk with the characteristics of the source disk unless the /NOINIT qualifier is used.

/PHYSICAL

Copies the entire input volume onto the output volume on a block-by-block basis, ignoring any file structure. Output volume must be mounted /FOREIGN. Note that this command copies the entire disk capacity regardless of how much of the disk is used.

/BUFFER_COUNT=n

Specifies the number of I/O buffers to be used in the backup operation. The default is 3. A maximum of 5 may be specified. Use of more buffers than the default may improve operation with streaming tape drives.

OUTPUT QUALIFIERS:

/NOCRC

Inhibits the calculation and storing of Cyclic Redundancy Check records on the output medium. The creation of these records requires considerable CPU overhead as well as tape overhead, and unnecessarily duplicates the error detection mechanisms of most tape controllers.

/GROUP_SIZE=n

BACKUP calculates and appends one error correction record to every group of 'n' data records, allowing it to correct one 'uncorrectable' read error in each group. The default is 10. A value of n=0 inhibits the entire process.

/BLOCK_SIZE=n

Specifies the output record size in bytes. The default for tape devices is 8192 (8 KBytes). The allowable range is 2048 to 65024 bytes. Larger block sizes may improve the performance of streaming tape drives, but may also cause problems at End-of-Tape if the controller's logical EOT occurs less than the specified block size before physical EOT.

EXAMPLE: \$ BACKUP /IMAGE /BUFFER_COUNT=5 DUA0: MUB0:name.bck -
/NOCRC /GROUP_SIZE=0 /BLOCK_SIZE=32768

This example produces an image backup with no CRC records, no error correction records, and a block size of 32 KB. This set of command switches will produce the most efficient image backup in terms of time required, but at the expense of BACKUP's normal error correction capabilities.

A3. PERSISTENT TAPE INITIALIZATION ERRORS

Before the VMS INITIALIZE utility writes to a tape, it attempts to read the tape's header records to test the accessibility, expiration date, and ownership fields. If it decides on the basis of the tests that the tape should not be initialized, it displays the error message 'MEDIUM IS OFFLINE'. Under some circumstances a blank tape may yield this error. In either case, the user may override the tests and force initialization by using the following command switches:

```
$ INITIALIZE /OVERRIDE=(ACCESS,EXPIR,OWNER) MUB0: name
```

A4. VMS CONSOLE ERROR MESSAGES

The following is a list of common VMS console error messages along with the corresponding error log status (if any) and the likely cause of the error.

Console message:	No Such Device Available
Error Log Status:	(No error log)
Source and reason:	Viking reports non-existent device
Console message:	Volume Is Not Software Enabled
Error Log Status:	(No error log)
Source and reason:	SCSI device reports Not Ready
Console message:	Medium is Offline
Error Log Status:	(No error log)
Source and reason:	See Paragraph A3 above.
Console message:	Parity Error
Error Log Status:	Data Error, Invalid Header (disk) Long Gap Encountered (tape)
Source and reason:	SCSI device reports Media Error or Blank Check
Console message:	(Fatal) Controller Error
Error Log Status:	Controller Error
Source and reason:	SCSI device reports Illegal Command, or Viking detects SCSI bus error.
Console message:	Position Lost (tape)
Error Log Status:	Controller Error
Source and reason:	SCSI device reports Illegal Command or Viking receives unexpected response from device. This message usually occurs with Fatal Controller Error.
Console message:	Invalid Buffer Length
Error Log Status:	Host Buffer Error
Source and reason:	Viking detects odd byte count (disk) or odd buffer address.

A5. SETTING DISK CLUSTER SIZE

WHAT IS A DISK 'CLUSTER'?

For a Files-11 structured disk the disk's 'cluster size' is the basic space-allocation unit. The cluster size is set to some number of virtual disk blocks (virtual blocks are always 512 bytes long for MSCP disks) when the disk is initialized. Thereafter, VMS allocates space on the disk in 'cluster-size' chunks and keeps track of allocated space using a bit map in which each bit corresponds to one cluster. The bit map is stored on the disk and cannot be larger than 255 disk blocks. If the disk is large and the cluster size is small ('1' for example) there could be too many clusters to fit in the available bit map space, and the allocation mechanism would fail.

WHAT CLUSTER SIZES CAN BE USED?

The range of possible cluster sizes depends on the disk capacity. For a disk with a capacity of 'N' 512-byte blocks (or the equivalent in other physical block sizes) the smallest cluster size that can be used is $N/255*4096$ (N divided by 1,044,480). If this is a fractional value, it must be rounded up to the next greater integer. Example: the disk capacity (N) is 1,680,234 512-blocks (860MB). The minimum cluster size is calculated to be 1.61 which must be rounded up to 2. The largest cluster size is $N/100$.

WHAT CLUSTER SIZE IS APPROPRIATE?

In selecting the cluster size you trade off wasted space at the ends of files (if the cluster size is set large) versus increased bit map size and file fragmentation (if the cluster size is set small). The appropriate size will depend on the specific system in which the disk is installed and the uses to which the disk will be put.

For disks with physical block sizes LARGER than 512 bytes, the cluster size should be set to an even multiple of the physical size in order to maximize Viking performance. Example: a disk has 1024-byte blocks. Set the cluster size to 2 (2 x 512 = 1024) in order to force VMS to allocate disk space on even 1024-byte block boundaries.

USING THE INITIALIZE COMMAND TO SET THE CLUSTER SIZE

To initialize a disk and set the cluster size, use the VMS INITIALIZE command with the /CLUSTER_SIZE qualifier:

```
$ INITIALIZE /CLUSTER_SIZE=2 DUxx: volume_label
```

IMAGE BACKUPS AND CLUSTER SIZE

A cautionary note concerning disk-to-disk image backups to newly-initialized disks: the BACKUP /IMAGE command will by default re-initialize the destination disk, using the cluster size of the source disk. If the resulting cluster size on the destination disk is incorrect, VMS will so indicate with an error message that the CLUSTER SIZE IS INAPPROPRIATE. In order to retain the selected cluster size on the destination disk, use BACKUP with the /NOINITIALIZE qualifier:

```
$ BACKUP /IMAGE /NOINITIALIZE DUxx: DUyy:
```

APPENDIX B: ALTERNATE ADDRESS OPTION CHIPS

GENERAL

Several alternate address option chips (PAL's) are available for Viking disk-only and tape-only models. These PAL's provide new VMS-compatible CSR base addresses to supplement the standard ones. They may be used in installations where VMS SYSGEN requires a CSR address that is not supported by the standard address PAL. The alternates are listed below with the address options implemented with each.

ORDERING ALTERNATE ADDRESS CHIPS

Specify the designation of the desired alternate address chip: 'DO-2' for disk-only Vikings; 'TO-2' or 'TO-3' for tape-only Vikings.

Q-BUS INSTALLATION

Remove the standard address PAL from its socket at location E4. Carefully insert the new PAL into the socket with pin 1 in the same orientation. Pin 1 is at the corner with the embossed dot. Do not go by the PAL label orientation.

UNIBUS INSTALLATION

Remove the standard address PAL from its socket at location E24. Carefully insert the new PAL into the socket with pin 1 in the same orientation. Pin 1 is at the corner with the embossed dot. Do not go by the PAL label orientation.

DO-2 PAL FOR VIKING QDO AND UDO DISK-ONLY MODELS

<u>PLUGS</u>	<u>1</u>	<u>2</u>	<u>3</u>	<u>DISK PORT ADDRESS</u>
	IN	IN	IN	772154 (System I/O page)
	IN	IN	OUT	760364 (Floating device)
	IN	OUT	IN	760370 (Floating device)
	IN	OUT	OUT	760374 (Floating device)
	OUT	IN	IN	772154 (System I/O page)
	OUT	IN	OUT	760454 (Floating device)
	OUT	OUT	IN	760554 (Floating device)
	OUT	OUT	OUT	760654 (Floating device)

(PLUG 4 is not used and may be IN or OUT)

TO-2 PAL FOR VIKING QTO AND UTO TAPE-ONLY MODELS

<u>PLUGS</u>	<u>1</u>	<u>2</u>	<u>3</u>	<u>TAPE PORT ADDRESS</u>
	IN	IN	IN	760704 (Floating device)
	IN	IN	OUT	760410 (Floating device)
	IN	OUT	IN	760510 (Floating device)
	IN	OUT	OUT	760610 (Floating device)
	OUT	IN	IN	760704 (Floating device)
	OUT	IN	OUT	760424 (Floating device)
	OUT	OUT	IN	760524 (Floating device)
	OUT	OUT	OUT	760624 (Floating device)

(PLUG 4 is not used and may be IN or OUT)

TO-3 PAL FOR VIKING QTO AND UTO TAPE-ONLY MODELS

<u>PLUGS</u>	<u>1</u>	<u>2</u>	<u>3</u>	<u>TAPE PORT ADDRESS</u>
	IN	IN	IN	774500 (Standard)
	IN	IN	OUT	760404 (Floating device)
	IN	OUT	IN	760444 (Floating device)
	IN	OUT	OUT	760504 (Floating device)
	OUT	IN	IN	774500 (Standard)
	OUT	IN	OUT	760410 (Floating device)
	OUT	OUT	IN	760450 (Floating device)
	OUT	OUT	OUT	760510 (Floating device)

(PLUG 4 is not used and may be IN or OUT)