

WANG

7302

**ASYNCHRONOUS
COMMUNICATIONS OPTION**

**Customer Engineering
Product Maintenance Manual**

741-0682

PREFACE

The purpose of this manual is to provide the Wang-trained Customer Engineer (CE) with instructions to operate, troubleshoot and repair the Wang Asynchronous Communications Option.

Third Edition (August 1984)

This reprint of Document 729-0682-A is now identified by document number 741-0682. The material in this document may only be used for the purpose stated in the Preface. Updates and/or changes to this document will be published as PUB's or subsequent editions.

This document is the property of Wang Laboratories, Inc. All information contained herein is considered company proprietary and its use is restricted to assisting the Wang-trained CE in servicing this Wang product. Reproduction of all or any part of this document is prohibited without the prior consent of Wang Laboratories, Inc.

TABLE OF CONTENTS

1.	INTRODUCTION	
2.	INSTALLATION	
2.1	Pre-Installation	1-1
2.2	System Requirements	2-1
2.3	Installation Procedure	2-3
2.4	Model 5526 Workstation With Option 5595-4 Specifications	2-6
2.5	Modem Requirements	2-7
3.	ASYNCHRONOUS COMMUNICATION SOFTWARE	
3.1	Teletype Emulation Description and Specifications	3-1
3.2	IBM 2741 Emulation Description and Specifications	3-5
3.3	TC Release 15.3T4 and 5.3T4	3-9
3.4	Asynchronous Emulator Operating Procedures	3-19
3-5	Software Corrections, Improvements, and Restrictions	3-26
3-6	Communications Software Description	3-34
4.	DIAGNOSTICS	
4.1	F13.0 and E13.0 System Checkout	4-1
4.2	Off-Line TC Asynchronous Diagnostics	4-1
4.3	On-Line System Test	4-1
4.4	General System Troubleshooting Hints	4-6
4.5	EIA Interface Test Set	4-10
5.	ENGINEERING CHANGE NOTICES (ECN's)	

LIST OF TABLES

<u>TABLE NO.</u>	<u>TITLE</u>	<u>PAGE</u>
2-1	Asynchronous Bell Modems	2-9
2-2	Modem Customer Options	2-11
2-3	Connector Pin Assignment	2-12
3-1	ASCII Code Set	3-30
3-2	IBM 2741 Correspondence Code Set	3-32

LIST OF APPENDICES

<u>APPENDIX</u>	<u>TITLE</u>
A	TC Workstation Bill of Material (BOM)
B	TC Workstation Electronic Schematics

LIST OF ILLUSTRATIONS

<u>FIGURE NO.</u>	<u>TITLE</u>	<u>PAGE</u>
2-1	Regulator Layout (PCB 7067)	2-4
3-1	Special TTY Keys	3-4
3-2	Special 2741 Keys	3-8

1

**INTRO-
DUCTION**

1. INTRODUCTION

The 5595-4 Asynchronous Communications Option provides the Wang Word Processing System (WWPS) with asynchronous communications capability. The 5595-4 Option includes a communications controller packaged inside a workstation and the special software to be loaded onto the system disk. With this hardware/software option and a suitable asynchronous modem to provide the interface to the telephone lines, the workstation can function as an interactive terminal to time-shared computer systems that support the Teletype or IBM 2741 Selectric Typewriter Terminal protocols. Also, the workstation can communicate to other terminals that support one of these widely used asynchronous protocols. The workstation equipped with this option can function as either as an editing workstation or a asynchronous communications workstation (but not simultaneously) and is completely independent of the normal operation of the other devices on the system.

A WWPS workstation with option 5595-4 and a compatible modem supports point-to-point, half-duplex communications over dial-up or leased networks. Acceptable line speeds include 110, 150, 200, 300, 600, or 1200 baud for the Teletype protocol, and 134.5, 300, or 1200 baud for the 2741 protocol.

During interactive communications, the workstation becomes a CRT-screen based Teletype or 2741 terminal with a fully active typewriter keyboard for on-line entry of control and data information. Information keyed in by the operator appears in normal intensity on the CRT and is transmitted character-by-character to the remote site. Information in the form of a document can also be transmitted from the system disk. Information received is highlighted on the CRT and can also be stored as a document onto the system disk.

2

**INSTAL-
LATION**

2. INSTALLATION

2.1 PRE-INSTALLATION PROCEDURE

Telecommunications system installation can be simplified a great deal if the few simple steps given below are observed:

- 1) If the customer requires a modem, check with Customer/Marketing representatives to ensure that the customer has ordered the right modem and options (refer to modem requirements in table 2.2) from a local telephone company or a private vendor.

NOTE:

Modem at local and at remote location must be of same type and compatible.

- 2) If the customer has ordered the proper modem then plan the TC installation the same day the modem is being installed. If modem installer is still present, make sure you check out the system in his presence because he can help you identify modem or telephone line problems.
- 3) If applicable, obtain the correct sign-on procedure and telephone number from the customer and verify it by calling data processing manager in charge at the remote computer location. Important: Also verify that the remote computer does support the emulation program your customer is going to use.

2.2 SYSTEM REQUIREMENTS

The minimum system requirements to provide a Wang Word Processing System, either a Editing Station, WP10A, WP20, or WP30, with Asynchronous Communications capabilities are the following items:

For modem connection:

1. A Model 5526 Editing Workstation (80 column) with Option 5595-4 (W.L. #177-9302)

OR

A Model 5526 Editing Workstation with Option 5595-4 and Horizontal Scroll Option (160 column) (W.L. #177-9302H)

2. A COM diskette (contains TC software)
 - A) COM 10A/20 diskette for use with either a Editing Station, WP10A, or WP20.
 - B) COM 30 diskette for use with a WP30.
3. A 12-foot, 25-pin RS-232-C compatible telecommunications cable (W.L. #220-0113).
4. 25-foot dual coaxial cable (W.L. #220-0148).
5. Asynchronous Modem (supplied by the customer).

For direct/local connection:

1. All of the above items except for the modem.
2. A Model 2227N Null Modem (W.L. #177-2227N).

OR

A Model 2228N Null Modem¹ (W.L. #177-2228N).
3. Another A 12-foot, 25-pin RS-232-C compatible telecommunications cable (W.L. #220-0113).
1. The 2228N should have the jumper installed to be compatible with the 2227N.

2.3 INSTALLATION PROCEDURE

2.3.1 SITE SELECTION

When selecting a site for the Asynchronous Communications Workstation, it is very important that it should be located close to the modem location so that a 12 foot TC cable can reach the modem.

It is not required or necessary to have the workstation near the Master Unit because, as with the other WWPS peripheral devices (printers, workstations, etc.), it can be up to 2000 feet from the Master Unit. The customer should be made aware of this fact and must order the appropriate length coaxial cable for the TC workstation (25 feet cable is standard).

A 115 VAC (230 VAC) power outlet must be available for the TC workstation and for the modem at the installation site.

2.3.2 D.C. VOLTAGE ADJUSTMENTS ON REGULATOR BOARD

Before operating the TC Workstation, D.C. regulated voltages must be checked or adjusted as required. Refer to figure 2.1 for pot locations on the 7067 regulator board for various regulated voltages.

ADJUST POT ON 7067 PCB	REGULATED VOLTAGE	LOCATION	ADJUSTED VOLTAGE RANGE
R4	+ 5 Volts	7227 PCB Test Point	+ 4.9 to + 5.1
R10	+12 Volts	7227 PCB Test Point	+11.8 to +12.2
R19	- 5 Volts	7227 PCB Test Point	- 4.9 to - 5.1
R16	-12 Volts	7067 PCB Pin 7 or H	-11.8 to -12.2

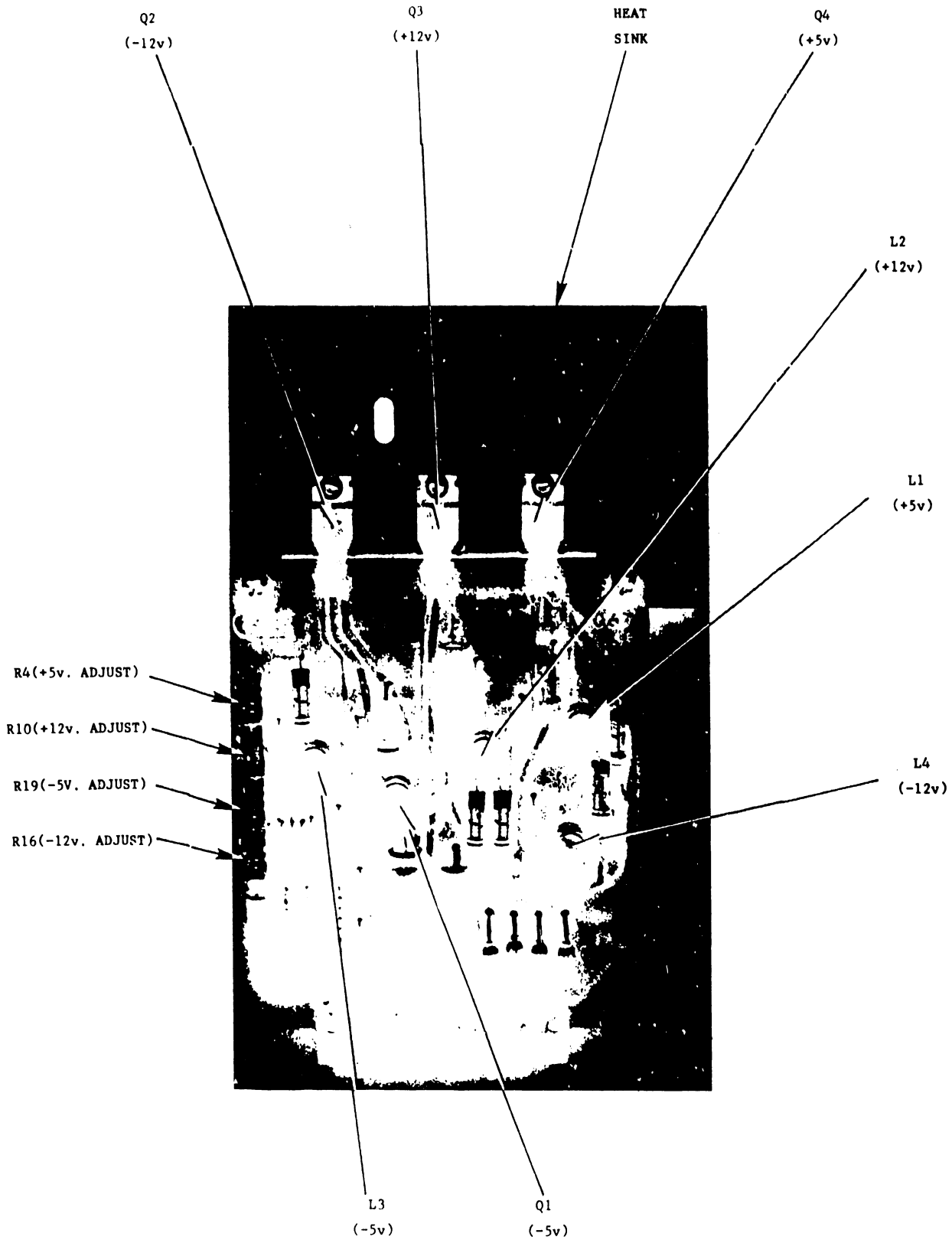

FIGURE 2.1 7067 REGULATOR LAYOUT

NOTE: These voltage test points are located on the upper left-hand component side of the 7227 PCB.

2.3.3. PORT ID SWITCH SETTINGS

PCB 7230 has a bank of five Port ID microswitches to be set as specified below. Their interpretation is a function of software, which uses them to identify a set of parameters stored on the system disk which defines the type of modem and line connected to the TC Workstation.

	1	2	3	4	5
ON		*			
OFF	*		*	*	*

2.3.4 INSTALLATION:

- 1) Connect the TC Workstation to one of the available channels on the rear of the Master Unit by a coaxial cable. (Check the cable for defects and perform continuity check.)
- 2) For Modem Connection:
 - A) Connect the supplied TC cable; one end to the RS-232-C connector on the TC Workstation (located on the right-hand side of the workstation's back panel), and the other end to the modem connector labeled "Customer Equipment".
 - B) Connect the modem and TC Workstation to a power outlet and turn both power switches on.

For Direct/Local Connection:

- A) Connect one of the supplied TC cable; one end to the RS-232-C connector on the TC Workstation (located on the right-hand side of the workstation's back panel), and the other end to one of the connectors of the 2227N or 2228N Null Modem.
 - B) Connect the other TC cable supplied; one end to the other side of the 2227N or 2228N Null Modem, and the other end to other systems RS-232-C connector.
 - C) Connect the TC Workstation to a power outlet and turn the power switch on.
- 3) Perform off-line TC diagnostic tests if available or perform on-line system test (refer to section 4.3)

2.4 MODEL 5526 WORKSTATION WITH OPTION 5595-4 SPECIFICATIONS

TC Workstation (80 column) (W.L. #177-9303)

P.C. Board Numbers:

210-7067 Power Supply Regulator Board
210-7227 Data Link Board (Device Type = Hex'1')

210-7230	TC Option Board (RS-232-C)
210-7236	24K Memory Board
210-7328	Motherboard (Chassis)
210-7425	CPU/CRT Control Board

TC Workstation with Horizontal Scroll Option (160 column) (W.L. #177-9303H)

P.C. Board Numbers:

210-7067 Power Supply Regulator Board
210-7227 Data Link Board (Device Type = Hex'2')

210-7230	TC Option Board (RS-232-C)
210-7236	24K Memory Board
210-7328	Motherboard (Chassis)
210-7335	Horizontal Scroll CPU/CRT Control Board

Height

13.5 in. (34.3 cm)

Width

19.75 in. (50.2 cm)

Depth

20.5 in. (52 cm)

Weight

54 lb (24.5 kg)

Display Size

12 in. diagonal (30.4 cm)

Power Requirements

115V or 230 VAC \pm 10%

50 or 60 Hz \pm 1 Hz

150 watts (510 BTU/Hr)

Fuse Rating

3 Slo-Blo for 115/230 VAC unit

2.5 MODEM REQUIREMENTS

The modem, or dataset, used with the system may be rented from the telephone company or purchased from any one of several modem vendors. In either case, the telephone company must connect the modem to the telephone network via telephone company installed data access arrangement (DAA). The DAA consists of a telephone handset and a modem interface rented from the telephone company. Usually a modem or DAA is permanently wired to a wall; therefore, it should be installed as close as possible to the Wang Word Processing system.

NOTE:

Ordering of a modem for a Wang customer is not the responsibility of a Wang Salesman nor is the installation of a modem the responsibility of a Wang Customer Engineer. Refer to table 2.2 for a list of the options that must be selected for each modem.

The modems used at both ends of a communications line must be compatible. For example, if a BELL 202S type modem is used at one end, another BELL 202S or equivalent must be used at the other end (not a 201A, 208B, 202C, or 201C). The modems listed in Table 2.1 or their equivalents may be used.

The TC Workstation conforms to the nationally recognized EIA RS-232-C and the internationally recognized CCITT V.24 standards for voltage levels and pin connections (refer to PRODUCT SERVICE TELEPROCESSING GUIDE, page 76). The signal polarity and the voltage of driven and detected signals are as follows:

<u>Logic Level</u>	<u>Applied Voltage</u>	<u>Detected Voltage</u>
0 or ON (Spacing)	+8 vdc	+3 to +25 vdc
1 or OFF (Marking)	-8 vdc	-3 to -25 vdc

The pin assignments are listed in Table 2.3 with both the EIA and the CCITT designations given for the circuit associated with each pin. Also, the signal descriptions and sources are included in the table.

TABLE 2.1
 ASYNCHRONOUS BELL MODEMS

<u>BELL MODEM</u>	<u>SPEED (BAUD)</u>	<u>DESCRIPTION</u>
103A	0 to 300	- obsolete - full-duplex (switched telephone network) - originate/answer
103F	0 to 300	- full-duplex (leased line) originate/answer
103J	0 to 300	- replaces 103A
113A	0 to 300	- obsolete - full-duplex (switched telephone network) - originate only (terminal data set)
113B	0 to 300	- obsolete - full-duplex (switched telephone network) - answer only (computer data set)
113C	0 to 300	- replaces 113A
113D	0 to 300	- replaces 113B
202C	0 to 1200	- obsolete - half-duplex (switched telephone network)
202D	0 to 1800	- obsolete - half or full-duplex (leased lines)
202R	0 to 1800	- obsolete - half or full-duplex (leased lines) - half-duplex (switched telephone network)

TABLE 2.1
 ASYNCHRONOUS BELL MODEMS (con't)

<u>BELL MODEM</u>	<u>SPEED (BAUD)</u>	<u>DESCRIPTION</u>
202S	0 to 1200	- replaces 202C and 202R - half-duplex (switched telephone network)
202T	0 to 1800	- replaces 202D and 202R - half or full-duplex (leased line)
212A	0 to 300	- full-duplex (switched telephone network)
	1200	- half-duplex (switched telephone network) - asynchronous or synchronous mode

TABLE 2.2
MODEM CUSTOMER OPTIONS

<u>Bell Modem or Equivalent</u>	<u>Options</u>
103A	-with/without permanent automatic answer -without automatic calling -with/without send space disconnect -with/without receive space disconnect -with common grounds (AA connected to AB)
103J	-all options listed for 103A -with/without loss of carrier disconnect -with CC (DSR) indication early -with CB (CTS) and CF (CD) indicators common -with CC (DSR) indication for analog loopback -without fail safe state of CN (Busy) circuit
113C	-all options listed for 103J
113D	-all options listed for 103J
202S	-with/without permanent automatic answer -without automatic calling -with common grounds (AA connected to AB) -with/without reverse channel -without local copy - primary or reverse channel
202T	-with/without reverse channel -with common grounds (AA connected to AB) -without local copy - primary or reverse channel -with/without alternate voice -with/without dial back-up

TABLE 2.3
RS-232-C CONNECTOR PIN ASSIGNMENTS

<u>PIN</u>	<u>EIA</u>	<u>CCITT</u>	<u>SIGNAL DESCRIPTION</u>	<u>SOURCE</u>
1*	AA	101	Protective Ground	
2*	BA	103	Transmitted Data	TC Workst.
3*	BB	104	Received Data	Modem
4*	CA	105	Request to Send	TC Workst.
5*	CB	106	Clear to Send	Modem
6*	CC	107	Data Set Ready	Modem
7*	AB	102	Signal Ground	
8*	CF	109	Received line Signal Detector	Modem
9				
10				
11*	SCA	120	Secondary Request to Send	TC Workst.
12*	SCF	122	Secondary Rec'd Line Sig. Det.	Modem
13	SCB	121	Secondary Clear to Send	Modem
14	SBA	118	Secondary Transmitted Data	TC Workst.
15*	DB	114	Trans. Signal Element Timing	Modem
16	SBB	119	Secondary Received Data	Modem
17*	DD	115	Receiver Signal Element Timing	Modem
18		124	Select Frequency Groups	TC Workst.
19*	SCA	120	Secondary Request to Send	TC Workst.
20*	CD	108.2	Data Terminal Ready	TC Workst.
21	CG	110	Signal Quality Detector	Modem
22	CE	125	Ring Indicator	Modem
23	CH/CI	111/112	Data Signalling Rate Selector	TC Workst./ Modem
24	DA	113	Trans. Signal Element Timing	TC Workst.
25			Unassigned	

*Denotes signals used by the TC Workstation.

3

**ASYNCHRONOUS
COMMUNICATIONS
SOFTWARE**

3. ASYNCHRONOUS COMMUNICATIONS SOFTWARE

3.1 TELETYPE EMULATION DESCRIPTION AND SPECIFICATIONS

The Western Union Teletype, one of the first terminals used for interactive communications with host computers, has become a standard for low speed interactive communications. Teletype or Teletype-like terminals operate in asynchronous mode (character-by-character transmission) with normal line speeds up to 1200 baud.

Wang's TC workstation, in conjunction with the Teletype Emulation software, allows the Wang Word Processing Systems (WWPS) to communicate with a wide array of devices which support the Teletype protocol. In addition to transmission from the TC workstation's keyboard and reception to the CRT screen, the Teletype emulator software allows for transmission of files (in the form of documents) to and from the system disk. Data and program files received from a host computer may be edited off-line by the TC workstation or any other workstation on the system and can also be queued to a printer later to provide a hard copy.

A TC workstation and a compatible modem supports point-to-point, half-duplex communications over dial-up or leased networks. Acceptable line speeds include 110, 150, 200, 300, 600, or 1200 baud for the Teletype emulator.

A function strip, supplied with the software for attachment on the TC workstation keyboard, identifies the special functions performed by the top row of keys during Teletype a communications session. Particular keys may be used to initiate document transmission from or reception to the system disk in a limited batch transmission environment. Other keys provide a convenient method of setting the desired communication parameters or transmitting a variety of ASCII control and graphic codes.

Emulation: Teletype emulation.

Package No.: Option 5595-4 (hardware and Teletype emulation software).

Line Discipline: Asynchronous point-to-point operation on a dial-up or leased private line (half-duplex).

Line Speeds: 110, 150, 200, 300, 600, or 1200 baud.

Connection: A Wang 2227N or 2228N null-modem may be used for local connections via the RS 232-C interface for distances up to 100 feet.

Using Short Haul modem and private lines, connection of up to 5 miles can be made.

For longer distances, Bell or equivalent type modems and acoustic couplers may be used on common carrier telephone lines. Refer to table 2.1 for a list of Bell modems.

Controller: Model 5526 Workstation with Option 5595-4 Asynchronous Communications Option.

Systems: Editing Station, WP10A, WP20, and WP30.

Code: The USASCII character set (refer to Table 3.1) is used for received and transmitted data. The character format is 7 data bits and one parity bit or 8 data bits and no parity bit, depending upon the type of parity selected.

Error Detection: No error detection is provided for received data and even, odd, or no parity can optionally be used for transmitted data.

Record Length: Reception - records are terminated by a carriage return and limited to 248 characters.

Transmission - records are terminated by a carriage return and when transmitted from the keyboard they are not limited to any length and when transmitted from the system disk they are limited to the document's format line length .

Communicates with:

- Any host computer system supporting Teletype protocol
(no modifications required).
- A Teletype-like terminal.
- Another Wang system with Teletype emulation.
- A device with a standard Teletype interface (RS-232-C)

Modes of Operation:

- Keyboard send and CRT receive are normally active.
- System disk receive selectable.
- System disk send.

Transmit From:

- System disk.
- Keyboard.

Receive To:

- System disk.
- CRT.

Options:

- Baud rate (110, 150, 200, 300, 600, or 1200).
- Parity (odd, even, or none).
- Disk send or receive (yes or no).

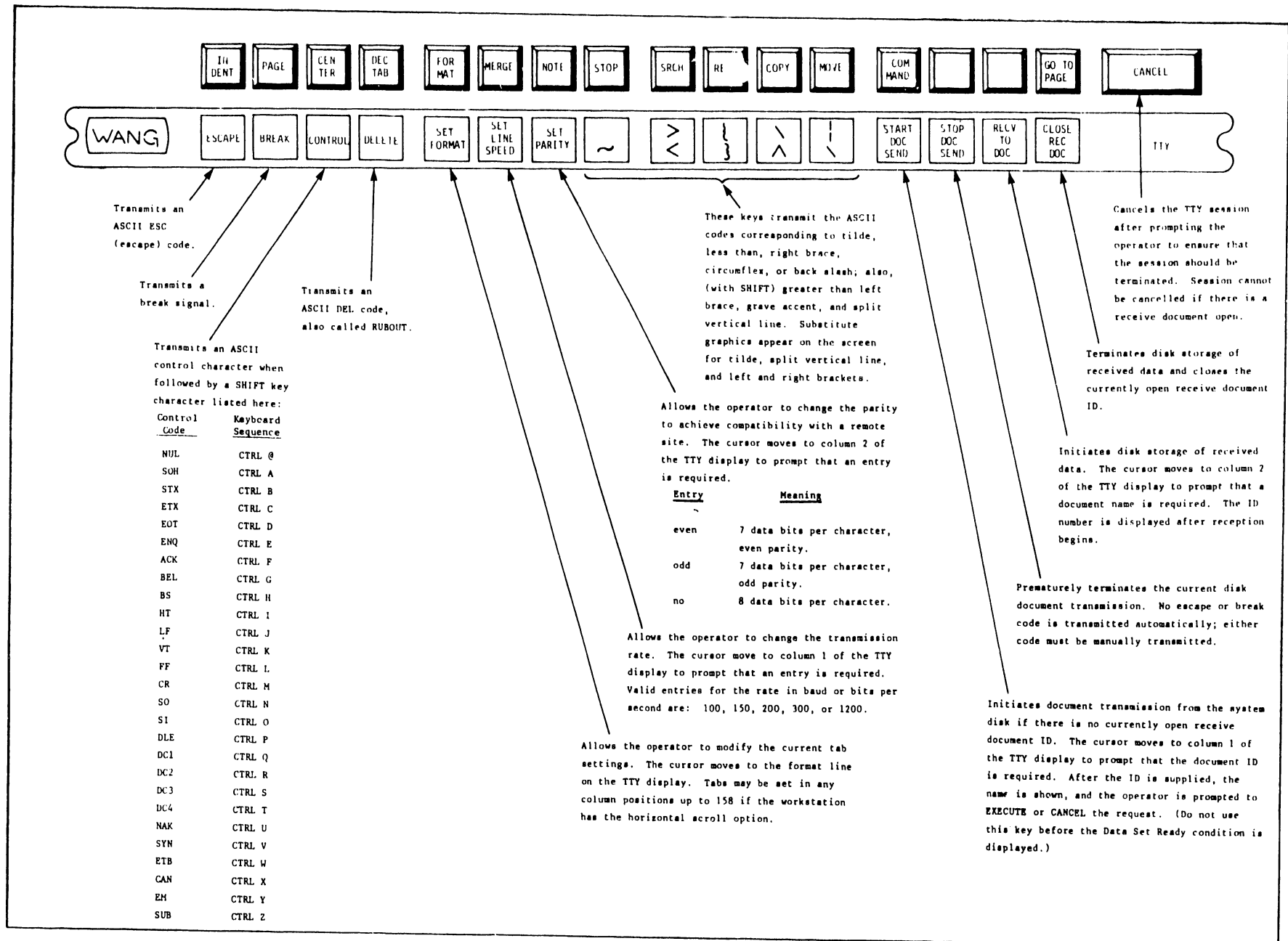

FIGURE 3.1 SPECIAL TTY KEYS

3.2 IBM 2741 EMULATION DESCRIPTION AND SPECIFICATIONS

The IBM 2741 Selectric Typewriter Terminal protocol, used for interactive communications with host computers, has become a standard for low speed interactive communications. 2741 or 2741-like terminals operate in asynchronous mode (character-by-character transmission) with normal line speeds up to 1200 baud.

Wang's TC workstation, in conjunction with the 2741 Emulation software, allows the Wang Word Processing Systems (WWPS) to communicate with a wide array of devices which support the 2741 protocol. In addition to transmission from the TC workstation's keyboard and reception to the CRT screen, the 2741 emulator software allows for transmission of files (in the form of documents) to and from the system disk. Data and program files received from a host computer may be edited off-line by the TC workstation or any other workstation on the system and can also be queued to a printer later to provide a hard copy.

A TC workstation and a compatible modem supports point-to-point, half-duplex communications over dial-up or leased networks. Acceptable line speeds include 134.5, 300, or 1200 baud for the 2741 emulator.

A function strip, supplied with the software for attachment on the TC workstation keyboard, identifies the special functions performed by the top row of keys during 2741 a communications session. Particular keys may be used to initiate document transmission from or reception to the system disk in a limited batch transmission environment. Other keys provide a convenient method of setting the desired line speed and tab positions, transmitting a 2741 ATTENTION code, or transmitting a variety of graphic codes.

Emulation: IBM 2741 emulation.

Package No.: Option 5595-4 (hardware and 2741 emulation software).

Line Discipline: Asynchronous point-to-point operation on a dial-up or leased private line (half-duplex).

Line Speeds: 134.5, 300, or 1200 baud.

Connection: A Wang 2227N or 2228N null-modem may be used for local connections via the RS 232-C interface for distances up to 100 feet.

Using Short Haul modem and private lines, connection of up to 5 miles can be made.

For longer distances, Bell or equivalent type modems and acoustic couplers may be used on common carrier telephone lines. Refer to table 2.1 for a list of Bell modems.

Controller: Model 5526 Workstation with Option 5595-4 Asynchronous Communications Option.

Systems: Editing Station, WP10A, WP20, and WP30.

Code: The Correspondence character set (refer to Table 3.2) is used for received and transmitted data. The character format is 6 data bits and 1 parity bit.

Error Detection: No error detection is provided for received data and odd parity is used for transmitted data.

Record Length: Reception - records are terminated by a carriage return and limited to 248 characters.

Transmission - records are terminated by a carriage return and when transmitted from the keyboard they are not limited to any length and when transmitted from the system disk they are limited to the document's format line length .

Communicates with: -Any host computer system supporting 2741 protocol
-A 2741-like terminal.
-Another Wang system with 2741 emulation.

Modes of active. -Keyboard send and CRT receive are normally active.

Operation: -System disk receive selectable.
-System disk send.

Transmit From: -System disk.
-Keyboard.

Receive To: -System disk.
-CRT.

Options: -Baud rate (134.5, 300, or 1200).
-Disk send or receive (yes or no).
-Tab settings.

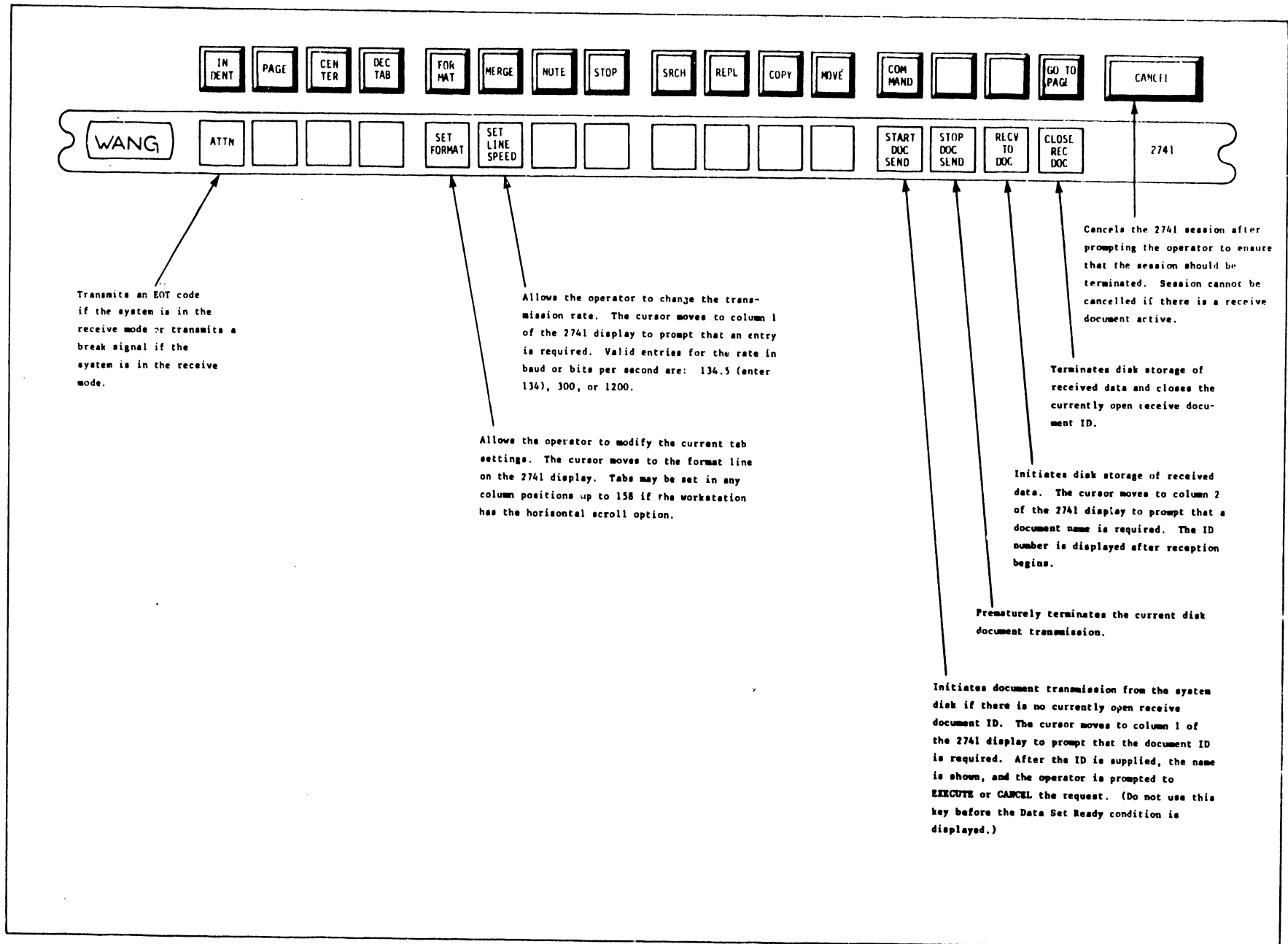

FIGURE 3.2 SPECIAL 2741 KEYS

3.3 TC RELEASE 15.3T4 and 5.3T4

3.3.1 INTRODUCTION

This release contains Asynchronous (Async) TC, Binary Synchronous (Bisync) TC, and Optical Character Recognition (OCR) software on the COM disk. The TC Function Selection allows the user to select the discipline(s) that are to be used at installation. The WPS, 2780, 3780, and Send to 2780/3780 disciplines use Bisync software and require a model 5528 TC processor while the TTY and 2741 disciplines are use Async software and require a TC Workstation. The model 5528 TC processor is also required for OCR operation.

3.3.2 PROCEDURE FOR LOADING COMMUNICATIONS ONTO AN EDITING STATION/WP10A/WP20

Three disks are involved in preparing for communications on a Editing Station, WP10A, or WP20: a Utility Disk (currently 15.3/4.3), a blank new disk which will become the System Disk with Communications, and Communications Master Disk called COM 10A/20 (currently 15.3T4).

NOTE:

The COM 10A/20 Release 15.3T4 can ONLY be used with all Word Processing Software Releases 15.1 and above on Editing Station or WP20 and 4.1 and above on WP10A.

1. Archive all documents. Make note of next available DOCUMENT and FLOPPY ID numbers. Remove both old System and Archive disks. Place a blank new disk with a write tab in the left (Archive) drive, and depressing the indented RESET button on the Master Unit.
2. Select "CREATE SYSTEM DISK-INITIAL IDS & FORMAT" by moving the cursor with the space bar, and then keying Execute twice (this operation will take approximately 1 minute).

NOTE: Do not use "CREATE SYSTEM DISK - OLD IDS & FORMAT"

3. Leave the newly created system disk in the left drive. Select "CHANGE IDS & STANDARD FORMAT". Follow menu instructions inputting document and floppy ID's noted in step 1.
4. Remove the Utility Disk from the right drive.
5. Load the COM 10A/20 Disk by placing it in the right (System Drive), and depressing the indented RESET button on the Master Unit.

NOTE: THE COM 10A/20 DISK WILL NOT LOAD UNLESS IT HAS A WRITE TAB ON IT.

6. Fill in the date and time on the start-up menu. The first set-up menu will now appear as shown below:

- Network Editing
- TC Function Selection
- TC System Updating
- OCR System Updating
- Other Functions

"Network Editing" is not available for this release.

"TC Function Selection" allows the user to select the desired discipline(s) which will be later transferred from the COM Disk to the System Disk by "TC System Updating".

"TC System Updating" allows the user to load the software for the selected discipline(s) onto the System Disk.

"OCR System Updating" allows the user to load the OCR software onto the Systems Disk.

"Other Functions" allows the user to access SZAP from the COM disk (enter 1776! as the authorized code)

7. Select the "TC Function Selection" by moving the cursor with the space bar and then keying Execute. Another menu will appear as shown:

Please Select up to 3 functions:

```
    1  2  3
None . . .
TTY Emulation . . .
2741 Emulation . . .
WPS/2780 Emulation . . .
WPS/3780 Emulation . . .
WPS/Send to 2780/3780 . . .
```

"TTY Emulation" selects software for Teletype emulation.

"2741 Emulation" selects software for 2741 emulation (both host and terminal version).

"WPS/2780 Emulation" selects software for 2780 emulation and WPS-to-WPS connection.

"WPS/3780 Emulation" selects software for 3780 emulation and WPS-to-WPS connection.

"WPS/Send to 2780/3780" selects software for transmitting to a 2780/3780 terminal and WPS-to-WPS connection.

8. To select and different discipline(s), use the space bar to position the cursor along side the desired discipline. The Return key allows the user to move to a different column to select another discipline. Up to three different selections may be picked. After the selections are made, key Execute to store the selections. The system will return to the set-up menu of step 6.
9. Select "TC system Updating". The following menu will be displayed:

- Copy Network and Software to System Disk
- Update Network on System Disk
- Update Network on Communications Disk

"Copy Network and Software to System Disk" copies the selected communications software onto the System Disk.

"Update Network on System Disk" updates the selected communications network (connection) on the System Disk. Do Not Use.

"Update Network on Communications Disk" updates the communications network (connection) on the COM Disk. Do Not Use.

10. Select the first choice "Copy Network and Software to System Disk" by keying Execute.

11. A prompt appears as follows:

Insert Communications Disk in System Drive

Insert System Disk in Archive Drive

(This is how the disk should already be positioned at this point if the instructions have been followed correctly. The COM 10A/20 disk should be in the right (System) drive and the newly created system Disk should be in the left (Archive) drive.

12. If the disks are positioned properly then key Execute. The movement of the Communications software onto the new System Disk should take less than one minute.

13. The Editing Station/WP10A/WP20 System Disk in the left drive now contains communications software. Remove it and label it "System Disk 15.3/4.3 with RSC COM 15.3T4.

14. The new system Disk with COM may now be placed in the right (System) drive, and the system can be initialized by depressing the indented RESET button on the Master.

NOTE:

The Communications and OCR Software takes up some of the available document space on the System Disk, and thus the "disk space message" at the bottom of the main menu will state that the disk is some % full with 0 documents depending on the discipline(s) selected.

15. Refer to ASYNCHRONOUS EMULATOR OPERATING INSTRUCTIONS in section 3.4 for operational procedures concerning the Communication Feature.

3.3.3 PROCEDURE FOR LOADING COMMUNICATIONS ONTO A WP30

Two disks are involved in preparing for communications on a WP 30: a Utility Disk (currently 5.3), and a Communications Master Disk called COM 30 (currently 5.3T4).

NOTE:

The COM 30 Release 5.3T4 can ONLY be used with all Word Processing Software Releases 5.1 and above.

1. ARCHIVE ALL DOCUMENTS. This is imperative as this procedure involves initializing the System Disk. It is the customer's responsibility to archive all documents of value. Make note of next available DOCUMENT and FLOPPY ID numbers. Remove any Archive disks in the Archive Drive. Load the Utility Disk by placing it in the Archive drive, moving the indented Utility Load Toggle Switch (located in the air vents on the front of the Master) to the UP position, and depressing the indented RESET button on the Master Unit.
2. Select "INITIALIZE SYSTEM DISK" by moving the cursor with the space bar, and then keying Execute twice (this operation will take a few minutes).
3. Select "CHANGE IDS & STANDARD FORMAT". Follow menu instructions inputting document and floppy ID's noted in step 1.

4. Remove the Utility Disk from the Archive drive.
5. Load the COM 30 Disk by placing it in the Archive drive, check that the indented Utility Load Toggle Switch is still up, and depress the indented RESET button on the Master Unit.

NOTE: THE COM 30 DISK WILL NOT LOAD UNLESS IT HAS A WRITE TAB ON IT.

6. Fill in the date and time on the start-up menu. The first set-up menu will now appear as shown below:

- Network Editing
- TC Function Selection
- TC System Updating
- OCR System Updating
- Other Functions

"Network Editing" is not available for this release.

"TC Function Selection" allows the user to select the desired discipline(s) which will be later transferred from the COM Disk to the System Disk by "TC System Updating".

"TC System Updating" allows the user to load the software for the selected discipline(s) onto the System Disk.

"OCR System Updating" allows the user to load the OCR software onto the System Disk.

"Other Functions" allows the user to access SZAP from the COM disk (enter 1776! as the authorized code)

7. Select the "TC Function Selection" by moving the cursor with the space bar and then keying Execute. Another menu will appear as shown:

Please Select up to 3 Functions:

None	.	.	.
TTY Emulation	.	.	.
2741 Emulation	.	.	.
WPS/2780 Emulation	.	.	.
WPS/3780 Emulation	.	.	.
WPS/Send to 2780/3780	.	.	.

"TTY Emulation" selects software for Teletype emulation.

"2741 Emulation" selects software for 2741 emulation (both host and terminal version).

"WPS/2780 Emulation" selects software for 2780 emulation and WPS-to-WPS connection.

"WPS/3780 Emulation" selects software for 3780 emulation and WPS-to-WPS connection.

"WPS/Send to 2780/3780" selects software for transmitting to a 2780/3780 terminal and WPS-to-WPS connection.

8. To select the different discipline(s), use the space bar to position the cursor along side the desired discipline. The Return key allows the user to move to a different column to select another discipline. Up to three different selections may be picked. After the selections are made, key Execute to store the selections. The system will return to the set-up menu of step 6.

9. Select "TC System Updating". The following menu will be displayed:

- Copy Network and Software to System Disk
- Update Network on System Disk
- Update Network on Communications Disk

"Copy Network and Software to System Disk" copies the selected communications software onto the System Disk.

Update Network on System Disk" updates the selected communications network (connection) on the System Disk. Do Not Use.

Update Network on Communication Disk" updates the communications network (connection) on the COM Disk. Do Not Use.

10. Select the first choice "Copy Network and Software to System Disk" by keying Execute.

11. A prompt appears as follows:

Insert Communications Disk in Archive Drive.

(this is where the COM 30 disk should already be positioned at this point if the instructions have been followed correctly.)

12. If the disk is positioned properly then key Execute. The movement of the Communication software onto the initialized System Disk should take less than one minute.

13. The WPS 30 System Disk is now updated with the latest release of the Word Processing Software (currently 5.3), and the latest Communications Software (currently 5.3T4).

14. The new System Disk with COM may now be initialized by moving the indented Utility Load Toggle Switch to the DOWN position, and depressing the indented RESET button on the Master Unit.

NOTE:

The Communications Software takes up some of the available document space on the System Disk, and thus the "disk space message" at the bottom of the main menu will state that the disk is 1% full with 0 documents.

15. At this point, the documents which has been archived can now be retrieved to the System Disk.
16. Refer to ASYNCHRONOUS EMULATOR OPERATING INSTRUCTIONS in section 3.4 for operational procedures concerning the Communication Feature.

3.3.4 ERROR MESSAGES ISSUED DURING TC SYSTEM UPDATING

The following codes are used to indicate during which operation(s) a message might be issued:

- 1 -- COPY NETWORK AND SOFTWARE TO SYSTEMS DISK
- 2 -- UPDATE NETWORK ON SYSTEMS DISK
- 3 -- UPDATE NETWORK ON COMMUNICATIONS DISK

- . ERROR: CANNOT READ/WRITE DISK IN ARCHIVE DRIVE
(1, 2, 3)
- . ERROR: CANNOT READ/WRITE DISK IN SYSTEM DRIVE
(1, 2, 3)
- . ERROR: CANNOT READ/WRITE SEALED DISK
(1, 2, 3)
- . ERROR: NO COPY -- CLEAR DOCUMENT AREA
(1)

All the documents on the Systems disk must be archived (using standard procedures) before retrying the operation.

Note: If the Systems disk had TC software and a network prior to the operation, they are lost.

ERROR: NO COPY/UPDATE -- UPDATE SYSTEMS DISK TO REV. XXXX
(1, 2, 3)

The label of both the Communications disk and the Systems disk, located at track 0 --sector 0, has a 4 character revision field at byte offset 5C. The above message is issued if the two revision fields are not compatible. To be compatible, the 1-st, 2-nd, and 4-th characters must be identical. (The revision displayed in the message is that of the Communications disk).

ERROR: NO UPDATE -- NEED MORE SPACE
(2)

There isn't enough space on the Systems Disk for the network to be copied from the Communications Disk, so space should be made available by archiving documents. Because there are no restrictions on the placement of the network, one may archive 1 or 2 documents at a time (using standard procedures) and retry the operation until it succeeds.

Note: If the Systems Disk has a network prior to the operation, it is lost.

ERROR: SYSTEMS DISK MUST HAVE TC SOFTWARE
(2, 3)

The selected operation can be performed only if the Systems disk already has TC software. The Systems disk label, at track 0 -- sector 0, has a TC flag at byte offset 1D. If the Systems disk has TC, then flag = FF; otherwise, flag = 00.

SORRY, TC SYSTEM UPDATING ALREADY IN PROGRESS
(1, 2, 3)

Only one work station can perform a TC maintenance operation at any given time.

3.4 ASYNCHRONOUS EMULATOR OPERATING PROCEDURES

3.4.1 PREPARING TO SEND OR RECEIVE

Successful communications with another site can be achieved if a few preliminary steps are taken before going on-line:

- 1) Check that the scheduled connection will be compatible with the requirements of the other site. Some considerations are:
 - A) Choose the proper connection either TTY, 274lh, or 274lt, to match the communications protocol used by the other end. Mismatches can cause unpredictable results.
 - B) Check that the other site supports the following operating parameters (refer to sections 3.1 or 3.2)

for Teletype: - half-duplex mode

- line speeds up to 1200 baud
- USASCII character set (data and control characters)
- 7 data bits with parity bit (odd or even), or 8 data bits with no parity bit.

for 274l: - half-duplex mode

- line speeds up to 1200 baud
- correspondence character set
- 6 data bits with odd parity error checking

- C) If modems are used, ensure that the modems at both end of the connection are compatible types. Refer to Section 2.5
- 3) If used, verify the correct telephone number and sign-on procedure for the remote site.

- 4) Prepare the documents to be transmitted in advance. The maximum record length of any document to be transmitted depends only on that particular document's format line. For example, if the document's format allows for 132 characters per line, then the maximum record length for that document will be 132. Thus, the records created from a document as it is transmitted are terminated by either a carriage return code or by the cursor wrap-around for a particular line.

3.4.2 SCHEDULING A TELETYPE TELECOMMUNICATIONS SESSION

The entire operating instructions for running a communications session consists of simply selecting the Telecommunications item on the WWPS Main Menu, and then filling out three brief Menus which are specifically related to TC.

PROCEDURE:

1. Begin with the main menu--

WANG WORD PROCESSING SYSTEM

Please select next activity:

- . Edit Old Document
- . Create New Document
- . Print Document
- . Special Print Functions
- . Document Index
- . Document Filing
- * Telecommunication
- . Other Functions

Select 'Telecommunications' and touch EXECUTE.

2. When the telecommunication menu appears--

Select Telecommunications Action

- * Schedule a Telecommunication Session
- . Cancel a Telecommunication Session
- . Display Telecommunication Session Request
- . Display Telecommunication Session Summary
- . Display Telecommunication Connections

accept the default choice, as shown, and touch EXECUTE.

3. The following display now appears:

Schedule a Telecommunication Session

Session: 0003A
Connection:

(An ID is supplied by the system; the cursor indicates an operator entry is required for the connection.)

Enter TTY and touch EXECUTE. ('Not a TC Workstation' appears if the workstation being used is not equipped with the asynchronous communications option)

4. The following display appears on the top of the screen:

Line Speed: 300	Parity: even	Data Set Not Ready
Send Doc ID	Receive Doc ID	
Doc Name	Doc Name	
Now on Page	Now on Page	Position 1
<u>!</u> 1.. .. .		

Initially the top line of the screen is blank. On the second line the default value for the line speed is set to 300 baud and the default value for parity is even. These default settings can be changed using the special TTY keys described in figure 3.1. The second line also displays the status of the modem interface signal Data Set Ready. Information relating to sending and receiving to the system disk, the session format line, and the present cursor position on the line is also displayed.

A function strip, supplied with the software, should be placed on the keyboard below the top row of keys. Use the clips and the knobs on the keyboard to fasten the strip on securely. The strip is labeled TTY on one side and 2741 on the other side. The function strip shows the new meanings which apply when a TTY session is scheduled. Refer to figure 3.1 for the explanation of these special functions.

NOTE: Before attempting to go on-line with the remote site, the desired line speed and parity must be set.

3.4.3 SCHEDULING A 2741 TELECOMMUNICATIONS SESSION

The entire operating instructions for running a communications session consists of simply selecting the Telecommunications item on the WWPS Main Menu, and then filling out three brief Menus which are specifically related to TC.

PROCEDURE:

1. Begin with the main menu--

WANG WORD PROCESSING SYSTEM

Please select next activity:

- . Edit Old Document
- . Create New Document
- . Print Document
- . Special Print Functions
- . Document Index
- . Document Filing
- * Telecommunication
- . Other Functions

Select 'Telecommunications' and touch EXECUTE.

2. When the telecommunication menu appears--

Select Telecommunications Action

- * Schedule a Telecommunication Session
- . Cancel a Telecommunication Session
- . Display Telecommunication Session Request
- . Display Telecommunication Session Summary
- . Display Telecommunication Connections

accept the default choice, as shown, and touch EXECUTE.

3. The following display now appears:

Schedule a Telecommunication Session

Session: 0003A

Connection:

3.4.4 ESTABLISHING A CONNECTION

After scheduling either a TTY, 274lt, or 274lh session an operator is ready to use the modem telephone to initiate a connection with the remote site. A typical procedure follows:

1. Depress the Talk button on the modem telephone.
2. Lift the handset from its cradle; then, dial the number of the remote facility. If a busy signal is heard, replace the handset and try again later. Otherwise, there are two cases to consider--

If the modem at the remote facility has an automatic answering capability, the device usually responds promptly and a high-pitched sound replaces the ringing signal. In such a case, depress the Data button on the modem telephone; then, replace the handset in the cradle.

If a person responds at the remote facility, leave the modem telephone in Talk mode. Ask the person whether the remote site is ready to communicate with the Wang Word Processor. When the remote site is ready, depress the Data button on the modem telephone and replace the handset in its cradle.

When the connection with the remote site is made via the modem, the data set message changes from 'not ready' to 'ready' automatically. Now the operator may transmit or receive information to/from the remote site.

3.4.5 TELETYPE OR 2741 ON-LINE COMMUNICATIONS

After the data set status is 'ready', the operator is ready to transmit or receive information.

NOTE: Do not attempt to communicate before the data set status is 'ready' as the workstation will become locked-up and will have to be powered off-and-on again to be freed.

The operating parameters must be set before the operator attempts to communicate with the remote site (refer to section 3.4.2 or 3.4.3). Transmitted data, whether from keyboard or disk, is displayed on the CRT in normal intensity, and received data is highlighted on the CRT.

Sending from the disk and receiving to the disk are mutually exclusive operations. If the operator attempts to transmit from the keyboard while reception is in progress, a 'Keyboard Locked' message appears. If the operator attempts to initiate transmission with the START DOC SEND key (or receive to a new document name with the RECV TO DOC key) before manually terminating reception with the CLOSE REC DOC key, a 'Recv Doc Active' message is displayed. Similarly, if an operator attempts to initiate reception to disk with the RECV TO DOC key while document transmission is in progress, a 'Send Doc Active' message is displayed. To terminate the communications session and return to the main Word Processing menu, use the CANCEL key and then the EXECUTE key. The session cannot be cancelled if a receive document is still active. The operator must use the CLOSE REC DOC key first and then the CANCEL key to terminate the session.

Specific instructions for interactive communications with a host computer system cannot be given here because the sign-on message and step-by-step procedure depend on the requirements imposed by the software resident at the time-shared host computer site. Documentation should be provided by the host computer facility to field service engineer so that the system may be on-lined tested.

3.5 SOFTWARE CORRECTIONS, IMPROVEMENTS, AND RESTRICTIONS

1. The following improvements and corrections for asynchronous emulators are included in the current release:

- a. Two new connections have been added for the 2741:
 - 2741t is for a 2741 playing the terminal role (Starts in Send mode. Turns line around after each record sent).
 - 2741h is for a 2741 playing the host role (Starts in Receive mode. In Send mode, turns the line around when there is nothing to send).
- b. A problem caused when the disk becomes full has been corrected. This problem could cause a workstation to blow up after the TC software encountered a disk full condition.
- c. Support for TTY-to-TTY transmission has been added. This support was distributed selectively as REV. 2.3D.
- d. Received DEL characters will be ignored, to correct a problem with the cursor when the DEL is the first character received. This problem will be fixed in a future release.
- e. For TTY, the graphics displayed for Greater Than, Less Than, Grave Accent, Circumflex, and Back Slash are now correct. Substitute graphics still appear for Tilde, Split Vertical Line, and Left and Right Brackets.
- f. The session cannot be cancelled if there is a receive document open.
- g. For both TTY and 2741, record length is not limited to the screen width.
- h. For both TTY and 2741, underlined characters are sent as a sequence: character, backspace, and underline.
- i. For both TTY and 2741, The Break signal is cut off after 200 ms.

- j. After hitting 'RECV TO DOC', it is no longer necessary to strike RETURN to enter receive mode.
 - k. The TTY no longer drops the line after the SET PARITY function.
 - l. For 2741, the keyboard can be unlocked by hitting the CANCEL key. (It is locked if the far end does not send an EOT.) Following the prompt 'Cancel Session', the CANCEL key returns the station to the Send mode - EXECUTE cancels the session.
 - m. It is now possible to use the BACKSPACE key while entering document names, etc.
 - n. For TTY, RETURN must be struck if the STOP DOC SEND key is hit in the middle of a line. For the 2741, this is not necessary.
 - o. If an EOT is received without a NL, a record will be formed. Note that EOT can be sent from a TTY by CONTROL D.
 - p. Blank lines are not longer sent at the beginning of a document after a STOP DOC SEND. This problem only occurred when STOP DOC SEND was hit in the middle of a line which was followed by blank lines.
2. The following restrictions for asynchronous emulators are included in the current release:
- a. For the TTY, receive Break is not supported.
 - b. When communicating between two TC workstations, one station must sometimes be put in the receive mode by hitting the ESCAPE key. This is especially true after starting a receive document.

- c. Occasionally, the system locks up (nothing can be sent or received) even though the Data Set status is shown as 'Ready'. The system must be restarted by turning the TC workstation off and on.

TABLE 3.1
ASCII CODE SET

		HIGH ORDER HEX DIGIT							
		0	1	2	3	4	5	6	7
L O W O R D E R H E X D I G I T	0	NUL	DLE	SP	0	@	P		p
	1	SOH	DC1 XON	:	1	A	Q	a	q
	2	STX	DC2 PN	"	2	B	R	b	r
	3	ETX	DC3 XOF	#	3	C	S	c	s
	4	EOT	DC4 PF	\$	4	D	T	d	t
	5	ENQ	NAK	%	5	E	U	e	u
	6	ACK	SYN	&	6	F	V	f	v
	7	BEL	ETB	'	7	G	W	g	w
	8	BS	CAN	(8	H	X	h	x
	9	HT	EM)	9	I	Y	i	y
	A	LF	SUB	*	:	J	Z	j	z
	B	VT	ESC	+	;	K	[k	{
	C	FF	FS	,	<	L	\	l	
	D	CR	GS	-	=	M]	m	}
	E	SO	RS	.	>	N	^	n	~
	F	SI	US	/	?	O	_	o	DEL

ASCII DATA LINK CONTROL CHARACTERS

ACK	Positive Acknowledgement
DLE	Data Link Escape
ENQ	Enquiry
EOT	End of Transmission
ETB	End of Text Block
ETX	End of Text
NAK	Negative Acknowledgement
SOH	Start of Header
STX	Start of Text
SYN	Synchronous Idle

ASCII FUNCTION CONTROL CHARACTERS

BS	Backspace
CAN	Cancel
CR	Carriage Return
DC1	Device Control 1
DC2	Device Control 2
DC3	Device Control 3
DC4	Device Control 4
EM	End of Medium
ESC	Escape
FF	Form Feed
FS	Field Separator
GS	Group Separator
HT	Horizontal Tab
LF	Line Feed (sometimes New Line)
NUL	Null
PF	Punch Off
PN	Punch On
RS	Record Separator
SO	Shift Out
SI	Shift In
SUB	Substitute
US	Unit Separator
VT	Vertical Tab
XOF	Paper Tape Reader Off
XON	Paper Tape Reader On

TABLE 3.2
IBM 2741 CORRESPONDENCE CODE SET

		<u>Lower Case</u>				<u>Upper Case</u>					
		HIGH ORDER HEX DIGIT									
		0	1	2	3	0	1	2	3		
LOW	0	SP	2	1]	3	SP	@	+	[#
	1	!	.	m	v		.	M	V		
ORD	2	t	n	x	u	T	N	X	U		
	3	j	=	g	f	J	+	G	F		
HER	4	4	z	0	⁹ EOA	\$	Z)	(EOA	
	5	o		s	w	O		S	W		
DIG	6	l		h	b	L		H	B		
	7	/		y	-	?		Y	-		
INT	8	5	6	7	8	%	c	&	*		
	9	'	i	r	a	"	I	R	A		
ALPH	A	e	k	d	c	E	K	D	C		
	B	p	q	;	,	P	Q	:	,		
CONT	C		UC		EOT		UC		EOT		
	D		BS	NL	IL		BS	NL	IL		
EOT	E			LF				LF			
	F		LC	HT			LC	HT			

2741 DATA LINK CONTROL CHARACTERS

EOA End of Address
EOT End of Transmission

2741 FUNCTION CONTROL CHARACTERS

BS Backspace
HT Horizontal Tab
IL Idle
LC Lower Case Shift
LF Line Feed
NL New Line (CR LF)
SP Space
UC Upper Case Shift

3.6 COMMUNICATIONS SOFTWARE DESCRIPTION

3.6.1 COM DISK PROGRAM MODULE LOCATIONS

RELEASE 15.1T2/5.1T2

COM Disk Map

<u>Module</u>	<u>Disk Address</u>
Black Box IPL	2F,01
WWPS to ASCII	2F,02
ASCII to WWPS	2F,03
TC Initial Load	30,00 - 30,09
TC Common	30,00 - 30,04
PL/M IPL	30,05 - 30,08
Move Rtn	30,09
Initiate Session	30,0A - 30,0F
Send IO Utility	31,00 - 31,03
Recv IO Utility	31,04 - 31,0D
WWPS to EBCDIC	31,0E
EBCDIC to WWPS	31,0F
Send File Utility	32,00 - 32,06
Recv File Utility	32,07 - 32,0A
Batch Driver Main	32,0B - 32,0F
Bisync Send Data U	33,00 - 33,05
Batch Driver-Send	33,06 - 33,0A
Batch Driver-Rcev	33,0B - 33,0F
Bisync Xmission U	34,00 - 34,0A
Menu 23 Overflow	34,0B
CSB - 1	34,0C
Establish Connection	34,0D - 34,0E
BCB - Async	34,0F
Bisync Recv Data U	35,00 - 35,05
Buffer Routines	35,06
MSL	35,07
Print Queue	35,08
QCB	35,09
Admin Block	35,0A
MDR	35,0B
QCB Initial	35,0C
SCB Initial	35,0D
MCB	35,0E
BCB - Batch Bisync	35,0F
PSB	36,00
Menus - 09	36,01 - 36,03
- 18	36,04 - 36,05
- 19	36,06 - 36,08
- 20	36,09 - 36,0A

- 21	36,0B - 36,0C
- 22	36,0D - 36,0E
- 23	36,0F (+34,0B)
Pak 4 -	37,00 - 39,09
Menus 6	37,00 - 37,0F
Menus 7	38,00 - 38,0C
Menus 8	38,0D - 39,09
Pak 5 - Menus 9	39,0A - 3A,09
Work Station IPL	3A,0A
Interactive Driver	3A,0B - 3A,0F
Async Xmission U	3B,00 - 3C,03
Spare	3C,04 - 3C,05
MCB - OCR	3C,06
BCB - OCR	3C,07
Admin Block - OCR	3C,08
SCB Initial - OCR	3C,09
OCR to WWPS	3C,0A - 3C,0F
OCR Xmission Utility	3D,00 - 3D,04
OCR Driver	3D,05 - 3D,06
WWPS to Corr	3D,07
Corr to WWPS (1)	3D,08
WWPS to Corr (u)	3D,09
2741 State Tables	3D,0A - 3E,02
TTY State Tables	3E,03 - 3E,0B
TTY XU (temp.)	3E,0C - 3F,0F

NOTE:

Disk Maps for the System Disk are not being distributed with this release because the maps vary according to the software selected. The MCB, whose format is shown in one in the 'TC Modules and Control Blocks' (Refer to Section 3.6.3), contains the disk addresses of all the remaining modules and control blocks. The address of the MCB itself is given in bytes OD-OE of Track 00, Sector 0E (the communications controller's IPL sector) of the System Disk, and in this release is located on the System Disk on Track 20, Sector 00 for the 20 and Track 2D, Sector 00 for the 30 (assuming no PIO).

3.6.2 TC WORKSTATION'S MEMORY LAYOUT

TC WORKSTATION'S MEMORY LAYOUT - RELEASE 5.3T4 OR 15.3/T4

First 8K		Second 8K		Third 8K	
0000	! <u>Interrupt</u> !	2000	! <u>SCB</u> !	4000	! <u>XU - Tables!</u>
0100	! <u>KB Trans.</u> !	2100	! !	4100	! !
0200	! <u>XU Work</u> !	2200	! <u>TC Common</u> !	4200	! !
0300	! <u>Space</u> !	2300	! !	4300	! !
0400	! <u>IO/FU Send</u> !	2400	! !	4400	! !
0500	! <u>Buffers</u> !	2500	! !	4500	! !
0600	! <u>FU/XU Send</u> !	2600	! !	4600	! !
0700	! <u>Buffers</u> !	2700	! <u>Driver</u> !	4700	! !
0800	! <u>IO/FU Recv</u> !	2800	! !	4800	! <u>not used</u> !
0900	! <u>Buffers</u> !	2900	! !	4900	! <u>XU - Code</u> !
0A00	! !	2A00	! !	4A00	! !
0B00	! !	2B00	! !	4B00	! !
0C00	! !	2C00	! <u>IO and FU</u> !	4C00	! !
0D00	! <u>XU/FU Recv</u> !	2D00	! !	4D00	! !
0E00	! <u>Buffers</u> !	2E00	! !	4E00	! !
0F00	! !	2F00	! !	4F00	! !
1000	! !	3000	! !	5000	! !
1100	! !	3100	! !	5100	! !
1200	! !	3200	! !	5200	! !
1300	! !	3300	! !	5300	! !
1400	! !	3400	! !	5400	! !
1500	! !	3500	! !	5500	! !
1600	! !	3600	! !	5600	! !
1700	! !	3700	! !	5700	! !
1800	! !	3800	! !	5800	! !
1900	! <u>not used</u> !	3900	! <u>FMT</u> !	5900	! !
1A00	! !	3A00	! <u>not used</u> !	5A00	! !
1B00	! !	3B00	! !	5B00	! <u>not used</u> !
1C00	! <u>BUR/STK</u> !	3C00	! <u>MCB</u> !	5C00	! !
1D00	! <u>not used</u> !	3D00	! <u>PGE</u> !	5D00	! <u>CT Send</u> !
1E00	! !	3E00	! <u>ASM</u> !	5E00	! <u>CT Recv L</u> !
1F00	! <u>BCB</u> !	3F00	! <u>PL/M Var.</u> !	5F00	! <u>CT Recv U</u> !

3.6.3 TC MODULES AND CONTROL BLOCKS

MODULES

Modules are classified by type. The type determines the memory in which the module executes, the conditions under which the module is invoked, and the availability of other modules and data to the modules of that type.

1. TC (Telecommunications Common) Type

These modules are common to all disciplines and operating modes.

- a) TC Loading - The Black Box IPL sector for Bisync and OCR, the TC Work Station IPL sector for the TC Work Station.
- b) TC Common - The TC Sequencer, which sequences through the phases of a session and loads the other modules in turn. Also includes subroutines to communicate with the Master for disk IO, disk space, inter-slave communication, etc.
- c) TC ASM - Assembly Language subroutines, currently only the Move Characters subroutine.

2. QD (Queue Driver) Type

These modules execute when no session is in progress, and perform pre-session on post-session processing involving operation on the QCB.

- a) PL/M IPL - This module is called in by the IPL sector to complete the IPL processing and the start a session if one is queued or this is an OCR box.
- b) Initiate - This module is called in after PL/M IPL and between sessions. After deleting any completed session from the queue, it initiates the next session or waits for a Start from the Master. Not used for OCR.

3. BD (Buffer Driver) Type

These modules execute during a session and drive the remaining session modules using the Buffer Control Block as the control mechanism.

- a) BD Establish - Invokes the Transmission Utility (XU) to initialize as necessary and wait for the Data Set Ready signal.
- b) Batch Driver Main - Invokes Send and Receive as appropriate during a batch session.
- c) Batch Driver-Send - Controls the Send portion of a batch session.
- d) Batch Driver-Recv - Controls the receive portion of a batch session.
- e) Interactive Driver - Controls sending and receiving of documents during an interactive session.
- f) OCR Driver - Controls receiving of documents for OCR.

4. IO (Input/Output) Type

These modules operate during a session.

- a) IO Send - Accesses documents during the send portion of a batch session. Not used for OCR.
- b) IO Receive - Stores documents during the receive portion of a batch session and for OCR.

5. FU (File Utility) Type

These modules operate during a session.

- a) FU Send - Performs file formatting operations (tabbing, centering, aligning, adjusting, etc.) on documents being sent. Not used for OCR.
- b) FU Recv - Performs file formatting operations (format line generation, sector formation, etc.) on documents being received. Not used for OCR.

6. DU (Data Utility) Type

These modules operate during a session (Bisync only).

- a) DU Send - Performs data and code translation on data being sent.
- b) DU Recv - Performs data and code translation on data being received.

7. XU (Transmission Utility) Type

These modules operate during a session.

Bisync XU - Sends and receives Bisync data.

Async XU - Interfaces with the user at the screen, sends and receives Async data.

OCR XU - Receives OCR data and formats it as a WPS document

8. CT (Code Translation Table) Type

- a) WWPS/EBCDIC
- b) EBCDIC/WWPS
- c) WWPS/ASCII
- d) ASCII/WWPS
- e) WWPS/Correspondence
- f) Correspondence/WWPS
- g) WWPS/OCR
- h) OCR/WWPS

9. BUR (Buffer Routine) Type

- a) Buffer Routines - subroutines to assign buffers to tasks.

10. Menu Type

These modules operate in the work station slave and process the TC menus.

CONTROL BLOCKS

1. Module Control Block (MCB) - one for the TC system and one for OCR. Contains the disk addresses of all other modules.
2. Session Control Block (SCB) - one for each session. Contains information about the session, including the session ID and the list of documents to be sent.

The SCBI contains initial values for the SCB, copied at session scheduling time. The OCR has its own SCBI containing the fixed values for an OCR "session".

3. Queue Control Block (QCB) - one for the system. For each port (currently only one), it gives the disk address of the currently active SCB. For each class of ports (also currently only one) it gives the count and head and tail pointers of the sessions queued for that class. Not used for OCR.

The QCBI contains the initial values for the QCB, copied at System IPL time by the WP Master. Not used for OCR.

4. Buffer Control Block (BCB) - one for Batch Bisync, one for Interactive Async, and one for OCR. Contains task and buffer control information and line status information.
5. Connection Specification Block (CSB) - one for each connection (currently 2780 and WPS). Specifies the discipline for that connection. Later will contain other information such as telephone number, etc. Not used for OCR.

6. Port Specification Block (PSB) - one for the system. Not used during system operation except as a link to the CSB's. Not used for OCR.
7. Print Queue Initial Block (PQI) - one for the system. Used to initialize the print request when documents are queued for printing.
8. ADMIN Initial Block (ADI) - one for the TC system and one for OCR. Used to initialize the ADMIN Block for non-WPS received documents.
9. Menu Display Block (MDB) - one for the system. Contains the English names for Baud rates and disciplines, for display on the menus. Not used for OCR.

.E0.	.CO.	.A0.	.80.	0
				1
				2
				3
				4
				5
				6
				7
				8
				9
				A
				B
				C
				D
				E
				F
				0
				1
				2
				3
				4
				5
				6
				7
				8
				9
				A
				B
				C
				D
				E
				F

.60.	.40.	.20.	.00.	3rd Port	BLOK	B
					NEXT	L 0
						O
						C
						K 1
						1
					BLOK	H
					END	E 2
						A
					BLOK	D
					TYPE	E 3
						R
					BLOK	I
					ID	4
						5
						6
						7
					BLOK	
					CODE	
					PORT	P
					ID	O 8
						R
					PORT	T
					TYPE	9
						G
					LINE	R
					SW	P A
					not	
					used	B
						/
				4th Port	CNN	12
					ID	C
						b
						y
						t
						D
						e
						s
						E
						p
						e
						r
						F
						p
						o
						r
						t
						/
						1
						2
						3
						4
					2nd Port	
						5
						6
						7
						8
						9
						A
						B
						C
						D
						E
						F

P
O
R
T

S
P
E
C
I
F
I
C
A
T
I
O
N

B
L
O
C
K

E0	C0	A0	80
		3rd cnn	0
			1
			2
			3
			4
			5
			6
			7
			8
			9
			A
			B
			C
			D
			E
			F
			0
			1
			2
			3
			4
			5
			6
			7
////			8
			9
			A
			B
		4th cnn	C
			D
			E
			F

60	40	20	00
		DISC	D BLOK
		ID	I NEXT
		CT ID	C I
			I KI 1
		DISC	L BLOK
		FLAGS	I END
		BAUD	E BLOK
			I TYPE
		2nd cnn	P BLOK
			E ID
		not used	I
		TERMID	C
			A
			I BLOK
			O CODE
			CNN
			ID
		SELECT	P
			A
			/ B
			40
			b C
			y
			t
			e D
			e
			p E
			e
			r
			F
		EXT	PORT
			TYPE
			nl
			SESS
			CODE
			e 1
			c
			ESTAB
			t
			i 2
			o
			DISC
			nl
			/ 3
			not
			used
			4
			5
			6
			7
			TEL
			NO
			8
			9
			A
			B
			C
			D
			E
			F

C
O
N
N
E
C
T
I
O
N

S
P
E
C
I
F
I
C
A
T
I
O
N

B
L
O
C
K

EO	CO	A0	80
//////	4th class	3rd class	0
			1
			2
			3
			4
			5
			6
			7
			8
			9
			A
			B
			C
			D
			E
			F
			0
			1
			2
			3
			4
			5
			6
			7
			8
			9
			A
			B
			C
			D
			E
			F

60	40	20	00
2nd class	PORT TYPE	C L	3rd port
	LINE SW	S S	
	CNN ID	G R	
	(for leased lines)	P	
	/	32	
	b	y	
	t	e	
	p	e	
	c	l	
	a	s	
	TOP IDLE	/	
	not used		
H CLASS Q	4th port	H	12
		PORT Q	b
			y
			t
			e
			s
			r
			f
			l
			0
			t
			1
			2
			3
			4
			5
			6
			7
			8
			9
			A
			B
			C
			D
			E
			F

Q
U
E
U
E

 C
O
N
T
R
O
L

 B
L
O
C
K

	-E0-	-C0-	-A0-	-80-
DISC ID	D 18th bce	I 14th bce	I 10th bce	0
CT ID	C I			1
DISC FLAGS	L I			2
BAUD	E I			3
PARITY	P I			4
not used	I P			5
TERMIN	I C			6
	I A			7
	I O			8
	I N			9
SELECT				A
				B
				C
				D
				E
				F
LINE STAT	S 20th bce	T 16th bce	T 12th bce	0
IO STATE	A T			1
TBLOK CTR	R E			2
				3
RBLOK CTR				4
				5
SYS MODE				6
				7
TMAX CTR	21st bce	17th bce	13th bce	8
				9
REQ CTR				A
				B
RMAX CTR				C
				D
RTMOT CTR				E
				F

	-60-	-40-	-20-	-00-
	6th bce	2nd bce	b u	BLOK NEXT
			f e	B L
			r	K 1
				R BLOK
				E END
				C
				V BLOK
				TYPE
				S BLOK
				C ID
				BLOK CODE
	7th bce	3rd bce		R SIO
				E STAT
				C
				V SFU
				STAT
				R
				E SDU
				C STAT
				SXU
				STAT
				RIO
				STAT
				RFU
				STAT
				R RDU
				E STAT
				C
				V RXU
				STAT
	8th bce	4th bce		B FILL
				L BCE
				K
				FILL
				SEM
				FILL
				TASK
				USE
				BCE
				not used
				USE
				SEM
				USE
				TASK
				S
				E 6
				N
				D
				R
	9th bce	5th bce		B BUFF
				C PTR
				E
				G
				R
				NEXT
				BCE
				BUFF
				CTRL
				8
				VERT
				b y
				c
				NULL
				LINES
				CHARS or
				RECORDS
				not used

B
U
P
F
E
R

C
O
N
T
R
O
L

B
L
O
C
K

4

**DIAG-
NOSTICS**

4. DIAGNOSTICS

4.1 F13.0 and E13.0 SYSTEM CHECKOUT

In order to checkout most of the hardware (with the exception of the 7230 TC Option Board), either the F13.0 (single PROM system) or E13.0 (dual PROM system) system checkout disk should be run. Before the test is run, the F13.0 or E13.0 disk must be modified in order to test all of the TC workstation's 24K of RAM (instead of the usual 16K of RAM). Use SZAP to change the following locations on the F13.0 or E13.0 disk:

<u>Device Type</u>	<u>Track</u>	<u>Sector</u>	<u>Byte</u>	<u>Old Value</u>	<u>New Value</u>
1	05	00	5D	40	60
Standard Workstation			84	40	60
2	05	01	5D	40	60
Horiz't Scroll Workstation			84	40	60

After these changes are made, operate the system checkout disks in the normal manner.

4.2 OFF-LINE TC ASYNCHRONOUS DIAGNOSTICS

Refer to WPNL 51.1

4.3 ON-LINE SYSTEM TEST

The suggested method of on-line system test (when applicable) for the Communications Controller is a telephone hook-up with an interactive port of WYLBUR (IBM 370/158 host computer) at the Wang Data Center in Burlington, MA (business telephone number (617) 272-8550). The Data Center supports both IBM 2741 and

Teletype protocol (connections = 2741t or TTY). An alternate method of on-line checkout is to arrange a test with the Home Office.

NOTE:

These methods are only to be used if the on-line checkout with the customer's remote site fails.

RULES FOR USING DATA CENTER FACILITIES

1. The signon procedures and keywords are strictly for customer engineering personnel use only.
2. Under no circumstances the signon or keyword be given to a customer for the protection of data base at the Wang Data Center. Please remember that IBM 370 at Wang Data Center is a time sharing system used by many of its customers.
3. Please limit your on-line checkout time to 10-15 minutes at a time as you may tie up the line for data center customers.
4. Before calling Home Office for assistance, the on-line check must be performed.
5. Successful checkout does insure that you have checked out functioning of hardware, software and modem. It does not checkout any variations in protocols or signon procedure customer may encounter when using other remote host computers.

TEST PROCEDURE:

1. Schedule an asynchronous TC session using either the 2741t or TTY connection.
2. Set the line parameters as follows:

For 2741t - 134.5 Baud (enter 134 baud)

For TTY - 110, 150, 200, 300, or 1200 Baud (depending on
the modem used)
- Even Parity

3. Dial WYLBUR. The telephone numbers are:

0-300 baud - (617) 272-8120 103 or 113 Type Modem
1200 baud - (617) 272-7420 202 Type Modem

4. After a few rings a clear carrier tone will be heard. Push the Data button on the modem telephone set. The Data button light must be lit once the telephone connection is established and will remain lit until the line is disconnected.
5. The Data Set status on the CRT screen of the TC workstation should have changed from 'Not Ready' to 'Ready' or else the TC workstation will be unable to communicate on-line.

6. From the keyboard, type one of the following entries:

2741 if 2741t is scheduled

GTWX if 0-300 baud TTY is scheduled

(-COPY-)TWX if 1200 baud TTY is scheduled

Note: (-COPY-) represents hitting only a single key, the COPY key.

7. WYLBUR will respond with something of the form:

WANG DATA CENTER LINE 37 16:36:38 06/27/78

TERMINAL?

Enter:

W33(-RETURN-).

Note: (-RETURN-) represents hitting only a single key, the RETURN key.

8. WYLBUR will respond with:

INITIALS?

Enter:

FES(-RETURN-).

9. WYLBUR will respond with:

ACCOUNT?

Enter:

FS(-RETURN-).

10. WYLBUR will respond with:

KEYWORD?

Enter keyword (obtained from Customer Engineering Home Office) and then key RETURN.

11. WYLBUR will respond with:

COMMAND?

You are now signed on with WYLBUR and are in the command mode.

12. Enter:

USE 2200 ON W33002(-RETURN-)

13. WYLBUR will respond with:

COMMAND?

Enter:

LIST UNN(-RETURN-)

14. WYLBUR will respond with:

1. THIS IS A 2200 T. C. TEST
2. THE 2200 CAN OPERATE AT 110, 150,300, 600,AND 1200 BAUD RATE DEPENDING ON MODEM.
3. THE BELL 103A OR COMPATIBLE CAN OPERATE AT UP TO 300 BAUD WHILE BELL 202C UP TO 1200 BAUD
4. THE 2200 SYSTEM CAN BE SELECTED FOR 5 TO 8 DATA BITS PER CHARACTER.
5. THE EVEN OR ODD OR NO PARITY IS SWITCH SELECTABLE. ALSO 1 OR 2 STOP BITS ARE SWITCH SELECTED.
6. THE 2200 T. C. USES HALF DUPLEX MODE WHICH MEANS IT CAN NOT RECEIVE AND TRANSMIT AT THE SAME TIME.
7. YOU MUST HAVE RECEIVED SEVEN LINES AND THIS IS THE END OF TRANSMISSION.

COMMAND?

Enter:

CLR ACT(-RETURN-)

15. WYLBUR will respond with:

COMMAND?

Enter:

SIGNOFF(-RETURN-)

16. WYLBUR will respond with something of the form:

0.07 SECONDS EDITING TIME
8 PAGE READS, 7 PAGE WRITES
2 DISK READS, 0 DISK WRITES
ELAPSED TIME = 00:01:42
END OF SESSION

17. WYLBUR will drop the line and the test is completed.

4.4 GENERAL SYSTEM TROUBLESHOOTING HINTS

4.4.1 INTRODUCTION

Troubleshooting the telecommunications system is a very complex task. There are so many factors and components involved, such as telephone lines, modems, host computers. Any one of these can cause a problem. The problem is not always a hardware failure in any of the components. More than 70% of the problems encountered in the telecommunications system at installation time are not sufficient information for sign-on procedure, wrong options on the modem and poor knowledge of operating procedure.

4.4.2 TROUBLESHOOTING CHECKLIST

The first thing any service representative should do is to check the installation items as stated below.

- a) Check the entire WP system by running all possible diagnostics available and checking all voltages.
- b) Check the TC workstation for correct switch settings, visually inspect the cards for any broken components, short etches, etc. Make sure the cards are seated properly in connectors.

- c) Run the off-line diagnostic if available. Most of the hardware functions are checked by the diagnostic.
- d) Check the T.C. cable for any bad contacts. Do a continuity check on the cable from one end to another end and make sure all the required signal wires are connected on both ends of the cable.
- e) Call the Telephone Data Service Center and have the modem checked. If possible be present when the modem service representative arrives and show him the problem.
- f) Make sure the host computer can, in fact, support the Wang system. For example, if the host computer can support only Teletype protocol with a character format of 8 data bits and no parity, then these parameters must be used in order to successfully communicate.
- g) Get in touch with data processing personnel at the host computer and discuss the sign-on procedure and explain the problem. Almost all of the sign-on type problems can be resolved this way. If you know anyone else using the same host computer or similar system, find out how he is using it.
- h) Most important of all, try to get help from your Area office, program analyst, Home Office, or anyone you know who has a telecommunications background.

4.4.3 MODEM CONTROL SIGNALS CHECKOUT

If the modem is suspected of causing trouble, the following control signals can be checked using an oscilloscope or with the EIA Interface Test Set (refer to section 4.5). The modem must be in the data mode when checking the control signals.

- 1) Remove the TC workstation's cover or use the EIA Interface Test Set so that you have access to signals used by the RS-232 connector (25 pin Cannon connector). Signal pin numbers given below are in reference to 25 pin Cannon connector.

- 2) Pins 1 and 7 are chassis and reference ground.

Check for any noise on ground circuit.

- 3) Pin 2 TRANSMITTED DATA (FROM TC workstation).

Signals on this circuit are generated by data terminal equipment (TC workstation). Check to see if terminal is transmitting data when in transmit mode. The data terminal will not transmit data unless Clear-to-Send signal is ON (+3v to +25v) on pin 5, Data Terminal Ready signal is ON (+3v to +25v) on pin 20 and Data Set Ready signal is ON (+3v to +25v) on pin 6.

- 4) Pin 3 RECEIVED DATA (FROM data set).

Signals on this circuit are generated by receiving data set in response to data signals received from a remote data set. This circuit is always held in the MARK or OFF state (-3v to -25v) when the received line signal detector (pin 8) is OFF (-3v to -25v).

- 5) Pin 4 REQUEST-TO-SEND (FROM TC workstation).

Data terminal (TC workstation) presents ON signal (+3v to +25v) on this circuit when terminal intends to transmit data. After turning this signal ON, data terminal must wait for ON condition on Clear-to-Send (pin 5) circuit before starting data transmission.

- 6) Pin 5 CLEAR-TO-SEND (FROM data set).

Signal on this circuit is generated by data set to indicate whether or not data set is ready to transmit data. This circuit is turned ON (+3v to +25v) in response to ON signal of Request-to-Send (pin 4) delayed approximately 50 to 200 ms depending on type of modem and customer options selected.

- 7) Pin 6 DATA SET READY (FROM data set).

The ON condition (+3v to +25v) on this circuit indicates that data set is in DATA mode and is capable of receiving and transmitting data. The Data Terminal Ready signal on pin 20 must be ON (+3v to +25v) during DATA mode. The OFF condition (-3v to -25v) indicates that data set is Talk, Test, or On-Hook mode.

- 8) Pin 8 RECEIVED LINE SIGNAL DETECTOR (carrier) (FROM data set).

The ON condition (+3v to +25v) on this circuit indicates the presence of the data carrier signal above the receiver threshold for at least 47 ± 3 milliseconds. This circuit is ON during receive mode and will turn OFF (-3v to -25v) and disable receiver when data terminal is in transmit mode or when Request-to-Send signal is turned ON.

- 9) Pin 11 SECONDARY REQUEST TO SEND (FROM TC workstation)

This circuit is provided on data sets equipped with the reverse channel option and is used to provide communication from the receiving data set to the transmitting data set simultaneous with the primary data channel. This channel can only be used to transmit a signal when Request-to-Send (pin 4) is OFF.

- 10) Pin 12 SECONDARY RECEIVED LINE SIGNAL DETECTOR (FROM data set).

This circuit is provided on data sets equipped with the reverse channel option to inform the data set transmitting on the primary channel of conditions at the receiving data set simultaneous with the transmission on the primary data channel.

11) Pin 20 DATA TERMINAL READY (FROM TC workstation).

The data terminal must apply an ON condition (+3v to +25v) on this circuit at all times to go into the DATA mode. An OFF signal on this line will not allow data set to go in the data mode. An OFF signal on this line during data transmission/reception will make data set drop the communication line.

4.5 EIA INTERFACE TEST SET

The ITS 1 EIA Interface Test Set is a self-contained pocket size test set that can be inserted between the Data Communication Equipment (DCE) or modem and Data Terminal Equipment (DTE). It permits the user to monitor the EIA RS-232 signals and isolate and identify sources of trouble.

The ITS 1 contains nine indicators which continuously monitor the level of the following interface signals: transmitted data, received data, request to send, clear to send, data set ready, received carrier detect, data terminal ready, signal quality detect and ring indicator. Two indicators monitor the transmit and receive clock signals. Unlike the nine levels indicators, these two indicators will not respond when only a DC level is present. The clock interface signal indicators will only turn on when there is an active clock signal present. Two additional uncommitted indicators are available for monitoring either positive or negative levels on any of the interface lines.

The ITS 1 contains 24 switches which allow any of the interface signals except line one, (Frame Ground) to be interrupted. These switches are physically located in the center of the front panel and functionally divide the Test Set into two halves. The upper half contains a cable and connector for connecting the Test set to the DCE or modem. The indicators which monitor signals originating from the modem are also located on the upper half of the front panel. Likewise, the lower half of the Test Set contains a connector to which

the DTE (terminal or CPU) can be connected and the indicators which monitor signals originating from the DTE. The positive and negative test indicators are also located on the lower half of the Test Set. All indicators are labeled with both the standard EIA designation and the commonly used abbreviations.

Twenty five pins are located both above and below the switches. These pins permit monitoring of any of the interface lines with either or both the positive and negative test indicators with jumpers supplied or probing with an external meter or oscilloscope. Both sets of pins are arranged in the same configuration and order as the pins in a standard EIA RS-232 female connector.

The ITS 1 is housed in a sturdy plastic case with aluminum extrusions and hinge. A positive latch is provided on the cover to keep the Test Set closed securely when not in use. The front panel is photographically etched and overcoated to prevent the lettering from being scratched or marred during use. The Test Set is self-contained and is powered by two penlite batteries which will provide over 100 hours of continuous operation. No power is consumed by the Test Set when not in use.

SPECIFICATIONS

<p>LEVEL INDICATORS</p> <p>Transmitted Data</p> <p>Received Data</p> <p>Request-to-Send</p> <p>Clear-to-Send</p> <p>Data Set Ready</p> <p>Received Carrier Detect</p> <p>Data Terminal Ready</p> <p>Signal Quality Detect</p> <p>Ring Indicator</p> <p>Positive Test</p> <p>Negative Test</p>	<p>ACTIVITY INDICATORS.....Transmit Clock</p> <p style="padding-left: 100px;">Receive Clock</p> <p>INDICATOR THRESHOLDS.....+ 3 volts</p> <p>INDICATOR INPUT IMPEDANCE....30,000 ohms</p> <p>POWER.....Two 1.5 volt</p> <p style="padding-left: 100px;">AA Batteries</p> <p>DIMENSIONS.....5.5"L x 3.6"W x</p> <p style="padding-left: 100px;">1.6"H</p> <p>Weight.....12 oz.</p>
---	---

TYPICAL APPLICATIONS

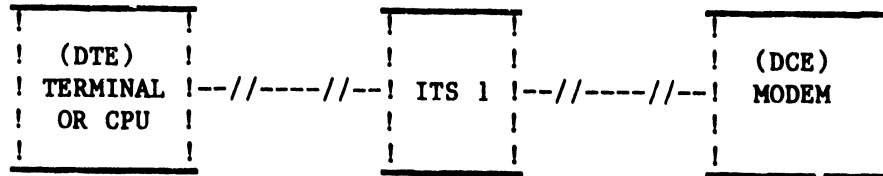
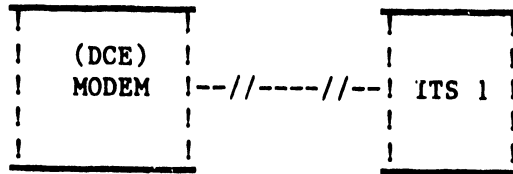
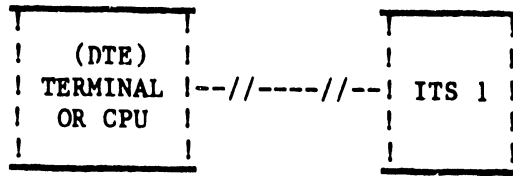

5

**ENGIN-
EERING
CHANGE
NOTICES
(ECN'S)**

5. ENGINEERING CHANGE NOTICES (E.C.N.'s)

The Model 5528 communications controller is comprised of the following P.C.B.'s:

- 210-7067 POWER SUPPLY REGULATOR BOARD
 - 210-7227 DATA LINK BOARD
 - 210-7230 TC OPTION BOARD (RS-232-C)
 - 210-7236 24K MEMORY BOARD
 - 210-7328 MOTHERBOARD (Chassis)
 - 210-7425 CPU/CRT CONTROL BOARD
- OR
- 210-7335 HORIZONTAL SCROLL CPU/CRT CONTROL BOARD

The following is a "TO BE EXECUTED" ECN listing of ONLY the ECN's which apply to the TC Option for the workstation with the electronic revision levels (E-REV) for the associated TC P.C.B.'s:

<u>P.C.B. #</u>	<u>ECN</u>	<u>DESCRIPTION</u>
7067	<u>!6!</u>	None
7227	<u>!3!</u>	None
7230	<u>9102</u> <u>!2!</u>	Artwork/Schematic>Loading Sketch/Design Change (see figure)
		1) Add (1) 2.2K ohm 1/4W Resistor (WL# 330-3022)
		2) Add (1) 7474 IC (WL# 376-0006)
		<u>REASON FOR CHANGE</u>
		To inhibit read of 8251 during any input instruction (received characters could be lost)

<u>P.C.B. #</u>	<u>ECN</u>	<u>DESCRIPTION</u>
7236	<u>101</u>	None
7328	<u>101</u>	None
7335	<u>101</u>	None
7425	<u>101</u>	None

APPENDIX

A

**T.C. WORKSTATION
BILL OF MATERIALS
(BOM)**

ASSEMBLY PART NUMBER 157-9206- - -
 ASSEMBLY DESCRIPTION 5526 WK/ST W/ASYNC

LEGEND

1: P=PHANTOM; 2: ITEM MASTER DELY CODE; 3: *=TAGGED OUT OF KIT(PROD STR)

POSITION IN STRUCTURE	LEGEND 1 2 3	COMPONENT PART NUMBER	DESCRIPTION	E C N	QUANTITY PER ASSY	U/M	IML
1		IN 167-9206- - -	5526 WK/ST W/ASYNC		1.0000	EACH	
2		IN 210-7236-A - -	7236A WK/STA 24K MEMORY MD 928	EC8920	1.0000	EACH	
3		IN 209-7236- - -	7236 WK/STA 24K MEMORY MOL 928		1.0000	EACH	
2		IN * 210-7425-1A - -	7425-1A WS CRT CNTL W/TC OPTION 50HZ		1.0000	EACH	
3		IN 209-7425-1 - -	7425-1 WS CRT CNTL W/TC OPTION 50HZ		1.0000	EACH	
4		IN 220-1103- - -	CRT BRD (W2)(COAX)B6482-122		1.0000	EACH	
2		IN 220-1143- - -	WIRE & LUG ASSY TYPE P065 D6482-12	EC8527	1.0000	EACH	
2		IN * 271-1122- - -	928 KEYBOARD & BP ASSY 6841-10		1.0000	EACH	
3		IN 210-7229- - -	7229 WS KEYBOARD	EC7259	1.0000	EACH	
2	P	FS 279-0322-1 - -	928 WK ST COM MECH W/ASYNC TC 50HZ		1.0000	EACH	
3		IN * 210-7156- - -	7156 PS REG W/CURRENTFOLD BACK		1.0000	EACH	
3		IN * 210-7227- - -	7227 MODULE(AUTO-INSERTED)		1.0000	EACH	
3		IN * 210-7230-A - -	7230A WS TC OPTION BOARD		1.0000	EACH	
4		IN 209-7230- - -	7230 WS TC OPTION BOARD		1.0000	EACH	
3		IN 220-0113- - -	2200 TC CABLE C6482-5	EC8585	1.0000	EACH	
3		IN 220-0148- - -	25 DUAL COAXIAL CABLE C6482-109		1.0000	EACH	
3		IN 220-1104- - -	CABLE CRT(COAX) B6482-123		1.0000	EACH	
3		IN * 270-0345-2 - -	928 WK ST CHASSIS W/ASYNC TC		1.0000	EACH	
4		IN 210-7328-1 - -	PCB ASSY 5526A WS MTHRBD W/TC		1.0000	EACH	
5		IN 220-3014- - -	24 COND 14"FLAT CABLE C-6482-79		1.0000	EACH	
4		IN 220-1076- - -	POWER CORD ASSY(F CHAS)B6482-95		1.0000	EACH	
4		IN 220-1101- - -	P054 WIRE&LUG ASSY(E CHAS)6482-12		1.0000	EACH	
4		IN * 270-0346-1 - -	WS POWER SUPPLY ASSY		1.0000	EACH	
5		IN 220-1042- - -	P022 WIRE & LUG ASSY(2LCRT)D6482-12		1.0000	EACH	
5		IN 220-1074- - -	CABLE PS/MB(F CHASSIS)B6482-91		1.0000	EACH	
5		IN 220-1077- - -	P043 WIRE & LUG ASSY(F CHAS)B648296		1.0000	EACH	
5		IN 220-1094- - -	P048 WIRE & LUG ASSY B		1.0000	EACH	
3		IN 272-0004- - -	928W2 BEZEL ASSY(ALUM TAPE) 6841-31		1.0000	EACH	
3		IN * 279-1015- - -	928W2 BASE ASSY(ALUM TAPE) 6841-30		1.0000	EACH	
3		IN * 279-4021- - -	928W2 COVER ASSY(ALUM TAPE) 6841-32		1.0000	EACH	

MB0080-A

MULTI-LEVEL BILL OF MATERIAL AS OF

RUN DATE: 07/13/78

PAGE 1

ASSEMBLY PART NUMBER 157-9206-A --
 ASSEMBLY DESCRIPTION 5526A WK/ST W/ASYNC ASCII

LEGEND
 1: P=PHANTOM; 2: ITEM MASTER DELY CODE; 3: *=TAGGED OUT OF KIT(PROD STR)

POSITION IN STRUCTURE	LEGEND 1 2 3	COMPONENT PART NUMBER	DESCRIPTION	E C N	QUANTITY PER ASSY	U/M	IML
1	IN	167-9206-A --	5526A WK/ST W/ASYNC ASCII				
2	IN	210-7236-A --	7236A WK/STA 24K MEMORY MD 928	EC8920	1.0000	EACH	
3	IN	209-7236- --	7236 WK/STA 24K MEMORY MDL 928		1.0000	EACH	
2	IN *	210-7425-1A- --	7425-1A WS CRT CNTL W/TC OPTION50HZ		1.0000	EACH	
3	IN	209-7425-1 --	7425-1 WS CRT CNTL W/TC OPTION 50HZ		1.0000	EACH	
4	IN	220-1103- --	CRT BRD (W2)(COAX)B6482-122		1.0000	EACH	
2	IN	220-1143- --	WIRE & LUG ASSY TYPE P065 D6482-12	EC8527	1.0000	EACH	
2	IN *	271-1140- --	928 KBD W/15 ASCII 6841-13		1.0000	EACH	
3	IN	210-7229- --	7229 WS KEYBOARD		1.0000	EACH	
2	P FS	279-0322-1 --	928 WK ST COM MECH W/ASYNC TC 50HZ		1.0000	EACH	
3	IN *	210-7156- --	7156 PS REG L/CURRENTFOLD BACK		1.0000	EACH	
3	IN *	210-7227- --	7227 MODULE(AUTO-INSERTED)		1.0000	EACH	
3	IN *	210-7230-A --	7230A WS TC OPTION BOARD		1.0000	EACH	
4	IN	209-7230- --	7230 WS TC OPTION BOARD		1.0000	EACH	
3	IN	220-0113- --	2200 TC CABLE C6482-5	EC8585	1.0000	EACH	
3	IN	220-0148- --	25°DUAL COAXIAL CABLE C6482-109		1.0000	EACH	
3	IN	220-1104- --	CABLE,CRT(COAX) B6482-123		1.0000	EACH	
4	IN *	270-0345-2 --	928 WK ST CHASSIS W/ASYNC TC		1.0000	EACH	
4	IN	210-7328-1 --	PCB ASSY 5526A WS MTHRBD W/TC		1.0000	EACH	
5	IN	220-3014- --	24 COND 14"FLAT CABLE C-6482-79		1.0000	EACH	
4	IN	220-1076- --	POWER CORD ASSY(F CHAS)B6482-95		1.0000	EACH	
4	IN	220-1101- --	P054 WIRE&LUG ASSY(E CHAS)6482-12		1.0000	EACH	
4	IN *	270-0346-1 --	WS POWER SUPPLY ASSY		1.0000	EACH	
4	IN	220-1042- --	P022 WIRE & LUG ASSY(2LCRT)D6482-12		1.0000	EACH	
4	IN	220-1074- --	CABLE PS/MB(F CHASSIS)B6482-91		1.0000	EACH	
4	IN	220-1077- --	P043 WIRE & LUG ASSY(F CHAS)B648296		1.0000	EACH	
4	IN	220-1094- --	P048 WIRE & LUG ASSY B		1.0000	EACH	
3	IN	272-0004- --	928W. BEZEL ASSY(ALUM TAPE) 6841-31		1.0000	EACH	
3	IN *	279-1015- --	928WZ BASE ASSY(ALUM TAPE) 6841-30		1.0000	EACH	
3	IN *	279-4021- --	928W2 COVER ASSY(ALUM TAPE) 6841-32		1.0000	EACH	

A-3

ASSEMBLY PART NUMBER 157-9206-H - -
 ASSEMBLY DESCRIPTION 5526H WK/ST W/ASYNC HORIZ SCROLL

LEGEND
 1: P=PHANTOM; 2: ITEM MASTER DELY CODE; 3: *=TAGGED OUT OF KIT(PROD STR)

POSITION IN STRUCTURE	LEGEND	COMPONENT PART NUMBER	DESCRIPTION	E C N	QUANTITY PER ASSY	U/M	IML
1	IN	167-9206-H - -	5526H WK/ST W/ASYNC HORIZ SCROLL		1.0000	EACH	
2	IN	210-7236-A - -	7236A WK/STA 24K MEMORY MD 928	EC8920	1.0000	EACH	
3	IN	209-7236- - -	7236 WK/STA 24K MEMORY MDL 928		1.0000	EACH	
2	IN *	210-7335-1A - -	7335-1A PCB ASSY WS WPD CNTL W/TC		1.0000	EACH	
3	IN	209-7335- - -	7335 WS WPD CONTROL W/TC OPTION		1.0000	EACH	
4	IN	220-1103- - -	CRT BRD (W2)(COAX)B6482-122		1.0000	EACH	
2	IN	220-1143- - -	WIRE & LUG ASSY TYPE P065 D6482-12	EC8527	1.0000	EACH	
3	IN *	271-1122- - -	928 KEYBOARD & BP ASSY 6841-10		1.0000	EACH	
3	IN	210-7229- - -	7229 WS KEYBOARD	EC7259	1.0000	EACH	
2	P FS	279-0322-1 - -	928 WK ST COM MECH W/ASYNC TC 50HZ		1.0000	EACH	
3	IN *	210-7156- - -	7156 PS REG W/CURRENTFOLD BACK		1.0000	EACH	
3	IN *	210-7227- - -	7227 MODULE(AUTO-INSERTED)		1.0000	EACH	
3	IN *	210-7230-A - -	7230A WS TC OPTION BOARD		1.0000	EACH	
4	IN	209-7230- - -	7230 WS TC OPTION BOARD		1.0000	EACH	
3	IN	220-0113- - -	2200 TC CABLE C6482-5	EC8585	1.0000	EACH	
3	IN	220-0148- - -	25-DUAL COAXIAL CABLE C6482-109		1.0000	EACH	
3	IN	220-1104- - -	CABLE CRT(COAX) B6482-123		1.0000	EACH	
3	IN *	270-0345-2 - -	928 WK ST CHASSIS W/ASYNC TC		1.0000	EACH	
4	IN	210-7328-1 - -	PCB ASSY 5526A WS MTHRBD W/TC		1.0000	EACH	
5	IN	220-3014- - -	24 COND 14"FLAT CABLE C-6482-79		1.0000	EACH	
4	IN	220-1076- - -	POWER CORD ASSY(F CHAS)B6482-95		1.0000	EACH	
4	IN	220-1101- - -	P054 WIRE&LUG ASSY(E CHAS)6482-12		1.0000	EACH	
4	IN *	270-0346-1 - -	WS POWER SUPPLY ASSY		1.0000	EACH	
5	IN	220-1042- - -	P022 WIRE & LUG ASSY(2LCRT)D6482-12		1.0000	EACH	
5	IN	220-1074- - -	CABLE PS/MB(F CHASSIS)B6482-91		1.0000	EACH	
5	IN	220-1077- - -	P043 WIRE & LUG ASSY(F CHAS)B648296		1.0000	EACH	
5	IN	220-1094- - -	P048 WIRE & LUG ASSY B		1.0000	EACH	
3	IN	272-0004- - -	928W2 BEZEL ASSY(ALUM TAPE) 6841-31		1.0000	EACH	
3	IN *	279-1015- - -	928W2 BASE ASSY(ALUM TAPE) 6841-30		1.0000	EACH	
3	IN *	279-4021- - -	928W2 COVER ASSY(ALUM TAPE) 6841-32		1.0000	EACH	

A-4

ASSEMBLY PART NUMBER 157-9206-M - -

ASSEMBLY DESCRIPTION 5526M WK/ST W/ASYNC 15 KEY NUM PAD

LEGEND

1: P=PHANTOM; 2: ITEM MASTER DELY CODE; 3: *=TAGGED OUT OF KIT(PROD STR)

POSITION IN STRUCTURE	LEGEND			COMPONENT PART NUMBER	DESCRIPTION	E C N	QUANTITY PER ASSY	U/M	IML
	1	2	3						
1		IN		167-9206-M - -	5526M WK/ST W/ASYNC 15 KEY NUM PAD		1.0000	EACH	
2		IN		210-7236-A - -	7236A WK/STA 24K MEMORY MD 928	EC8920	1.0000	EACH	
3		IN		209-7236- - -	7236 WK/STA 24K MEMORY MDL 928		1.0000	EACH	
2		IN *		210-7425-1A- -	7425-1A WS CRT CNTL W/TC OPTION50HZ		1.0000	EACH	
3		IN		209-7425-1 - -	7425-1 WS CRT CNTL W/TC OPTION 50HZ		1.0000	EACH	
4		IN		220-1103- - -	CRT BRD (W2)(COAX)B6482-122		1.0000	EACH	
2		IN		220-1143- - -	WIRE & LUG ASSY TYPE P065 D6482-12	EC8527	1.0000	EACH	
2		IN *		271-1139- - -	928 KEYBD W/15 KEY NUM PAD 6841-12		1.0000	EACH	
3		IN		210-7229- - -	7229 WS KEYBOARD		1.0000	EACH	
2		P FS		279-0322-1 - -	928 WK ST COM MECH W/ASYNC TC 50HZ		1.0000	EACH	
3		IN *		210-7156- - -	7156 PS REG W/CURRENTFOLD BACK		1.0000	EACH	
3		IN *		210-7227- - -	7227 MODULE(AUTO-INSERTED)		1.0000	EACH	
3		IN *		210-7230-A - -	7230A WS TC OPTION BOARD		1.0000	EACH	
4		IN		209-7230- - -	7230 WS TC OPTION BOARD		1.0000	EACH	
3		IN		220-0113- - -	2200 TC CABLE C6482-5	EC8585	1.0000	EACH	
3		IN		220-0148- - -	25 DUAL COAXIAL CABLE C6482-109		1.0000	EACH	
3		IN		220-1104- - -	CABLE CRT(COAX) B6482-123		1.0000	EACH	
3		IN *		270-0345-2 - -	928 WK ST CHASSIS W/ASYNC TC		1.0000	EACH	
4		IN		210-7328-1 - -	PCB ASSY 5526A WS W/THRBD W/TC		1.0000	EACH	
5		IN		220-3014- - -	24 COND 14"FLAT CABLE C-6482-79		1.0000	EACH	
4		IN		220-1076- - -	POWER CORD ASSY(F CHAS)B6482-95		1.0000	EACH	
4		IN		220-1101- - -	P05A WIRE&LUG ASSY(F CHAS)6482-12		1.0000	EACH	
4		IN *		270-0346-1 - -	WS POWER SUPPLY ASSY		1.0000	EACH	
5		IN		220-1042- - -	P022 WIRE & LUG ASSY(2LCRT)D6482-12		1.0000	EACH	
5		IN		220-1074- - -	CABLE PS/MB(F CHASSIS)B6482-91		1.0000	EACH	
5		IN		220-1077- - -	P043 WIRE & LUG ASSY(F CHAS)B648296		1.0000	EACH	
5		IN		220-1094- - -	P048 WIRE & LUG ASSY B		1.0000	EACH	
3		IN		272-0004- - -	928W2 BEZEL ASSY(ALUM TAPE) 6841-31		1.0000	EACH	
3		IN *		279-1015- - -	928W2 BASE ASSY(ALUM TAPE) 6841-30		1.0000	EACH	
3		IN *		279-4021- - -	928W2 COVER ASSY(ALUM TAPE) 6841-32		1.0000	EACH	

MB0080-A MULTI-LEVEL BILL OF MATERIAL AS OF

RUN DATE: 07/13/78

PAGE 1

ASSEMBLY PART NUMBER 157-9206-S - -
 ASSEMBLY DESCRIPTION 5526S WK/ST W/ASYNC SPANISH

LEGEND
 1: P=PHANTOM; 2: ITEM MASTER DELY CODE; 3: *=TAGGED OUT OF KIT(PROD STR)

POSITION IN STRUCTURE	LEGEND 1 2 3	COMPONENT PART NUMBER	DESCRIPTION	E C N	QUANTITY PER ASSY	U/M	IML
1	IN	167-9206-S - -	5526S WK/ST W/ASYNC SPANISH		1.0000	EACH	
2	IN	210-7236-A - -	7236A WK/STA 24K MEMORY MD 928	EC8920	1.0000	EACH	
3	IN	209-7236 - - -	7236 WK/STA 24K MEMORY MDL 928		1.0000	EACH	
2	IN *	210-7425-1A - -	7425-1A WS CRT CNTL W/TC OPTION50HZ		1.0000	EACH	
3	IN	209-7425-1 - -	7425-1 WS CRT CNTL W/TC OPTION 50HZ		1.0000	EACH	
4	IN	220-1103 - - -	CRT BRD (W2)(COAX)B6482-122		1.0000	EACH	
2	IN	220-1143 - - -	WIRE & LUG ASSY TYPE P055 D6482-12	EC8527	1.0000	EACH	
2	IN *	271-1138 - - -	928 KBD ASSY SPANISH 6841-11		1.0000	EACH	
3	IN	210-7229 - - -	7229 WS KEYBOARD		1.0000	EACH	
2	P FS	279-0322-1 - -	928 WK ST COM MECH W/ASYNC TC 50HZ		1.0000	EACH	
3	IN *	210-7156 - - -	7156 PS REG W/CURRENTFOLD BACK		1.0000	EACH	
3	IN *	210-7227 - - -	7227 MODULE(AUTO-INSERTED)		1.0000	EACH	
3	IN *	210-7230-A - -	7230A WS TC OPTION BOARD		1.0000	EACH	
4	IN	209-7230 - - -	7230 WS TC OPTION BOARD		1.0000	EACH	
3	IN	220-0113 - - -	2200 TC CABLE C6482-5	EC8585	1.0000	EACH	
3	IN	220-0148 - - -	25*DUAL COAXIAL CABLE C6482-109		1.0000	EACH	
3	IN	220-1104 - - -	CABLE,CRT(COAX) B6482-123		1.0000	EACH	
3	IN *	270-0345-2 - -	928 WK ST CHASSIS W/ASYNC TC		1.0000	EACH	
4	IN	210-7328-1 - -	PCB ASSY 5526A WS MTHR6D W/TC		1.0000	EACH	
5	IN	220-3014 - - -	24 COND 14*FLAT CABLE C-6482-79		1.0000	EACH	
4	IN	220-1076 - - -	POWER CORD ASSY(F CHAS)B6482-95		1.0000	EACH	
4	IN	220-1101 - - -	P054 WIRE&LUG ASSY(E CHAS)6482-12		1.0000	EACH	
4	IN *	270-0346-1 - -	WS POWER SUPPLY ASSY		1.0000	EACH	
5	IN	220-1042 - - -	P022 WIRE & LUG ASSY(2LCRT)D6482-12		1.0000	EACH	
5	IN	220-1074 - - -	CABLE PS/MB(F CHASSIS)B6482-91		1.0000	EACH	
5	IN	220-1077 - - -	P043 WIRE & LUG ASSY(F CHAS)B648296		1.0000	EACH	
5	IN	220-1094 - - -	P048 WIRE & LUG ASSY B		1.0000	EACH	
3	IN	272-0004 - - -	928W2 BEZEL ASSY(ALUM TAPE) 6841-31		1.0000	EACH	
3	IN *	279-1015 - - -	928WZ BASE ASSY(ALUM TAPE) 6841-30		1.0000	EACH	
3	IN *	279-4021 - - -	928W2 COVER ASSY(ALUM TAPE) 6841-32		1.0000	EACH	

MB0080-A MULTI-LEVEL BILL OF MATERIAL AS OF

RUN DATE: 07/13/78

PAGE 1

ASSEMBLY PART NUMBER 167-9206- - -
 ASSEMBLY DESCRIPTION 5526 WK/ST W/ASYNC

LEGEND

1: P=PHANTOM; 2: ITEM MASTER DELY CODE; 3: *=TAGGED OUT OF KIT(PROD STR)

POSITION IN STRUCTURE	LEGEND 1 2 3	COMPONENT PART NUMBER	DESCRIPTION	E C N	QUANTITY PER ASSY	U/M	IML
1		IN 210-7236-A - -	7236A WK/STA 24K MEMORY MD 928				
2		IN 209-7236- - -	7236 WK/STA 24K MEMORY MDL 928	EC8920	1.0000	EACH	
1		IN * 210-7425-1A- -	7425-1A WS CRT CNTL W/TC OPTION50HZ		1.0000	EACH	
2		IN 209-7425-1 - -	7425-1 WS CRT CNTL W/TC OPTION 50HZ		1.0000	EACH	
3		IN 220-1103- - -	CRT BRD (W2)(COAX)B6482-122		1.0000	EACH	
1		IN 220-1143- - -	WIRE & LUG ASSY TYPE P065 D6482-12	EC8527	1.0000	EACH	
2		IN * 271-1122- - -	928 KEYBOARD & BP ASSY 6841-10		1.0000	EACH	
1		IN 210-7229- - -	7229 WS KEYBOARD	EC7259	1.0000	EACH	
1	P FS	IN 279-0322-1 - -	928 WK ST COM MECH W/ASYNC TC 50HZ		1.0000	EACH	
2		IN * 210-7156- - -	7156 PS REG W/CURRENTFOLD BACK		1.0000	EACH	
2		IN * 210-7227- - -	7227 MODULE(AUTO-INSERTED)		1.0000	EACH	
2		IN * 210-7230-A - -	7230A WS TC OPTION BOARD		1.0000	EACH	
3		IN 209-7230- - -	7230 WS TC OPTION BOARD		1.0000	EACH	
2		IN 220-0113- - -	2200 TC CABLE C6482-5	EC8585	1.0000	EACH	
2		IN 220-0148- - -	25-DUAL COAXIAL CABLE C6482-109		1.0000	EACH	
2		IN 220-1104- - -	CABLE CRT(COAX) B6482-123		1.0000	EACH	
3		IN * 270-0345-2 - -	928 WK ST CHASSIS W/ASYNC TC		1.0000	EACH	
4		IN 210-7328-1 - -	PCB ASSY 5526A WS MTHRBD W/TC		1.0000	EACH	
3		IN 220-3014- - -	24 COND 14"FLAT CABLE C-6482-79		1.0000	EACH	
3		IN 220-1076- - -	POWER CORD ASSY(F CHAS)B6482-95		1.0000	EACH	
3		IN 220-1101- - -	P054 WIRE&LUG ASSY(E CHAS)6482-12		1.0000	EACH	
3		IN * 270-0346-1 - -	WS POWER SUPPLY ASSY		1.0000	EACH	
4		IN 220-1042- - -	P022 WIRE & LUG ASSY(2LCRT)D6482-12		1.0000	EACH	
4		IN 220-1074- - -	CABLE PS/MB(F CHASSIS)B6482-91		1.0000	EACH	
4		IN 220-1077- - -	P043 WIRE & LUG ASSY(F CHAS)B648296		1.0000	EACH	
4		IN 220-1094- - -	P048 WIRE & LUG ASSY B		1.0000	EACH	
2		IN 272-0004- - -	928W2 BEZEL ASSY(ALUM TAPE) 6841-31		1.0000	EACH	
2		IN * 279-1015- - -	928WZ BASE ASSY(ALUM TAPE) 6841-30		1.0000	EACH	
2		IN * 279-4021- - -	928WZ COVER ASSY(ALUM TAPE) 6841-32		1.0000	EACH	

M80080-A MULTI-LEVEL BILL OF MATERIAL AS OF

RUN DATE: 07/13/78

PAGE 1

ASSEMBLY PART NUMBER 167-9206-A --
 ASSEMBLY DESCRIPTION 5526A WK/ST W/ASYNC ASCII

LEGEND
 1: P=PHANTOM; 2: ITEM MASTER DELY CODE; 3: *=TAGGED OUT OF KIT(PROD STR)

POSITION IN STRUCTURE	LEGEND	COMPONENT PART NUMBER	DESCRIPTION	E C N	QUANTITY PER ASSY	U/M	IML
1		IN 210-7236-A --	7236A WK/STA 24K MEMORY MD 928				
2		IN 209-7236- --	7236 WK/STA 24K MEMORY MDL 928	EC8920	1.0000	EACH	
1		IN * 210-7425-1A- --	7425-1A WS CRT CNTL W/TC OPTION50HZ		1.0000	EACH	
2		IN 209-7425-1 --	7425-1 WS CRT CNTL W/TC OPTION 50HZ		1.0000	EACH	
3		IN 220-1103- --	CRT BRD (W2)(COAX)B6482-122		1.0000	EACH	
1		IN 220-1143- --	WIRE & LUG ASSY TYPE P065 D6482-12	EC8527	1.0000	EACH	
1		IN * 271-1140- --	928 KBD W/15 ASCII 6841-13		1.0000	EACH	
2		IN 210-7229- --	7229 WS KEYBOARD		1.0000	EACH	
1	P	FS 279-0322-1 --	928 WK ST COM MECH W/ASYNC TC 50HZ				
2		IN * 210-7156- --	7156 PS REG W/CURRENTFOLD BACK		1.0000	EACH	
2		IN * 210-7227- --	7227 MODULE(AUTO-INSERTED)		1.0000	EACH	
2		IN * 210-7230-A --	7230A WS TC OPTION BOARD		1.0000	EACH	
3		IN 209-7230- --	7230 WS TC OPTION BOARD		1.0000	EACH	
2		IN 220-0113- --	2200 TC CABLE C6482-5	EC8585	1.0000	EACH	
2		IN 220-0148- --	25° DUAL COAXIAL CABLE C6482-109		1.0000	EACH	
2		IN 220-1104- --	CABLE CRT(COAX) B6482-123		1.0000	EACH	
2		IN * 270-0345-2 --	928 WK ST CHASSIS W/ASYNC TC		1.0000	EACH	
3		IN 210-7328-1 --	PCB ASSY 5526A WS MTHRBD W/TC		1.0000	EACH	
4		IN 220-3014- --	24 COND 14° FLAT CABLE C-6482-79		1.0000	EACH	
3		IN 220-1076- --	POWER CORD ASSY(IF CHAS)B6482-95		1.0000	EACH	
3		IN 220-1101- --	P054 WIRE&LUG ASSY(E CHAS)6482-12		1.0000	EACH	
4		IN * 270-0346-1 --	WS POWER SUPPLY ASSY		1.0000	EACH	
4		IN 220-1042- --	P022 WIRE & LUG ASSY(2LCRT)D6482-12		1.0000	EACH	
4		IN 220-1074- --	CABLE PS/MB(IF CHASSIS)B6482-91		1.0000	EACH	
4		IN 220-1077- --	P043 WIRE & LUG ASSY(IF CHAS)B648296		1.0000	EACH	
4		IN 220-1094- --	P048 WIRE & LUG ASSY B		1.0000	EACH	
2		IN 272-0004- --	928W2 BEZEL ASSY(ALUM TAPE) 6841-31		1.0000	EACH	
2		IN * 279-1015- --	928W2 BASE ASSY(ALUM TAPE) 6841-30		1.0000	EACH	
2		IN * 279-4021- --	928W2 COVER ASSY(ALUM TAPE) 6841-32		1.0000	EACH	

A-8

ASSEMBLY PART NUMBER 167-9206-H - -
 ASSEMBLY DESCRIPTION 5526H WK/ST W/ASYNC HORIZ SCROLL

LEGEND
 1: P=PHANTOM; 2: ITEM MASTER DELY CODE; 3: *=TAGGED OUT OF KIT(PROD STR)

POSITION IN STRUCTURE	LEGEND			COMPONENT PART NUMBER	DESCRIPTION	E C N	QUANTITY PER ASSY	U/M	IML
	1	2	3						
1				IN 210-7236-A - -	7236A WK/STA 24K MEMORY MD 928	EC8920	1.0000	EACH	
2				IN 200-7236- - -	7236 WK/STA 24K MEMORY MDL 928		1.0000	EACH	
1				IN * 210-7335-1A- -	7335-1A PCB ASSY WS WPO CNTRL W/TC		1.0000	EACH	
2				IN 209-7335- - -	7335 WS WPO CONTROL W/TC OPTION		1.0000	EACH	
3				IN 220-1103- - -	CRT BRD (W2)(COAX)B6482-122		1.0000	EACH	
1				IN 220-1143- - -	WIRE & LUG ASSY TYPE P065 D6482-12	EC8527	1.0000	EACH	
1				IN * 271-1122- - -	928 KEYBOARD & BP ASSY 6841-10		1.0000	EACH	
2				IN 210-7229- - -	7229 WS KEYBOARD	EC7259	1.0000	EACH	
1		P		FS 279-0322-1 - -	928 WK ST COM MECH W/ASYNC TC 50HZ		1.0000	EACH	
2				IN * 210-7156- - -	7156 PS REG W/CURRENTFOLD BACK		1.0000	EACH	
2				IN * 210-7227- - -	7227 MODULE(AUTO-INSERTED)		1.0000	EACH	
2				IN * 210-7230-A - -	7230A WS TC OPTION BOARD		1.0000	EACH	
3				IN 209-7230- - -	7230 WS TC OPTION BOARD		1.0000	EACH	
2				IN 220-0113- - -	2200 TC CABLE C6482-5	EC8585	1.0000	EACH	
2				IN 220-0148- - -	25-DUAL COAXIAL CABLE C6482-109		1.0000	EACH	
2				IN 220-1104- - -	CABLE,CRT(COAX) B6482-123		1.0000	EACH	
2				IN * 270-0345-2 - -	928 WK ST CHASSIS W/ASYNC TC		1.0000	EACH	
3				IN 210-7328-1 - -	PCB ASSY 5526A WS MTHRBD W/TC		1.0000	EACH	
4				IN 220-3014- - -	24 COND 14"FLAT CABLE C-6482-79		1.0000	EACH	
3				IN 220-1076- - -	POWER CORD ASSY(F CHAS)B6482-95		1.0000	EACH	
3				IN 220-1101- - -	P054 WIRE&LUG ASSY(E CHAS)6482-12		1.0000	EACH	
3				IN * 270-0346-1 - -	WS POWER SUPPLY ASSY		1.0000	EACH	
4				IN 220-1042- - -	P022 WIRE & LUG ASSY(2LCRT)D6482-12		1.0000	EACH	
4				IN 220-1074- - -	CABLE PS/MB(F CHASSIS)B6482-91		1.0000	EACH	
4				IN 220-1077- - -	P043 WIRE & LUG ASSY(F CHAS)B648296		1.0000	EACH	
4				IN 220-1094- - -	P048 WIRE & LUG ASSY B		1.0000	EACH	
2				IN 272-0004- - -	928W2 BEZEL ASSY(ALUM TAPE) 6841-31		1.0000	EACH	
2				IN * 279-1015- - -	928W2 BASE ASSY(ALUM TAPE) 6841-30		1.0000	EACH	
2				IN * 279-4021- - -	928W2 COVER ASSY(ALUM TAPE) 6841-32		1.0000	EACH	

A-9

ASSEMBLY PART NUMBER 167-9206-M - -
 ASSEMBLY DESCRIPTION 5526M WK/ST W/ASYNC 15 KEY NUM PAD

LEGEND

1: P=PHANTOM; 2: ITEM MASTER DELY CODE; 3: *=TAGGED OUT OF KIT(PROD STR)

POSITION IN STRUCTURE	LEGEND 1 2 3	COMPONENT PART NUMBER	DESCRIPTION	E C N	QUANTITY PER ASSY	U/M	IML
1		IN 210-7236-A - -	7236A WK/STA 24K MEMORY MD 928	EC8920	1.0000	EACH	
2		IN 209-7236- - -	7236 WK/STA 24K MEMORY MDL 928		1.0000	EACH	
1		IN * 210-7425-1A- -	7425-1A WS CRT CNTL W/TC OPTION50HZ		1.0000	EACH	
2		IN 209-7425-1 - -	7425-1 WS CRT CNTL W/TC OPTION 50HZ		1.0000	EACH	
3		IN 220-1103- - -	CRT BPD (W2)(COAX)B6482-122		1.0000	EACH	
1		IN 220-1143- - -	WIRE & LUG ASSY TYPE P065 D6482-12	EC8527	1.0000	EACH	
1		IN * 271-1139- - -	928 KEYBD W/15 KEY NUM PAD 6841-12		1.0000	EACH	
2		IN 210-7229- - -	7229 WS KEYBOARD		1.0000	EACH	
1	P FS	IN 279-0322-1 - -	928 WK ST COM MECH W/ASYNC TC 50HZ		1.0000	EACH	
2		IN * 210-7156- - -	7156 PS REG W/CURRENTFOLD BACK		1.0000	EACH	
2		IN * 210-7227- - -	7227 MODULE(AUTO-INSERTED)		1.0000	EACH	
2		IN * 210-7230-A - -	7230A WS TC OPTION BOARD		1.0000	EACH	
3		IN 209-7230- - -	7230 WS TC OPTION BOARD		1.0000	EACH	
2		IN 220-0113- - -	2200 TC CABLE C6482-5	EC8585	1.0000	EACH	
2		IN 220-0148- - -	25*DUAL COAXIAL CABLE C6482-109		1.0000	EACH	
2		IN 220-1104- - -	CABLE CRT(COAX) B6482-123		1.0000	EACH	
2		IN * 270-0345-2 - -	928 WK ST CHASSIS W/ASYNC TC		1.0000	EACH	
3		IN 210-7328-1 - -	PCB ASSY 5526A WS MTHRBD W/TC		1.0000	EACH	
4		IN 220-3014- - -	24 COND 14*FLAT CABLE C-6482-79		1.0000	EACH	
3		IN 220-1076- - -	POWER CORD ASSY(F CHAS)B6482-95		1.0000	EACH	
3		IN 220-1101- - -	P054 WIRE&LUG ASSY(E CHAS)6482-12		1.0000	EACH	
3		IN * 270-0346-1 - -	WS POWER SUPPLY ASSY		1.0000	EACH	
4		IN 220-1042- - -	P022 WIRE & LUG ASSY(2LCRT)D6482-12		1.0000	EACH	
4		IN 220-1074- - -	CABLE PS/MB(F CHASSIS)B6482-91		1.0000	EACH	
4		IN 220-1077- - -	P043 WIRE & LUG ASSY(F CHAS)B648296		1.0000	EACH	
4		IN 220-1094- - -	P048 WIRE & LUG ASSY B		1.0000	EACH	
2		IN 272-0004- - -	928W2 BEZEL ASSY(ALUM TAPE) 6841-31		1.0000	EACH	
2		IN * 279-1015- - -	928WZ BASE ASSY(ALUM TAPE) 6841-30		1.0000	EACH	
2		IN * 279-4021- - -	928W2 COVER ASSY(ALUM TAPE) 6841-32		1.0000	EACH	

ASSEMBLY PART NUMBER 167-9206-S - -
 ASSEMBLY DESCRIPTION 5526S WK/ST W/ASYNC SPANISH

LEGEND
 1: P=PHANTOM; 2: ITEM MASTER DELY CODE; 3: *=TAGGED OUT OF KIT(PROD STR)

POSITION IN STRUCTURE	LEGEND 1 2 3	COMPONENT PART NUMBER	DESCRIPTION	E C N	QUANTITY PER ASSY	U/M	IML
1		IN 210-7236-A - -	7236A WK/STA 24K MEMORY MD 928	EC8920	1.0000	EACH	
2		IN 209-7236- - -	7236 WK/STA 24K MEMORY MDL 928		1.0000	EACH	
1		IN * 210-7425-1A - -	7425-1A WS CRT CNTL W/TC OPTION 50HZ		1.0000	EACH	
2		IN 209-7425-1 - -	7425-1 WS CRT CNTL W/TC OPTION 50HZ		1.0000	EACH	
3		IN 220-1103- - -	CRT BRD (W2)(COAX)B6482-122		1.0000	EACH	
1		IN 220-1143- - -	WIRE & LUG ASSY TYPE P065 D6482-12	EC8527	1.0000	EACH	
1		IN * 271-1138- - -	928 KBD ASSY SPANISH 6841-11		1.0000	EACH	
2		IN 210-7229- - -	7229 WS KEYBOARD		1.0000	EACH	
1	P	FS 279-0322-1 - -	928 WK ST COM MECH W/ASYNC TC 50HZ		1.0000	EACH	
2		IN * 210-7156- - -	7156 PS REG W/CURRENTFOLD BACK		1.0000	EACH	
2		IN * 210-7227- - -	7227 MODULE(AUTO-INSERTED)		1.0000	EACH	
2		IN * 210-7230-A - -	7230A WS TC OPTION BOARD		1.0000	EACH	
3		IN 209-7230- - -	7230 WS TC OPTION BOARD		1.0000	EACH	
2		IN 220-0113- - -	2200 TC CABLE C6482-5	EC8585	1.0000	EACH	
2		IN 220-0148- - -	25 DUAL COAXIAL CABLE C6482-109		1.0000	EACH	
2		IN 220-1104- - -	CABLE,CRT(COAX) B6482-123		1.0000	EACH	
3		IN * 270-0345-2 - -	928 WK ST CHASSIS W/ASYNC TC		1.0000	EACH	
4		IN 210-7328-1 - -	PCB ASSY 5526A WS MTRBD W/TC		1.0000	EACH	
4		IN 220-3014- - -	24 COND 14*FLAT CABLE C-6482-79		1.0000	EACH	
3		IN 220-1076- - -	POWER CORD ASSY(F CHAS)B6482-95		1.0000	EACH	
3		IN 220-1101- - -	P054 WIRE&LUG ASSY(E CHAS)6482-12		1.0000	EACH	
3		IN * 270-0346-1 - -	WS POWER SUPPLY ASSY		1.0000	EACH	
4		IN 220-1042- - -	P022 WIRE & LUG ASSY(2LCRT)D6482-12		1.0000	EACH	
4		IN 220-1074- - -	CABLE PS/MB(F CHASSIS)B6482-91		1.0000	EACH	
4		IN 220-1077- - -	P043 WIRE & LUG ASSY(F CHAS)B648296		1.0000	EACH	
4		IN 220-1094- - -	P048 WIRE & LUG ASSY B		1.0000	EACH	
2		IN 272-0004- - -	928W2 BEZEL ASSY(ALUM TAPE) 6841-31		1.0000	EACH	
2		IN * 279-1015- - -	928WZ BASE ASSY(ALUM TAPE) 6841-30		1.0000	EACH	
2		IN * 279-1021- - -	928WZ COVER ASSY(ALUM TAPE) 6841-32		1.0000	EACH	

A-11

ASSEMBLY PART NUMBER 177-9206- - -
 ASSEMBLY DESCRIPTION 5526 WK/ST W/ASYNC

LEGEND
 1: P=PHANTOM; 2: ITEM MASTER DELY CODE; 3: *=TAGGED OUT OF KIT(PRCD STR)

POSITION IN STRUCTURE	LEGEND	COMPONENT PART NUMBER	DESCRIPTION	E C N	QUANTITY PER ASSY	U/M	IML
1	2	3					
1		IN 187-9206- - -	5526 WK/ST W/ASYNC		1.0000	EACH	
2		IN 210-7236-A - -	7236A WK/STA 24K MEMORY MD 928	EC8920	1.0000	EACH	
3		IN 209-7236- - -	7236 WK/STA 24K MEMORY MDL 928		1.0000	EACH	
2		IN * 210-7425-A - -	7425-A WS CRT CNTL W/TC OPTION 60HZ		1.0000	EACH	
3		IN 209-7425- - -	7425 WS CRT CNTL W/TC OPTION 60HZ		1.0000	EACH	
4		IN 220-1103- - -	CRT BRD (W2)(COAX)B6482-122		1.0000	EACH	
2		IN 220-1143- - -	WIRE & LUG ASSY TYPE P065 D6482-12	EC8527	1.0000	EACH	
2		IN * 271-1122- - -	928 KEYBOARD & BP ASSY 6841-10		1.0000	EACH	
3		IN 210-7229- - -	7229 WS KEYBOARD	EC7259	1.0000	EACH	
2	P	FS 279-0322- - -	928 WK ST COM MECH W/ASYNC TC 60HZ		1.0000	EACH	
3		IN * 210-7156- - -	7156 PS REG W/CURRENTFOLD BACK		1.0000	EACH	
3		IN * 210-7227- - -	7227 MODULE(AUTO-INSERTED)		1.0000	EACH	
3		IN * 210-7230-A - -	7230A WS TC OPTION BOARD		1.0000	EACH	
4		IN 209-7230- - -	7230 WS TC OPTION BOARD		1.0000	EACH	
3		IN 220-0113- - -	2200 TC CABLE C6482-5	EC8585	1.0000	EACH	
3		IN 220-0148- - -	25° DUAL COAXIAL CABLE C6482-109		1.0000	EACH	
3		IN * 270-0345-2 - -	928 WK ST CHASSIS W/ASYNC TC		1.0000	EACH	
4		IN 210-7328-1 - -	PCB ASSY 5526A WS MTHRBD W/TC		1.0000	EACH	
5		IN 220-3014- - -	24 COND 14" FLAT CABLE J-6482-79		1.0000	EACH	
4		IN 220-1076- - -	POWER CORD ASSY(IF CHAS)B6482-95		1.0000	EACH	
4		IN 220-1101- - -	P054 WIRE&LUG ASSY(E CHAS)6482-12		1.0000	EACH	
4		IN * 270-0346-1 - -	WS POWER SUPPLY ASSY		1.0000	EACH	
5		IN 220-1042- - -	P022 WIRE & LUG ASSY(2LCRT)D6482-12		1.0000	EACH	
5		IN 220-1074- - -	CABLE PS/MB(IF CHASSIS)B6482-91		1.0000	EACH	
5		IN 220-1077- - -	P043 WIRE & LUG ASSY(IF CHAS)B648296		1.0000	EACH	
5		IN 220-1094- - -	P048 WIRE & LUG ASSY B		1.0000	EACH	
3		IN * 270-0360- - -	12" MONITOR & POWER SUPPLY ASSY		1.0000	EACH	
4		IN 270-0361- - -	POWER SUPPLY, 12" MONITOR		1.0000	EACH	
5		IN * 210-7255- - -	7255 MODULE (12" MONITOR)		1.0000	EACH	
6	P	IN 220-1107- - -	12" CRT POWER SUPPLY CABLE B6482-141	EC6389	1.0000	EACH	
4		IN * 270-0362- - -	12" MONITOR ASSY(LESS PWR SUPPLY)		1.0000	EACH	
5		IN * 210-7456- - -	PCB ASSY 2246 9" 12" MONITOR ELEC	EC8373	1.0000	EACH	
5		IN 220-0160- - -	BRIGHTNESS POT CABLE ASSY C6482-140	EC6389	1.0000	EACH	
5		IN 270-3068- - -	12" CRT HARNESS ASSY D6482-139	EC6389	1.0000	EACH	
5		IN 270-3092- - -	YOKE ASSY (12" MONITOR) B6482-246	EC7817	1.0000	EACH	
3		IN 272-0004- - -	928W2 BEZEL ASSY(ALUM TAPE) 6841-31		1.0000	EACH	
3		IN * 279-1015- - -	928WZ BASE ASSY(ALUM TAPE) 6841-30		1.0000	EACH	
3		IN * 279-4021- - -	928W2 COVER ASSY(ALUM TAPE) 6841-32		1.0000	EACH	

ASSEMBLY PART NUMBER 177-9206-A - -
 ASSEMBLY DESCRIPTION 5526A WK/ST W/ASYNC ASCII

LEGEND
 1: P=PHANTOM; 2: ITEM MASTER DELY CODE; 3: *=TAGGED OUT OF KIT(PROD STR)

POSITION IN STRUCTURE	LEGEND 1 2 3	COMPONENT PART NUMBER	DESCRIPTION	E C N	QUANTITY PER ASSY	U/M	IML
1		IN 187-9206-A - -	5526A WK/ST W/ASYNC ASCII				
2		IN 210-7236-A - -	7236A WK/STA 24K MEMORY MDL 928	EC8920	1.0000	EACH	
3		IN 209-7236- - -	7236 WK/STA 24K MEMORY MDL 928		1.0000	EACH	
2		IN * 210-7425-A - -	7425-A WS CRT CNTL W/TC OPTION 60HZ		1.0000	EACH	
3		IN 209-7425- - -	7425 WS CRT CNTL W/TC OPTION 60HZ		1.0000	EACH	
4		IN 220-1103- - -	CRT BRD (W2)(COAX)B6482-122		1.0000	EACH	
2		IN 220-1143- - -	WIRE & LUG ASSY TYPE P065 D6482-12	EC8527	1.0000	EACH	
2		IN * 271-1140- - -	928 KBD W/15 ASCII 6841-13		1.0000	EACH	
3		IN 210-7229- - -	7229 WS KEYBOARD		1.0000	EACH	
2	P	FS 279-0322- - -	928 WK ST COM MECH W/ASYNC TC 60HZ		1.0000	EACH	
3		IN * 210-7156- - -	7156 PS REG W/CURRENTFOLD BACK		1.0000	EACH	
3		IN * 210-7227- - -	7227 MODULE(AUTO-INSERTED)		1.0000	EACH	
3		IN * 210-7230-A - -	7230A WS TC OPTION BOARD		1.0000	EACH	
4		IN 209-7230- - -	7230 WS TC OPTION BOARD		1.0000	EACH	
3		IN 220-0113- - -	2200 TC CABLE C6482-5	EC8585	1.0000	EACH	
3		IN 220-0148- - -	25 DUAL COAXIAL CABLE C6482-109		1.0000	EACH	
3		IN * 270-0345-2 - -	928 WK ST CHASSIS W/ASYNC TC		1.0000	EACH	
4		IN 210-7328-1 - -	PCB ASSY 5526A WS MTHRBD W/TC		1.0000	EACH	
5		IN 220-3014- - -	24 COND 14" FLAT CABLE C-6482-79		1.0000	EACH	
4		IN 220-1076- - -	POWER CORD ASSY(F CHAS)B6482-95		1.0000	EACH	
4		IN 220-1101- - -	P054 WIRE&LUG ASSY(E CHAS)6482-12		1.0000	EACH	
4		IN * 270-0346-1 - -	WS POWER SUPPLY ASSY		1.0000	EACH	
5		IN 220-1042- - -	P022 WIRE & LUG ASSY(2LCRT)D6482-12		1.0000	EACH	
5		IN 220-1074- - -	CABLE PS/MB(F CHASSIS)B6482-91		1.0000	EACH	
5		IN 220-1077- - -	P043 WIRE & LUG ASSY(F CHAS)B648296		1.0000	EACH	
5		IN 220-1094- - -	P048 WIRE & LUG ASSY B		1.0000	EACH	
3		IN * 270-0360- - -	12" MONITOR & POWER SUPPLY ASSY		1.0000	EACH	
4		IN 270-0361- - -	POWER SUPPLY, 12" MONITOR		1.0000	EACH	
5	P	FS * 210-7255- - -	7255 MODULE (12" MONITOR)		1.0000	EACH	
6		IN 220-1107- - -	12" CRT POWER SUPPLY CABLE B6482-141	EC6389	1.0000	EACH	
4		IN * 270-0362- - -	12" MONITOR ASSY(LESS PWR SUPPLY)		1.0000	EACH	
5		IN * 210-7456- - -	PCB ASSY 2246 9"X12" MONITOR ELEC	EC8373	1.0000	EACH	
5		IN 220-0160- - -	BRIGHTNESS POT CABLE ASSY C6482-140	EC6389	1.0000	EACH	
5		IN 270-3068- - -	12" CRT HARNESS ASSY D6482-139	EC6389	1.0000	EACH	
5		IN 270-3092- - -	YOKE ASSY (12" MONITOR) B6482-246	EC7817	1.0000	EACH	
3		IN 272-0004- - -	928W2 BEZEL ASSY(ALUM TAPE) 6841-31		1.0000	EACH	
3		IN * 279-1015- - -	928WZ BASE ASSY(ALUM TAPE) 6841-30		1.0000	EACH	
3		IN * 279-4021- - -	928W2 COVER ASSY(ALUM TAPE) 6841-J2		1.0000	EACH	

MB0080-A

MULTI-LEVEL BILL OF MATERIAL AS OF

RUN DATE: 07/13/78

PAGE 1

ASSEMBLY PART NUMBER 177-9206-H - -
ASSEMBLY DESCRIPTION 5526H WK/ST W/ASYNC HORIZ SCROLL

LEGEND

1: P=PHANTOM; 2: ITEM MASTER DELY CODE; 3: *=TAGGED OUT OF KIT(PROD STR)

POSITION IN STRUCTURE	LEGEND	COMPONENT PART NUMBER	DESCRIPTION	E C N	QUANTITY PER ASSY	U/M	IML
1	IN	187-9206-H - -	5526H WK/ST W/ASYNC HORIZ SCROLL				
2	IN	210-7236-A - -	7236A WK/STA 24K MEMORY MD 928		1.0000	EACH	
3	IN	209-7236- - -	7236 WK/STA 24K MEMORY MDL 928	EC8920	1.0000	EACH	
2	IN *	210-7335-A - -	7335A WS WPD CONTROL W/TC OPTION		1.0000	EACH	
3	IN	209-7335- - -	7335 WS WPD CONTROL W/TC OPTION		1.0000	EACH	
4	IN	220-1103- - -	CRT BRD (W2)(COAX)B6482-122		1.0000	EACH	
2	IN	220-1143- - -	WIRE & LUG ASSY TYPE P065 D6482-12		1.0000	EACH	
2	IN *	271-1122- - -	928 KEYBOARD & BP ASSY 6841-10	EC8527	1.0000	EACH	
3	IN	210-7229- - -	7229 WS KEYBOARD	EC7259	1.0000	EACH	
2	P FS	279-0322- - -	928 WK ST COM MECH W/ASYNC TC 60HZ				
3	IN *	210-7156- - -	7156 PS REG W/CURRENTFOLD BACK		1.0000	EACH	
3	IN *	210-7227- - -	7227 MODULE(AUTO-INSERTED)		1.0000	EACH	
3	IN *	210-7230-A - -	7230A WS TC OPTION BOARD		1.0000	EACH	
4	IN	209-7230- - -	7230 WS TC OPTION BOARD		1.0000	EACH	
3	IN	220-0113- - -	2200 TC CABLE C6482-5				
3	IN	220-0148- - -	25 DUAL COAXIAL CABLE C6482-109	EC8585	1.0000	EACH	
4	IN *	270-0345-2 - -	928 WK ST CHASSIS W/ASYNC TC		1.0000	EACH	
5	IN	210-7328-1 - -	PCB ASSY 5526A WS MTHRBD W/TC		1.0000	EACH	
5	IN	220-3014- - -	24 COND 14*FLAT CABLE C-6482-79		1.0000	EACH	
4	IN	220-1076- - -	POWER CORD ASSY(F CHAS)B6482-95		1.0000	EACH	
4	IN	220-1101- - -	P054 WIRE&LUG ASSY(E CHAS)6482-12		1.0000	EACH	
4	IN *	270-0346-1 - -	WS POWER SUPPLY ASSY		1.0000	EACH	
5	IN	220-1042- - -	P022 WIRE & LUG ASSY(2LCRT)D6482-12		1.0000	EACH	
5	IN	220-1074- - -	CABLE PS/MB(F CHASSIS)B6482-91		1.0000	EACH	
5	IN	220-1077- - -	P043 WIRE & LUG ASSY(F CHAS)B648296		1.0000	EACH	
5	IN	220-1094- - -	P048 WIRE & LUG ASSY B		1.0000	EACH	
3	IN *	270-031- - -	12**MONITOR & POWER SUPPLY ASSY		1.0000	EACH	
4	IN	270-0361- - -	POWER SUPPLY,12**MONITOR		1.0000	EACH	
5	P FS *	210-7255- - -	7255 MODULE (12** MONITOR)		1.0000	EACH	
6	IN	220-1107- - -	12** CRT POWER SUPPLY CABLE B6482-141	EC6389	1.0000	EACH	
4	IN *	270-0362- - -	12** MONITOR ASSY(LESS PWR SUPPLY)		1.0000	EACH	
5	IN *	210-7456- - -	PCB ASSY 2246 9**12** MONITOR ELEC	EC6373	1.0000	EACH	
5	IN	220-0160- - -	BRIGHTNESS POT CABLE ASSY C6482-140	EC6389	1.0000	EACH	
5	IN	270-3068- - -	12** CRT HARNESS ASSY D6482-139	EC6389	1.0000	EACH	
5	IN	270-3092- - -	YOKE ASSY (12** MONITOR) B6482-246	EC7817	1.0000	EACH	
3	IN	272-0004- - -	928W2 BEZEL ASSY(ALUM TAPE) 6841-31		1.0000	EACH	
3	IN *	279-1015- - -	928WZ BASE ASSY(ALUM TAPE) 6841-30		1.0000	EACH	
3	IN *	279-4021- - -	928W2 COVER ASSY(ALUM TAPE) 6841-32		1.0000	EACH	

A-14

ASSEMBLY PART NUMBER 177-9206-M - -

LEGEND

ASSEMBLY DESCRIPTION 5526M WK/ST W/ASYNC 15 KEY NUM PAD 1: P=PHANTOM; 2: ITEM MASTER DELY CODE; 3: *=TAGGED OUT OF KIT(PROD STR)

POSITION IN STRUCTURE	LEGEND			COMPONENT PART NUMBER	DESCRIPTION	E C N	QUANTITY PER ASSY	U/M	IML
	1	2	3						
1	IN			187-9206-M - -	5526M WK/ST W/ASYNC 15 KEY NUM PAD		1.0000	EACH	
2	IN			210-7236-A - -	7236A WK/STA 24K MEMORY MD 928	EC8920	1.0000	EACH	
3	IN			209-7236 - - -	7236 WK/STA 24K MEMORY MDL 928		1.0000	EACH	
2	IN	*		210-7425-A - -	7425-A WS CRT CNTL W/TC OPTION 60HZ		1.0000	EACH	
3	IN			209-7425 - - -	7425 WS CRT CNTL W/TC OPTION 60HZ		1.0000	EACH	
4	IN			220-1103 - - -	CRT BRD (W2)(COAX)B6482-122		1.0000	EACH	
2	IN			220-1143 - - -	WIRE & LUG ASSY TYPE P065 D6482-12	EC8527	1.0000	EACH	
3	IN	*		271-1139 - - -	928 KEYBD W/15 KEY NUM PAD 6841-12		1.0000	EACH	
3	IN			210-7229 - - -	7229 WS KEYBOARD		1.0000	EACH	
2	P	FS		279-0322 - - -	928 WK ST COM MECH W/ASYNC TC 60HZ		1.0000	EACH	
3	IN	*		210-7156 - - -	7156 PS REG W/CURRENTFOLD BACK		1.0000	EACH	
3	IN	*		210-7227 - - -	7227 MODULE(AUTO-INSERTED)		1.0000	EACH	
3	IN	*		210-7230-A - -	7230A WS TC OPTION BOARD		1.0000	EACH	
4	IN			209-7230 - - -	7230 WS TC OPTION BOARD		1.0000	EACH	
3	IN			220-0113 - - -	2200 TC CABLE C6482-5	EC8585	1.0000	EACH	
3	IN			220-0148 - - -	25'DUAL COAXIAL CABLE C6482-109		1.0000	EACH	
3	IN	*		270-0345-2 - -	928 WK ST CHASSIS W/ASYNC TC		1.0000	EACH	
4	IN			210-7328-1 - -	PCB ASSY 5526A WS MTHRBD W/TC		1.0000	EACH	
5	IN			220-3014 - - -	24 COND 14"FLAT CABLE C-6482-79		1.0000	EACH	
4	IN			220-1076 - - -	POWER CORD ASSY(F CHAS)B6482-95		1.0000	EACH	
4	IN			220-1101 - - -	P054 WIRE&LUG ASSY(E CHAS)6482-12		1.0000	EACH	
4	IN	*		270-0346-1 - -	WS POWER SUPPLY ASSY		1.0000	EACH	
5	IN			220-1042 - - -	P022 WIRE & LUG ASSY(2LCRT)D6482-12		1.0000	EACH	
5	IN			220-1074 - - -	CABLE PS/MB(F CHASSIS)B6482-91		1.0000	EACH	
5	IN			220-1077 - - -	P043 WIRE & LUG ASSY(F CHAS)B648296		1.0000	EACH	
5	IN			220-1094 - - -	P048 WIRE & LUG ASSY B		1.0000	EACH	
3	IN	*		270-0360 - - -	12"MONITOR & POWER SUPPLY ASSY		1.0000	EACH	
4	IN			270-0361 - - -	POWER SUPPLY, 12"MONITOR		1.0000	EACH	
5	P	FS	*	210-7255 - - -	7255 MODULE (12" MONITOR)		1.0000	EACH	
6	IN			220-1107 - - -	12" CRT POWER SUPPLY CABLE B6482-141	EC6389	1.0000	EACH	
4	IN	*		270-0362 - - -	12" MONITOR ASSY(LESS PWR SUPPLY)		1.0000	EACH	
5	IN	*		210-7456 - - -	PCB ASSY 2246 9"X12" MONITOR ELEC	EC8373	1.0000	EACH	
5	IN			220-0160 - - -	BRIGHTNESS POT CABLE ASSY C6482-140	EC6389	1.0000	EACH	
5	IN			270-3068 - - -	12" CRT HARNESS ASSY D6482-139	EC6389	1.0000	EACH	
5	IN			270-3092 - - -	YOKE ASSY (12" MONITOR) B6482-246	EC7817	1.0000	EACH	
3	IN			272-0004 - - -	928W2 BEZEL ASSY(ALUM TAPE) 6841-31		1.0000	EACH	
3	IN	*		279-1015 - - -	928WZ BASE ASSY(ALUM TAPE) 6841-30		1.0000	EACH	
3	IN	*		279-4021 - - -	928W2 COVER ASSY(ALUM TAPE) 6841-32		1.0000	EACH	

A-15

MB0080-A

MULTI-LEVEL BILL OF MATERIAL AS OF

RUN DATE: 07/13/78

PAGE 1

ASSEMBLY PART NUMBER 177-9206-S - -
ASSEMBLY DESCRIPTION 55265 WK/ST W/ASYNC SPANISH

LEGEND

1: PHANTOM; 2: ITEM MASTER DELY CODE; 3: *-TAGGED OUT OF KIT(PROD STR)

POSITION IN STRUCTURE	LEGEND			COMPONENT PART NUMBER	DESCRIPTION	E C N	QUANTITY PER ASSY	U/M	IML
	1	2	3						
1				IN 187-9206-S - -	55265 WK/ST W/ASYNC SPANISH				
2				IN 210-7236-A - -	7236A WK/STA 24K MEMORY MD 928	EC8920	1.0000	EACH	
3				IN 209-7236- - -	7236 WK/STA 24K MEMORY MDL 928		1.0000	EACH	
2				IN * 210-7425-A - -	7425-A WS CRT CNTL W/TC OPTION 60HZ		1.0000	EACH	
3				IN 209-7425- - -	7425 WS CRT CNTL W/TC OPTION 60HZ		1.0000	EACH	
4				IN 220-1103- - -	CRT BRD (W2)(COAX)B6482-122		1.0000	EACH	
2				IN 220-1143- - -	WIRE & LUG ASSY TYPE P065 D6482-12	EC8527	1.0000	EACH	
3				IN * 271-1138- - -	928 KBD ASSY SPANISH 6841-11		1.0000	EACH	
3				IN 210-7229- - -	7229 WS KEYBOARD		1.0000	EACH	
2		P		FS 279-0322- - -	928 WK ST COM MECH W/ASYNC TC 60HZ		1.0000	EACH	
3				IN * 210-7156- - -	7156 PS REG W/CURRENTFOLD BACK		1.0000	EACH	
3				IN * 210-7227- - -	7227 MODULE(AUTO-INSERTED)		1.0000	EACH	
3				IN * 210-7230-A - -	7230A WS TC OPTION BOARD		1.0000	EACH	
4				IN 209-7230- - -	7230 WS TC OPTION BOARD		1.0000	EACH	
3				IN 220-0113- - -	2200 TC CABLE C6482-5	EC8585	1.0000	EACH	
3				IN 220-0148- - -	25* DUAL COAXIAL CABLE C6482-109		1.0000	EACH	
4				IN * 270-0345-2 - -	928 WK ST CHASSIS W/ASYNC TC		1.0000	EACH	
5				IN 210-7328-1 - -	PCB ASSY 5526A WS MTHRBD W/TC		1.0000	EACH	
5				IN 220-3014- - -	24 COND 14*FLAT CABLE C-6482-79		1.0000	EACH	
4				IN 220-1076- - -	POWER CORD ASSY(F CHAS)B6482-95		1.0000	EACH	
4				IN 220-1101- - -	P054 WIRE&LUG ASSY(E CHAS)B6482-12		1.0000	EACH	
4				IN * 270-0346-1 - -	WS POWER SUPPLY ASSY		1.0000	EACH	
5				IN 220-1042- - -	P022 WIRE & LUG ASSY(2LCRT)D6482-12		1.0000	EACH	
5				IN 220-1074- - -	CABLE PS/MB(F CHASSIS)B6482-91		1.0000	EACH	
5				IN 220-1077- - -	P043 WIRE & LUG ASSY(F CHAS)B648296		1.0000	EACH	
5				IN 220-1094- - -	P048 WIRE & LUG ASSY B		1.0000	EACH	
3				IN * 270-0360- - -	12* MONITOR & POWER SUPPLY ASSY		1.0000	EACH	
4				IN 270-0361- - -	POWER SUPPLY, 12* MONITOR		1.0000	EACH	
5		P		FS * 210-7255- - -	7255 MODULE (12* MONITOR)		1.0000	EACH	
6				IN 220-1107- - -	12* CRT POWER SUPPLY CABLE B6482-141	EC6389	1.0000	EACH	
4				IN * 270-0362- - -	12* MONITOR ASSY(LESS PWR SUPPLY)		1.0000	EACH	
5				IN * 210-7456- - -	PCB ASSY 2246 9*612* MONITOR ELEC	EC8373	1.0000	EACH	
5				IN 220-0160- - -	BRIGHTNESS POT CABLE ASSY C6482-140	EC6389	1.0000	EACH	
5				IN 270-3068- - -	12* CRT HARNESS ASSY D6482-139	EC6389	1.0000	EACH	
5				IN 270-3092- - -	YOKE ASSY (12* MONITOR) B6482-246	EC7817	1.0000	EACH	
3				IN 272-0004- - -	928W2 BEZEL ASSY(ALUM TAPE) 6841-31		1.0000	EACH	
3				IN * 279-1015- - -	928W2 BASE ASSY(ALUM TAPE) 6841-30		1.0000	EACH	
3				IN * 279-4021- - -	928W2 COVER ASSY(ALUM TAPE) 6841-32		1.0000	EACH	

A-16

ASSEMBLY PART NUMBER 187-9206- - -
 ASSEMBLY DESCRIPTION 5526 WK/ST W/ASYNC

LEGEND
 1: P=PHANTOM; 2: ITEM MASTER DELY CODE; 3: *=TAGGED OUT OF KIT(PROD STR)

POSITION IN STRUCTURE	LEGEND			COMPONENT PART NUMBER	DESCRIPTION	E C N	QUANTITY PER ASSY	U/M	IML
	1	2	3						
1		IN		210-7236-A - -	7236A WK/STA 24K MEMORY MD 928	EC8920	1.0000	EACH	
2		IN		209-7236- - -	7236 WK/STA 24K MEMORY MDL 928		1.0000	EACH	
1		IN	*	210-7425-A - -	7425-A WS CRT CNTL W/TC OPTION 60HZ		1.0000	EACH	
2		IN		209-7425- - -	7425 WS CRT CNTL W/TC OPTION 60HZ		1.0000	FACH	
3		IN		220-1103- - -	CRT BRD (W2)(COAX)B6482-122		1.0000	EACH	
1		IN		220-1143- - -	WIRE & LUG ASSY TYPE P065 D6482-12	EC8527	1.0000	EACH	
1		IN	*	271-1122- - -	928 KEYBOARD & BP ASSY 6841-10		1.0000	EACH	
2		IN		210-7229- - -	7229 WS KEYBOARD	EC7259	1.0000	EACH	
1		P	FS	279-0322- - -	928 WK ST CDM MECH W/ASYNC TC 60HZ		1.0000	EACH	
2		IN	*	210-7156- - -	7156 PS REG W/CURRENTFOLD BACK		1.0000	EACH	
2		IN	*	210-7227- - -	7227 MODULE(AUTO-INSERTED)		1.0000	EACH	
2		IN	*	210-7230-A - -	7230A WS TC OPTION BOARD		1.0000	EACH	
3		IN		209-7230- - -	7230 WS TC OPTION BOARD		1.0000	EACH	
2		IN		220-0113- - -	2200 TC CABLE C6482-5	EC8585	1.0000	EACH	
2		IN		220-0148- - -	25*DUAL COAXIAL CABLE C6482-109		1.0000	EACH	
2		IN	*	270-0345-2 - -	928 WK ST CHASSIS W/ASYNC TC		1.0000	EACH	
3		IN		210-7328-1 - -	PCB ASSY 5526A WS MTHRBD W/TC		1.0000	EACH	
4		IN		220-3014- - -	24 COND 14*FLAT CABLE C-6482-79		1.0000	EACH	
3		IN		220-1076- - -	POWER CORD ASSY(F CHAS)B6482-95		1.0000	EACH	
3		IN		220-1101- - -	P054 WIRE&LUG ASSY(E CHAS)6482-12		1.0000	EACH	
3		IN	*	270-0346-1 - -	WS POWER SUPPLY ASSY		1.0000	EACH	
4		IN		220-1042- - -	P022 WIRE & LUG ASSY(2LCRT)D6482-12		1.0000	EACH	
4		IN		220-1074- - -	CABLE PS/MB(F CHASSIS)B6482-91		1.0000	EACH	
4		IN		220-1077- - -	P043 WIRE & LUG ASSY(F CHAS)B648296		1.0000	EACH	
4		IN		220-1094- - -	P048 WIRE & LUG ASSY B		1.0000	EACH	
2		IN	*	270-0360- - -	12"MONITOR & POWER SUPPLY ASSY		1.0000	EACH	
3		IN		270-0361- - -	POWER SUPPLY,12"MONITOR		1.0000	EACH	
4		P	FS	210-7255- - -	7255 MODULE (12" MONITOR)		1.0000	EACH	
5		IN		220-1107- - -	12" CRT POWER SUPPLY CABLE B6482-141	EC6389	1.0000	EACH	
3		IN	*	270-0362- - -	12" MONITOR ASSY(LESS PWR SUPPLY)		1.0000	EACH	
4		IN	*	210-7456- - -	PCB ASSY 2246 9*12" MONITOR ELEC	EC8373	1.0000	EACH	
4		IN		220-0160- - -	BRIGHTNESS POT CABLE ASSY C6482-140	EC6389	1.0000	EACH	
4		IN		270-3068- - -	12" CRT HARNESS ASSY D6482-139	EC6389	1.0000	EACH	
4		IN		270-3092- - -	YOKE ASSY (12" MONITOR) B6482-246	EC7817	1.0000	EACH	
2		IN		272-0004- - -	928W2 BEZEL ASSY(ALUM TAPE) 6841-31		1.0000	EACH	
2		IN	*	279-1015- - -	928WZ BASE ASSY(ALUM TAPE) 6841-30		1.0000	EACH	
2		IN	*	279-4021- - -	928W2 COVER ASSY(ALUM TAPE) 6841-32		1.0000	EACH	

ASSEMBLY PART NUMBER 187-9206-A --
 ASSEMBLY DESCRIPTION 5526A WK/ST W/ASYNC ASCII

LEGEND
 1: P=PHANTOM; 2: ITEM MASTER DELY CODE; 3: *=TAGGED OUT OF KIT(PROD STR)

POSITION IN STRUCTURE	LEGEND			COMPONENT PART NUMBER	DESCRIPTION	E C N	QUANTITY PER ASSY	U/M	IML
	1	2	3						
1		IN		210-7236-A --	7236A WK/STA 24K MEMORY MD 928	EC8920	1.0000	EACH	
2		IN		209-7236-- --	7236 WK/STA 24K MEMORY MDL 928		1.0000	EACH	
1		IN	*	210-7425-A --	7425-A WS CRT CNTL W/TC OPTION 60HZ		1.0000	EACH	
2		IN		209-7425-- --	7425 WS CRT CNTL W/TC OPTION 60HZ		1.0000	EACH	
3		IN		220-1103-- --	CRT BRD (W2)(COAX)B6482-122		1.0000	EACH	
1		IN		220-1143-- --	WIRE & LUG ASSY TYPE P065 D6482-12	EC8527	1.0000	EACH	
1		IN	*	271-1140-- --	928 KBD W/15 ASCII 6841-13		1.0000	EACH	
2		IN		210-7229-- --	7229 WS KEYBOARD		1.0000	EACH	
1		P	FS	279-0322-- --	928 WK ST COM MECH W/ASYNC TC 60HZ		1.0000	EACH	
2		IN	*	210-7156-- --	7156 PS REG W/CURRENTFOLD BACK		1.0000	EACH	
2		IN	*	210-7227-- --	7227 MODULE(AUTO-INSERTED)		1.0000	EACH	
2		IN	*	210-7230-A --	7230A WS TC OPTION BOARD		1.0000	EACH	
3		IN		209-7230-- --	7230 WS TC OPTION BOARD		1.0000	EACH	
2		IN		220-0113-- --	2200 TC CABLE C6482-5	EC8585	1.0000	EACH	
2		IN		220-0148-- --	25* DUAL COAXIAL CABLE C6482-109		1.0000	EACH	
3		IN	*	270-0345-2 --	928 WK ST CHASSIS W/ASYNC TC		1.0000	EACH	
3		IN		210-7328-1 --	PCB ASSY 5526A WS MTHRBD W/TC		1.0000	EACH	
4		IN		220-3014-- --	24 COND 14*FLAT CABLE C-6482-79		1.0000	EACH	
3		IN		220-1076-- --	POWER CORD ASSY(F CHAS)B6482-95		1.0000	EACH	
3		IN		220-1101-- --	P054 WIRE&LUG ASSY(E CHAS)6482-12		1.0000	EACH	
3		IN	*	270-0346-1 --	WS POWER SUPPLY ASSY		1.0000	EACH	
4		IN		220-1042-- --	P022 WIRE & LUG ASSY(2LCRT)D6482-12		1.0000	EACH	
4		IN		220-1074-- --	CABLE PS/MB(F CHASSIS)B6482-91		1.0000	EACH	
4		IN		220-1077-- --	P043 WIRE & LUG ASSY(F CHAS)B648296		1.0000	EACH	
4		IN		220-1094-- --	P048 WIRE & LUG ASSY B		1.0000	EACH	
2		IN	*	270-0360-- --	12" MONITOR & POWER SUPPLY ASSY		1.0000	EACH	
3		IN		270-0361-- --	POWER SUPPLY, 12" MONITOR		1.0000	EACH	
4		P	FS	* 210-7255-- --	7255 MODULE (12" MONITOR)		1.0000	EACH	
5		IN		220-1107-- --	12" CRT POWER SUPPLY CABLE B6482-141	EC6389	1.0000	EACH	
3		IN	*	270-0362-- --	12" MONITOR ASSY(LESS PWR SUPPLY)		1.0000	EACH	
4		IN	*	210-7456-- --	PCB ASSY 2246 9*6 12" MONITOR ELEC	EC8373	1.0000	EACH	
4		IN		220-0160-- --	BRIGHTNESS POT CABLE ASSY C6482-140	EC6389	1.0000	EACH	
4		IN		270-3068-- --	12" CRT HARNESS ASSY D6482-139	EC6389	1.0000	EACH	
4		IN		270-3092-- --	YUKE ASSY (12" MONITOR) B6482-246	EC7817	1.0000	EACH	
2		IN		272-0004-- --	928W2 BEZEL ASSY(ALUM TAPE) 6841-31		1.0000	EACH	
2		IN	*	279-1015-- --	928WZ BASE ASSY(ALUM TAPE) 6841-30		1.0000	EACH	
2		IN	*	279-4021-- --	928W2 COVER ASSY(ALUM TAPE) 6841-32		1.0000	EACH	

A-18

ASSEMBLY PART NUMBER 187-9206-H - -
 ASSEMBLY DESCRIPTION 5526H WK/ST W/ASYNC HORIZ SCROLL

LEGEND
 1: P=PHANTOM; 2: ITEM MASTER DELY CODE; 3: *=TAGGED OUT OF KIT(PROD STR)

POSITION STRUCTURE	IN LEGEND 1 2 3	COMPONENT PART NUMBER	DESCRIPTION	E C N	QUANTITY PER ASSY	U/M	IML
1	IN	210-7236-A - -	7236A WK/STA 24K MEMORY MD 928	EC8920	1.0000	EACH	
2	IN	209-7236- - -	7236 WK/STA 24K MEMORY MDL 928		1.0000	EACH	
1	IN *	210-7335-A - -	7335A WS WPD CONTROL W/TC OPTION		1.0000	EACH	
2	IN	209-7335- - -	7335 WS WPD CONTROL W/TC OPTION		1.0000	EACH	
3	IN	220-1103- - -	CRT BRD (W2)(COAX)B6482-122		1.0000	EACH	
1	IN	220-1143- - -	WIRE & LUG ASSY TYPE P065 D6482-12	EC8527	1.0000	EACH	
1	IN *	271-1122- - -	928 KEYBOARD & BP ASSY 6841-10		1.0000	EACH	
2	IN	210-7229- - -	7229 WS KEYBOARD	EC7259	1.0000	EACH	
1	P FS	279-0322- - -	928 WK ST COM MECH W/ASYNC TC 60HZ		1.0000	EACH	
2	IN *	210-7156- - -	7156 PS REG W/CURRENTFOLD BACK		1.0000	EACH	
2	IN *	210-7227- - -	7227 MODULE(AUTO-INSERTED)		1.0000	EACH	
2	IN *	210-7230-A - -	7230A WS TC OPTION BOARD		1.0000	EACH	
3	IN	209-7230- - -	7230 WS TC OPTION BOARD		1.0000	EACH	
2	IN	220-0113- - -	2200 TC CABLE C6482-5	EC8585	1.0000	EACH	
2	IN	220-0148- - -	25"DUAL COAXIAL CABLE C6482-109		1.0000	EACH	
2	IN *	270-0345-2 - -	928 WK ST CHASSIS W/ASYNC TC		1.0000	EACH	
3	IN	210-7328-1 - -	PCB ASSY 5526A WS MTHRBD W/TC		1.0000	EACH	
4	IN	220-3014- - -	24 COND 14"FLAT CABLE C-6482-79		1.0000	EACH	
3	IN	220-1076- - -	POWER CORD ASSY(F CHAS)B6482-95		1.0000	EACH	
3	IN	220-1101- - -	P054 WIRE&LUG ASSY(E CHAS)6482-12		1.0000	EACH	
3	IN *	270-0446-1 - -	WS POWER SUPPLY ASSY		1.0000	EACH	
4	IN	220-1042- - -	P022 WIRE & LUG ASSY(2LCRT)D6482-12		1.0000	EACH	
4	IN	220-1074- - -	CABLE PS/MB(F CHASSIS)B6482-91		1.0000	EACH	
4	IN	220-1077- - -	P043 WIRE & LUG ASSY(F CHAS)B648296		1.0000	EACH	
4	IN	220-1094- - -	P048 WIRE & LUG ASSY B		1.0000	EACH	
2	IN *	270-0360- - -	12"MONITOR & POWER SUPPLY ASSY		1.0000	EACH	
3	IN	270-0361- - -	POWER SUPPLY,12"MONITOR		1.0000	EACH	
4	P FS *	210-7255- - -	7255 MODULE (12" MONITOR)		1.0000	EACH	
5	IN	220-1107- - -	12" CRT POWER SUPPLY CABLE B6482-141	EC6389	1.0000	EACH	
3	IN *	270-0362- - -	12" MONITOR ASSY(LESS PWR SUPPLY)		1.0000	EACH	
4	IN *	210-7456- - -	PCB ASSY 2246 9"612" MONITOR ELEC	EC8373	1.0000	EACH	
4	IN	220-0160- - -	BRIGHTNESS POT CABLE ASSY C6482-140	EC6389	1.0000	EACH	
4	IN	270-3068- - -	12" CRT HARNESS ASSY D6482-139	EC6389	1.0000	EACH	
4	IN	270-3092- - -	YOKE ASSY (12" MONITOR) B6482-246	EC7817	1.0000	EACH	
2	IN	272-0004- - -	928W2 BEZEL ASSY(ALUM TAPE) 6841-31		1.0000	EACH	
2	IN *	279-1015- - -	928W2 BASE ASSY(ALUM TAPE) 6841-30		1.0000	EACH	
2	IN *	279-4021- - -	928W2 COVER ASSY(ALUM TAPE) 6841-32		1.0000	EACH	

MB0080-A MULTI-LEVEL BILL OF MATERIAL AS OF

RUN DATE: 07/13/78

PAGE 1

ASSEMBLY PART NUMBER 187-9206-M --
 ASSEMBLY DESCRIPTION 5526M WK/ST W/ASYNC 15 KEY NUM PAD

LEGEND
 1: P=PHANTOM; 2: ITEM MASTER DELY CODE; 3: *=TAGGED OUT OF KIT(PROD STR)

POSITION IN STRUCTURE	LEGEND	COMPONENT PART NUMBER	DESCRIPTION	E C N	QUANTITY PER ASSY	U/M	IML
1	2	3					
1		IN 210-7236-A --	7236A WK/STA 24K MEMORY MD 928	EC8920	1.0000	EACH	
2		IN 209-7236- --	7236 WK/STA 24K MEMORY MDL 928		1.0000	EACH	
1		IN * 210-7425-A --	7425-A WS CRT CNTL W/TC OPTION 60HZ		1.0000	EACH	
2		IN 209-7425- --	7425 WS CRT CNTL W/TC OPTION 60HZ		1.0000	EACH	
3		IN 220-1103- --	CRT BRD (W2)(COAX)B6482-122		1.0000	EACH	
1		IN 220-1143- --	WIRE & LUG ASSY TYPE P065 D6482-12	EC8527	1.0000	EACH	
1		IN * 271-1139- --	928 KEYBD W/15 KEY NUM PAD 6841-12		1.0000	EACH	
2		IN 210-7229- --	7229 WS KEYBOARD		1.0000	EACH	
1	P	FS 279-0322- --	928 WK ST COM MECH W/ASYNC TC 60HZ		1.0000	EACH	
2		IN * 210-7156- --	7156 PS REG W/CURRENTFOLD BACK		1.0000	EACH	
2		IN * 210-7227- --	7227 MODULE(AUTO-INSERTED)		1.0000	EACH	
2		IN * 210-7230-A --	7230A WS TC OPTION BOARD		1.0000	EACH	
3		IN 209-7230- --	7230 WS TC OPTION BOARD		1.0000	EACH	
2		IN 220-0113- --	2200 TC CABLE C6482-5	EC8585	1.0000	EACH	
2		IN 220-0148- --	25° DUAL COAXIAL CABLE C6482-109		1.0000	EACH	
3		IN * 270-0345-2 --	928 WK ST CHASSIS W/ASYNC TC		1.0000	EACH	
4		IN 210-7328-1 --	PCB ASSY 5526A WS MTHRBD W/TC		1.0000	EACH	
4		IN 220-3014- --	24 COND 14"FLAT CABLE C-6482-79		1.0000	EACH	
3		IN 220-1076- --	POWER CORD ASSY(F CHAS)B6482-95		1.0000	EACH	
3		IN 220-1101- --	P054 WIRE&LUG ASSY(E CHAS)6482-12		1.0000	EACH	
3		IN * 270-0346-1 --	WS POWER SUPPLY ASSY		1.0000	EACH	
4		IN 220-1042- --	P022 WIRE & LUG ASSY(2LCRT)D6482-12		1.0000	EACH	
4		IN 220-1074- --	CABLE PS/MB(F CHASSIS)B6482-91		1.0000	EACH	
4		IN 220-1077- --	P043 WIRE & LUG ASSY(F CHAS)B648296		1.0000	EACH	
4		IN 220-1094- --	P048 WIRE & LUG ASSY B		1.0000	EACH	
2		IN * 270-0360- --	12" MONITOR & POWER SUPPLY ASSY		1.0000	EACH	
3		IN 270-0361- --	POWER SUPPLY, 12" MONITOR		1.0000	EACH	
4		IN * 210-7255- --	7255 MODULE (12" MONITOR)		1.0000	EACH	
5		IN 220-1107- --	12" CRT POWER SUPPLY CABLE B6482-141	EC6389	1.0000	EACH	
3		IN * 270-0362- --	12" MONITOR ASSY(LESS PWR SUPPLY)		1.0000	EACH	
4		IN * 210-7456- --	PCB ASSY 2246 9"X12" MONITOR ELEC	EC8373	1.0000	EACH	
4		IN 220-0160- --	BRIGHTNESS POT CABLE ASSY C6482-140	EC6389	1.0000	EACH	
4		IN 270-3068- --	12" CRT HARNESS ASSY D6482-139	EC6389	1.0000	EACH	
4		IN 270-3092- --	YOKER ASSY (12" MONITOR) B6482-246	EC7817	1.0000	EACH	
2		IN 272-0004- --	928W2 BEZEL ASSY(ALUM TAPE) 6841-31		1.0000	EACH	
2		IN * 279-1015- --	928WZ BASE ASSY(ALUM TAPE) 6841-30		1.0000	EACH	
2		IN * 279-4021- --	928W2 COVER ASSY(ALUM TAPE) 6841-32		1.0000	EACH	

A-20

ASSEMBLY PART NUMBER 187-9206-S - -
 ASSEMBLY DESCRIPTION 5526S WK/ST W/ASYNC SPANISH

LEGEND

1: P=PHANTOM; 2: ITEM MASTER DELY CODE; 3: *TAGGED OUT OF KIT(PROD STR)

POSITION IN STRUCTURE	LEGEND	COMPONENT PART NUMBER	DESCRIPTION	E C N	QUANTITY PER ASSY	U/M	IML
1	IN	210-7236-A - -	7236A WK/STA 24K MEMORY MD 928	EC8920	1.0000	EACH	
2	IN	209-7236- - -	7236 WK/STA 24K MEMORY MDL 928		1.0000	EACH	
1	IN *	210-7425-A - -	7425-A WS CRT CNTL W/TC OPTION 60HZ		1.0000	EACH	
2	IN	209-7425- - -	7425 WS CRT CNTL W/TC OPTION 60HZ		1.0000	EACH	
3	IN	220-1103- - -	CRT BRD (W2)(COAX)B6482-122		1.0000	EACH	
1	IN	220-1143- - -	WIRE & LUG ASSY TYPE P065 D6482-12	EC8527	1.0000	EACH	
1	IN *	271-1138- - -	928 KBD ASSY SPANISH 6841-11		1.0000	EACH	
2	IN	210-7229- - -	7229 WS KEYBOARD		1.0000	EACH	
1	P FS	279-0322- - -	928 WK ST COM MECH W/ASYNC TC 60HZ		1.0000	EACH	
2	IN *	210-7156- - -	7156 PS REG W/CURRENTFOLD BACK		1.0000	EACH	
2	IN *	210-7227- - -	7227 MODULE(AUTO-INSERTED)		1.0000	EACH	
2	IN *	210-7230-A - -	7230A WS TC OPTION BOARD		1.0000	EACH	
3	IN	209-7230- - -	7230 WS TC OPTION BOARD		1.0000	EACH	
2	IN	220-0113- - -	2200 TC CABLE C6482-5	EC8585	1.0000	EACH	
2	IN	220-0148- - -	25*DUAL COAXIAL CABLE C6482-109		1.0000	EACH	
3	IN *	270-0345-2 - -	928 WK ST CHASSIS W/ASYNC TC		1.0000	EACH	
4	IN	210-7328-1 - -	PCB ASSY 5526A WS MTHRBD W/TC		1.0000	EACH	
4	IN	220-3014- - -	24 COND 14*FLAT CABLE C-6482-79		1.0000	EACH	
3	IN	220-1076- - -	POWER CORD ASSY(F CHAS)B6482-95		1.0000	EACH	
3	IN	220-1101- - -	P054 WIRE&LUG ASSY(E CHAS)6482-12		1.0000	EACH	
3	IN *	270-0346-1 - -	WS POWER SUPPLY ASSY		1.0000	EACH	
4	IN	220-1042- - -	P022 WIRE & LUG ASSY(2LCRT)D6482-12		1.0000	EACH	
4	IN	220-1074- - -	CABLE PS/MB(F CHASSIS)B6482-91		1.0000	EACH	
4	IN	220-1077- - -	P043 WIRE & LUG ASSY(F CHAS)B648296		1.0000	EACH	
4	IN	220-1094- - -	P048 WIRE & LUG ASSY B		1.0000	EACH	
2	IN *	270-0360- - -	12" MONITOR & POWER SUPPLY ASSY		1.0000	EACH	
3	IN	270-0361- - -	POWER SUPPLY,12" MONITOR		1.0000	EACH	
4	P FS *	210-7255- - -	7255 MODULE (12" MONITOR)		1.0000	EACH	
5	IN	220-1107- - -	12" CRT POWER SUPPLY CABLE B6482-141	EC6389	1.0000	EACH	
3	IN *	270-0362- - -	12" MONITOR ASSY(LESS PWR SUPPLY)		1.0000	EACH	
4	IN *	210-7456- - -	PCB ASSY 2246 9"X12" MONITOR ELEC	EC8373	1.0000	EACH	
4	IN	220-0160- - -	BRIGHTNESS POT CABLE ASSY C6482-140	EC6389	1.0000	EACH	
4	IN	270-3068- - -	12" CRT HARNESS ASSY D6482-139	EC6389	1.0000	EACH	
4	IN	270-3092- - -	YOKE ASSY (12" MONITOR) B6482-246	EC7817	1.0000	EACH	
2	IN	272-0004- - -	928W2 BEZEL ASSY(ALUM TAPE) 6841-31		1.0000	EACH	
2	IN *	279-1015- - -	928W2 BASE ASSY(ALUM TAPE) 6841-30		1.0000	EACH	
2	IN *	279-4021- - -	928W2 COVER ASSY(ALUM TAPE) 6841-32		1.0000	EACH	

MB0080-A MULTI-LEVEL BILL OF MATERIAL AS OF

RUN DATE: 07/13/78

PAGE 1

ASSEMBLY PART NUMBER 270-0345-2 - -

ASSEMBLY DESCRIPTION 928 WK ST CHASSIS W/ASYNC TC

LEGEND

1: P=PHANTOM; 2: ITEM MASTER DELY CODE; 3: *=TAGGED OUT OF KIT(PROD STR)

POSITION STRUCTURE	IN LEGEND			COMPONENT PART NUMBER	DESCRIPTION	E C N	QUANTITY PER ASSY	U/M	IML
	1	2	3						
1		IN		210-7328-1 - -	PCB ASSY 5526A WS MTHRBD W/TC		1.0000	EACH	
2		IN		220-3014- - -	24 COND 14"FLAT CABLE C-6482-79		1.0000	EACH	
1		IN		220-1076- - -	POWER CORD ASSY(F CHAS)B6482-95		1.0000	EACH	
1		IN		220-1101- - -	P054 WIRE&LUG ASSY(E CHAS)6482-12		1.0000	EACH	
1		IN *		270-0346-1 - -	WS POWER SUPPLY ASSY		1.0000	EACH	
2		IN		220-1042- - -	P022 WIRE & LUG ASSY(2LCRT)D6482-12		1.0000	EACH	
2		IN		220-1074- - -	CABLE PS/MB(F CHASSIS)B6482-91		1.0000	EACH	
2		IN		220-1077- - -	P043 WIRE & LUG ASSY(F CHAS)B648296		1.0000	EACH	
2		IN		220-1094- - -	P048 WIRE & LUG ASSY B		1.0000	EACH	

ASSEMBLY PART NUMBER 279-0322- - -

LEGEND

ASSEMBLY DESCRIPTION 928 WK ST COM MECH W/ASYNC TC 60HZ 1: P=PHANTOM; 2: ITEM MASTER DELY CODE; 3: *=TAGGED OUT OF KIT(PROD STR)

POSITION STRUCTURE	LEGEND			COMPONENT PART NUMBER	DESCRIPTION	E C N	QUANTITY PER ASSY	U/M	IML
	1	2	3						
1				IN * 210-7156- - -	7156 PS REG W/CURRENTFOLD BACK		1.0000	EACH	
1				IN * 210-7227- - -	7227 MODULE(AUTO-INSERTED)		1.0000	EACH	
1				IN * 210-7230-A - - -	7230A WS TC OPTION BOARD		1.0000	EACH	
2				IN 209-7230- - -	7230 WS TC OPTION BOARD		1.0000	EACH	
1				IN 220-0113- - -	2200 TC CABLE C6482-5	EC8585	1.0000	EACH	
1				IN 220-0148- - -	25*DUAL COAXIAL CABLE C6482-109		1.0000	EACH	
1				IN * 270-0345-2 - - -	928 WK ST CHASSIS W/ASYNC TC		1.0000	EACH	
2				IN 210-7328-1 - - -	PCB ASSY 5526A WS MTHRBL W/TC		1.0000	EACH	
3				IN 220-3014- - -	24 COND 14"FLAT CABLE C-6482-79		1.0000	EACH	
2				IN 220-1076- - -	POWER CORD ASSY(F CHAS)B6482-95		1.0000	EACH	
2				IN 220-1101- - -	P054 WIRE&LUG ASSY(E CHAS)6482-12		1.0000	EACH	
2				IN * 270-0346-1 - - -	WS POWER SUPPLY ASSY		1.0000	EACH	
3				IN 220-1042- - -	P022 WIRE & LUG ASSY(2LCRT)D6482-12		1.0000	EACH	
3				IN 220-1074- - -	CABLE PS/MB(F CHASSIS)B6482-91		1.0000	EACH	
3				IN 220-1077- - -	P043 WIRE & LUG ASSY(F CHAS)B648296		1.0000	EACH	
3				IN 220-1094- - -	P048 WIRE & LUG ASSY B		1.0000	EACH	
1				IN * 270-0360- - -	12"MONITOR & POWER SUPPLY ASSY		1.0000	EACH	
2				IN 270-0361- - -	POWER SUPPLY,12"MONITOR		1.0000	EACH	
3		P		FS * 210-7255- - -	7255 MODULE (12" MONITOR)		1.0000	EACH	
4				IN 220-1107- - -	12" CRT POWER SUPPLY CABLE B6482-141	EC6389	1.0000	EACH	
2				IN * 270-0362- - -	12" MONITOR ASSY(LESS PWR SUPPLY)		1.0000	EACH	
3				IN * 210-7456- - -	PCB ASSY 2245 9"612" MONITOR ELEC	EC8373	1.0000	EACH	
3				IN 220-0160- - -	BRIGHTNESS POT CABLE ASSY C6482-140	EC6389	1.0000	EACH	
3				IN 270-3068- - -	12" CRT HARNESS ASSY D6482-139	EC6389	1.0000	EACH	
3				IN 270-3092- - -	YOKE ASSY (12" MONITOR) B6482-246	EC7817	1.0000	EACH	
1				IN 272-0004- - -	928W2 BEZEL ASSY(ALUM TAPE) 6841-31		1.0000	EACH	
1				IN * 279-1015- - -	928WZ BASE ASSY(ALUM TAPE) 6841-30		1.0000	EACH	
1				IN * 279-4021- - -	928WZ COVER ASSY(ALUM TAPE) 6841-32		1.0000	EACH	

A-23

MB0080-A MULTI-LEVEL BILL OF MATERIAL AS OF

RUN DATE: 07/13/78

PAGE 1

ASSEMBLY PART NUMBER 279-0322-1 - -
 ASSEMBLY DESCRIPTION 928 WK ST COM MECH W/ASYNC TC 50HZ

LEGEND
 1: P=PHANTOM; 2: ITEM MASTER DELY CODE; 3: *=TAGGED OUT OF KIT(PROD STR)

POSITION IN STRUCTURE	LEGEND	COMPONENT PART NUMBER	DESCRIPTION	E C N	QUANTITY PER ASSY	U/M	IML
1	IN *	210-7156-	7156 PS REG W/CURRENTFOLD BACK				
1	IN *	210-7227-	7227 MODULE(AUTO-INSERTED)		1.0000	EACH	
1	IN *	210-7230-A	7230A WS TC OPTION BOARD		1.0000	EACH	
2	IN	209-7230-	7230 WS TC OPTION BOARD		1.0000	EACH	
1	IN	220-0113-	2200 TC CABLE C6482-5		1.0000	EACH	
1	IN	220-0148-	25"DUAL COAXIAL CABLE C6482-109	EC8585	1.0000	EACH	
1	IN	220-1104-	CABLE,CRT(COAX) B6482-123		1.0000	EACH	
1	IN *	270-0345-2	928 WK ST CHASSIS W/ASYNC TC		1.0000	EACH	
2	IN	210-7328-1	PCB ASSY 5526A WS MTHRBD W/TC		1.0000	EACH	
3	IN	220-3014-	24 COND 14*FLAT CABLE C-6482-79		1.0000	EACH	
2	IN	220-1076-	POWER CORD ASSY(F CHAS)B6482-95		1.0000	EACH	
2	IN	220-1101-	P054 WIRE&LUG ASSY(E CHAS)6482-12		1.0000	EACH	
2	IN *	270-0346-1	WS POWER SUPPLY ASSY		1.0000	EACH	
3	IN	220-1042-	P022 WIRE & LUG ASSY(2LCRT)D6482-12		1.0000	EACH	
3	IN	220-1074-	CABLE PS/MB(F CHASSIS)B6482-91		1.0000	EACH	
3	IN	220-1077-	P043 WIRE & LUG ASSY(F CHAS)B648296		1.0000	EACH	
3	IN	220-1094-	P048 WIRE & LUG ASSY B		1.0000	EACH	
1	IN	272-0004-	928W2 BEZEL ASSY(ALUM TAPE) 6841-31		1.0000	EACH	
1	IN *	279-1015-	928WZ BASE ASSY(ALUM TAPE) 6841-30		1.0000	EACH	
1	IN *	279-4021-	928W2 COVER ASSY(ALUM TAPE) 6841-32		1.0000	EACH	

END OF REPORT MB0080-A

APPENDIX

B

T.C. WORKSTATION

ELECTRONIC

SCHEMATICS

THE SCHEMATICS, WHEN AVAILABLE, ARE ON THE LAST FICHE IN THIS SET.

**NEWS
LETTER
NO. 51.1**

CUSTOMER ENGINEERING WORD PROCESSING NEWSLETTER NO. 51.1

CONFORM/EXECUTE	
INFORMATION ONLY	X

SYSTEMS 10/20/30

OCTOBER 24, 1978

MODEL 5595-4 ASYNCHRONOUS COMMUNICATIONS OPTION "PARTIAL"

(UPDATE TO AND CORRECTIONS FOR WPNL 51 - 14 JULY 1978)

This newsletter contains the following information:

* **WPS Telecommunications Software Corrections and Improvements:**

Release 15. X T5/5.X T5

(Refer to page 9, paragraph 3.3 of WPNL 51)

* **928 T.C. Workstation Diagnostic User Manual:**

Off-Line/On-Line Master Release R1.0

and

Off-Line/On-Line Event Handler Release E1.0

(Refer to page 4-1, paragraph 4.2 of WPNL 51)



LABORATORIES, INC.

ONE INDUSTRIAL AVENUE LOWELL MASSACHUSETTS 01851. TEL (617) 851-4111. TWX 710 343-6769. TELEX 94 7421

TABLE OF CONTENTS

HEADING	TITLE	PAGE
SECTION I:	WPS TELECOMMUNICATIONS SOFTWARE CORRECTIONS AND IMPROVEMENTS	

(Release 15.X T5/5.X T5)
 (Refer to Page 9, Paragraph 3.3 of WPNL 51
 - 14 July 78)

SECTION II: 928 T.C. WORKSTATION DIAGNOSTIC USER MANUAL

(For Off Line/On Line Master Release R 1.0
 and
 Off Line/On Line Event Handler Release E 1.0)
 (Refer to Page 4-1, Paragraph 4.2 of WPNL 51
 - 14 July 78)

2.1	GENERAL	2-1
2.2	928 T.C. WORKSTATION DIAGNOSTIC USER MANUAL	2-2
	A. On-Line Loading Procedures for the 928 System 20 TC Workstation	2-2
	B. On-Line Loading Procedures for the 928 System 30 TC Workstation	2-2
	C. To Load a 928 System 20 or System 30 by IPL	2-3
	D. General Loading Procedures	2-4
2.3	TESTS, ERRORS AND EXPLANATIONS.....	2-9
	A. TEST ZERO.....	2-9
	1. Initial 8080 Test	2-9
	a. Description	2-9
	b. Messages	2-9
	c. Errors: Code Hardware Error	2-9
	d. Error/Hardware	2-9
	e. Equates and Storage Area	2-9
	f. Data that was Transferred	2-9

TABLE OF CONTENTS (Cont.)

B.	TEST ONE	2-10
1.	Read TCS Port ID Switches	2-10
a.	Description	2-10
b.	Messages	2-10
c.	Errors	2-10
d.	Hardware	2-10
C.	TEST TWO	2-11
1.	Reads TCS Device Option Switch	2-11
a.	Description	2-11
b.	Message	2-11
c.	Errors	2-11
d.	Hardware	2-11
D.	TEST THREE	2-12
1.	Initial Port Access to USART	2-12
a.	Description	2-12
b.	Message	2-12
c.	Errors	2-12
d.	Error/Hardware	2-12
e.	Storage Area	2-12
E.	TEST FOUR	2-13
1.	Asynchronous I/O Test at 2400 BAUD	2-13
a.	Description	2-13
b.	Environment	2-13
c.	Messages	2-13
d.	Errors	2-13
e.	Error/Hardware	2-15
f.	Status Information Stored for Reference ...	2-15
F.	TEST FIVE	2-16
1.	Interrupt Path Test	2-16
a.	Description	2-16
b.	Message	2-16
c.	Errors	2-16
d.	Error/Hardware	2-17
e.	Storage Area	2-17

TABLE OF CONTENTS (Cont.)

G.	TEST SIX	2-18
1.	Interval Timer Test	2-18
a.	Description	2-18
b.	Messages	2-18
c.	Errors	2-18
d.	Error/Hardware	2-18
H.	TEST SEVEN	2-18
1.	Asynchronous Mode Test at 2400 BAUD	2-19
a.	Description	2-19
b.	Messages	2-19
c.	Errors	2-19
d.	Error/Hardware	2-20
I.	TEST EIGHT	2-21
1.	Optional Asynchronous Mode Test	2-21
a.	Description	2-21
b.	Messages	2-21
c.	Errors	2-21
d.	Error/Hardware	2-22
J.	TEST NINE	2-23
1.	Operator Aid	2-23
a.	Description	2-23
b.	Messages	2-23
c.	Errors	2-23
d.	Mode	2-24
2.4	GENERAL INFORMATION FOR USART COMMAND AND STATUS BYTES	2-25
A.	STATUS BYTES CONFIGURATION	2-25
B.	STATUS WORD	2-25
C.	COMMAND MODE WORD FOR ASYNCHRONOUS MODE	2-25
D.	DEFINITION OF BIT LOCATIONS	2-25
E.	SPECIAL INFORMATION ON CHIPS	2-26

LIST OF ILLUSTRATIONS

FIGURE NO.	TITLE	PAGE
FIGURE 2-1	INITIAL PROMPT MESSAGES	2-6
FIGURE 2-2	FULL SCREEN INITIAL DISPLAY	2-6
FIGURE 2-3	SAMPLE OF SCREEN DISPLAY AFTER A RUN OF ONE LOOP WITH ERRORS	2-7
FIGURE 2-4	25 PIN RS-232-C MAIL CONNECTOR (W.L. PART #350-1030) WIRING FOR LOOPBACK CONNECTOR	2-8

LIST OF TABLES

TABLE NO.	TITLE	PAGE
TABLE 1-1	REV. 15 X T5. XT5 - COM DISK MAP - DISK ADDRESS ORDER	1-4
TABLE 2-1	TEST PARAMETERS FOR TEST EIGHT	2-24

SECTION I

(REFER TO PAGE 9, PARAGRAPH 3.3 OF WPNL 51 - 14 JULY 78)

WPS TELECOMMUNICATIONS SOFTWARE CORRECTIONS AND IMPROVEMENTS

(Release 15.X T5/5.X T5)

The following corrections and improvements for asynchronous emulators are included in the current release:

1. Names for asynchronous connections have been changed for ease of entry and to provide a host/terminal option for teletype.
 - a. tty: Teletype terminal mode (formally TTY) assumes the terminal role and starts in send mode.
 - b. ttyh: Teletype host mode (new) assumes the host role and starts in receive mode.
 - c. 2741: 2741 terminal mode (formally 2741t) assumes the terminal role and starts in send mode.
 - d. 2741h: 2741 host mode remains the same.
2. For both tty and 2741, a problem which prevented tabs from being set has been corrected.
3. For both tty and 2741, a Break may now be sent through the 1st and 2nd channels by turning off Secondary Request to Send.
4. Teletype connections include specifications to insert an End of Line (EOL) sequence of up to 3 characters. These are:

tty: Hex OD (CR).

ttyh: Hex OD, OA (CR, LF).

These specifications can be changed by SZAPing the connection specification in the CSB as follows:

- a. Find the connection spec in the CSB (the first 8 bytes contain the connection name) and add hex 28 to the offset of the first byte. This give the offset of the first byte of the End of Line (EOL) sequence.
- b. Note that the current contents should be OD, FF or OD, OA, FF for terminal and host respectively. Enter up to 3 characters, followed by FF to mark the end of the sequence.
- c. Example: The End of Line sequence for "tty" is in CSB-2 and is located at track 2F, sector 04, byte 30 of the R15.X T5 Comm 20 diskette and contains the hex characters OD FF. Beginning at byte 30, enter up to 3 new EOL characters, followed by hex FF.

The End of Line sequence for "ttyh" is in CSB-3 and is located at track 2F, sector 05, byte 30 of the 15.X T5 Comm 20 diskette and contains the hex characters OD, OA, FF.

5. For tty, the Line Feed (LF) function after Carriage Return (CR) is sent or received is no longer supported. The LF function is controlled by the far end.
6. In host mode, (ttyh) the telephone sends Line Feed (LF) and does a Line Feed after Carriage Return (CR) is received.
7. For a teletype in "send" state, Request to Send will always be on and received characters will be ignored. Receiving an End of Transmission (EOT) causes entry into "send" state. To enable other characters to do this, SZAP their value(s) in the ASCII to WWPS table to hex C2.
8. The teletype "Stop Send" key will send the "End of Line" sequence and allow the line to turn around (go into receive mode).
9. During teletype send, Control D (EOT), Control M (CR) and Control T (DC4) will cause a line turnaround.

10. In teletype, received DEL's will be ignored, as will any character with a hex value of 80 or greater.
11. A teletype problem caused by the sequence "CR" sent and "LF" received has been corrected.
12. The timing of the teletype "Break" character has been fixed at 200 msec.
13. Teletype "Break" can be sent anytime, regardless of being in send or receive mode.
14. A teletype session can be cancelled while in receive mode.
15. In 2741, both host and terminal modes can transmit continuously from a document. Only a received "Break" stops transmission of the document.
16. The 2741 "Stop Send" key will send "New Line, End of Transmission" (NL, EOT).
17. All function keys that are not used for the 2741 are ignored. Formerly they would cause a character to be sent.
18. To correct a 2741 connection problem, a downshift will not automatically be sent following the "End of Address" (EOA) when the Data Set Ready line comes on. If the host requires a bid sequence of "EOA, EOT", depress the "Attn" key to send the "EOT".

TABLE 1-1

REV. 15. X T5 - COM DISK MAP - DISK ADDRESS ORDER

Reserved for MSL's	2D,00	-	2F,00
Black Box IPL	2F,01		
WWPS to ASCII	2F,02		
ASCII to WWPS	2F,03		
CSB-2, CSB-3	2F,04	-	2F,05
Spare	2F,06	-	2F,0F
TC Intial Load	30,00	-	30,09
TC Common	30,00	-	30,04
PL/M IPL	30,05	-	30,08
Move Rtn	30,09		
Initiate Session	30,0A	-	30,0F
Send IO Utility	31,00	-	31,03
Recv IO Utility	31,04	-	31,0D
WWPS to EBCDIC	31,0E		
EBCDIC TO WWPS	31,0F		
Send File Utility	32,00	-	32,06
Recv File Utility	32,07	-	32,0A
Batch Driver-Main	32,0B	-	32,0F
Bisync Send Data U	33,00	-	33,05
Batch Driver-Send	33,06	-	33,0A
Batch Driver-Recv	33,0B	-	33,0F
Bisync Xmission U	34,00	-	34,0A
Menu 23 Overflow	34,0B		
CSB - 1	34,0C		
Establish Connection	..	34,0D	-	34,0E
BCB - Async	34,0F		
Bisync Recv Data U	35,00	-	35,05
Buffer Routines	35,06		
MSL	35,07		
Print Queue	35,08		
QCB	35,09		
Admin Block	35,0A		
MDB	35,0B		
QCB Initial	35,0C		

TABLE 1-1 (CONT'D)

REV. 15. X T5 - COM DISK MAP - DISK ADDRESS ORDER

SCB Initial	35,0D
MCB	35,0E
BCB - Batch Bisync	35,0F
PSB	36,00
Menus - 09	36,01 - 36,03
- 18	36,04 - 36,05
- 19	36,06 - 36,08
- 20	36,09 - 36,0A
- 21	36,0B - 36,0C
- 22	36,0D - 36,0E
- 23	36,0F (+34,0B)
PAK 4 -	37,00 - 39,09
Menus 6	37,00 - 37,0F
Menus 7	38,00 - 38,0C
Menus 8	38,0D - 39,09
PAK 5 - Menus 9	39,0A - 3A,09
Work Station IPL	3A,0A
Interactive Driver	3A,0B - 3A,0F
Async Xmission U	3B,00 - 3C,03
Spare	3C,04 - 3C,05
MCB - OCR	3C,06
BCB - OCR	3C,07
Admin Block - OCR	3C,08
SCB Initial - OCR	3C,09
OCR to WWPS	3C,0A - 3C,0F
OCR Xmission Utility ..	3D,00 - 3D,04
OCR Driver	3D,05 - 3D,06
WWPS to Corr.....	3D,07
Corr. to WWPS (1)	3D,08
WWPS to Corr. (u).....	3D,08
2741 State Tables	3D,0A - 3E,02
TTY State Tables	3E,03 - 3E,0B

SECTION II

(REFER TO PAGE 4-1, PARAGRAPH 4.2 OF WPNL 51 - 14 JULY 1978)

928 T.C. WORKSTATION DIAGNOSTIC USER MANUAL

(For Off Line/On Line Master Release R 1.0

and

Off Line/On Line Event Handler Release E 1.0)

2.1 GENERAL

The 928 T.C. workstation diagnostic is a complete diagnostic for testing the 5595-4 telecommunications option. The option is contained on the 210-7230 PCB. All that is necessary for the test is a T.C. workstation, diagnostic diskette and a loopback connector, described in Figure 2-4. The diagnostic contains 10 separate tests. Test 0 thru 7 will be run without choice in the automatic mode or any test can run individually in the non-automatic mode. In the non-automatic mode, any test can be run either single pass or multiple pass. A choice of "Halt On Error" or "Continue On Error" may be made along with a choice of looping on the test or looping on the error. Errors are displayed by error code and test number. These are followed by the display of a particular I.C.(s) that may be the cause of the error. The Users Manual also contains the list of errors and I.C.s and pin numbers associated with the errors. The Users Manual also contains complete loading and operating instructions. The following is the purpose of each test.

Test 0 - Verify data buss integrity and 8080 memory read/write capability.

Test 1 - Check port I.D. switches.

Test 2 - Check device option switch.

Test 3 - Verify port access commands to the USART.

Test 4 - Test the transmit/receive logic.

Test 5 - Check USART and interval timer generated interrupts.

Test 6 - Check interval timer clock. (Ref. Note 1)

Test 7 - Asynchronous transmission test.

Test 8 - Optional asynchronous transmission test. (Ref. Note 2)

Test 9 - Operator aid.

NOTE 1: - At present, it is possible to receive false interval timer errors even though the timer is working. This because the tolerance of the diagnostic is more critical than the tolerance of the timer hardware. Both the hardware and the diagnostic are in the process of being corrected.

NOTE 2: - Test 9 (Operator Aid) must be run to specify USART parameters for test 8.

2.2 928 T.C. WORKSTATION DIAGNOSTIC USER MANUAL

A. On-Line Loading Procedures for the 928 System 20 TC Workstation

1. Insert diagnostic diskette into the System diskette slot (right drive).
2. Power off slave to be tested.
3. Power on slave to be tested.
4. Initial prompt message should appear. (Figure 2-1)
5. Go to General Loading Procedures.

B. On-Line Loading Procedures for the 928 System 30 TC Workstation

- 1 Insert diagnostic diskette into Archive diskette slot (left drive).

2. Select the alternate menu on the T.C. Workstation to be tested.
3. Select function 'EDIT OLD GLOSSARY'.

INPUT "0000D" and then key execute.
4. Initial prompt message should appear. (Figure 2-1)
5. Go to General Loading Procedures.

C. To Load a 928 System 20 or System 30 by IPL

1. Insert diagnostic diskette into System diskette drive (right drive). Insert diskette into archive drive and change disk-select switch to 'UP' position for System 30.
2. Depress IPL/Master Reset Button.
3. Initial prompt message should appear on all CRT Workstations that are powered up. Test only T.C. Workstations.
4. Go to General Loading procedure.

NOTE: - Loading procedures are identical for R-Type or E.H. Type Master CPU's. The correct T.C. Diagnostic platter must be used for the corresponding CPU Type.

D. General Loading Procedures

1. When Figure 2-1 appears on the CRT, the operator is prompted by a blinking "?" (question mark).

Key "a" to set auto mode. Auto mode will run a complete confidence/Burn-in Test on the T.C. circuitry. (Test 0-7)

Key "n" for non-auto mode. (Any test)
2. Select run mode as follows: (Non-auto mode only)
Key "s" for single pass
Key "m" for multiple pass
3. Test selection parameters should then be displayed. See Figure 2-2.
4. Select the tests to be executed by using the space bar to move the cursor to the selected test, typing "y" or "n" for appropriate tests.
5. Run-time test sequence is from top to bottom.
6. Keys available are backspace, space, y, n, cancel, and execute.
7. If test 9 was selected, this aid will be executed first.
8. The program may be restarted at any time by keying the 'cancel' key.
9. If an error is found and 'continue on error' is not selected, depressing any key except 'cancel' will restart that test.
10. Whenever a Blinking Hi-Intensity Character is on the screen, it indicates a test condition.

11. All Hi-Intensity Characters are Test Mode Parameters.
12. Whenever an error condition occurs, two messages appear on the screen; an error code with the corresponding test that it occurred in and chip/s numbers of expected bad components, the first chip listed being the one most likely suspected. Further definition of the error conditions can be found in the test description in this user manual.
13. In the test description, under the heading of "ERROR/HARDWARE", the error message is repeated with the pin location of the signal being generated. These have been given in order that the operator may be able to "scope" the problem signal.

WP TELECOMMUNICATIONS WORKSTATION DIAGNOSTICS REL 1.0 (NEEDS LOOP BACK PLUG) (See Figure 2-4).
AUTOMATIC/NONAUTOMATIC (a/n) ? SINGLE/MULTIPLE PASS (s/m)?

**FIGURE 2-1
INITIAL PROMPT MESSAGES**

WP TELECOMMUNICATIONS WORKSTATION DIAGNOSTICS REL 1.0 (NEEDS LOOP BACK PLUG)
AUTOMATIC/NONAUTOMATIC (a/n) a SINGLE/MULTIPLE PASS (s/m) m FAULT ISOLATION TEST PARAMETERS. SELECT TESTS TO BE PERFORMED TYPE y/n ONLY

TEST0	n
TEST1	n
TEST2	n
TEST3	n
TEST4	n
TEST5	n
TEST6	n
TEST7	n
TEST8	n
TEST9	n
CONT N ERR	n
LOOP N ERR	n
LOOP N TST	n

**FIGURE 2-2
FULL SCREEN INITIAL DISPLAY**

	14	15	16	17	18	19	20	21	22	23	24	25	
	1	2	3	4	5	6	7	8	9	10	11	12	13
Jumper	PIN	to	PIN										
	2		3										
	4		5										
	11		12										
	6		20										
	20		8										

FIGURE 2-4
25 PIN RS-232-C MAIL CONNECTOR
(W.L. PART #350-1030)
WIRING FOR LOOPBACK CONNECTOR

2.3 TESTS, ERRORS AND EXPLANATIONS

A. TEST ZERO

1. Initial 8080 Test

a. Description

Section 1 of this test verifies data bus integrity and 8080 memory read/write capability. This is done by copying a block of test words (16 bytes) from one location to another and verifying their proper transfer. Flags "FLAG1D", "FLAG2D", and "FLAG3D" are an indication to the master that each respective part has been completed.

b. Messages None

c. Errors Code Hardware Error

1. Error in data bus integrity or read/write lines.
2. Error in stack pushes-read/write stack.
3. Error in stack pops-read/write.

d. Error/Hardware

Code Hardware

1. 8080A
2. 8080A
3. 8080A

e. Equates and Storage Area

FLAG1D	LOCATION = 02CE
FLAG2D	LOCATION = 02CD
FLAG3D	LOCATION = 20CE
BLOCK1	LOCATION = 02CFH
BLOCK2	LOCATION = 02D9H
BLOCK3	LOCATION = 02E9H
BLOCK4	LOCATION = 0309H

f. Data that was Transferred

0AA55H, 0201H, 0804H, 2010H, 8040H

C. TEST TWO

1. Reads TCS Device Option Switch

a. Description Does an "IN 07H" and displays results to the screen.

b. Message "Device options byte ##, switch 5-4-3-2-1"
.
X X X X X
X DEFINE AS:+ = ON - = OFF

c. Errors There are no errors reported by this test.

d. Hardware Device options sense switch dip bank, L11

D. TEST THREE

1. Initial Port Access to USART

a. Description This test verifies for various port access commands to check if access can be made. All latest inputs are stored for future reference. Ten passes on each subroutine are made to insure that the test is complete.

b. Messages None •

c. Errors Code / Description

01 = TST31- did an "IN-04", DEVICE TC ID SWITCH BAD
 02 = TST32- did an "IN-07", TCS OPTIONS SWITCH BAD
 03 = TST33- did an "OUT-12", "IN-03", INTERRUPT STATUS BAD
 04 = TST34- did an "OUT-35, IN-35", USART STATUS BAD
 05 = TST35- did an "IN-35", USART INITIAL STATUS BAD
 06 = TST36- did an "IN-02", INT STATUS BAD AFTER 1 output
 07 = TST37- did an "IN-02", INT STATUS BAD AFTER 1 I/O

d. Error/Hardware Code / Hardware-pin

01 = ID DIP SWITCH, L4
 02 = OPTIONS SENSE SWITCH, L11
 03 = L13, L24-8
 04 = L13 L24-8
 05 = L12, L16-6, L6-8, L16-11
 06 = L12, L17, L18, L19
 07 = L12, L17, L18, L19

e. Storage Area

Label	Description	Location
TEST31	GD/BD STATUS	0319
TEST32	GD/BD STATUS	031b
TEST33	BAD STATUS	031d
TEST34	INTRPT GD/BD STATUS	031e
TEST35	BD USART STATUS	0320
TEST36	BD MDM IN/OUT	0321

E. TEST FOUR

1. Asynchronous I/O Test at 2400 BAUD

a. Description This module exercises the receive, transmit logic by operating the USART in polled status, read only controlled environment. No interrupts are being used, checks the status of the USART with the interrupts status byte, MDM status byte. A preliminary test verifies the 8251 for the proper STATUS BITS, and I/O capabilities in ASYNCH I/O mode. It sends and receives 10 characters. Specific status bytes and received characters are checked for errors which are stored in memory locations STARTMEM to ENDMEM.

b. Environment

Operates in normal ASYNC mode, transmits and receives 10 characters. Checks for bad TXRDY,RXRDY,TXMIT conditions. Does not test for parity overrun, or framing error other than ensuring they were reset initially.

c. Messages None

d. Errors CODE ERROR CONDITIONS

● Initial USART Conditions / USART IN POWER UP MODE

- (1) TRANSMIT READY ERROR -TXR- (IN-35)
- (2) RECEIVED READY ERROR -RXR- (IN-35)
- (3) TRANSMIT EMPTY ERROR -TXE- (IN-35)
- (4) FE,PE,OE NOT RESET ERROR (IN-35)

- Initial Interrupt Conditions / INTERRUPT STATUS BYTE
 - (5) TXR ERR (IN-03)
 - (6) RXR ERROR (IN-03)

- USART status after one transmit
 - (7) TXRDY ERROR (IN 35) AFTER 1 transmit
 - (8) TRANSMIT EMPTY (IN-35)

- Interrupt status after one transmit / IN-03
 - (9) TXR ERROR (IN-03)
 - (a) RXR (IN-03)

- USART status after transmit and receive / IN-35
 - (b) TXRDY FAILED TO COME UP (IN-35)
 - (c) TXE FAILED TO COME UP (IN-35)
 - (d) TXRDY ERROR (IN-35)

- Interrupt status after transmit and receive / IN-03
 - (e) RXR ERROR (IN-03)
 - (f) TXR ERROR (IN-03)

- USART status after one transmit and receive from character generator
 - (10) BAD CHARACTER TRANSMIT/RECEIVED (IN-35)

e. Error/Hardware CODE / HARDWARE - PIN

- (1) L12-27, L14-3, L16-6
- (2) L12-28, L14-5, L16-6
- (3) L12-1, L14-7, L16-6
- (4) L12-2,-5,-6, L14-9,-11,-13, L16-6
- (5) L13-5, L12-15
- (6) L13-7, L12-14
- (7) L12-27, L16-6
- (8) L12-1, L14-6
- (9) L13-5, L28-16, L12-28
- (A) L13-7, L28-6, L12-1
- (B) L12-27, L14-18, L13-02
- (C) L12-1, L14-7, L13-6
- (D) L12-27, L14-18, L13-02
- (E) L13-7, L28, L12-1
- (F) L13-5
- (10) RCVD L12-27,-28,-1,-2,-5,-6,-7,-8,
L18-13, L13-12,-14, L12-12, L12-11,
L12-13, L24-6) TRNSMT = L12-27,-28,
-1 , -2 , -5 , -6 , -7 , -8, L27-7,
L12-19, L12-12, L12-11)

f. Status Information Stored for Reference

LOCATION / DESCRIPTION

0323H	USART START UP STATUS BYTE
0324H	INTSTAT START UP STATUS BYTE
0325H	USART 1 outdata STATUS BYTE
0326H	INTSTAT 1 OUTDATA STATUS BYTE
0327H	USART 1 OUT & 1 IN STATUS BYTE
0328H	INTSTAT 1 OUT & 1 IN STATUS BYTE
0329H	10 I / O OPERATIONS CHRCS STATUS BYTE

F. TEST FIVE

1. Interrupt Path Test

a. Description This test is designed to check that interrupts being generated by the USART and interval timer are going to location zero of the 8080 Microchip. The procedure is as follows: an interrupt is generated which should go to location zero; the interrupt service routine saves the status of the interrupt status byte at a location called "INTSTATM" (copy of the command "IN 03").

b. Message None

c. Errors Code / Description

- Initial Conditions Start Up Mode

- (1) 01 = did an "IN-03, OUT-13", INTERVAL INTERRUPT OCCURED WHEN SHOULDN'T HAVE
- (2) 02 = did an "IN-03, OUT-17", INTERVAL INTERRUPT didn't occured when should have
- (3) 03 = did an "IN-03, OUT-17", TXRDY interrupt was not generated
- (4) 04 = did an "IN-03, OUT-17", RXRDY interrupt occured when shouldn't have,

- DID one transmit mode only

- (1) 05 = did an "OUT-15, IN-03", RXRDY interrupt didn't occured when should have,
- (2) 0B = did an "IN-03, OUT-17", RXRDY status not on when should be

d. Error/Hardware

CODE / HARDWARE-PIN

01 = L32-3, L13-9, L29, L30)
 02 = L32-3, L5, L13-9, L24-8, L29-9, L30-9
 03 = L13-5, L24-8, L12-15, L29-9, L30-9
 04 = L13-7, L24-8, L12-14, L29-7, L30-9
 05 = L12-14, L28-8, L29-9, L30-9
 0B = L13-7, L12-14

e. Storage Area

LOCATION LABEL

0334H	CHCK5A
0335H	CHCK5B
0336H	CHCK5C
0337H	CHCK5D

G. TEST SIX

1. Interval Timer Test

a. Description Check the performance of the interval timer clock. Make sure the clock pulses are within +/- 15% of specs. Check that the interrupt goes to page zero to be processed.

b. Message None

c. Errors CODE / DESCRIPTION

- 01 = cmd "OUT-13, IN-03" interval timer interrupts was not cleared out,
- 02 = cmd "OUT-17, IN-03" interval timer interrupt too late
- 03 = cmd "OUT-17, IN-03" interval timer interrupt too late
- 04 = cmd "OUT-17, IN-03" interval timer interrupt too early

d. Error/Hardware CODE / HARDWARE - PIN

- 01 = L32-6, L29-4
- 02 = L5, 10 ms real clock, L29-9, L30-9
- 03 = L5, 10 ms real clock, L29-9, L30-9
- 04 = L5, 10 ms real clock, L29-9, L30-9

- DID One Transmit Mode

06 = CMD "OUT-13, OUT-17, OUT-13, OUT-35, OUT-15,
IN-35"

07 = CMD "OUT-13, OUT-17, OUT-13, OUT-35, OUT-15,
IN-03"

08 = RECEIVED BAD CHARACTER (IN-15)

- DID a Transmit and a Receive Mode

09 = CMD "OUT-15, IN-15, IN-35"

RCVD INPROPER STATUS AFTER RECEIVED MODE USART

0A = USART ERROR CONDITIONS (FE,PE,OR)(L12, L14,
L16)

0B = CMD "OUT-15, IN-15, IN-03"

IMPROPER STATUS BYTE IN INTSTAT AFTER I/O

FF = LOOP BACK PLUG NOT INTSTALLED(loop back plug)

d. Error Hardware

CODE / HARDWARE

01 = SW 1, L4

02 = JUMPERS, L11

03 = not used

04 = L12, L14, L16

05 = L13, L12

06 = L12, L16

07 = L13, L28, L12

08 = L12, L18, L13, L24, L27

09 = L12, L14, L13

0A = L12, L14, L16

0B = L13, L28, L12

FF = Loop back plug

- Initial USART Start Up Conditions

04 = CMD "OUT-13, OUT-17, IN-35" INITIAL USART
(TXE, TXR)

05 = CMD "OUT-13, OUT-17, IN-03" INTSTAT BYTE
ERROR (RXR, TXR)

- DID One Transmit Mode

06 = CMD "OUT-13, OUT-17, OUT-13, OUT-35,
OUT-15, IN-35"

07 = CMD "OUT-13, OUT-17, OUT-13, OUT-35,
OUT-15, IN-03"

08 = RECEIVED BAD CHARACTER (IN-15)

- DID a Transmit and a Receive Mode

09 = CMD "OUT-15, IN-15, IN-35"

RCVD INPROPER STATUS AFTER RECEIVED MODE USART

0A = USART ERROR CONDITIONS (FE,PE,OR)(L12,
L14, L16)

0B = CMD "OUT-15, IN-15, IN-03"

IMPROPER STATUS BYTE IN INTSTAT AFTER I/O

FF = LOOP BACK PLUG NOT INTSTALLED(loop back
plug)

d. Error/Hardware

CODE / HARDWARE-PIN

01 = SW 1, L4
02 = JUMPERS, L11
03 = RUN TEST 9
04 = L12, L14
05 = L12, L28, L13
06 = L12, L14, L13
07 = L12 L13, L28
08 = L12, L14, L13
09 = L12, L14, L13
0A = L12, L13, L28
0B = L12, L13, L28
FF = Loop back plug

J. TEST NINE**1. Operator Aid**

Allows operator to read any memory location (i.e. - status locations) also allows for Test 8 USART parameter input and allows for examination of Test 7 output buffers.

a. Description r = memory read
 p = test 8 parameter input
 b = Test 7 buffer examination

NOTE 1: - OPERATOR MUST KEY "EXECUTE" TO EXIT TEST 9.

NOTE 2: - See Table 2-1 for parameter values.

b. Message FOR TEST 8

"INPUT COMAND (r/p/b)?"

Key one of the following:

"r"; MSG = "READ MEMORY ##### DATA"
 "p"; MSG = "CLCK=?? MODE=?? CHRC ?"
 "b"; BOTTOM 6 ROWS RECEIVER BUFFER

NOTE - For Selection "b"

A hi-intensity blinking "c" will indicate the separation of the test 7 buffer from test 8 buffer. The top 3 1/2 lines of data is test 7 buffer while the remaing 3 1/2 lines are test 8 BUFFER.

c. Errors No Errors are Reported

2.4 GENERAL INFORMATION FOR USART COMMAND AND STATUS BYTES

A. STATUS BYTES CONFIGURATION (NUMBERS INDICATE BIT VALUE)

RLS 10 SRL 8 DSR 4 CTS 2 RD 1 (MDM STAT/IN-02)'

IT 8 RXR 4 TXR 2 KYB 1 (INTSTAT/IN-03)'

FE 12 OE 10 PE 8 TXE 4 RXR 2 TXR 1 (USART STAT/IN-35)'

B. STATUS WORD

0,0,FE,OE, PE,TXE,RXE,TXR
7,6, 5, 4, 3, 2, 1, 0

----- FOR ASYNCH MODE -----

C. COMMAND MODE WORD FOR ASYNCHRONOUS MODE

S2,S1,EP,PEN L2,L1,ON,CRD
! ! ! ! ! ! ! !
7 6 5 4 3 2 1 0

D. DEFINITION OF BIT LOCATIONS

S2,S1 = number of stop bits (00 = not used, 01 = 1, 10 = 1 1/2, 11 = 2 bits)

EP = even parity generated,/ check if PEN IS SET

L2, L1 = transmit character length
(00 = 5, 01 = 6, 10 = 7, 11 = 8)

BIT # 1 always on

CRD = clock rate divider

E. SPECIAL INFORMATION ON CHIPS

Enable Telecommunications Interrupts = L29-9, L30-9

Disable Telecommunications Interrupts = L29-7, L30-9

USART Select Signal L12-11

CMD Out-35 L12-13

USART Transmission Mode L12-12

USART Telecommunication Interrupts L24-8

Device Options Switch Latch L11-4,-6,-10

Port ID Switch Latch L4

USART Chip is L12

**NEWS
LETTER
NO. 51.4**

CUSTOMER ENGINEERING

WORD PROCESSING NEWSLETTER NO. 51.4

CONFORM/EXECUTE	
INFORMATION ONLY	X

SYSTEMS 10/20/30

MARCH 5, 1979

WPS TELECOMMUNICATIONS MODEL 5595-4
 ASYNCHRONOUS SOFTWARE UPDATE

RELEASE 16.XT5(WL #703-0001)/6.XT5 (WL #703-0002)
 RELEASE 17.XT6(WL #703-0001A)/7.XT6(WL #703-0002A)

(UPDATE TO AND CORRECTION FOR WPNL 51 - 14 JULY 78)

*****NOTE*****

These software updates apply only if the "Event Handler" T.C. hardware modifications (see WPNL's 48.1 and 54) have been incorporated into the existing 928 system.

RELEASE 16.XT5/6.XT5

The following corrections and improvements for asynchronous emulators are included in the current release:

1. To change the format length for received documents to 132 (or any length less than 159), make a patch on the COM Disk:

<u>Disk Address</u>	<u>Was</u>	<u>Change to</u>
T31 SOA B48:	4D	81 (or desired length-3, in hex)
T31 SOB B3A:	4D	81 (or desired length-3, in hex)
T31 SOB B41:	4C	80 (or desired length-4, in hex)

NOTE: On the Rev. T5B disk the addresses were T32, S08 and S09.



LABORATORIES, INC.

ONE INDUSTRIAL AVENUE LOWELL MASSACHUSETTS 01851 TEL (617) 851 4111 TWX 710 343 6769 TELEFAX 94 7421

2. Several problems with receiving to 2741 are corrected:
 - all 9's were being dropped
 - occasional other characters were being dropped
 - data overrun was occurring frequently and would cause the received document to be formed incorrectly.
3. Default line speed for the 2741 is changed to 134.
4. A bug causing the "disk full" message not to be displayed in some cases has been corrected.
5. Received tabs are retained in the document.
6. For the TTY, received form feeds are translated to page breaks properly and an end of page sequence associated with the connection can be sent at the end of each page. The screen shows a page symbol in both cases.
7. The function keys were not being handled correctly for non-standard key translations (such as in Canada). This is corrected for the TTY. (The 2741 is corrected in Rev. T5D.)
8. For the TTY, receiving LF followed by characters then CR no longer causes the workstation to blow up.
9. Replace characters received in error by (backslash).
10. A problem causing the workstation to blow up occasionally while scrolling the screen is corrected.
11. For TTY, the delay following each record sent is changed from .5 to 1 second, to allow time for the far end to respond.

12. SRS will be raised while unit is in received mode. This corrects a problem with signing on with the 2741.

RELEASE 17.XT6/7.XT6

TC Release T6 is compatible ONLY with WP Release 17/7.2 and later. If an attempt is made to execute the COM Utilities using an earlier version of the System Disk, the following message will appear on the screen:

'ERROR: No Copy/Update - Update Systems Disk to Rev. 17/7'.

The following corrections and improvements for asynchronous emulators are included in the current release:

1. Glossary documents can now be sent. The glossary page is not sent, so the document must be re-verified before it is used at the receiving end. Header, Footer, and Work pages are sent only in Transparent mode (WPS connection or // in comments field).
2. The restriction to 4 asynchronous stations is removed.
3. It is not longer necessary to have unique channel ID's for asynchronous stations.
4. The problem causing asynchronous stations with duplicate ID's to blow up after session cancel is removed.

**NEWS
LETTER
NO. 51.5**

CUSTOMER ENGINEERING

WORD PROCESSING NEWSLETTER NO. 51.5

CONFORM/EXECUTE	
INFORMATION ONLY	X

SYSTEMS 10/20/30

MAY 25, 1979

T.C. WORKSTATION and SYSTEM 5 TC SOFTWARE RELEASE
(Refer to WPNL No. 51 and No. 70)

This newsletter contains the following information:

- (A) Bisync feature for a TC Workstation
- (B) Operating procedure for TC Workstation in Bisync Mode.
- (C) Software corrections and improvements for Async and Bisync for System 5/10/20/30 TC Workstations.

RELEASE 2.XT7.2 (W.L. #703-0139) - SYSTEM 5

RELEASE 7.XT7.2 (W.L. #703-0141) - SYSTEM 30

RELEASE 17.XT7.2 (W.L. #703-0140) - SYSTEM 10,20

- (D) Engineering Change Notices



LABORATORIES, INC.

ONE INDUSTRIAL AVENUE, LOWELL, MASSACHUSETTS 01851, TEL (617) 851 4111, TWX 710 343-6769, TELEX 94 7421

(A) BISYNC FEATURE FOR A TC WORKSTATION

With the release of this software it is now possible for a TC Workstation to operate in an Async as well as Bisync mode (up to 2400 baud). This is a new feature for a TC Workstation.

For an existing user to operate Bisync (2780, 3780, etc.) mode, switch No. 2 on a 7230 board must be set to the ON position. If a customer has a 5528 (black box) used in Bisync mode, he will now be able to operate both of them in Bisync mode. The only difference being: any of the workstations in a system can access the 5528 to operate in Bisync mode, but the TC Workstation is an interactive stand-alone device when connected to a master.

(B) OPERATING PROCEDURE FOR TC WORKSTATION IN BISYNC MODE

Using Bisync communications on a TC Workstation and System 5, there is a new screen display when a TC session is scheduled. The TC Workstation must be switched to TC mode to start TC. The user accomplishes this by the following procedure:

1. Begin with the main menu--

WANG WORD PROCESSING SYSTEM

Please select next activity:

- . Edit Old Document
- . Create New Document
- . Print Document
- . Special Print Functions
- . Document Index
- . Document Filing
- * Telecommunication
- . Other Functions

Select 'Telecommunications' and touch EXECUTE.

2. When the telecommunication menu appears--

Revision ..7.4/17.4T7.2 - 03/21/79

Select Telecommunications Action

- * Schedule a Telecommunication Session
- . Cancel a Telecommunication Session
- . Display Telecommunication Session Request
- . Display Telecommunication Session Summary
- . Display Telecommunication Connections
- . Switch Workstation to Telecommunication Mode

accept the default choice, as shown, and touch EXECUTE.

3. The following display now appears:

Schedule a Telecommunication Session

Session: 0003A
Connection:

An ID is supplied by the system; the cursor indicates an operator entry is required for the connection.

The following connections are valid for Release 17/7/2.xT7.2 of the COM Disk.

Connection

<u>Name</u>	<u>Restrictions</u>	<u>Purpose</u>
WPS wps	Requires bisynchronous hardware (Model 5528) and 2780 or 3780 emulation.	For connections to other Wang Word Processors--codes representing document format lines, screen graphics, IDs and authors' names are exchanged.

2780	Requires bisynchronous hardware (Model 5528) and 2780 emulation.	For connections to host computers or non-Wang word processors using the 2780 protocol.
2780v	Requires bisynchronous hardware (Model 5528) and Send to 2780/3780 software.	For connections to 2780 terminal.
3780	Requires bisynchronous hardware (Model 5528) and 3780 emulation.	For connections to host computers or non-Wang word processors using the 3780 protocol (without compression).
3780c	Requires bisynchronous hardware (Model 5528) and 3780 emulation.	Includes 3780 compression; otherwise, same as 3780 connections.
TTY	Requires asynchronous hardware and TTY emulation.	For connections to host computers or compatible terminals using the Teletype protocol.
2741t	Requires asynchronous hardware and 2741 emulation.	For connections to host computers using the IBM 2741 protocol.
2741h	Requires asynchronous hardware and 2741 emulation.	For connections to compatible terminals using the IBM 2741 protocol.

- * w2780 Requires TC Workstation and 2780 emulation For connections to host Computers or non-Wang Word Processors using the 2780 Protocol.
- * w3780 Requires TC Workstation and 3780 emulation For connections to host Computers or non-Wang Word Processors using the 3780 Protocol. (without compression)
- * w2780V Requires TC Workstation and send to 2780/3780 software. For connection to 2780 terminal.
- * w3780 Requires TC Workstation and 3780 emulation Includes 3780 compression, otherwise, same as 3780 connections.
- * WWPS Requires TC Workstation and 2780 or 3780 emulation. For connection to other Wang Word Processors--codes representing document format lines, screen graphics, IDS and author's names are exchanged.
- * wwps

* Use these connections for Bisync TC Workstation.

CONNECTION SUMMARY

Connection ID	Channel/Class	Telephone Number	Discipline
WPS.....	1	Electronic Mail
2780.....	1	2780 Emulation
3780c....	1	3780 Emulation
3780.....	1	3780 Emulation
TTY.....		TTY Emulation
2780v....	1	2780 Emulation
2741h....		2741 Emulation
2741t....		2741 Emulation
ttyh		tty Emulation
wwps	2	Electronic Mail
wps	1	Electronic Mail
WWPS	2	Electronic Mail
w2780V	2	2780 Emulation
w2780	2	2780 Emulation
w3780C	2	3780 Emulation
w3780	2	3780 Emulation

Enter WWPS, wwps, w2780, w2780v, w3780, or w3780c, depending upon which protocol is suitable for the remote facility--as illustration, the next step assumes that w2780 is the choice made here.

4. After a connection name is entered in step 3, the display expands-

Schedule a Telecommunication Session

Session: 0003A
 Connection: w2780
Baud 2780 EMULATION
 DIAL.....

The heading, the session ID, and the operator entry from step 3 are repeated. Line speed in bps (baud) and a phone number are blank for Release 17/7/2.xT7.2

DOCID TRANSMIT DOCUMENT NAME

.....
.....
.....
.....
.....
.....

A blinking cursor
indicates that a
document ID can now
be entered .

Queue Session Request

- . at tail of queue
- . at head of queue

For a receive-only session, no document ID need be specified; touch EXECUTE and go to step 6. Otherwise, enter the first document ID. The corresponding document name is displayed for operator verification. If an incorrect document name is shown, position the cursor and enter the correct ID over the incorrect ID. Repeat the ID entry process until the last document (or a maximum of six documents) is listed. Next, consider the 'Queue Session Request' portion of the display. Normally, the session being scheduled should go to the tail of the queue (the default condition); however, if desired, touch RETURN to move the cursor from the DOCID list to the queue default condition and then use the space bar to select the 'head of queue' alternative. (The time of day specification is not supported by software Release 17/7/2.xT7.2) Finally, touch EXECUTE.

5. The main menu reappears and the scheduled session is logged into the session queue automatically. If additional documents are to be sent to the same remote facility, repeat steps 1 through 4 as often as necessary to specify all the documents.
6. To check what was scheduled for a particular active or ready session, go to the telecommunications menu and select "Display Telecommunication Session Request". Enter the session I.D. number. The system will then display:

Session ID: 0003A

Connection w2780

Baud

Telephone

Docid

0001A

0002A

0003A

0005A

0007B

0009N

If the displayed session is a receive only session, then there will be no document I.D. number displayed under Docid.

7. When a TC Session has been scheduled, the TC Workstation must be switched to TC mode to start TC. To accomplish this, proceed as follows:
8. From the main menu, select 'Telecommunications' and touch EXECUTE:

WANG WORD PROCESSING SYSTEM

Please select next activity:

- . EDIT OLD DOCUMENT
- . CREATE NEW DOCUMENT
- . PRINT DOCUMENT
- . SPECIAL PRINT FUNCTION
- . DOCUMENT INDEX
- . DOCUMENT FILING
- * TELECOMMUNICATIONS
- . OTHER FUNCTIONS

9. When the telecommunications menu appears --

REVISION ..7.4/17.4T7.2 - 03/21/79

SELECT TELECOMMUNICATION ACTION

- . SCHEDULE A TELECOMMUNICATION SESSION
- . CANCEL A TELECOMMUNICATION SESSION
- . DISPLAY TELECOMMUNICATION SESSION REQUEST
- . DISPLAY TELECOMMUNICATION SESSION SUMMARY
- . DISPLAY TELECOMMUNICATION CONNECTIONS
- * SWITCH WORKSTATION TO TELECOMMUNICATION MODE

Select 'SWITCH WORKSTATION TO TELECOMMUNICATION MODE' and touch EXECUTE.

10. Now the Bisync Workstation is ready for Communication Session, and it will display on the screen:

WANG WORD PROCESSING SYSTEM TELECOMMUNICATIONS

SESSION ID: 0003A w2780
DATA SET: NOT READY
RECORD SENT: 00000
RECORD RECEIVED: 00000
CURRENT DOC. ID.:

TEXT MONITOR RUNNING

11. Before establishing a connection, become familiar with the following keyboard procedures:

- a) The key sequence CANCEL-EXECUTE aborts TC activity; the key sequence CANCEL-CANCEL leaves it undisturbed.

- b) There is a monitor display with three modes. The system defaults to text monitor mode (an ASCII representation of the document contents as the user will see them).
- c) All monitor display can be suspended by hitting 'M' while the text monitor is active. Another 'M' will cause the text monitor to resume activity.
- d) Shift FORMAT activates the line monitor. The screen then displays all characters sent or received, including line control characters (a hexadecimal representation of the entire EBCDIC data stream). If the line monitor is running, Shift FORMAT causes a switch to text monitor mode.
- e) The screen display of either monitor (though not TC activity, of course) can be 'frozen' for inspection by pressing STOP. Another STOP entry causes the monitor to resume its display of data currently received or transmitted.
- f) A message on screen always indicates which of the two monitors has been selected and what its current status is.
- g) The TC workstation and black box can execute single or multiple sessions, but the TC workstation does not function like the black box when the last scheduled session has transmitted all documents. A session can be scheduled for a waiting TC workstation from another terminal, but the currently active session must be cancelled with a CANCEL - EXECUTE key sequence. By contrast, a black box will continue to operate without intervention.

12. Additions to TC Menus and Messages

- (1) Some additions were made to existing menus.
 - (a) 'Switch Workstation to Telecommunications Mode' has already been mentioned above.

- (b) The number of the TC release appears with the menu from which TC activities are selected.
- (2) There is also a number of messages.
- (a) If an attempt is made to cancel the active session of a TC workstation from any terminal other than the one that has the session, 'Cancel at TC workstation' is displayed.
 - (b) Choosing TC activities on a workstation that is not equipped for TC causes 'Not a TC workstation' to appear on screen.
 - (c) Switching a TC workstation to TC mode before a session has been scheduled elicits 'First schedule session (s)'.
(d) On System 5, printing and telecommunications cannot be scheduled to run at the same time. 'Wait for printer idle' appears when telecommunications must wait for the printer to complete its task.
 - (e) The messages pertaining to the line and text monitors are 'Text Monitor' or 'Line Monitor', followed by either 'Running' or 'Pausing'. If neither monitor is active, 'Monitors Cancelled' is displayed.
 - (f) The messages associated with the cancellation of a TC session have already been explained above.
 - (g) The message 'Workstation ID not assigned' indicates a discrepancy between the hardware switch settings for the TC ports and software specifications.

(C) SOFTWARE CORRECTIONS IMPROVEMENTS AND RESTRICTION

Release 7/17/2.XT7.2

RESTRICTIONS

1. SYSTEM 5 TC is only compatible with WP Release 2.3 and higher.
2. There is a system restriction on the maximum number of times that a document can be scheduled for TC transmission at one time. If the limit of 31 is exceeded, the scheduling station displays a '0' error and the System must be re-IPL'ed before scheduling TC again.
3. Future release will support multiple TC Workstations, and at that time, it will be necessary to use switch-setting addresses of other even numbered digits on a switch bank of a 7230 board. For this release, if an attempt is made to use a Workstation with other than switch setting #2 for Bisync, the message 'Workstation ID not assigned' is displayed.

NEW FEATURES AND CORRECTIONS

1. Session Restart Option for Unattended Operation (Bisync Only)

When this option is specified (see 8a below), the last session in the queue will be automatically restarted whenever it is terminated normally or is aborted. The option is intended for unattended operation where the connection is permanent or is made by auto answer. It allows one session to be scheduled and to be reactivated for each separate transmission. The session will be dequeued only if cancelled by the operator or another session is scheduled.

2. Password Protection of Received Documents

Received documents can be protected under control of either the sender or the receiver:

- If the sender wishes to protect a document, he must assign it a password and send it in WPS mode.
- If the receiver wishes to protect all documents received during a session, the session must be executed on a Workstation for which a password has been entered.

These two methods interact as follows:

- If a password is received with a document (possible only in WPS mode), that password is assigned to the document in the receiving system.
- If no password is received, the password (if any) of the receiving TC station is assigned.
- Only sender-controlled protection is available for documents received to a TC Black Box, since passwords are not entered for these devices.
- Only receiver-controlled protection is available for Async communications, since WPS mode is not used for Async.

Following a TC session, the password of the TC workstation will be cleared before returning to Word Processing mode.

3. Automatic Printing of Received Documents (Async and Bisync)

When this option is specified (see 8b below), all received documents will be automatically queued for printing. For this purpose, a standard print request (not the system default) is used. This request specifies the character printer.

For the System 5, printing does not begin until after return to WP mode. For other systems, printing can begin as soon as the document is received.

Documents will be printed only if the receiving TC station has password access to the document. For example, a protected document received to a TC Black Box will not be printed.

4. The Revision number and date of the TC Release will be displayed in the TC Selection Menu.

5. Bisync:

- a) Lower case connection names for WPS connections have been added. WPS and wps are identical in meaning, as are WWPS and wwps.
- b) Data Terminal Ready will always be off when there is no active session.
- c) The EBCDIC Send Translation Table has been changed to send hex 41 for Don't Merge. (The Receive Table translate hex 41 to Don't Merge.)
- d) The time-of-day scheduling option has been removed from the menu.
- e) The last block of a received document will no longer be acknowledged until the document has been closed and cataloged.

- f) Reverse Interrupt (RVI) is now supported. If an RVI is received, the session will switch to Receive Mode.
- g) If a session is aborted, the line will be disconnected.
- h) A bug causing an extra blank page to be generated under some circumstances has been corrected.

6. Async:

CAUTION:

There is a restriction in our WP Async Communications offering: the limitation is LOST DATA ON RECEIVING DATA TO DISK VIA ASYNC TTY AT 1200 BPS. The problem is due to the lack of flow control in TTY mode and limited time available to record the data on a disk. There will be no further attempt made to correct this situation, therefore, customer must use TTY at 300 baud to record the data on disk or use the Bisync feature of a Workstation to operate at higher than 300 baud.

- a) A bug causing a parity error after disk overrun has been corrected.
- b) For TTY, a bug which creates an invalid document when a form-feed is not preceded by a line-feed has been corrected.
- c) A bug causing an extra blank page to be generated under some circumstances has been corrected.
- d) The spacing on the screen will be reflected in received documents in the following cases:
 - Line feed received while in the middle of a line.
 - Backspacing and overstriking of tabs.

7. Async and Bisync:

- a) Receiving more than 120 pages now causes a new document to be formed. This was also the case in T6, but it was handled incorrectly in T7.1.

- b) System 5 is more supported as a Horizontal Scroll Workstation.
- c) A problem in T7.1 which caused a session to hang up (not be cancellable) under some conditions has been corrected.
- d) Entering debug by hitting shift stop will no longer cause the workstation to line out or to end the session prematurely. However, debug cannot be used during a bisync session on the system 20/30, keystrokes will be ignored after debug is entered. Debug works properly on system 5 for both async and bisync and for system 20/30 async, but is disabled unless the chip is installed.

8. Specifying Options Through SZAP

- a) Restart Session option (Bisync Only)

This option is specified per connection. First you must find the connection you want to Zap, by inspecting COM disk addresses as follows:

<u>CONNECTION</u>	<u>TRACK</u>	<u>SECTOR</u>	<u>BYTE</u>	<u>OLD VALUE</u>	<u>NEW VALUE</u>
wwps	2F	05	50	00	02
WWPS	2F	05	C8	00	02
w2780	2F	06	50	00	02
w2780V	2F	06	14	00	02
w3780	2F	06	C8	00	02
w3780C	2F	06	8C	00	02

- b) Automatic Print Queueing (Bisync, Async)

This option, if specified, applies to all connections. Zap Com 35, OD Byte 2F from 00 to 80.

c) Null Modem Line Speeds (Bisync)

The default line speed for directly connected BSC operation using the Communications Controller with a 2228N Null Modem is 2400 bps. If higher speeds are desired, the com 5/10/20/30 disk may be changed by SZAP as follows:

<u>CONNECTION</u>	<u>TRACK</u>	<u>SECTOR</u>	<u>BYTE</u>	<u>SPEED</u>	<u>VALUE</u>
w2780V	2F	06	23	1200	= 07
w2780	2F	06	5F	2000	= 09
w3780C	2F	06	9B	4800	= 0B
w3780	2F	06	D7	9600	= 0C

d) Timeout Logic (Bisync Only)

The BSC software provides for two separate timeouts, a short timeout and a long timeout. The short timeout provides the time delay between the transmission of a sign-on document and the next document to be transmitted. It is also the time delay before a session will enter its period of inactivity. The default short timeout is for 25 seconds. The long timeout is the timeout that causes the active session to terminate and disconnect the telephone after a specified time of inactivity. After the timeout runs down, a disconnect sequence code for a switched telephone line (DLE EOT) is automatically transmitted to the remote end to disconnect the telephone connection at both ends. The default long timeout is forever (disabled).

To change the default settings, the Session Control Block (SCB) Initial located on the COM disk may be changed by SZAP as follows:

<u>TIMEOUT</u>	<u>TRACK</u>	<u>SECTOR</u>	<u>BYTE</u>	<u>OLD VALUE</u>
short	35	0D	A0-A1	0A00 (25 seconds)
long	35	0D	A2-A3	0000 (disabled)

To calculate the new value for either timeout (two bytes), take the desired timeout value in seconds and convert it from a decimal number to a two byte hexadecimal number and then transpose the two bytes. As an example, set a timeout for 30 seconds. The number 30 in decimal equals '001E' as a two byte hexadecimal number and then transposing the two bytes the final value is '1E00'.

e) Default Length (Async and Bisync)

To change the format length for received documents to 132 (or any other length less than 159), make a patch on the COM Disk:

<u>DISK ADDRESS</u>	<u>WAS</u>	<u>CHANGE TO</u>
T31 SOA B4B	4D	81 (or desired length-3, in hex)
T31 SOB B3D	4D	81 (or desired length-3, in hex)
T31 SOB B44	4C	80 (or desired length-4, in hex)

f) Sending NAK instead of WAK (Bisync Only)

To send NAK instead of WAK:

Com 33, OF Byte BF-CO - Zap from 106B to 323D

(D) ENGINEERING CHANGE NOTICES

The following E.C.N. to be executed:

P.C.B. #	ECN NO.	E. REV	DESCRIPTION
7230	10762	5	Add (1) .01uf Cap (WL #300-1903)

REASON FOR CHANGE

To reduce slew rate of Null Modem
Clocks to meet RS-232C specs.

Change artwork, assembly drawing and schematic as follows:

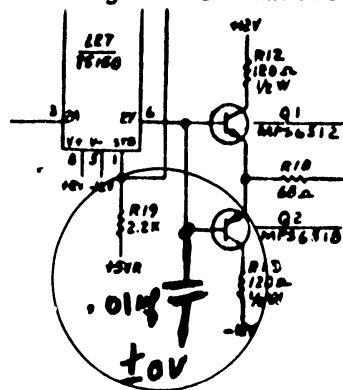

**NEWS
LETTER
NO. 51.6**

CUSTOMER ENGINEERING

WORD PROCESSING NEWSLETTER NO. 51.6

CONFORM/EXECUTE	
INFORMATION ONLY	X

SYSTEMS 5/10/20/30

June 7, 1979

TC WORKSTATION AND SYSTEM 5 T.C. SOFTWARE RELEASE

(Refer to WPNL NO.(s) 51 and NO. 70

RELEASE 2.XT7.3 (W.L. # 703-0139)
 RELEASE 7.XT7.3 (W.L. # 703-0141)
 RELEASE 17.XT7.3 (W.L. # 703-0140)

This release corrects a problem with the generated format lines in received documents. If the return for the format line fills in the last byte of the disk sector, the return would be lost; and the following text, up to the next return, would be appended to the format line.

This correction affects the zap for changing the format length.

To change the format length to 132 for received documents (or any length less than 159), make a patch on the COM DISK.

DISK ADDRESS	WAS	CHANGED TO
T31 SOA B4B	4E	82 (or desired length -2, in hex)
T31 SOB B3D	4E	82 (or desired length -2, in hex)
T31 SOB B44	4C	80 (or desired length -4, in hex)



LABORATORIES, INC.

ONE INDUSTRIAL AVENUE, LOWELL, MASSACHUSETTS 01851. TEL (617) 851 4111. TWX 710 343 6769. TELEX 94 7421

**NEWS
LETTER
NO. 51.7**

CUSTOMER ENGINEERING

WORD PROCESSING NEWSLETTER NO. 51.7

CONFORM/EXECUTE	
INFORMATION ONLY	X

SYSTEMS 10/20/30

December 26, 1979

This Newsletter contains the following information:

- * WPS Telecommunications Software Corrections and Improvements.

(Refer to WPNL No. 51)

RELEASE 8.XT8.3 (WL # 703-0141B)

RELEASE 18.XT8.3 (WL # 703-0140B)

- ** NEW WORKSTATION T.C. ELECTRONICS (Option Board, PCB #7541)

*Release 8.XT8.3/ 18.XT8.3

The following Corrections and Improvements for Asynchronous Emulators are included in the current release.

1. All SZAP's for T8.3 are the same as for T7.3 except for the receive format length. To change the format length for received documents to 132, (or any other length less than 159), make a patch on the COM DISK:

<u>DISK ADDRESS</u>	<u>WAS</u>	<u>CHANGE TO</u>
T31 S0A B4A	4E	82 (or desired length-2, in Hex)
T31 S0B B3C	4E	82 (or desired length-2, in Hex)
T31 S0B B43	4C	80 (or desired length-4, in Hex)

2. The screen display of received data now wraps instead of scrolls.
3. 1200/ baud disk-overflow condition has been corrected.
4. Receiving short records no longer cause parity errors, data loss, or disk-overflow conditions.
5. In receive mode, a time delay of zero at the send site no longer results in the loss of data at the receive site.

V.C.3

WANG LABORATORIES, INC.
ONE INDUSTRIAL AVENUE, LOWELL, MASSACHUSETTS 01851. TEL (617) 459 5000 TWX 710 343 6769. TELEX 94 7421

- 6. The insertion of erroneous blank lines in the received document have been corrected.
 - 7. A page code no longer causes linkage with the prior two records.
- ** T.C. Option Board 210-7541.

PCB 7541 is a new T.C. option that can be used on a two (2) board Workstation (5536) and the old version of the three (3) board (5526) Workstation.

NOTE:

Up to the present, the 7230 T.C. option board was used in the three (3) board (5526) workstation but it is not compatible with the (2) board Workstation (5536).

The available T.C. DIAGNOSTIC in the field (E2.0) does NOT function properly with PCB 7541. A new WP single channel DIAGNOSTIC is in the process of being released to the field.

PCB 7541 has a bank of five (5) PORT ID microswitches to be set as specified below:

	SWITCH SETTING				
	1	2	3	4	5
ON		*			
OFF	*		*	*	*

The switch interpretation is a function of software which uses the switches to identify a set of parameters stored on the system disk which define the type of Modem and line connected to the TC workstation.

APPENDIX

B

T.C. WORKSTATION

ELECTRONIC

SCHEMATICS

THE INFORMATION CONTAINED IN THIS DRAWING IS THE PROPERTY OF WANG LABORATORIES, INC. AND IS CONFIDENTIAL AND PROPRIETARY TO WANG LABORATORIES, INC. IT MAY NOT BE COPIED, REPRODUCED OR USED IN WHOLE OR IN PART FOR ANY REASON.

MILLIMETERS IN PARENTHESIS TOLERANCES TO BE EQUIVALENT TO INCH DIMENSIONS

DO NOT SCALE

WIRE LEGEND & TOLERANCES		
WIRE NO.	TOLERANCE	
01-10	.001	
11-20	.002	
21-30	.003	
31-40	.004	
41-50	.005	
51-60	.006	
61-70	.007	
71-80	.008	
81-90	.009	
91-100	.010	
WIRE	DESCRIPTION	WIRE
110		111

SIGNAL-TERMINAL DESIGNATIONS; VIEW FROM BOTTOM (WIRING SIDE OF COMPONENT)

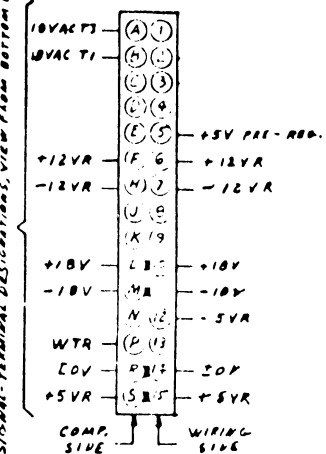

LOCATION	W.L. PART NO.	PIR. R4	WTR. R2
L1, 2	376-0066	5	
L3, 4	376-0134	9	
L5	376-0010	7	14

I.C. TYPE	LOCATION	SPARE
7404	L5	5

COMPONENT	W.L. PART NO.
R1, 2, 3	330-3022
R3, 4	330-2068
R4, 10	336-1014
R5, 8, 20	330-3075
R7, 11	330-3035
R10, 19	334-1022
R13, 15	333-1018
R12, 14	330-1027
R17	333-0068
L7A	332-1022
P1	340-1015
C1, 2, 5, 6	330-1015
C3	330-1015
C4	330-1010
C7	330-1010
C7, 10, 11	330-1010
C12	330-4045
D1, 2, 3, 4	330-3008
Q1	330-1024
Q2	330-1053
Q4	330-1052
Q1 PAU	330-3007

LOADING CHART	
210-7067	AVDVT LOAD C12, LC40 315-1052
210-7067-1	BE NOT LOAD D1, D3 & JUMPER "A" CHG. C3 TO A 300-4020-474F, CHG. C7 TO A 300-4045-22043 W.L. 315-1052 TO C3
210-7067-2	LOADING SAME AS 7067, BUT REMOVES JUMPER "B" LOAD J35-182T ON Q2

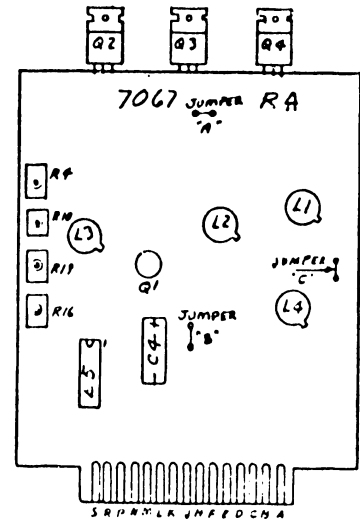

JUL 18 1978

7067	7067-1	7067-2
E-REV	E-REV	E-REV
6	6	5

REVISION	DATE	BY	DESCRIPTION	APPROVED BY	DATE
1	1/15/78	WANG	INITIAL DESIGN		
2	2/15/78	WANG	REVISED FOR MANUFACTURE		
3	3/15/78	WANG	REVISED FOR MANUFACTURE		
4	4/15/78	WANG	REVISED FOR MANUFACTURE		
5	5/15/78	WANG	REVISED FOR MANUFACTURE		
6	6/15/78	WANG	REVISED FOR MANUFACTURE		
7	7/15/78	WANG	REVISED FOR MANUFACTURE		
8	8/15/78	WANG	REVISED FOR MANUFACTURE		
9	9/15/78	WANG	REVISED FOR MANUFACTURE		
10	10/15/78	WANG	REVISED FOR MANUFACTURE		
11	11/15/78	WANG	REVISED FOR MANUFACTURE		

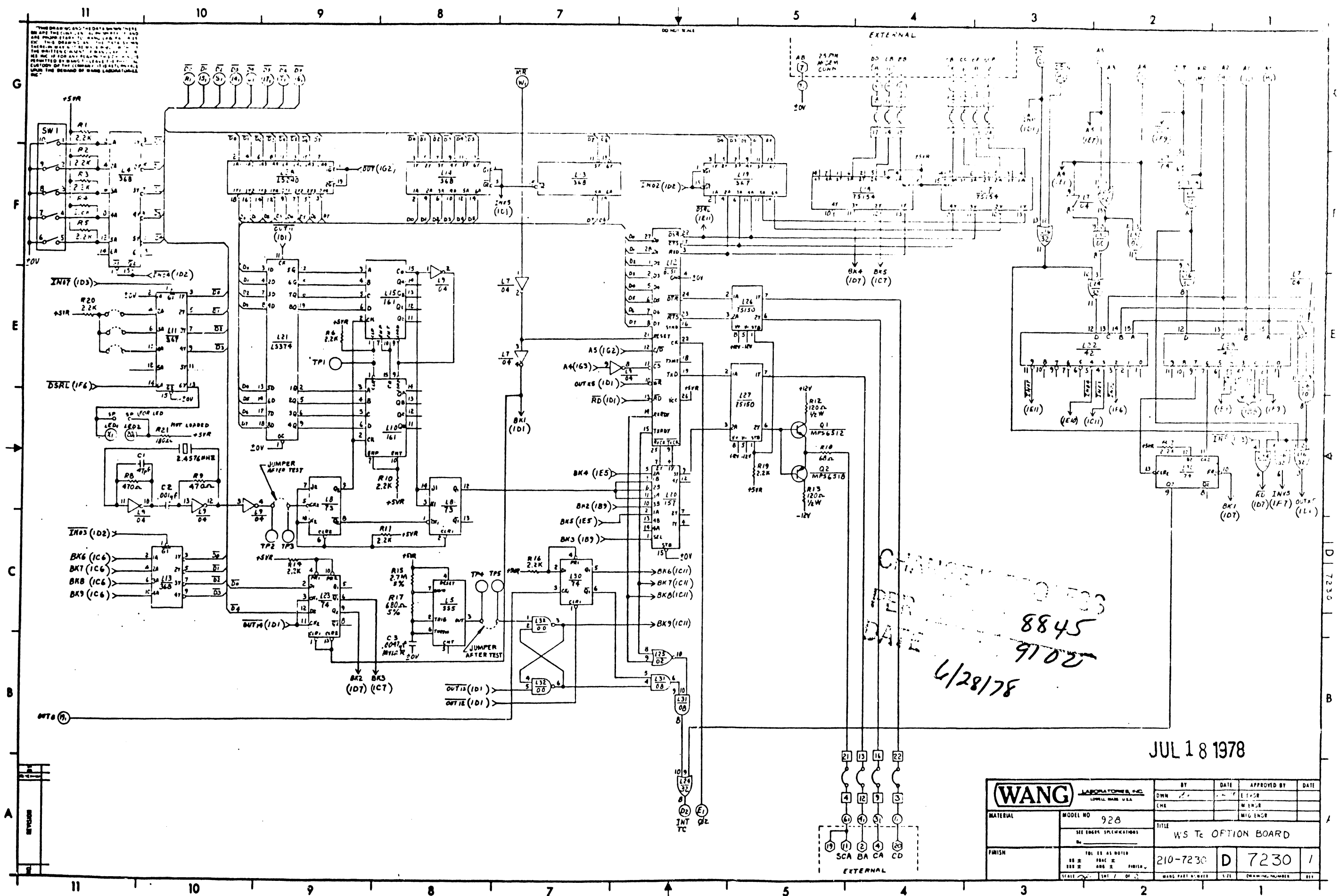

CHANGED PER DATE
 8845
 9102
 6/28/78

JUL 18 1978

WANG LABORATORIES, INC. LOWELL, MASS. U.S.A.		BY	DATE	APPROVED BY	DATE
MATERIAL	MODEL NO 928	OWN		E. J. S.	
	SEE ENG'G SPECIFICATIONS	CHK		M. L. S.	
				MIG ENGR	
FINISH	TOL. IS AS NOTED	210-7230	D	7230	1
	SEE ENG'G SPECIFICATIONS				
	SCALE: 1/8" = 1"	DATE: 7/18/78	BY: M. L. S.	CHK: E. J. S.	APP: M. L. S.

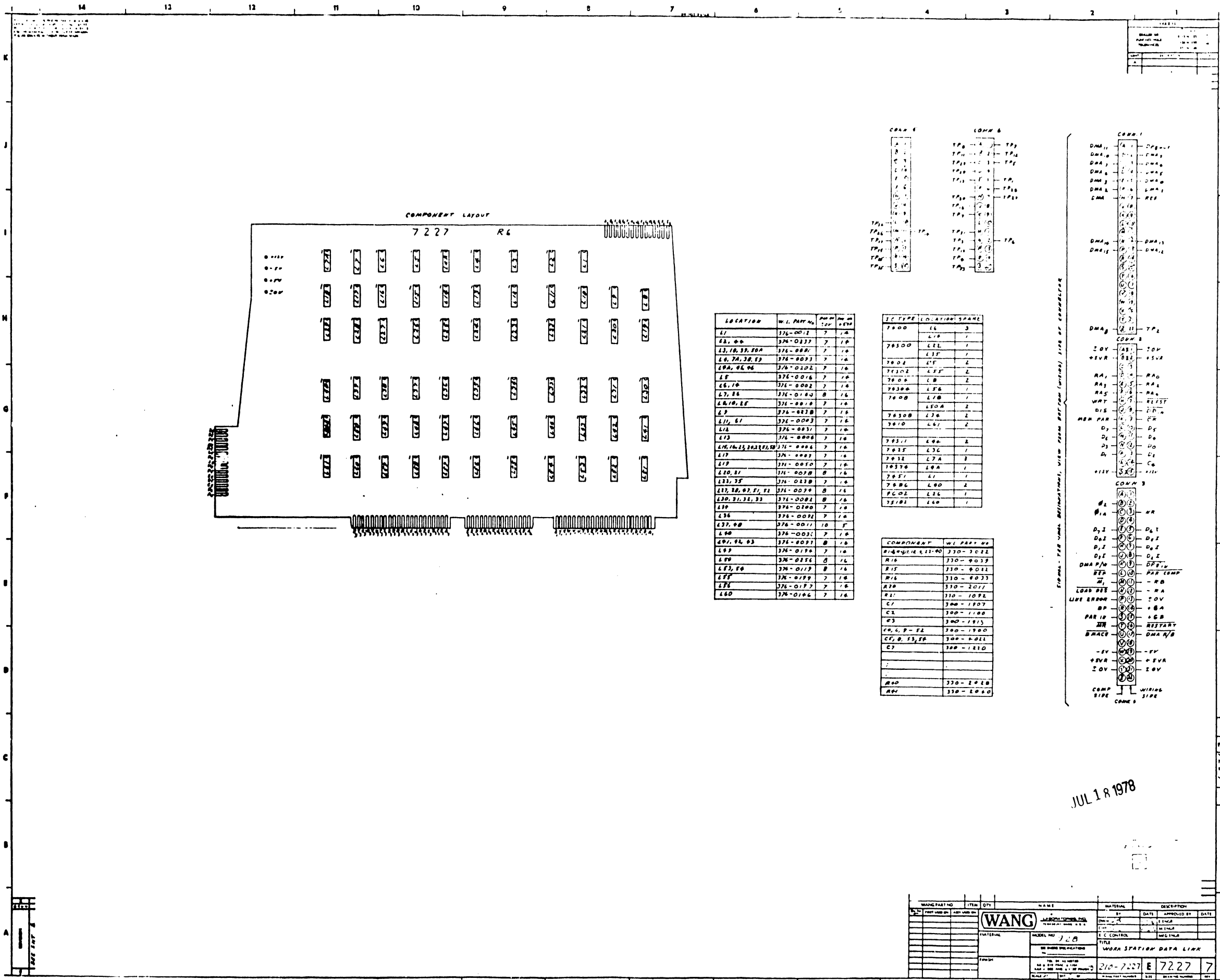

LOCATION	W.I. PART NO.	QTY	REV
L1	376-0012	7	1A
L2, 6A, 6B	376-0137	7	1A
L3, 10, 33, 30A	376-0001	7	1A
L4, 2A, 3B, 5D	376-0033	7	1A
L5A, 6L, 6E	376-0102	7	1A
L6	376-0016	7	1A
L6, 7A	376-0002	7	1A
L7, 8A	376-0100	8	1A
L8, 10, 1E	376-0010	7	1A
L9	376-0020	7	1A
L11, 6I	376-0003	7	1A
L1A	376-0031	7	1A
L13	376-0008	7	1A
L14, 14A, 14B, 14C, 14D	376-0004	7	1A
L17	376-0007	7	1A
L17	376-0050	7	1A
L20, 2I	376-0028	8	1A
L23, 3E	376-0120	7	1A
L27, 2B, 2C, 2I, 2J	376-0029	8	1A
L30, 3I, 3L, 3J	376-0081	8	1A
L39	376-0100	7	1A
L36	376-0081	7	1A
L37, 40	376-0011	10	F
L40	376-0031	7	1A
L41, 4L, 43	376-0037	8	1A
L42	376-0130	7	1A
L49	376-0154	8	1A
L53, 5B	376-0119	8	1A
L57	376-0129	7	1A
L58	376-0127	7	1A
L60	376-0106	7	1A

IC TYPE	LOCATION	QTY
7400	L6	3
7400	L2L	1
7400	L1F	1
7400	L1F	2
7400	L3F	2
7400	L7A	1
7400	L7B	1
7400	L50A	2
7400B	L7B	2
7400	L4I	2
7401	L4A	2
7401	L3C	1
7401	L7A	1
7401	L6A	1
7401	L7	1
7401	L40	2
7401	L2L	1
7401	L40	1

COMPONENT	W.I. PART NO.
R14, 41, 42, 43, 44, 45, 46	370-3022
R16	370-3039
R15	370-3022
R16	370-3033
R19	370-2011
R1	370-1082
C1	300-1907
C2	300-1100
C3	300-1915
C4, C, D, E, F	300-1900
C7, D, 53, 5A	300-3021
C7	300-1210
D1	370-2028
D2	370-2020

JUL 18 1978

WANG PART NO.	ITEM	QTY	NAME	MATERIAL	DESCRIPTION
7227					
WANG			DATE	APPROVED BY	DATE
WANG STATION DATA LINK			DATE	APPROVED BY	DATE
7227			DATE	APPROVED BY	DATE

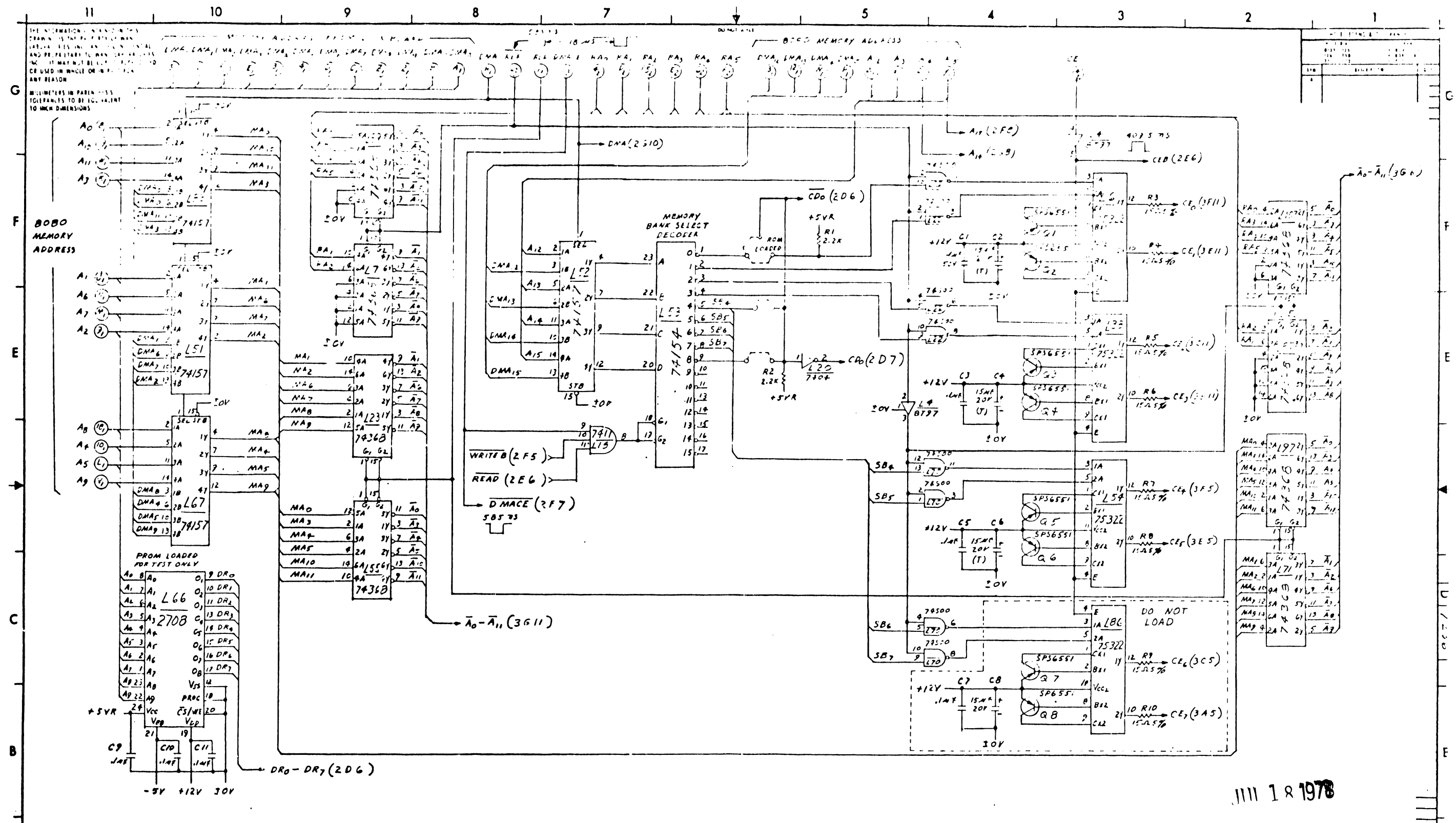

REV	DATE	BY	DATE	APPROVED BY	DATE
1		DMW		ENG	
2		ENG		MEM	
3		MEM		MFG	

QTY	ITEM	WANG PART NO	DRAWING NO	DESCRIPTION
1	74154			MEMORY BANK SELECT DECODER
1	74157			4-BIT BINARY DECODER
1	2708			PROM
1	75322			COMPARATOR
1	78500			REGULATOR

WANG	LAUNCHPAD INC	TEMPERATURE MADE U.S.A.
MODEL NO	728	
TITLE	MEMORY BANK STATION, 1K MEMORY	
210-1236	D	7236

THE INFORMATION CONTAINED IN THIS DRAWING IS THE PROPERTY OF WANG LABORATORIES, INC. AND IS CONFIDENTIAL AND PROPRIETARY TO WANG LABORATORIES, INC. IT MAY NOT BE COPIED, REPRODUCED OR USED IN WHOLE OR IN PART FOR ANY REASON.

NOTE: DIMENSIONS IN PARENTHESES TOLERANCES TO BE EQUIVALENT TO INCH DIMENSIONS.

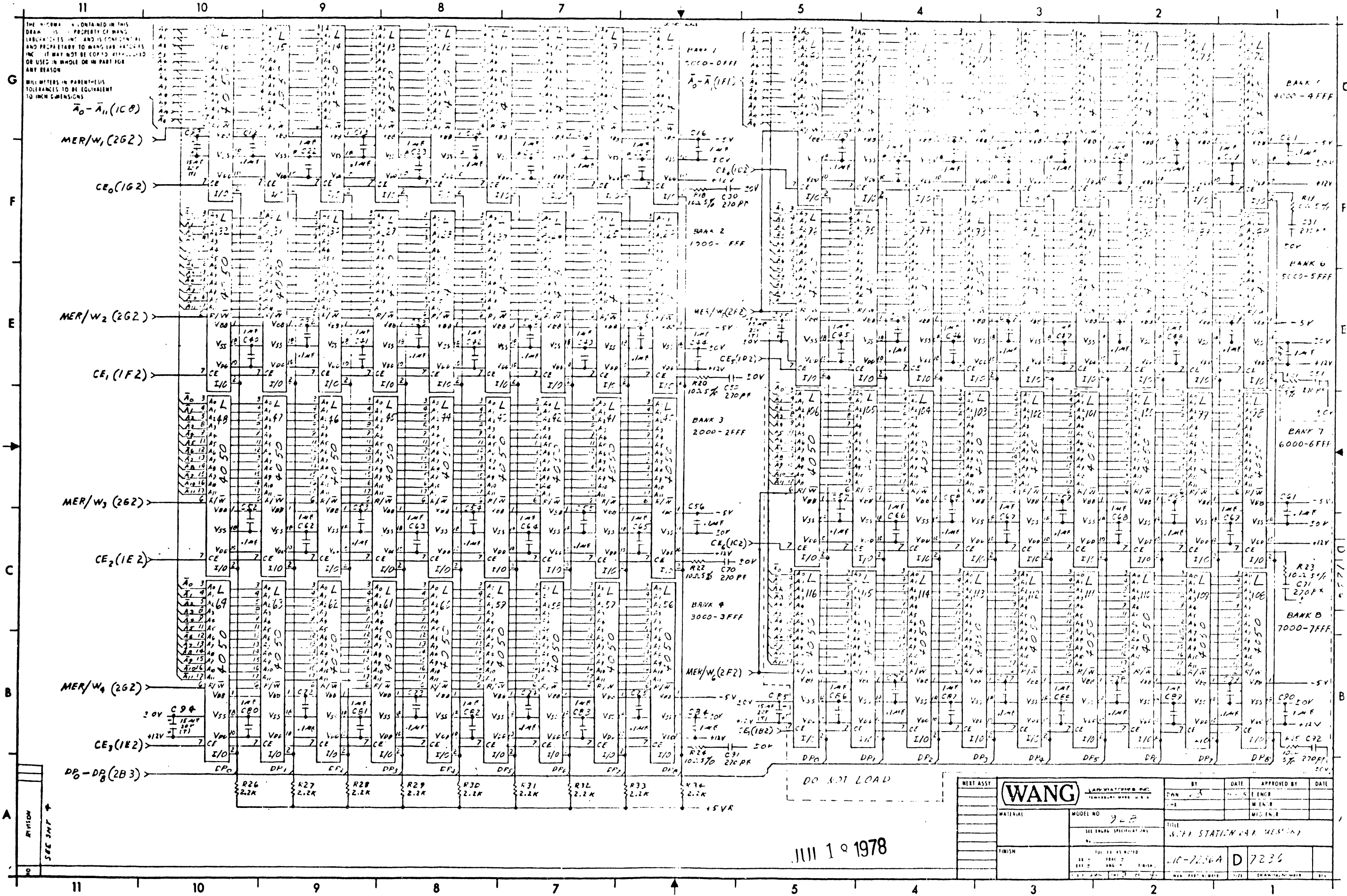

JUL 1 1978

WANG	LABORATORIES, INC.	TEMPERLEY HILLS, CALIF.
MODEL NO.	7-2-2	
TITLE	WANG STATION (A.R. MEM'RY)	
DATE	10-22-64	D 7236

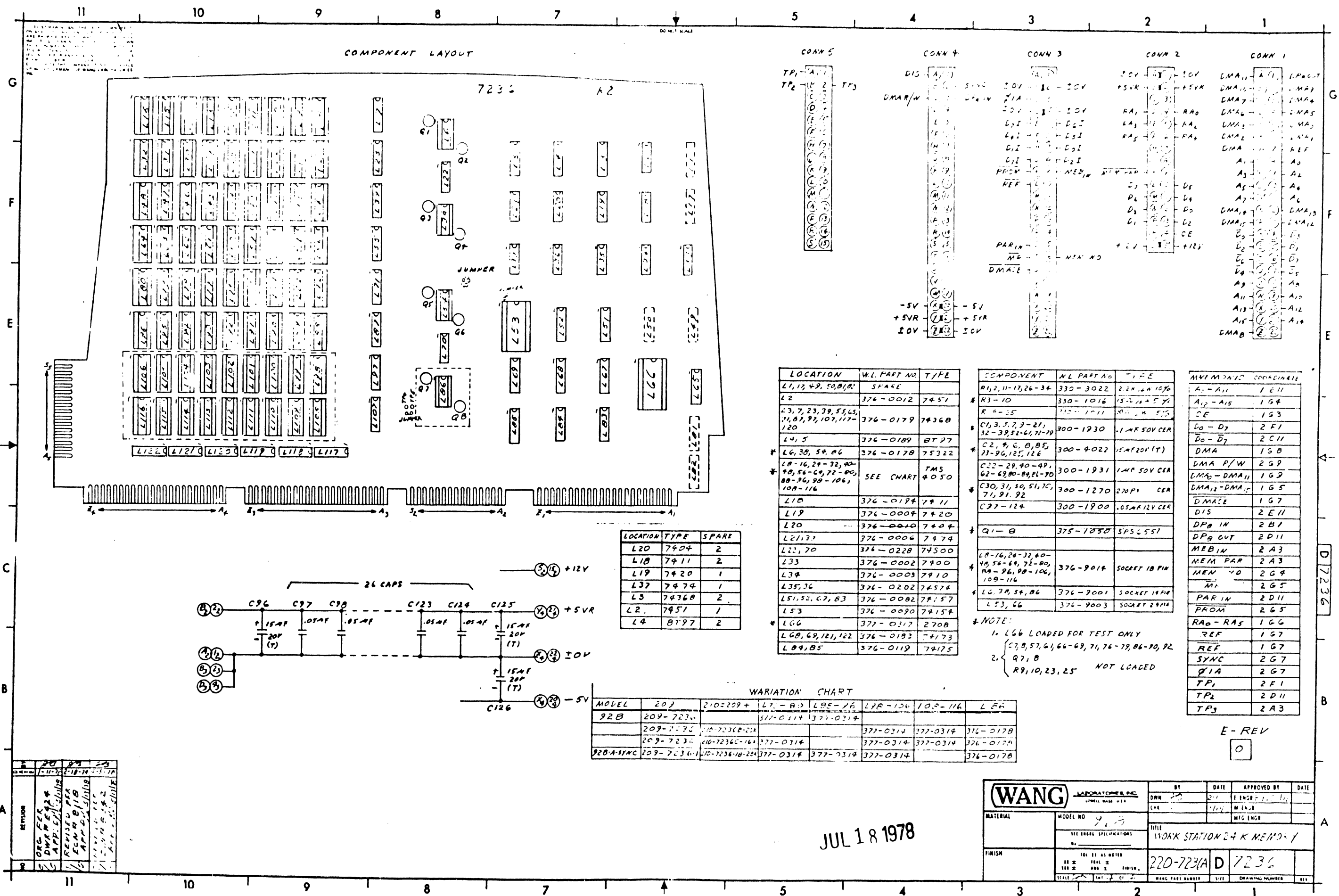

LOCATION	TYPE	SPARE
L20	7404	2
L18	7411	2
L19	7420	1
L37	7474	1
L3	74360	2
L2	7451	1
L4	8797	2

LOCATION	W.L. PART NO.	TYPE
L1, 17, 49, 50, 81, 81	SPARE	
L2	376-0012	7451
L3, 7, 23, 39, 55, 65, 71, 87, 97, 107, 117, 120	376-0179	74360
L4, 5	376-0189	BT 27
L6, 38, 54, 86	376-0178	74322
L8-16, 28-32, 40-48, 56-64, 72-80, 88-96, 98-106, 108-116	SEE CHART	TMS 4050
L15	376-0194	7411
L19	376-0004	7420
L20	376-0040	7404
L21, 77	376-0006	7474
L22, 70	376-0228	74500
L33	376-0002	7400
L34	376-0003	7410
L35, 36	376-0202	74574
L51, 52, 67, 83	376-0082	74157
L53	376-0090	74154
L66	377-0317	2708
L68, 69, 121, 122	376-0193	74173
L84, 85	376-0119	74175

COMPONENT	W.L. PART NO.	TYPE
R1, 2, 11-17, 26-34	330-3022	22K 1/4W 10%
R3-10	330-1016	15-27K 1/4W 5%
R4-25	330-1011	100K 1/4W 5%
C1, 3, 5, 7, 9-21, 32-39, 52-61, 71-79	300-1930	1UF 50V CER
C2, 4, 6, 8, 85, 77-96, 125, 126	300-4022	15UF 20V (T)
C22-29, 40-49, 62-69, 80-84, 86-90	300-1931	1UF 50V CER
C30, 31, 50, 51, 70, 71, 91, 92	300-1270	270PF CER
C97-124	300-1900	.05UF 12V CER
Q1-B	375-1030	SP5C551
L8-16, 28-32, 40-48, 56-64, 72-80, 88-96, 98-106, 108-116	376-9014	SOCKET 18 PIN
L6, 38, 54, 86	376-9001	SOCKET 18 PIN
L53, 66	376-9003	SOCKET 28 PIN

SYMBOL	COORDINATE
A1-A11	1E11
A12-A15	1G4
CE	1G3
D0-D7	2F1
D0-D7	2C11
DMA	1G0
DMA P/W	2G9
DMA1-DMA11	1G9
DMA12-DMA17	1G5
DMA18	1G7
DIS	2E11
DP0 IN	2B1
DP0 OUT	2D11
MEBIN	2A3
MEM PAR	2A3
MEN NO	2G9
MI	2G5
PAR IN	2D11
PROM	2G5
RA0-RA5	1G6
REF	1G7
REF	1G7
SYNC	2G7
Q1A	2G7
TP1	2F1
TP2	2D11
TP3	2A3

MODEL	209-229	210-229	L7-B	L85-16	L78-104	103-116	LER
92B	209-7236	210-7236B-21A	377-0314	377-0314			
	209-7236				377-0314	377-0314	376-0178
	209-7236	210-7236C-16A	377-0314		377-0314	377-0314	376-0178
92B-A-SYNC	209-7236-1	210-7236-10-22A	377-0314	377-0314	377-0314		376-0178

* NOTE:
 1. L66 LOADED FOR TEST ONLY
 2. { C7, 8, 57, 61, 66-69, 71, 76-79, 86-90, 92, 97, 103 } NOT LOADED

REVISION	DATE	BY	DESCRIPTION
1	11-18-78
2

JUL 18 1978

(WANG) LABORATORIES, INC. LOWELL MASS USA		BY	DATE	APPROVED BY	DATE
MATERIAL	MODEL NO. 7236	DNW	2-1	E ENGR	11/18/78
	SEE DRAWING SPECIFICATIONS	CHK	11/18/78	M ENGR	
FINISH	TOL IN AS NOTED			MFG ENGR	
	88 ± .004 ±				
	888 ± .006 ±				
	8888 ± .008 ±				
	88888 ± .010 ±				
	888888 ± .012 ±				
	8888888 ± .015 ±				
	88888888 ± .020 ±				
	888888888 ± .025 ±				
	8888888888 ± .030 ±				
	88888888888 ± .040 ±				
	888888888888 ± .050 ±				
	8888888888888 ± .060 ±				
	88888888888888 ± .080 ±				
	888888888888888 ± .100 ±				
	8888888888888888 ± .120 ±				
	88888888888888888 ± .150 ±				
	888888888888888888 ± .200 ±				
	8888888888888888888 ± .250 ±				
	88888888888888888888 ± .300 ±				
	888888888888888888888 ± .400 ±				
	8888888888888888888888 ± .500 ±				
	88888888888888888888888 ± .600 ±				
	888888888888888888888888 ± .700 ±				
	8888888888888888888888888 ± .800 ±				
	88888888888888888888888888 ± .900 ±				
	888888888888888888888888888 ± 1.000 ±				
	8888888888888888888888888888 ± 1.200 ±				
	88888888888888888888888888888 ± 1.500 ±				
	888888888888888888888888888888 ± 2.000 ±				
	8888888888888888888888888888888 ± 2.500 ±				
	88888888888888888888888888888888 ± 3.000 ±				
	888888888888888888888888888888888 ± 4.000 ±				
	8888888888888888888888888888888888 ± 5.000 ±				
	88888888888888888888888888888888888 ± 6.000 ±				
	888888888888888888888888888888888888 ± 7.000 ±				
	8888888888888888888888888888888888888 ± 8.000 ±				
	88888888888888888888888888888888888888 ± 9.000 ±				
	888888888888888888888888888888888888888 ± 10.000 ±				

SIGNAL	MATA LINK 7227	CPB CRT 7425	MEM I 7236	TC OPT 7230	J1	J2	J3	J4	J5	J6
A0	B1	J1	B1	B1						
A1	J1	J1	J1	J1						
A2	91	91	91	91						
A3	K1	K1	K1	K1						
A4	101	101	101	101						
A5	L1	L1	L1	L1						
A6	111	111	111	111						
A7	M1	M1	M1	M1						
A8	161	161	161	161						
A9	V1	V1	V1	V1						
A10	191	191	191	191						
A11	W1	W1	W1	W1						
A12	201	201	201	201						
A13	X1	X1	X1	X1						
A14	211	211	211	211						
A15	Y1	Y1	Y1	Y1						
AA					1					
AB					7					
AET		A4		T1				11		
BA				41	2					
BB				F1	3					
BP	R3	143								
C4	142	M2								
CA				31	4					
CB				D1	5					
CC				C1	6					
CD				11	20					
CE		142	142	142						
CF				B1	8					
CK	92	102								
CK	92	92								
CLICKER		D4								
D0	122		122							
D1	R1	R1	R1	R1						
D2	P2	P2	P2	P2						
D3	151	151	151	151						
D4	132	132	132	132						
D5	S1	S1	S1	S1						
D6	N2	N2	N2	N2						
D7	141	141	141	141						
D8	112	112	112	112						
D9	U1	U1	U1	U1						
D10	102	102	102	102						
D11	171	171	171	171						
D12	M2	M2	M2	M2						
D13	T1	T1	T1	T1						
D14	L2	L2	L2	L2						
D15	161	161	161	161						
D16	73	73	73	73						
D17	H3	H3	H3	H3						
D18	83	83	83	83						
D19	J3	J3	J3	J3						
D20	F3	F3	F3	F3						
D21	G3	G3	G3	G3						
D22	S3	S3	S3	S3						
D23	E3	E3	E3	E3						
D24	U3	U3	U3	U3						
DB				M1	15					
DB1	82	82		82						
DD				N1	17					
D13	J2	J2	A4							
DMA	H1	H1	M1							
DMA0	S1	S1	S1							
DMA1	G1	G1	F1							
DMA2	F1	F1	F1							
DMA3	E1	E1	E1							
DMA4	S1	S1	S1							
DMA5	41	41	41							
DMA6	D1	D1	D1							
DMA7	C1	C1	C1							
DMA8	Z1	Z1	Z1							
DMA9	21	21	21							
DMA10	B1	B1	B1							
DMA11	A1	A1	A1							
DMA12	131	131	131							
DMA13	121	121	121							
DMA14	N1	N1	N1							
DMA15	P1	P1	P1							
DMA16	U3	U3	U3							
DMA17	124	124								
DMA18	K3	K3	C4							
DMSFR/B		M4								
DP6 IN	93	34	34							
DP6 OUT	11	11	11							
F2	143	143								
+GA	153	153								
+GB										
ZMP		21								
INT		P1								
INTA		M3								
INTE		N1								
INTIC		V3								
I/O		221								

JUL 18 1978

WANG LABORATORIES INC. LITTLE ROCK, ARK.		BY	DATE	APPROVAL BY	DATE
MATERIAL		DWN	7/18	ENGR	
MODEL NO. 128		CHK		M ENGR	
MEMORANDUM SPECIFICATIONS		TITLE		WS MOTHERBOARD W/TC ADAPTER	
FORMS		100	100	100	100
SCALE	100%	DATE PART NUMBER	SIZE	DRAWING NUMBER	REV
		210-7328	D	7328	1

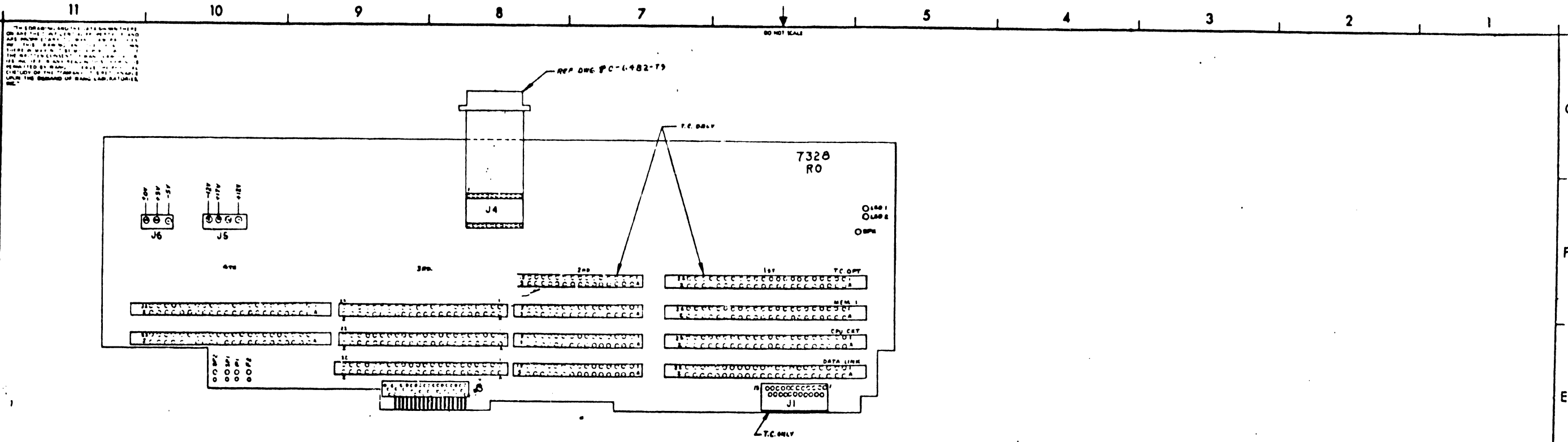

COMPONENT	W.L. PART NO.	QTY
CONN. 1, 4	350-0021	5
CONN. 2	350-0011	3
CONN. 3	350-0039	3
J4	376-9017	1
J4	220-3014	1
J5	654-1194	1
J6	654-1193	1
FOR T.C. ONLY ADD		
CONN. 1	350-0021	1
CONN. 2	350-0011	1
J1	350-1047	1

JUL 18 1978

REVISED PER	DATE
ORIGINATED PER	DATE
DESIGNED PER	DATE
APPROVED PER	DATE
TESTED PER	DATE
ASSEMBLED PER	DATE

(WANG) LABORATORIES INC. LITTLE ROCK, ARK.		BY	DATE	APPROVED BY	DATE
MODEL NO. 928		DWR	7/18/78	E. ENGR. J. J. J.	7/18/78
SEE 10000 SPECIFICATIONS		CHE. 1	7/18/78	M. ENGR.	
TITLE WS MOTHERBOARD w/T.C. ADAPTER				MFG ENGR.	
FOR 01 AS NOTED		210-7328	D	7328	1
REV. 01		SCALE 1:1	SHEET 3 OF 3	WOOD JURY BUREAU	SIZE

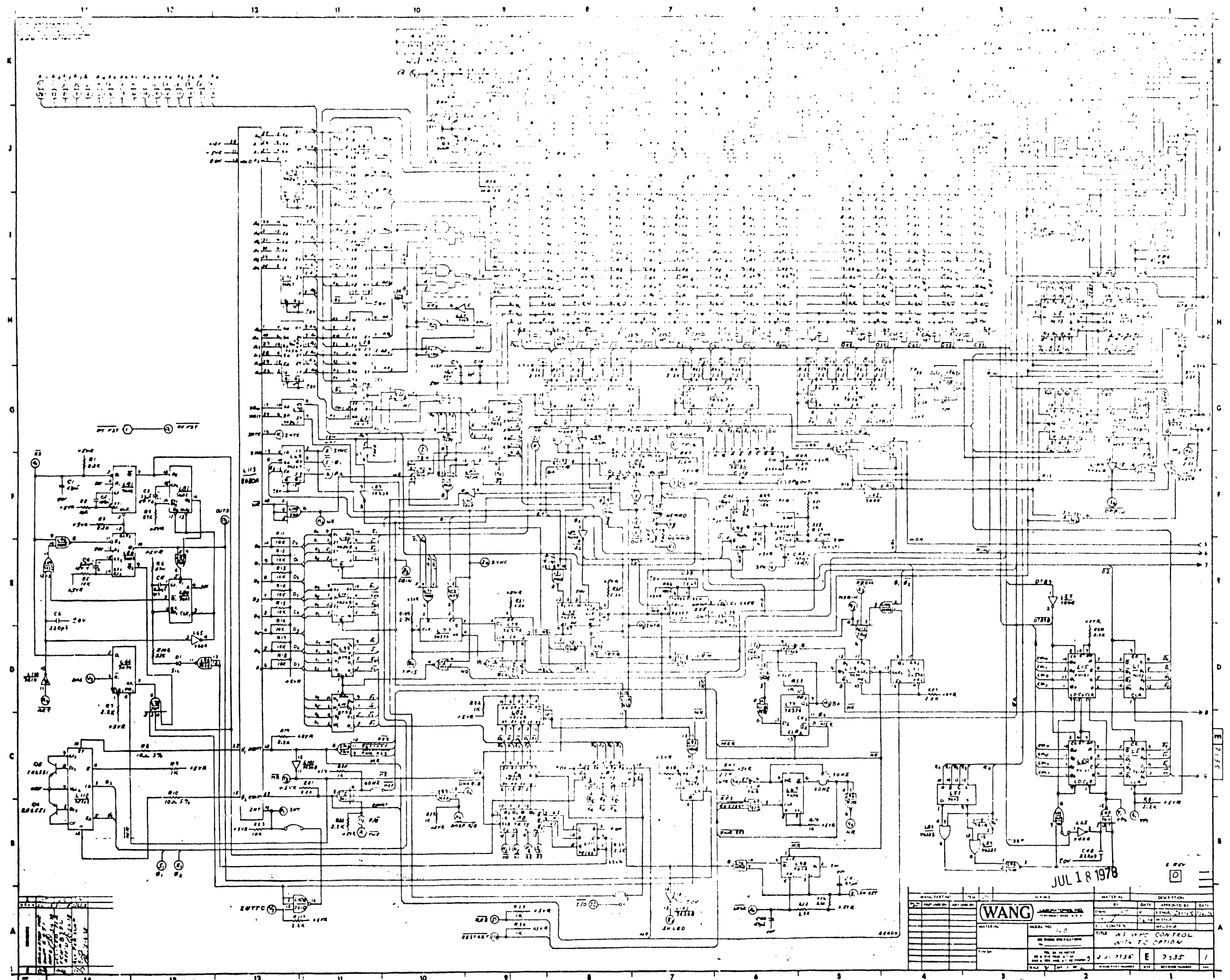

		MODEL NO. 7535 TITLE: AS WANG CONTROL WITH T.C. OPTION DATE: JUL 18 1978 BY: E 7535	
REVISION NO. 1 DATE 7/18/78 BY E 7535	APPROVED BY DATE 7/18/78 BY E 7535	CHECKED BY DATE 7/18/78 BY E 7535	DESIGNED BY DATE 7/18/78 BY E 7535

LOCATION	AL PART NO	TYPE
L1, 3, 4	376-0013	7417
L4, 5, 6	376-0014	7417
L7	376-0015	7417
L8	376-0016	7417
L9	376-0017	7417
L10, 11, 12, 13, 14	376-0018	7417
L15, 16, 17, 18, 19, 20, 21, 22	376-0019	7417
L23, 24, 25, 26, 27, 28, 29, 30, 31, 32, 33, 34, 35, 36, 37, 38, 39, 40, 41, 42, 43, 44, 45, 46, 47, 48, 49, 50, 51, 52, 53, 54, 55, 56, 57, 58, 59, 60, 61, 62, 63, 64, 65, 66, 67, 68, 69, 70, 71, 72, 73, 74, 75, 76, 77, 78, 79, 80, 81, 82, 83, 84, 85, 86, 87, 88, 89, 90, 91, 92, 93, 94, 95, 96, 97, 98, 99, 100, 101, 102, 103, 104, 105, 106, 107, 108, 109, 110, 111, 112, 113, 114, 115, 116, 117, 118, 119, 120, 121, 122, 123, 124, 125, 126, 127, 128, 129, 130, 131, 132, 133, 134, 135, 136, 137, 138, 139, 140, 141, 142, 143, 144, 145, 146, 147, 148, 149, 150, 151, 152, 153, 154, 155, 156, 157, 158, 159, 160, 161, 162, 163, 164, 165, 166, 167, 168, 169, 170, 171, 172, 173, 174, 175, 176, 177, 178, 179, 180, 181, 182, 183, 184, 185, 186, 187, 188, 189, 190, 191, 192, 193, 194, 195, 196, 197, 198, 199, 200, 201, 202, 203, 204, 205, 206, 207, 208, 209, 210, 211, 212, 213, 214, 215, 216, 217, 218, 219, 220, 221, 222, 223, 224, 225, 226, 227, 228, 229, 230, 231, 232, 233, 234, 235, 236, 237, 238, 239, 240, 241, 242, 243, 244, 245, 246, 247, 248, 249, 250, 251, 252, 253, 254, 255, 256, 257, 258, 259, 260, 261, 262, 263, 264, 265, 266, 267, 268, 269, 270, 271, 272, 273, 274, 275, 276, 277, 278, 279, 280, 281, 282, 283, 284, 285, 286, 287, 288, 289, 290, 291, 292, 293, 294, 295, 296, 297, 298, 299, 300, 301, 302, 303, 304, 305, 306, 307, 308, 309, 310, 311, 312, 313, 314, 315, 316, 317, 318, 319, 320, 321, 322, 323, 324, 325, 326, 327, 328, 329, 330, 331, 332, 333, 334, 335, 336, 337, 338, 339, 340, 341, 342, 343, 344, 345, 346, 347, 348, 349, 350, 351, 352, 353, 354, 355, 356, 357, 358, 359, 360, 361, 362, 363, 364, 365, 366, 367, 368, 369, 370, 371, 372, 373, 374, 375, 376, 377, 378, 379, 380, 381, 382, 383, 384, 385, 386, 387, 388, 389, 390, 391, 392, 393, 394, 395, 396, 397, 398, 399, 400, 401, 402, 403, 404, 405, 406, 407, 408, 409, 410, 411, 412, 413, 414, 415, 416, 417, 418, 419, 420, 421, 422, 423, 424, 425, 426, 427, 428, 429, 430, 431, 432, 433, 434, 435, 436, 437, 438, 439, 440, 441, 442, 443, 444, 445, 446, 447, 448, 449, 450, 451, 452, 453, 454, 455, 456, 457, 458, 459, 460, 461, 462, 463, 464, 465, 466, 467, 468, 469, 470, 471, 472, 473, 474, 475, 476, 477, 478, 479, 480, 481, 482, 483, 484, 485, 486, 487, 488, 489, 490, 491, 492, 493, 494, 495, 496, 497, 498, 499, 500, 501, 502, 503, 504, 505, 506, 507, 508, 509, 510, 511, 512, 513, 514, 515, 516, 517, 518, 519, 520, 521, 522, 523, 524, 525, 526, 527, 528, 529, 530, 531, 532, 533, 534, 535, 536, 537, 538, 539, 540, 541, 542, 543, 544, 545, 546, 547, 548, 549, 550, 551, 552, 553, 554, 555, 556, 557, 558, 559, 560, 561, 562, 563, 564, 565, 566, 567, 568, 569, 570, 571, 572, 573, 574, 575, 576, 577, 578, 579, 580, 581, 582, 583, 584, 585, 586, 587, 588, 589, 590, 591, 592, 593, 594, 595, 596, 597, 598, 599, 600, 601, 602, 603, 604, 605, 606, 607, 608, 609, 610, 611, 612, 613, 614, 615, 616, 617, 618, 619, 620, 621, 622, 623, 624, 625, 626, 627, 628, 629, 630, 631, 632, 633, 634, 635, 636, 637, 638, 639, 640, 641, 642, 643, 644, 645, 646, 647, 648, 649, 650, 651, 652, 653, 654, 655, 656, 657, 658, 659, 660, 661, 662, 663, 664, 665, 666, 667, 668, 669, 670, 671, 672, 673, 674, 675, 676, 677, 678, 679, 680, 681, 682, 683, 684, 685, 686, 687, 688, 689, 690, 691, 692, 693, 694, 695, 696, 697, 698, 699, 700, 701, 702, 703, 704, 705, 706, 707, 708, 709, 710, 711, 712, 713, 714, 715, 716, 717, 718, 719, 720, 721, 722, 723, 724, 725, 726, 727, 728, 729, 730, 731, 732, 733, 734, 735, 736, 737, 738, 739, 740, 741, 742, 743, 744, 745		

COMPONENT	AL PART NO	TYPE
R1	376-0020	7417
R2	376-0021	7417
R3	376-0022	7417
R4	376-0023	7417
R5	376-0024	7417
R6	376-0025	7417
R7	376-0026	7417
R8	376-0027	7417
R9	376-0028	7417
R10	376-0029	7417
R11	376-0030	7417
R12	376-0031	7417
R13	376-0032	7417
R14	376-0033	7417
R15	376-0034	7417
R16	376-0035	7417
R17	376-0036	7417
R18	376-0037	7417
R19	376-0038	7417
R20	376-0039	7417
R21	376-0040	7417
R22	376-0041	7417
R23	376-0042	7417
R24	376-0043	7417
R25	376-0044	7417
R26	376-0045	7417
R27	376-0046	7417
R28	376-0047	7417
R29	376-0048	7417
R30	376-0049	7417
R31	376-0050	7417
R32	376-0051	7417
R33	376-0052	7417
R34	376-0053	7417
R35	376-0054	7417
R36	376-0055	7417
R37	376-0056	7417
R38	376-0057	7417
R39	376-0058	7417
R40	376-0059	7417
R41	376-0060	7417
R42	376-0061	7417
R43	376-0062	7417
R44	376-0063	7417
R45	376-0064	7417
R46	376-0065	7417
R47	376-0066	7417
R48	376-0067	7417
R49	376-0068	7417
R50	376-0069	7417
R51	376-0070	7417
R52	376-0071	7417
R53	376-0072	7417
R54	376-0073	7417
R55	376-0074	7417
R56	376-0075	7417
R57	376-0076	7417
R58	376-0077	7417
R59	376-0078	7417
R60	376-0079	7417
R61	376-0080	7417
R62	376-0081	7417
R63	376-0082	7417
R64	376-0083	7417
R65	376-0084	7417
R66	376-0085	7417
R67	376-0086	7417
R68	376-0087	7417
R69	376-0088	7417
R70	376-0089	7417
R71	376-0090	7417
R72	376-0091	7417
R73	376-0092	7417
R74	376-0093	7417
R75	376-0094	7417
R76	376-0095	7417
R77	376-0096	7417
R78	376-0097	7417
R79	376-0098	7417
R80	376-0099	7417
R81	376-0100	7417
R82	376-0101	7417
R83	376-0102	7417
R84	376-0103	7417
R85	376-0104	7417
R86	376-0105	7417
R87	376-0106	7417
R88	376-0107	7417
R89	376-0108	7417
R90	376-0109	7417
R91	376-0110	7417
R92	376-0111	7417
R93	376-0112	7417
R94	376-0113	7417
R95	376-0114	7417
R96	376-0115	7417
R97	376-0116	7417
R98	376-0117	7417
R99	376-0118	7417
R100	376-0119	7417
R101	376-0120	7417
R102	376-0121	7417
R103	376-0122	7417
R104	376-0123	7417
R105	376-0124	7417
R106	376-0125	7417
R107	376-0126	7417
R108	376-0127	7417
R109	376-0128	7417
R110	376-0129	7417
R111	376-0130	7417
R112	376-0131	7417
R113	376-0132	7417
R114	376-0133	7417
R115	376-0134	7417
R116	376-0135	7417
R117	376-0136	7417
R118	376-0137	7417
R119	376-0138	7417
R120	376-0139	7417
R121	376-0140	7417
R122	376-0141	7417
R123	376-0142	7417
R124	376-0143	7417
R125	376-0144	7417
R126	376-0145	7417
R127	376-0146	7417
R128	376-0147	7417
R129	376-0148	7417
R130	376-0149	7417
R131	376-0150	7417
R132	376-0151	7417
R133	376-0152	7417
R134	376-0153	7417
R135	376-0154	7417
R136	376-0155	7417
R137	376-0156	7417
R138	376-0157	7417
R139	376-0158	7417
R140	376-0159	7417
R141	376-0160	7417
R142	376-0161	7417
R143	376-0162	7417
R144	376-0163	7417
R145	376-0164	7417
R146	376-0165	7417
R147	376-0166	7417
R148	376-0167	7417
R149	376-0168	7417
R150	376-0169	7417
R151	376-0170	7417
R152	376-0171	7417
R153	376-0172	7417
R154	376-0173	7417
R155	376-0174	7417
R156	376-0175	7417
R157	376-0176	7417
R158	376-0177	7417
R159	376-0178	7417
R160	376-0179	7417
R161	376-0180	7417
R162	376-0181	7417
R163	376-0182	7417
R164	376-0183	7417
R165	376-0184	7417
R166	376-0185	7417
R167	376-0186	7417
R168	376-0187	7417
R169	376-0188	7417
R170	376-0189	7417
R171	376-0190	7417
R172	376-0191	7417
R173	376-0192	7417
R174	376-0193	7417
R175	376-0194	7417
R176	376-0195	7417
R177	376-0196	7417
R178	376-0197	7417
R179	376-0198	7417
R180	376-0199	7417
R181	376-0200	7417
R182	376-0201	7417
R183	376-0202	7417
R184	376-0203	7417
R185	376-0204	7417
R186	376-0205	7417
R187	376-0206	7417
R188	376-0207	7417
R189	376-0208	7417
R190	376-0209	7417
R191	376-0210	7417
R192	376-0211	7417
R193	376-0212	7417
R194	376-0213	7417
R195	376-0214	7417
R196	376-0215	7417
R197	376-0216	7417
R198	376-0217	7417
R199	376-0218	7417
R200	376-0219	7417
R201	376-0220	7417
R202	376-0221	7417
R203	376-0222	7417
R204	376-0223	7417
R205	376-0224	7417
R206	376-0225	7417
R207	376-0226	7417
R208	376-0227	7417
R209	376-0228	7417
R210	376-0229	7417
R211	376-0230	7417
R212	376-0231	7417
R213	376-0232	7417
R214	376-0233	7417
R215	376-0234	7417
R216	376-0235	7417
R217	376-0236	7417
R218	376-0237	7417
R219	376-0238	7417
R220	376-0239	7417
R221	376-0240	7417
R222	376-0241	7417
R223	376-0242	7417
R224	376-0243	7417
R225	376-0244	7417
R226	376-0245	7417
R227	376-0246	7417
R228	376-0247	7417
R229	376-0248	7417
R230	376-0249	7417
R231	376-0250	7417
R232	376-0251	7417
R233	376-0252	7417
R234	376-0253	7417
R235	376-0254	7417
R236	376-0255	7417
R237	376-0256	7417
R238	376-0257	7417
R239	376-0258	7417
R240	376-0259	7417
R241	376-0260	7417
R242	376-0261	7417
R243	376-0262	

6 5 4 3 2 1

DO NOT SCALE

HOLE LEGEND

DRILLED OR PUNCHED HOLE TOLERANCES:	HOLE DIA.	TOL.
	.0135 to .125	+ .003 - .001
	.126 to .250	+ .004 - .001
	.251 to .500	+ .005 - .001

IDENT.	DESCRIPTION	QTY.
A		

CHASSIS GND
XMT DATA
RCV DATA
REQ TO SEND
CLEAR TO SEND
DATA SET READY
SIGNAL GND
CARRIER DET
SUP. XMT
SUP. RCV
DATA TERM. READY
RING

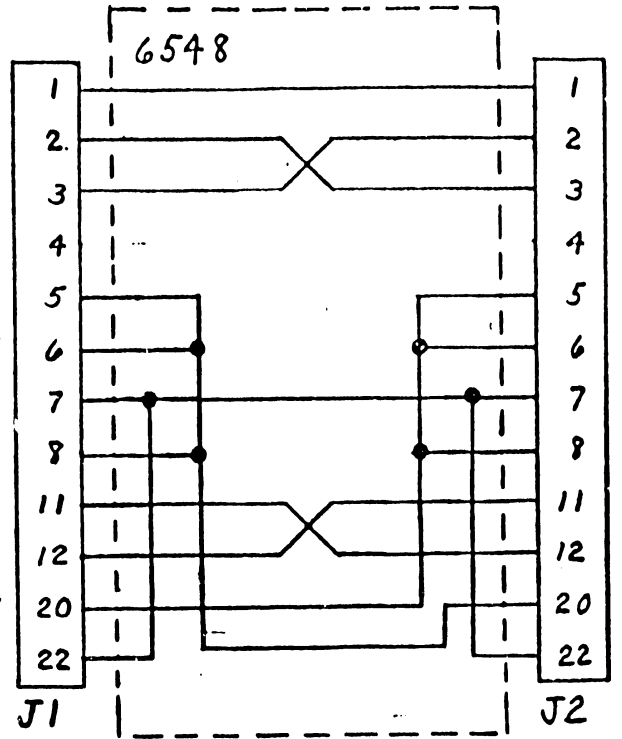

WANG LABORATORIES, INC.		PL 6548-4	A				
DATE: 7/18/78		REV: 21C-6548	REV: 1				
NULL MODEN JUNCTION							
QTY PER DASH NO	REV	WANG PART NUMBER	WANG DRAWING NUMBER	NOMENCLATURE OR DESCRIPTION	ITEM NO		
	-4						
	1	510-6548		6548 PC BOARD	1		
	2	350-1031		DB-25S CH CONN. 6000 SERIES	2		
					3		
REV	REVISION DESCRIPTION	DATE	APPROVED	REV	REVISION DESCRIPTION	DATE	APPROVED
VENDOR ITEM FOR PROCUREMENT OR PART NUMBER SEE SPECIFICATION CONTROL OR SOURCE CONTROL DRAWING		NOTES		MODEL 2227 N		PL 6548-4	

JUL 18 1978

NO	REVISION	DATE	BY
2			

WANG PART NO.	ITEM	QTY.	NAME	MATERIAL	DESCRIPTION		
			WANG LABORATORIES, INC. TEWKSBURY, MASS. U. S. A.	BY	DATE	APPROVED BY	DATE
				DWN J.E.	7/18/78	E ENGR	J.E.
			MATERIAL	MODEL NO.	TITLE		
				2227-N	WIRING DIAGRAM		
			FINISH	SEE ENGRG SPECIFICATIONS	NULL MODEN JUNCTION		
				TOL. EX. AS NOTED			
				.XX ± .010 FRAC. ± 1/64			
				.XXX ± .005 ANG ± 1°30' FINISH ✓			
			SCALE	SHT / OF /	WANG PART NUMBER	DWG NUMBER	REV.

2228N
MODEM
(TO BE SUPPLIED)

END