

1186 USER'S GUIDE

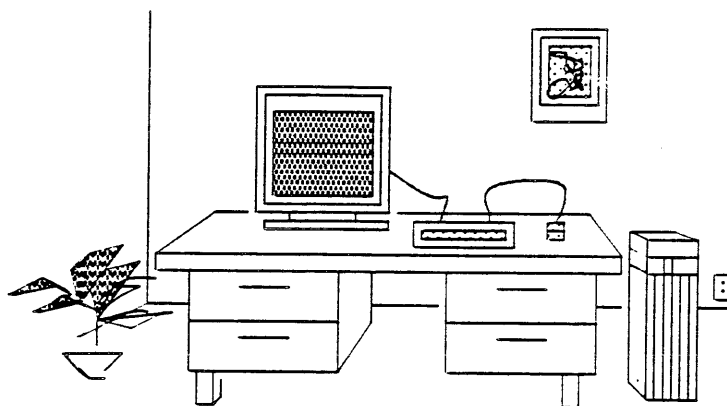

XEROX

Copyright © 1986 by Xerox Corporation
All rights reserved.

DEC, VAX, VMS, and VT100 are trademarks of Digital Equipment Corporation.

IBM is a registered trademark of International Business Machines.

Text revision number:
3102061

Manual reorder number
3101352

Table of Contents

1. Introduction	1
The 1186 Workstation	1
Getting Started	3
Software	5
The Lisp Sysout	5
Starting Lisp	6
Installing a Sysout	7
Loading Interlisp-D Packages	7
Copying Floppies to a File Server	8
Cursor Codes	9
Booting the Xerox 1186	10
The Ethernet	11
Copying Files Between Machines	12
Advice For the Standalone User	12
References	13
2. Equipment	15
Environmental Requirements	15
Electrical Requirements	16
Standard Equipment	16
Processor	16
Display	19

TABLE OF CONTENTS

Keyboard	20
Mouse	22
Optional Equipment	23
Floppy Disk Drive	23
Ethernet Transceiver and Controller	24
Ethernet Interface	24
Peripheral Equipment	24
Cables	24
Power Supply	25
3. Using the 1186	27
Turning the 1186 On	27
Booting the 1186	28
Booting Sequence for Interlisp-D	28
Turning the 1186 Off	29
Routine Maintenance	29
Keyboard	29
Mouse	29
Display Screen	30
Floppy Disk Drive	30
Floppy Disks	30
Troubleshooting	31
Reporting Problems	32
4. Software Installation	33
Installing Lisp on the 1186 Workstation	33

<u>Floppy Disks Needed</u>	33
<u>Factory Configuration</u>	34
<u>Partitioning</u>	34
<u>Steps for Partitioning</u>	34
<u>Microcode and System Tool Installation</u>	35
<u>Steps for Microcode and System Tool Installation</u>	36
<u>Installing the Lisp Sysout from Floppies</u>	38
<u>Steps for Installing the Lisp Sysout from Floppies</u>	38
<u>Installing the Lisp Sysout from the Network</u>	39
<u>Steps for Installing a Lisp Sysout from the Network</u>	40
<u>To Re-Install a Lisp Sysout from the Rigid Disk</u>	43
<u>Steps for Re-Installing a Lisp Sysout</u>	43
<u>Initializing Lisp</u>	44
<u>Steps for Initializing Lisp</u>	45
<u>Loading Interlisp-D Packages</u>	46
<u>Logging Out of Lisp</u>	48
<u>Steps for Logging Out of Lisp</u>	48
<u>Troubleshooting for Lisp Installation</u>	48
<u>Rigid DiskFile System</u>	49
<u>Disk Partitions</u>	49
<u>File System Utility Functions</u>	50
<u>File Name Conventions</u>	52
<u>Disk Scavenging</u>	53

5. System Tools	57
Introduction	57
The Profile Tool	58
Parameter Items	61
Command Items	62
The Lisp System Tool	63
Parameter Items	65
Command Items	68
The On-Line Diagnostic Tool	74
Parameter Items	76
Command Items	76
6. Input/Output	77
Floppy Disk Support	77
Naming, Erasing and Formatting Floppies	78
Copying Floppies	79
Loading Sysouts and Other Large Files onto Floppies	79
Measuring Unused Floppy Space	81
Testing Whether a Floppy is in the Drive	81
Scavenging Floppies	82
RS232 Support	82
Cable Configurations for RS232C Port and TTY Ports	83

7. Diagnostics	87
Boot Options for Running Diagnostics	87
Preboot Diagnostics	87
Boot Diagnostics	88
Cursor Codes	91
Pilot Operating System Codes	92
Lisp Codes	92
Glossary	99
Index	107

Appendix A - Setting the Time

Setting Date and Time on Standalone Workstations

Appendix B - The Floppy Copy Utility

Copying Floppy Disks

Appendix C - Library Guide

How to Load from the Library Floppies

Library Floppy Index

HelpSys Floppy Index

[This page intentionally left blank.]

1.

INTRODUCTION

The 1186 is an artificial intelligence development workstation that combines Xerox hardware and software to provide a wide variety of user applications. This chapter provides a brief overview of the 1186 workstation and its software environment.

The 1186 Workstation

Your workstation consists of the components described below.

Display Screen: When the power is turned on, the screen should display the boot icons, on-screen representations of the 10 function keys at the top of your keyboard.

Processor Unit: The central processor (CP) is in a brown, rectangular box about two feet tall that usually sits on the floor close to the screen and keyboard. The power switch is on the front of the processor unit (often called the front panel) near the top, just under the word "Xerox". The switch is labeled with a 0 and a 1; 0 is off, 1 is on. Also near the power switch are the boot button (labeled B Reset), a green "power on" light, and three red lights which are used for diagnostic purposes (see chapter 7, Diagnostics).

If your 1186 isn't on, you can turn it on by pushing the power switch to 1. The screen should flash and after a minute or two the boot icons should appear.

Contained in the processor unit is the **Rigid Disk**. If you purchased a **Floppy Disk Drive**, it will probably be sitting on top of the processor unit (for complete details on the rigid disk and the floppy disk drive see chapter 2, Equipment and chapter 3, Using the 1186).

Keyboard: The keyboard is attached to the display by a cable and is the way you interact with the processor (see chapter 2, Equipment).

Three-button Optical Mouse: The mouse is attached to the keyboard with a thin insulated wire. It guides a pointer (called the mouse cursor) across the screen (see chapter 2, Equipment). The mouse comes with an optical mouse pad, and must be on the pad when you move it.

Sometimes the mouse cursor will change shape and display a series of four numbers. These are cursor codes and the numbers represent both progress and error conditions (see chapter 7, Diagnostics).

Together these components comprise the standard 1186 configuration. You should read chapter 2, Equipment and chapter 3, Using the 1186, to familiarize yourself with the care and use of your Xerox 1186 workstation's equipment.

Getting Started

Xerox 1186 workstations come with some software (a Lisp sysout and System Tools) already installed on the rigid disk.

If you discover that software isn't installed, that you cannot load it due to some mishap during either installation or shipping, or you decide to repartition (i.e., erase and restructure) your disk, you will need to follow the procedures found in chapter 4, Software Installation.

Your workstation should be turned on and the boot icons displayed. Press the F1 key on your keyboard. If a boot icon other than the one representing the F1 key is already darkened you must press the boot button (B Reset) first.

Pressing the F1 key begins the loading process of your Interlisp-D environment, called a sysout. (This is described in a subsequent section called **The Lisp Sysout**.) In the upper left hand corner of your screen you will see a small square containing four numbers. These numbers are called cursor codes and are used to inform you of the progress of the operation you are running. The sysout loading process takes one to two minutes.

If Interlisp-D loads successfully your screen will display three windows: the Interlisp-D Executive window (figure 1) the prompt window (figure 2) and the Interlisp-D logo window (figure 4).

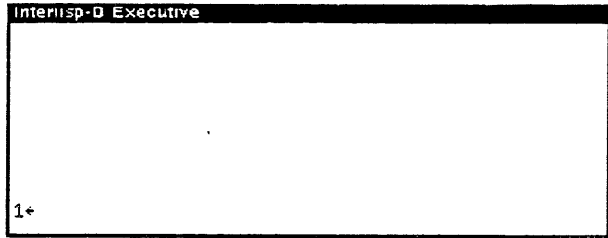

Figure 1. The Interlisp-D Executive window

The executive window is the window where you interact with the system by typing in commands and Lisp expressions to be evaluated.

You will also see the prompt window (figure 2),

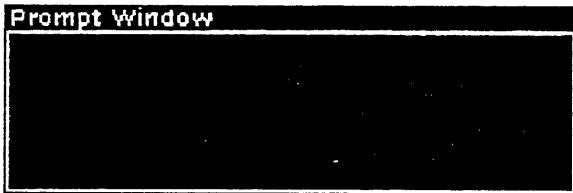

Figure 2. The prompt window

The prompt window is where system messages are printed. For example, if you are not connected to a network that has a time server, or the 1186 cannot get the time for any other reason, the prompt window will print a message (figure 3). You should always work in an environment with the correct time set. If the time is not set on your workstation see Appendix A-Setting the Time.

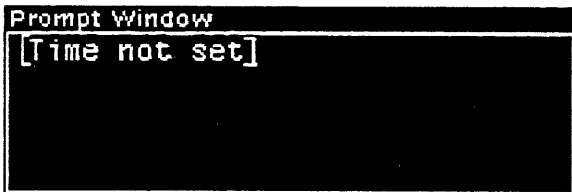

Figure 3. Prompt window with message indicating that time is not set

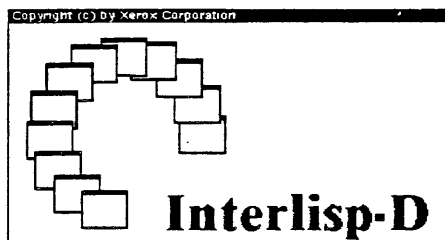

Figure 4. The Interlisp-D logo window

Software

Xerox supplies several software systems with the 1186. Each system is recorded on one or more floppy disks. The major system is the Interlisp-D sysout. Other systems provided are a software installation utility, Lisp Library packages, and machine diagnostics.

Two examples of Library packages are the text editing package called TEdit and the drawing program called Sketch.

The Lisp Sysout

A sysout is a snapshot of an Interlisp-D environment. The sysout contains all the information needed to start the initial state of the Interlisp-D system—a sysout is the initial contents of virtual memory. As you run Lisp, its virtual memory grows to accommodate newly allocated data structures, compiled code and the like.

If you want to stop working in the sysout and want to save the state of your virtual memory (e.g., the entire environment plus the software modules you have loaded) you must log out of Interlisp-D. You do this by typing (LOGOUT).

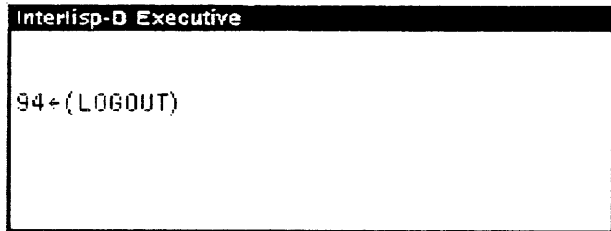

Figure 5. The Interlisp-D executive window during execution of a logout

After you type the closing parenthesis, Interlisp-D automatically begins saving the current state of your virtual memory. The state of the virtual memory will be stored in the logical volume in which you were running. You can resume your Interlisp-D session from the place where you logged out with an F1 boot.

You can produce sysouts of your own, which capture the state of your own custom environment, by using the function SYSOUT (See chapter 6, Input/Output and the *Interlisp-D Reference Manual*).

Starting Lisp

If you want to resume running from the point of the most recent LOGOUT, simply press F1 while the boot icons are displayed.

When Interlisp-D is started for the first time, it may ask you to supply the name of an Init file. An Init file contains information that configures Interlisp-D for your installation.

For example, the file INIT.NONET configures Interlisp-D for an 1186 that is not connected to a network with a file server. To use it, put the Lisp Library floppy containing INIT.NONET into the floppy drive and type

{FLOPPY}INIT.NONET

in response to the prompt for an Init file. If you prefer not to specify an Init file, press the carriage return.

You may also be prompted for a PUP host ID. For an explanation of this request, see the section of this chapter entitled **The Ethernet**.

After you have run Interlisp-D once, you will probably want to store the Init file of your choosing on the local disk, so that it is loaded automatically when you start a fresh sysout.

After the initialization finishes, a caret will start blinking in the Interlisp-D Executive window, indicating you can now enter expressions and commands.

Installing a Sysout

Fresh sysouts may be installed in logical volumes *Lisp*, *Lisp2*, etc. by running System Tools (see chapter 5, System Tools). Sysouts also can be installed from floppy disks or from a file server. You may also copy a sysout from one logical volume to another if the sysout on the source volume has never been started (see chapter 4, Software Installation).

Loading Interlisp-D Packages

Xerox supplies two sets of floppies containing Interlisp-D software modules: the Lisp Library, which contains software supported by Xerox; and Lisp Users, which contains user-written software not supported by Xerox.

Please consult Appendix C-Library Guide, before attempting to load a specific Library package into your virtual memory. Appendix C lists those packages that require you to load files from more than one floppy disk, provides the sequence of

loading, and contains an index indicating which modules reside on which floppies

Each module consists of one or more compiled files. There are also floppies containing fonts and the on-line documentation (HelpSys).

To load a module from these floppies into a running Interlisp-D environment, insert the floppy containing the module you need into the floppy disk drive, and use the LOAD function to read it into virtual memory.

For instance, to load the Grapher module, type
(LOAD '{FLOPPY}GRAPHER.DCOM)

to the Interlisp-D Executive. If you are loading many modules, you may find it convenient instead to first connect to the floppy device by typing

CONN {FLOPPY}

after which you could type simply

(LOAD 'GRAPHER.DCOM).

When a module such as Grapher is loaded, the system attempts to automatically load all the files on which the module depends that have not yet been loaded. If the required files are stored on a floppy disk other than the one currently loaded in the floppy disk drive, the system will fail to find them.

Copying Floppies to a File Server

Another solution, which most users with a file server or a large disk are likely to prefer, is to copy the contents of the floppies to the file server or disk. Then the system can load all the necessary files directly from the server or disk with no further intervention. You can either copy everything on the floppies or just the modules you need. The Library module Copyfiles is useful for loading the

contents of the floppies to a file server or a rigid disk.

Load COPYFILES.DCOM from the Library and then, for each floppy you wish to copy type (in the executive window),

```
(COPYFILES '{FLOPPY}' '{host}<directory>')
```

where {host}<directory> specifies a directory on a file server where you have set aside space for Library files, or is {DSK}<LISPPFILES> if you are copying the files to your machine's rigid disk.

If you only wish to copy selected files from the floppies, you can copy them one at a time with the function COPYFILE, or more conveniently use the Library module File Browser to browse each floppy and copy the files you desire. See the Lisp Library documentation for the CopyFiles and File Browser modules for more details.

Note: The HelpSys file IRM.HASHFILE is an exception: it spans three floppies and must be copied in "huge" mode (see chapter 6, Input/Output).

Cursor Codes

Two types of codes are displayed in the four-digit cursor code: progress codes and error codes. These codes are called cursor codes because the mouse cursor changes shape to display a four-digit number.

Progress codes are displayed at various stages of booting and initialization. These codes vanish when initialization is finished, or halt in some error code.

Error codes are indications of problems in the program you are attempting to run. Codes less than 9000 are displayed by non-Lisp systems (e.g., the booting programs), while codes in the range 9000-9999 are displayed while Lisp is running. Error codes usually indicate serious errors, as most minor errors during Lisp operation are handled within the Interlisp-D Break Package. Thus an error code generally indicates a software error in a part of the system where it would be dangerous to signal a normal Lisp error.

When Lisp encounters such an error, it halts, displays a cursor code indicating the type of error, and waits for you to take some action. You have a choice of two actions: (1) you can press the UNDO key, which calls a debugging program called TeleRaid (a Library Module); from which it is possible to inspect the halted machine's state from another (network connected) workstation; or (2) you can press the STOP key, in which case the system attempts a "Hard Reset", which clears the state of any active computation and restarts all processes from the top.

If the failure persists, please note the cursor code and notify Xerox AISupport. It is also helpful to gather additional information by running TeleRaid.

Occasionally there are fundamental problems during booting signaled by a combination of red lights above the boot button.

Refer to chapter 7, Diagnostics for more information about error codes and boot lights.

Booting the Xerox 1186

Booting Lisp or other software on the Xerox 1186 is a two-stage process. First, press the boot button (labeled B Reset) on the front of the processor. The screen will display the boot icons (The boot icons are also displayed when you first power up the Xerox 1186, or after performing a (LOGOUT) in Lisp). Then press one of the 10 keyboard function keys, labeled F1 through F10. Each key specifies a different mode of booting. Some ways of booting are:

- F1** Resumes running Interlisp-D from the most recent session. When you press F1 the display will darken and the cursor will cycle numbers in the upper left-hand corner while the system initializes memory. If you have aborted the previous Interlisp-D session without logging out, an F1-boot may fail; a typical cursor code in this case is 0217.
- F1 0** Invokes the System Tools which allow you to install a new environment on a volume, or run the saved environment from a different volume than the most recent one used. To do this, press F1, then immediately press and release the zero key.
- F2** Boots software from an appropriately configured floppy disk. The *Installation Utility*, supplied with the Xerox 1186, is such a floppy; the Lisp Library Packages floppies are not.
- F6** Boots the Boot Diagnostics floppy, which runs a comprehensive set of machine diagnostics (See chapter 7, Diagnostics).

The Ethernet

The Xerox 1186 is equipped with a controller for a 10MHz Ethernet. This permits the Xerox 1186 to utilize the services of file servers, print servers, and other equipment that speak the Xerox Network Services (NS) protocols. The Ethernet also allows the Xerox 1186 to communicate with other Xerox 1100 series workstations on the network.

Each Xerox processor is uniquely identified with a 48-bit host number. This number is used to identify the Xerox 1186 in every NS network transaction.

Interlisp-D can also use PUP protocols to communicate with certain servers. The PUP protocols use 8-bit host numbers unique only within one network. These numbers are not hard-wired in the processor itself, but are usually assigned to each machine by a system administrator. If you find that you need a PUP number please consult your system administrator.

Occasionally devices on the Ethernet may fail to communicate, either due to a hardware problem with the network, or the network software on some server. If you should experience trouble consult your system administrator.

Copying Files Between Machines

On a network that lacks a file server, it is sometimes convenient to be able to transfer files directly between two Xerox 1186 workstations. The Library module FTPServer provides such a capability. Please consult the documentation of the module FTPServer in the Lisp Library Packages manual.

Advice For the Standalone User

If your 1186 is a standalone system, the following considerations are important:

Back-up your critical files. In a very short time you will accumulate a large number of files on your rigid disk. Back up the most important ones on floppy disks. You can always reload software into your machine using the floppies that were provided. But if you have created a critical file, saved it on your rigid disk but not on floppies, you run the risk of losing the file forever if you experience an unrecoverable failure of the rigid disk.

Two Library packages are useful in backing up your files; the Copyfiles package and the File Browser package. Please consult the Lisp Library Packages manual for information on these packages.

Remember to set the time. Every time you log out of Interlisp you lose the time setting. Saving files when you are working in a sysout without the time set is a risky business. Always perform a (SETTIME) when you first begin an Interlisp-D session (see Appendix A-Setting theTime).

[This page intentionally left blank.]

2.

EQUIPMENT

The 1186 is a high-performance, artificial intelligence workstation designed for a wide range of environments. The 1186 workstation can be configured from a group of standard components, or expanded to include optional features.

Environmental Requirements

When Workstation is Operating:

Audible noise (processor only)	47DBA
Temperature	50-90 degrees F
Relative humidity	15%-85%
Altitude	to 6000 feet
Heat dissipation BTU/per hr (processor only)	
max configuration	1462
min configuration	853
15-inch display	205
19-inch display	341
floppy disk drive	68

When Workstation is Turned Off:

Temperature	-20 to 150 degrees F
Relative Humidity	15%-90%
Altitude	to 25000 feet

Safety Approvals

The 1186 has the agency approvals listed below:

Electromagnetic Emissions FCC-A, VDE-A

Safety UL 478, IEC 380, CSA C22, No. 154

Electrical Requirements

The 1186 uses one outlet for the processor and the display. A second power outlet is required to connect an optional local printer. An outlet on the back of the processor unit provides power for the display. Nominal current for the 1186 workstation is 3.0 Amperes, with the processor generating 2.6 amperes, and the display generating 0.4 Amperes.

Standard Equipment

Your 1186 workstation comes with four standard components:

- processor
- display
- keyboard
- mouse

Processor

The 1186 electronics, power supply, and rigid disk are housed in a floor-standing processor unit. At the rear of the processor are ports for connecting the display and keyboard, and the floppy disk drive, printer, and Ethernet drop cable.

The front of the unit has one boot button, labeled B Reset, a power-on switch, a green power-on indicator light, and three red lights (LEDs).

Processor Physical Specifications

Height	21.5 inches
Width	9.5 inches
Depth	12.5 inches
Weight(standard configuration)	50 lbs

Processor Memory

The 1186 workstation has a minimum of 1.6 Megabytes of processor memory, with additional increments of 512 Kilobytes available as options, yielding a total of 3,712 kilobytes of memory.

The standard workstation can accommodate the maximum memory configuration. The first 1,152 Kilobytes can be installed without additional printed circuit boards. A Memory Expansion Board is required to attain the maximum memory capability.

Processor Memory Specifications

Main memory cycle time,	
16-bit word	375 nanoseconds
Display memory cycle time,	
four 16-bit words	750 nanoseconds
Word size	16 bits

EQUIPMENT

Real memory address size	24 bits
Virtual memory address size	24 bits
Virtual memory page size	512 bytes

Rigid Disk

The basic 1186 workstation includes a 20 Megabyte (Mb) rigid disk drive, which is housed in the processor cabinet. The system can be ordered with a 40-Mb, or 80-Mb rigid disk when a larger capacity is needed.

The 20-Mb, 40-Mb, and 80-Mb rigid disks are each contained in one cabinet. The 80-Mb disks are full-height 5.25-inch Winchester disk drives.

Rigid Disk Specifications

Interface	ST412/ST506			
Transfer rate	5 Mbps			
Bytes per sector	512			
Unformatted size (Mb)	10	20	40	80
Formatted size (Mb)	7.8	15.7	31.4	62.8
Average access time (ms)	60	45	45	35
RPM	3600	3600	3600	3600

RS-232-C Serial Interface

The processor contains two RS-232-C interfaces. Asynchronous, byte-synchronous (IBM Bisync), and bit-synchronous (SDL/HDLC) transfers are supported. One interface is configured as a Data

Terminal Equipment (DTE) port, for use with common carrier communications. The second interface is configured as a DCE (Data Communications Equipment) port, suitable for connection to local printers. Software control is provided for communication options, including transfer rate, parity, and start/stop bit choices. To use the RS-232-C DTE port, you must have an RS-232-C communication cable to connect the modem.

RS-232-C Serial Interface Specifications

Transfer Types	Async	Byte Sync	Bit Sync
Transfer Rates (bps)	110-9600	300-9600	300-9600

Display

The display unit that comes with your 1186 workstation is available in a 15- or 19-inch, high resolution, monochrome screen. Its base tilts and swivels for viewing ease. A thumbwheel located on the right, behind the the display screen, controls intensity. The display unit includes a display signal cable, keyboard signal cable, and a power cord, all 10 feet long. These connect the display pedestal to the back of the processor unit.

Display Screen Specifications

Screen Size	15-inch	19-inch
Width	11 inches	15.2 inches
Height	8.7 inches	11.6 inches
Visible Area (pixels)	632x833	862x1152
Horizontal Scan Rate	28 KHz	37.28 KHz
Pixels per inch	80	80
Refresh Rate	38 Hz	38 Hz

Display Physical Specifications

Width	15 inches	19 inches
Height	14 inches	18 inches
Depth	15 inches	16 inches
Weight	30 lbs	38 lbs

Keyboard

The keyboard is a low profile, tactile feedback, QWERTY keyboard with an adjustable tilt capability. It can be raised or lowered using the adjustable tilt knobs on both sides of the keyboard.

A keyboard diagram appears on the following page. Your 1186 keyboard is compatible with the IBM PC keyboard. It has also been specifically designed to run Lisp.

Ten function keys at the top of the keyboard, labelled F1-F10, are used for normal keyboard applications and for booting the system. They are also used to duplicate the IBM PC's function keys if you are running PC Emulation software. (See chapter 7, Diagnostics for more information about these keys.)

1186 Keyboard

F1 2.101	F2 2.102	F3 2.103	F4 2.104	F5 2.105	F6 2.106	F7 2.107	F8 2.110	F9 2.111	F10 2.112
CENTER	BOLD	ITALIC	CASE	STRIKEOUT	UNDERLINE	SUPER SUB	LARGER SMALLER	MARGINS	LOOKS

TC STOP 1.1	2.27 DELETE 177
UNDO 2.4	AGAIN 2.10
FIND 2.1	COPY 12.71
SAME 12.71	MOVE 12.61
HELP 2.1	CONTROL 2.5

ESC	1 1	2 2	3 3	4 4	5 5	6 6	7 7	8 8	9 9	0 0	←	→	BACKSPACE
TAB	Q q	W w	E e	R r	T t	Y y	U u	I i	O o	P p	{ }	 	RETURN
LOCK	A a	S s	D d	F f	G g	H h	J j	K k	L l	.	~		
SHIFT	Z z	X x	C c	V v	B b	N n	M m	< ,	> ;	/ /			SHIFT
META 2.25											EXPAND 2.24		

+	- NUM 11	↑ SCROLL 12	↓ BREAK 13
PrSc DOT 1.13	HOME 2.16	↑ 8 2.16	↓ PgUP 2.15
NEWT 2.22	← 4 2.16	5 2.16	→ 6 2.16
	END 2.17	↓ 2 2.17	PgDN 2.20
	INS 2.21	1 2.21	

Keyboard Specifications

Adjustable tilt	5 degrees to 11 degrees
Main keyboard keys	56
Left function keys	10
Top function keys	10
Right function keys (numeric pad)	18
Keyboard interface	9600 bps async
Width	19 inches
Height	1.25 inches
Depth	7.5 inches
Weight	4 lbs

Mouse

The mouse is an electronic pointing device which provides X- and Y-positioning input to the 1186 workstation. The mouse guides a pointer on the screen as it is moved across the mouse pad. The pointer is generally represented by an arrow, but can take on different shapes depending upon the function being performed.

The mouse is used to select icons and menu items, to position the cursor for text input and editing, and to invoke commands.

Mouse Specifications

Width	2.25 inches
Height	1.25 inches
Depth	3.75 inches

Optional Equipment

The following optional components are available for your 1186 workstation:

- floppy disk drive
- Ethernet transceiver and controller
- Ethernet interface

Floppy Disk Drive

The floppy disk drive is an optional feature, except where the PC emulation capability is used. It is a 500 Kb, IBM-compatible, half-height floppy disk drive. It supports one 5.25-inch, double-sided, single/double density floppy disk at a time. It is housed in a separate cabinet, and is designed to fit on top of the processor, or it can be placed within four feet of the processor. An optional 10-foot cable set allows you to place the floppy disk drive on your desktop.

Floppy Disk Drive Specifications

Interface	SA400
Transfer rate	250 Kbps
Bytes per sector	512
Unformatted size	500 Kb
Formatted size	360 Kb
Average access time	93 ms
RPM	300
Width	9.5 inches
Height	2 inches
Depth	12.5 inches
Weight	6 lbs

Ethernet Transceiver and Controller

The Ethernet transceiver and controller are used to connect workstations to the Ethernet, a high-speed (10 million bits per second) communications link used by Xerox.

Ethernet Interface

The Ethernet interface supports both the Ethernet specification, Version 1.0, and the IEEE802.3 standard. The physical network hardware can be any standard coaxial cable that fully meets Ethernet's specification, or an RG58 cable Per IEEE 802.3 1985 (ISO DIS 88022/3). The drop cable connector can accept either the Ethernet version 1.0 or IEEE 802.3 drop cables. The transfer rate using this interface is 10 megabits per second.

Peripheral Equipment

The following peripheral equipment is required to configure your 1186 workstation.

Cables

A standard 1186 configuration uses the following five cables:

- workstation power cord
- display power cord
- display signal cable
- keyboard cable
- mouse cable

If your configuration includes an optional Ethernet interface, a drop cable for connection to the Ethernet is required. A workstation with an optional floppy disk drive requires a floppy disk drive power cord and signal cable.

Power Supply

The power supply that comes with your standard 1186 configuration supports all system configurations. Therefore, no upgrade is necessary if you wish to expand your workstation's capability. The power supply has a panel-mounted, two-position voltage selection switch. One position supports 100/115 VAC, and the other supports 220/240 VAC.

Power Supply Specifications

Power consumption				270 watts
Input power requirements				
	Range	Nominal	Frequency	
U.S. and Canada	98-127	115	60 ± 0.5	
Europe	194-264	220/240	50 ± 0.5	
Japan	90-100	100	60 ± 0.5	
Japan	90-100	100	50 ± 0.5	

[This page intentionally left blank]

Turning the 1186 On

The power switch is on the front of the processor unit near the top (just under "Xerox"). The switch is labeled with a 0 and a 1; 0 is off, 1 is on. Turn the 1186 on by pushing the power switch to the 1 position. The screen should flash and after a minute or two, the boot icons (on-screen representations of the ten function keys at the top of the keyboard) should appear. Also on the front of the processor is the boot button (labeled B Reset), a green "power on" light, and three red lights which are used for diagnostic purposes (see chapter 7, Diagnostics).

Note: Wait at least three minutes if you decide to turn the processor on after turning it off.

Booting the 1186

The installation and diagnostic software delivered with your Xerox 1186 is bound into a package called a boot file. (The Lisp Library packages and the Lisp Users packages, among others, are not bootable files. They must be explicitly loaded when you are running Interlisp-D). The process of loading a boot file into the 1186 is called booting. Boot files may be booted from either the rigid disk or a floppy disk. Normally, the rigid disk is configured so that powering up the processor resumes the last Interlisp-D session.

Booting the 1186 is performed at the keyboard by pressing one of the ten function keys labeled F1 through F10. Booting options are summarized below:

Key	Function
F1	Rigid disk boot/Lisp boot
F2	Floppy disk boot
F3	Ether boot
F4	Alternate Ether boot
F5	Diagnostic rigid disk boot
F6	Diagnostic floppy disk boot
F7	Diagnostic Ether boot
F8-F10	currently not used

Pressing the F1 key and then immediately pressing the zero key activates the alternate rigid disk boot/System Tools boot.

Booting Sequence for Interlisp-D

Cursor codes are displayed on the 1186 display screen. They are usually in the upper left corner of the screen, or they can replace the mouse pointer.

This section describes the current sequence of cursor codes for booting your workstation and loading Interlisp-D. The cursor code numbers are arranged in four quadrants of a square, with two characters on each side. The correct reading order is top left, top right, bottom left, and bottom right.

With the boot icons displayed on the screen, press the F1 key. The screen will turn black and the small white rectangle will be replaced by a four-digit number which will begin to count rapidly upwards.

If no errors are detected, the cursor code will start incrementing at a slower rate, beginning with 0. During this phase, Interlisp-D is being loaded into virtual memory. Once Interlisp-D is loaded, the cursor code changes to 1186. The display is activated almost immediately, and displays a collection of random dots. A few seconds elapse, and the Interlisp-D screen appears.

Turning the 1186 Off

1. Type (LOGOUT). In a few minutes the boot icons will appear on screen.
2. Put the power switch at the 0 position.

Note: Remember to wait at least three minutes before turning the processor on again.

Routine Maintenance

To keep your 1186 workstation in good working order, the following tasks should be performed on a monthly basis, or as specified.

Keyboard

Brush off the keyboard to keep dust from building up under the keys.

Mouse

Brush or wipe the dust from the surface of the mouse pad, since dust can interfere with the ball

bearings of the two-button mouse, and the lens of the three-button mouse.

Move the mouse in circles on the mouse pad and check the movement of the cursor on the display screen to make sure it is operating smoothly. If you see any hesitation in the movement of the cursor, the mouse should be cleaned by a Xerox technical representative.

Display Screen

Lightly wipe your display screen with a damp cloth. You may use a commercial window cleaner by spraying cleaner on the cloth before cleaning the screen.

CAUTION: Do not allow any liquid to drip down into the housing around the screen.

Floppy Disk Drive

Clean the floppy disk drive heads as needed. If the heads are not kept clean, deposits can accumulate that can cause scratching or erasure of data on the disks. Obtain a Xerox head cleaning kit from your technical representative, and follow the directions that come with the kit.

Floppy Disks

Store floppy disks away from magnets, dust, and heat. Do not bend them. Do not write on their labels with ball-point pens or pencils of any sort. Any of these actions can result in loss of data.

Troubleshooting

This section describes some of the more common problems that may occur when you are using your 1186 workstation.

Problem: The display is black, with no bouncing white rectangle.

1. Check the intensity wheel to see if it is turned all the way up. (The intensity thumbwheel is located just behind the display screen, on the right-hand side.)
2. Make sure the processor is plugged in.
3. Make sure the processor is turned on.

Problem: The cursor will not move.

1. Test the mouse's sensors by moving it in circles on the plastic pad.
2. Make sure the two-button mouse is on the special plastic pad or other non-slip surface. The three-button mouse must be on its special optical paper (grey-colored with small, hexagonal pattern.)
3. Make sure the thin cable is attached securely to the mouse and the keyboard.
4. Check the cursor code that is displayed on your display screen. If the code is a number other than 1186, write the code down and report it to your system administrator, or the Xerox service representative.

Reporting Problems

The Xerox AIS support team is committed to providing full support services to the entire Xerox AIS user community. Users are encouraged to report problems with the system, errors in the documentation, and their general observations. Messages may be sent to us in several ways.

At most Xerox 1100 sites, an experienced user is designated as the Xerox 1100 System Administrator. If the system administrator is not able to help you with your problem, he or she should be able to contact the Xerox AIS support team for you.

Users with access to the ARPANET are encouraged to send mail to our net address:

AISupport@XEROX

Users without ARPANET sponsorship should call (818) 351-2351 ext. 2222 collect or write to:

Xerox AIS Support
Xerox Special Information Systems
250 North Halstead Street
Pasadena, CA 91109

4. SOFTWARE INSTALLATION

This chapter describes the initial software installation and the 1186 rigid disk file system.

Installing Lisp on the 1186 Workstation

The procedures described in this section supplement the installation software's on-line script. If you run into a problem, refer to the section titled **Troubleshooting for Lisp Installation**.

Read the information before each procedure to find out what conditions should exist before you start (Prerequisites), when that procedure should be performed (Usage), things to watch out for (Warning), and what you should do before starting the procedure (Special Instructions.)

This is a step-by-step guide to installing the System Tools and Lisp on your local disk. For a comprehensive discussion of the System Tools please refer to chapter 5, System Tools.

Floppy Disks Needed

Installation Utility

System Files (There are five system files floppies numbered from one to five).

0) Factory Configuration (EEPROM) and Bad Page Checkout

This procedure is usually performed at the factory before you receive your workstation. If you detect a bad page problem, contact your Xerox representative.

1) Partitioning

Prerequisites:

- Assumes that proper EEPROM Configuration and Bad Page Checkout (Procedure 0) have been performed.
- Know the disk size you are working with (usually 40Mb). You will be prompted for this information.

Usage:

Perform this procedure only when the disk is new, or when you have experienced a catastrophic disk failure.

Warning:

Partitioning the disk DESTROYS all disk files. If the disk is not new, user files must be saved first.

Steps for Partitioning

- a. Turn the workstation on and insert the *Installation Utility* floppy disk.
 - b. Press the B Reset button on the front of the workstation
- Wait (up to five seconds) for the boot icons to appear on the screen.

- Press the F2 key (Floppy Boot).

The 4-digit cursor code will count 149, 199, 910, 920, 940, 990 then the Main Menu will appear.

Note: If, after the Main Menu appears, you are asked to set the time, please refer to Appendix A for time-setting instructions.

c. Type 1 (Lisp Installation).

- The Installer menu will appear.

d. Type 1, 2, 3, 4, 5, 6, or 7 depending on disk size (Partition xxMB disk...) and press <RETURN>.

You will then see the message:

WARNING - PARTITIONING A DISK DESTROYS ALL ITS CONTENTS

CONTINUE?(Y/N)

If the disk is new or files have been BACKED UP type Y, and press <RETURN>. After about 5 minutes, the installer menu will reappear. Go to Procedure 2, "Microcode and System Tool Installation."

2) Microcode and System Tool Installation

Prerequisites:

Assumes the disk is partitioned for Lisp.

Usage:

Can be safely repeated, but only needs to be done once after Partitioning.

Special Instructions:

If you have just finished partitioning (Procedure 1), go to step d.

Steps for Microcode and System Tool Installation

- a. Insert the *Installation Utility* floppy.
- b. Press the B Reset button on the front of the processor unit.
- Wait up to five seconds for the boot device icons to appear on the screen.
- Press the F2 key (Floppy Boot).

The 4-digit cursor code will count 149, 199, 910, 920, 940, 990, then the Main Menu will appear.

- c. Type **1** (Lisp Installation) and press **<RETURN>**.
- d. When the Installer menu appears, type **8** (Initialize Workstation System Tools volume) and press **<RETURN>**.
 - Wait for the prompt to appear. This can take up to two minutes.
 - Insert the "System Files" floppies as prompted. There are five System Files floppies. You will be prompted to insert the System Files floppies into the floppy disk drive by number, e.g., "Insert Floppy Disk labeled 'System Files #1' in the floppy disk drive." After you have inserted the correct floppy press **<RETURN>**.
- e. When the installation of the System Tools is complete, the Installer menu will reappear.
- f. When the menu reappears type **9** (Boot System Tools Volume) and press **<RETURN>**.

Note: You must have the System Files #5 floppy inserted in the floppy disk drive.

After you perform step f, the machine will illuminate, running Tajo.

Note: At the top of the screen you will see "User: {}! Invalid Password." Ignore this message.

An icon, labeled "Executive 12.0," will appear near the bottom of the screen. Move the cursor to the center top of this icon (a small region of the icon will invert) and press the right mouse button. The icon will expand into the Tajo executive window. Move the cursor into the executive window and press the left mouse button. This is where you type:

```
Floppy Read Init.cm;@Init.cm
```

and press <RETURN>.

The caret will turn into a small black blinking rectangle. A series of messages will be printed in the executive window informing you of the progress of the installation.

After the above command is executed, your 1186 will go into the base state, a bouncing white box with various messages regarding the uses of the System Tools.

You may remove the System Files #5 from the floppy disk drive now.

g. You must use the Profile Tool to set your user profile before continuing. See chapter 5, System Tools, page 58 for instructions.

h. Proceed to install the Lisp Sysout from Floppies (Procedure 3) or from the Network (Procedure 4).

3) Installing the Lisp Sysout from Floppies

Prerequisites:

Assumes the Initial Microcode and Lisp Microcode have been installed and the System Tools are running (Procedure 2, above).

Usage:

This procedure takes about 30 minutes.

Warning:

Destroys the Lisp Virtual Memory of last logout, but not the LispFiles.

Steps for Installing the Lisp Sysout from Floppies

You should be in the base state, with the bouncing white box on your screen.

a. Press the left mouse button to enter the window labeled Lisp System Tool.

● Wait about one minute for the Lisp System Tool window to appear.

b. One third of the way down the window on the line that begins with the **Document:** parameter, move the cursor over the **Floppy** choice. Press the left mouse button. **Floppy** should become highlighted.

c. Skip the next line and move the cursor over the **Volume Menu:** parameter and press the left mouse button. Type just the number 2, which will be added to the word Lisp. After you finish typing, the **Volume Menu:** parameter should look like:

Volume Menu: Lisp2.

d. Skip the next four lines. Complete information concerning their meaning and use is contained in chapter 7, System Tools.

e. On the seventh line put the cursor over the **Sysin!** command and press the left mouse button.

f. You will get the message, "creating VM file. . . Insert floppy labeled 'Lisp Sysout #1' Confirm to continue."

- The cursor will change to a mouse icon. Press the left button to continue or the right button to abort.

- When the contents of a floppy have been copied into the volume you have specified, you will be prompted to insert the next floppy.

- Continue inserting the Lisp.Sysout floppies as prompted. This will take about 30 minutes. (Obtain these floppies from your system administrator.).

g. When you have finished loading the sysout you will be asked if you want to boot the sysout. Press the right mouse button to abort the booting operation.

h. Proceed to the section titled **Continuing, From Servers and Floppies:**.

4) Installing a Lisp Sysout from the Network

Prerequisites:

Assumes the Initial Microcode and Lisp Microcode have been installed and the System Tools are running (Procedure 2, above).

Warning:

Destroys the Lisp Virtual Memory of last logout, but not the Lisp Files.

Steps for Installing a Lisp Sysout from the Network

You should be in the base state, with the bouncing white box on your screen. Press the left mouse button to invoke the window labeled Lisp System Tool.

From an NS Server:

- a. The system tool parameters begin about a third of the way down the window. Move the cursor over the **Device:** parameter entry **NS-FS** and press the left mouse button. **NS-FS** will become highlighted.
- b. Move the cursor to the next line which has **File:** as its first parameter. This is where you will enter the information the system tool needs to fetch your Lisp sysout. For an NS server, the entry you type would look similar to the following:

```
[Pele:]<Lisp>Koto>Basics> full.sysout
```

- c. Move the cursor over the **Volume Menu:** parameter and press the left mouse button. Type just the number 2 which will be added to the word Lisp. After you finish typing, the **Volume Menu:** parameter should look like:

Volume Menu: Lisp2

- d. Skip the next two lines. Complete information concerning their meaning and use is contained in chapter 7, System Tools.
- e. Move the cursor over the **User:** parameter and press the left mouse button. Type your name.

- f. Move the cursor over the **User Password:** parameter and press the left mouse button. Type your password.
- g. Move the cursor over the **Domain:** parameter and press the left mouse button. Type the name of your clearinghouse domain, e.g., Parc.
- h. Move the cursor over the **Organization:** parameter and press the left mouse button. Type the name of your clearinghouse organization, e.g., Xerox.
- i. To fetch and install your lisp sysout, move the cursor over the **Sysin!** command and press the left mouse button. The machine will load the sysout you pointed it at in step b above. The length of time it takes to fetch the sysout depends on how busy the file server is.

Skip past the next section, to the section titled **Continuing, From Servers and Floppies:**

From a PUP Server:

- a. The system tools commands begin about a third of the way down the window. Move the cursor over the **Device:** parameter entry **PUP-FS** and press the left mouse button. **PUP-FS** will become highlighted.
- b. Move the cursor to the next line which has **File:** as its first parameter. This is where you will enter the information the system tool needs to fetch your lisp sysout. For a PUP server, the entry you type would look similar to

```
[Eris]<Lisp>Koto>Basics> full.sysout.
```

- c. Move the cursor over the **Volume Menu:** parameter and press the left mouse button. Type just the number 2 which will be added to the word

Lisp. After you finish typing, the **Volume Menu:** parameter should look like:

Volume Menu: Lisp2.

d. Skip the next two lines. Complete information concerning their meaning and use is contained in chapter 5, System Tools.

e. Move the cursor over the **User:** parameter and press the left mouse button. Type your name.

f. Move the cursor over the **UserPassword:** parameter and press the left mouse button. Type your password.

g. To fetch and install your lisp sysout, move the cursor over the **Sysin!** command and press the left mouse button. The machine will load the sysout you pointed it at in step b above. The length of time it takes to fetch the sysout depends on how busy the file server is.

Continuing, From Servers and Floppies:

1. Move the cursor over the **Copy VMem!** command and press the left mouse button. A subwindow will appear called "CopyVMem."

2. Move the cursor over the **Source Volume:** parameter in the Copy VMem subwindow and press the left mouse button. Type Lisp2.

3. Move the cursor over the **Dest. Volume:** entry press the left mouse button and type Lisp.

4. Move the cursor over the **Start!** command and press the left mouse button. You will be asked to confirm the start command. Press the left mouse button to confirm and the right button to abort.

5. After the sysout has been copied and expanded, you will be asked if you want to boot the copied sysout. Press the right mouse button to abort.
6. Then select the **Quit!** command by pressing the left mouse button. When the Lisp System Tools window reappears, select **Boot!** by pressing the left mouse button.
7. When the boot icons appear on the screen, press the F1 key. This will boot the sysout you just copied. In one or two minutes, the Interlisp-D window environment will appear. Go to Procedure 6, Initializing Lisp.

5) Re-Installing a Lisp Sysout from the Rigid Disk

Prerequisites:

- Assumes Initial Microcode and Lisp Microcode were installed and the System Tools are running.
- Assumes there is an unused and unexpanded Lisp Sysout on the Lisp2 volume.
- Assumes the boot icons are displayed on the screen (if the icons are not displayed, press the B Reset button).

Steps for Re-Installing a Lisp Sysout from the Rigid Disk

- a. Do an alternate F1 boot by pressing the F1 key and immediately pressing the zero key.

Note: The zero key must be pressed while the 4-digit cursor code reads 149.

The 4-digit cursor code will count 149, 199, 910, 920, 940, 990 then a bouncing white box will appear. If the cursor code goes to a number higher than 990, the alternate F1 boot has failed. Press the B Reset button and try again.

- c. Press the left mouse button to enter Lisp System Tools.
- d. Move the cursor over the **Copy VMem!** command and press the left mouse button. A subwindow will appear called CopyVMem.
- e. Move the cursor over the **Source Volume:** parameter in the Copy VMem subwindow and press the left mouse button. Type Lisp 2. Move the cursor over the parameter **Dest. Volume:** and press the left mouse button. Type Lisp.
- f. Move the cursor over the **Start!** command and press the left mouse button. You will be asked to confirm the **Start:** command. Press the left mouse button to confirm and the right button to abort.
- g. After the sysout has been copied and expanded (System Tools automatically expands the sysout to fit into the Lisp volume), System Tools will ask you if you want to boot the copied sysout. Press the left mouse button to confirm the booting operation.
- h. When the boot icons appear on the screen, press the F1 key. This will boot the sysout you just copied. In one or two minutes you should see the Interlisp-D window environment appear.
- i. Go to Procedure 6, Initializing Lisp.

6) Initializing Lisp

Prerequisites:

Assumes Initial microcode was installed, and that Lisp (on Lisp volume) was successfully loaded from the network or floppies.

Special Instructions:

If you already have the Lisp window display on your screen, go to step c.

Steps for Initializing Lisp

a. Press the B Reset button on the front panel of the processor unit.

Wait for the boot device icons to appear.

b. Press the F1 key (Rigid Disk Boot)

The 4-digit cursor code will count 149, 199, 2000. .2600, 1186. . . in 1 - 2 minutes.

The InterLisp - D windows will appear on the screen.

c. Answer the next prompt by furnishing your init file designation. For example:

```
{taurus:aissouth}<softwaretest>pasa> init.lisp
```

An Init file contains information that configures Interlisp-D for your installation.

If, for example, you are not connected to a network with a file server, use the file INIT.NONET. To use Init.nonet put the Lisp Library floppy containing INIT.NONET (see Appendix C, Library Guide; **Lisp Library Packages Index**, for the number of the Library floppy with Init.nonet) into the floppy drive and type

```
{FLOPPY}INIT.NONET
```

in response to the prompt for an Init file. If you prefer not to specify an Init file, press carriage return.

7) Loading Interlisp-D Packages

Xerox supplies two sets of floppies containing Interlisp-D software modules: the Lisp Library, which contains software supported by Xerox; and Lisp Users, which contains user-written software not supported by Xerox.

Please consult Appendix C, Library Guide, before attempting to load a specific library package into your virtual memory. Appendix C lists those modules that require the loading of files from more than one floppy disk, provides the sequence of loading, and contains an index indicating which modules reside on which floppies.

Each module consists of one or more compiled files (indicated by the extension DCOM). There are also floppies containing fonts and the on-line documentation (HelpSys).

To load a module from these floppies into a running Interlisp-D environment, insert the floppy containing the module you need into the floppy disk drive, and use the LOAD function to read it into virtual memory.

For instance, to load the Grapher module, type

```
(LOAD '{FLOPPY}GRAPHER.DCOM)
```

to the Interlisp-D Executive. If you are loading many modules, you may find it convenient instead to first connect to the floppy device by typing

```
CONN {FLOPPY}
```

after which you could type simply

```
(LOAD 'GRAPHER.DCOM).
```

When a module such as Grapher is loaded, the system attempts to automatically load all the files on which the module depends that have not yet been loaded. If the required files are stored on a

floppy disk other than the one currently loaded in the floppy disk drive, the system will fail to find them.

Another solution, which most users with a file server or a large disk are likely to prefer, is to copy the contents of the floppies to a file server or disk. Then the system can load all the necessary files directly from the server or disk with no further intervention. You can either copy everything on the floppies or just the modules you need. For loading the contents of the floppies to a file server or local disk, the Library module CopyFiles is useful. Load COPYFILES.DCOM from the Library and then perform, for each floppy you wish to copy,

```
(COPYFILES '{FLOPPY}' '{host}<directory>'),
```

where {host}<directory> specifies a directory on a file server where you have set aside space for Library files, or is {DSK}<LISPPFILES> if you are copying the files to your machine's local disk.

If you only want to copy selected files from the floppies, you can copy them one at a time with the function COPYFILE, or more conveniently, use the Library module File Browser to browse each floppy and copy the files you want. See the Lisp Library documentation for the CopyFiles and File Browser modules for more details.

Note: the HelpSys file IRM.HASHFILE is an exception: it spans three floppies and must be copied in "huge" mode (see chapter 6, Input/Output).

8) Logging Out of Lisp

Steps for Logging Out of Lisp

If you want to turn off your processor you must logout of Lisp first.

- a. Type (LOGOUT) in the Interlisp-D Executive window.
- b. Wait for the boot icons to appear on the screen (about one to two minutes).
- c. Push the power button to zero.

Troubleshooting for Lisp Installation

Problem: When using Procedure 6, Initializing Lisp, the cursor code freezes at 199.

Solution: Be sure you have performed steps g and h of Procedure 2 in the correct order.

Problem: When doing an PUP Fetch, the cursor code freezes at 981.

Solution: See your system administrator. Your processor must be properly registered.

Steps for Microcode Only Installation

If you accidentally erase your Lispfiles volume, you must reinstall your microcode. This step tells you how to do so.

- a. Insert the *Installation Utility* floppy.
- b. Press the B Reset button on the front of the processor unit.
 - Wait up to five seconds for the boot device icons to appear on the screen.
 - Press the F2 key (Floppy Boot).

The 4-digit cursor code will count 149, 199, 910, 920, 940, 990, then the Main Menu will appear.

- c. Type the number for Lisp Installation and press <RETURN>.
- d. Type the number for Install Lisp Microcode Only and press <RETURN>. You will be prompted to insert "System Files Floppy #1." Insert the floppy and press <RETURN>.

Note: Prolog users must choose the menu option "Install Prolog Microcode" after installing the Lisp microcode.

[This page intentionally left blank.]

Rigid Disk File System

The 1186 rigid disk file system is designed to provide Interlisp-D users with a flexible mechanism for storing and accessing files. The 1186 file system supports such features as random access and version numbers on files. In addition, the 1186 rigid file system supports a hierarchical naming structure for files.

Disk Partitions

The rigid disk used with the 1186 may be partitioned into up to ten regions called *logical volumes*. Logical volumes are like directories on the disk device: they may be used to hold Interlisp virtual memories, or Interlisp files. You can partition the disk with the *Installation Utility* floppy. Because partitioning the rigid disk erases all its contents, you are advised to partition the disk appropriately before storing anything on it. Otherwise, you will have to move all files from the disk, repartition it, and then copy the files back to the disk.

Although an Interlisp virtual memory file can coexist on a logical volume with other files, it is generally advisable to give each virtual memory file a logical volume that it does not share with anything else. Otherwise, the resulting fragmentation adversely affects swapping performance. A logical volume intended to contain an Interlisp virtual memory should be between 8,000 disk pages (4 megabytes) and 64,000 pages (32 megabytes) long. The closer to 64,000 pages you can make your virtual memory volume the better, provided there is still enough space on the disk for any other volumes you might need.

Note that to store Interlisp files on a logical volume, you must create a Lisp directory on that volume (see below for instructions).

File System Utility Functions

So long as there is a logical volume with a Lisp directory on it (a Lisp directory is a place that Lisp can store files on the rigid disk) you can access the rigid disk device with {DSK}. If you do not have a logical volume with a Lisp directory on it, Interlisp emulates the {DSK} device by a core device. (A core device is a file device whose backing store is entirely within the Lisp virtual memory.)

However, this causes three problems. (1) The core device provides limited space; (2) when running GREET, Interlisp fails to find {DSK}Init.Lisp and has to prompt you for an init file; and (3) since the core device is contained in virtual memory, it (and the files stored on it) can last only as long as you keep your virtual memory image.

To create a Lisp directory on a logical volume, call

(CREATEDSKDIRECTORY VOLUMENAME) [Function]

CREATEDSKDIRECTORY affects only the specified volume. CREATEDSKDIRECTORY returns the name of the directory created. You should install an Interlisp directory only the first time the logical volume is used. After that, the system automatically recognizes and opens access to the logical volumes that have Interlisp directories on them.

Should you ever want to get rid of a Lisp directory (and all the files in it), call

(PURGEDSKDIRECTORY VOLUMENAME) [Function]

PURGEDSKDIRECTORY affects only the Lisp files on the specified volume. An alternative way to get rid

of a Lisp directory is to use the System Tool to Erase the entire logical volume.

To find out if a particular logical volume already has a Lisp directory on it, call

(LISPDIRECTORYP *VOLUMENAME*) [Function]

To find out what logical volumes you have on your local disk, call

(VOLUMES) [Function]

To find out the total size of a logical volume in disk pages, call

(VOLUMESIZE *VOLUMENAME*) [Function]

To find out the number of free pages left on a volume, call

(DISKFREEPAGES *VOLUMENAME*
RECOMPUTE) [Function]

And to find out which logical volume contains the virtual memory you are currently running in, call

(DISKPARTITION) [Function]

There is a display window that can keep track of the information provided by LISPDIRECTORYP, VOLUMES, VOLUMESIZE, and DISKFREEPAGES. The display window can be in one of three states: ON, OFF, or CLOSED. ON means the display window is updated whenever the file system state changes. (This continuous updating can slow down the file system significantly.) OFF means that the display window is open, but updated only when you left-button it with the mouse. CLOSED means that the display window is closed and never updated. The display mode is initially set to CLOSED. To change the state of the display, call

(DSKDISPLAY *NEWSTATE*) [Function]

DSKDISPLAY returns the old state of the file system display, and if *NEWSTATE* is one of the literals ON, OFF, or CLOSED, then the display state is changed to *NEWSTATE*. To control the position of the display window, call

(DSKDISPLAY *PLACE*) [Function]

Once the display window is open, you can update it or change its state by putting the mouse cursor in the window. with the mouse. Pressing the left button updates the window, and pressing the middle button brings up a menu that allows you to change the display state.

Finally, once an Interlisp directory has been installed on a logical volume, any program running in Lisp has access to the Lisp files on the volume. Access is provided through the usual device-independent file interface: CONN (to connect to any directory or subdirectory on the local disk), OPENSTREAM, CLOSEF, DELFILE, GETFILEINFO, SETFILEINFO, BIN, BOUT, LOAD, etc.

File Name Conventions

Each logical volume with a Lisp directory on it serves as a directory of the device {DSK}. Files are referred to as

{DSK}<LOGICALVOLUMENAME>*FileName*

Thus the file Init.Lisp on the volume LispFiles would be called {DSK}<LispFiles>Init.Lisp.

In addition, you can indicate subdirectories using the > character in file names to delimit subdirectory names. Subdirectories allow you to group files to a finer degree. Files with subdirectories are written

{DSK}<LOGICALVOLUMENAME>*SubDir1*>...>*SubDirN*>*FileName*

For example, suppose you had a file LRdesign.TEdit on the subdirectory ParserGenerator on the subdirectory Compiler on the directory (logical volume) LispFiles of the rigid disk device. Its name would be written as follows:

```
{DSK}<LispFiles>Compiler>ParserGenerator>LR  
Design.TEdit.
```

If you don't explicitly put a directory in the file name for {DSK}, the system will default to a directory in a simple way. If the file does not have a subdirectory and you omit the directory (logical volume name), the directory defaults to the first logical volume, after the volume that contains the running virtual memory, that has a Lisp directory.

Thus if your disk has the logical volumes Lisp, Tajo, and LispFiles, and the Lisp volume contains the running virtual memory, and only the LispFiles volume has a Lisp directory on it, then {DSK}Init.Lisp refers to the file {DSK}<LispFiles>Init.Lisp. All the utility functions presented above default logical volume names in a similar way. An example of a utility function that doesn't default directory names is CREATEDSKDIRECTORY. If you want to find out what the default Lisp directory is, call

```
(DIRECTORYNAME '{DSK})
```

This defaulting convention is necessitated by several parts of the Interlisp system that create scratch files on the device {DSK} without specifying a directory (logical volume).

Disk Scavenging

The Koto release provides a disk scavenging service to help you recover from the unlikely event of file system failure. There are two classes of file system failure: Lisp directory failure and lower-level, Pilot operating system failure. Scavenging for Lisp

directories is provided by SCAVENGEDSKDIRECTORY; scavenging for Pilot is provided by the System Tool.

Lisp directory failures show up as infinite looping or other aberrant behavior while the system is doing a directory search or enumeration. To repair the directory, return to the top level (the Interlisp-D Executive) and call

**(SCAVENGEDSKDIRECTORY
VOLUMENAME) [Function]**

This function deletes the old directory, then reconstructs it from the files on the given logical volume.

Pilot failures manifest themselves as "HARD DISK ERROR" breaks within Lisp. To fix such a failure, return to the top level, log out of Lisp and get into the System Tool. Invoke the **Scavenge!** command for the damaged logical volume. If the System Tool reports that there were no problems, proceed back to Lisp and call SCAVENGEDSKDIRECTORY as described above.

On the other hand, the System Tool may report problems. Each problem is described by a message in the format shown below:

[fileID] type = file type; problem description

The fileID is a pair of numbers separated by a comma. The file type is a single number. If it is in the range 10048 to 10077 inclusive, the damaged file belongs to the Lisp local file system. Any other file types may be safely ignored.

If the file is in the Lisp local file system, you should examine the problem description to determine your next course of action. There are five possible problems.

unreadable pages [first...last plus one)

1. This indicates a hardware problem. You should run the disk diagnostics and probably have the pages marked bad.

missing pages [first..last plus one)

2. Some of the file pages have not been allocated correctly. You will probably see this after getting VERIFY ERRORS in Lisp.

duplicate page found

3. Self-explanatory

orphan page found

4. The scavenger found an allocated disk page that it believes belongs to no allocated file.

unknown problem

5. This is a catch-all for cases not covered by the previous four.

Return to the top level (Interlisp-D Executive) and call **SCAVENGEDSKDIRECTORY** from Lisp unless case 1 or 2 reported that page 0 of a file was damaged. If the only problems were of class 3 or 4, you should be able to resume normal operation.

In cases 1, 2, and 5 we recommend that you copy the files from the local disk to floppies or a file server, then erase the volume using the System Tool's **Erase!** command. Do not attempt to access the damaged files in any way. The function **FILENAMEFROMID** will let you translate from Pilot file ID's into file names.

(FILENAMEFROMID *LOWHALF HIGHHALF*
VOLUMENAME) [Function]

This function take a Pilot file ID, as printed by the Scavenger and tries to find that file in the Lisp directory of the given volume, returning a string

with the file name if successful, NIL otherwise. Note that the Pilot scavenger prints file IDs in octal.

If you have any doubt about which logical volumes to scavenge, scavenge them all. The scavenger does not harm an intact volume.

5. SYSTEM TOOLS

Introduction

When the Xerox 1186 is in the base state (a bouncing white rectangle on a dark background), the Lisp System Tool, Profile Tool and On-line Diagnostics can be invoked and the Lisp Volume can be booted. Base state is entered by doing an alternate F1 0 boot (see chapter 4, Software Installation). If the bouncing white rectangle does not appear, make sure you have correctly loaded the software as described in the previous chapter.

Each of these tools displays its own window. Although not specifically labeled, each window is divided into the following regions, from the top of the window to the bottom, respectively:

- Herald name displays the version date and time
- Message subwindow displays any error messages
- Parameter subwindow specifies all data parameters
- Command subwindow contains all available commands
- File subwindow displays interactive messages

Parameter fields are selected with the left mouse button. Parameter menus are available in some cases, and they can be selected by pressing either both mouse buttons on a two-button mouse, or

using the middle mouse button on a three-button mouse. Hereafter, parameter selection will be referred to as being available through the middle mouse button. The DELETE key can be used to delete a selection.

The mouse button or the NEXT key can be used to advance to the next field in the window. Using the NEXT key to advance the cursor will delete whatever is already printed in that parameter field. However, no harm will result if you accidentally erase one of these filled-in fields.

Users unfamiliar with mouse and window manipulations are strongly encouraged to read the on-line help command from the Diagnostics tool which provides in-depth details on their usage.

The Profile Tool

The Profile Tool enables you to set a number of parameters that are used by the Lisp System Tool for installing Interlisp-D sysouts. For example, if the path name to your sysouts is always the same, you may enter that name into the Profile Tool. Entering the path name into the Profile Tool changes the default value of the File: parameter in the Lisp System Tool.

Thus, every time you open the Lisp System Tool to fetch a sysout, the File: parameter will be filled in. You can change the default values in the Lisp System Tool window.

Summary:

- To activate the tool from the base state, press the middle mouse button.
- Select the parameters you wish to set or change.
- Select the **Set Profile!** command.
- Confirm by pressing the left mouse button when the small mouse icon appears. Click the right mouse button to abort the command.
- Select **Quit!**.

EPIC: AI-BU: Profile Tool of 3-Feb-86 10:12

User: YourName User Password: ***** Domain: xsis
Organization: Xerox Device: {~~PUP-FG~~, NS-FS, Floppy, Local Disk}
Volume Menu: Current Password: New Password:
MS File-Pathname: (Local;Domain;Organization)Directory/SubDirectory/FileName.sysout
Pup File-Pathname: [Host]<Directory>SubDirectory>FileName.sysout
Floppy File Name: Lisp.sysout
Default Lisp Volume: Lisp Boot Volume For STOP Key: Lisp
CopyVM From Volume: Lisp2 CopyVM To Volume: Lisp

Set Profile! Change Password! Quit!

Profile Tool Window

Parameter Items

The Profile Tool has the following parameter items:

User/User Password:

Your NS/PUP user and password names used to Login to the remote file server. (For PUP users, the name should be followed by a registry, like YourName.pa) It is not necessary to supply the password in the Profile Tool. It can be entered in the System Tool Window. If a password is supplied, it is stored on the disk in an unencrypted form.

Domain/Organization:

Your domain and organization name. If you do not use an NS file server, these parameters are irrelevant and should be left blank.

Device:

Selects the type of device on which the Lisp sysout file is stored. The choices are PUP-FS, NS-FS, Floppy and Local Disk.

Volume Menu:

Volume name for changing the volume password. Also used to select a particular volume for operations.

Current Password:

Current volume password string, initially set to the volume name. Once the current password string is changed, the volume is password-protected. Subsequent access to the volume will require the password to be typed from the Lisp System Tool window.

New Password:

New volume password string, consisting of at least five characters.

NS File-Pathname:

Complete file pathname of the Lisp sysout file to be retrieved from an NS file server (see the next section, The Lisp System Tool, for examples of pathnames).

PUP File-Pathname:

Complete file pathname of the Lisp sysout file to be retrieved from a PUP file server (see the next section, The Lisp System Tool, for examples of pathnames).

Floppy File Name:

The file name on the floppy diskette from which the Lisp sysout file is to be loaded.

Default Lisp Volume:

Sets the default volume for the Lisp System Tool to operate on.

Boot Volume for Stop Key:

The name of the volume that boots with a STOP key or F1 boot.

Copy VM from Volume:

The name of the logical volume (e.g., Lisp2) that will be the source of the virtual memory to be copied.

Copy VM to Volume:

The name of the logical volume to which the virtual memory will be copied.

Command Items

Set Profile!

Writes the parameter information entered in the Profile Tool window to the Lisp System Tool.

Change Password!

Changes the password for the logical volume named in the **Volume Menu:** parameter. For the

change to take effect both the **Current Password:** and **New Password:** parameter items must be completed.

Note: F1 and STOP key boots will not work on a protected volume. To reset the password protection, change the volume password back to the volume name. Since a password must consist of at least five characters, you will not be able to reset the password for volumes with short names (like Lisp).

Quit!

Closes the Profile Tool window. Unless you have selected either the **Set Profile!** or the **Change Password!** command items, no changes will be made to the parameter items of the Lisp System Tool.

The Lisp System Tool

Summary:

- To activate the tool from the base state, press the left mouse button.
- Select the parameters you wish to set or change.
- Select the appropriate command.
- Confirm by pressing the left mouse button when the small mouse icon appears. Press the right mouse button to abort the command.

Lisp System Tool Window

Document: (██████), ErrorMsg) Device: {PUP-FS, ██████, Floppy, Local Disk} □

File: [Taurus:AISSouth]<Lisp>Koto>Basics>Lisp.sysout

Volume Name: Lisp

Volume Size = 16288

Free Pages = 10

Volume Password:

Max. Vmem Size = 7981

Vmem Size = 6358

Volume Boot File: [Taurus:AISSouth]<Lisp>Koto>Basics>Lisp.sysout (24-Jan-86 10:08:53 PST)

User: YourName

User Password: ****

Domain: xsis

Organization: Xerox

System!

Erase!

Set Max Vmem!

Make Script!

System & Boot!

Remote List!

Copy Vmem!

Scavenge!

Floppy!

Boot!

Help!

Quit!

Fetch Lisp Microcode!

Parameter Items

The Lisp System Tool has the following parameter items:

Document:

Used in conjunction with the **Help!** command. Select the **General** document to display on-line documentation for the Lisp System Tool. Select the **ErrorMsg** document to display the meanings of the error messages you may encounter from commands in the file subwindow. The file subwindow may be scrolled by positioning the mouse pointer on the left side of the subwindow and pressing the left or right mouse buttons to scroll up or down, respectively.

Device:

Device from which to install the Lisp sysout. This parameter also determines which of the default pathnames set in the Profile Tool will be used. For example, if **PUP-FS** is chosen, then the file specified under **PUP File-Pathname:** in the Profile window is selected.

File:

The file pathname of the Lisp sysout file to be retrieved from the selected device. The syntax of the file pathname depends on the particular file system on your host machine. Note that Host names are never enclosed in the curly brackets generally used in Lisp.

On a Xerox PUP file server, the file pathname looks like

```
[Host]<Directory>SubDirectory>FileName.  
                                ext!version
```

A typical example would be

```
[Rosebowl%]<Lisp>Fugue>Lisp.sysout
```

On a Xerox product (NS) file server, the file pathname looks like

(Host:Domain:Organization)Directory/
SubDirectory/FileName.ext!version

A typical example would be

(Phylex:XSYS North:Xerox)Demo/Demo.sysout

An equivalent but shorter way would be (Phylex:)<Demo>Demo.sysout if the **Domain:** and **Organization:** parameters are set appropriately

On a Unix file server the file pathname looks like [host]</directory/subdirectory/>filename.ext

A typical example would be

[safe]</a/lisp/fugue4/>lisp.sysout

On a VAX-VMS file server the file pathname looks like

[Host]<Directory.SubDirectory>
FileName.ext;version

A typical example would be

[Taos]<DEIProd.Prior>Lisp.sys

On a DEC-2060 TOPS-20 file server, the file pathname looks like

[Host]<Directory.SubDirectory>
FileName.Sys.version

A typical example would be

[Sumex-2060]<Dolphin.Fugue6.BetaTest>
Lisp.sysout

Note: If a version is not specified, the highest version will be fetched.

Volume Menu:

Contains the menu of all the volume names when your disk is partitioned. Use the middle button to display the menu, then select the desired volume name. The volume name displayed here will be the

object of all commands aimed at a specific logical volume, e.g., **Erase!**.

Volume Size:

Shows the size, in pages, of the logical volume named by the **Volume Menu:** parameter.

Free Pages:

Shows the available free pages on the logical volume named by the **Volume Menu:** parameter.

Volume Password:

The password string for the logical volume named by the **Volume Menu:** parameter. A string of asterisks rather than the actual password is displayed.

Max VMem Size:

Shows the maximum size of Interlisp's virtual memory on the logical volume named by the **Volume Menu:** parameter.

VMem Size:

Shows the actual size in pages of the Lisp virtual memory on the logical volume named by the **Volume Menu:** parameter. This number should be the same as returned by the function **VMEMSIZE** just prior to logging out of Interlisp.

Volume Boot File:

Shows leader page note for the volume boot file, indicating the origin of the boot file. The Lisp System Tool and Installation Utility fills this in automatically.

User/User Password:

Your **NS/PUP** user and password names associated with **Login** to remote file server. (For **PUP** uses the name should be followed by a registry, for example, **YourName.pa**)

Domain/Organization:

Your clearinghouse domain and organization. If you do not use an NS file server, these parameters are irrelevant and should be left blank.

Command Items

Sysin!

Installs the file named in the **File:** parameter from the selected **Device:** into the logical volume named in **Volume Menu:**. If the operation is successful, the VMem file will be automatically expanded (to your volume size) for you. If you want a different VMem size, you may use the **Set Max VMem!** command to alter it. This command can be aborted with the STOP key.

Erase!

Erases the contents of the logical volume specified by the **Volume Menu:** parameter.

Set Max VMem!

Alters Interlisp's virtual memory file size on the logical volume named by the parameter **Volume Menu:**. Your VMem file is automatically created for you during the **Sysin!** operation. The local file system attempts to allocate contiguous space when the file is first created. There are continuing performance penalties for accessing a fragmented file, which may result from growing the file one or more times.

Make Script!

This command allows you to set up your own customized disk partitioning. **Make Script!** brings up a new window which allows you to enter the volume names and sizes. Up to nine volumes may be specified (one volume is reserved for System Tools). To enter your partition, first select the disk type that corresponds to your disk type. Your disk type should be one of 10, 20, 40, or 80 megabytes.

The **Free Pages**: parameter will be automatically updated when the next volume name is entered.

When partitioning a disk, it is imperative to use all the disk pages available. If this is not done and then later the disk is damaged, the physical volume may be unscavengeable. For this reason, the tool assigns all unallocated disk pages to the last logical volume.

When you are finished with the volume specification, select the **Make Script!** command (in the **Make Script!** subwindow, *not* the **Lisp System Tools** window) and you will be prompted to insert the *Installation Utility* floppy. At the end of the operation you will have added an entry to the **Installer** menu that appears when you boot the *Installation Utility* floppy. In order to actually repartition the rigid disk, you must do an F2 boot of the *Installation Utility* floppy and select the "USER SPECIFIED PARTITION" option in the **Installer** menu (See chapter 4, Software Installation; Partitioning).

Sysin & Boot!

Performs the **Sysin** function and if no errors occur, boots the system.

Remote List!

Enumerates all the file names on the specified file pathname that matches the wild card. Wild card characters are * which matches zero or more characters, and # which matches exactly one character.

Copy VMem!

Copies the Lisp virtual memory from one logical volume (Source) to another logical volume (Destination). This command does not copy the entire contents of the logical volume, but only the number of pages specified by the **VMemSize**: parameter of the source volume. The **Copy VMem!**

command brings up its own window, explained below.

Source Volume:

Enter the name of the logical volume that is the source of the VMEM you want to copy.

Dest. Volume:

Enter the name of the logical volume to which you are copying the VMEM.

Source Volume Password:

Dest. Volume Password:

If either the source or the destination volumes are password-protected, the appropriate passwords must be entered in these parameter fields.

Start!

Starts copying the virtual memory. After selecting **Start!** a mouse icon will appear. Press the left mouse button to confirm the copy operation and the right button to abort the command. When the virtual memory has been copied, you can respond affirmatively to the confirmation message and boot the Destination volume, or you can cancel the boot and **Quit!**

Quit!

Removes the Copy VMem window.

Scavenge!

Scavenge performs a logical volume-scavenge on the volume named in the parameter item **Volume Menu:**. This command should be used whenever you suspect the integrity of your disk volume. This command is part of the local file system's error recovery process. For complete details see the disk scavenging section in chapter 4, Software

Installation. The file subwindow message will look like:

Volume = Lispn
Scavenging...done
Volume repaired, log file complete
N files on volume
No problems found

Floppy!

Floppy disk utility. Brings up a subwindow with several options.

Pattern:

The search pattern for files stored on the floppy. See **List!**, below.

Floppy Name:

The name you gave the floppy when it was formatted.

Info!

Displays floppy name, single or double density, single or double sided, number of free pages and largest free block. Automatically fills in the **Floppy Name:** field.

List!

Lists files as called for in **Pattern:** field. The wildcards * and # are allowed.

Format!

Formats the Floppy, giving it the name specified in the **Floppy Name:** field.

Duplicate!

Duplicates a floppy. This command will only work if there is a rigid disk volume available with at least 700 free pages.

Quit!

Removes the Floppy Tool window.

Boot!

Boots the volume specified by the **Volume Menu:** parameter. Press the F1 key when the boot icons appear.

Help!

Prints on-line help and error messages.

Quit!

Deactivates all windows and returns to the bouncing rectangle.

Fetch Lisp Microcode!

Fetches microcode from the file specified by the **File:** parameter and installs it on the logical volume named by the **Volume Menu:** parameter.

DiskType: {18Mb, 29Mb, 42Mb, <input type="checkbox"/>	
Drive Size: 65274	Free Pages: 61674
Volume 1: SystemTools	Volume 1 Size: 3600
Volume 2:	Volume 2 Size: 0
Volume 3:	Volume 3 Size: 0
Volume 4:	Volume 4 Size: 0
Volume 5:	Volume 5 Size: 0
Volume 6:	Volume 6 Size: 0
Volume 7:	Volume 7 Size: 0
Volume 8:	Volume 8 Size: 0
Volume 9:	Volume 9 Size: 0
Volume 10:	Volume 10 Size: 0
Make Script!	Quit!

Source Volume: Lisp2		Dest. Volume: Lisp	
Source Volume Password:		Dest. Volume Password:	
Start!			
Quit!			
Pattern:			
Floppy Name:			
Info!	List!	Format!	Duplicate!
Quit!			

Make Script, Copy VMem and Floppy Subwindows

The On-Line Diagnostics Tool

The programs for these on-line diagnostics tests are stored on the System Tools Volume, and are accessible from the bouncing white rectangle. These tests are for the Display, Keyboard, Echo Test (Ethernet), RS232 Loopback, Floppy Drive and Ethernet Statistics.

All of the tests are documented on-line, and can be accessed by selecting the the **Help!** command.

Summary:

- To activate from the base state, press the right mouse button or the space bar.
- Select the test to be executed.
- Select the parameter(s) for the test.
- Select the **Start!** command.
- Select **Help!** for documentation.

Details:

To read all of the documentation, you may find it convenient to adjust the height of the File subwindow before you select **Help!**. To do this, position the cursor over the small box at the right of the line that divides the file subwindow from the other subwindows. Press the left mouse button down, and while still holding it down, move the cursor up or down to adjust the boundary line.

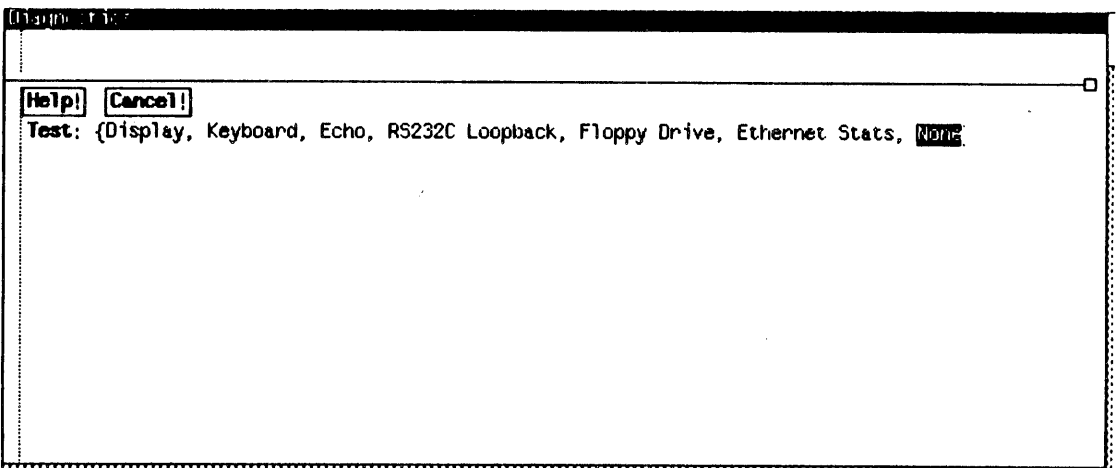

Diagnostics Window

Parameter Items

Types of tests available:

Display, Keyboard, Echo, RS232
Loopback, Floppy Drive, Ethernet Stats

For details, please see the on-line documentation before starting these tests.

Command Items

Help!

Used with parameter "None", displays the complete documentation on how to use the Diagnostics window, including the Window Manager. Used with one of the test parameters, displays the complete documentation for that test.

Start!

Start the selected test. Note that the Start! command only appears after you have selected one of the tests.

Cancel!

Closes the Diagnostics window and returns to the bouncing white rectangle.

Input/output on the Xerox 1186 is supported in many ways: by keyboard, display, mouse, rigid disk, Ethernet, floppy disk, and RS232 communications. This chapter only covers aspects of the last two: the floppy disk and RS232 communications.

Floppy Disk Support

This section describes Interlisp-D's file device {Floppy}, which is used to interact with floppy drives on Xerox 1186 machines.

Use a 5½ inch double-sided, double-density, soft sectored floppy disk. Insert the floppy into the floppy drive face up, the edge of the floppy with two 1½ inch-long cover holes (one hole per side) going in first. The write-protect notch will be on the left edge as you look down on the floppy from above. You write protect a floppy by covering the write-protect notch with the tabs provided with the floppies.

In general, Interlisp-D can be used to read, write, and otherwise interact with files on Pilot-formatted floppy disks through standard Interlisp input/output functions. All familiar operations such as LOAD, OPENFILE, READ, PRINT, BIN, BOUT, GETFILEINFO, SETFILEINFO, GETFILEPTR, SETFILEPTR, etc., work with floppies. COPYFILE is commonly used to archive and unarchive files between floppies and other file devices. Files on floppies can

be compiled, edited, and hard-copied just as files may be on all other ordinary file devices.

Naming, Erasing, and Formatting Floppies

To erase and establish track information on a floppy, especially a floppy that is brand-new, call

(FLOPPY.FORMAT *NAME* *AUTOCONFIRMFLG*
SLOWFLG) [Function]

The *NAME* argument becomes the name of your floppy. It can be any string or atom of 106 or fewer characters. It's a good idea to label the outside of your floppy with the same name using a sticky label and a soft marker.

AUTOCONFIRMFLG controls questioning you about destroying the contents of a floppy that appears to contain valid information. If *AUTOCONFIRMFLG* is T, you will not be asked to confirm.

SLOWFLG determines how thorough a formatting job is to be done on the floppy you format. If *SLOWFLG* is T, FLOPPY.FORMAT completely erases your floppy, setting down track information and critical Pilot records on it. When *SLOWFLG* is left NIL, only the Pilot records needed to give your floppy an empty directory are written. Use *SLOWFLG* = T with a brand-new floppy.

Typically you will leave *AUTOCONFIRMFLG* and *SLOWFLG* as NIL. For example, doing (FLOPPY.FORMAT "My Floppy") will create a blank floppy named "My Floppy."

To reset the name put onto a floppy by FLOPPY.FORMAT, use

(FLOPPY.NAME *NAME*) [Function]

If *NAME* is NIL, then FLOPPY.NAME reads the name put onto a floppy by FLOPPY.FORMAT or FLOPPY.NAME.

Copying Floppies

The ability to copy Pilot floppies is supported through two functions:

(FLOPPY.TO.FILE *TOFILE*) [Function]

(FLOPPY.FROM.FILE *FROMFILE*) [Function]

FLOPPY.TO.FILE copies the contents of the current floppy to a file, and FLOPPY.FROM.FILE is FLOPPY.TO.FILE's inverse. For instance, to copy the contents of one floppy onto another, insert the floppy to be copied into the floppy drive. Then type (FLOPPY.TO.FILE 'ToFile). Remove the first floppy and insert a blank floppy. Type (FLOPPY.FROM.FILE 'FromFile). The first floppy has now been copied.

The *TOFILE* produced by FLOPPY.TO.FILE is approximately 700 pages long and can be placed on a file server or a logical volume of your machine. FLOPPY.FROM.FILE can be used more than once if you would like to make more than one copy. As an alternative to using FLOPPY.SCAVENGE (described below), the *TOFILE* produced by FLOPPY.TO.FILE can be usefully edited to salvage the contents of a floppy that has been damaged.

Loading Sysouts and Other Large Files Onto Floppies

Sysouts may be created on floppies through Interlisp's SYSOUT or MAKESYS functions, then later installed on the same or another Xerox 1186 using the *Installation Utility*. Sysouts may also be taken from other file devices and put onto floppies through the use of the function FLOPPY.MODE (see

below). To copy a sysout to floppies, simply do one of the following functions:

(SYSOUT '{FLOPPY}) [Function]

(MAKESYS '{FLOPPY}) [Function]

You are prompted to insert new floppies as they are needed. It generally takes at least ten floppies to store a sysout. To load in a sysout from floppies, you can use the Lisp System Tool.

The normal mode of operation for {FLOPPY} is

(FLOPPY.MODE 'PILOT) [Function]

Two special modes of operation for floppies, SYSOUT, and HUGEPILOT are also available. You can put floppies into either of the two modes to copy sysouts or huge files from file servers to floppies or from floppies to file servers.

In SYSOUT mode, you may use COPYFILE to move a sysout off another file device onto floppies. To do this, you must first set the floppies to SYSOUT mode, then do the COPYFILE. For example,

(FLOPPY.MODE 'SYSOUT)

(COPYFILE '{FileServer}<Directory>LISP.SYSOUT '{FLOPPY})

will put the current Interlisp-D LISP.SYSOUT onto floppies. While in SYSOUT mode, you can copy as many sysouts as you like onto floppies. The *Installation Utility* is then used to load these sysouts onto a Xerox 1186. Similarly, sysouts can be copied from floppies onto another file device using COPYFILE when in SYSOUT mode. For example,

(FLOPPY.MODE 'SYSOUT)

```
(COPYFILE '{FLOPPY}' {YourFileServer} <YourDirectory> Your.Sysout)
```

will copy the sysout onto your directory on a file server. To get back to ordinary floppy operation, type (FLOPPY.MODE 'PILOT).

You can write and read huge Pilot files (like IRM.hashfile) from multiple floppies to, for example, your rigid disk in HUGEPILOT mode, which can be set by typing

```
(FLOPPY.MODE 'HUGEPILOT).
```

```
(COPYFILE '{FLOPPY}FileName' '{DSK}FileName
```

This mode is practically identical to SYSOUT mode, with the exception that you have control over the names of files and floppies.

Measuring Unused Floppy Space

The following function tells you how much space is left on a floppy.

```
(FLOPPY.FREE.PAGES) [Function]
```

returns the number of free pages on the current floppy. Pilot floppy files are contiguously represented on a floppy disk. If you are using your floppy interactively (not just doing a simple series of COPYFILE commands after a FLOPPY.FORMAT), don't fill your floppy to capacity. Try to keep such a floppy less than 75 percent full.

Testing Whether a Floppy is in the Drive

Two functions are available for testing whether a floppy is in the floppy drive.

```
(FLOPPY.CAN.READP) [Function]
```

tests if there is a floppy in the floppy drive. FLOPPY.CAN.READP does not provide any protection against not fully closing the floppy drive door.

(FLOPPY.CAN.WRITEP) [Function]

tests if there is a floppy in the floppy drive and the floppy drive can write on this floppy. (The floppy drive can only write on floppies whose write-protect notches are not covered with tape.)

Note: The 1186 can not tell if the floppy drive door has been opened.

Scavenging Floppies

(FLOPPY.SCAVENGE) [Function]

attempts to repair a floppy whose critical records have become confused. Also, if you accidentally delete floppy files, FLOPPY.SCAVENGE retrieves them (provided you don't wait till after they have been overwritten by new files).

RS232 Support

There are two standard ports on the Xerox 1186 for RS232 communications: the TTY Port, and the RS232C Port.

The RS232 port (DTE) is configured for standard RS232 communications, while the TTY port (DCE) is configured for use with local printers. The ports' transfer rate, parity, start/stop bit and flow control choices are software-controllable to provide a wide range of interface capabilities.

Cable Configurations for the RS232C and TTY Ports

There are several cable configurations for use with the RS232 and TTY ports. Since the 1186 has female connectors for both ports, all cables must terminate with the corresponding male connector (25-pin DB-25) on the 1186 side.

There are four configurations most often used;

- RS232 to modem
- RS232 to printer
- TTY port to printer
- modem eliminator (which allows two 1186 machines to communicate via the RS232 or TTY ports)

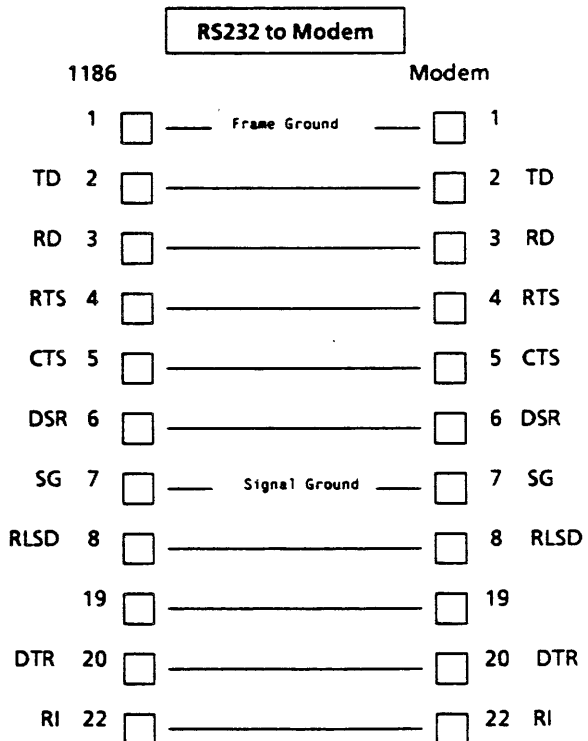

The next two configurations are used for connecting your workstation to printers.

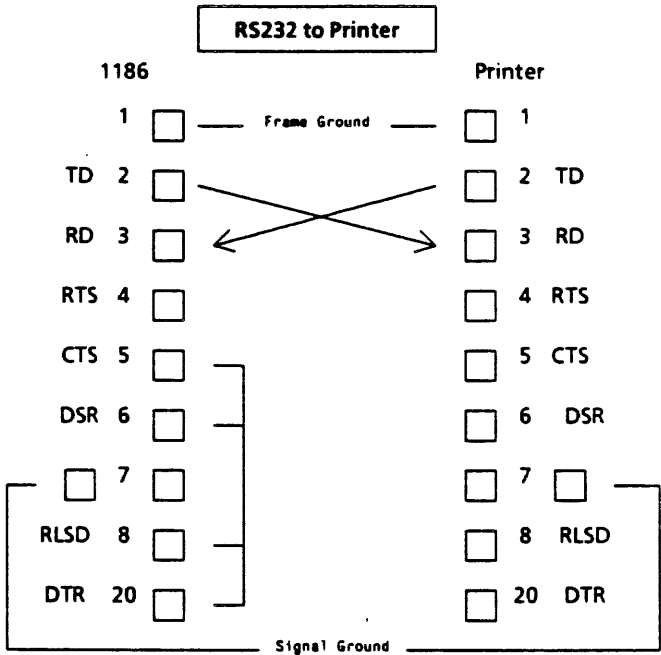

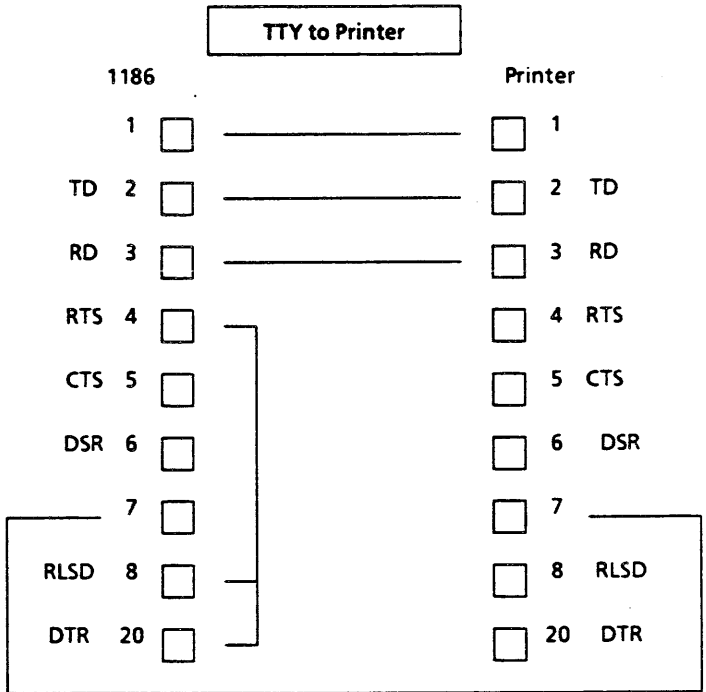

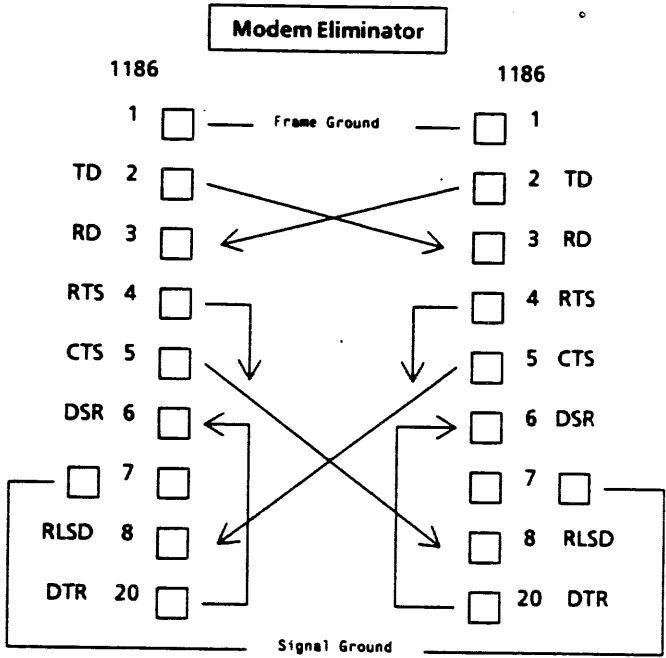

Diagnostics are performed when you are rebooting or restarting the workstation. They are software programs that are used to indicate how well the hardware is operating. This chapter describes the types of diagnostics that are run when you boot the 1186. A summary of the cursor codes used to indicate progress and error conditions is also included.

Boot Options for Running Diagnostics

There are two options for booting the 1186; Normal and Diagnostic Boot. These are described below.

Preboot Diagnostics

Normal booting causes the workstation to run a short diagnostic test, called Preboot Diagnostics, to check for machine problems. Preboot Diagnostics are automatically executed whenever you turn the workstation on, or when you press the boot button (B Reset).

- If Preboot Diagnostics fail, the boot icons do not appear on the display screen.
- If Preboot Diagnostics succeed, the boot icons appear and normal booting can begin.

Three small red lights below the small green light on the workstation front panel indicate the operation of Preboot Diagnostics, which takes

approximately five seconds to complete. All three red lights are lit during the first phase of Preboot Diagnostics. Then seven additional tests are run, each showing different combinations of lights.

The red lights go off if Preboot Diagnostics succeed, but remain lit if a failure occurs. The system also produces a beeping sound if it detects a failure.

If the boot icons do not appear within 10 seconds, if one or more red lights remain lit, or if a beeping sound is heard, a failure that prevents the system from booting has occurred. Note the pattern of lights (on-off-on, on-on-off, and so forth) and contact your technical support representative.

After the Preboot Diagnostics finish, you can boot your workstation by pressing one of the function keys represented by the boot icons on the display. During booting, cursor codes are displayed on the screen instead of the normal mouse cursor. The cursor codes are displayed in a small box that is usually in the upper left corner of the display. If a boot-time error is detected, the cursor code will stop counting, and display the combination of numbers that indicate the error type. Refer to the list of cursor codes at the end of this chapter for an explanation, or contact your system administrator.

Boot Diagnostics

A diagnostic boot provides a more specific and extensive diagnostic test. Boot Diagnostics should be run when:

- The workstation is initially installed, or moved to another location.
- Any component of the workstation is exchanged or replaced.
- A problem is suspected.

Running Boot Diagnostics

After resetting the machine by pressing the B Reset button, six function key/boot icons appear on the screen; three of these are special diagnostic boot icons which can be used to select the device from which the diagnostic program will be obtained. To run diagnostics from:

- Rigid Disk – press the F5 Function key.
- Floppy Disk – load the floppy disk labeled "Boot Diagnostics" into the floppy disk drive, and press the F6 function key/boot icon.
- Network – press the F7 function key.

If the device does not have the diagnostic program available, the function key for that device will not do anything.

Options for Boot Diagnostics

There are short and long versions of Boot Diagnostics.

- Short diagnostics run from 2 to 5 minutes, and perform routine checks.
- Long diagnostics run from 15 to 20 minutes. This option runs more thorough tests, and is used when problems are suspected.

Running the Short Option of Boot Diagnostics:

To run the short version of Boot Diagnostics:

1. Press the B Reset button on the front panel of the workstation.

2. Press the function key (F5, F6 or F7) corresponding to the test you wish to run.

Running the Long Option of Boot Diagnostics:

To run the long version of Boot Diagnostics:

1. Press the B Reset button on the front panel of the workstation.
2. Press the function key (F5, F6 or F7) corresponding to the test you wish to run, twice in rapid succession.

Behavior While Running Boot Diagnostics

The cursor codes for Boot Diagnostics always contain one or more letters, ranging from A to F. Letters are unique to Boot Diagnostic cursor codes.

While Boot Diagnostics are running, the display is normally black. However, during memory test, the screen displays a variety of special patterns.

Each test has an identifier that contains at least one letter. If test Ax (x can be any number) completes successfully, it goes to test Bx, then Cx, and so forth.

If a test fails, the Boot Diagnostics terminate and no additional test are run.

Results of Boot Diagnostics

Errors Detected When a hardware problem is detected, the cursor codes alternate continuously between two numbers. The first number is the "test code" and contains one or more letters, from A to F. The second number is the "error code." Record the numbers exactly as they appear.

Press the R key on the keyboard. This causes a third test result to appear (and may contain digits 0-9, or

letters A–F.) This result should also be written down and reported to your technical service representative.

Successful Completion Successful completion of Boot Diagnostics is indicated by the appearance of the boot icons. Normal system booting can then be performed.

Cursor Codes

There are two types of cursor codes: progress codes and error codes. Progress codes are displayed incrementally at various stages of initialization. Error codes freeze or blink the error number on your screen.

All cursor codes less than 9000 are generated by non-Lisp programs that have been implemented directly in microcode, or in Mesa, a high-level programming language used by Xerox. Cursor codes from 9000 to 9999 are generated by an error in the Lisp system code. Only those cursor codes likely to occur during operation of a work station running Lisp are identified in this document.

Currently, whenever an Interlisp-D system error occurs, the cursor will be replaced by the appropriate error code. If this happens when the cursor is located in a dark area of the screen, such as the prompt window, the cursor code will not be visible. Therefore, if you are encountering repeatable errors that freeze your system, attempt to keep the cursor in an area of white space on the display screen. This will allow you to read the error code. This problem is being addressed and should be eliminated in the near future.

OFFLINE DIAGNOSTICS

A third 1186 boot option uses offline boot diagnostics. These offline diagnostic tests may be performed when your 1186 is not running Lisp. The offline diagnostic tests can be run, one by one, upon selection of the appropriate test from a diagnostics menu. The procedure requires the following floppy disks:

Offline Diagnostics Disk #1

Offline Diagnostics Disk #2

Loading Offline Diagnostics From Floppy Disk

1. Press the B Reset button on the processor.
2. Insert Offline Diagnostics Disk #1 in the floppy drive.
Boot icons should appear across the bottom of your screen.
3. Press the F2 key on your keyboard when the icons appear.

A small window with numbers cycling through it will appear in the top left corner of your screen. When the number cycle reaches 0990 a new window will appear, with the word RUNNING, in the upper left corner of the window. This indicates that the Diagnostics Disk #1 is being loaded.

The following message is displayed when Disk #1 has been loaded:

Please insert second diagnostic floppy disk. Is the floppy disk ready? Y

4. Remove Disk #1 and insert Offline Diagnostics Disk #2 into the floppy drive in response to this message. Press the <RETURN> key. The following message appears on your screen:

Loading diagnostics from the second floppy disk

Wait for completion of loading. The following menu appears on the screen when Disk #2 has been loaded:

What class of user do you belong to?

- 1 - Normal User***
- 2 - System Administrator***
- 3 - Technical Support***

Please enter selection:

5. Type 1 and press <RETURN>.

Running Offline Diagnostic Tests

At this point the following menu appears on your screen:

- 1 - Ethernet Tests***
- 2 - Floppy Disk Tests***
- 3 - Floppy Disk Utility***
- 4 - Formatter, Scavenger and Bad Page Utilities***
- 5 - Rigid Disk Tests***
- 6 - Keyboard/Display/Mouse/Beeper Tests***
- 7 - System Configuration Utility***

Please enter selection:

1. Select the test you wish to run from the above menu by typing the number of the desired option.

The equivalences between the numbers on the menu and previous Koto diagnostic floppy disks are:

- 1 (previously unavailable)
- 2 Floppy Disk Utility
- 3 Floppy Disk Utility
- 4 Rigid Disk Utilities (version 1.1)
- 5 Rigid Disk Diagnostics (version 12.0k)
- 6 Keyboard, Mouse & Display Diagnostics (withdrawn in Koto 2.0 Release)

7 System Configuration Utility (version 1.0)
Offline Diagnostics Disk #2
Boot Diagnostics (version 12.0k)

2. Run the diagnostic tests by entering these numbers (3, 4, 5, 6, 7) one at a time.

Each time a number is entered another menu appears. These submenus ask you for more information on running the diagnostic test. To return to the diagnostics menu above, select "Return to Previous Menu" choice on the secondary menu. Repeat step 2 for each of the Diagnostic types.

Note: The Floppy Standard test requires that Offline Diagnostics Floppy Disk #2 be write-enabled.

[This page intentionally left blank.]

Pilot Operating System Codes

Pilot Operating System codes are described below:

0900 - 0999

Pilot Error Codes

- 0915 Pilot breakpoint:
Can signify any number of problems, such as: bad page on the rigid disk, cannot read the floppy disk, or a hardware failure. To recover, try running ALAG. If ALAG passes and its Media Scan test shows no new bad pages, the floppy disk (software installation) is suspect.
- 0937 Trying to find out the time and date:
Trying to get the time off the Ethernet. If it hangs here the software was incorrectly installed. Time can be set from within Lisp (with SETTIME). Standalone users take note: you must set the time everytime you boot Lisp.
- 0981 Trying to discover Ethernet PUP host number:
Will hang in this state if non-Lisp code tries to perform PUP operations and no PUP ID Server responds, or processor ID is not registered. See system administrator.

Lisp Codes

9000 - 9299

Interlisp-D Microcode Error Codes

Most of these errors are indicative of some serious problem; Lisp software attempts to cause regular breaks when these occur.

- 9001 CSParErr Control store parity error;
a hardware error

9002	StackErr	Hardware stack overflow
9003	IBEmptyErr	Instruction fetch unit empty error
9004	VirtAddrErr	Attempt to reference virtual address >22 bits
9005	EmuMemErr	Double bit memory error or non-existent memory
9009		Bad argument to CAR/CDR
9013	NegPcError	Inconsistent PC at FnCall
9014	applyUfn	Arg to apply not integer
9016	notFreeTrap	Stack allocation error
9024		Page fault in the page fault handler.
9051	BadUfnTable	An entry in \UFNtable is invalid
9080		Invalid Var
9088		Invalid Var
9098		Inconsistent Initial microcode
9099		Inconsistent Initial microcode
9120	MiscErr	Misc. Opcode; no such register (OUTPUT)
9121	MiscErr	Misc.Opcode; bad second byte
9122	MiscErr	Misc. Opcode; no such source (INPUT)
9126	PcNegErr	Inconsistent PC at Punt

9300 - 9399

Lisp System Code Errors (call to \MP.ERROR)

These codes generally indicate an error state in Lisp system code that cannot be handled in the break package. Most are "should never happen" cases that indicate a serious error; but some (in particular, 9305 and 9318) may be much less serious. If possible, use TeleRaid to find out more information (press the UNDO key to enter the TeleRaid server (cursor changes into "TeleRaid"), and run the TeleRaid server from another machine).

Even if you can't TeleRaid from another machine, you can convert several of these codes into a Lisp break if the error occurred under user code (rather than, say, the Garbage Collector): type CTRL-B to connect to the TeleRaid server.

Summary of TeleRaid server commands:

- CTRL-B** Attempt to enter Break. If the error is in a special system context, will change cursor to "CANT", indicating refusal to enter break. Warning: even if the system is willing to try to enter a break, it may fail, leaving your system unrestartable. When in doubt, use CTRL-D.

- CTRL-D** Perform Hard Reset—clear stack, flush all non-restartable processes.

- CTRL-N** Continue from error. Warning: You should not use this command except for the following errors: 9318 (when you believe it be be continuable, see below); 9915 error when caused by typing the Raid interrupt; 9325; 9326; 9329.

- CTRL-P** Display PUP host number (in decimal) in maintenance panel.

The Lisp System Code errors are:

- 9302 Invalid Vmem: attempt to boot an image that is not a valid Lisp sysout, or which is inconsistent from having some, but not all, of its dirty pages written. Can happen if you boot instead of calling LOGOUT. Usually caught sooner as code 217.
- 9303 This usually only happens if your machine has insufficient memory.
- 9305 Invalid address: attempt to use a pointer that does not refer to an existing (allocated) part of virtual memory. Usually means garbage was fetched from somewhere that should have contained a pointer; a common source is code with type checking turned off attempting to fetch a datatype field from an object that is not a datatype, such as NIL or a small integer. This error can often be converted to a break with the CTRL-B TeleRaid command if the Lisp image is otherwise in a good state.
- 9307 Inconsistent state in page fault handler.
- 9308 Inconsistent state in page fault handler.
- 9309 Attempt to allocate already existing page (from call to \NEWPAGE).
- 9310 A 9309 error recursively inside the new page allocator.
- 9311 Bad state in virtual memory system.
- 9312 Arg to CLOCK0 not an integer box.
- 9313 Fault on resident page: processor took a page fault for a page that appears to be resident.
- 9314 PageFault on stack: shouldn't happen, as stack is resident.

- 9317 Bad state in virtual memory system.
- 9318 Error in uninterruptable system code: an error that ordinarily would enter a break (e.g., a type test failure), but in a piece of code that should not be user-interruptable. This is generally a sign that some datum used by system code has been smashed, but this is not always fatal. Should you not be in a position to diagnose the error with TeleRaid, you can type CTRL-N after entering the TeleRaid server; Lisp will proceed from the cursor code halt and attempt to enter a break anyway, from which (if it succeeds) you might be able to glean more information about the problem. Warning: continuing with CTRL-N can be fatal if the error really was in a place where a break would not succeed.
- 9319 Stack full: hard stack overflow. A soft stack overflow (Lisp break "STACK FULL") occurs when the stack is mostly used up; if you proceed beyond that point without resetting you can completely fill the stack and get this cursor code. Press STOP to perform a HARDRESET to clear the stack, or run TeleRaid to find out who was guilty of overflowing the stack.
- 9320 Storage is completely full. A continuable Lisp break "STORAGE FULL" occurs when the allocation space is nearly full.
- 9321 Unknown UFN: attempt to execute an unimplemented opcode. This usually means that the processor is trying to execute random memory, or took a wild jump somewhere. Often a microcode bug.
- 9322 Atoms full: the limit on number of litatoms (2^{16}) has been reached.

- 9324 Stack frame use count overflow: the program has attempted to create more than 200 references to the same stack frame.
- 9325 Storage nearly full: this is a warning that comes later than the "STORAGE FULL" break but before you completely run out (and get a 9320). You can continue from this error with CTRL-N from TeleRaid.
- 9326 Bad MDS free list: the free list of recycled MDS pages got trashed. You can continue from this error with CTRL-N from TeleRaid.
- 9327 Bad array block. The array allocator found a bad array block in its free list. Generally means some unsafe code destroyed one or more locations in array space.
- 9328 A variation on 9327.
- 9329 The garbage collector attempted to reclaim an array block, but the block's header was destroyed. You can continue from this error with CTRL-N from TeleRaid, but it is symptomatic of array trashing, and you should save your state as soon as possible and restart in a good sysout.
- 9330 Reference counting problem: an object marked as having a overflowed reference count (greater than 62) is not found in the overflow table.
- 9331 Reference counting problem: an object whose reference count just now overflowed was already in the overflow table.
- 9332 Reference counting problem: an attempt was made to decrement the reference count of an object whose reference count was already zero.

- 9333 One of a number of consistency checks in the process manager failed.
- 9334 The process manager needed to build a function frame for some operation, but failed. This normally should never happen, but could conceivably if you are about to completely fill up the stack (and thus would otherwise get a 9319 error).
- 9336 Somehow control was transferred to the T frame at the top of the world (effectively a (RETTO T), except that RETTO turns that case into a RESET), thereby evading the process world. This leaves the stack in an unresumable state.
- 9337 The process that is being scheduled to run next has had its stack released. An inconsistent state in the process scheduler.
- 9399 See 9341

9400 - 9899 Unassigned

9900 - 9924 Attempt to Call Raid

The only code normally seen in this range is 9915:

- 9915 Call to RAID. Note that if you have the Raid interrupt enabled (typically on CTRL- C), you will get a 9915 error by typing that interrupt character, which you can continue by typing CTRL-N from TeleRaid. Any other occurrence of 9915 generally signifies an error in system code that has not been explicitly assigned a code in the 9300 range.

- ALAG** An acronym for Automatic Load-and-Go, this term describes diagnostics that run with little or no user interaction. Typically, these diagnostics have no menus or commands. Once started, they run independently, and upon completion they return a simple PASS/FAIL indication. If a failure is indicated, other diagnostics are then run by a service technician. Boot Diagnostics and Preboot diagnostics are ALAG, and the Rigid Disk Diagnostics are not.
- ARPANET** Network linking research computers. An acronym for Advanced Research Projects Agency Network.
- atom** The basic Lisp building block and the smallest structure in Lisp. Can consist of any contiguous string of characters, except prohibited characters such as parentheses.
- B Reset** Meaning "boot reset", the red button on the front of your processor unit.
- base state** Black screen with bouncing white rectangle.
- bit map** A representation of a graphic entity as a sequence of bits.
- boot** Short for bootstrap, a machine-level software routine used to facilitate system start-up. Also describes the process of loading a boot file onto the 1186 workstation.

GLOSSARY

- boot icons** The pictorial representations shown on the bottom of your display screen representing the boot types that are available on your system. Same as **boot soft keys** below.
- boot soft keys** The on-screen representation of the ten function keys on the 1186 keyboard.
- break** An indication of an error. When an error happens, an Interlisp "break" is entered, and a "break window" is brought up. The break window appears like a top-level executive window, except that the prompt character ":" is used to indicate that the executive is ready to accept input, in the same way that "←" is used at the top-level executive (see the *Interlisp-D Reference Manual*).
- break window** A working space for handling errors. The title is usually the name of the broken function (see **break**, **window**, and the *Interlisp-D Reference Manual*).
- caret** The blinking symbol on your screen indicating where input is to go. The caret is positioned by moving the mouse cursor.
- clearinghouse** A Xerox Network service that provides a directory function within an internal network, allowing all other system components to locate requested resources and other registered objects. It is implemented as a distributed system.
- CRT** Abbreviation for Cathode-Ray Tube, a vacuum tube used for displaying on-line graphic data. A visible pattern is produced when an electron beam is focused on a small cross-section of a luminescent screen. The beam can be varied in intensity and location to display any form. Your 1186

- display screen is an example of a cathode-ray tube.
- cursor** A character on the CRT that follows the movement of the mouse, and allows you to reposition the caret. It is sometimes called the mouse cursor. The cursor can change shape to indicate certain conditions. An hourglass shape indicates that a process is going on. A small box representing the mouse requires a confirmation response before a selected process is performed. During preboot and boot, the cursor can change to display a four-digit display. See the description for **cursor code**.
- cursor code** Displayed in a small square on the CRT. The cursor changes to a four-character display used to indicate progress, failures, and help trace problems. Cursor codes are not always displayed. They appear during booting to indicate the progress of the boot operation, when running some diagnostics, and when failures occur, both software failures as well as hardware failures. On some Xerox machines, these codes are displayed in the maintenance panel of the processor unit, and are therefore called MP codes.
- DCE** Abbreviation for Data Communications Equipment. An interface suitable for connection to local printers. See the chapter entitled Input/Output.
- diagnostics** Tests used to troubleshoot and isolate problems. Normal or casual users need diagnostics to give positive indications of hardware failures. See the chapter entitled Diagnostics for more information.
- default** An action taken (or value specified) unless another action is specified by the user.

directory	A set of one or more files that are stored together in the same place on a device.
DTE	Abbreviation for Data Terminal Equipment. An interface suitable for common carrier communications.
Ethernet	Communication line used to connect multiple systems having compatible interfaces.
extension	The second part of a file name, usually used to indicate the type of file. It is separated from the first part of the file name (which indicates what the file contains) by a period.
file server	Computer attached to the network that provides file storage and retrieval service.
function	A Lisp procedure that carries out a series of steps to produce some result. A function has a name and zero or more arguments on which it does its work.
host	Any machine on a network. Often used to refer specifically to a machine that provides a network service, such as filing.
icon	A pictorial representation, usually of a shrunken window.
init file	Abbreviated form of initialization file. A file containing user-specified programs. An init file allows you to personalize your Interlisp-D world by automatically including those programs that are most useful every time you log in.
Installer menu	The menu referred to in chapter 4, Software Installation, that offers 17 options, to which you respond by typing the number of the chosen item.

installer prompt	The right angle bracket (>) displayed in the installer menu that usually indicates a user response is required.
Interlisp-D	Dialect of Lisp.
Interlisp-D Executive	The window that contains the cursor at initialization. Formerly called the Top Level Typescript (TTY) window.
IOP	Input/Output Processor.
Lisp	Interactive, recursive programming language widely used for artificial intelligence applications. Short for "List Processing."
litatom	In Lisp, refers to a non-numerical atom.
logical volume	The logical structuring of the media into specific categories such as initial microcode, system, and user areas. Logical volume boundaries are predetermined by software.
MEB	Abbreviation for Memory Expansion Board.
Media Scan	One of the diagnostic test run by ALAG (Automatic Load and Go). Media Scan examines the media page by page, looks for CRC (Cyclic Redundancy Check) errors, and reports them accordingly.
menu	A collection of text strings, buttons, or icons generally used to present a set of possible actions.
Mesa	A Pascal-like, high-level programming language developed at Xerox.
microcode	The microinstructions of a computer, especially a microprocessor.

GLOSSARY

Mesa Processor	Any machine capable of supporting the Mesa Processing Language.
mouse	Pointing device equipped with buttons. Your 1186 workstation may have a two-button or three-button mouse. See chapter 2 for a description of both mouse types. Sometimes referred to as the optical pointer.
mouse cursor	See description for cursor.
MPB	Mesa Processor Board.
network	An interconnection of several computers, allowing them to communicate and share resources. Sometimes also used to refer to the medium itself, e.g., a coaxial cable in the case of the Ethernet.
NIL	In Lisp, NIL is a special lisp atom that translates to "false."
NS	Abbreviation for network systems
operating system	A collection of software routines used to supervise the sequencing and processing of computer programs.
PARC	Abbreviation for Palo Alto Research Center
package	An Interlisp-D tool, or program, designed to help you carry out some complex procedure or task. A package must be loaded into your environment before you can use it.
partition	A piece of a large rigid disk.
pathname	The complete name of a file you want to load. Includes the name of the file server, the directory and subdirectories. For example a Lisp sysout's pathname might be {eris}<lisp>koto>basics>full.sysout,

	where eris is the name of a file server, lisp is the directory, koto and basics are the subdirectories and full.sysout is the specific name of the software you want to load.
PCO	Abbreviation for Personal Computer Option, one of the optional components available for the 1186 workstation.
physical volume	The highest level of logical structuring of the media (i.e., the rigid disk.)
Pilot Operating System	The operating system for the Mesa processor, which serves as an interface between the processor and all other software.
prompt window	The black window at the top of your screen used to display Executive process information. This window can be moved, shaped and temporarily closed.
protocols	Standards specifying how machines exchange information over a network.
PUP	Abbreviation for PARC (see PARC, above) Universal Packet, one of the structures used to transmit blocks of information (packets) on the Ethernet. Also, one such unit of information.
PWA	Printed Wiring Assembly, often referred to as a printed circuit board.
PWBA	Abbreviation for Printed Wiring Board Assembly. See PWA above.
scavenger	Software facility capable of making repairs in page, file order, structure, and in some cases, content.
sysout	A frozen version of an Interlisp-D environment. It contains all the

	information needed to initialize virtual memory when Interlisp-D is started.
Tajo	A Mesa-based window environment that supports System Tools.
Teleraid	A debugging program that is available as a library package.
TOD clock	Time of Day clock.
tracking symbol	Small graphics figure on a display device that represents the position of the cursor and tracks the movement of the mouse. See the description for cursor .
virtual memory	Working space on the local disk.
VAX	Refers to one of Digital Equipment Corporation's mainframe minicomputers, i.e., a VAX 11/750.
VMS	Abbreviation for Virtual Memory System, one of the operating systems used by Digital Equipment Corporation's VAX computers.
window	A defined area within a display screen that can be used as a working space. Windows can be active simultaneously on one display screen, and can overlay one another.

A

AI Support, 32
ARPANET, 32

B

base state,
 booting from, 28
 description, 57
boot
 alternate F1, 43
 button, 1
 diagnostic, 87
 floppy, 36
 icons, 25
 file, 25
 normal, 87
 types, 11
booting, 28
 sequence for Interlisp-D, 28
B Reset, 1
break
 entering a, 94

C

cables, 24
cleaning
 display screen, 30
 keyboard, 30
 mouse, 30
configurations
 standard disk,
CONTROL key
 See CTRL commands

COPYFILE function, 9
copying
 floppies, 75
 See also Appendix B
CTRL commands, 94
cursor codes, 9

D

DCE interface, 19, 82
diagnostic
 floppy disk,
 rigid disk,
disk
 booting from,
 partitioning,
display
 description of, 19
 cleaning, 30
 positioning,
disk scavenging, 53
DTE interface, 19, 82

E

electrical
 requirements, 16
environmental
 requirements, 16
error codes
 Pilot, 92
 TeleRaid, 94
Ethernet
 description of, 11
 interface, 24
 transceiver, 24

F

files

file names, 52

file system, 49

FILESLOAD function, C-2

floppy disk drive, 23

specifications, 23

function keys, 28

H

hard reset, 10

HelpSys

floppy index, C-14

HUGEPILOT mode, 9, 81

I

init file, 6

installation

software, 33

utility floppy, 33-39

Interlisp-D

errors, 92

executive window, 3

installation of, 33

logo window, 5

K

keyboard

diagram, 21

specifications, 22

L

Library Packages

Copyfiles, 13

File Browser, 13

floppy index, C-6

guide to, C-1

Sketch, 5

TEdit, 5

Lisp

initializing, 43

Library Packages, 7

starting, 6

System Tool, 63

system code errors, 94

Users Packages, 7

loading

Lisp Library Packages, 7, 46

Lisp Users Packages, 7

logical volumes, 49

LOGOUT command, 5-6, 48

M

Memory Expansion Board, 17

Microcode Error codes, 92

media scan, 92

Mesa, 91

mouse

cleaning, 29

specifications, 22

troubleshooting, 31

N

network

installing Lisp from, 39

See also, Ethernet

NS host, 12

NS Server

installing a sysout from, 40

pathname, 62

O

On-Line Diagnostics Tool, 74

P

partitioning, 34
pathnames, 62
Pilot error codes, 92
PL command, C-3
power supply, 25
power switch, 27
printer
 connecting to a, 19, 84
processor
 description, 1
 memory, 17
 specifications, 17
Profile Tool, 58
progress codes, 91
prompt window, 4
protocols, 12
PUP
 Installing sysout, 41
 pathname, 62
 protocols, 12

R

references, 13
repartitioning, 3, 34
reporting problems, 32
RS232, 18, 82-86
 cable configurations, 83
 support, 83

S

safety, 16
scavenging, 78
SETTIME function, 13
system administrator, 30
sysout
 description of, 5
 installing from PUP server, 41
 installing from NS server, 40
 installing from floppy, 38
 installing from rigid, 43
SYSOUT function, 80

T

Teleraid
 summary of commands, 94
Troubleshooting, 31
 for Lisp Installation, 48
TTY Port, 83
 cable configurations for, 83

W

wildcard characters, 69
window
 Interlisp-D Executive, 3
 prompt, 3

X

Xerox services
 service representative, 32
 support offices, 32

[This page intentionally left blank.]

APPENDIX A-

SETTING THE TIME

This appendix explains how to set the time either when you first boot the *Installation Utility* or after you have Interlisp-D running

If you have arrived here from chapter 4, *Software Installation*, please follow the instructions for setting the time using the *Installation Utility*, and then return to procedure 1, step c.

Setting Date and Time on Stand-Alone Workstations

Xerox 1186 software is designed to accept date and time information automatically from the network. If time service is not available, or if the Xerox 1186 is not on a network, date and time must be set manually. This can be accomplished by using the SETTIME function when Interlisp-D is running.

Using the SETTIME Function to Set Time

If the date and time are not set after turning on the Xerox 1186 and doing an F1 boot, the boot process will suspend itself temporarily, with the cursor code 0937 displayed on the screen (see chapter 7, *Diagnostics; Cursor Codes*). If no time service is available, date and time must be supplied manually.

To call SETTIME when Interlisp-D is running, type (in the executive window)

```
(SETTIME "9-APR-84 10:44:00")
```

In general, the recommended mode of operation for systems without time service is to boot the Xerox 1186 into Lisp and set the time and date with the function SETTIME.

Note: Time information is not maintained when the machine is powered down.

Using the Installation Utility Floppy to Set Time

It is necessary for users that are not on a network to set the time after booting the *Installation Utility* floppy. You will be prompted as follows:

Time zone offset from Greenwich (-12 - 12):

Enter the appropriate value (see table on next page).

Minute offset (0..59):

Enter 0 and press <RETURN>

First day of daylight savings time (0-366):

Enter 121 and press <RETURN>

Last day of daylight savings time (0-366):

Enter 305 and press <RETURN>

Please enter date and time:

Enter date and time in the format shown
month/day/year hours:minutes:seconds
For example, 3/15/84 15:42:00

Set time to March 15, 1984 3:42 PM

Do you wish to change the time?

Respond by typing Y or N.

TIME ZONE OFFSETS

- 12: (ocean)
- 11: Nome, Alaska
- 10: Honolulu, Hawaii
- 9: Marquesas Islands
- 8: Los Angeles, California
- 7: Denver, Colorado
- 6: Chicago, Illinois
- 5: New York, New York
- 4: Buenos Aires
- 3: Brazil
- 2: Greenland
- 1: Cape Verde Islands
- 0: Greenwich, England
- 1: Paris, France
- 2: Helsinki
- 3: Moscow, U.S.S.R.
- 4: Teheran, Iran
- 5: Sverdlovsk
- 6: Tashkent
- 7: Novosibirsk, U.S.S.R.
- 8: Hong Kong
- 9: Tokyo, Japan
- 10: Vladivostok, U.S.S.R.
- 11: Caroline Islands
- 12: Anadyr, U.S.S.R.

[This page intentionally left blank.]

APPENDIX B-

THE FLOPPY COPY UTILITY

Copying Floppy Disks

Floppy disks may be copied with the use of the *Floppy Disk Copy Utility* provided on floppy disk. This utility allows you to copy an entire floppy image from a source floppy disk to a destination floppy disk.

Using the Floppy Disk Copy Utility

Insert the *Floppy Disk Copy Utility* floppy in the floppy disk drive and press the B RESET button the front panel of the workstation. Press the F2 function key to boot the Utility floppy. You will be prompted with the following:

What class of user do you belong to?

1 - I Am A Normal User

2 - I Am A System Administrator

3 - I Am From Technical Support

Please enter Selection:

Select choice 1. The next menu will look like this:

Floppy Duplication and Verification Facility

1 - Diskette Copy and Checksum Utility

2 - Go To Previous Menu

Please Enter Selection:

Select Choice 1. The menu will be expanded and present you with four options:

- 1 - Read Master
- 2 - Make Copy
- 3 - Calculate Checksum
- 4 - Quit

To make a copy, select choice 1. You will be prompted to insert the source floppy into the floppy drive. When the source floppy has been read into the machine, a short beep will occur. You should then select choice 2 to write out the image retained in the machine onto the destination floppy. You will be prompted to insert the destination floppy into the floppy drive.

You may calculate the checksum of any floppy by selecting choice 3 from the menu. This value is useful when compared with the checksum of a copied floppy, because each copy should have the same checksum value as the original. If the checksums differ, you can assume something is wrong with the copied floppy diskette.

When you wish to exit the *Floppy Disk Copy Utility*, select choice 4 - **Quit**, to return to the menu entitled *Floppy Duplication and Verification Facility*; from here select choice 2 - **Go To Previous Menu**. You will be asked to confirm this choice:

Test data will be deleted upon exit. Is this OK?

Answer Y to exit.

APPENDIX C-

LIBRARY GUIDE

The Library Guide consists of instructions on how to load Lisp Library Modules when the main file and any subsidiary files or modules are located on more than one floppy disk.

The first section, **How to Load From the Library Floppies** provides instruction on how to load modules whose files span more than one floppy, as well as a list of those Library modules that must be loaded from more than one floppy.

The second section, **Lisp Library Floppy Index**, is an alphabetical listing of all the files that comprise the Lisp Library, and the number of the floppy each file can be found on.

The third section, the **HelpSys Floppy Index**, contains an alphabetical listing of all the files that comprise HelpSys, the on-line information system, and the number of the floppy each file can be found on.

How to Load From the Library Floppies

Some modules in the Library consist of several files; some also require for their operation that other modules be present in the environment. When you load the "main" file of a module, the system attempts to automatically load all the required subsidiary files. However, when loading Library files from floppies, all the subsidiary files may not be located on a single floppy. If some of the subsidiary files are located on a different floppy than the main file, then the system is unable to find them. The loading process will stop with a "File Not Found" error and display a break window. To avoid this error, you must explicitly load the subsidiary files, then the main file.

This appendix is divided into three sections. The first two sections provide you with step-by-step procedures for loading the Tedit and Grapher Library modules from floppies.

The third section consists of a table of Library modules and files. For each Library module, one or more modules (indicated by an plus sign (+)) or single files (indicated by floppy number) are listed. If you wish to load the module in the left column, first load the files or modules listed in the right column, in the order given (unless they are already loaded) and then load the module listed in the left column.

For those modules that require the TEdit module, follow the instructions for loading TEdit, load any other subsidiary files and then load the main file.

The easiest way to ensure that a file is only loaded once is to use the function FILESLOAD, which automatically appends the extension "DCOM" to the file name, and checks to see if it is already loaded (in which case it does nothing). For

example, to load the module KEYBOARDEDITOR, you could do the following:

Insert Library Floppy #2

(FILESLOAD ICONW)

Insert Library Floppy #11

(FILESLOAD VIRTUALKEYBOARDS)

Insert Library Floppy #12

(FILESLOAD KEYBOARDEDITOR)

FILESLOAD takes an arbitrary number of arguments.

You can also tell if a file is loaded by looking at its property list with the PL command. Loaded files have a property FILEDATES indicating its source. For example typing:

PL ICONW

will cause the following to be displayed in the executive window

```
FILEDATES : ("11-Sep-85 11:00:04" .  
{ERIS}<LISPCORE>LIBRARY>ICONW.;9))  
COPYRIGHT : ("Xerox Corporation" 1984 1985)
```

Note: Sometimes when you are loading files or showing directories, the executive window will invert (turn black). In order to continue you must press <RETURN>.

Loading the TEDIT Library Module

In order to smoothly load TEdit you must take some preparatory steps before attempting to load all of the files that comprise it. You should note that these instructions are specifically formulated for users without file servers and assume that the local disk is being used to store fonts and files.

1. Copy the MODERN10-C0.DISPLAYFONT from Displayfont floppy # 14 to your local disk. Insert display font floppy # 14 into the floppy drive and type into the executive window:

```
(DIR {FLOPPY})
```

2. After the directory appears, type:

```
(COPYFILE  
'{FLOPPY}MODERN10-C0.DISPLAYFONT  
'{DSK}<LISPPFILES>  
MODERN10-C0.DISPLAYFONT)
```

3. When the copying process is complete you must set the variable DISPLAYFONTDIRECTORIES so files that require this font to load successfully will know where to find it. In the executive window type:

```
(SETQ DISPLAYFONTDIRECTORIES  
'({DSK}<LISPPFILES>))
```

4. You also need to set the DIRECTORIES variable to a list of places that a file will look for allied files that it needs for a successful load. In the executive window type:

```
(SETQ DIRECTORIES '({FLOPPY}  
{DSK}<LISPPFILES>))
```

Now you must copy some TEdit files from floppy to your local disk. Having these files on the disk when you load TEdit will prevent the loading process from being interrupted when other TEdit files "look for" these files. To copy these files to your disk:

5. Insert Library floppy #2 and in the executive window type:

```
(DIR {FLOPPY})
```

6. After the directory has been displayed, type in the executive window:

```
(COPYFILE '{FLOPPY}TEDITPAGE.DCOM  
'{DSK}<LISPPFILES>TEDITPAGE.DCOM)
```

8. After the copy process is complete, type in the executive window:

```
(COPYFILE '{FLOPPY}TEDITFILE.DCOM  
'{DSK}<LISPPFILES>TEDITFILE.DCOM)
```

9. After the copy process is complete and with Library Floppy #2 still in the floppy drive, type in the executive window:

```
(FILESLOAD TEDITABBREV IMAGEOBJ  
ICONW TEDITFIND TEDITFNKEYS)
```

10. Insert Library Floppy #1. In the executive window type:

```
(DIR {FLOPPY})
```

11. After the directory has been displayed, type in the executive window:

```
(FILESLOAD TEDIT)
```

This last procedure takes about four minutes and completes the loading sequence for TEdit.

Loading the GRAPHER Library Module

Successful loading of the Grapher module requires that all of the Helvetica display fonts be accessible during the load. You must copy the Helvetica display fonts to an accessible place, for example, your local disk.

The easiest way to transfer the fonts from floppy to a local disk is to use the library module Copyfiles. You will find COPYFILES.DCOM on Library floppy # 4.

1. Insert Library floppy #4 in the floppy drive and type in the executive window:

```
(DIR {FLOPPY})
```

2. After the directory is displayed, type in the executive window:

```
(FILESLOAD COPYFILES)
```

Once Copyfiles is loaded into your virtual memory you can copy all the Helvetica fonts to your disk at once.

3. Insert Display font floppy #13 into the floppy drive and type into the executive window:

```
(DIR {FLOPPY})
```

4. After the directory is displayed, type in the executive window:

```
(COPYFILES '{FLOPPY}HELVETICA*  
' {DSK}<LISPPFILES>HELVETICA*)
```

Transferring the Helvetica display font files to your disk will take about one minute.

5. Once the fonts are on your local disk, you must set the variable DISPLAYFONTDIRECTORIES to the place where you installed the fonts. Continuing with the example of using the local hard disk, you would type into the executive window:

```
(SETQ DISPLAYFONTDIRECTORIES  
'({DSK}<LISPPFILES>))
```

You are now ready to load the Grapher package.

6. Insert Library floppy #2 into the floppy drive and type in the executive window:

```
(DIR {FLOPPY})
```

7. After the directory is displayed, type in the executive window:

(FILESLOAD GRAPHER)

This completes the loading sequence for the Grapher Library module.

Loading Other Library Packages

Any Library packages not present in this table require no special action—they load only files that are located on the same floppy. Special characters (+ † ‡ § and § §) are keys to footnotes at the end of the table.

<i>To load:</i>	<i>First load these files/modules:</i>
C150STREAM(7)	READNUMBER (2)
COLOR(7)	READNUMBER (2)
COLORDEMO(7)	READNUMBER (2)
DINFO (HelpSys#6)	TEDIT + ‡ GRAPHER (2)‡ FREEMENU (12) HASH (6)
FILEBROWSER(8)	ICONW (2)
GRAPHER‡	HELVETICA DISPLAYFONTS (DISPLAYFONT # 13)
HELPSYS (HelpSys#6)	HASH (6) TEDIT + ‡
IRISSTREAM (8)§§	READNUMBER (2) COLOR (7) GACHAE-SF FONTS (9)
KERMITMENU(6)†	FREEMENU (12) CHAT (6)
KEYBOARDEDITOR (12)	ICONW (2) VIRTUALKEYBOARDS (11)
LOADIRIS(8)	ICONW (2)

	FREEMENU (12)
MATMULT(3)	CMLARRAY (4)
RS232CHAT(5)†	CHAT (6)
RS232CMENU(5)†	CHAT (6) FREEMENU (12)
SKETCH(3)	TEDIT + ‡ GRAPHZOOM (2) CMLARRAY (4)
TCPCHAT(5)†§	CHAT (6)
TEDIT(1)‡	
TTYCHAT(5)†	CHAT (6)
VIRTUALKEYBOARDS (11)	ICONW (2)

NOTES

+ Module consists of one or more additional files.

† Before attempting to load this module you must add {FLOPPY} to the list, LISPUSERSDIRECTORIES:

```
(SETQ LISPUSERSDIRECTORIES  
'({FLOPPY}))
```

‡ See specific module loading instructions above.

§ Once TCPCHAT has finished loaded you will be prompted:

```
Please enter the name of the IP  
initialization file for this host.
```

```
Please consult the Lisp Library Packages  
manual for information on the initialization  
procedure.
```

§§ Before attempting to load Irisstream you must copy the SF font set to a random access device. Then set the variable IRISFONTDIRECTORIES to the place where you have your fonts.

[This page intentionally left blank]

Lisp Library Floppy Index

4045STREAM.DCOM	KOTO LIBRARY #7
BIG.DCOM	KOTO LIBRARY #2
BITMAPFNS.DCOM	KOTO LIBRARY #2
BROWSER.DCOM	KOTO LIBRARY #2
BUSEXTENDER.DCOM	KOTO LIBRARY #6
BUSMASTER.DCOM	KOTO LIBRARY #6
C150STREAM.DCOM	KOTO LIBRARY #7
CENTRONICS.DCOM	KOTO LIBRARY #7
CHAT.DCOM	KOTO LIBRARY #6
CHATTERMINAL.DCOM	KOTO LIBRARY #6
CHECKSET.DCOM	KOTO LIBRARY #12
CIRCLPRINT.DCOM	KOTO LIBRARY #1
CLASSIC10C0.C150FONT	KOTO LIBRARY #7
CLASSIC14C0.C150FONT	KOTO LIBRARY #7
CLASSIC18C10.C150FONT	KOTO LIBRARY #7
CML.DCOM	KOTO LIBRARY #4
CMLARITH.DCOM	KOTO LIBRARY #4
CMLARRAY.DCOM	KOTO LIBRARY #4
CMLARRAYINSPECTOR.DCOM	KOTO LIBRARY #4
CMLCHARACTER.DCOM	KOTO LIBRARY #4
CMLCOMPILE.DCOM	KOTO LIBRARY #4

CMLEXEC.DCOM	KOTO LIBRARY #4
CMLFLOATARRAY.DCOM	KOTO LIBRARY #4
CMLHELP.DCOM	KOTO LIBRARY #4
CMLPRETTY.DCOM	KOTO LIBRARY #4
CMLPRINT.DCOM	KOTO LIBRARY #4
CMLSETF.DCOM	KOTO LIBRARY #4
CMLSPECIALFORMS.DCOM	KOTO LIBRARY #4
CMLSTREAMS.DCOM	KOTO LIBRARY #4
CMLSTRUCT.DCOM	KOTO LIBRARY #4
CMLTYPES.DCOM	KOTO LIBRARY #4
COLOR.DCOM	KOTO LIBRARY #7
COLORDEMO.DCOM	KOTO LIBRARY #7
COMPILEBANG.DCOM	KOTO LIBRARY #4
COPYFILES.DCOM	KOTO LIBRARY #4
DANDELIONKEYBOARDS.	KOTO LIBRARY #11
DATABASEFNS.DCOM	KOTO LIBRARY #6
DECL.DCOM	KOTO LIBRARY #4
DES.DCOM	KOTO LIBRARY #10
DLRS232C.DCOM	KOTO LIBRARY #5
DLTTY.DCOM	KOTO LIBRARY #5
DMCHAT.DCOM	KOTO LIBRARY #6
DORADOCOLOR.DCOM	KOTO LIBRARY #7
DORADOKEYBOARDS.	KOTO LIBRARY #11

DOVEKEYBOARDS.	KOTO LIBRARY #11
EDITBITMAP.DCOM	KOTO LIBRARY #2
ETHERRECORDS.	KOTO LIBRARY #7
EXPORTS.ALL	KOTO LIBRARY #11
FASTFX80STREAM.DCOM	KOTO LIBRARY #7
FILEBROWSER.DCOM	KOTO LIBRARY #8
FILECACHE.DCOM	KOTO LIBRARY #9
FONTSAMPLE.DCOM	KOTO LIBRARY #7
FONTSHEET1.IP	KOTO LIBRARY #7
FONTSHEET2.IP	KOTO LIBRARY #7
FONTSHEET3.IP	KOTO LIBRARY #7
FONTSHEET4.IP	KOTO LIBRARY #7
FONTSHEET5.IP	KOTO LIBRARY #7
FREEMENU.DCOM	KOTO LIBRARY #12
FTPSERVER.DCOM	KOTO LIBRARY #6
FX80STREAM.	KOTO LIBRARY #12
FX80STREAM.DCOM	KOTO LIBRARY #12
FXPRINTER.DCOM	KOTO LIBRARY #7
GACHAE.LC1-SF	KOTO LIBRARY #9
GACHAE.LC2-SF	KOTO LIBRARY #9
GACHAE.NUM-SF	KOTO LIBRARY #9
GACHAE.S1-SF	KOTO LIBRARY #9
GACHAE.S2-SF	KOTO LIBRARY #9

GACHAE.UC1-SF	KOTO LIBRARY #9
GACHAE.UC2-SF	KOTO LIBRARY #9
GCHAX.DCOM	KOTO LIBRARY #6
GRAPHER.DCOM	KOTO LIBRARY #2
GRAPHZOOM.DCOM	KOTO LIBRARY #2
HASH.DCOM	KOTO LIBRARY #6
HLCOLOR.DCOM	KOTO LIBRARY #7
HRULE.DCOM	KOTO LIBRARY #1
ICONW.DCOM	KOTO LIBRARY #2
IMAGEOBJ.DCOM	KOTO LIBRARY #2
INIT.NONET	KOTO LIBRARY #12
INIT.SAMPLE	KOTO LIBRARY #12
IRISCONSTANTS.DCOM	KOTO LIBRARY #8
IRISIO.DCOM	KOTO LIBRARY #8
IRISLIB.DCOM	KOTO LIBRARY #8
IRISNET.DCOM	KOTO LIBRARY #8
IRISSTREAM.DCOM	KOTO LIBRARY #8
KERMIT.	KOTO LIBRARY #6
KERMIT.DCOM	KOTO LIBRARY #6
KERMITMENU.DCOM	KOTO LIBRARY #6
KEYBOARDEDITOR.DCOM	KOTO LIBRARY #12
LABEL.DCOM	KOTO LIBRARY #4
LAMBDATRAN.DCOM	KOTO LIBRARY #4

LISTEN.DCOM	KOTO LIBRARY #4
LLCOLOR.DCOM	KOTO LIBRARY #7
LOADIRIS.DCOM	KOTO LIBRARY #8
MATMULT.DCOM	KOTO LIBRARY #3
MINISERVE.DCOM	KOTO LIBRARY #7
NSCHAT.DCOM	KOTO LIBRARY #6
NSMAINTAIN.DCOM	KOTO LIBRARY #10
PCALLSTATS.DCOM	KOTO LIBRARY #3
PUPCHAT.DCOM	KOTO LIBRARY #6
RDSYS.DCOM	KOTO LIBRARY #11
READAIS.DCOM	KOTO LIBRARY #12
READNUMBER.DCOM	KOTO LIBRARY #2
READNUMBER.DCOM	KOTO LIBRARY #10
READSYS.DCOM	KOTO LIBRARY #11
REMOTEVMEM.DCOM	KOTO LIBRARY #11
RS232CHAT.DCOM	KOTO LIBRARY #5
RS232CMENU.DCOM	KOTO LIBRARY #5
SAMEDIR.DCOM	KOTO LIBRARY #3
SFFONT.DCOM	KOTO LIBRARY #8
SIMPLIFY.DCOM	KOTO LIBRARY #4
SKETCH.DCOM	KOTO LIBRARY #3
SKETCHEDIT.DCOM	KOTO LIBRARY #3
SKETCHELEMENTS.DCOM	KOTO LIBRARY #3

SKETCHOBJ.DCOM	KOTO LIBRARY #3
SKETCHSTREAM.DCOM	KOTO LIBRARY #3
SPY.DCOM	KOTO LIBRARY #2
SYSEDT.	KOTO LIBRARY #4
TABLEBROWSER.DCOM	KOTO LIBRARY #8
TCP.DCOM	KOTO LIBRARY #5
TCPCHAT.DCOM	KOTO LIBRARY #5
TCPCONFIG.DCOM	KOTO LIBRARY #5
TCPDEBUG.DCOM	KOTO LIBRARY #5
TCPFTP.DCOM	KOTO LIBRARY #5
TCPHTE.DCOM	KOTO LIBRARY #5
TCPLLAR.DCOM	KOTO LIBRARY #5
TCPLLICMP.DCOM	KOTO LIBRARY #5
TCPLLIP.DCOM	KOTO LIBRARY #5
TCPNAMES.DCOM	KOTO LIBRARY #5
TCPTFTP.DCOM	KOTO LIBRARY #5
TCPUUDP.DCOM	KOTO LIBRARY #5
TEDIT.DCOM	KOTO LIBRARY #1
TEDITABBREV.DCOM	KOTO LIBRARY #2
TEDITCHAT.DCOM	KOTO LIBRARY #6
TEDITCOMMAND.DCOM	KOTO LIBRARY #2
TEDITFILE.DCOM	KOTO LIBRARY #2
TEDITFIND.DCOM	KOTO LIBRARY #2

TEDITFNKEYS.DCOM	KOTO LIBRARY #2
TEDITHCPY.DCOM	KOTO LIBRARY #1
TEDITHISTORY.DCOM	KOTO LIBRARY #1
TEDITLOOKS.DCOM	KOTO LIBRARY #1
TEDITMENU.DCOM	KOTO LIBRARY #1
TEDITPAGE.DCOM	KOTO LIBRARY #2
TEDITSCREEN.DCOM	KOTO LIBRARY #1
TEDITSELECTION.DCOM	KOTO LIBRARY #2
TEDITWINDOW.DCOM	KOTO LIBRARY #1
TEK4010CHAT.DCOM	KOTO LIBRARY #6
TELERAID.DCOM	KOTO LIBRARY #11
TEXEC.DCOM	KOTO LIBRARY #6
TEXTOFD.DCOM	KOTO LIBRARY #2
TFBRAVO.DCOM	KOTO LIBRARY #1
TIMESROMAN.LC1-SF	KOTO LIBRARY #10
TIMESROMAN.LC2-SF	KOTO LIBRARY #10
TIMESROMAN.NUM-SF	KOTO LIBRARY #10
TIMESROMAN.S1-SF	KOTO LIBRARY #10
TIMESROMAN.S3-SF	KOTO LIBRARY #10
TIMESROMAN.UC1-SF	KOTO LIBRARY #10
TIMESROMAN.UC2-SF	KOTO LIBRARY #10
TIMESROMAN10C0.C150FONT	KOTO LIBRARY #7
TIMESROMAN12C0.C150FONT	KOTO LIBRARY #7

APPENDIX C

TIMESROMAN14C0.C150FONT	KOTO LIBRARY #7
TTYCHAT.DCOM	KOTO LIBRARY #5
VIRTUALKEYBOARDS.DCOM	KOTO LIBRARY #11
VMEM.DCOM	KOTO LIBRARY #11
VT100KP.DCOM	KOTO LIBRARY #6
VTCHAT.DCOM	KOTO LIBRARY #6
WHEREIS.DCOM	KOTO LIBRARY #6

HelpSys Floppy Index

CHAPACK.TXT	KOTO HELPSYS #5
CHAPARRAYS.TXT	KOTO HELPSYS #4
CHAPBREAKING.TXT	KOTO HELPSYS #5
CHAPCLISP.TXT	KOTO HELPSYS #1
CHAPCOMPILER.TXT	KOTO HELPSYS #1
CHAPCONTROLFNS.TXT	KOTO HELPSYS #3
CHAPDWIM.TXT	KOTO HELPSYS #4
CHAPEDITOR.TXT	KOTO HELPSYS #1
CHAPERROES.TXT	KOTO HELPSYS #1
CHAPETHER.TXT	KOTO HELPSYS #4
CHAPEXEC.TXT	KOTO HELPSYS #3
CHAPFILES.TXT	KOTO HELPSYS #5
CHAPFNDEF.TXT	KOTO HELPSYS #4
CHAPFP.TXT	KOTO HELPSYS #2
CHAPGRAPHICS.TXT	KOTO HELPSYS #3
CHAPHARDCOPY.TXT	KOTO HELPSYS #5
CHAPHASHARRAYS.TXT	KOTO HELPSYS #6
CHAPINTRO.TXT	KOTO HELPSYS #5
CHAPIO.TXT	KOTO HELPSYS #4
CHAPLISTS.TXT	KOTO HELPSYS #6
CHAPLITATOMS.TXT	KOTO HELPSYS #6

APPENDIX C

CHAPMASTERSCOPE.TXT	KOTO HELPSYS #4
CHAPMISC.TXT	KOTO HELPSYS #2
CHAPNUMBERS.TXT	KOTO HELPSYS #1
CHAPPERFORMANCE.TXT	KOTO HELPSYS #5
CHAPPROCESSES.TXT	KOTO HELPSYS #5
CHAPRECORDPACKAGE.TXT	KOTO HELPSYS #5
CHAPSTACK.TXT	KOTO HELPSYS #2
CHAPSTRINGS.TXT	KOTO HELPSYS #5
CHAPTERMINAL.TXT	KOTO HELPSYS #5
CHAPUSERIO.TXT	KOTO HELPSYS #3
CHAPWINDOWS.TXT	KOTO HELPSYS #2
DINFO.DCOM	KOTO HELPSYS #6
HELPSYS.DCOM	KOTO HELPSYS #6
IRM.DINFOGRAPH	KOTO HELPSYS #6
IRM.HASHFILE	KOTO HELPSYS #7
IRM.HASHFILE	KOTO HELPSYS #8
IRM.HASHFILE	KOTO HELPSYS #9
IRMTOP.TXT	KOTO HELPSYS #6

DOCUMENT UPDATE SHEET

Document Name: *Xerox 1186 User's Guide*

Document Number: *3101678*

DOC. VERSION	RELEASE DATE	REPLACE PAGES	INSERT PAGES	INSTRUCTIONS/ NOTES
<i>Koto 2.02</i>	<i>1/30/87</i>	<i>N/A</i>	<i>pp. 48-1 through 48-2</i>	<i>The attached insert describes how to install microcode only. This is necessary in case you ever erase your Lispfiles volume. Insert this page between pages 48 and 49 of your 1186 User's Guide.</i>
<i>Koto 2.02</i>	<i>1/30/87</i>	<i>N/A</i>	<i>pp. 91-1 through 91-4</i>	<i>These pages have been supplied to document the Offline Diagnostics option. They logically follow the section titled "Results of Boot Diagnostics" (pp. 90-91) and precede the section titled "Cursor Codes." Place the new pages between pages 90 and 91.</i>

Steps for Microcode Only Installation

If you accidentally erase your Lispfiles volume, you must reinstall your microcode. This step tells you how to do so.

- a. Insert the *Installation Utility* floppy.
- b. Press the B Reset button on the front of the processor unit.
 - Wait up to five seconds for the boot device icons to appear on the screen.
 - Press the F2 key (Floppy Boot).

The 4-digit cursor code will count 149, 199, 910, 920, 940, 990, then the Main Menu will appear.

- c. Type the number for Lisp Installation and press <RETURN>.
- d. Type the number for Install Lisp Microcode Only and press <RETURN>. You will be prompted to insert "System Files Floppy #1." Insert the floppy and press <RETURN>.

Note: Prolog users must choose the menu option "Install Prolog Microcode" after installing the Lisp microcode.

[This page intentionally left blank.]

OFFLINE DIAGNOSTICS

A third 1186 boot option uses offline boot diagnostics. These offline diagnostic tests may be performed when your 1186 is not running Lisp. The offline diagnostic tests can be run, one by one, upon selection of the appropriate test from a diagnostics menu. The procedure requires the following floppy disks:

Offline Diagnostics Disk #1

Offline Diagnostics Disk #2

Loading Offline Diagnostics From Floppy Disk

1. Press the B Reset button on the processor.
2. Insert Offline Diagnostics Disk #1 in the floppy drive.
Boot icons should appear across the bottom of your screen.
3. Press the F2 key on your keyboard when the icons appear.

A small window with numbers cycling through it will appear in the top left corner of your screen. When the number cycle reaches 0990 a new window will appear, with the word RUNNING, in the upper left corner of the window. This indicates that the Diagnostics Disk #1 is being loaded.

The following message is displayed when Disk #1 has been loaded:

Please insert second diagnostic floppy disk. Is the floppy disk ready? Y

4. Remove Disk #1 and insert Offline Diagnostics Disk #2 into the floppy drive in response to this message. Press the <RETURN> key. The following message appears on your screen:

Loading diagnostics from the second floppy disk

Wait for completion of loading. The following menu appears on the screen when Disk #2 has been loaded:

What class of user do you belong to?

- 1 - Normal User***
- 2 - System Administrator***
- 3 - Technical Support***

Please enter selection:

5. Type 1 and press <RETURN>.

Running Offline Diagnostic Tests

At this point the following menu appears on your screen:

- 1 - Ethernet Tests***
- 2 - Floppy Disk Tests***
- 3 - Floppy Disk Utility***
- 4 - Formatter, Scavenger and Bad Page Utilities***
- 5 - Rigid Disk Tests***
- 6 - Keyboard/Display/Mouse/Beeper Tests***
- 7 - System Configuration Utility***

Please enter selection:

1. Select the test you wish to run from the above menu by typing the number of the desired option.

The equivalences between the numbers on the menu and previous Koto diagnostic floppy disks are:

- 1 (previously unavailable)
- 2 Floppy Disk Utility
- 3 Floppy Disk Utility
- 4 Rigid Disk Utilities (version 1.1)
- 5 Rigid Disk Diagnostics (version 12.0k)
- 6 Keyboard, Mouse & Display Diagnostics (withdrawn in Koto 2.0 Release)

7 System Configuration Utility (version 1.0)
Offline Diagnostics Disk #2
Boot Diagnostics (version 12.0k)

2. Run the diagnostic tests by entering these numbers (3, 4, 5, 6, 7) one at a time.

Each time a number is entered another menu appears. These submenus ask you for more information on running the diagnostic test. To return to the diagnostics menu above, select "Return to Previous Menu" choice on the secondary menu. Repeat step 2 for each of the Diagnostic types.

Note: The Floppy Standard test requires that Offline Diagnostics Floppy Disk #2 be write-enabled.

[This page intentionally left blank.]

**Replacement Pages
for
Chapter 4
of the 1186 User's Guide**

*Please remove
old pages **35 through 38**
and replace them
with these pages.*

- Press the F2 key (Floppy Boot).

The 4-digit cursor code will count 149, 199, 910, 920, 940, 990 then the Main Menu will appear.

Note: If, after the Main Menu appears, you are asked to set the time, please refer to Appendix A for time-setting instructions.

c. Type 1 (Lisp Installation).

- The Installer menu will appear.

d. Type 1, 2, 3, 4, 5, or 6 depending on disk size (Partition xxMB disk. . .) and press <RETURN>.

You will then see the message:

WARNING - PARTITIONING A DISK DESTROYS ALL ITS CONTENTS

CONTINUE?(Y/N)

If the disk is new or files have been BACKED UP type Y, and press <RETURN>. After about 5 minutes, the installer menu will reappear. Go to Procedure 2, "Microcode and System Tool Installation."

2) Microcode and System Tool Installation

Prerequisites:

Assumes the disk is partitioned for Lisp.

Usage:

Can be safely repeated, but only needs to be done once after Partitioning.

Special Instructions:

If you have just finished partitioning (Procedure 1), go to step d.

Steps for Microcode and System Tool Installation

- a. Insert the *Installation Utility* floppy.
- b. Press the B Reset button on the front of the processor unit.
 - Wait up to five seconds for the boot device icons to appear on the screen.
 - Press the F2 key (Floppy Boot).

The 4-digit cursor code will count 149, 199, 910, 920, 940, 990, then the Main Menu will appear.

- c. Type **1** (Lisp Installation) and press <RETURN>.
- d. When the Installer menu appears, type **7** (Initialize Workstation System Tools volume) and press <RETURN>.
 - Wait for the prompt to appear. This can take up to two minutes.
 - Insert the "System Files" floppies as prompted. There are five System Files floppies. You will be prompted to insert the System Files floppies into the floppy disk drive by number, e.g., "Insert Floppy Disk labeled 'System Files #1' in the floppy disk drive." After you have inserted the correct floppy press <RETURN>.
- e. When the installation of the System Tools is complete, the Installer menu will reappear.
- f. When the menu reappears, type **8** (Boot System Tools Volume) and press <RETURN>. **Note that System Files floppy #5 should still be in the disk drive.**

After you perform step f, the machine will illuminate, running Tajo.

Note: At the top of the screen you will see "User: {}! Invalid Password." Ignore this message.

An icon, labeled "Executive 12.2c," will appear near the bottom of the screen. Move the cursor to the center top of this icon (a small region of the icon will invert) and press the right mouse button. The icon will expand into the Tajo executive window. Move the cursor into the executive window and press the left mouse button. This is where you type:
Floppy Read Init.cm;@Init.cm
and press <RETURN>.

The caret will turn into a small black blinking rectangle. A series of messages will be printed in the executive window informing you of the progress of the installation.

After the above command is executed, your 1186 will go into the base state, a bouncing white box with various messages regarding the uses of the System Tools.

You may remove the System Files floppy #5 from the floppy disk drive now.

g. Proceed to install the Lisp Sysout from Floppies (Procedure 3) or from the Network (Procedure 4).

3) Installing the Lisp Sysout from Floppies

Prerequisites:

Assumes the Initial Microcode and Lisp Microcode have been installed and the System Tools are running (Procedure 2, above).

Usage:

This procedure takes about 30 minutes.

Warning:

Destroys the Lisp Virtual Memory of last logout, but not the LispFiles.

Steps for Installing the Lisp Sysout from Floppies

You should be in the base state, with the bouncing white box on your screen.

a. Press the left mouse button to enter the window labeled Lisp System Tool.

● Wait about one minute for the Lisp System Tool window to appear.

b. One third of the way down the window on the line that begins with the **Document:** parameter, move the cursor over the **Floppy** choice. Press the left mouse button. **Floppy** should become highlighted.

c. Skip the next line and move the cursor over the **Volume Menu:** parameter and press the left mouse button. Type just the number 2, which will be added to the word Lisp. After you finish typing, the **Volume Menu:** parameter should look like:

Volume Menu: Lisp2.

1186 User's Guide
Appendix C: Library Guide

Please remove Appendix C (pages C-1 to C-14) in your copy of the 1186 User's Guide. Remove the cover sheets from this enclosure and insert the new Appendix C pages in their place.

APPENDIX C- LIBRARY GUIDE

The Library Guide consists of instructions on how to load Lisp Library Modules when the main file and any subsidiary files or modules are located on more than one floppy disk.

The first section, **How to Load From the Library Floppies** provides instruction on how to load modules whose files span more than one floppy, as well as a list of those Library modules that must be loaded from more than one floppy.

The second section, **Lisp Library Floppy Index**, is an alphabetical listing of all the files that comprise the Lisp Library, and the number of the floppy each file can be found on.

The third section, the **HelpSys Floppy Index**, contains an alphabetical listing of all the files that comprise HelpSys, the on-line information system, and the number of the floppy each file can be found on.

How to Load From the Library Floppies

Some modules in the Library consist of several files; some also require for their operation that other modules be present in the environment. When you load the "main" file of a module, the system attempts to automatically load all the required subsidiary files. However, when loading Library files from floppies, all the subsidiary files may not be located on a single floppy. If some of the subsidiary files are located on a different floppy than the main file, then the system is unable to find them. The loading process will stop with a "File Not Found" error and display a break window. To avoid this error, you must explicitly load the subsidiary files, then the main file.

This appendix is divided into three sections. The first two sections provide you with step-by-step procedures for loading the Tedit and Grapher Library modules from floppies.

The third section consists of a table of Library modules and files. For each Library module, one or more modules (indicated by an plus sign (+)) or single files (indicated by floppy number) are listed. If you wish to load the module in the left column, first load the files or modules listed in the right column, in the order given (unless they are already loaded) and then load the module listed in the left column.

For those modules that require the TEdit module, follow the instructions for loading TEdit, load any other subsidiary files and then load the main file.

The easiest way to ensure that a file is only loaded once is to use the function FILESLOAD, which automatically appends the extension "DCOM" to the file name, and checks to see if it is already loaded (in which case it does nothing). For

example, to load the module KEYBOARDEDITOR, you could do the following:

Insert Library Floppy #2

(FILESLOAD ICONW)

Insert Library Floppy #11

(FILESLOAD VIRTUALKEYBOARDS)

Insert Library Floppy #12

(FILESLOAD KEYBOARDEDITOR)

FILESLOAD takes an arbitrary number of arguments.

You can also tell if a file is loaded by looking at its property list with the PL command. Loaded files have a property FILEDATES indicating its source. For example typing:

PL ICONW

will cause the following to be displayed in the executive window

```
FILEDATES : (("11-Sep-85 11:00:04" .  
{ERIS}<LISPCORE>LIBRARY>ICONW.;9))  
COPYRIGHT : ("Xerox Corporation" 1984 1985)
```

Note: Sometimes when you are loading files or showing directories, the executive window will invert (turn black). In order to continue you must press <RETURN>.

Loading the TEDIT Library Module

In order to smoothly load TEdit you must take some preparatory steps before attempting to load all of the files that comprise it. You should note that these instructions are specifically formulated for users without file servers and assume that the local disk is being used to store fonts and files.

1. Copy the MODERN10-C0.DISPLAYFONT from Displayfont floppy # 14 to your local disk. Insert display font floppy # 14 into the floppy drive and type into the executive window:

```
(DIR {FLOPPY})
```

2. After the directory appears, type:

```
(COPYFILE  
' {FLOPPY}MODERN10-C0.DISPLAYFONT  
' {DSK}<LISPPFILES>  
  MODERN10-C0.DISPLAYFONT)
```

3. When the copying process is complete you must set the variable DISPLAYFONTDIRECTORIES so files that require this font to load successfully will know where to find it. In the executive window type:

```
(SETQ DISPLAYFONTDIRECTORIES  
' ({DSK}<LISPPFILES>))
```

4. You also need to set the DIRECTORIES variable to a list of places that a file will look for allied files that it needs for a successful load. In the executive window type:

```
(SETQ DIRECTORIES '({FLOPPY}  
  {DSK}<LISPPFILES>))
```

Now you must copy some TEdit files from floppy to your local disk. Having these files on the disk when you load TEdit will prevent the loading process from being interrupted when other TEdit files "look for" these files. To copy these files to your disk:

5. Insert Library floppy #2 and in the executive window type:

```
(DIR {FLOPPY})
```

6. After the directory has been displayed, type in the executive window:

```
(COPYFILE '{FLOPPY}TEDITPAGE.DCOM  
' {DSK}<LISPPFILES>TEDITPAGE.DCOM)
```

8. After the copy process is complete, type in the executive window:

```
(COPYFILE '{FLOPPY}TEDITFILE.DCOM  
' {DSK}<LISPPFILES>TEDITFILE.DCOM)
```

9. After the copy process is complete and with Library Floppy #2 still in the floppy drive, type in the executive window:

```
(FILESLOAD TEDITABBREV IMAGEOBJ  
ICONW TEDITFIND TEDITFNKEYS)
```

10. Insert Library Floppy #1. In the executive window type:

```
(DIR {FLOPPY})
```

11. After the directory has been displayed, type in the executive window:

```
(FILESLOAD TEDIT)
```

This last procedure takes about four minutes and completes the loading sequence for TEdit.

Loading the GRAPHER Library Module

Successful loading of the Grapher module requires that all of the Helvetica display fonts be accessible during the load. You must copy the Helvetica display fonts to an accessible place, for example, your local disk.

The easiest way to transfer the fonts from floppy to a local disk is to use the library module Copyfiles. You will find COPYFILES.DCOM on Library floppy # 4.

1. Insert Library floppy #4 in the floppy drive and type in the executive window:

```
(DIR {FLOPPY})
```

2. After the directory is displayed, type in the executive window:

```
(FILESLOAD COPYFILES)
```

Once Copyfiles is loaded into your virtual memory you can copy all the Helvetica fonts to your disk at once.

3. Insert Display font floppy #13 into the floppy drive and type into the executive window:

```
(DIR {FLOPPY})
```

4. After the directory is displayed, type in the executive window:

```
(COPYFILES '{FLOPPY}HELVETICA*  
'{DSK}<LISPPFILES>HELVETICA*)
```

Transferring the Helvetica display font files to your disk will take about one minute.

5. Once the fonts are on your local disk, you must set the variable DISPLAYFONTDIRECTORIES to the place where you installed the fonts. Continuing with the example of using the local hard disk, you would type into the executive window:

```
(SETQ DISPLAYFONTDIRECTORIES  
'({DSK}<LISPPFILES>))
```

You are now ready to load the Grapher package.

6. Insert Library floppy #2 into the floppy drive and type in the executive window:

```
(DIR {FLOPPY})
```

7. After the directory is displayed, type in the executive window:

(FILESLOAD GRAPHER)

This completes the loading sequence for the Grapher Library module.

Loading Other Library Packages

Any Library packages not present in this table require no special action—they load only files that are located on the same floppy. Special characters (+ † ‡ § and §§) are keys to footnotes at the end of the table.

<i>To load:</i>	<i>First load these files/modules:</i>
C150STREAM(7)	READNUMBER (2)
COLOR(7)	READNUMBER (2)
COLORDEMO(7)	READNUMBER (2)
DINFO (HelpSys#6)	TEDIT + ‡ GRAPHER (2)‡ FREEMENU (12) HASH (6)
FILEBROWSER(8)	ICONW (2)
GRAPHER‡	HELVETICA DISPLAYFONTS (DISPLAYFONT # 13)
HELPSYS (HelpSys#6)	HASH (6) TEDIT + ‡
IRISSTREAM (8)§§	READNUMBER (2) COLOR (7) GACHAE-SF FONTS (9)
KERMITMENU(6)†	FREEMENU (12) CHAT (6)
KEYBOARDEDITOR (12)	ICONW (2) VIRTUALKEYBOARDS (11)
LOADIRIS(8)	ICONW (2)

	FREEMENU (12)
MATMULT(3)	CMLARRAY (4)
RS232CHAT(5)†	CHAT (6)
RS232CMENU(5)†	CHAT (6) FREEMENU (12)
SKETCH(3)	TEDIT + ‡ GRAPHZOOM (2) CMLARRAY (4)
TCPCHAT(5)†§	CHAT (6)
TEDIT(1)‡	
TTYCHAT(5)†	CHAT (6)
VIRTUALKEYBOARDS ICONW (2) (11)	

NOTES

+ Module consists of one or more additional files.

† Before attempting to load this module you must add {FLOPPY} to the list, LISPUSERSDIRECTORIES:

```
(SETQ LISPUSERSDIRECTORIES  
'({FLOPPY}))
```

‡ See specific module loading instructions above.

§ Once TCPCHAT has finished loaded you will be prompted:

Please enter the name of the IP
initialization file for this host.

Please consult the *Lisp Library Packages*
manual for information on the initialization
procedure.

§§ Before attempting to load Irisstream you must copy the SF font set to a random access device. Then set the variable IRISFONTDIRECTORIES to the place where you have your fonts.

[This page intentionally left blank]

Lisp Library Floppy Index

4045STREAM.DCOM	KOTO LIBRARY #7
BIG.DCOM	KOTO LIBRARY #2
BITMAPFNS.DCOM	KOTO LIBRARY #2
BROWSER.DCOM	KOTO LIBRARY #2
BUSEXTENDER.DCOM	KOTO LIBRARY #6
BUSMASTER.DCOM	KOTO LIBRARY #6
C150STREAM.DCOM	KOTO LIBRARY #7
CENTRONICS.DCOM	KOTO LIBRARY #7
CHAT.DCOM	KOTO LIBRARY #6
CHATTERMINAL.DCOM	KOTO LIBRARY #6
CHECKSET.DCOM	KOTO LIBRARY #12
CIRCLPRINT.DCOM	KOTO LIBRARY #1
CLASSIC10C0.C150FONT	KOTO LIBRARY #7
CLASSIC14C0.C150FONT	KOTO LIBRARY #7
CLASSIC18C10.C150FONT	KOTO LIBRARY #7
CML.DCOM	KOTO LIBRARY #4
CMLARITH.DCOM	KOTO LIBRARY #4
CMLARRAY.DCOM	KOTO LIBRARY #4
CMLARRAYINSPECTOR.DCOM	KOTO LIBRARY #4
CMLCHARACTER.DCOM	KOTO LIBRARY #4
CMLCOMPILE.DCOM	KOTO LIBRARY #4

CMLEXEC.DCOM	KOTO LIBRARY #4
CMLFLOATARRAY.DCOM	KOTO LIBRARY #4
CMLHELP.DCOM	KOTO LIBRARY #4
CMLPRETTY.DCOM	KOTO LIBRARY #4
CMLPRINT.DCOM	KOTO LIBRARY #4
CMLSETF.DCOM	KOTO LIBRARY #4
CMLSPECIALFORMS.DCOM	KOTO LIBRARY #4
CMLSTREAMS.DCOM	KOTO LIBRARY #4
CMLSTRUCT.DCOM	KOTO LIBRARY #4
CMLTYPES.DCOM	KOTO LIBRARY #4
COLOR.DCOM	KOTO LIBRARY #7
COLORDEMO.DCOM	KOTO LIBRARY #7
COMPILEBANG.DCOM	KOTO LIBRARY #4
COPYFILES.DCOM	KOTO LIBRARY #4
DANDELIONKEYBOARDS.	KOTO LIBRARY #11
DATABASEFNS.DCOM	KOTO LIBRARY #6
DECL.DCOM	KOTO LIBRARY #4
DES.DCOM	KOTO LIBRARY #10
DLS232C.DCOM	KOTO LIBRARY #5
DLTTY.DCOM	KOTO LIBRARY #5
DMCHAT.DCOM	KOTO LIBRARY #6
DORADOCOLOR.DCOM	KOTO LIBRARY #7
DORADOKEYBOARDS.	KOTO LIBRARY #11

DOVEKEYBOARDS.	KOTO LIBRARY #11
EDITBITMAP.DCOM	KOTO LIBRARY #2
ETHERRECORDS.	KOTO LIBRARY #7
EXPORTS.ALL	KOTO LIBRARY #11
FASTFX80STREAM.DCOM	KOTO LIBRARY #7
FILEBROWSER.DCOM	KOTO LIBRARY #8
FILECACHE.DCOM	KOTO LIBRARY #9
FONTSAMPLE.DCOM	KOTO LIBRARY #7
FONTSHEET1.IP	KOTO LIBRARY #7
FONTSHEET2.IP	KOTO LIBRARY #7
FONTSHEET3.IP	KOTO LIBRARY #7
FONTSHEET4.IP	KOTO LIBRARY #7
FONTSHEET5.IP	KOTO LIBRARY #7
FREEMENU.DCOM	KOTO LIBRARY #12
FTPSERVER.DCOM	KOTO LIBRARY #6
FX80STREAM.	KOTO LIBRARY #12
FX80STREAM.DCOM	KOTO LIBRARY #12
FXPRINTER.DCOM	KOTO LIBRARY #7
GACHAE.LC1-SF	KOTO LIBRARY #9
GACHAE.LC2-SF	KOTO LIBRARY #9
GACHAE.NUM-SF	KOTO LIBRARY #9
GACHAE.S1-SF	KOTO LIBRARY #9
GACHAE.S2-SF	KOTO LIBRARY #9

GACHAE.UC1-SF	KOTO LIBRARY #9
GACHAE.UC2-SF	KOTO LIBRARY #9
GCHAX.DCOM	KOTO LIBRARY #6
GRAPHER.DCOM	KOTO LIBRARY #2
GRAPHZOOM.DCOM	KOTO LIBRARY #2
HASH.DCOM	KOTO LIBRARY #6
HLCOLOR.DCOM	KOTO LIBRARY #7
HRULE.DCOM	KOTO LIBRARY #1
ICONW.DCOM	KOTO LIBRARY #2
IMAGEOBJ.DCOM	KOTO LIBRARY #2
INIT.NONET	KOTO LIBRARY #12
INIT.SAMPLE	KOTO LIBRARY #12
IRISCONSTANTS.DCOM	KOTO LIBRARY #8
IRISIO.DCOM	KOTO LIBRARY #8
IRISLIB.DCOM	KOTO LIBRARY #8
IRISNET.DCOM	KOTO LIBRARY #8
IRISSTREAM.DCOM	KOTO LIBRARY #8
KERMIT.	KOTO LIBRARY #6
KERMIT.DCOM	KOTO LIBRARY #6
KERMITMENU.DCOM	KOTO LIBRARY #6
KEYBOARDEDITOR.DCOM	KOTO LIBRARY #12
LABEL.DCOM	KOTO LIBRARY #4
LAMB DATRAN.DCOM	KOTO LIBRARY #4

LISTEN.DCOM	KOTO LIBRARY #4
LLCOLOR.DCOM	KOTO LIBRARY #7
LOADIRIS.DCOM	KOTO LIBRARY #8
MATMULT.DCOM	KOTO LIBRARY #3
MINISERVE.DCOM	KOTO LIBRARY #7
NSCHAT.DCOM	KOTO LIBRARY #6
NSMAINTAIN.DCOM	KOTO LIBRARY #10
PCALLSTATS.DCOM	KOTO LIBRARY #3
PUPCHAT.DCOM	KOTO LIBRARY #6
RDSYS.DCOM	KOTO LIBRARY #11
READAIS.DCOM	KOTO LIBRARY #12
READNUMBER.DCOM	KOTO LIBRARY #2
READNUMBER.DCOM	KOTO LIBRARY #10
READSYS.DCOM	KOTO LIBRARY #11
REMOTEVMEM.DCOM	KOTO LIBRARY #11
RS232CHAT.DCOM	KOTO LIBRARY #5
RS232CMENU.DCOM	KOTO LIBRARY #5
SAMEDIR.DCOM	KOTO LIBRARY #3
SFFONT.DCOM	KOTO LIBRARY #8
SIMPLIFY.DCOM	KOTO LIBRARY #4
SKETCH.DCOM	KOTO LIBRARY #3
SKETCHEDIT.DCOM	KOTO LIBRARY #3
SKETCHELEMENTS.DCOM	KOTO LIBRARY #3

SKETCHOBJ.DCOM	KOTO LIBRARY #3
SKETCHSTREAM.DCOM	KOTO LIBRARY #3
SPY.DCOM	KOTO LIBRARY #2
SYSEEDIT.	KOTO LIBRARY #4
TABLEBROWSER.DCOM	KOTO LIBRARY #8
TCP.DCOM	KOTO LIBRARY #5
TCPCHAT.DCOM	KOTO LIBRARY #5
TCPCONFIG.DCOM	KOTO LIBRARY #5
TCPDEBUG.DCOM	KOTO LIBRARY #5
TCPFTP.DCOM	KOTO LIBRARY #5
TCPHTE.DCOM	KOTO LIBRARY #5
TCPLLAR.DCOM	KOTO LIBRARY #5
TCPLLICMP.DCOM	KOTO LIBRARY #5
TCPLLIP.DCOM	KOTO LIBRARY #5
TCPNAMES.DCOM	KOTO LIBRARY #5
TCPTFTP.DCOM	KOTO LIBRARY #5
TCPUUDP.DCOM	KOTO LIBRARY #5
TEDIT.DCOM	KOTO LIBRARY #1
TEDITABBREV.DCOM	KOTO LIBRARY #2
TEDITCHAT.DCOM	KOTO LIBRARY #6
TEDITCOMMAND.DCOM	KOTO LIBRARY #2
TEDITFILE.DCOM	KOTO LIBRARY #2
TEDITFIND.DCOM	KOTO LIBRARY #2

TEDITFNKEYS.DCOM	KOTO LIBRARY #2
TEDITHCPY.DCOM	KOTO LIBRARY #1
TEDITHISTORY.DCOM	KOTO LIBRARY #1
TEDITLOOKS.DCOM	KOTO LIBRARY #1
TEDITMENU.DCOM	KOTO LIBRARY #1
TEDITPAGE.DCOM	KOTO LIBRARY #2
TEDITSCREEN.DCOM	KOTO LIBRARY #1
TEDITSELECTION.DCOM	KOTO LIBRARY #2
TEDITWINDOW.DCOM	KOTO LIBRARY #1
TEK4010CHAT.DCOM	KOTO LIBRARY #6
TELERAID.DCOM	KOTO LIBRARY #11
TEXEC.DCOM	KOTO LIBRARY #6
TEXTOFD.DCOM	KOTO LIBRARY #2
TFBRAVO.DCOM	KOTO LIBRARY #1
TIMESROMAN.LC1-SF	KOTO LIBRARY #10
TIMESROMAN.LC2-SF	KOTO LIBRARY #10
TIMESROMAN.NUM-SF	KOTO LIBRARY #10
TIMESROMAN.S1-SF	KOTO LIBRARY #10
TIMESROMAN.S3-SF	KOTO LIBRARY #10
TIMESROMAN.UC1-SF	KOTO LIBRARY #10
TIMESROMAN.UC2-SF	KOTO LIBRARY #10
TIMESROMAN10C0.C150FONT	KOTO LIBRARY #7
TIMESROMAN12C0.C150FONT	KOTO LIBRARY #7

TIMESROMAN14C0.C150FONT	KOTO LIBRARY #7
TTYCHAT.DCOM	KOTO LIBRARY #5
VIRTUALKEYBOARDS.DCOM	KOTO LIBRARY #11
VMEM.DCOM	KOTO LIBRARY #11
VT100KP.DCOM	KOTO LIBRARY #6
VTCHAT.DCOM	KOTO LIBRARY #6
WHEREIS.DCOM	KOTO LIBRARY #6

HelpSys Floppy Index

CHAPACK.TXT	KOTO HELPSYS #5
CHAPARRAYS.TXT	KOTO HELPSYS #4
CHAPBREAKING.TXT	KOTO HELPSYS #5
CHAPCLISP.TXT	KOTO HELPSYS #1
CHAPCOMPILER.TXT	KOTO HELPSYS #1
CHAPCONTROLFNS.TXT	KOTO HELPSYS #3
CHAPDWIM.TXT	KOTO HELPSYS #4
CHAPEDITOR.TXT	KOTO HELPSYS #1
CHAPERROES.TXT	KOTO HELPSYS #1
CHAPETHER.TXT	KOTO HELPSYS #4
CHAPEXEC.TXT	KOTO HELPSYS #3
CHAPFILES.TXT	KOTO HELPSYS #5
CHAPFNDEF.TXT	KOTO HELPSYS #4
CHAPFP.TXT	KOTO HELPSYS #2
CHAPGRAPHICS.TXT	KOTO HELPSYS #3
CHAPHARDCOPY.TXT	KOTO HELPSYS #5
CHAPHASHARRAYS.TXT	KOTO HELPSYS #6
CHAPINTRO.TXT	KOTO HELPSYS #5
CHAPIO.TXT	KOTO HELPSYS #4
CHAPLISTS.TXT	KOTO HELPSYS #6
CHAPLITATOMS.TXT	KOTO HELPSYS #6

CHAPMASTERSCOPE.TXT	KOTO HELPSYS #4
CHAPMISC.TXT	KOTO HELPSYS #2
CHAPNUMBERS.TXT	KOTO HELPSYS #1
CHAPPERFORMANCE.TXT	KOTO HELPSYS #5
CHAPPROCESSES.TXT	KOTO HELPSYS #5
CHAPRECORDPACKAGE.TXT	KOTO HELPSYS #5
CHAPSTACK.TXT	KOTO HELPSYS #2
CHAPSTRINGS.TXT	KOTO HELPSYS #5
CHAPTERMINAL.TXT	KOTO HELPSYS #5
CHAPUSERIO.TXT	KOTO HELPSYS #3
CHAPWINDOWS.TXT	KOTO HELPSYS #2
DINFO.DCOM	KOTO HELPSYS #6
HELPSYS.DCOM	KOTO HELPSYS #6
IRM.DINFOGRAPH	KOTO HELPSYS #6
IRM.HASHFILE	KOTO HELPSYS #7
IRM.HASHFILE	KOTO HELPSYS #8
IRM.HASHFILE	KOTO HELPSYS #9
IRMTOP.TXT	KOTO HELPSYS #6