

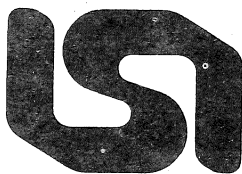

ADM 36 **Video Display Terminal** **Users Reference Manual**

LEAR SIEGLER, INC.
DATA PRODUCTS DIVISION
714 NORTH BROOKHURST STREET, ANAHEIM, CALIFORNIA, 92803

ADM 36
Video Display Terminal



LEAR SIEGLER, INC.

USERS REFERENCE
MANUAL

TABLE OF CONTENTS

SECTION	PAGE	
I	GENERAL DESCRIPTION	1-1
1.1	INTRODUCTION	1-1
1.2	PURPOSE AND USE	1-1
1.3	DESCRIPTION	1-1
1.3.1	Features	1-1
1.4	SPECIFICATIONS	1-6
1.5	OPTIONS	1-6
1.5.1	15 Inch Display Option	1-6
1.5.2	Composite Video Option	1-6
1.5.3	Tilt Mechanism Option	1-6
1.5.4	International Keycap Option	1-6
1.5.5	Integral Modem Option	1-6
1.6	RELATED DOCUMENTS	1-6
II	INSTALLATION	2-1
2.1	INTRODUCTION	2-1
2.2	SAFETY REQUIREMENTS	2-1
2.3	UNPACKING AND INITIAL INSPECTION	2-1
2.4	SITE REQUIREMENTS	2-1
2.5	LINE VOLTAGE SELECTION	2-2
2.6	SET-UP MODE	2-2
2.6.1	SET-UP A Mode	2-4
2.6.2	SET-UP B Mode	2-5
2.6.3	SET-UP Mode Keys	2-7
2.6.3.1	Clear All Tabs (3) Key	2-7
2.6.3.2	Line Local (4) Key	2-7
2.6.3.3	Receive Speed (8) Key	2-7
2.6.3.4	Reset (0) Key	2-7
2.6.3.5	Set Clear Tab (2) Key	2-7
2.6.3.6	SET-UP A/B (5) Key	2-8
2.6.3.7	Toggle (6) Key	2-8
2.6.3.8	Transmit Speed (7) Key	2-8
2.6.3.9	80/132 Columns (9) Key	2-8

TABLE OF CONTENTS (cont'd)

SECTION	PAGE
2.6.4 SAVE SET-UP FEATURES	2-8
2.6.5 Recall SET-UP Features	2-8
2.6.6 Default SET-UP Features	2-9
2.6.7 Default Tabs	2-9
2.6.8 Reset The Terminal	2-9
2.6.9 SET-UP Features	2-9
2.6.9.1 Answerback	2-9
2.6.9.2 Auto Repeat	2-10
2.6.9.3 Auto X-ON/X-OFF	2-10
2.6.9.4 Background	2-10
2.6.9.5 Bits Character	2-10
2.6.9.6 Character Set	2-11
2.6.9.7 Characters/Row	2-11
2.6.9.8 Cursor Mode	2-11
2.6.9.9 Flag	2-11
2.6.9.10 Keyboard Type	2-11
2.6.9.11 Keyclick	2-11
2.6.9.12 Line Frequency	2-11
2.6.9.13 Line Mode	2-11
2.6.9.14 Margin Bell	2-11
2.6.9.15 New Line	2-11
2.6.9.16 Parity	2-11
2.6.9.17 Parity Sense	2-12
2.6.9.18 Printer Baud Rate	2-12
2.6.9.19 Printer Bits Character	2-12
2.6.9.20 Printer Handshake	2-12
2.6.9.21 Printer Parity	2-12
2.6.9.22 Printer Parity Sense	2-12
2.6.9.23 Printer Stop Bits	2-12
2.6.9.24 Print Extent	2-12
2.6.9.25 Print Terminator	2-12
2.6.9.26 Receive Baud Rate	2-12
2.6.9.27 Scroll Mode	2-13
2.6.9.28 Stop Bits	2-13
2.6.9.29 Terminal Mode	2-13
2.6.9.30 Transmit Baud Rate	2-13
2.6.9.31 Wrap-Around	2-13
2.6.9.32 80/132 Clear Page	2-13
2.6.10 Self/Test Mode	2-13
2.6.10.1 Self-Test Error Messages	2-13
2.6.11 Problem Checklist	2-14
2.6.12 Strapping Options	2-15
2.7 INTERFACE INFORMATION	2-15
2.7.1 RS-232C (Modem) Inteface	2-15
2.7.2 RS-422A (Modem) Interface	2-15
2.7.3 20mA Current Loop (Modem) Inteface	2-15
2.7.4 Printer Port Interface	2-15

TABLE OF CONTENTS (cont'd)

SECTION	PAGE
2.8 INSTALLING THE ADM 36	2-20
2.9 POWER TURN-ON	2-20
2.10 POWER TURN-OFF	2-20
2.11 CARE OF THE ADM 36	2-20
2.11.1 Cleaning	2-20
2.11.2 Inspection	2-20
III OPERATION	3-1
3.1 INTRODUCTION	3-1
3.2 KEYBOARD	3-1
3.2.1 Auto Repeating Keys	3-1
3.2.2 Alphabetic Keys	3-1
3.2.2.1 Caps Lock Key	3-1
3.2.2.2 Shift Key	3-1
3.2.2.3 Numeric And Special Character Keys	3-2
3.2.4 Special Control	3-2
3.2.4.1 Backspace Key	3-2
3.2.4.2 Delete Key	3-2
3.2.4.3 ESC Key	3-2
3.2.4.4 Linefeed Key	3-2
3.2.4.5 Return Key	3-5
3.2.4.6 Space Bar	3-5
3.2.4.7 Tab Key	3-5
3.2.5 Cursor Control Keys	3-6
3.2.6 Special Function Keys	3-6
3.2.6.1 Break Key	3-6
3.2.6.2 CTRL (Control) Key	3-7
3.2.6.3 ENTER Key	3-7
3.2.6.4 NO SCROLL Key	3-8
3.2.6.5 SET-UP Key	3-9
3.2.7 Numeric (Auxiliary) Keypad	3-9
3.2.8 Indicator Lights	3-10
3.2.8.1 On/OFF Line Indicator Light	3-10
3.2.8.2 KBD Locked Light	3-10
3.2.8.3 L1-L4 Indicator Lights	3-10
3.3 SPECIAL GRAPHICS AND CHARACTER SETS	3-10
3.3.1 Special and Wide Point Graphics Character Sets	3-10
3.3.2 European Character Sets	3-11
3.4 CONTROL FUNCTIONS	3-11
3.4.1 Control Character	3-11
3.4.2 ANSI Control Sequences Mode	3-15

TABLE OF CONTENTS (cont'd)

SECTION	PAGE
3.5 SPECIAL GRAPHICS AND CHARACTER SET SELECTION	3-18
3.5.1 LSIDHL - Double-High Line (LSI Private)	3-18
3.5.2 LSIDWL - Double-Wide Line (LSI Private)	3-18
3.5.3 SCS - Select Character Set	3-18
3.5.4 LSIWSHL - Single-Wide, Single-High Line	3-18
3.6 CURSOR FUNCTIONS	3-19
3.6.1 CUB - Cursor Backward	3-19
3.6.2 CUD - Cursor Down (No Scroll)	3-19
3.6.3 CUF - Cursor Forward	3-19
3.6.4 CUP - Cursor Position	3-19
3.6.5 CPR - Cursor Position Report	3-20
3.6.6 CUU - Cursor Up (No Scroll)	3-20
3.6.7 HVP - Horizontal and Vertical Position (Set Cursor)	3-20
3.6.8 IND - Index (Cursor Down With Scroll)	3-20
3.6.9 NEL - New Line With Scroll	3-20
3.6.10 LSICRC - Restore Cursor and Attributes (LSI Private)	3-21
3.6.11 RI - Reverse Index (Cursor Up With Scroll)	3-21
3.6.12 LSICSC - Save Cursor and Attributes (LSI Private)	3-21
3.8 KEYPAD MODES	3-21
3.8.1 LSIKPAM - Keypad Applicatin Mode (LSI Private)	3-21
3.8.2 LSIKPNM - Keypad Numeric Mode	3-21
3.9 SCREEN CONTROL AND EDIT FUNCTIONS	3-21
3.9.1 DAQ - Define Area Qualification	3-21
3.9.2 DL - Delete Line	3-21
3.9.3 DCH - Delete Character	3-22
3.9.4 ED - Erase In Display	3-22
3.9.5 EL - Erase In Line	3-22
3.9.6 HTS - Horizontal Tabulation Set	3-22
3.9.7 IL - Insert Line	3-22
3.9.8 SGR - Select Graphics Rendition	3-23
3.9.9 LSIALN - Screen Alignment (LSI Private)	3-23
3.9.10 LSISTBM - Set Top and Bottom Margins (LSI Private)	3-23
3.9.11 TBC - Tabulation Clear	3-23
3.10 SET/RESET MODE	3-23
3.10.1 RM - Reset Mode	3-24
3.10.2 SM - Set Mode	3-24
3.11 MODES APPLICABLE TO SET/RESET	3-24
3.11.1 LSIANM - ANSI/VT-52 Mode - (LSI Private)	3-25
3.11.2 LSIARM - Auto Repeat Mode (LSI Private)	3-25
3.11.3 LSICKM - Cursor Keys Mode (LSI Private)	3-25
3.11.4 LSIICOLM - Column Mode (LSI Private)	3-25
3.11.5 ERM - Erasure Mode	3-25

TABLE OF CONTENTS (cont'd)

SECTION	PAGE
3.11.6 LSIFF - Form Feed Mode (LSI Private)	3-25
3.11.7 IRM - Inset/Replacement Mode	3-26
3.11.8 LNM - Line Feed/New Line Mode	3-26
3.11.9 LSIOM - Origin Mode (LSI Private)	3-26
3.11.10 LSIEXT - Print Extent Mode (LSI Private)	3-27
3.11.11 LSI SCLM - Scrolling Mode (LSI Private)	3-27
3.11.12 LSI SCNM - Screen Mode (LSI Private)	3-27
3.11.13 LSIWM - Wrap-around Mode (LSI Private)	3-27
3.12 OUTPUT AND PRINT FUNCTIONS	3-27
3.12.1 DSR - Device Status Report	3-27
3.12.2 MC - Media Copy	3-28
3.13 LED CONTROL FUNCTIONS	3-28
3.13.1 LSILL - Load LEDs (LSI Private)	3-28
3.14 HOST/TERMINAL STATUS AND CONTROL FUNCTIONS	3-29
3.14.1 DA - Device Attributes	3-29
3.14.2 LSIID - Identity Terminal (LSI Private)	3-29
3.14.3 LSITST - Invoke Self-Test (LSI Private)	3-29
3.14.4 LSIREPTPARM - Report Terminal Parameters (LSI Private)	3-29
3.14.5 LSIREQTPARM - Request Terminal Parameters	3-31
3.14.6 RIS - Reset (Terminal) To Initial State	3-31
3.15 VT-52 MODE CONTROL SEQUENCES	3-31
3.15.1 Cursor Up	3-32
3.15.2 Cursor Down	3-32
3.15.3 Cursor Left	3-32
3.15.4 Cursor Right	3-32
3.15.5 Cursor To Home	3-32
3.15.6 Cursor Up With Scroll	3-32
3.15.7 Direct Cursor Address	3-32
3.15.8 Enter Alternate Keypad Mode	3-32
3.15.9 Enter ANSI Mode	3-32
3.15.10 Enter Graphics Mode	3-32
3.15.11 Erase to End of Line	3-32
3.15.12 Erase to End of Screen	3-33
3.15.13 Exit Alternate Keypad Mode	3-33
3.15.14 Exit Graphic Mode	3-33
3.15.15 Identify	3-33
3.15.16 Inverse Video	3-33
3.15.17 Normal Video	3-33
3.15.18 Print Cursor Line Function	3-33
3.15.19 Print Screen Function	3-33
3.15.20 Select Auto Print (Line-at-a-Time) Mode	3-33
3.15.21 Select Printer Controller Mode	3-33
3.15.22 Terminate Auto Print (Line-at-a-Time) Mode	3-33
3.15.23 Terminal Printer Controller Mode	3-33

TABLE OF CONTENTS (cont'd)

LIST OF FIGURES

FIGURE		PAGE
1-1	ADM 36 Video Display Terminal shown with optional 15 inch screen	1-0
1-2	ADM 36 USASCII Character Format (By Ascending ASCII Codes) with HEX CODE	1-2
1-3	ADM 36 Keyboard Layouts	1-3
2-1	ADM 36 Mounting Requirements	2-2
2-2	SET-UP Mode Memory Structure	2-3
2-3	SET-UP A Mode Display Screen	2-4
2-4	SET-UP B Mode Display Screen	2-5
2-5	Keys Used in the SET-UP Mode	2-7
2-6	Typical ADM 36 Applications	2-16
2-7	ADM 36 Panel Controls	2-17
2-8	RS-232C (Modem) Interface Logic	2-18
2-9	RS-422A (Modem) Interface Logic	2-18
2-10	20mA Current Loop (Modem) Interface Logic	2-19
2-11	Printer Interface Logic	2-19
3-1	ADM 36 Keyboard	3-2
3-2	ADM 36 Indicator Lights	3-10
3-3	Basic Elements of the ANSI Control Sequences Format	3-15

TABLE OF CONTENTS (cont'd)

LIST OF TABLES

TABLE	PAGE
1-1 ADM 36 Specifications	1-7
2-1 SET-UP B Mode Terminal Features Summary	2-6
2-2 SET-UP Mode Keys Summarized	2-8
2-3 Problem Checklist	2-14
3-1 Alphabetic Key Codes	3-3
3-2 Numeric and Special Character Codes	3-4
3-3 Special Control Key Codes	3-5
3-4 Cursor Control Key Code Sequence	3-6
3-5 Control Codes generated by the CTRL key in conjunction with another key	3-7
3-6 SET-UP Features Changeable by the Host Computer	3-8
3-7 Numeric Keypad Codes	3-9
3-8 US/UKASCII and European Character Sets	3-11
3-9 Special Graphics and Wide Point Graphics Character Sets	3-11
3-10 Control Characters Received From Host	3-14
3-11 ANSI Control Sequences Summary	3-16
3-12 Set/Reset Mode Control Sequence Parameters	3-24
3-13 Report Terminal Parameters	3-30
3-14 VT-52 Mode Escape Sequence Summary	3-31

APPENDIX

ASCII CONTROL CODE CHART	A-1
SET-UP MODE KEYS SUMMARIZED	A-2
SPECIAL GRAPHICS AND WIDE POINT GRAPHICS CHARACTER SET	A-3
ANSI CONTROL SEQUENCES SUMMARY	A-4
VT-52 MODE ESCAPE SEQUENCE SUMMARY	A-5

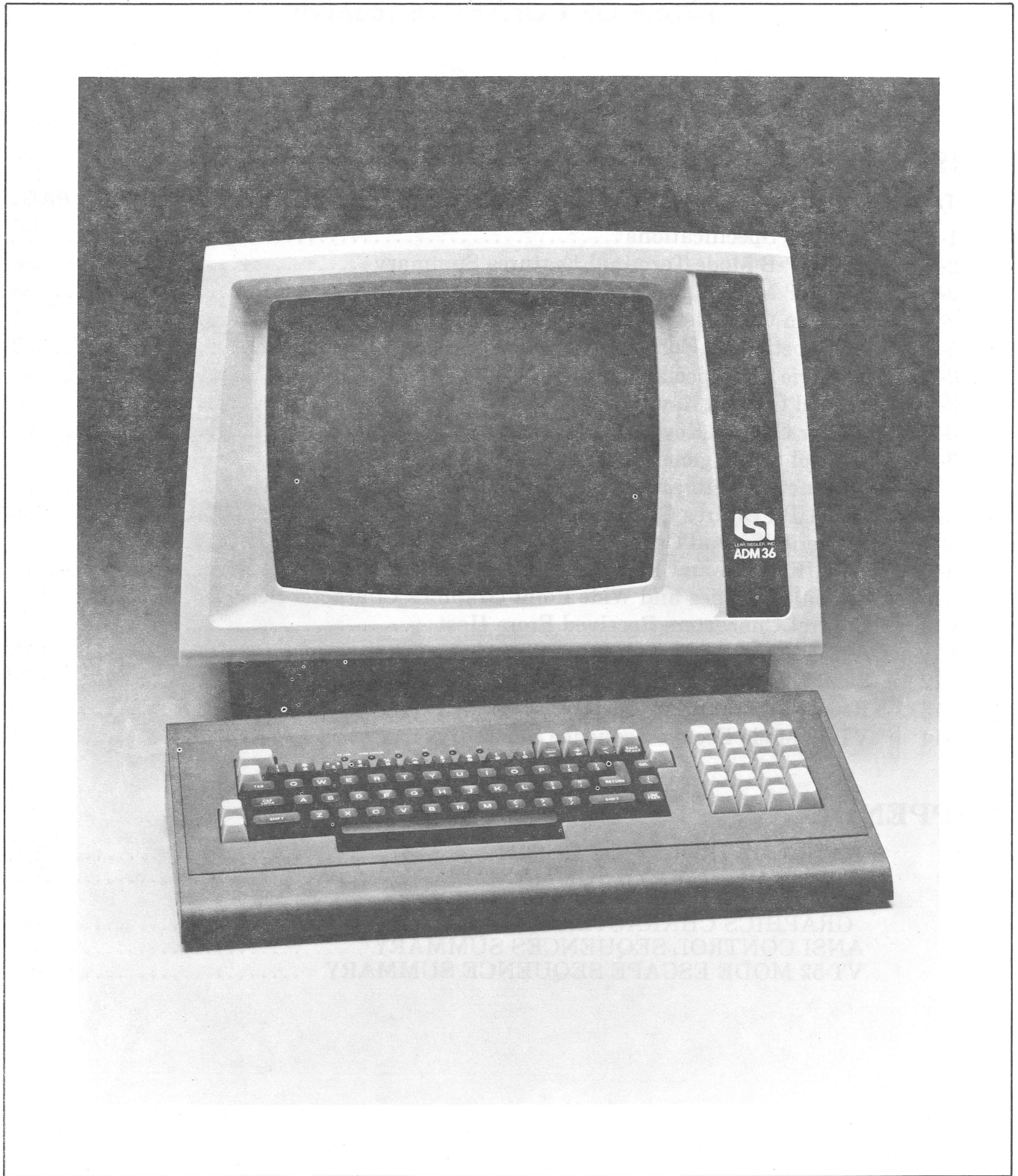

Figure 1-1. ADM 36 Video Display Terminal (shown with optional 15 inch screen)

SECTION I GENERAL DESCRIPTION

1.1 INTRODUCTION

This section describes the primary functions of the Lear Siegler ADM 36 Video Display Terminal (figure 1-1), along with its physical dimensions, specifications, and operating features.

1.2 PURPOSE AND USE

There are numerous applications of the ADM 36, all involving the transfer of data. Data transfer in some applications may be almost exclusively unidirectional either from the unit to the computer, or from the computer to the unit. A more frequent application, however, is one in which an operator communicates with a computer, and the computer responds in accordance with its stored program.

1.3 DESCRIPTION

The ADM 36 is a complete stand alone data terminal consisting of a Monitor Unit, and a separate Keyboard Unit. Both units contain two section lightweight enclosures which house the required circuits associated with their individual functions. At the rear of the Monitor Unit are the interface connectors, fuse, power cord, ON/OFF switch, and Keyboard connector.

The standard display screen is a 12-inch (30.5cm) diagonal CRT. The display format consists of an 80-character x 24-line or 132-character x 24-line page. Figure 1-2 shows the standard 96 character USASCII format (with HEXadecimal codes) employed by the ADM 36.

1.3.1

The ADM 36 includes the following features:

ANSI x 3.41-1974 and x 3.64-1979 code compatibility

- Full Duplex RS-232, RS-422, and 20mA Current Loop Communications Port

- Asynchronous Serial Printer Port
- Two display formats: 80x24 or 132x24
- Non-Embedded Visual Attributes: blink, bold, underline, reduced, reverse, double high, double wide, and protected
- Eight selectable character sets including: USASCII, UKASCII, Spanish, French, German, Italian, Norwegian/Danish, and Swedish/Finnish
- Line drawing (Business Graphics) and wide point (132x120) Graphics
- 7x9 character matrix, with descenders, in a 9x10 field. All points programmable through a 2716 PROM. (For example, continuous Arabic characters may be user programmed).
- Smooth or Jump Scroll
- User defineable horizontal split screen
- Non-volatile RAM stores all operating parameters. No switches need be set by the user. Features are changed via the keyboard in SET-UP mode, using "English Legend" prompts on the display.
- A fast Z80 CPU and fast RAMs allow operation to 4800 baud with no X-ON/X-OFF cycles. No display flicker during screen reading or writing.
- 256 character F1F0
- Video output option RS-170 compatible, standard monitors may be used; 25 MHz minimum bandwidth required for 132 character operation. Keyboard programmable brightness level.
- 50/60 Hz operation

20	21	22	23	24	25	26	27	28	29	2A	2B	2C	2D	2E	2F
	!	"	#	\$	%	&	'	()	*	+	,	-	.	/
30	31	32	33	34	35	36	37	38	39	3A	3B	3C	3D	3E	3F
0	1	2	3	4	5	6	7	8	9	:	;	<	=	>	?
40	41	42	43	44	45	46	47	48	49	4A	4B	4C	4D	4E	4F
@	A	B	C	D	E	F	G	H	I	J	K	L	M	N	O
50	51	52	53	54	55	56	57	58	59	5A	5B	5C	5D	5E	5F
P	Q	R	S	T	U	V	W	X	Y	Z	[\]	^	_
60	61	62	63	64	65	66	67	68	69	6A	6B	6C	6D	6E	6F
`	a	b	c	d	e	f	g	h	i	j	k	l	m	n	o
70	71	72	73	74	75	76	77	78	79	7A	7B	7C	7D	7E	7F
p	q	r	s	t	u	v	w	x	y	z	{		}	~	

Figure 1-2. ADM 36 USASCII Character Format (By Ascending ASCII Codes) with HEX Code

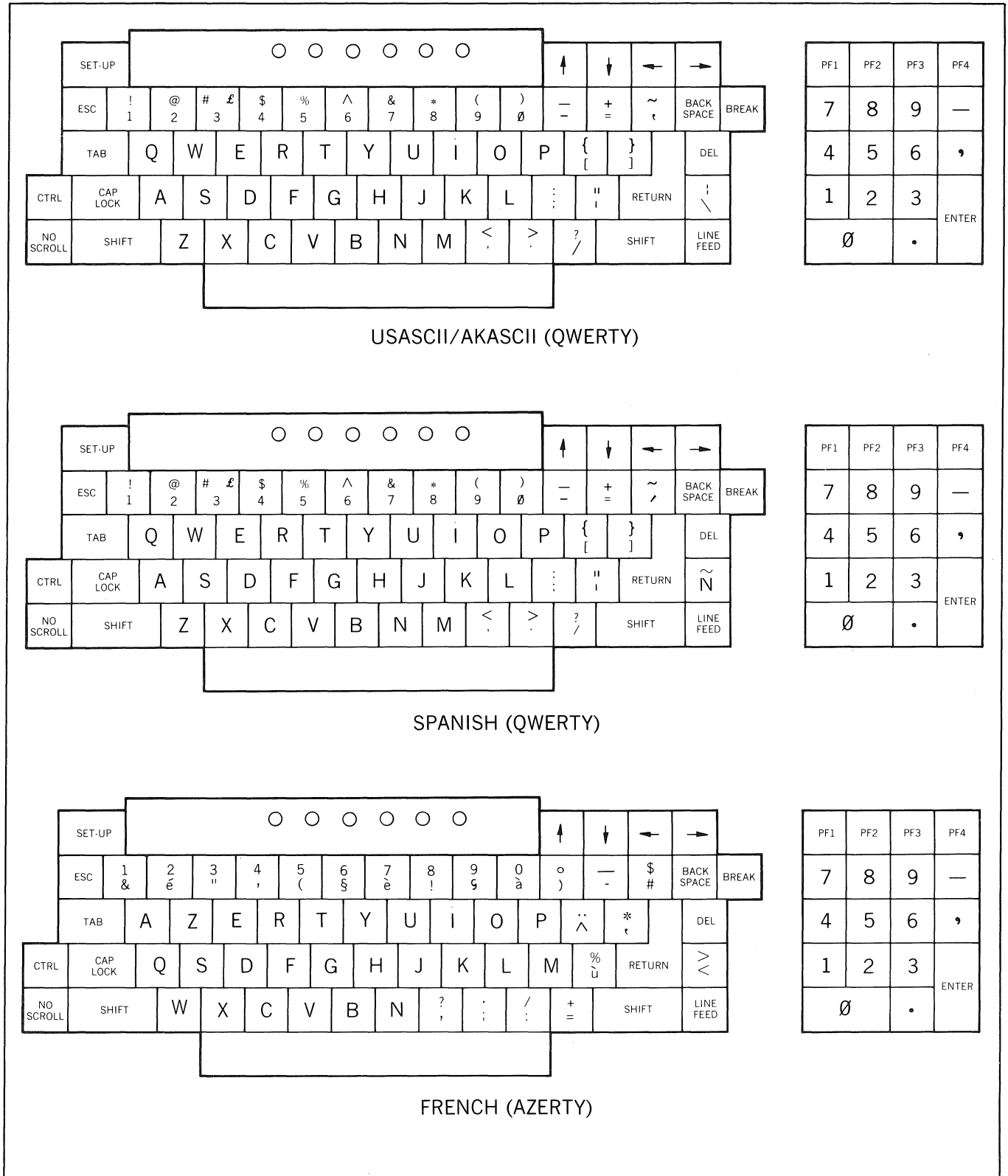
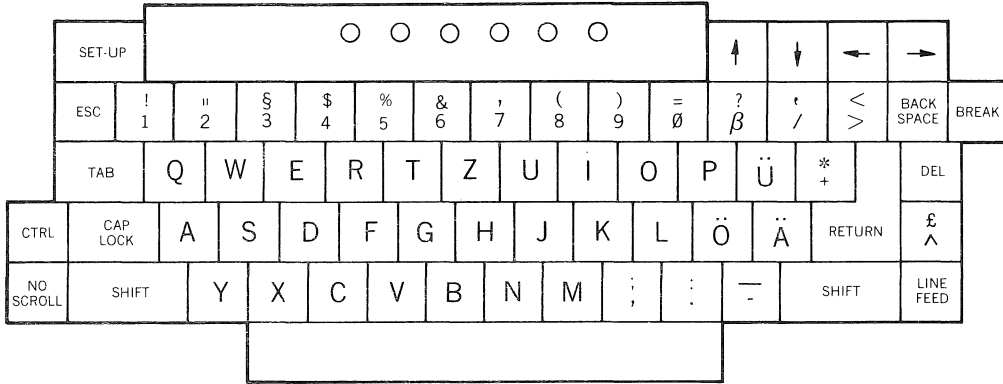
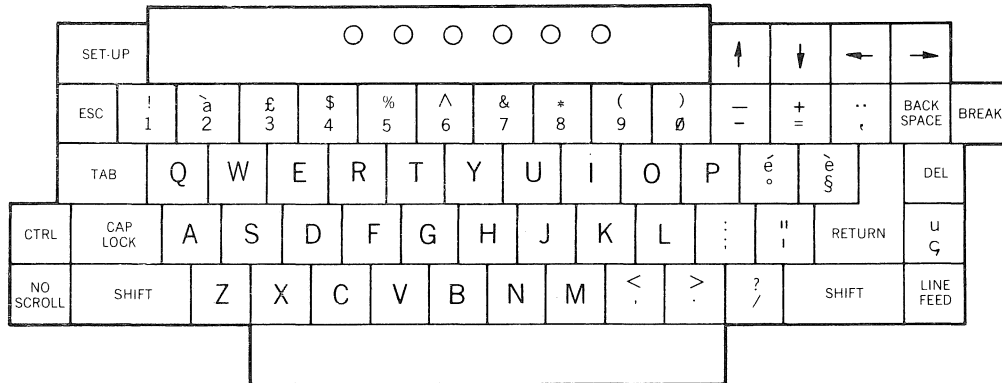

Figure 1-3. ADM 36 Keyboard Layouts



GERMAN (QWERTZ)



ITALIAN (QWERTY)

Figure 1-3. ADM 36 Keyboard Layouts (continued)

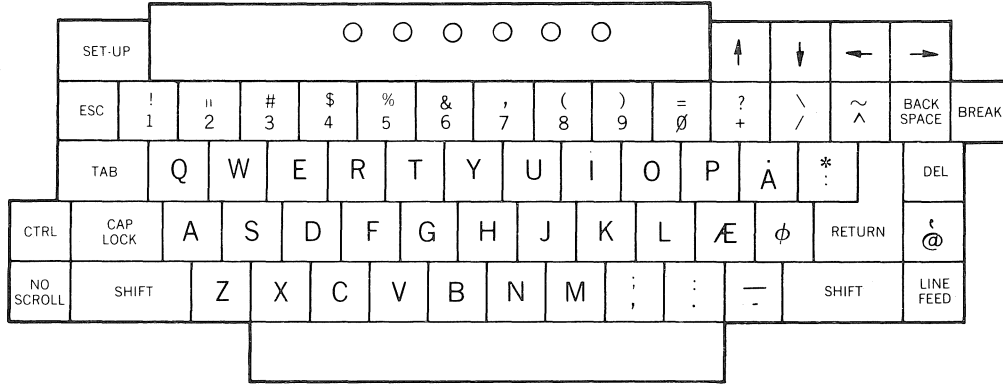

NORWEGIAN/DANISH (QWERTY)

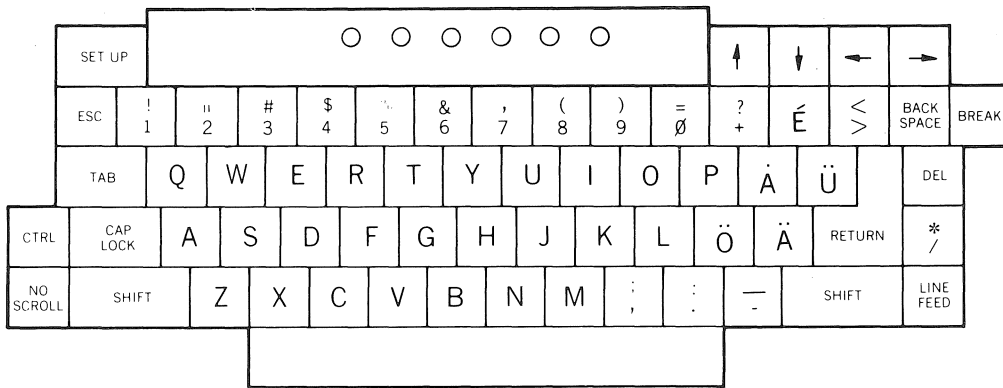

SWEDISH/FINNISH (QWERTY)

Figure 1-3. ADM 36 Keyboard Layouts (continued)

1.4 SPECIFICATIONS

Table 1-1 lists the specifications for the ADM 36.

1.5 OPTIONS

The ADM 36 can be equipped with several options, each requiring additions and/or modifications to the standard configuration of the unit. Following is a list of the options available for the ADM 36.

1.5.1 15 Inch Display Option

The ADM 36 can be ordered with an optional 15 inch (38.1cm) diagonal display. Display format remains the same - 80 characters x 24 lines or 132 characters x 24 lines.

1.5.2 Composite Video Option

The Composite Video Option provides the capability of driving an external display monitor. The signal levels and timing are RS-170 compatible. For proper operation at 132 columns, a monitor with a minimum of 25 MHz bandwidth is required.

1.5.3 Tilt Mechanism Option

The display tilt mechanism option allows the display to be placed in one of six positions. Adjustment range is from 10 degrees back to 5 degrees forward of vertical.

1.5.4 International Keycap Option

The international keycap set provides the capability of using a "QWERTY," "QWERTZ," or "AZERTY" style keyboard layout. The keycap set also includes the special character keycaps that are used by languages other than English. Refer to figure 1-3 for illustrations of the various keyboard layouts and associated keycap legend changes.

1.5.5 Integral Modem Option

The integral modem option allows the ADM 36 to be interfaced directly to a telephone line (no telephone required) for remote communications. The modem is compatible with 103 and 212A type modems utilizing full duplex operation, the modem is controlled through the ADM 36 keyboard and uses the CRT to display status conditions.

1.6 RELATED DOCUMENTS

ADM 36 Maintenance Manual (and Illustrated Parts Catalog.)

Table 1-1. ADM 36 Specifications

DISPLAY

CRT Screen: 12-inch (30.5-cm) diagonal, P4 Phosphor or P31 Green Phosphor with etched faceplate

Vertical Refresh Rate: 50 Hz or 60 Hz, depending on line frequency; non-interlaced

Horizontal Refresh Rate: 15.7 kHz

Display Format: 80 characters/line x 24 lines or
132 characters/line x 24 lines

Display Area: 5.5 inches (13.9 cm) high x 7.75 inches (19.7cm) wide

Character Set: 96 ASCII characters

Character Matrix: 7 x 9 dot matrix (plug full 2-dot descenders)

Character Field: 9 x 10 dot matrix (6 mm high x 3 mm wide)

Cursor: 9 x 10 dot matrix, reverse image block cursor

Cursor Control: Backspace, Forespace, Up, Down, Tab, Return, Read Cursor, Cursor Addressing, and Line Feed

Visual Attributes: (Non-embedded) Blink, bold, reverse video, underline, reduced, protected fields displayed in reduced intensity, double high and double wide

KEYBOARD FUNCTIONS

Keyboard: 26-letter alphabet with upper & lower case, numerics 0 thru 9; Punctuation, Return, Backspace, Tab, Shift, Caps Lock. Most keys are auto repeating (approximately 30 characters/second)

Numeric Key Pad: 18 keys, 0 thru 9, Enter, Comma, Period, Minus, and four function keys

Cursor Control: Individual Cursor control keys

Functional Command Keys: SET-UP, Break, ESCape, Delete (DEL), Control, No Scroll, and Line Feed

FORMATTING AIDS

Protect Mode: Screen formatting of protected and unprotected fields displayed in dual intensity

Edit Operations: Clear entire screen to spaces, clear unprotected positions to spaces, character insert by line, character delete by line, line insert, line delete, erase line to spaces, and erase page to spaces. All edit operations can be activated remotely by the host using ESCape sequences.

TRANSMISSION MODES

Conversation Mode: Conversation mode/full-duplex operation, characters are transmitted as they are typed on the keyboard. (Host must echo the character to be displayed when the ADM 36 is on-line.

Control Characters: All Control characters may be transmitted to computer

Interface Levels: RS-232C (V.24): +/- 12V per RS-232C specification
RS-422: 5 volts per RS-422 specification
Current Loop: Input 20mA = MAX (12V)
10mA = ON (4.1V)
5mA = OFF (1.5V)
470 + 1.8V equivalent input impedance reversal protected.
Output - 40V open circuit MAX.
100mA MAX

Data Rates: 50, 75, 110, 134.5, 150, 200, 300, 600, 1200, 1800, 2000, 2400, 3600, 4800, 7200, 9600, 19200 Baud

Parity: Even, odd or none

Video Interface: RS-170 Output:
AC coupled (200 uF)
75 ohm impedance
2V peak to peak (.4V sync.)
Composite Sync and Video
Non-interlaced
60 Hz H = 15.737 KHz (262 lines)
50 Hz V = 60.06 Hz

50 Hz H = 15.585 KHz (312 lines)
V = 49.952 Hz

Dot Frequency:
14.7 Mhz @ 80 char/line
24.3 Mhz @ 132 char/line

Non-composite sync. output:
TTL Vertical sync. pulse
TTL Horizontal sync. pulse
Analog video signal

Table 1-1. ADM 36 Specifications (continued)

OPERATING ENVIRONMENT

5°C to 40°C(41°F to 104°F): 5% to 95% relative humidity without condensation

Power Requirements:

Standard: 115V 10%, 60 Hz
Optional: 230V 10%, 50 Hz

Heat Dissipation: 222 BTU/HR

Dimensions - Monitor Unit

Width: 18.0 inches (45.7 cm)
Depth: 13.5 inches (34.3 cm)
Height: 15.5 inches (39.4 cm)

Dimensions - Keyboard Unit

Width: 18.0 inches (45.7 cm)
Depth: 9.0 inches (22.9 cm)
Height: 2.8 inches (7.0 cm)

Weight: 28 pounds (12.60 kg) (Total)

OPTIONS

Display Tilt Mechanism
15-inch (38.1 cm) diagonal display
P-31 green phosphor (No Cost)
Micro Program Source Code Listing
Output Cables
Clear or blank key caps
Special paint
Key locks

SECTION II INSTALLATION

2.1 INTRODUCTION

This section contains installation instructions for the ADM 36. Also included are descriptions of on-site safety requirements, initial set-up, communications interfaces, plus procedures for power turn-on/self test, power turn-off and routine maintenance.

2.2 SAFETY REQUIREMENTS

No special safety precautions are required for ADM 36 installation.

2.3 UNPACKING AND INITIAL INSPECTION

Each ADM 36 is thoroughly inspected and carefully packaged prior to shipment. Every precaution is taken to ensure that each unit is complete and ready for installation at the customer's site. However, it is recommended that each unit be inspected upon receipt for transit damage. Start by examining the exterior of the package for evidence of rough or careless handling; then perform a thorough visual inspection of the internal components and subassemblies. As a rule, more transportation companies will not honor claims for damage unless they are filed promptly; therefore, the following steps should be taken:

1. Verify that each item shown on the Sales Order Packing Slip has been included in the shipment. Contact Lear Siegler or your distributor immediately in the event of packing shortage.
2. Verify that the serial number of the unit corresponds to that shown on the invoice.
3. Check the hardware to determine if any assemblies or screws were loosened during shipment. Tighten as required.

4. Inspect for dust or foreign material which may impair electrical contact when cable connections are made. Vacuum to remove any loose dirt.
5. Install and test the ADM 36 as soon as possible after delivery. (This is very important since internal damage to the equipment cannot be determined by visual inspection alone).
6. If, in your opinion, the equipment has been damaged - either internally or externally - notify the agent of the transportation company immediately, and ask him to make an inspection. If assistance is needed to describe the extent of the damage or the repairs that will be necessary, contact your local Sales and Service Office.

2.4 SITE REQUIREMENTS

The ADM 36 may be conveniently used in a normal office environment as no special mounting provisions are required. It is recommended that the environment be weather protected with an ambient temperature range of 41 deg F to 104 deg F (5 deg C to 40 deg C) and a relative humidity of not greater than 95%.



Allow the ADM 36 to adjust to any change in the environment before applying power. Moving the unit from one location to another could produce internal condensation and adversely affect ADM 36 operation.

Whenever the ADM 36 is physically moved from a cold location to a warmer environment, be sure to allow sufficient time for the equipment temperature to equalize

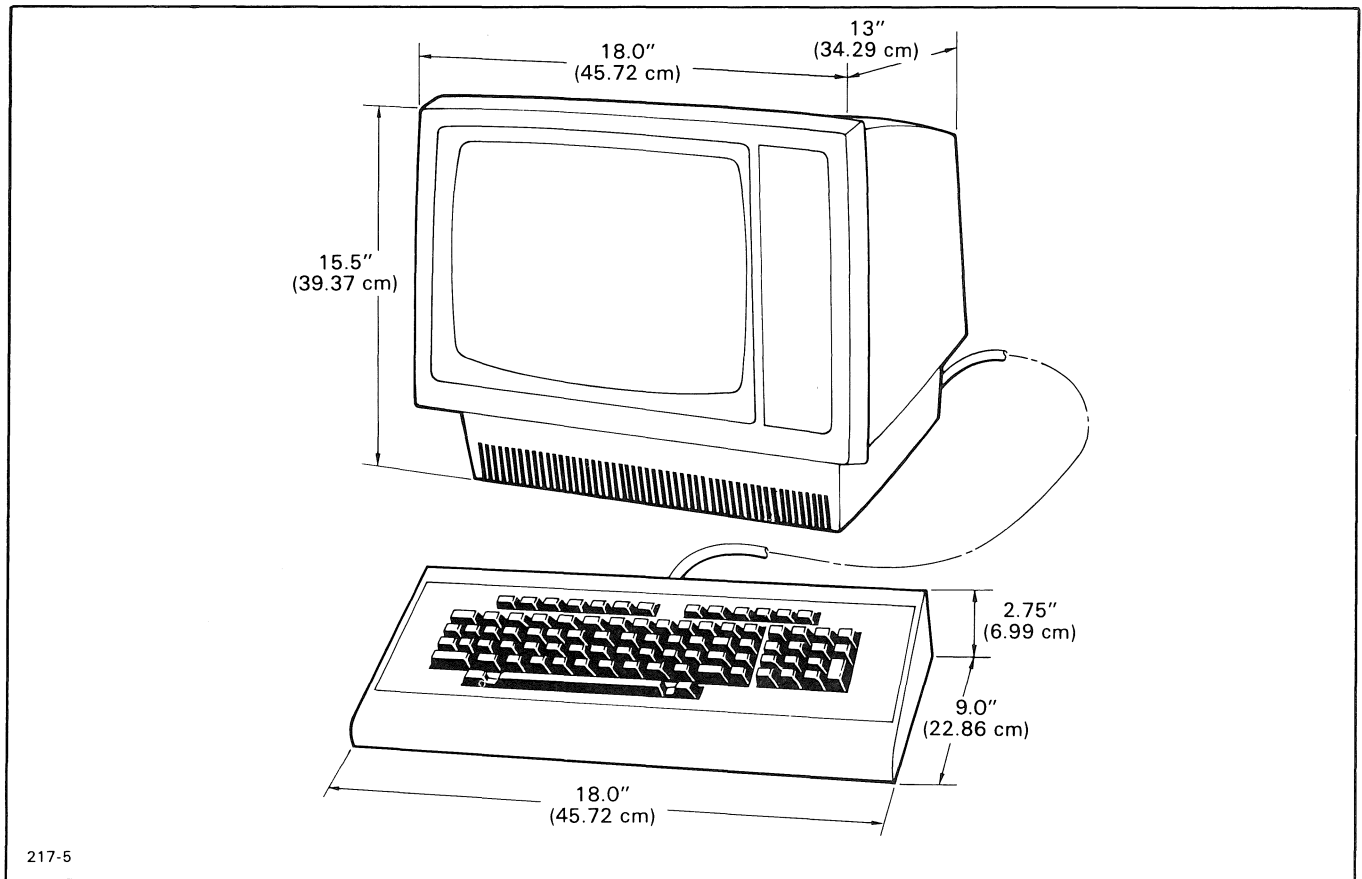

Figure 2-1. ADM 36 Mounting Requirements

with the warmer location before activating the unit. Condensation developed by the temperature differential could possibly impair the ADM 36. The physical dimensions of the ADM 36 are shown in figure 2-1. The basic requirements for installation are as follows:

- Table or desk mounting
- Standard three-pronged 115-volt (230-volt optionally) power outlet.
- Cable connection to the computer, modem, serial printer, or other auxiliary device. If connection to a remote computer is desired, a modem or data set is usually required.

2.5 LINE VOLTAGE SELECTION

The ADM 36 is shipped configured for either 115-volt or 230-volt operation, as specified in the purchase order. Any change in line voltage requires circuit changes which can be

accomplished only by authorized maintenance personnel.

2.6 SET-UP MODE

The SET-UP mode function allows a user to select terminal features that are tailored to the operating environment of a specific system. The ADM 36 selects and stores the terminal features in the SET-UP mode by means of nonvolatile memory (NVR), instead of switches or jumpers.

Once features are selected and written to NVR memory, the terminal always remembers what features have been selected. When the SET-UP mode is entered (by pressing the SET-UP key), the features stored in working memory are displayed on the screen. These features may be changed and can be stored in either working or permanent (NVR) memory. Working memory is achieved by selecting terminal features in the SET-UP mode without a Save operation. Permanent

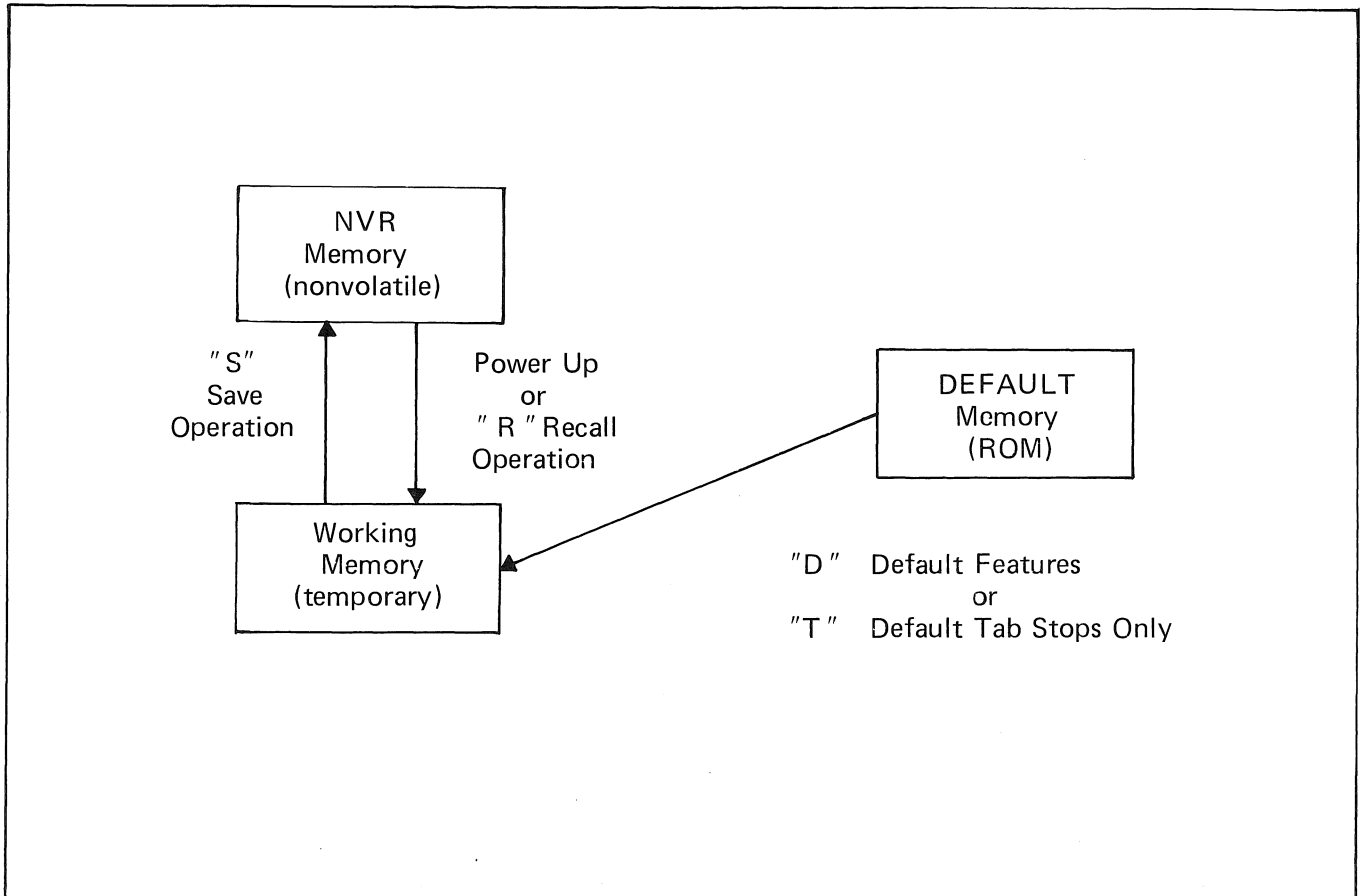

Figure 2-2. SET-UP Mode Memory Structure

memory is performed by a Save operation which writes to the NVR memory. (The Save operation is explained later in this section). The ADM 36 also has a static (ROM) memory that allows you to set the NVR or working memory with default features and tabs that are factory preset in the ROM. The diagram depicts the memory locations of the terminal: If the terminal power is turned off, if the terminal is reset, or a recall operation is performed, all features stored in temporary memory will be replaced with the features in

the NVR memory. (The Save, Recall, Default Features, Default Tabs, and Reset operations are explained in this section.) There are two SET-UP modes; SET-UP A mode which displays the location of the tab stops on the last line of the screen and allows you to set or change tabs and adjust the screen brightness, and SET-UP B mode which displays the terminal features and options on the last line of the screen. SET-UP A and SET-UP B mode are explained in the following paragraphs.

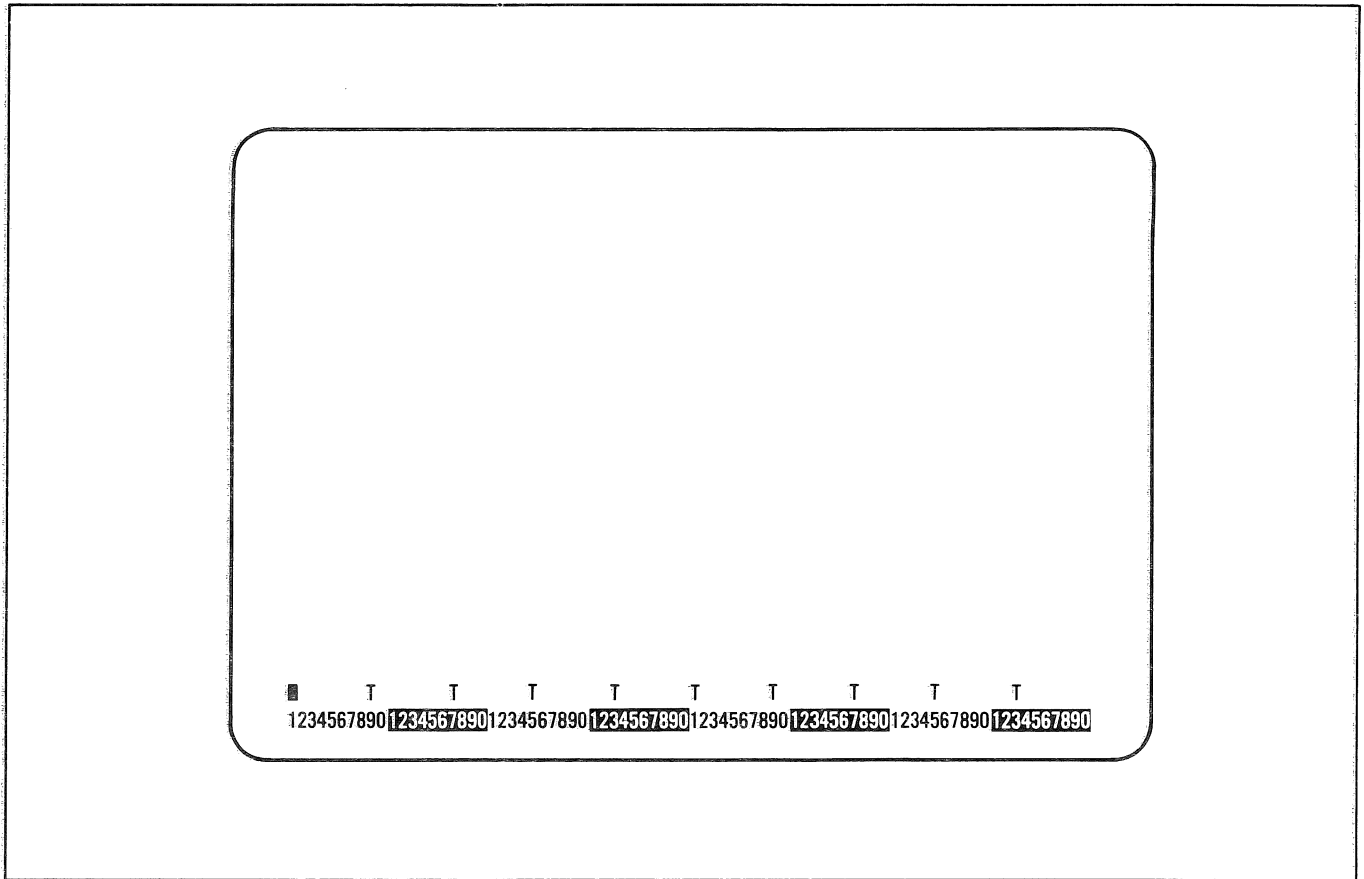

Figure 2-3. SET-UP A Mode Display Screen

2.6.1 Set-Up A Mode

To enter the SET-UP mode, press the SET-UP key. SET-UP A is automatically displayed first, and is shown in figure 2-3. The last line of the display screen contains a "ruler" which numbers each character position on a line. Each tab stop location is shown by a "T" character above the ruler.

SET-UP A may also be entered from SET-UP B by pressing the 5 key.

To exit SET-UP A mode, press the SET-UP key.

The features that can be changed in SET-UP A are the tabs and screen brightness. The following steps detail the procedures for setting or changing tabs and screen brightness.

Changing tabs in SET-UP A:

1. To clear all tab stops press the 3 key.

2. To set or clear an individual tab stop, position the cursor on the preset or new tab stop and press the 2 key.
3. To recall default tabs from the factory preset tabs, press the T key.

Changing the screen brightness in SET-UP A:

1. Press the key to increase the screen brightness.
2. Press the key to decrease the screen brightness.

Note

Brightness should be adjusted so that all three levels (bold, normal, and reduced) of video produce readable characters on the display.

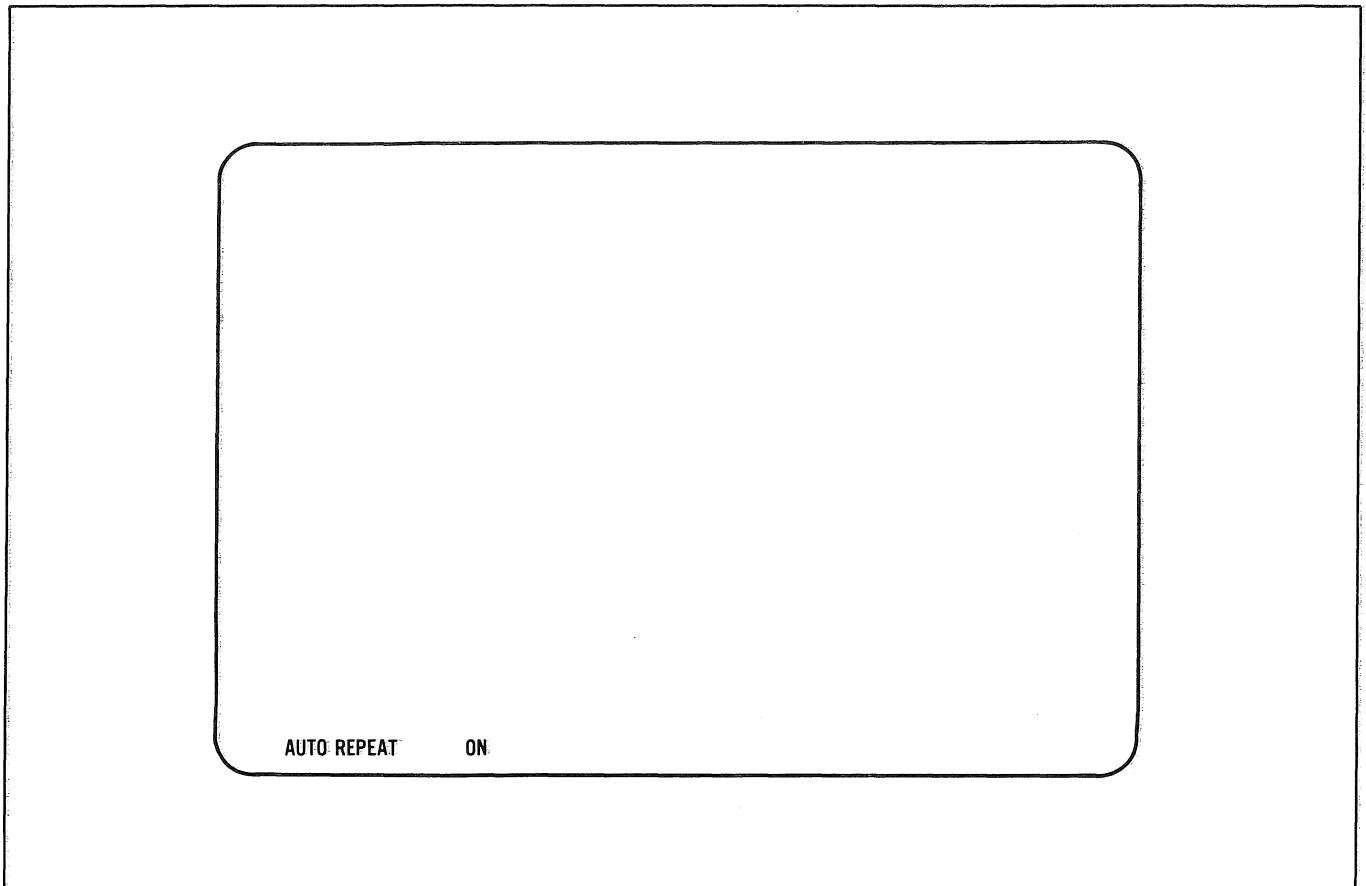

Figure 2-4. SET-UP B Mode Display Screen

2.6.2 SET-UP B Mode

The SET-UP B mode may only be entered from SET-UP A mode. While in SET-UP A mode, press the 5 key on the main keyboard. The screen will display the first SET-UP feature on the last line of the screen, along with the feature options.

Only one feature is displayed on the screen at a time. In order to display or change each feature, perform the following steps:

1. To step forward through each terminal feature in SET-UP B, press the key or space bar. To step backward through each terminal feature, press the key.
2. To change a feature, step to the desired feature and press the 6 key. Each time the 6 key is pressed the feature option will change, generally to the opposite state.

To exit SET-UP B, press the SET-UP key.

Figure 2-8 is an example of the display screen in SET-UP B.

Table 2-1 summarizes the terminal features and options presented in SET-UP B mode. (Each feature is described in detail in "SET-UP Features", this section).

Table 2-1. SET-UP B Mode Terminal Features Summary.

FEATURE	OPTIONS
<p>FOR OPERATOR COMFORT:</p> <p>Auto Repeat Background Cursor Mode Keyclick Margin Bell Scroll Mode Wrap-Around</p>	<p>On or Off Dark or Light On or Off On or Off On or Off Jump or Smooth On or Off</p>
<p>FOR HOST COMPATIBILITY:</p> <p>Auto X-ON/X-OFF Bits/Character Character Set</p> <p>Character/Row Flag Keyboard Type Line Mode New Line Parity Parity Sense Printer Baud Rate Printer Handshake Printer Stop Bits Printer Parity Printer Parity Sense Print Extent Print Terminator Receive Baud Rate</p> <p>Stop Bits Terminal Mode Transmit Baud Rate</p> <p>80/132 Clears Screen</p>	<p>On or Off 7 or 8 US ASCII, German, French, S/F (Swedish/ Finnish), DK/N (Danish/Norwegian), UK ASCII, Spanish, or Italian 80 or 132 0 through 15 QWERTY, QWERTZ, AZERTY, or CUSTOM Local or On-Line On or Off On or Off On or Off Same as Transmit Baud Rate above X-ON/X-OFF or RTS 1 or 2 On or Off Odd or Even Full or Partial None or Form-Feed 50, 75, 110, 134.5, 150, 200, 300, 600, 1200, 1800, 2000, 2400, 3600, 4800, 9600, 19200 1 or 2 ANSI or VT-52 50, 75, 110, 134.5, 150, 200, 300, 600, 1200, 1800, 2000, 2400, 3600, 4800, 9600, 19200 On or Off</p>
<p>INSTALLATION:</p> <p>Line Frequency</p>	<p>50 or 60</p>

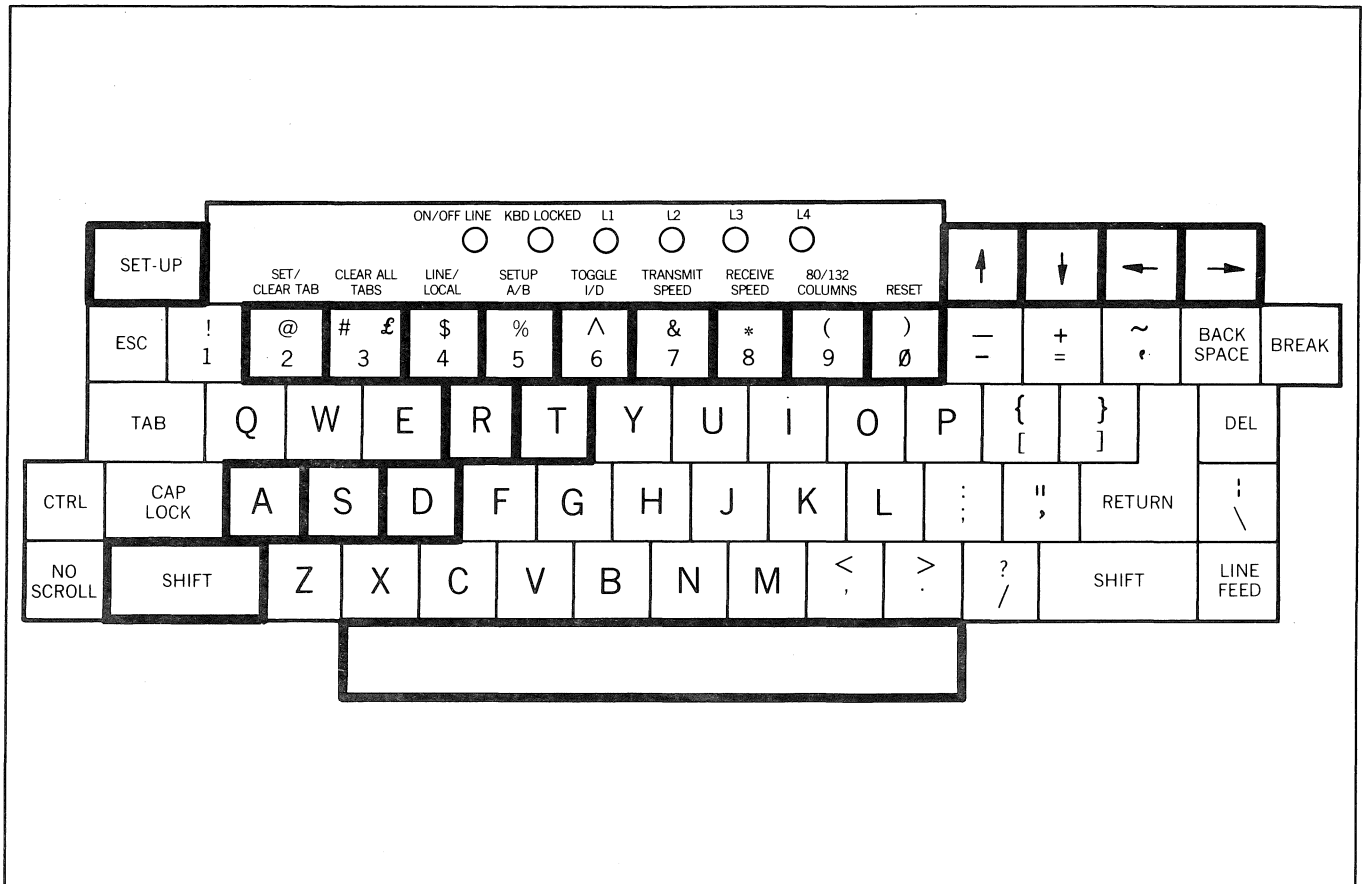

Figure 2-5. Keys Used in the SET-UP Mode

2.6.3 SET-UP Mode Keys

The keys used in the SET-UP mode are illustrated in figure 2-5, and explained in the following paragraphs. The SET-UP keys are presented in alphabetical order. (See Table 2-2 for a summary of the SET-UP mode keys.)

2.6.3.1 Clear All Tabs (3) Key

The Clear All Tabs (3) key clears all horizontal tabs set in the terminal when in SET-UP A Mode.

2.6.3.2 Line Local (4) Key

The LINE/LOCAL (4) Key places the terminal in either the ON LINE or LOCAL mode when in the SET-UP mode. When the terminal is in the ON LINE mode, it communicates with the host system. When the terminal is in the LOCAL mode, it is functionally disconnected from the host

system. (See "Line Mode" under the SET-UP FEATURES, this section), for an explanation of the ON LINE or LOCAL mode.

2.6.3.3. Receive Speed (8) Key

When the terminal is in SET-UP B mode, the Receive Speed (8) key takes the terminal through the receive baud rate settings in ascending order.

2.6.3.4 Reset (0) Key

The Reset (0) key starts the reset sequence when the terminal is in the SET-UP mode. The Reset (0) key has the same result as turning the terminal power off and then on.

2.6.3.5 Set Clear Tab (2) Key

The Set/Clear Tab (2) key sets or clears individual horizontal tabs when in SET-UP A mode.

KEY	SET-UP A MODE	SET-UP B MODE
SET-UP	Exit SET-UP mode	Exit SET-UP mode
2 (Set/clear tab)	Set/Clear tab at current position	Ignored
3 (Clear all tabs)	Clear all tabs	Ignored
4 (Line/local)	Go to SET-UP B - toggle line/local	Toggle line/local
5 (Set-up A/B)	Go to SET-UP B	Go to SET-UP A
6 (Toggle)	ignored	Change feature setting
7 (Transmit speed)	Go to SET-UP B transmit baud rate	Change transmit baud rate
8 (Receive speed)	Go to SET-UP B receive baud rate	Change receive baud rate
9 (80/132 columns)	Toggle 80/132	Toggle 80/132
0 (Reset)	Resets terminal	Resets terminal
A (Shifted)	Ignored	Enter Answerback mode
R (Shifted)	Recall features from NVR	Recall features from NVR
S (Shifted)	Save features to NVR	Save features to NVR
T (Shifted)	Recall default tabs	Ignored
D (Shifted)	Recall default features	Recall default features
↑	Increase brightness	Increase brightness
↓	Decrease brightness	Decrease brightness
→	Moves cursor to right	Move to next features
←	Moves cursor to left	Return to previous feature
Space	Move cursor to right	Move to next feature
RETURN	Return cursor to left	Return to first feature

Table 2-2. SET-UP Mode Keys Summarized.

2.6.3.6 SET-UP A/B (5) Key

The SET-UP A/B (5) Key switches the terminal from SET-UP A to SET-UP B or from SET-UP B to SET-UP A, when the terminal is in the SET-UP mode.

2.6.3.7 Toggle (6) Key

When in the SET-UP B mode, the Toggle I/O (6) key changes the displayed feature setting, generally to the opposite state. On features with more than one setting, toggle will "rotate" through all the possible states.

2.6.3.8. Transmit Speed (7) Key

When the terminal is in SET-UP B mode, the Transmit Speed (7) key takes the terminal through the transmit baud rate settings in ascending order.

2.6.3.9 80/132 Columns (9) Key

When the terminal is in SET-UP mode, the 80/132 columns (9) key switches the display screen line size from 80 to 132 characters or from 132 to 80 characters per line.

2.6.4 Save SET-UP Features

The Save operation stores the SET-UP features from working memory to permanent NVR memory. The following steps detail the procedure for saving SET-UP features:

1. Press the SET-UP key to place the terminal in the SET-UP mode.
2. Press the SHIFT and S keys simultaneously. After a brief wait, the terminal will return to the SET-UP mode.
3. Press the SET-UP key to exit the SET-UP mode.

2.6.5 Recall SET-UP Features

The Recall operation replaces SET-UP features in working memory with features stored in NVR memory. The following steps detail the procedure for recalling stored SET-UP features:

1. Press the SET-UP key to place the terminal in the SET-UP mode.

2. Press the SHIFT and R keys simultaneously. After a brief wait, the terminal will return to the SET-UP mode.
3. Press the SET-UP key to exit the SET-UP mode.

2.6.6 Default SET-UP Features

The factory set of SET-UP features (as stored in the ROM) may be placed in working memory with the Default operation. The following steps detail the procedure to copy the default features setting to the working memory:

1. Press the SET-UP key to place the terminal in the SET-UP mode.
2. Press the SHIFT and D keys simultaneously.
3. Press the SET-UP key to exit the SET-UP mode.

2.6.7 Default Tabs

The tab stops set at the factory (as stored in the ROM) may be placed in working memory with the Default Tab operation. The following steps detail the procedure to copy the default tabs to the working memory:

1. Press the SET-UP key to place the terminal in the SET-UP mode.
2. Press the SHIFT and T keys simultaneously.
3. Press the SET-UP key to exit the SET-UP mode.

2.6.8 Reset the Terminal

The reset operation resets the terminal from the keyboard. When the terminal is reset, the memory is cleared and the self-test program is run as if the terminal power had been turned off and then on. The following steps detail the procedure to reset the terminal:

1. Press the SET-UP key to place the terminal in the SET-UP mode.
2. Press the 0 (zero) key on the main keyboard. The terminal will be reset, and power on self-test will be run. The terminal features will be set according to the permanent SET-UP features in NVR memory.

2.6.9 SET-UP Features

The ADM 36 SET-UP features fall into one of three categories; operator preference, host computer compatibility or interface, and installation (as summarized in Table 2-1).

The SET-UP features are explained in the following paragraphs, and are presented in alphabetical order.

2.6.9.1 Answerback

The Answerback feature provides the terminal the capability of identifying itself by sending a message to the host computer. The Answerback feature is a question and answer sequence where the terminal responds to a question of identifying itself from the host computer via an "ENQ" control code. The entire sequence takes place automatically without operator action, and without writing to the display screen. It is also possible to transmit the Answerback message by pressing CTRL and BREAK keys simultaneously.

The following steps detail how to type an Answerback Message into the terminal:

1. Place the terminal in SET-UP B mode.
2. Press the SHIFT and A keys simultaneously. The terminal will respond by displaying the current Answerback message.
3. Type the message delimiter character, which may be any character not used in the actual Answerback message. The message delimiter is not a part of the Answerback message. If a mistake is made when typing the message, type the message delimiter character again and go back to Step 1. This is the only way to correct errors in the Answerback message.
4. Type the Answerback message. The message may have up to 20 characters, including space and control characters. Control characters are displayed as a ♦ character to indicate their presence in the message.
5. Type the message delimiter character, Answerback message, and the message

delimiter character. The Answerback message then disappears from the screen.

Note

Once the Answerback message steps have been completed the message will be temporarily stored, and can be saved with the Save Operation.

To look at the Answerback message, do the following:

1. Enter SET-UP B.
2. Press SHIFT and A keys.
3. Press SET-UP key (message is not changed) to exit SET-UP mode.

2.6.9.2 Auto Repeat

The Auto Repeat feature allows a key to be automatically repeated when held down for more than .5 seconds. This feature enables Auto Repeat of all keys with the following exceptions.

SET-UP
ESC
NO SCROLL
TAB
RETURN
CTRL and any other key

2.6.9.3 Auto X-ON/OFF

The auto X-ON/OFF feature is used to stop and start transmission of data from the host computer to the terminal for specified events. The X-OFF (DC3) code equals stop, and X-ON (DC1) code equals start. The ADM 36 automatically generates the synchronizing code X-ON and X-OFF. When the AUTO X-ON/X-OFF feature is enabled (on), the ADM 36 will generate the X-OFF code when one of the following events occur:

1. The NO SCROLL key is pressed.
2. The terminal is placed in SET-UP mode.
3. A CTRL S (X-OFF code) key sequence is pressed.

4. The internal buffer (256 characters) is 32 characters away from being full. (This is transparent to the operator.)

To resume transmission from the host computer to the terminal, an X-ON code must be generated. An X-ON code is generated by one of the following conditions:

1. The NO SCROLL key is pressed again.
2. The terminal is taken out of SET-UP mode (by pressing the SET-UP key).
3. A CTRL Q (X-ON code) key sequence is pressed.
4. The buffer empties (transparent to the operator).

Note

If the host computer software does not support the AUTO X-ON/X-OFF codes data sent may be lost during the buffer full condition or when the terminal is in SET-UP mode.

Note

The terminal will always stop transmission when an X-OFF code is received, and will resume transmission when an X-ON code is received, regardless of the AUTO X-ON/X-OFF feature setting.

2.6.9.4 Background

The Background feature is used by the operator to change the type of background of the screen. In normal video mode, the screen contains light characters on a dark background. In reverse video mode, the screen contains dark characters on a light background.

2.6.9.5 Bits Character

The Bits/Character feature enables the ADM 36 to transmit and receive either 7- or 8-bit characters. When using 8-bit operation, bit 8 is set to a space (0) for transmitted characters, and is ignored for all characters received.

2.6.9.6 Character Set

The ADM 36 contains eight different character sets that can be selected by the user. The following character sets may be selected:

US ASCII
GERMAN
FRENCH
SPANISH
S/F (Swedish/Finnish)
DK/N (Danish/Norwegian)
UK ASCII
ITALIAN

2.6.9.7 Characters/Row

The Characters/Row feature allows the user to display either 80 or 132 characters per line.

Note

If the "80/132 CLEARS SCREEN" feature is enabled (on), the screen will clear and the current contents lost when the characters are changed from 80 to 132 or from 132 to 80 per row.

2.6.9.8 Cursor Mode

The Cursor mode feature allows the cursor to be displayed either as a blinking block (■) or a blinking underline (-). The cursor represents the "active position" on the display screen, and indicates where the next character will be placed on the screen.

2.6.9.9 Flag

The Flag value is a number (0 through 15) that is transmitted in the <FLAGS> field of the report terminal parameters sequence. (See "Report Terminal Parameters" LSI REPT PARA in Section 3.) The host computer may, or may not use this parameter; it has no significance to the ADM 36.

2.6.9.10 Keyboard Type

The Keyboard Type feature indicates to the ADM 36 what type of keyboard will be used. The ADM 36 can be set for QWERTY, QWERTZ, AZERTY, or CUSTOM (user-defined custom keyboard layout) keyboard types. (See figure 1-3 for an illustration of

the keyboard types.) Note that if the "AZERTY" type keyboard is selected, the top row of keys (numerics and punctuation) will be inverted, i.e. The shift key must be pressed to produce numerals or change options in SET-UP mode.

2.6.9.11 Keyclick

The Keyclick feature is used to turn a keyclick tone on or off. If the feature is on, a tone is generated each time a key on the keyboard is pressed.

2.6.9.12 Line Frequency

The Line Frequency feature is used to select a power line frequency of 50 or 60 Hertz. This feature makes the ADM 36 compatible with different power line frequencies.

2.6.9.13 Line Mode

The Line mode feature places the terminal in either the ON-LINE or LOCAL (off-line) mode. When the ON-LINE mode is selected the ON/OFF LINE indicator light is illuminated, all messages from the computer are displayed on the screen, and all characters entered on the keyboard are sent to the computer. (Characters will be displayed only if echoed from the host.) When the OFF-LINE mode is selected the ON/OFF LINE indicator light is extinguished, messages are not sent or received from the computer, and all characters entered on the keyboard are displayed on the screen only.

2.6.9.14 Margin Bell

The Margin Bell feature sounds a tone when the cursor is eight characters from the end of the current line. This operates in the same way as a typewriter.

2.6.9.15 New Line

The New Line feature (when on) enables the RETURN key to generate a carriage return (CR) and a line feed (LF) code when pressed. The LINE FEED key also generates a line feed and a carriage return code when pressed.

2.6.9.16 Parity

When the Parity feature is enabled, received data is checked for transmission errors. If a

transmission error is detected, the ADM 36 indicates the error by displaying a checkerboard character (▣) in place of the erroneous character. On transmission a parity bit is added to the 7- or 8-bit character. If the Parity feature is disabled, no parity bit is transmitted or received.

2.6.9.17 Parity Sense

The Parity Sense feature determines odd or even parity used by the ADM 36 for parity checking. When the Parity feature is on the ADM 36's parity must match the parity the computer is sending. If it does not match, most of the characters sent to the computer will be rejected even if the ADM 36 receives them correctly. If a parity error occurs, a checkerboard character (▣) is displayed in place of the received character on the screen.

2.6.9.18 Printer Baud Rate

The Baud Rate feature is used for the selection of the transmit speed to the printer. The ADM 36 will transmit at any of the following preselected baud rate speeds:

50	1200
75	1800
110	2000
134.5	2400
150	3600
200	4800
300	9600
600	19200

2.6.9.19 Printer Bits Character

The Printer Bits/Character feature allows the ADM 36 to transmit either 7- or 8-bit characters to the printer. When the 8-bit operation is selected, bit 8 is set to a space (0) for transmission of characters.

2.6.9.20 Printer Handshake

The printer handshake is a means for the printer to indicate to the terminal its status--busy or ready to accept data. The terminal will stop transmitting data when the printer sends an X-OFF code or makes the Busy (RTS) level true at the interface. Transmission resumes when the printer transmits an X-ON code or makes the Busy (RTS) level false.

2.6.9.21 Printer Parity

When the Printer Parity feature is enabled (on) a parity bit will be added to the 7- or 8-bit character. If the Printer Parity feature is disabled (off) no parity bit is transmitted.

2.6.9.22 Printer Parity Sense

The Printer Parity Sense feature determines odd or even parity used for the printer.

2.6.9.23 Printer Stop Bits

The Printer Stop Bits feature determines if one or two stop bits per character is transmitted to the printer.

2.6.9.24 Print Extent

The Print Extent feature determines if the full screen or partial screen contents are printed. The partial screen print is determined by the scrolling region selected by the host computer (see "Set Top and Bottom Margins - LSISTBM", in Section 3 for an explanation of the scrolling region).

Note

A screen is printed by pressing the SHIFT and ENTER keys simultaneously, as explained in "Keyboard Controls" in Section 3.

2.6.9.25 Print Terminator

When the Print Terminator feature is set to Form-Feed, a form-feed character (FF) is added at the end of the Print Screen sequence.

2.6.9.26 Receive Baud Rate

The Receive Baud Rate feature sets the receive speed to match the computer transmit speed. The ADM 36 will receive at any of the following baud rates:

50	1200
75	1800
110	2000
134.5	2400
150	3600
200	4800
300	9600
600	19200

2.6.9.27 Scroll Mode

The Scroll Mode feature allows you to set the upward or downward movement of existing lines on a display screen to a Jump scroll or Smooth scroll mode. The Jump scroll mode displays new lines as fast as the computer can transmit them. Lines in the Jump mode are sometimes difficult to read if the baud rate speed is high. The Smooth scroll displays new lines of data at a slower rate so they can be read easily.

Note

The AUTO X-ON/X-OFF feature should be enabled and supported by the host computer software to ensure that data is not lost when the Smooth scroll mode is enabled. If the AUTO X-ON/X-OFF is disabled (off) the ADM 36 will switch to the Jump scroll mode 64 characters before the end of the buffer to avoid losing data.

2.6.9.28 Stop Bits

The Stop Bits feature determines if one or two stop bits per character is used by the ADM 36. (If the baud rate is 300 or lower, 2 should be selected.)

2.6.9.29 Terminal Mode

The Terminal Mode feature sets the ADM 36 to work in the American National Standards Institute (ANSI) mode or a VT52 Compatible mode. When the ANSI mode is selected, the ADM 36 will generate and respond to code sequences compatible with ANSI X3.41-7974 and the ANSI X3.64-1979 standards.

2.6.9.30 Transmit Baud Rate

The Transmit Baud Rate feature selects the transmit speed of data to the host computer. The transmit speed must match the host computer receive speed. The ADM 36 will transmit at any of the following baud rates.

50	1200
75	1800
110	2000
134.5	2400
150	3600
200	4800
300	9600
600	19200

2.6.9.31 Wrap-Around

When the Wrap-Around feature is enabled (on) the 81st or 133rd character (depending on the characters per row selected) is automatically placed on the first character position of the next line. If the Wrap-Around feature is disabled (off) the 81st or 133rd character and all following characters will be overwritten into the last character position of the current line until the RETURN key is pressed.

2.6.9.32 80/132 Clear Page

When the 80/132 Clear Page feature is enabled (on) the terminal screen will automatically clear when the characters are changed from 80 to 132 or from 132 to 80 characters per line.

2.6.10 Self-Test Mode

A Self-Test mode is built into the ADM 36 that automatically, or on command, tests the condition of the terminal, should a fault be detected. The Self-Test program checks the following items:

- Video Memory
- Nonvolatile Memory (NVR)
- Internal Memory (ROM and RAM)
- Keyboard

This test is performed automatically when the terminal is turned on.

2.6.10.1 Self-Test Error Messages

There are two categories of errors detected in the self-test mode for the terminal, fatal and nonfatal. Fatal errors cause the terminal to immediately stop all operations. No intelligible information is displayed on the screen; usually the screen contains a random pattern of characters. The only indication of a fatal error is the random pattern of characters on the screen, or a possible error code displayed on the programmable keyboard indicator lights. (L1-L4).

Nonfatal errors do not halt the terminal processor. Instead the terminal is switched to LOCAL mode and indicators L1, L2 and/or

SYMPTOM	POSSIBLE CAUSE AND CORRECTIVE ACTION						
Terminal will not turn ON when the power switch is set to ON.	<p>AC power cord is not plugged into wall outlet; plug in cord.</p> <p>Power is not coming from the wall outlet; check outlet with a known working electrical device (such as a lamp). If no power, call your electrician.</p> <p>AC line fuse blown; turn terminal OFF and have the fuse replaced.</p>						
No keyboard response	<p>Keyboard cable not plugged in; plug-in keyboard cable.</p> <p>KBD LOCKED indicator on; computer has turned the keyboard off. The KBD LOCKED conditions may be cleared by entering and exiting the SET-UP mode. If this condition persists, check with the host computer software personnel for a possible operating error.</p> <p>Perform the self-test operation.</p>						
Garbled or Error (⊠) Characters	<p>Incorrect SET-UP feature selection; correct the SET-UP features. Suggested SET-UP features which may be in error:</p> <table data-bbox="868 1165 1372 1270"> <tr> <td>ANSI/VT-52</td> <td>Parity Sense</td> </tr> <tr> <td>AUTO X-ON/X-OFF</td> <td>Receiver Speed</td> </tr> <tr> <td>Bits/Character Parity</td> <td>Transmit Speed</td> </tr> </table> <p>Perform the self-test operation.</p>	ANSI/VT-52	Parity Sense	AUTO X-ON/X-OFF	Receiver Speed	Bits/Character Parity	Transmit Speed
ANSI/VT-52	Parity Sense						
AUTO X-ON/X-OFF	Receiver Speed						
Bits/Character Parity	Transmit Speed						
Several Successive Long Tones	<p>The terminal has had difficulty in reading or writing the SET-UP features stored in non-volatile memory. Check the feature settings and perform the save operation.</p> <p>Perform the self-test operation.</p>						

Table 2-3. Problem Checklist

L3 will illuminate to indicate the possible error condition as follows:

- L1 = Memory (ROM) error
- L2 = Memory (RAM) error
- L3 = Display memory error
- Long tone = Non-volatile error (NVR) error
- Short tone = Successful self-test

2.6.11 Problem Checklist

If there is a problem with your terminal, you should initiate the power-up self-test program. The self-test will help determine if the problem is in the terminal or some other part of the computer system. Table 2-3 is a problem checklist that should be performed before requesting a service call.

2.6.12 Strapping Options

The following chart details the strapping options available for installation of the ADM 36. The ADM 36 uses on-board ROM, therefore it is not necessary for the user to set or change jumpers or straps for normal operation.

AS SHIPPED:

E1	-	1-2 3-4 5-6 7-8 9-10
E2	-	2-4
E3	-	1-2 5-6 9-10 13-14 15-16
E4	-	3-4
E5	-	3-4
E6	-	3-4
E7	-	3-4
E8	-	3-4
E9	-	1-3
E10	-	1-2
E11	-	3-4

2.7 INTERFACE INFORMATION

The ADM 36 may be cabled directly to a local computer, serial printer, or other auxiliary device; or it may be connected via telephone data lines to a remote computer located anywhere in the world. Remote computer connections require the use of a modem or data set **figure 2-6** shows a typical ADM 36

application, while **figure 2-7** shows the rear panel location of the interface connectors.

2.7.1 RS-232C (Modem) Interface

The RS-232C Modem Interface allows the ADM 36 to be connected directly to a host or a modem utilizing RS-232C signal levels. **Figure 2-8** depicts the pins and associated signal names from the RS-232C standard that are used in the ADM 36. Note that the modem connector is also used for RS-422A and 20mA current loop interfacing. Thus only the signals indicated should be used. Modem cables using all 25 pins may cause invalid signals to be present at the connecting devices.

2.7.2 RS-422A (Modem) Interface

The RS-422A Interface allows the ADM 36 to be connected to a device using the differential line levels associated with RS-422A standard. Refer to **figure 2-9** for details on which pins of the modem connector the RS-422A signals are assigned. Damage may result if RS-232C level signals are connected to RS-422A devices.

2.7.3 20mA Current Loop (Modem) Interface

The ADM 36 Modem connector also provides the ability to interface to a host using 20mA current loop levels. **Figure 2-10** illustrates the transmit and receive pairs associated with current loop operation. The current loop is always passive at the ADM 36.

2.7.4 Printer Port Interface

The PRINTER port is used for connecting a serial printer to the terminal. **Figure 2-11** shows the logic associated with the Printer interface. Refer to SET-UP mode for the settings of the features which enable the PRINTER port and establish the RTS or X-ON/X-OFF signal characteristics appropriate for the printer in use.

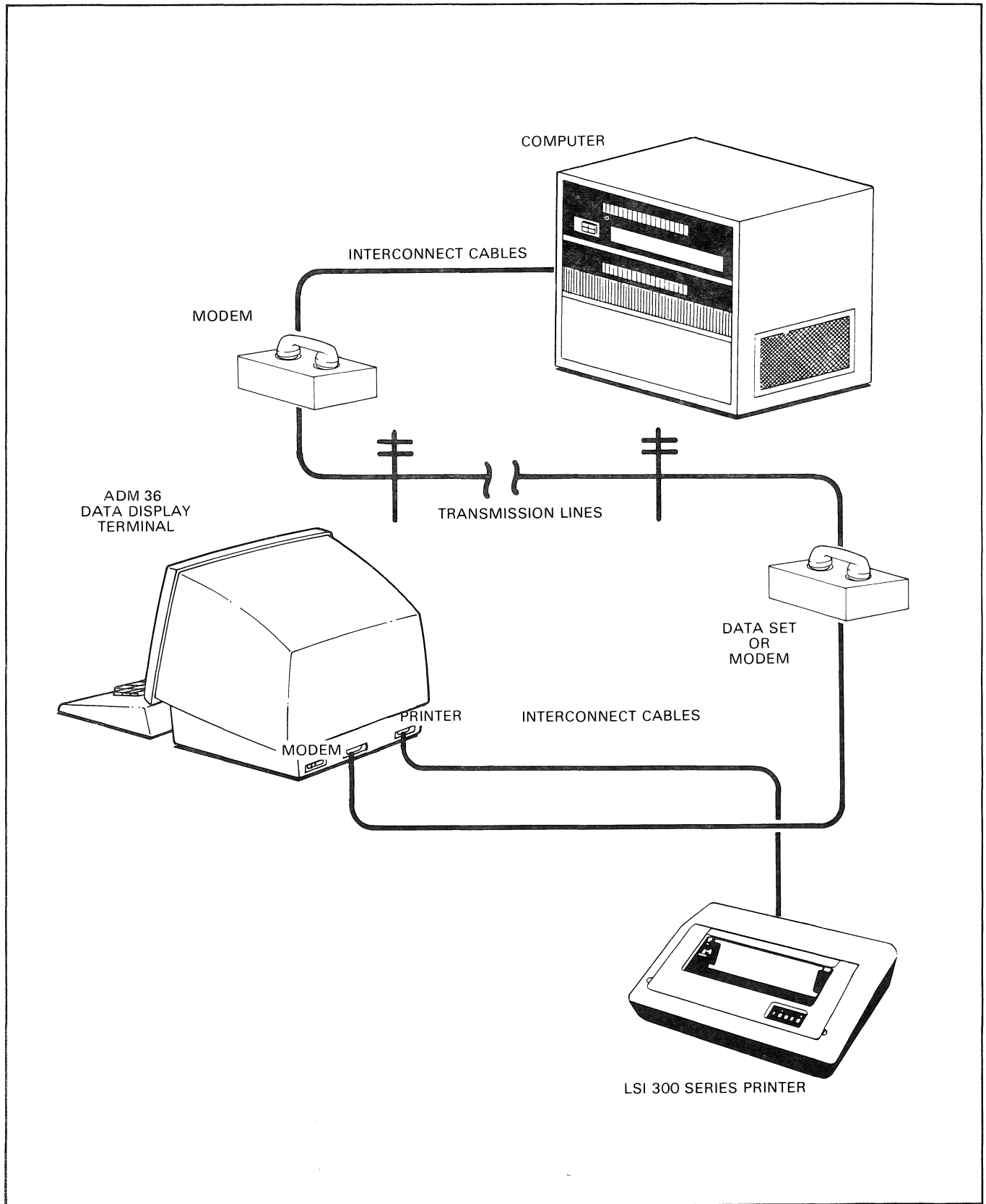

Figure 2-6. Typical ADM 36 Applications

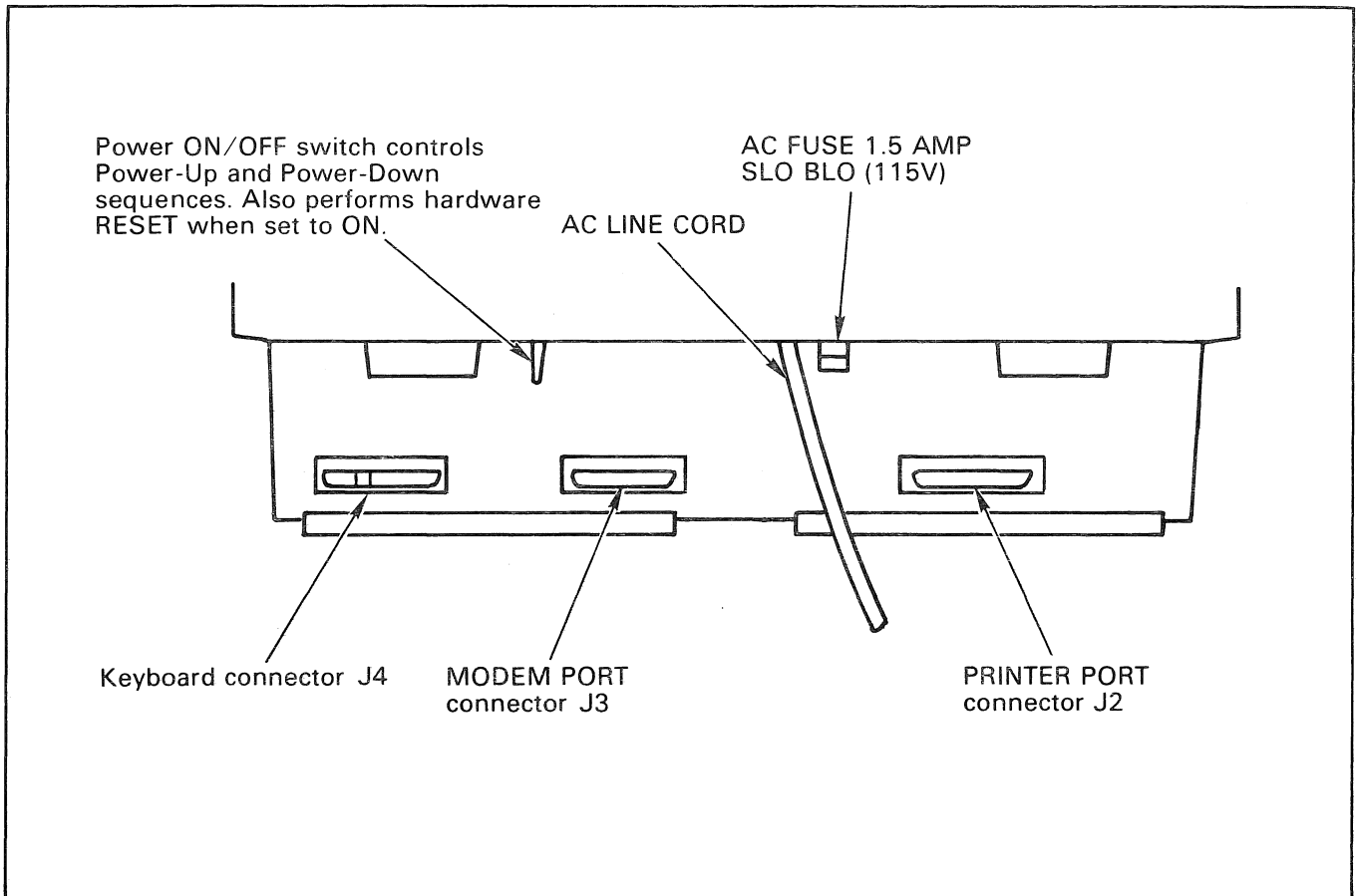

Figure 2-7. ADM 36 Panel Controls

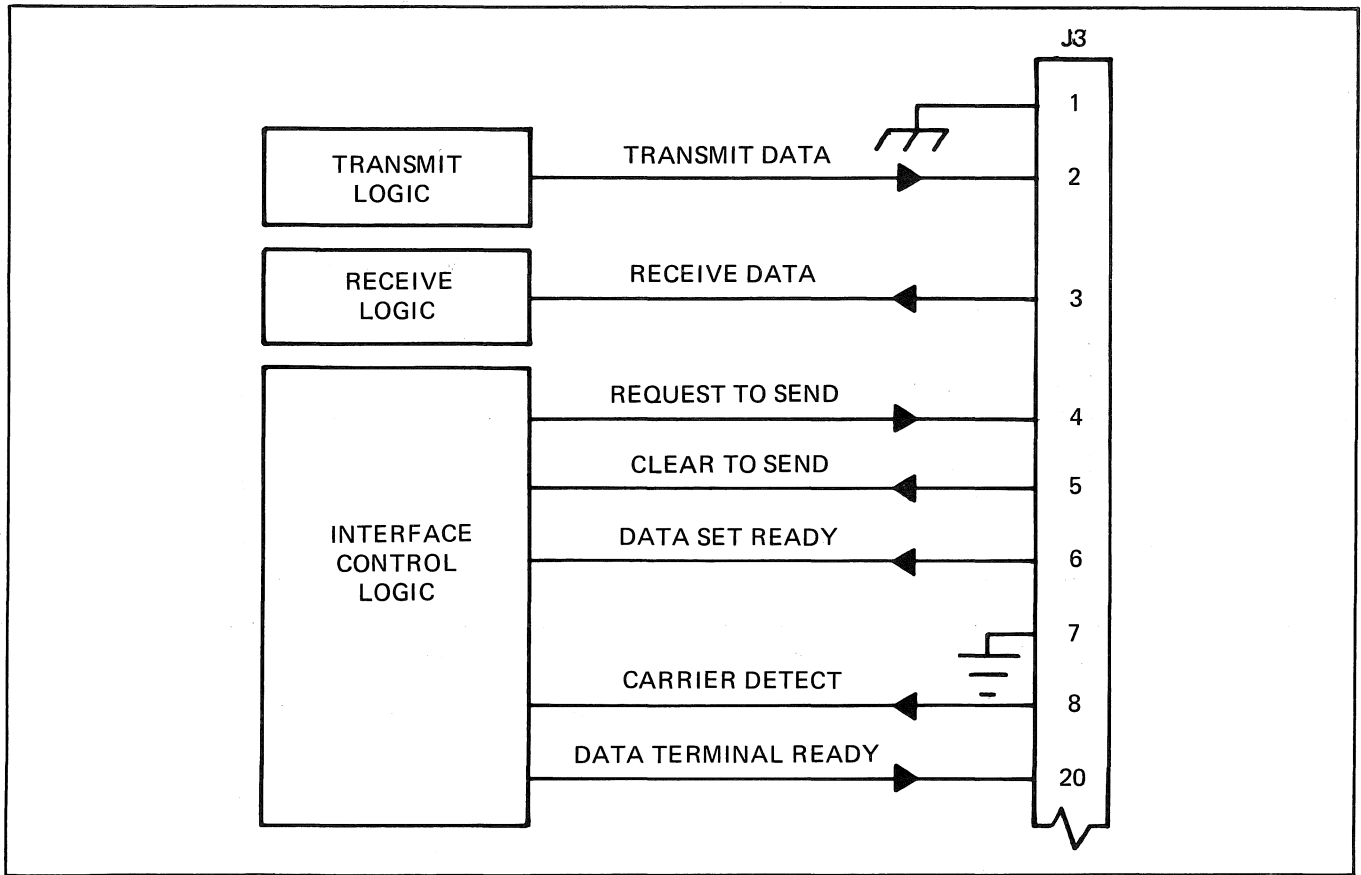

Figure 2-8. RS-232C (Modem) Interface Logic

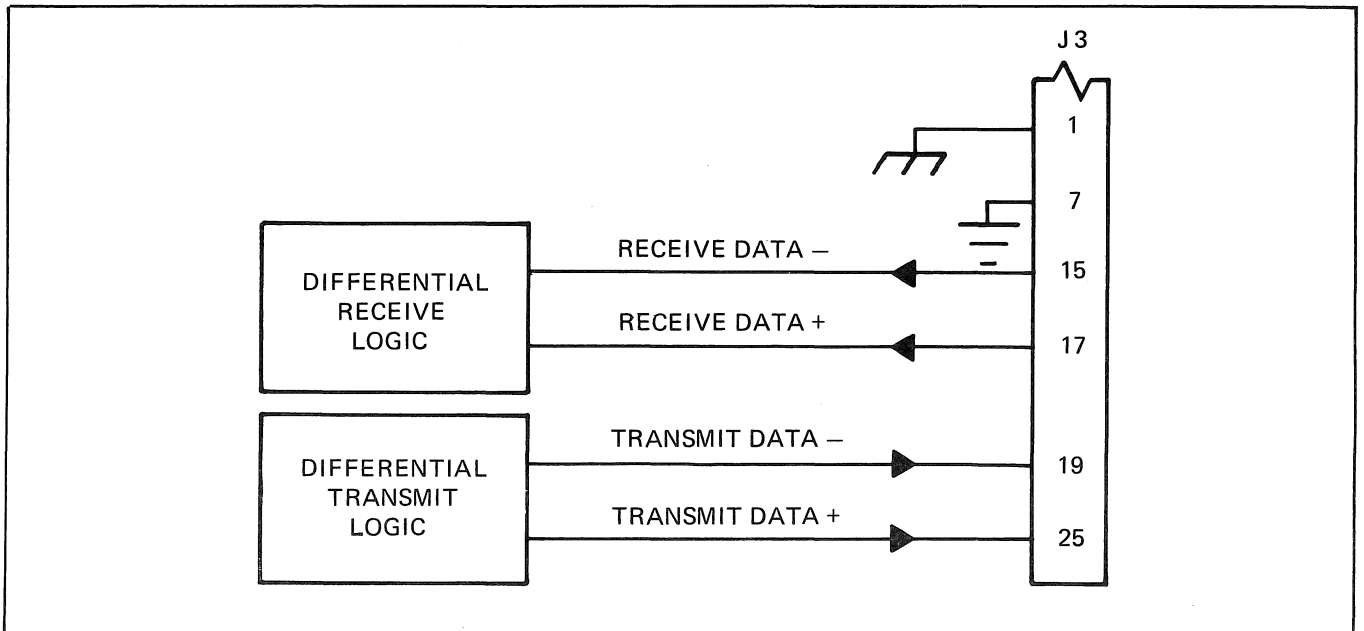

Figure 2-9. RS-422A (Modem) Interface Logic

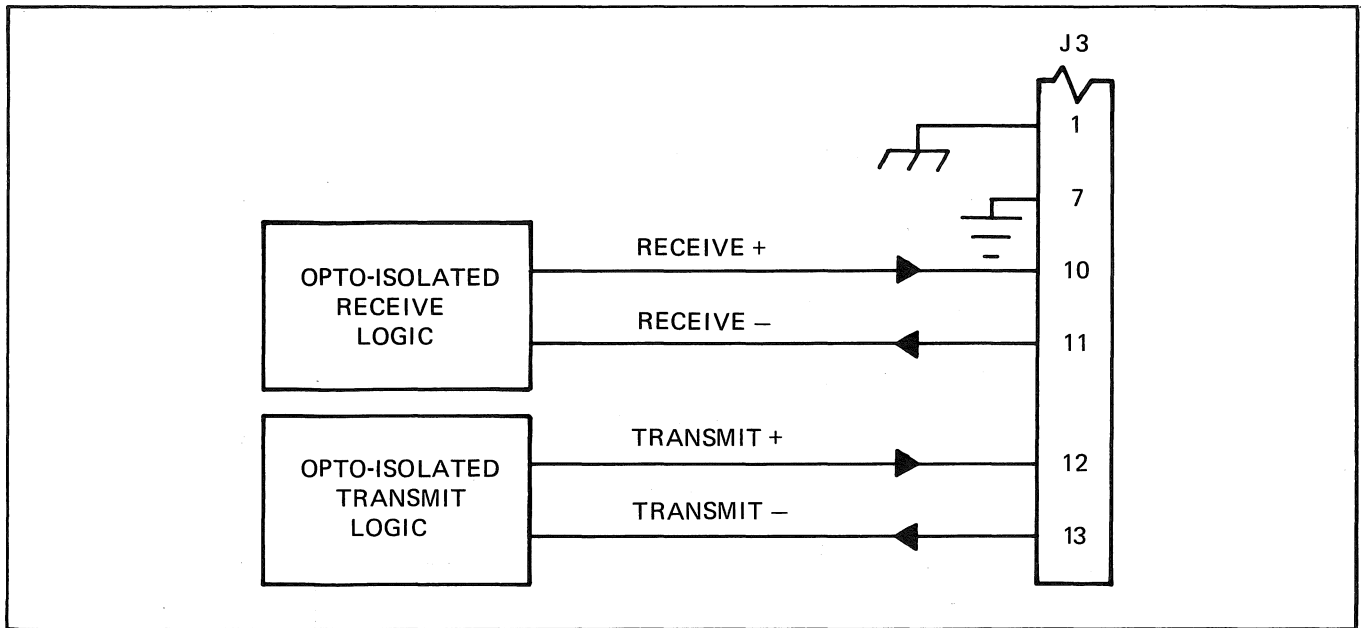

Figure 2-10. 20mA Current Loop (Modem) Interface Logic

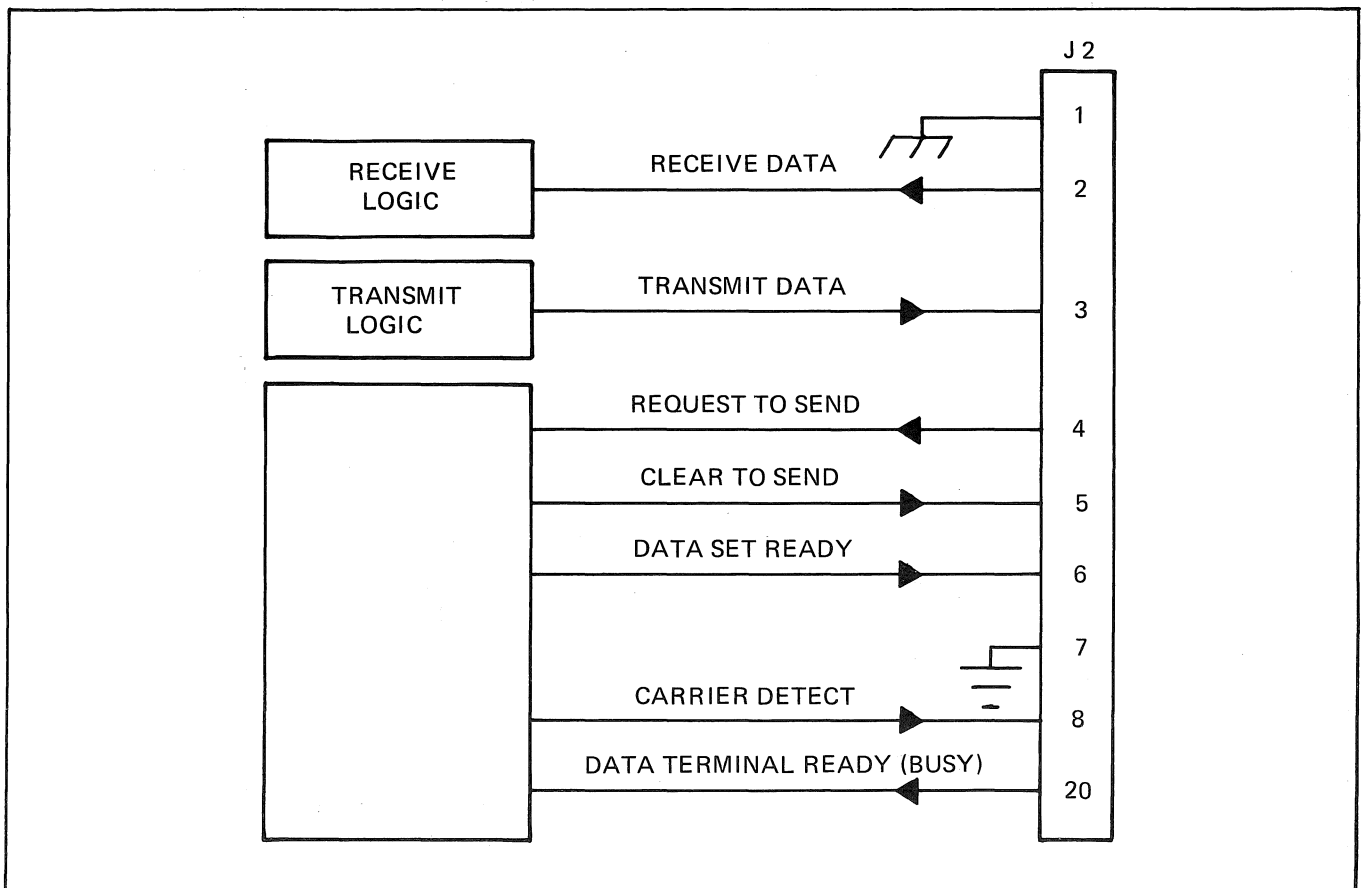

Figure 2-11. Printer Interface Logic (RS-232C)

2.8 INSTALLING THE ADM 36

1. Check the ON/OFF switch (figure 2-7) to ensure that it is set to OFF.
2. Connect the data interface cable(s) to the terminal using the appropriate interface information (paragraph 2.7).
3. Plug the power cord into a grounded AC outlet of the proper voltage (refer to paragraph 2.5).
4. Turn on the terminal.
5. Verify that all operating parameters specified in SET-UP mode (paragraph 2.6) are set correctly.

2.9 POWER TURN-ON

1. Set the ON/OFF switch to ON. (See figure 2-7.)
2. Wait approximately 20 seconds for the unit to warm up. The ADM 36 will beep twice to indicate no errors on power-up self-test.

CAUTION

To avoid damage to the CRT screen when the terminal is to remain ON but unchanged for extended periods of time, reduce the screen brightness.

3. Adjust BRIGHTNESS (SET-UP mode, paragraph 2.6.1) for desired display brightness.
4. If the cursor does not appear or if an error indication appears, refer to the self-test instructions and problems checklist in paragraphs 2.6.10 and 2.6.11.

5. If the display still does not appear, trouble-shoot the CRT monitor, then the terminal electronics, if necessary.

2.10 POWER TURN-OFF

Refer to figure 2-7 and proceed as follows:

1. If the unit contains information which must be retained, be sure to transmit this information to host immediately. This is necessary, as display memory is cleared when power is removed from the unit. An alternative is to send the information to a printer prior to turning OFF unit.
2. Turn of the ADM 36 by setting ON/OFF switch to OFF.

2.11 CARE OF THE ADM 36

Proper care of the ADM 36 consists of performing the routine cleaning and inspection procedures listed in the following paragraphs.

2.11.1 Cleaning

At period intervals, clean the exterior housing and lightly dust the unit using a soft brush or damp lint-free cloth. However, paper towels may be substituted if desired. Do not use petroleum base cleaners, such as lighter fluid, as this could be harmful to the painted surface. Remove smudges from the CRT exterior screen and the housing with conventional spray cleaners or alcohol. Be careful not to scratch the CRT screen.

2.11.2 Inspection

Periodically, inspect the keyboard assembly for freedom of movement. Determine that the intensity of character traced on the CRT screen has not diminished. Any required mechanical and electrical adjustment shall only be performed by an authorized Lear Siegler service representative.

SECTION III OPERATION

3.1 INTRODUCTION

This section provides the information necessary for the operator to utilize the ADM 36 to its fullest capabilities. The section emphasizes the control codes required to initiate and control various terminal operations, whether originating at the host or the unit keyboard. It is assumed that the operator is thoroughly familiar with keyboard operations that are discussed in the paragraphs which follow.

3.2 KEYBOARD

The ADM 36 Keyboard is designed as shown in figure 3-1. The keyboard is similar to a standard office typewriter with additional keys and indicator lights. The additional keys and indicator lights are used to generate control sequences, cursor control commands, and to show terminal status.

The keyboard is used to transmit ASCII codes to the host computer by entering specific keys or a combination of keys. Some keys transmit one or more codes to the host as soon as the keys are pressed. The CTRL (control) and SHIFT keys do not transmit codes. However, they modify codes transmitted by other keys when pressed with another key. When a key is pressed that transmits a code, the terminal makes a clicking sound to verify to the operator that the key was processed by the terminal. If more than one key that transmits codes are pressed together, the two codes will be transmitted in the order in which they were typed.

The following pages discuss the keys on the keyboard, codes generated by these keys, and the different character sets that may be selected by the ADM 36.

3.2.1 Auto Repeating Keys

All keys will automatically repeat when pressed and held down for more than 1/2 second, with the exception of the SET-UP, ESC, NO SCROLL, TAB, RETURN, and any key pressed simultaneously with the CTRL key. When an auto repeat key is pressed, the code is transmitted immediately. If the key is held for more than 1/2 second, the code(s) is transmitted repeatedly at the rate of approximately 30 CPS (or less than 30 CPS if a low transmit baud rate is used) until the key is released.

3.2.2 Alphabetic Keys

The ADM 36 transmits the lowercase code for alphabetic keys unless one or both of the SHIFT keys are pressed, or the CAPS LOCK key is pressed. If the SHIFT or CAPS LOCK key is pressed the uppercase (shifted) code is transmitted. The CAPS LOCK key locks only the 26 alphabetic keys in the uppercase mode. See Table 3-1 for the codes generated by the alphabetic keys; the codes are also listed in Appendix A for quick reference.

3.2.2.1 Caps Lock Key

The CAPS LOCK key, when pressed, locks only the 26 alphabetical keys in the shifted mode and enables the transmission of uppercase characters only. All numeric and special symbol keys remain in lowercase. Press again to unlock the key.

3.2.2.2 Shift Key

The SHIFT key places in the keyboard in an uppercase mode and enables the uppercase function on all keys. If a key does not have an uppercase function, the SHIFT key is disregarded.

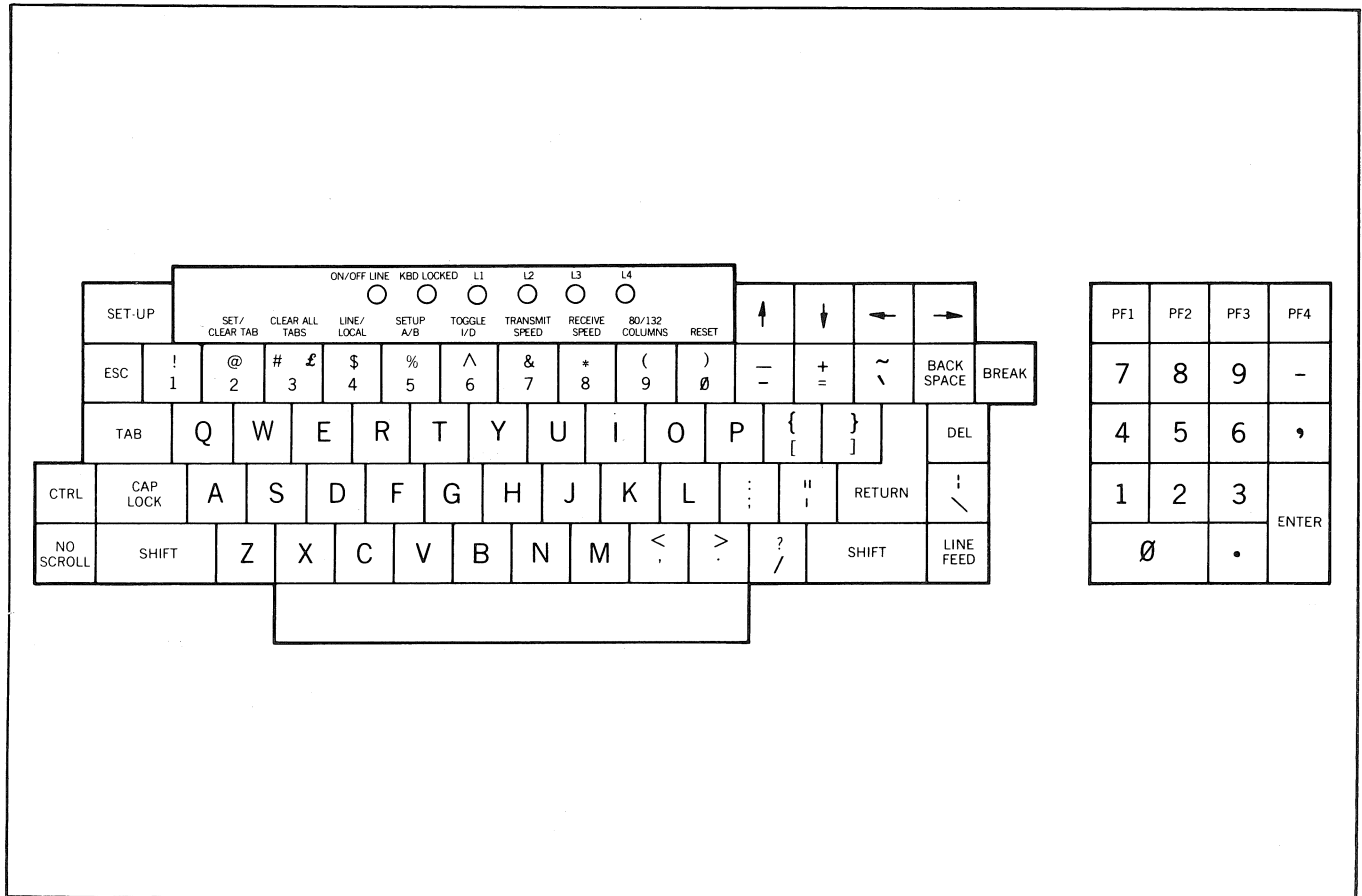

Figure 3-1. ADM 36 Keyboard.

3.2.3 Numeric And Special Character Keys

The ADM 36 transmits the lowercase code of the numeric and special character keys unless the one of the SHIFT keys is pressed. If the SHIFT key is pressed the uppercase code is transmitted. The CAPS LOCK key does not affect the numeric or special character keys. See Table 3-2 for the codes generated by the numeric and special character keys; the codes are also listed in Appendix A for quick reference.

3.2.4 Special Control

The Special Control keys transmit control codes to the host computer from the ADM 36. The special control keys and their codes are listed in Table 3-3 (codes are also listed in Appendix A for quick reference).

3.2.4.1 Backspace Key

The backspace key transmits a backspace code.

3.2.4.2 Delete Key

The DELETE key transmits a delete character code to the host device. The deleted character may or may not be erased from the display screen.

3.2.4.3 ESC Key

The ESC (escape) key transmits a code which has a special meaning as specified by your system. In most applications the ESC key tells the system to treat the next key(s) pressed as a command.

3.2.4.4 Linefeed Key

The LINE FEED key transmits a line feed code to the system.

Table 3-1. Alphabetic Key Codes.

KEY	UPPERCASE KEY CODE GENERATED (HEX)	LOWERCASE KEY CODE GENERATED (HEX)
A	41	61
B	42	62
C	43	63
D	44	64
E	45	65
F	46	66
G	47	67
H	48	68
I	49	69
J	4A	6A
K	4B	6B
L	4C	6C
M	4D	6D
N	4E	6E
O	4F	6F
P	50	70
Q	51	71
R	52	72
S	53	73
T	54	74
U	55	75
V	56	76
W	57	77
X	58	78
Y	59	79
Z	5A	7A

Table 3-2. Numeric and Special Character Codes.

LOWERCASE KEY	CODE GENERATED (HEX)	UPPERCASE KEY (SHIFTED)	CODE GENERATED (HEX)
1	31	!	21
2	32	@	40
3	33	# or £	23
4	34	\$	24
5	35	%	25
6	36	^	5E
7	37	&	26
8	38	*	2A
9	39	(28
0	30)	29
- (hyphen)	2D	_ (underscore)	5F
=	3D	+	2B
[5B	{	7B
;	3B	:	3A
' (apostrophe)	27	"	22
, (comma)	2C	<	3C
/	2F	?	3F
\ (grave)	5C	!	7C
	60	~	7E
]	5D	}	7D

Table 3-3. Special Control Key Codes.

SPECIAL CONTROL KEY	CODE GENERATED BY TERMINAL (HEX)	TERMINAL ACTION IF HOST SENT CODE	COMMENTS
BACKSPACE	08	Backspace one character	Transmits a backspace code.
DELETE	7F	Ignored	Transmits a delete character code to the host device. The deleted character may or may not be erased from the display screen.
ESC	1B	Initial delimiter of an escape sequence - interpret the following character string from the host as a command, rather than displaying on	Transmits a code which has a special meaning as specified by your system. In most applications the ESC key tells the system to treat the next key(s) pressed as a command.
LINEFEED	0A	Line Feed	Transmits a line feed code to the system.
RETURN*	0D	Carriage Return	Transmits either a carriage return (CR) code or a carriage return and a line feed (LF) code.
SPACE BAR	20	Enter a space on the display screen, erase what was there before.	Moves the cursor on character position to the right, and enters a space on the display screen.
TAB	09	Tab (one tap stop)	Transmits a tab code to the system.

*The RETURN key can be redefined in the SET-UP Mode, See "New Line" in SET-UP FEATURES, Section 2 for the information to redefine the RETURN key.

3.2.4.5 Return Key

The RETURN key transmits either a carriage return (CR) code or a carriage return and a line feed (LF) code. This function is selected in the SET-UP mode.

3.2.4.6 Space Bar

The Space Bar moves the cursor one character position to the right, and enters a space on the display screen.

3.2.4.7 Tab Key

The TAB key transmits a tab code to the system.

Table 3-4. Cursor control key code sequences.

CURSOR KEY	VT-52 MODE	ANSI MODE (CURSOR KEY MODE RESET*)	ANSI MODE (CURSOR KEY MODE SET*)
↑ (up)	ESC A	ESC [A	ESC O A
↓ (down)	ESC B	ESC [B	ESC O B
→ (right)	ESC C	ESC [C	ESC O C
← (left)	ESC D	ESC [D	ESC O D

*See "Control Sequences" this section for a detailed explanation of these modes.

3.2.5 Cursor Control Keys

The Cursor Control keys (↑, ↓, →, ←) transmits control sequences to the host computer. The control sequences generated by the cursor control keys are shown in **Table 3-4**.

3.2.6 Special Function Keys

The Special Function keys provide unique operations to the terminal. Some of the special functions are dependent on the host system software, and may or may not be used. The following paragraphs explain the special function keys.

3.2.6.1 Break Key

When the BREAK key is pressed the transmission line is forced to its zero state for .250 seconds ± 10 percent.

SHIFT And BREAK Key

If the SHIFT key is pressed with the BREAK key, the time for the zero state is increased to 3.5 seconds ± 10 percent and the data terminal ready (DTR) is de-asserted (off). After the 3.5 second break, the data terminal ready is asserted (on). Pressing the SHIFT and BREAK keys provides the long-break-disconnect function. A modem with RS-232-C levels can be configured to cause the local and remote data sets to disconnect with the long-break-disconnect function. A modem connected via the 20mA current loop may disconnect the remote data set only.

CONTROL And BREAK Key

Pressing the CTRL (control) and BREAK key together causes the transmission of the Answerback message. (See "Answerback" in the SET-UP Features, **Section 2**, for an explanation of the Answerback message.)

Table 3-5. Control codes generated by the CTRL key in conjunction with another key.

CTRL KEY PRESSED WITH FOLLOWING KEY	CODE TRANSMITTED (HEX)	ASCII MNEMONIC
@	00	NUL
A	01	SOH
B	02	STX
C	03	ETX
D	04	EOT
E	05	ENQ
F	06	ACK
G	07	BELL
H	08	BS
I	09	HT
J	0A	LF
K	0B	VT
L	0C	FF
M	0D	CR
N	0E	SO
O	0F	SI
P	10	DLE
Q	11	DC1 (or XON)
R	12	DC2
S	13	DC3 (or XOFF)
T	14	DC4
U	15	NAK
V	16	SYN
W	17	ETB
X	18	CAN
Y	19	EM
Z	1A	SUB
[1B	ESC
\	1C	FS
]	1D	GS
^	1E	RS
_	1F	US

3.2.6.2 CTRL (Control) Key

The CTRL (control) key is used to generate control codes when pressed in conjunction with other keys on the keyboard. The control codes generated and transmitted to the host are shown in **Table 3-5**; the control codes are also listed in **Appendix A** for quick reference.

3.2.6.3 ENTER Key

The ENTER key (by itself) transmits the same code as the RETURN key. (The RETURN key can transmit either a carriage return or a carriage return and line feed (LF) code, as defined in "New Line" in the SET-UP FEATURES, Section 2.)

Table 3-6. SET-UP Features Changeable by the Host Computer.

SET-UP FEATURE OR MACHINE STATE	CAN BE CHANGED FROM HOST COMPUTER	FEATURES IN NVR THAT CAN BE CHANGED IN SET-UP
Alternate keypad mode	yes (LSIKPAM/LSIKPNM)	no
ANSI/VT-52 mode	yes (LSIANM)	yes
Auto repeat	yes (LSIARM)	yes
Auto X-ON/X-OFF	no	yes
Bits per character	no	yes
Characters per row	yes (LSICOLM)	yes
Cursor	no	yes
Cursor key mode	yes (LSICKM)	no
New line	yes (LMN)	yes
Keyclick	no	yes
Margin bell	no	yes
Origin mode	yes (LSICOM)	no
Parity	no	yes
Parity sense	no	yes
Power frequency	no	yes
Receive speed	no	yes
Screen	yes (LSISCMN)	yes
Scroll	yes (LSISCLM)	yes
Tabs	yes (HTS/TBC)	yes
Transmit speed	no	yes
Wrap-around	yes (LSIAWM)	yes
Change Char. Set	yes (SCS)	yes

SHIFT and ENTER Keys

When the SHIFT and ENTER keys are pressed simultaneously, the contents of the screen will be output to the printer port. The output can be either full or partial screen contents according to the setting of the Print Extent feature (see "Print Extent" in the SET-UP FEATURES, Section 2). A form-feed (FF) character can be added to the end of the screen output if the Print Terminator feature is selected (see "Print Terminator" in SET-UP FEATURES, Section 2).

CONTROL and ENTER Keys

When the CTRL and ENTER keys are pressed simultaneously, line-at-a-time print mode is enabled. The screen will output a line at a time to the printer port whenever the cursor moves

off the line. A subsequent CTRL-ENTER entry will disable the line-at-a-time printer mode.

3.2.6.4 NO SCROLL Key

If the NO SCROLL feature is enabled (in SET-UP and at the host), the NO SCROLL key may be used to temporarily inhibit the scrolling of data off the screen. When the NO SCROLL key is pressed, an X-OFF character is sent to the host. The host should respond by suspending transmission to the terminal. When NO SCROLL is pressed again, an X-ON is sent to the host. The host may then resume transmission. (See "NO SCROLL" in SET-UP FEATURES, in Section 2). If the Auto X-ON/X-OFF feature is disabled, the NO SCROLL key has no effect upon the host, and will not transmit X-ON/X-OFF.

Table 3-7. Numeric Keypad Codes.

KEY	VT-52/KEYPAD NUMERIC MODE	VT-52/ APPLICATION MODE	ANSI KEYPAD NUMERIC MODE	ANSI APPLICATION MODE
0	0	ESC ? p	0	ESC O p
1	1	ESC ? q	1	ESC O q
2	2	ESC ? r	2	ESC O r
3	3	ESC ? s	3	ESC O s
4	4	ESC ? t	4	ESC O t
5	5	ESC ? u	5	ESC O u
6	6	ESC ? v	6	ESC O v
7	7	ESC ? w	7	ESC O w
8	8	ESC ? x	8	ESC O x
9	9	ESC ? y	9	ESC O y
-	- (minus)	ESC ? m	- (minus)	ESC O m
,	, (comma)	ESC ? l*	, (comma)	ESC O l*
ENTER	Same as RETURN key	ESC ? M	Same as RETURN key	ESC O M
PF1	ESC P	ESC P	ESC O P	ESC O P
PF2	ESC Q	ESC Q	ESC O Q	ESC O Q
PF3	ESC R	ESC R	ESC O R	ESC O R
PF4	ESC S	ESC S	ESC O S	ESC O S

*Lower-case "L" character (l)

3.2.6.5 SET-UP Key

The SET-UP key is pressed to place the terminal in the SET-UP mode, or to take the terminal out of the SET-UP mode. The SET-UP features are explained in detail in "SET-UP Mode", Section 2. The SET-UP features which may be changed by the host computer are listed in Table 3-6, and are explained in "Control Sequences", this section.

3.2.7 Numeric (Auxiliary) Keypad

The keys on the numeric keypad may transmit the same codes as the associated

keys on the keyboard (numerals, minus sign, and comma). The ENTER key on the numeric keypad transmits the same code as the RETURN key on the keyboard.

The numeric keypad can also be used to transmit control sequences to the host to enable user-defined functions by placing the terminal in Keypad Application Mode. The Keypad Application Mode is determined by a command from the host.

The keys on the numeric keypad transmit one of four combinations of codes. Table 3-7

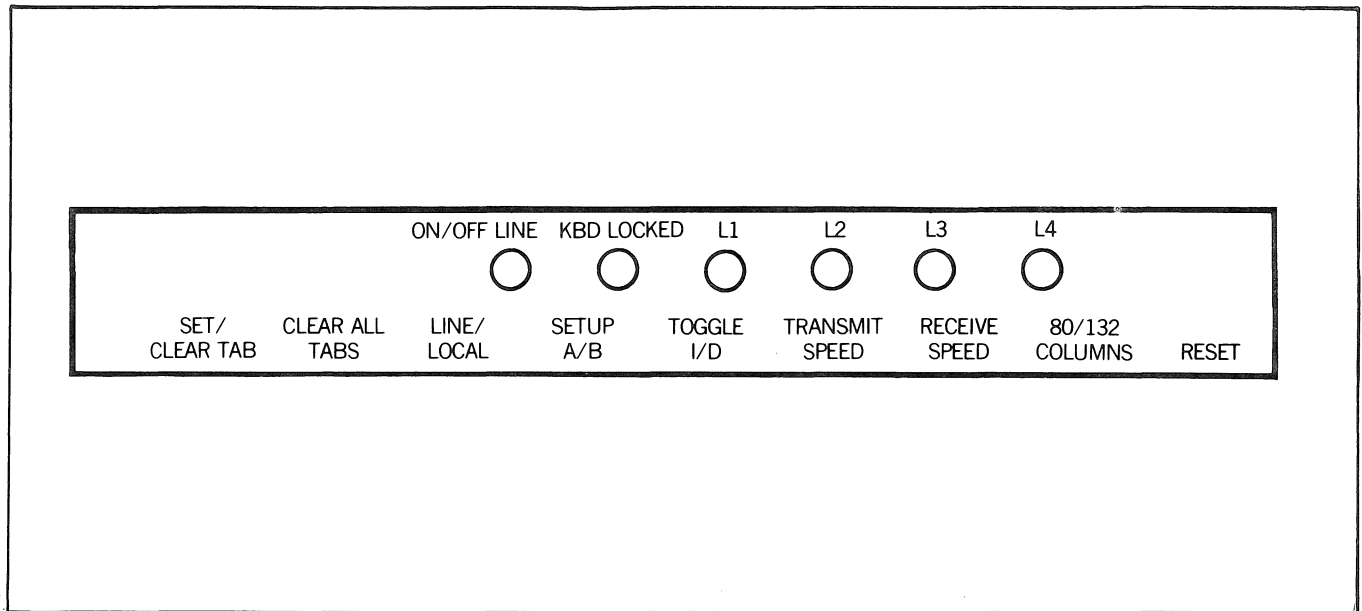

Figure 3-2. ADM 36 Indicator Lights

listed the keypad keys, the possible modes, and the control sequence generated for each key.

3.2.8 Indicator Lights

The indicator lights are located at the top left-hand corner of the keyboard. Three indicator lights inform the operator of special operating conditions (e.g., on-line/local, keyboard locked) and the remaining lights can be user-programmed for special application needs.

3.2.8.1 ON/OFF Line Indicator Light

The ON/OFF LINE indicator light is illuminated when the terminal is on-line and ready to transmit or receive messages from the host device. When the ON/OFF LINE indicator light is not illuminated, the terminal is off-line (local mode) and cannot communicate with the host device. In LOCAL mode the keyboard remains active and all characters typed are placed on the screen.

3.2.8.2 KBD Locked Light

The KBD (keyboard) locked light is illuminated when the keyboard has been turned off, but the terminal is still able to

receive data from the host computer. The keyboard locked condition can be cleared by entering and exiting the SET-UP mode.

3.2.8.3 L1-L4 Indicator Lights

The L1, L2, L3, and L4 indicator lights are turned on or off by the host device, and are user-programmable for special application needs. These lights are also used to show self-test errors.

3.3 SPECIAL GRAPHICS AND CHARACTER SETS

The ADM 36 offers special graphics and European character sets, as detailed in the following paragraphs.

3.3.1 Special and Wide Point Graphics Character Sets

The ADM 36 offers special graphics character sets that replace the characters normally typed on an USASCII or UKASCII keyboard (codes 5F through 7E hex) with special graphic characters. The special graphics character sets are: line graphics and wide-point. Table 3-9 illustrates the hex code transmitted, the USASCII/UKASCII character, and the special graphics or wide point graphics character that replaces the USASCII/UKASCII character when selected.

3.3.2 European Character Sets

The ADM 36 offers six European character sets along with USASCII and UKASCII character sets. If one of the European character sets is selected, some characters normally typed on a USASCII or UKASCII keyboard are replaced with the selected European characters. Table 3-8 illustrates the USASCII/UKASCII character and the selected European character that changes, and the hex code transmitted.

3.4 CONTROL FUNCTIONS

A control function is a single character or a string of characters used in the software to indicate actions that affect the recording, processing, transmitting, or representation of data from the host to the terminal. The two types of control functions are as follows:

Control Character

Control Sequence (either ANSI or VT-52)

The control characters and the ANSI and VT-52 control sequences are explained in the following paragraphs.

3.4.1 Control Character

The control character is a single character sent from the host to the terminal whose occurrence in a particular context initiates, modifies, or stops a control function. The control character causes the ADM 36 to take an action, but does not display a character on the screen.

The control characters are specifically left out of the control sequence syntax, but may be embedded in a control sequence. The ability to embed control characters allows the synchronization characters X-ON and X-OFF

Table 3-8. US/UKASCII and European Character Sets.

HEX CODE	US-ASCII	UK-ASCII	SPAIN	GERMANY	DENMARK NORWAY	FINLAND SWEDEN	FRANCE	ITALY
23	#	£	#	#	#	#	£	£
24	\$	\$	\$	\$	\$	Ö	\$	\$
40	@	@	@	§	@	É	à	§
5B	[[[Ä	Æ	Ä	°	°
5C	\	\	N	Ö	Ø	Ö	ç	é
5D]]]	Ü	À	Ä	§	ì
5E	^	^	^	^	^	Ü	^	^
60	`	`	`	`	`	e	`	ù
7B	{	{	{	ä	Ɔ	ä	é	à
7C			ñ	ö	ø	ö	ù	ò
7D	}	}	}	ü	à	ä	è	è
7E	~	~	~	β	~	ü	..	ì

Table 3-9. Special Graphics and Wide Point Graphics Character Sets

Hex Code	USASCII	Wide Point Graphics	Line Graphics and VT52 Character Set
5F	_ (underscore)	(Blank)	(Blank)
60	` (Grave)	Horizontal line scan 9 and 10	◇ Diamond
61	a	Horizontal line scan 7 and 8	▒ Checkerboard
62	b	Horizontal line scan 7, 8, 9 and 10	H␣ Horizontal Tab
63	c	Horizontal line scan 5 and 6	FF Form feed
64	d	Horizontal line scan 5, 6, 9 and 10	CR Carriage return
65	e	Horizontal line scan 5, 6, 7 and 8	LF Line feed
66	f	Horizontal line scan 5, 6, 7, 8, 9 and 10	° Degree
67	g	Horizontal line scan 3 and 4	± Plus/minus
68	h	Horizontal line scan 3, 4, 9 and 10	NL New line
69	i	Horizontal line scan 3, 4, 7 and 8	V␣ Vertical tab
6A	j	Horizontal line scan 3, 4, 7, 8, 9 and 10	┘ Lower right corner
6B	k	Horizontal line scan 3, 4, 5 and 6	┘ Upper right corner
6C	l	Horizontal line scan 3, 4, 5, 6, 9 and 10	└ Upper left corner
6D	m	Horizontal line scan 3, 4, 5, 6, 7, and 8	└ Lower left corner
6E	n	Horizontal line scan 3, 4, 5, 6, 7, 8, 9 and 10	+ Crossing lines

Table 3-9. Special Graphics and Wide Point Graphics Character Sets (continued)

Hex Code	USASCII	Wide Point Graphics	Line Graphics and VT52 Character Set
6F	o	Horizontal line scan 1 and 2	— Horizontal line scan 1
70	p	Horizontal line scan 1, 2, 9 and 10	— Horizontal line scan 3
71	q	Horizontal line scan 1, 2, 7 and 8	— Horizontal line scan 5
72	r	Horizontal line scan 1, 2, 7, 8, 9 and 10	— Horizontal line scan 7
73	s	Horizontal line scan 1, 2, 5 and 6	Horizontal line scan 9
74	t	Horizontal line scan 1, 2, 5, 6, 9 and 10	┌ Left "T"
75	u	Horizontal line scan 1, 2, 5, 6, 7 and 8	┐ Right "T"
76	v	Horizontal line scan 1, 2, 5, 6, 7, 8, 9 and 10	└ Bottom "T"
77	w	Horizontal line scan 1, 2, 3 and 4	└ Top "T"
78	x	Horizontal line scan 1, 2, 3, 4, 9 and 10	Vertical bar
79	y	Horizontal line scan 1, 2, 3, 4, 7 and 8	≤ Less than or equal to
7A	z	Horizontal line 1, 2, 3, 4, 7, 8, 9 and 10	≥ Greater than or equal to
7B	{	Horizontal line scan 1, 2, 3, 4, 5 and 6	π Pi
7C		Horizontal line scan 1, 2, 3, 4, 5, 6, 9 and 10	≠ Not equal to
7D	}	Horizontal line scan 1, 2, 3, 4, 5, 6, 7 and 8	£ UK pound sign
7E	~	Horizontal line scan 1, 2, 3, 4, 5, 6, 7, 8, 9 and 10	• Centered dot

to be interpreted properly without affecting the control sequence.

Embedded control characters are executed as soon as they are encountered by the ADM 36; then processing of the control sequence continues with the next character received. The only exceptions to the continued processing is when ESC, CAN or SUB occurs. When an ESC (1B) occurs the current control sequence is aborted and the new one starts

beginning with the ESC received. When a CAN (18) or SUB (1A) occurs the control sequence is aborted.

The control characters recognized by the ADM 36, the hexadecimal code, and the action taken are shown in Table 3-10. All other control codes cause no action to be taken. (The control characters are also listed in Appendix A by hexadecimal code for quick reference.)

Table 3-10. Control Characters Received From Host

CONTROL CHARACTER	HEX CODE	ACTION
BEL	07	Bell - Sound a bell tone from keyboard.
BS	08	Backspace - moves the cursor left one character position. If cursor is at leftmost position, no action is taken.
CAN	18	Cancel - causes the control sequences to abort. Also causes the error character (⌘) to be displayed on the screen.
CR	0D	Carriage Return - moves the cursor to the leftmost character position on the current line.
DEL	7F	Delete - ignored on input (not stored in input buffer).
ENQ	05	Enquiry - transmit the Answerback Message for terminal identification.
ESC	1B	Escape - introduces a control sequence.
FF	0C	Form Feed - interpreted as Line Feed.
HT	09	Horizontal Tab - moves the cursor to the next tab stop. If no further tab stops are set on the line, the cursor moves to the right margin.
LF	0A	Line Feed - causes a line feed, or a New Line operation (see "Line Feed/New Line Mode", this section).
NUL	00	Null - ignored on input (not stored in input buffer).
SI	0F	Shift In - select G0 character set (selected by the ESC (sequence).
SO	0E	Shift Out - select G1 character set (selected by the ESC) sequence).
SUB	1A	Substitute - interpreted as CAN.
XOFF	13	Causes ADM 36 to stop transmitting all codes except XOFF (DC3) and XON (DC1).
XON	11	Resume transmission by ADM 36.

3.4.2 ANSI Control Sequences Mode

The following control sequences are software compatible to the American National Standards Institute (ANSI X3.64-1979) standards for control sequences in terminals.

Figure 3-3 outlines the basic elements of the ANSI control sequences format: (Control sequences listed as LSI private indicate the usage of a command not yet specified in the ANSI standard. The formation of the private sequences is in conformance with the X3.64-1979 Standard which provides for private commands in such cases.)

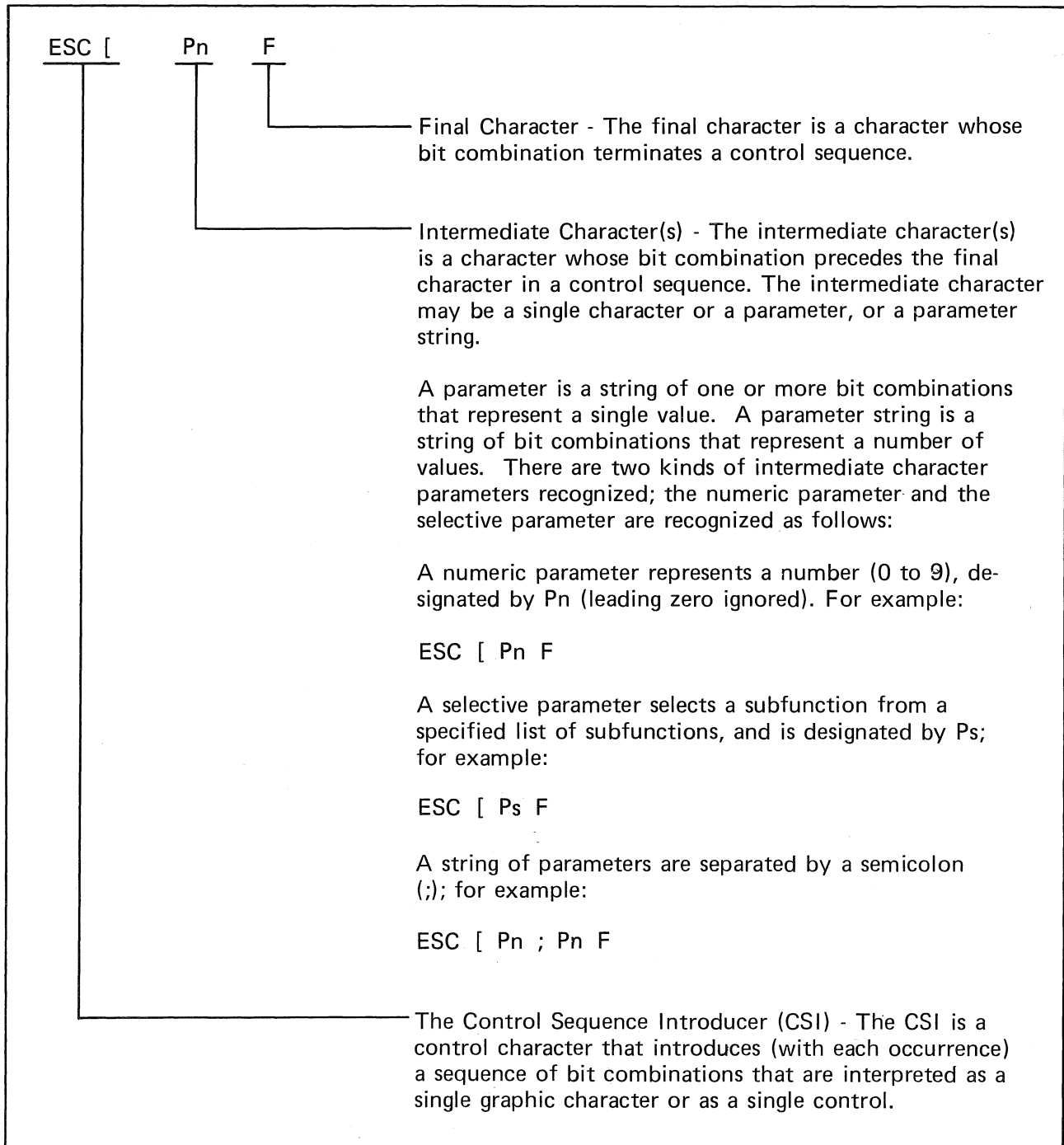

Figure 3-3. Basic Elements of the ANSI Control Sequences Format

Most control sequences have a function-dependent value, called the default value, that is assumed when no explicit value or a zero (0) is specified. If the control sequence has a default value, it will be specified in the associated sequence in the following paragraphs.

The ANSI control sequences are listed in groups of related functions as follows, and are summarized in Table 3-11:

- Special graphics and character set selection
- Cursor functions
- Keypad modes
- Screen control and edit functions
- Set/reset mode
- Output and print functions
- LED control
- Host/terminal control and status functions

Table 3-11. ANSI Control Sequences Summary

FUNCTION GROUP	DESCRIPTION	CONTROL SEQUENCE
Special Graphics and Character Set Selection	Double-High Line Double-Wide Line Select Character Set Single-Wide, Single-High Line	ESC # 3 (top half) ESC # 4 (bottom) ESC (Fs Designate G0 Character Set ESC) Fs Designate G1 Character Set ESC # 5
Cursor Functions	Cursor Backward Cursor Down Cursor Forward Cursor Position Cursor Position Report Cursor Up Horizontal and Vertical Position (Set Cursor) Index (Cursor Down With Scroll) New Line With Scroll Restore Cursor and Attributes Reverse Index (Cursor Up With Scroll) Save Cursor and Attributes	ESC [Pn D ESC [Pn B ESC [Pn C ESC [Pn; Pn H ESC [Pn; Pn R ESC [Pn A ESC [Pn; Pn f ESC D ESC E ESC 8 ESC M ESC 7

Table 3-11. ANSI Control Sequences Summary (continued)

FUNCTION GROUP	DESCRIPTION	CONTROL SEQUENCE
Keypad Mode	Keypad Application Mode Keypad Numeric Mode	ESC = ESC >
Screen Control and Edit Functions	Define Area Qualifications Delete Line Delete Character Erase in Display Erase in Line Horizontal Tab Set Insert Line Select Graphic Redition Screen Alignment Set Top and Bottom Margins Tabulation Clear	ESC [Ps o ESC [Pn M ESC [Pn P ESC [Ps J ESC [Ps K ESC H ESC [Pn L ESC [Ps;...Ps m ESC # 8 ESC [Pn;...Pn r ESC [Ps g
Set/Reset Mode	Reset Mode Set Mode (See Table 3-12 for a list of modes set with set/reset control sequences.)	ESC [Ps;...Ps l* ESC [Ps;...Ps h
Output and Print	Device Status Report Media Copy	ESC [Ps n ESC [Ps i
LED Control Functions	Load LEDs	ESC [Ps q
Host/Terminal Status and Control Functions	Device Attributes Identify Terminal Invoke Self-Test Report Terminal Parameters Request Terminal Parameters Reset (Terminal) to Initial State	ESC [Ps c ESC Z ESC [2; Pn y ESC [3; <comm par>; <comm nbits>; <comm xspeed>; <comm rspeed>; <clkmul>; <flags>; <ANSI/VT-52>; <prt par>; <prt nbits>; <prt xspeed>; <prt rspeed> x ESC [l.x ESC c

*Lower-case "L" character

3.5 SPECIAL GRAPHICS AND CHARACTER SET SELECTION

The following control sequences specifies the special graphics and character set selection format.

3.5.1 LSIDHL - Double-High Line (LSI Private)

ESC # 3 - top half
ESC # 4 - bottom half

The double-high line (LSIDHL) control sequences cause the line with the active cursor position to become the top or bottom half of a double-high (and double-wide) lines. The sequences must be used in pairs on adjacent lines, and the same character output must be sent to both lines to form the double-high characters.

3.5.2 LSIDWL - Double Wide Line (LSI Private)

ESC # 6

The double-wide line (LSIDWL) control sequence causes the line with the active cursor position to become double-width, single-height characters. The use of the double-wide line reduces the number of characters per line by half, and all characters to the right of the screen are lost.

3.5.3 SCS - Select Character Set

ESC (Fs - Designate G0 character set
ESC)Fs - Designate G1 character set

The select character set (SCS) control sequence selects the appropriate G0 and G1 character sets from one of 12 possible character and special graphic sets. The G0 and G1 character sets are invoked by the SI (shift in) and SO (shift out) codes.

Fs = 0 Line graphics
1 Alternate character set defined in SET-UP
2 Alternate (extra) ROM special graphics
3 Wide-point graphics
A UKASCII
B USASCII
E Spanish
F French
G German
I Italian
N Norwegian/Danish
S Swedish/Finnish

The UK (United Kingdom) and US (United States) ASCII sets, and the international character sets are in accordance with ANSI X3.4-1977, ISO 646-1973, and general usage. The other character sets are private. The special graphics means that the characters for codes 5F to 7E (hexadecimal) are replaced with other characters. The specified character set will be used until another SCS control sequence is received.

Examples:

ESC (0 - Selects the line graphics character set as the G0 character set (invoked by SI - shift in)

ESC) A - Selects the UKASCII character set as the G1 character set (invoked by SO - shift out)

3.5.4 LSISWSHL - Single-Wide, Single-High Line

ESC # 5

The single-wide, single-high line (LSISWSHL) control sequence cause the line with the active cursor position to become single-wide, single-high (standard) characters.

Note

If a line is either a Double-High or Double-Wide line, and the Single-Wide/Single-High line control sequence is used, the characters on the line will be positioned on the leftmost side of the screen.

3.6 CURSOR FUNCTIONS

The following control sequences specify the cursor functions for the ADM 36, and are listed in alphabetical order by function.

3.6.1 CUB - Cursor Backward

ESC [Pn D

Default Value = 1

The cursor backward (CUB) control sequence moves the active cursor position to the left. The number of positions the cursor is moved is determined by the parameter (Pn). If the parameter value is zero (0) or one (1), the cursor is moved back one position to the left. If the cursor position is moved to the left more positions than the left margin, the cursor stops at the left margin. The default value of the parameter is one (1).

Pn = numeric parameter

Example:

ESC [3 D - moves the cursor to the left three positions.

3.6.2 CUD - Cursor Down (No Scroll)

ESC [Pn B

Default Value = 1

The cursor down (CUD) with no scroll control sequence moves the active position of the cursor down one or more lines with the same column position. The number of lines the cursor is moved is determined by the parameter Pn. If the parameter value is zero (0) or one (1), the cursor is moved down one line. If the cursor position is moved down more lines than the bottom of the screen or the scrolling region, the cursor stops at the last line. The default value of the parameter is one (1).

Pn = numeric parameter

Example:

ESC [2 B - moves the cursor down two lines, at the same column position.

3.6.3 CUF - Cursor Forward

ESC [Pn C

Default Value = 1

The cursor forward (CUF) control sequence moves the active position of the cursor to the right one or more positions. The number of positions the cursor is moved is determined by the parameter Pn. If the parameter value is zero (0) or one (1), the cursor is moved to the right one position. If the cursor position is moved forward more columns than the right margin, the cursor stops at the right margin. The default value of the parameter is one (1).

Pn = numeric parameter

Example:

ESC [9 C - moves the cursor nine positions to the right.

3.6.4 CUP - Cursor Position

ESC [Pn; Pn H

Default Value = 1

The cursor position (CUP) control sequence moves the active position of the cursor to a specified line and column position. The positions are determined by the parameters Pn; Pn. The first parameter specifies the line number, and the second parameter specifies the column position. If both parameter values are zero (0) or one (1), the cursor is moved to the first line, first column position. The default value of the parameters are first line, first column (equivalent to a cursor home action).

Pn = numeric parameter

Examples:

ESC [2; 1 H - moves the cursor to the second line, first column position.

ESC [3; 5 H - moves the cursor to the third line, fifth column position.

ESC [H - moves the cursor to the home position (upper-left corner)

Note

The CUP control sequence depends on the number of lines specified in the Origin Mode setting. See "LSICOM - Origin Mode", this section, for an explanation of this mode.

3.6.5 CPR - Cursor Position Report

ESC [Pn; Pn R

Default Value = 1

The cursor position report (CPR) control sequence reports the active cursor position to the host (which is solicited by a device status report (DSR) from the host). The position is reported by the parameters Pn; Pn, in which the first parameter is the line number and the second parameter the column position. If not parameters are present or if the parameters are zero (0), the default value is equivalent to the cursor home position (line one, column one).

Pn = numeric variable

Note

The CPR control sequence depends on the Origin Mode setting. See "LSICOM - Origin Mode", this section, for an explanation of this mode.

3.6.6 CUU - Cursor Up (No Scroll)

ESC [Pn A

Default Value = 1

The cursor up (CUU) with no scroll control sequence moves the active position of the cursor up one or more lines at the same column position. The number of lines the cursor is moved is determined by the parameter Pn. If the parameter value is zero (0) or one (1), the cursor is moved up one line. If the cursor position is moved up more lines than the top of the screen or scrolling region, the cursor stops at the first line. The default value of the parameter is one (1).

Pn = numeric parameter

Example:

ESC [4 A - moves the cursor up four lines, at the same column position.

3.6.7 HVP - Horizontal and Vertical Position (Set Cursor)

ESC [Pn; Pn f

Default Value = 1

The horizontal and vertical position (HVP) control sequence is used to move the active cursor to a specified position. The specified position is determined by the parameters Pn; Pn. The first parameter specifies the line number, and the second parameter specifies the column position. If a parameter value is either zero (0) or one (1), the cursor is moved to the first line or first column position, respectively. The default value (no parameter present) is the first line, first column (equivalent to a cursor home action).

On = numeric parameter

Example:

ESC [3; 1 f - moves the cursor to line three, column one.

Note

The HVP control sequence depends on the Origin Mode setting. See "LSICOM - Origin Mode", this section, for an explanation of this mode.

The HVP control sequence is equivalent to the CUP control sequence.

3.6.8 IND - Index (Cursor Down With Scroll)

ESC D

The index (IND) control sequence (or cursor down with scroll) moves the active position of the cursor down one line without changing the column position. If the cursor position is on the bottom line of the screen or scrolling region, then the cursor does not move but the screen or scrolling region is scrolled up one line. The old top line is lost and the new bottom line is cleared.

3.6.9 NEL - New Line With Scroll

ESC E

The new line with scroll (NEL) control sequence causes the active cursor position to move to the first character position on the next line down. If the cursor position is on the bottom line of the screen or scrolling region, then the cursor does not move but the screen or scrolling region is scrolled one line.

Note

The New Line With Scroll control sequence to equivalent to carriage return (CR) followed by Index control sequence.

3.6.10 LSICRC - Restore Cursor and Attributes (LSI Private)

ESC 8

The restore cursor and attributes (LSICRC) control sequence restores a previously saved cursor position, graphic rendition, and character set. The Restore Cursor and Attributes control sequence is complementary to Save Cursor and Attributes control sequence (LSICSC).

3.6.11 RI - Reverse Index (Cursor Up With Scroll)

ESC M

The reverse index (RI) or cursor up with scroll control sequence moves the active position of the cursor up one line without changing the column position. If the cursor position is on the top line of the screen or scrolling, then the cursor does not move, but the screen (or scrolling region) is scrolled down one line. The old bottom line is lost, and the new top line is cleared.

3.6.12 LSICSC - Save Cursor and Attributes (LSI Private)

ESC 7

The save cursor and attributes (LSICSC) control sequence causes the cursor position, graphic rendition, and the character set to be saved.

3.8 KEYPAD MODES

The following control sequences affect the numeric keypad on the terminal keyboard.

3.8.1 LSIKPAM - Keypad Application Mode (LSI Private)

ESC =

The keypad application mode (LSIKPAM) control sequence causes the numeric keypad to transmit control sequences as specified in Table 3-7, "Numeric (Auxiliary) Keypad", this section.

3.8.2 LSIKPNM - Keypad Numeric Mode

ESC >

The keypad numeric mode (LSIKPNM) control sequence causes the numeric keypad to transmit the ASCII codes corresponding to the actual characters on the keys. The ASCII codes are identified in Table 3-7, "Numeric (Auxiliary) Keypad", this section.

3.9 SCREEN CONTROL AND EDIT FUNCTIONS

The following control sequences are used for edit and control functions for the display screen. The screen control and edit functions are listed in alphabetical order by function.

3.9.1 DAQ - Define Area Qualification

ESC [Ps o

The define area qualification (DAQ) control sequence defines beginning and end of protected fields (areas). In the ADM 36, the DAQ specifies the beginning and end of a string of consecutive characters that are protected against erasure by ED and EL when ERM is reset.

Ps = selective parameter

Parameter (Ps) Meaning

0 End of protective field.

8 Begin protective field.

3.9.2 DL - Delete Line

ESC [Pn M

Default Value = 1

The delete line (DL) control sequence deletes the contents of one or more adjacent lines as specified by the parameter Pn. A parameter value of zero (0) or one (1) deletes the contents

of the active line and shifts all adjacent lines one line up toward the active line.

Pn = numeric parameter

Example:

ESC [3 M - deletes the active line and the two following lines.

3.9.3 DCH - Delete Character

ESC [Pn P

Default Value = 1

The delete character (DCH) control sequence deletes the character at the active cursor position or the active character and adjacent characters as specified by the parameter Pn. A parameter value of zero (0) or one (1) deletes one character at the active cursor position. All characters to the right of the deleted characters (if any) are shifted to the left toward the active position.

Pn = numeric parameter

Example:

ESC [2 P - deletes the character at the active cursor position and the character following.

3.9.4 ED - Erase In Display

ESC [Ps J

The erase in display (ED) control sequence erases some or all of the display as specified by the parameter (Ps).

Ps = selective parameter

Parameter (Ps) Meaning

- 0 Erase the display from the active cursor position to the end of the screen.
- 1 Erase from the start of the display screen to the active cursor position, inclusive.
- 2 Erase all the lines of the display. (All lines are changed to single-width, and the cursor does not move.)

Note

Any complete line erased by the ED control sequence is returned to single-width mode.

Example:

ESC [2 J - erases all the lines of the display.

3.9.5 EL - Erase In Line

ESC [Ps K

Default Value = 1

The erase in line (EL) control sequence erases some or all the characters on an active display line, as specified by the parameter Ps.

Ps = selective parameter

Parameter (Ps) Meaning

- 0 Erase from the active cursor position to the end of the line, inclusive.
- 1 Erase from the start of the line to the active cursor position, inclusive.
- 2 Erase the entire line and change to single width.

Note

If the cursor is in column 1 (leftmost), then ESC [0 K is equivalent to ESC [2 K.

3.9.6 HTS - Horizontal Tabulation Set

ESC H

The horizontal tabulation set (HTS) sets one horizontal tab stop at the active cursor position.

3.9.7 IL - Insert Line

ESC [Pn L

Default Value = 1

The insert line (IL) control sequence inserts one or more erased lines as specified by the

parameter Pn. A parameter value of zero (0) or one (1) inserts an erased line at the active line and shifts all lines below the active line down.

Pn = numeric parameter

Example:

ESC [3 L - inserts three erased lines at the active line.

3.9.8 SGR - Select Graphic Rendition

ESC [Ps;...Ps m

The select graphic rendition (SGR) control sequence invokes the graphic rendition specified by the parameters (Ps;...Ps). All characters following the SGR control sequence are rendered according to the specified parameter until the next occurrence of an SGR control sequence. Previously set attributes are retained.

Ps = selective parameter

Parameter (Ps) Meaning

- 0 All character attributes off
- 1 Boldface
- 2 Reduced
- 4 Underscore
- 5 Blinking
- 7 Reversed video

Example:

ESC [1; 4 m - invokes boldface and underscored characters.

ESC [0; 5 m - clears any previous attribute, then invoke blinking.

3.9.9 LSIALN - Screen Alignment (LSI Private)

ESC # 8

The screen alignment (LSIALN) control sequence fills the entire display screen with uppercase E's for screen focus and alignment. The cursor is set to line 1/column 1.

3.9.10 LSISTBM - Set Top and Bottom Margins (LSI Private)

ESC [Pn; Pn r

The set top and bottom margins (LSISTBM) control sequence defines the scrolling region of the display screen. The parameters Pn; Pn define the line numbers of the scrolling region. The first parameter is the line numbers of the first line in the scrolling region, and the second parameter defines the bottom line. The default value, when no parameters are specified, is the entire screen with no margins.

The scrolling region must be at least two lines, with the first number specified smaller than the second number. The cursor is placed in the home position (first line, first column).

Pn = numeric parameter

Example:

ESC [1; 10 r - specifies the scrolling region as line 1 through 10.

3.9.11 TBC - Tabulation Clear

ESC [Ps g

The tabulation clear (TBC) control sequence is used to clear one or all horizontal tab stops. The tabulation to be cleared is determined by the selective parameter Ps.

Ps = selective parameter

Parameter (Ps) Meaning

- 0 Clear the horizontal tab stop at the active cursor position.
- 3 Clear all horizontal tab stops.

The default value when no parameter is specified is zero (0). All other parameter values besides the zero (0) and three (3) are ignored.

3.10 SET/RESET MODE

The set and reset mode control sequences specifies the mode of operation for the ADM 36. Table 3-12 summarizes the modes that are changed with the set and reset control sequence parameters.

Table 3-12. Set/Reset Mode Control Sequence Parameters

PARAMETER (Ps)	SET MODE MEANING	RESET MODE MEANING
0	Error (ignored)	Error (ignored)
4	Insertion Mode	Replacement Mode
6	Erasure Mode-Erase all screen	Erasure Mode-Erase unprotected screen
20	New Line Mode	Line Feed Mode
?1	Cursor Keys - Application Mode	Cursor Keys - ANSI Cursor Control Mode
?2	ANSI Mode*	VT-52 Mode
?3	132 Columns	80 Columns
?4	Scroll Mode - Smooth	Scroll Mode - Jump
?5	Black-on-White Screen Mode	White-on-Black Screen Mode
?6	Origin Mode - Relative Cursor Address	Origin Mode - Absolute Cursor Address
?7	Wraparound Mode On	Wraparound Mode Off
?8	Auto-Repeat Mode On	Auto-Repeat Mode Off
?18	Form Feed Mode On	Form Feed Mode Off
?19	Print Extend Mode - full	Print Extent Mode - partial

*Ignored in VT-52 Mode

The set and reset mode control sequences and modes that are changed by these control sequences are explained in the following paragraphs.

3.10.1 RM - Reset Mode

ESC [Ps;...Ps 1*

(*lower case "L")

The reset mode (RM) control sequence resets one or more ADM 36 modes as specified by the parameters Ps;...Ps. Each mode to be reset must be specified by separate parameters.

Ps = selective parameters (as specified in Table 3-12)

Example:

ESC [4; 20 1 - resets mode to replacement and line feed mode.

ESC [?4; ?5 1 - resets mode to jump scroll and white-on-black screen mode.

3.10.2 SM - Set Mode

ESC [Ps;...Ps h

The set mode (SM) control sequence sets one or more modes within ADM 36, as specified by the parameters Ps;...Ps. Each mode to be set is specified by a separate parameter. A mode is set until reset by a reset (RM) control sequence.

Ps = selective parameter (as specified in Table 3-12)

Example:

ESC [?3; ?4; ?5 h - sets the ADM 36 modes to 132 columns, smooth scroll, and black-on-white screen.

3.11 MODES APPLICABLE TO SET/RESET

The following modes are specified by parameters in either the set (SM) or reset (RM) modes in the ADM 36.

3.11.1 LSIANM - ANSI/VT-52 Mode - (LSI Private)

The ANSI/VT-52 mode (LSIANM) is specified by a parameter in either the set or reset mode. In the set state only ANSI compatible escape and control sequences are interpreted and executed. In the reset state only VT-52 compatible escape sequences are interpreted and executed. The following control sequences specifies and ANSI/VT-52 mode:

ESC [?2 l - set VT-52 mode
ESC [?2 h - Set ANSI mode

3.11.2 LSIARM - Auto Repeat Mode (LSI Private)

The auto repeat mode (LSIARM) is specified by a parameter in either the set mode (SM) or reset mode (RM). In the set state certain keyboard keys automatically repeat (see "Auto Repeat", Section 2). In the reset state the keyboard keys do not automatically repeat. The following set/reset mode control sequences specifies the auto repeat mode:

ESC [?8 h - set auto repeat on
ESC [?8 l - reset auto repeat off

3.11.3 LSICKM - Cursor Keys Mode (LSI Private)

The cursor keys mode (LSICKM) is specified by a parameter in either the set mode (SM) or reset mode (RM). The cursor keys mode is only effective when the terminal is in Keypad Application Mode (see "Keypad Application Mode - LSIKPAM" this section), and the ANSI mode is set (see "ANSI/VT-52 Mode" this section). If the above conditions are met, the set state causes the four cursor keys will send application functions. In the reset state the four cursor keys will send ANSI cursor control commands. The following control sequences specifies the cursor keys mode:

ESC [?1 h - set application mode
ESC [?1 l - set numeric mode

3.11.4 LSICOLM - Column Mode (LSI Private)

The column mode (LSICOLM) is specified by a parameter in either the set mode (SM) or reset mode (RM) control sequence. In the set state the maximum number of columns per line on the display screen is 132. In the reset state the maximum number of columns per line on the display screen is set to 80. The following control sequences specifies the column mode.

ESC [?3 h - set 132 columns
ESC [?3 l - set 80 columns

3.11.5 ERM - Erasure Mode

The erasure mode (ERM) is specified by a parameter in either the set mode (SM) and reset mode (RM) control sequence. In the set state, erase functions erase all characters regardless of their protected state. In the reset state, erase functions erase only unprotected characters. (See "Define Area Qualification - DOQ", this section, for an explanation of protected and unprotected areas.) The following control sequences specifies the erasure mode:

ESC [6 h - set mode control sequence (erases all characters)
ESC [6 l - reset mode control sequence (erases unprotected only)

3.11.6 LSIFF - Form Feed Mode (LSI Private)

The form feed mode (LSIFF) is specified by a parameter in either the set mode (SM) or reset mode (RM) control sequence. In the set state a form feed character is added to the characters at the end of the Print Screen function (see "Print Screen", this section). In the reset state the carriage return (CR) and line feed (LF) are always transmitted to the printer as part of the Print Screen function; no print terminator character is added. The following control sequences specifies the form feed mode:

ESC [?18 h - set mode control sequence (form feed character added to Print Screen)

ESC [?18 l - reset mode control sequence (no print terminator character)

3.11.7 IRM - Insert/Replacement Mode

The insert/replacement mode (IRM) is specified by a parameter in either the set mode (SM) and reset mode (RM) control sequence. In the set state the terminal is in insert mode and the keyboard indicator light (L3) is illuminated. In the insert mode all incoming characters are placed at the active cursor position, and all characters to the right on the active line are shifted to the right. All characters shifted past the right margin are not wrapped around to the next line, but are dropped from memory.

In the reset state the terminal is in replacement mode and all incoming characters overlay the current characters starting at the active cursor position.

The following control sequences specifies the insert/replacement mode:

ESC [4 h - set insert mode

ESC [4 l - set replacement mode

3.11.8 LNM - Line Feed/New Line Mode

The line feed/new line mode (LNM) is specified by a parameter in either the set mode (SM) or reset mode (RM) control sequence. In the set state the line feed (LF) moves the cursor to the first character position on the following line, and causes the RETURN key to send a carriage return (CR) and a line feed code. The CR and LF is called the New Line (NL) option.

In the reset state the LF is interpreted as a vertical movement of the active position only (as defined in ANSI Standard X3.4-1977), and causes the RETURN key to send the single CR code.

The following control sequence specifies the line feed/new line mode:

ESC [20 h - set new line option

ESC [20 l - set line feed only

Note

The line feed/new line mode does not affect the Index (IND) or Next Line (NEL) control sequences.

3.11.9 LSIOM - Origin Mode (LSI Private)

The origin mode (LSIOM) specifies the origin (home position) of the cursor on the display screen. The origin mode is specified by a parameter in either the set mode (SM) or reset mode (RM) control sequence. In the set state the origin is the upper-left character position within the current margin settings. The line and column numbers are relative to the current margins. The cursor cannot be positioned outside these margins.

In the reset state the origin is the upper-left character position (home position) on the display screen. The line and column numbers are independent of the current margin settings. The cursor may be positioned outside the current margin settings by the Cursor Position (CUP) and Horizontal and Vertical Position (HVP) control sequences. (See "Cursor Position - CUP" and "Horizontal and Vertical Position - HVP", this section for an explanation of these cursor control sequences).

The following control sequences specifies the origin mode of the screen:

ESC [?6 h - set relative cursor address - origin mode

ESC [?6 l - set absolute cursor address - origin mode

Note

The cursor is moved to the home position when the origin mode is set or reset. Lines and columns are numbered consecutively, with the origin (home position) being line 1, column 1.

3.11.10 LSIEXT - Print Extent Mode (LSI Private)

The print extent mode (LSIEXT) is specified by a parameter in either the set mode (SM) or reset mode (RM) control sequence. In the set state all characters on the display screen are transmitted to the printer during a Print Screen function (see "Print Screen", **this section**). In the reset state only characters between the scrolling region margins are transmitted to a printer during a Print Screen function. (See "Set Top and Bottom Margins - LSISTBM", **this section**, for an explanation of the scrolling region.) The following control sequences specifies the print extent mode:

ESC [?19 h - print full screen
ESC [?19 l - print only the scrolling region contents

3.11.11 LSI SCLM - Scrolling Mode (LSI Private)

The scrolling mode (LSI SCLM) is specified by a parameter in either the set mode (SM) or reset mode (RM) control sequence. In the set state the scroll is smooth, and scrolls at a maximum rate of six lines per second. In the reset state the scroll "jumps" instantaneously. The following control sequences specifies the scrolling mode:

ESC [?4 h - set smooth scroll
ESC [?4 l - set jump scroll

3.11.12 LSI SCNM - Screen Mode (LSI Private)

The screen mode (LSI SCNM) is specified by a parameter in either the set mode (SM) or reset mode (RM) control sequence. The set state causes the screen to be white with black characters. The reset state causes the screen to be black with white characters. The following control sequences specifies the screen mode:

ESC [?5 h - set black-on-white screen mode
ESC [?5 l - set white-on-black screen mode

3.11.13 LSIWM - Wrap-around Mode (LSI Private)

The wrap-around mode (LSIWM) is specified by a parameter in either the set mode (SM) or reset mode (RM). In the set state all displayable characters received after the last character position on the line are advanced to the first character position on the next line. In the reset state all characters received at the last character position on the line will replace the previous displayed character. The following control sequences specifies the wrap-around mode:

ESC [?7 h - set wrap-around mode
ESC [?7 l - no wrap-around feature, replaces last character on line

3.12 OUTPUT AND PRINT FUNCTIONS

The following control sequences specifies the output and print functions of the ADM 36. The output and print functions are listed in alphabetical order by function.

3.12.1 DSR - Device Status Report

ESC [P s n

The device status report (DSR) control sequence reports the general status of the device sending the control sequence and/or requests a status report from the receiving device as specified by the parameter Ps.

Ps = selective parameter

Parameter (Ps) Meaning

- 0 Response - ready, no malfunctions detected
- 3 Response - malfunction, retry
- 5 Command - please report status using DSR
- 6 Command - please report active position using a CPR control sequence

- ?10 Response - printer is ready
- ?11 Response - printer is not ready
- ?13 Response - no printer
- ?15 Command - please report printer status

3.12.2 MC - Media Copy

ESC [Ps i

The media copy (MC) control sequence controls the transfer of data between the terminal and an auxiliary input/output device. The direction of the data transfer and the identification of the auxiliary device is specified by the parameter Ps.

Ps = selective parameter

Parameter (Ps) Meaning

- 0 Dump screen contents to printer (Print Screen function, explained below)
- 4 Terminate printer controller mode
- 5 Select printer controller mode (Printer Controller Mode, explained below)
- ?1 Print line containing cursor (Line function, explained below)
- ?4 Terminate line-at-a-time mode
- ?5 Select line-at-a-time mode (Auto Print Mode, explained below)

The Print Screen function is selected from the video terminal keyboard (by pressing the SHIFT and ENTER keys), or by the host computer. The print screen function transmits a complete copy of the screen display to the serial printer. Depending on the selection of the Print Extent Mode, either the entire screen or the contents within the scrolling region are transmitted to the printer. The scrolling region is selected by the Set Top and Bottom Margins control

sequence. (See "Set Top and Bottom Margins - LSISTBM" and "Print Extent Mode - LSIEXT" this section for a detailed explanation.)

The Printer Controller mode is selected by the host computer. When Printer Controller mode is selected all characters received from the host are transmitted to the serial printer without displaying (not displayed on the screen of the video terminal), converting, or altering the characters in any way.

The Print Cursor Line function is selected by the host computer. This function prints the line of the screen containing the cursor. The cursor position is not changed by this function; and the line on the screen cannot be changed before being printed.

The Auto Print (line-at-a-time) mode is selected from the video terminal keyboard (by pressing the CNTL and ENTER keys), or by the host computer. When auto print is selected one line at a time is printed from the video display screen. The line is printed as soon as the cursor is moved off the line by a line feed (LF), form feed (FF), or vertical tab character. When the cursor moves off the line, the line cannot be altered before being printed.

Examples:

ESC [0 i - outputs the screen contents to a printer

ESC [5 i - select the Printer Controller Mode (all characters are transmitted to printed without being displayed on the screen).

ESC [4 i - terminates the Printer Controller Mode.

3.13 LED CONTROL FUNCTIONS

The following paragraphs explain the control sequence function that controls the LEDs (light emitting diodes) on the terminal keyboard.

3.13.1 LSILL - Load LEDs (LSI Private)

ESC [Ps ;...Ps q

Default Value = 0

The load LEDs (LSILL) control sequence clears or loads any combination of the four programmable LEDs on the terminal keyboard, as specified by the parameter Ps. The LEDs are located on the upper-left corner of the keyboard and are numbered L1 through L4. Lighted LED's are extinguished only by the parameter zero (0) (Ps = 0).

Ps = selective parameter

Parameter (Ps) Meaning

- 0 Clear all LEDs (L1 through L4)
- 1 Illuminate L1
- 2 Illuminate L2
- 3 Illuminate L3
- 4 Illumniate L4

3.14 HOST/TERMINAL STATUS AND CONTROL FUNCTIONS

The following control sequences specify the host and terminal status and control functions. These functions are listed in alphabetical order by function.

3.14.1. DA - Device Attributes

ESC [Ps c

The device attributes (DA) control sequence requests a device to send a device attributes control sequence to identify itself to the host with either no parameter or a parameter of zero (0). The DA control sequence also responds to the request for identification by parameters whose value is greater than zero. The numeric parameter for the DA control sequence are as follows:

Ps = selective parameter

Parameter (Ps) Meaning

- 0 Request - (identification)
- ?1;11 Response - Advanced Video Option (AVO) and Printer Port

3.14.2 LSIID - Identify Terminal (LSI Private)

ESC Z

The identify terminal (LSIID) control sequence responds to a request from host for terminal identification the same as the Device Attributes (DA) control sequence. (See "Device Attributes - DA" control sequence **this section.**)

Note

*Not recommended for new design.
Included for compatability only.*

3.14.3 LSITST - Invoke Self-Test (LSI Private)

ESC [2; Ps y

The invoke self-test (LSITST) invokes a test to be performed, as specified by the parameter (Ps) indicating the test.

Ps = selective parameter

Parameter (Ps) Meaning

- 0 No test is performed, screen is cleared and video terminal operates with last stored SET-UP features settings.
- 1 Power-up self-test
- 2 Data loop-back test*
- 9 Power-up self-test indefinitely
- 10 Data loop-back test indefinitely*

*Requires loop-back connector (pin 2 to 3 of RS-232 host link).

3.14.4 LSIREPTPARM - Report Terminal Parameters (LSI Private)

ESC [3 ; <comm par>; <comm nbits>; <comm xspeed>; <comm rspeed>; <clkmul>; <flags>; <ANSI/VT-52>; <prt par>; <prt nbits>; <prt xspeed>; <prt rspeed>x

Table 3-13. Report Terminal Parameters.

PARAMETERS	PARAMETER VALUE	DEFINITION
<comm par>	1	No parity set for communication interface.
	2	Space parity set for communication interface.
	3	Mark parity set for communication interface.
	4	Odd parity set for communication interface.
	5	Even Parity set for communication interface.
<comm nbits>	1	8 data bits per character
	2	7 data bits per character
<comm xspeed>	0	50 Bits per second
	8	75 Bits per second
	16	110 Bits per second
	24	134.5 Bits per second
	32	150 Bits per second
	40	200 Bits per second
	48	300 Bits per second
	56	600 Bits per second
	64	1200 Bits per second
	72	1800 Bits per second
	80	2000 Bits per second
	88	2400 Bits per second
	96	3600 Bits per second
104	4800 Bits per second	
112	9600 Bits per second	
120	19200 Bits per second	
<comm rspeed>	Same as <com xspeed> parameter.	
<clkmul>	1	Bit rate multiplier is 16.
<flags>	0-15	Communicates the flag value of SET-UP B. The flag value is a decimal number between 0 and 15, inclusive.
<ANSI/VT-52>	0	VT-52 Mode
	1	ANSI Mode
<prt par>	Same as <comm par> parameters	
<prt nbits>	Same as <comm nbits> parameters	
<prt xspeed>	Same as <comm xspeed> parameters.	
<prt rspeed>	Same as <comm xspeed> parameters.	

Table 3-14. VT-52 Mode Escape Sequence Summary

VT-52 MODE FUNCTIONS	ESCAPE SEQUENCE
Cursor Up	ESC A
Cursor Down	ESC B
Cursor Left	ESC D
Cursor Right	ESC C
Cursor To Home	ESC H
Cursor Up With Scroll	ESC I
Direct Cursor Address	ESC Y Pn Pn
Enter Alternate Keypad Mode	ESC =
Enter ANSI Mode	ESC <
Enter Graphics Mode	ESC F
Erase To End Of Line	ESC K
Erase To End Of Screen	ESC J
Exit Alternate Keypad Mode	ESC >
Exit Graphics Mode	ESC G
Identify	ESC Z
Inverse Video	ESC 3
Normal Video	ESC 4
Print Cursor Line Function	ESC V
Print Screen Function	ESC [
Select Auto Print (Line-at-a-Time) Mode	ESC ^
Select Printer Controller Mode	ESC W
Terminate Auto Print (Line-at-a-Time) Mode	ESC _
Terminate Printer Controller Mode	ESC X

The report terminal parameters (LSIREPTPARM) control sequence is transmitted on receipt of a Request Terminal Parameters (LSIREQTPARM) control sequence from the host. Table 3-14 lists all the parameters and definitions of each.

3.14.5 LSIREQTPARM - Request Terminal Parameters

ESC [lx

The request terminal parameters (LSIREQTPARM) control sequence is sent by the host to determine the status of selected terminal parameters. The LSIREQTPARM control sequence is sent by the terminal when requested by the LSIREQTPARM control sequence. (See "Report Terminal Parameters-LSIREPTPARM", this section for reference.)

3.14.6 RIS - Reset (Terminal) To Initial State

ESC c

The reset to initial state (RIS) control sequence resets the terminal to its initial state (the state it has after power-on). The RIS control sequence also executes the power-up self-test.

3.15 VT-52 MODE CONTROL SEQUENCES

The following paragraphs detail the escape sequences that are software compatible to the VT-52 control sequences. The control sequences are listed in alphabetical order by function, and are summarized in Table 3-14.

3.15.1 Cursor Up

ESC A

The cursor up escape sequence moves the active cursor position up one position without altering the horizontal position. The cursor will stop at the top margin if an attempt is made to move up past this margin.

3.15.2 Cursor Down

ESC B

The cursor down escape sequence moves the active cursor position down one position without altering the horizontal position. The cursor will stop at the bottom margin if an attempt is made to move down this margin.

3.15.3 Cursor Left

ESC D

The cursor left escape sequence moves the active cursor position to the left. The cursor will stop at the left margin if an attempt is made to move the cursor past this margin.

3.15.4 Cursor Right

ESC C

The cursor right escape sequence moves the active cursor position to the right. The cursor will stop at the right margin if an attempt is made to move past this margin.

3.15.5 Cursor To Home

ESC H

The cursor to home escape sequence moves the cursor to the home position (line 1, column 1).

3.15.6. Cursor Up With Scroll

ESC I

The cursor up with scroll escape sequence moves the active cursor position up position without altering the horizontal position. If the cursor is on the top line of the screen, a scroll down is performed.

3.15.7 Direct Cursor Address

ESC Y Pn Pn

The direct cursor address screen escape sequence moves the cursor to the specified

line and column number. The line and column numbers are sent as ASCII codes whose values are the number plus 1F (Hex).

PN = 1F (Hex) plus line/column number.

Example:

ESC Y space space - moves cursor to home position.

3.15.8 Enter Alternate Keypad Mode

ESC =

The alternate keypad mode escape sequence causes the auxiliary keypad keys to send unique identifiable escape sequences for use by applications programs.

Note

See "Keypad Modes" control sequence in the ANSI Control Sequence, this section for information concerning the alternate keypad mode options.

3.15.9 Enter ANSI Mode

ESC <

The enter ANSI mode escape sequence causes all subsequent escape sequences to be interpreted according to ANSI Standards X3.64-1979 and X3.41-1974. All alternate sequences in this section then will not be recognized.

3.15.10 Enter Graphics Mode

ESC F

The enter graphic mode escape sequence causes the special graphics character set to be used. (See Table 3-8, Special Graphics Character Sets for a list of the special graphics characters.)

3.15.11 Erase to End of Line

ESC K

The erase to end of line escape sequence erases all characters from the active cursor position to the end of the current line. The active cursor position is not changed.

3.15.12 Erase to End of Screen

ES J

The erase to end of screen escape sequence erases all characters from the active cursor position to the end of the screen. The active cursor position is not changed.

3.15.13 Exit Alternate Keypad Mode

ESC >

The exit alternate keypad mode exits the application keypad mode and returns the auxiliary keypad to numeric mode. The auxiliary keypad then sends the ASCII codes for the functions or characters engraved on the keys.

3.15.14 Exit Graphic Mode

ESC G

The exit graphics mode escape sequence cancels the special graphics character set mode and causes the standard ASCII character set to be used.

3.15.15 Identify

ESC Z

The identify escape sequence causes the terminal to send its identifier escape sequence to the host. The terminal escape identifier escape sequence is as follows:

ESC / Z

3.15.16 Inverse Video

ESC 3

The inverse video escape sequence changes to display screen to black characters on a white screen.

3.15.17 Normal Video

ESC 4

The normal video escape sequence causes the video terminal screen to display white characters on a black screen (normal screen when powered-up).

3.15.18 Print Cursor Line Function

ESC V

The print cursor line function prints the line of the display screen containing the active cursor. The cursor position is not changed by

this function. Once the print cursor line function is selected, the line cannot be changed before being printed.

3.15.19 Print Screen Function

ESC [

The print screen function escape sequence transmits a complete copy of the video terminal screen display to the serial printer. After the print screen function is selected, the contents of the screen cannot be changed before being printed.

3.15.20 Select Auto Print (Line-at-a-Time) Mode

ESC ^

The select auto print (line-at-a-time) mode escape sequence causes the video terminal screen to print one line at a time. A line on the display screen is printed as soon as the cursor moves off the line. The cursor is moved off by a line feed (LF), form feed (FF), or vertical tab character.

3.10.21 Select Printer Controller Mode

ESC W

The select printer controller escape sequence mode causes all characters received from the host to be transmitted to the serial printer without displaying, converting, or altering the characters in any way.

3.15.22 Terminate Auto Print (Line-at-a-Time) Mode

ESC -

The terminate auto print escape sequence terminates the Auto Print Mode (as explained in "Select Auto Print (Line-at-a-Time) Mode", this section).

3.15.23 Terminate Printer Controller Mode

ESC X

The terminate printer controller mode escape sequence terminates the printer controller mode (as explained in "Select Printer Controller Mode", this section).

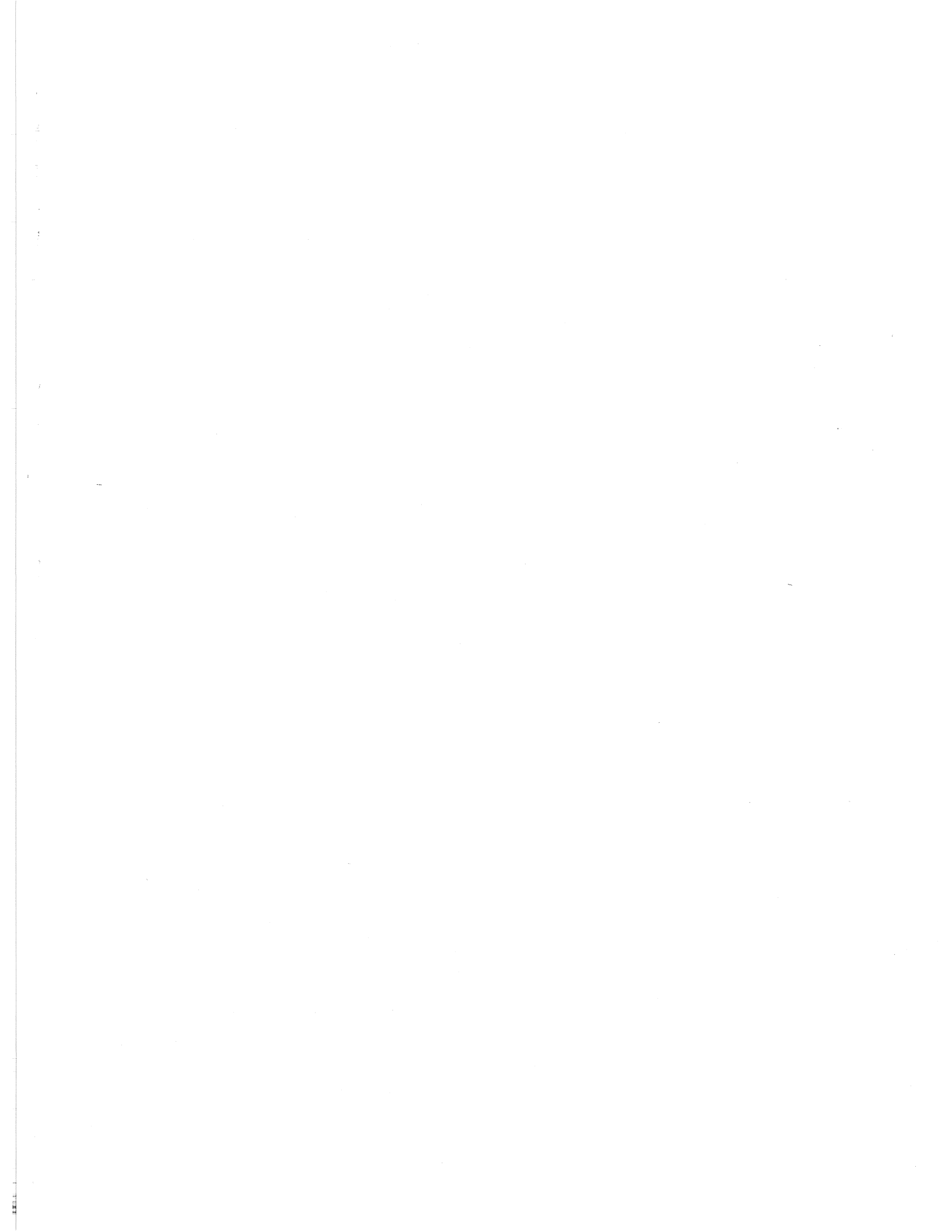

**APPENDIX A
OPERATORS
QUICK REFERENCE
CHARTS**

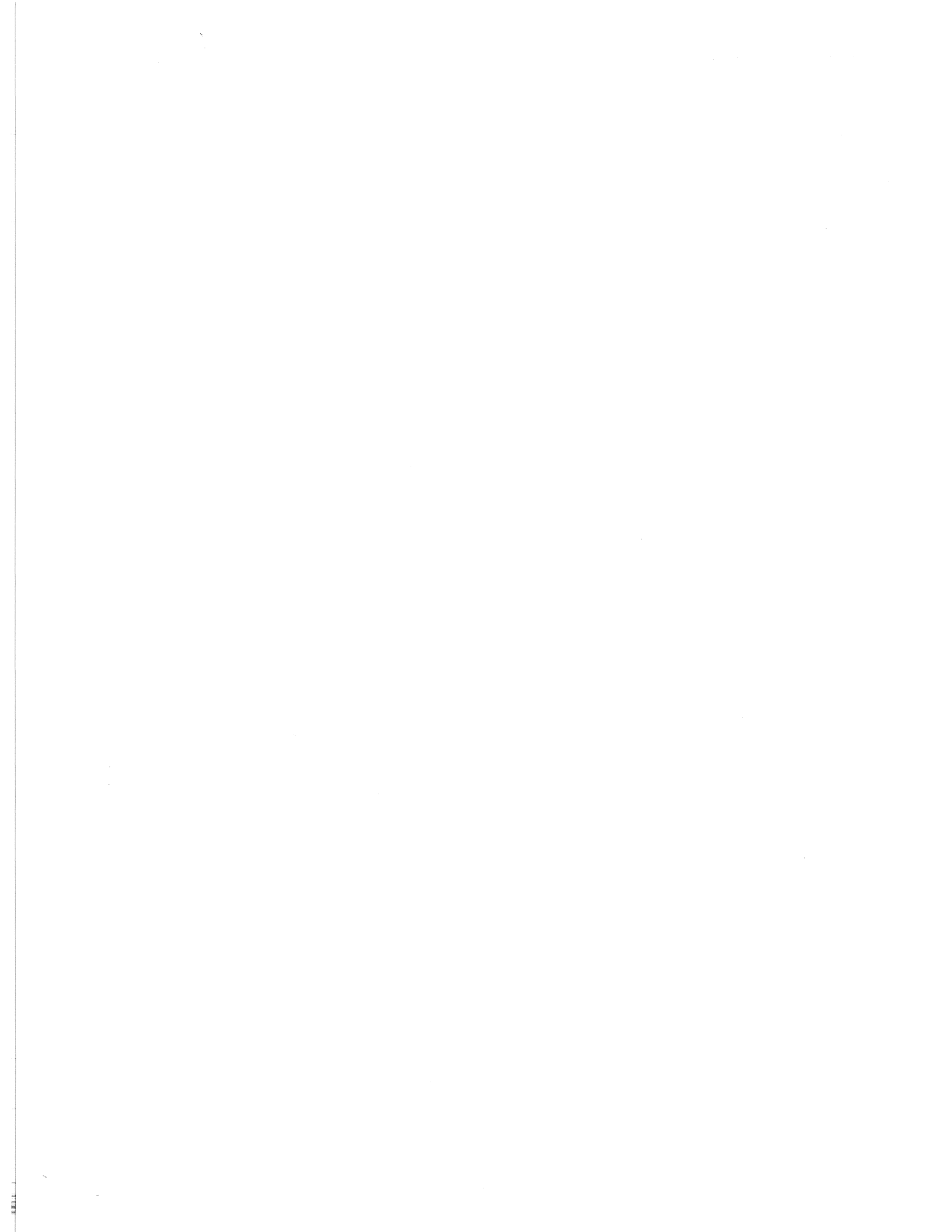

ASCII CONTROL CODE CHART

B7 B6 BITS B5 B4 B3 B2 B1	0	0	0	0	1	1	1	1
	0	0	0	1	0	0	1	1
	CONTROL		NUMBERS SYMBOLS		UPPER CASE		LOWER CASE	
0 0 0 0	0 NUL	20 DLE	40 SP	60 0	100 @	120 P	140 '	160 p
0 0 0 1	1 SOH	21 DC1	41 !	61 1	101 A	121 Q	141 a	161 q
0 0 1 0	2 STX	22 DC2	42 "	62 2	102 B	122 R	142 b	162 r
0 0 1 1	3 ETX	23 DC3	43 #	63 3	103 C	123 S	143 c	163 s
0 1 0 0	4 EOT	24 DC4	44 \$	64 4	104 D	124 T	144 d	164 t
0 1 0 1	5 ENQ	25 NAK	45 %	65 5	105 E	125 U	145 e	165 u
0 1 1 0	6 ACK	26 SYN	46 &	66 6	106 F	126 V	146 f	166 v
0 1 1 1	7 BEL	27 ETB	47 '	67 7	107 G	127 W	147 g	167 w
1 0 0 0	8 BS	30 CAN	50 (70 8	110 H	130 X	150 h	170 x
1 0 0 1	9 HT	31 EM	51)	71 9	111 I	131 Y	151 i	171 y
1 0 1 0	10 LF	32 SUB	52 *	72 :	112 J	132 Z	152 j	172 z
1 0 1 1	11 VT	33 ESC	53 +	73 ;	113 K	133 [153 k	173 {
1 1 0 0	12 FF	34 FS	54 ,	74 <	114 L	134 \	154 l	174 !
1 1 0 1	13 CR	35 GS	55 -	75 =	115 M	135]	155 m	175 }
1 1 1 0	14 SO	36 RS	56 .	76 >	116 N	136 ^	156 n	176 ~
1 1 1 1	15 SI	37 US	57 /	77 ?	117 O	137 _	157 o	177 (DEL) RUBOUT

KEY

octal	10	←	LSI CURSOR CONTROL CODE
	BS		ASCII character
hex	8	8	decimal

Get familiar with ASCII and LSI control codes with the help of this handy table.

SET-UP MODE KEYS SUMMARIZED

KEY	SET-UP A MODE	SET-UP B MODE
SET-UP	Exit SET-UP mode	Exit SET-UP mode
2 (Set/clear tab)	Set/Clear tab at current position	Ignored
3 (Clear all tabs)	Clear all tabs	Ignored
4 (Line/local)	Go to SET-UP B - toggle line/local	Toggle line/local
5 (Set-up A/B)	Go to SET-UP B	Go to SET-UP A
6 (Toggle)	Ignored	Change feature setting
7 (Transmit speed)	Go to SET-UP B transmit baud rate	Change transmit baud rate
8 (Receive speed)	Go to SET-UP B receive baud rate	Change receive baud rate
9 (80/132 columns)	Toggle 80/132	Toggle 80/132
0 (Reset)	Resets terminal	Resets terminal
A (Shifted)	Ignored	Enter Answerback mode
R (Shifted)	Recall features from NVR	Recall features from NVR
S (Shifted)	Save features to NVR	Save features to NVR
T (Shifted)	Recall default tabs	Ignored
D (Shifted)	Recall default features	Recall default features
↑	Increase brightness	Increase brightness
↓	Decrease brightness	Decrease brightness
→	Moves cursor to right	Move to next features
←	Moves cursor to left	Return to previous feature
Space	Move cursor to right	Move to next feature
RETURN	Return cursor to left	Return to first feature

SPECIAL GRAPHICS AND WIDE POINT GRAPHICS CHARACTER SETS

Hex Code	USASCII	Wide Point Graphics	Line Graphics and VT52 Character Set
5F	_ (underscore)	(Blank)	(Blank)
60	` (Grave)	Horizontal line scan 9 and 10	◇ Diamond
61	a	Horizontal line scan 7 and 8	▣ Checkerboard
62	b	Horizontal line scan 7, 8, 9 and 10	HT Horizontal Tab
63	c	Horizontal line scan 5 and 6	FF Form feed
64	d	Horizontal line scan 5, 6, 9 and 10	CR Carriage return
65	e	Horizontal line scan 5, 6, 7 and 8	LF Line feed
66	f	Horizontal line scan 5, 6, 7, 8, 9 and 10	° Degree
67	g	Horizontal line scan 3 and 4	± Plus/minus
68	h	Horizontal line scan 3, 4, 9 and 10	NL New line
69	i	Horizontal line scan 3, 4, 7 and 8	VT Vertical tab
6A	j	Horizontal line scan 3, 4, 7, 8, 9 and 10	┘ Lower right corner
6B	k	Horizontal line scan 3, 4, 5 and 6	┐ Upper right corner
6C	l	Horizontal line scan 3, 4, 5, 6, 9 and 10	└ Upper left corner
6D	m	Horizontal line scan 3, 4, 5, 6, 7, and 8	└ Lower left corner
6E	n	Horizontal line scan 3, 4, 5, 6, 7, 8, 9 and 10	⊕ Crossing lines

ANSI CONTROL SEQUENCES SUMMARY

FUNCTION GROUP	DESCRIPTION	CONTROL SEQUENCE
Special Graphics and Character Set Selection	Double-High Line Double-Wide Line Select Character Set Single-Wide, Single-High Line	ESC # 3 (top half) ESC # 4 (bottom) ESC (Fs Designate G0 Character Set ESC) Fs Designate G1 Character Set ESC # 5
Cursor Functions	Cursor Backward Cursor Down Cursor Forward Cursor Position Cursor Position Report Cursor Up Horizontal and Vertical Position (Set Cursor) Index (Cursor Down With Scroll) New Line With Scroll Restore Cursor and Attributes Reverse Index (Cursor Up With Scroll) Save Cursor and Attributes	ESC [Pn D ESC [Pn B ESC [Pn C ESC [Pn; Pn H ESC [Pn; Pn R ESC [Pn A ESC [Pn; Pn f ESC D ESC E ESC 8 ESC M ESC 7

VT-52 MODE ESCAPE SEQUENCE SUMMARY

VT-52 MODE FUNCTIONS	ESCAPE SEQUENCE
Cursor Up	ESC A
Cursor Down	ESC B
Cursor Left	ESC D
Cursor Right	ESC C
Cursor To Home	ESC H
Cursor Up With Scroll	ESC I
Direct Cursor Address	ESC Y Pn Pn
Enter Alternate Keypad Mode	ESC =
Enter ANSI Mode	ESC <
Enter Graphics Mode	ESC F
Erase To End Of Line	ESC K
Erase To End Of Screen	ESC J
Exit Alternate Keypad Mode	ESC >
Exit Graphics Mode	ESC G
Identify	ESC Z
Inverse Video	ESC 3
Normal Video	ESC 4
Print Cursor Line Function	ESC V
Print Screen Function	ESC [
Select Auto Print (Line-at-a-Time) Mode	ESC ^
Select Printer Controller Mode	ESC W
Terminate Auto Print (Line-at-a-Time) Mode	ESC _
Terminate Printer Controller Mode	ESC X

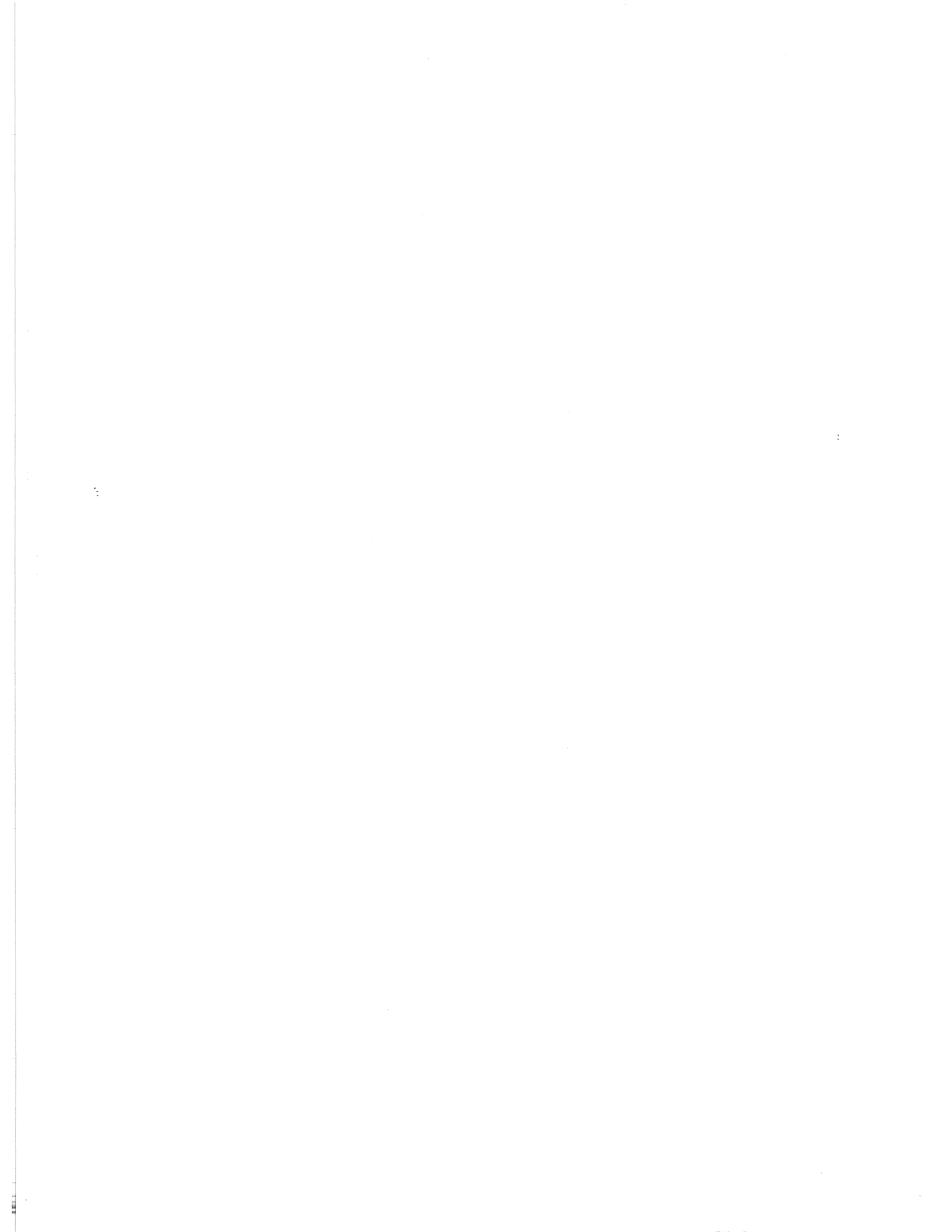



NO POSTAGE
STAMP
NECESSARY
IF MAILED IN THE
UNITED STATES

BUSINESS REPLY CARD
FIRST CLASS PERMIT NO. 3061 ANAHEIM, CALIFORNIA

POSTAGE WILL BE PAID BY ADDRESSEE:
Attn: Marketing Communications
LEAR SIEGLER, INC.
DATA PRODUCTS DIVISION
714 NORTH BROOKHURST STREET
ANAHEIM, CALIFORNIA 92803



NO POSTAGE
STAMP
NECESSARY
IF MAILED IN THE
UNITED STATES

BUSINESS REPLY CARD
FIRST CLASS PERMIT NO. 3061 ANAHEIM, CALIFORNIA

POSTAGE WILL BE PAID BY ADDRESSEE:
Attn: Marketing Communications
LEAR SIEGLER, INC.
DATA PRODUCTS DIVISION
714 NORTH BROOKHURST STREET
ANAHEIM, CALIFORNIA 92803

Let us know...
If you have any suggestions for
improving this publication, after writing
your comments, carefully cut out and
mail the pre-addressed, post-paid card to
us. All comments will be given careful
consideration, and become the property
of LEAR SIEGLER, INC.

**COMMENTS AND
SUGGESTIONS**

PUBLICATION TITLE _____

PUBLICATION NO. _____ DATE _____

YOUR NAME _____

TITLE _____

COMPANY _____

ADDRESS _____

SUGGESTIONS _____

PUBLICATION TITLE _____

PUBLICATION NO. _____ DATE _____

YOUR NAME _____

TITLE _____

COMPANY _____

ADDRESS _____

SUGGESTIONS _____



LEAR SIEGLER, INC.
DATA PRODUCTS DIVISION

714 NORTH BROOKHURST STREET, ANAHEIM, CALIFORNIA 92803
PHONE: (714) 774-1010 TELEX: 65-5444 TWX: 910-591-1157