























➔  **Better Farming Series 32 - Biogas 2: Building a Better Biogas Unit (FAO, 1986, 47 p.)**







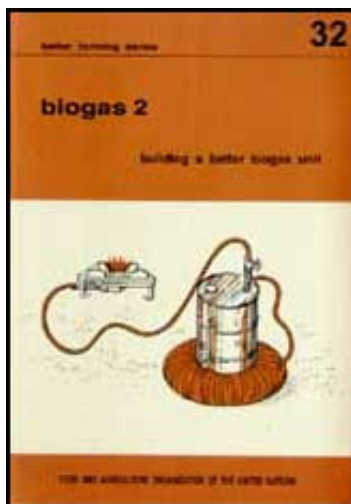

-  **(introduction...)**
-  **Preface**
-  **Introduction**
- How to build a better small biogas unit**
 -  **You will need**
 -  **Cleaning the oil drum**
 -  **Where to put your biogas unit**
 -  **Preparing the oil drum**
 -  **Testing for leaks**
 -  **Preparing the gas holder**
 -  **Attaching the gas holder**
- Putting in the waste**
 -  **The waste materials**
 -  **The starter**
 -  **Putting waste in this biogas unit**
 -  **After the waste is in**
-  **Time**
- Temperature**
 -  **(introduction...)**

-  **Cold weather protection**
-  **Scum**
-  **When the gas is made**
-  **Taking care of your biogas unit**
-  **Making more biogas**
- What more can you do?**
-  **(introduction...)**
-  **Another kind of biogas unit**



[Home](#) > [ar](#).[cn](#).[de](#).[en](#).[es](#).[fr](#).[id](#).[it](#).[ph](#).[po](#).[ru](#).[sw](#)



-  **Better Farming Series 32 - Biogas 2: Building a Better Biogas Unit (FAO, 1986, 47 p.)**
- ➔  **(introduction...)**
-  **Preface**
-  **Introduction**
- How to build a better small biogas unit**
- Putting in the waste**
-  **Time**
- Temperature**
-  **Scum**
-  **When the gas is made**
-  **Taking care of your biogas unit**

-  **Making more biogas**
-  **What more can you do?**

FOOD AND AGRICULTURE ORGANIZATION OF THE UNITED NATIONS Rome 1986

P-69







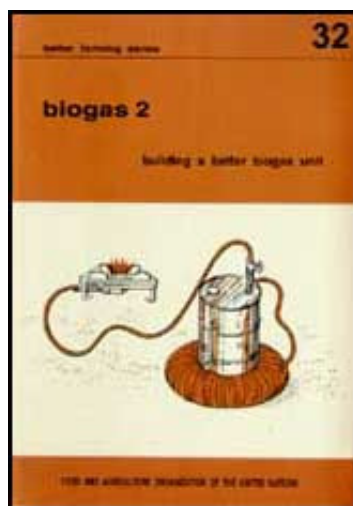

ISBN 92-5-102392-1





© FAO 1986



[Home](#) > [ar](#).[cn](#).[de](#).[en](#).[es](#).[fr](#).[id](#).[it](#).[ph](#).[po](#).[ru](#).[sw](#)



-  **Better Farming Series 32 - Biogas 2: Building a Better Biogas Unit (FAO, 1986, 47 p.)**
-  ***(introduction...)***
-  **Preface**
-  **Introduction**
-  **How to build a better small biogas unit**
-  **Putting in the waste**
-  **Time**
-  **Temperature**
-  **Scum**

-  **When the gas is made**
-   **Taking care of your biogas unit**
-  **Making more biogas**
-  **What more can you do?**

Taking care of your biogas unit

129. Always be careful when you are near a biogas unit because gas may be leaking.

130. If gas is leaking and you breathe in too much of it, It can make you very sick.

131. Never build a fire, smoke, or even light a match near the unit, because if gas is leaking it may explode.

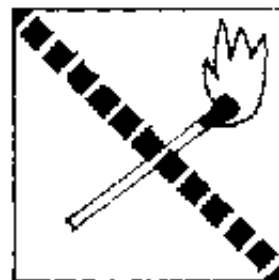

Never build fire near the unit

132. Check your biogas unit and gas lines often to be sure that there are no leaks. The note on page 34 in this booklet tells you how to check for leaks in a working biogas unit.

133. If the oil drum begins to rust, coat it with the kind of paint that is used to paint metal.



Paint the oil drum

134. About once each year, when you are taking the unit apart, wash it inside and outside with warm soapy water as you were told to do in Items 19 to 26 in this booklet.

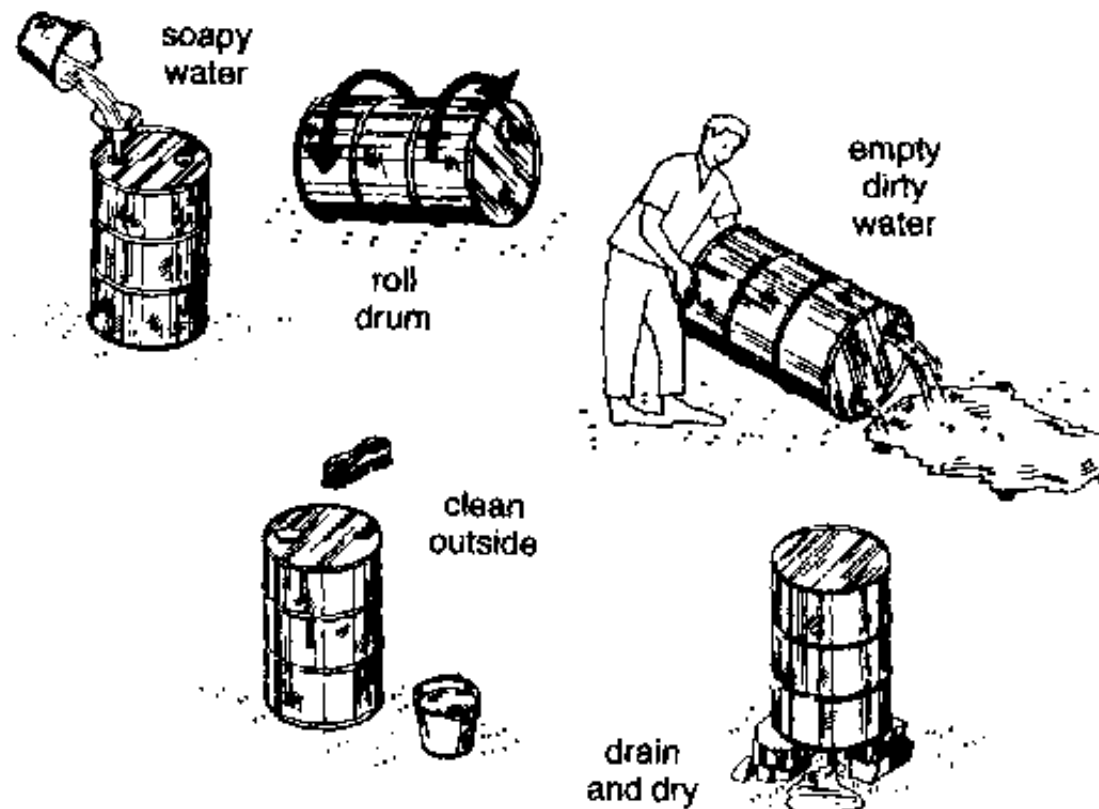

Clean the drum

135. Then paint it inside and outside as you were told to do in Items 47 and 49 in this booklet.



[Home](#) > [ar](#).[cn](#).[de](#).[en](#).[es](#).[fr](#).[id](#).[it](#).[ph](#).[po](#).[ru](#).[sw](#)

 **Better Farming Series 32 - Biogas 2: Building a Better Biogas Unit (FAO, 1986, 47 p.)**



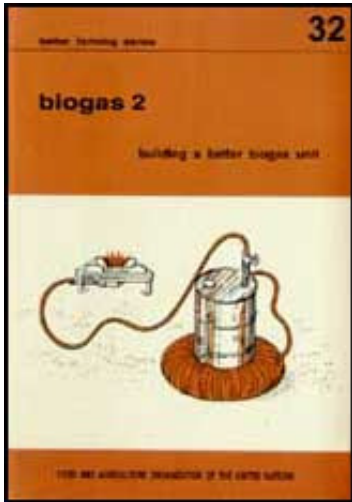

- (Introduction...)**
- Preface**
- Introduction**
- How to build a better small biogas unit**
- Putting in the waste**
- Time**
- Temperature**
- Scum**
- When the gas is made**
- Taking care of your biogas unit**
- Making more biogas**
- What more can you do?**

Making more biogas

136. As with your old biogas unit, the easiest way to make more gas is to build one or more small units and get gas from them all.

137. If you can get more oil drums, pipe, T- pieces, valves, inner tubes and gas lines, and if you have enough time, you can build and run more units.

138. The drawings below show you how to connect several units to the same gas line with T- Pieces.

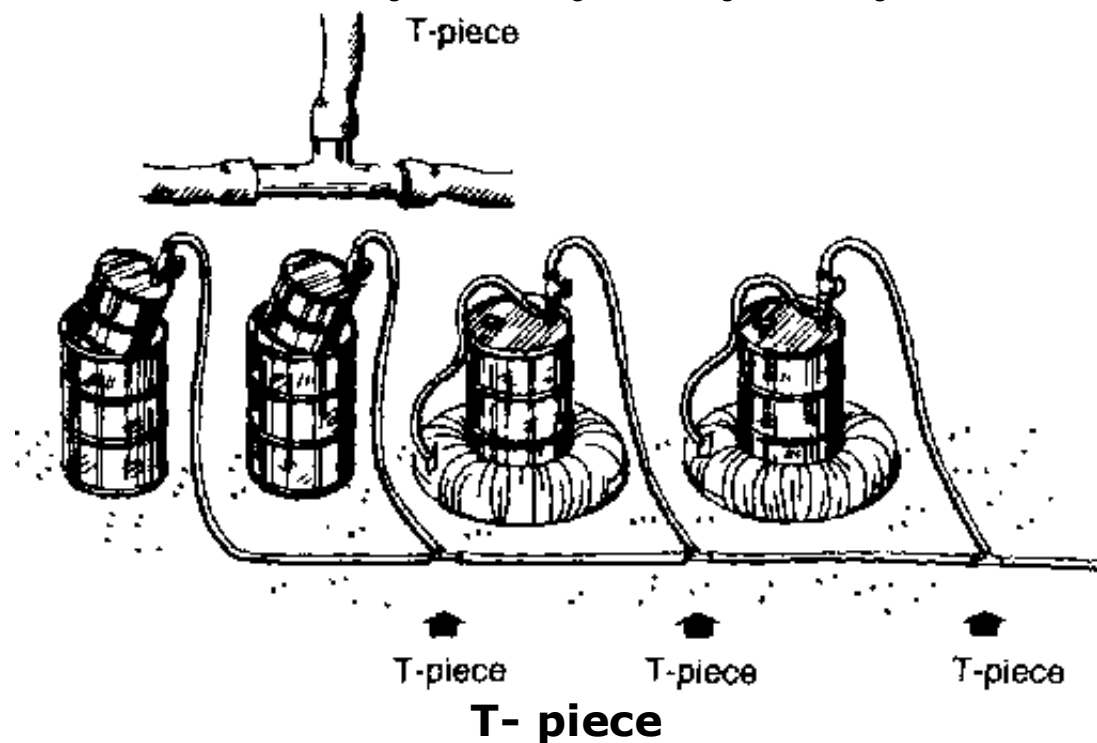

139. As you have already been told in Booklet No. 31, when you have several biogas units, fill them with waste at different times. That way, when all the gas in one unit has been used, you will get gas from another unit that is still working.



[Home](#) > [ar.cn.de.en.es.fr.id.it.ph.po.ru.sw](#)

 **Better Farming Series 32 - Biogas 2: Building a Better Biogas Unit (FAO, 1986, 47 p.)**

 **What more can you do?**

 **(introduction...)**

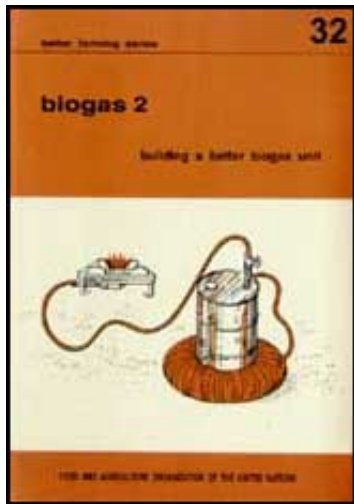

Another kind of biogas unit

Better Farming Series 32 - Biogas 2: Building a Better Biogas Unit (FAO, 1986, 47 p.)

What more can you do?

140. The biogas unit that you learned to build in Booklet No. 31 and the biogas unit that you learned to build in this booklet are both small units that use one drum for the waste holder.

141. With both of these small units you put in all of the waste when you first began. Then, when all of the gas was made, you cleaned out the unit, used the waste as fertilizer and started all over again.

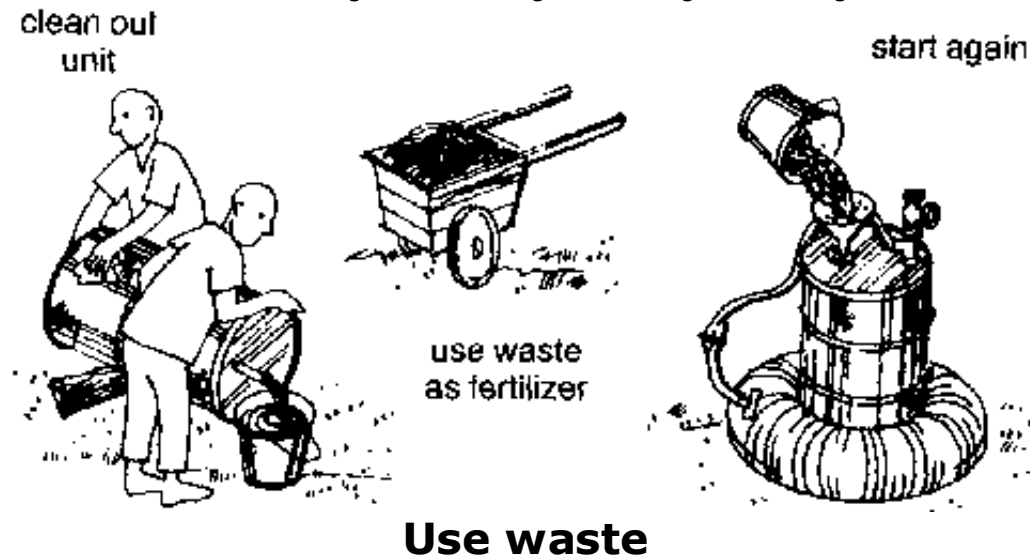

142. By building and using either or both of these units you learned a lot from your experience.

143. Now, let us look at still another biogas unit that you can build using what you have learned to help you.

Another kind of biogas unit

144. This unit is bigger and better than your first two units. It is also more difficult to build and to use.

145. This kind of biogas unit can also be built using oil drums with the same kind of pipe fittings that you used before.

146. However, it can be built much bigger than your old units. You can use several oil drums instead of only one. So, you can make more gas than you did before.

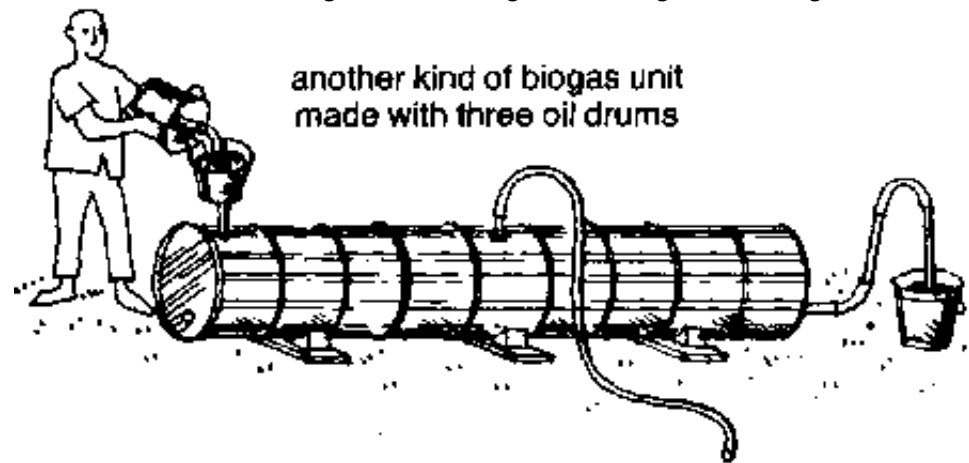

Another kind of biogas unit

147. This kind of unit is also filled with waste when you first begin.

148. Then, after the unit begins to make gas, you continue to put in waste from time to time. You may do this every few days or you may do it every week.

149. However, when you put new waste into this kind of unit, an equal amount of waste is pushed out of the unit.

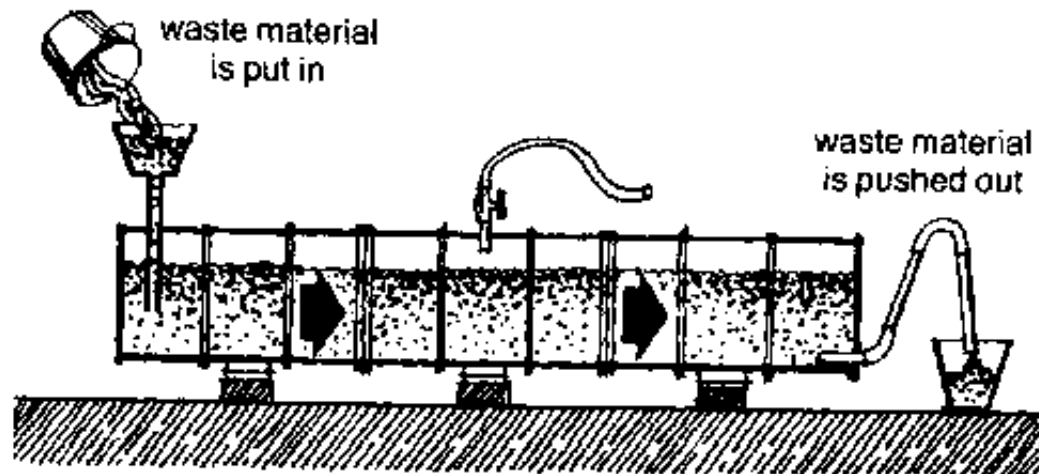

Put in waste material

150. With fresh waste material always moving through the unit, it will make biogas for a much longer time.

151. You will learn more about this bigger and better unit in a later booklet in this series.



[Home](#) > [ar](#).[cn](#).[de](#).[en](#).[es](#).[fr](#).[id](#).[it](#).[ph](#).[po](#).[ru](#).[sw](#)

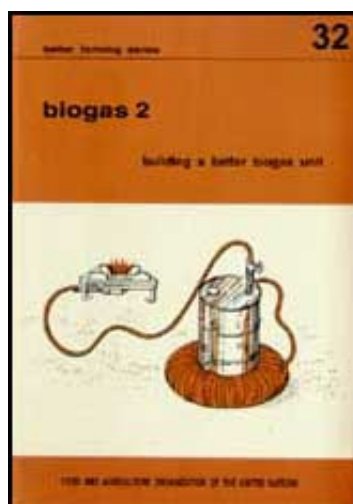

Better Farming Series 32 - Biogas 2: Building a Better Biogas Unit (FAO, 1986, 47 p.)

 ***(introduction...)***

  **Preface**

 **Introduction**

 **How to build a better small biogas unit**

 **Putting in the waste**

 **Time**

 **Temperature**

 **Scum**

 **When the gas is made**

 **Taking care of your biogas unit**

 **Making more biogas**

□ What more can you do?

Preface

The first twenty- six volumes in FAO's Better Farming Series were based on the Cours d'apprentissage agricole prepared in Cte d'Ivoire by the Institut africain de dveloppement conomique et social for use by extension workers. Later volumes, beginning with No. 27, have been prepared by FAO for use in agricultural development at the farm and family level. The approach has deliberately been a general one, the intention being to constitute basic prototype outlines to be modified or expanded in each area according to local conditions of agriculture.

Many of the booklets deal with specific crops and techniques, while others are intended to give the farmer more general information which can help him to understand why he does what he does, so that he will be able to do it better. This booklet was added to the series owing to the favourable comments received on Booklet No. 31, Biogas: what it is; how it is made; how to use it. Both booklets have been based on published works by researchers and experimenters in small scale biogas production in Africa, Asia, Europe and North America.

Adaptations of the series, or of individual volumes in it, have been published in Arabic, Bengali, Creole, Hindi, Igala, Indonesian, Kiswahili, Malagasy, SiSwati, Thai and Turkish.

Requests for permission to issue this manual in other languages and to adapt it according to local climatic and ecological conditions are welcomed. They should be addressed to the Director, Publications Division, Food and Agriculture

Organization of the United Nations, Via delle Terme di Caracalla, 00100 Rome, Italy.



[Home](#) > [ar](#).[cn](#).[de](#).[en](#).[es](#).[fr](#).[id](#).[it](#).[ph](#).[po](#).[ru](#).[sw](#)

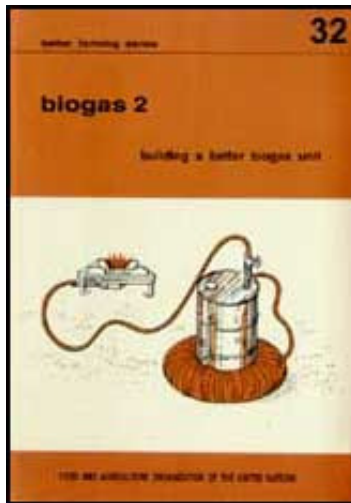

Better Farming Series 32 - Biogas 2: Building a Better Biogas Unit (FAO, 1986, 47 p.)

 *(introduction...)*

 **Preface**

  **Introduction**

How to build a better small biogas unit

Putting in the waste

 **Time**

Temperature

 **Scum**

 **When the gas is made**

 **Taking care of your biogas unit**

 **Making more biogas**

What more can you do?

Introduction

1. You have already built one or more biogas units like the one described in the

Better Farming Series Booklet No. 31; Biogas: what it how it is made; how to use it.

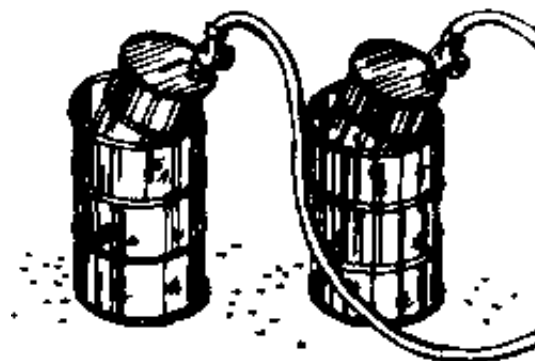

Biogas unit

- 2. When you first began you found that you had to learn a lot of new things in order to make your unit work.**
- 3. However, little by little you have learned more and more through your own experience.**
- 4. When your first gas was made you used it for cooking. You found that cooking with gas was cleaner, easier and faster than cooking with kerosene, charcoal or fuelwood.**

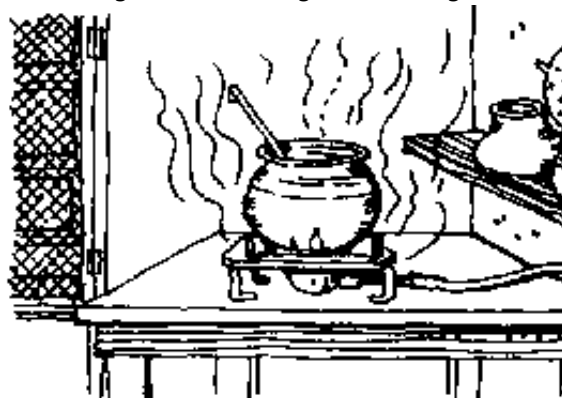

Cooking

5. Now that you know more about biogas and how it is made, let us look at another way to make biogas even better.

6. In this booklet you will learn how to build and use a better small biogas unit like the one shown below.

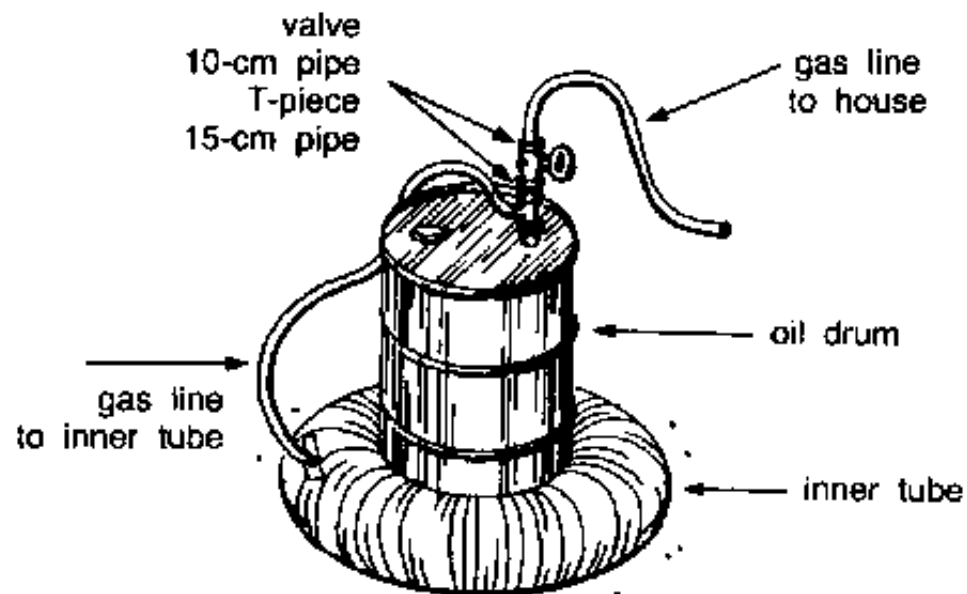

biogas unit

7. It too has an oil drum for a waste holder and, like your first small unit, all the waste is put in at one time when you begin.

8. However, the new unit is closed. A closed unit is cleaner. You cannot smell the waste after you have put it in as you could with your old unit.

9. In addition, with your old unit some of the gas was lost from around the open sides of the oil- drum waste holder.

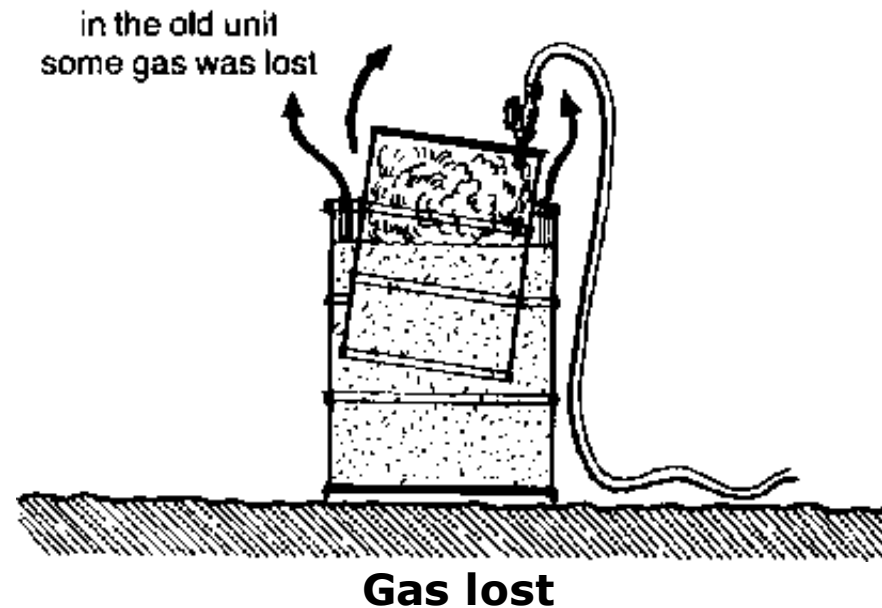

10. Since the new unit is closed you will not lose any gas. You can collect it all so you will have more gas to use.

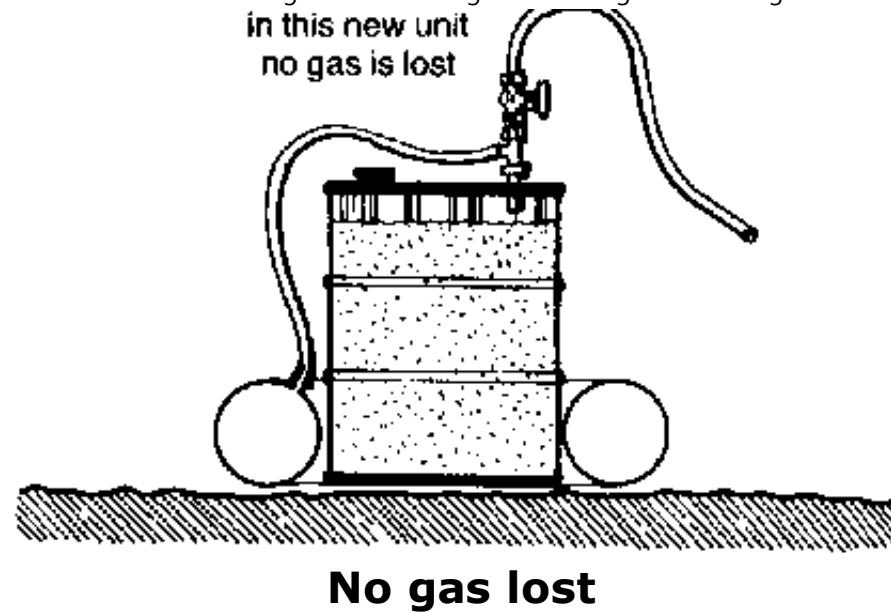

11. Notice in the closed unit (see the drawing above) that the oil drum is filled nearly to the top with waste. There is little space to hold gas.

12. So, you will need something to collect the gas. In the new unit, the gas holder is a used inner tube as you can see in the drawing on page 2 in this booklet.

13. This new biogas unit looks much like your old unit and it works in much the same way. You already know a lot of the things that you need to know to put this new unit together.

14. However, before you begin it would be a good idea to read Booklet No. 31 again.

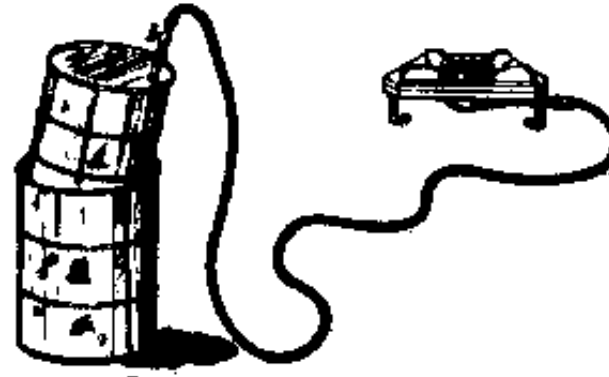

Biogas unit





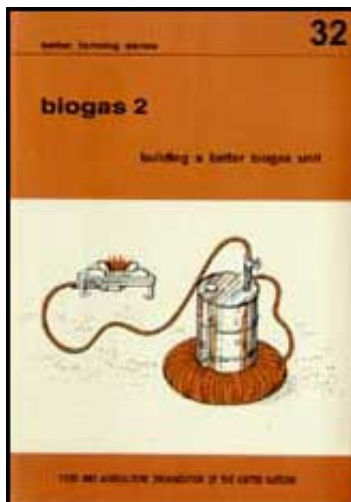



[Home](#) > [ar.cn.de.en.es.fr.id.it.ph.po.ru.sw](#)



Better Farming Series 32 - Biogas 2: Building a Better Biogas Unit (FAO, 1986, 47 p.)

How to build a better small biogas unit

-  **You will need**
-  **Cleaning the oil drum**
-  **Where to put your biogas unit**
-  **Preparing the oil drum**
-  **Testing for leaks**
-  **Preparing the gas holder**
-  **Attaching the gas holder**

Better Farming Series 32 - Biogas 2: Building a Better Biogas Unit (FAO, 1986, 47

p.)

How to build a better small biogas unit

You will need

- an oil drum of about 200 litres, to hold the waste



Oil drum

- a piece of pipe about 15 centimetres long and about 2 centimetres in diameter to fit the oil drum, for the gas outlet

gas outlet



Gas outlet

- a pipe T- piece, to connect the gas outlet to the inner tube

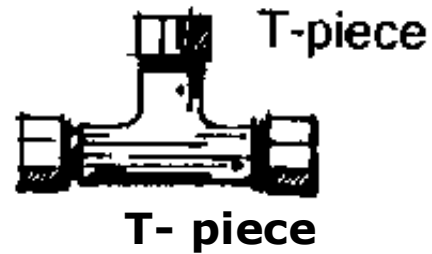

- a piece of pipe about 10 centimetres long to fit the T- Piece

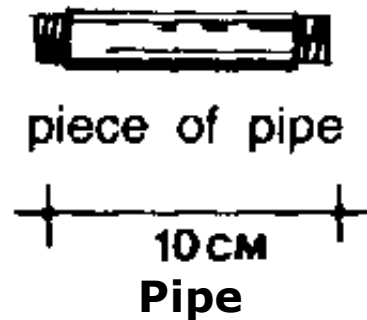

- a valve to fit the 1 10- centimetre pipe

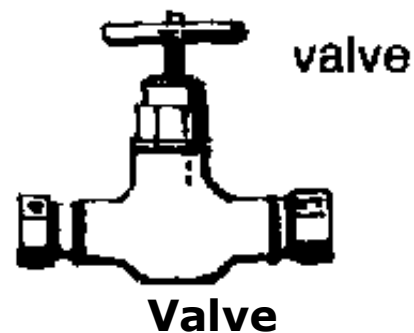

Note

The drawing on page 14 in this booklet shows you how these pipe fittings are attached to the oil drum.

- **at least 12 metres of rubber or plastic tube, about 2 centimetres in diameter, for the gas lines**

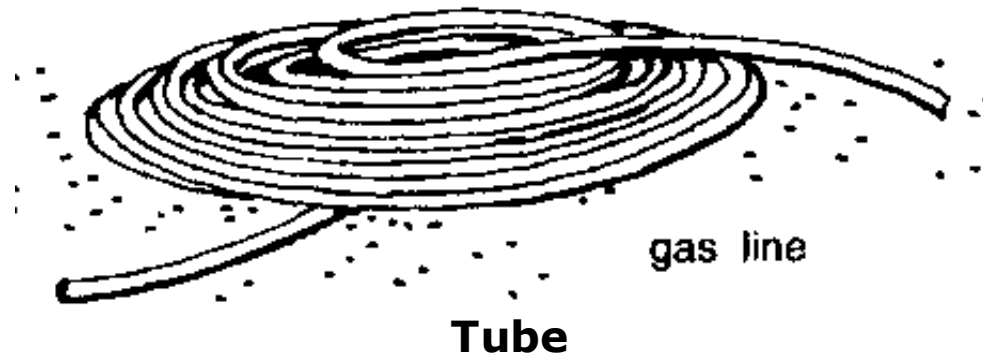

- **one or more inner tubes, to collect the gas**

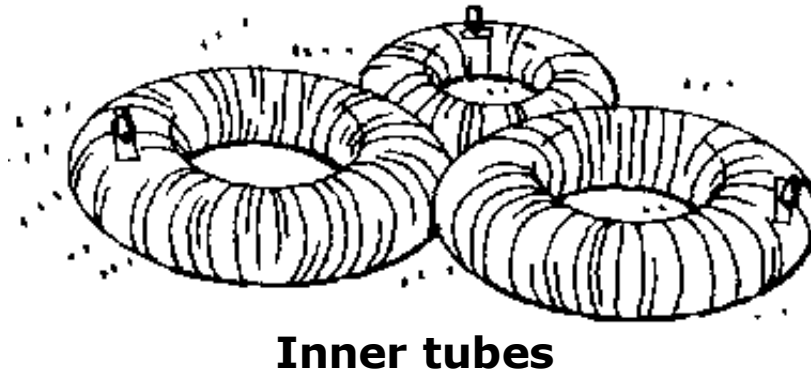

- **if you are using more than one inner tube, you will also need one or more small T- pieces to connect the inner tubes.**



15. The oil drum should have one hole for putting in the waste and another hole for the gas outlet. Many drums have threaded holes with threaded plugs to close them.

16. Try to find an oil drum with threaded holes in the top. That way it will be easier to build this unit and to make it airtight.

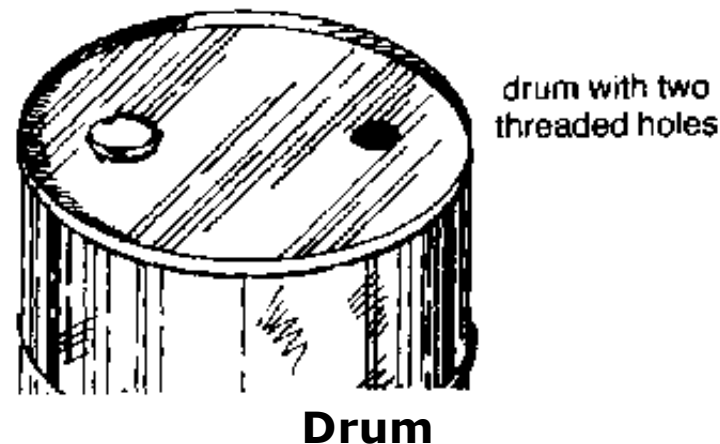

Cleaning the oil drum

17. Begin by cleaning the drum inside and outside to remove all oil and grease.

18. Take the metal plugs out of the holes and put them carefully aside, so that you

can find them later.

19. First clean the inside of the drum. Pour in a bucket or two of warm, soapy water or other cleaner. Then close all of the holes.



20. Put the drum on its side. Roll it back and forth so that the soapy water or cleaner can wash the whole inside. Then open the holes and empty out the water.



21. Continue to wash the inside of the oil drum with soapy water or cleaner until it is completely clean.

22. You can tell the oil drum is clean when the water you empty out is clean.

23. When you are sure that the inside is clean, pour in three buckets of fresh water and roll the drum back and forth once more. This is to rinse out any soap or cleaner that is still inside. Then empty it out again.

24. Now clean the outside of the drum with a brush and soapy water or cleaner. Rinse it with fresh water.

25. Open the holes in the top and put the drum on stones with the top down. Let it drain and dry.

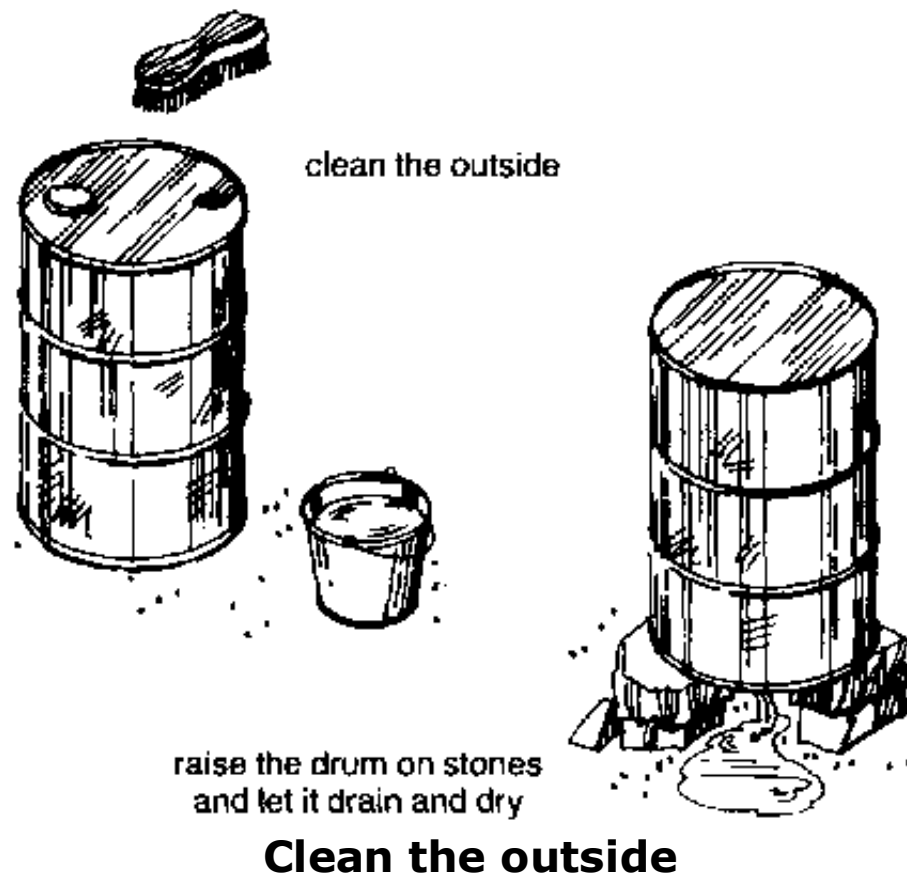

26. When the drum is dry inside and out you are ready to begin.

Where to put your biogas unit

27. Before you build your new biogas unit you should decide where to put it. Items 26 to 34 in Booklet No. 31 will tell you where.

28. However, do not put this unit underground. If the unit is underground you will not be able to shake it to break up the scum (see Items 109 to 113 in this booklet).

Preparing the oil drum

29. If your oil drum has a hole in its side, close it tightly. You can use a threaded metal plug or weld a piece of metal over the hole.

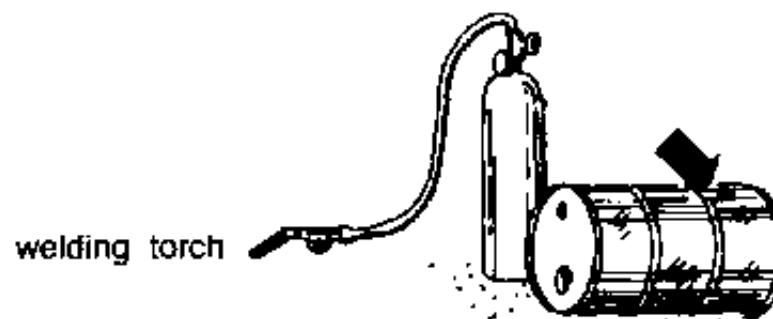
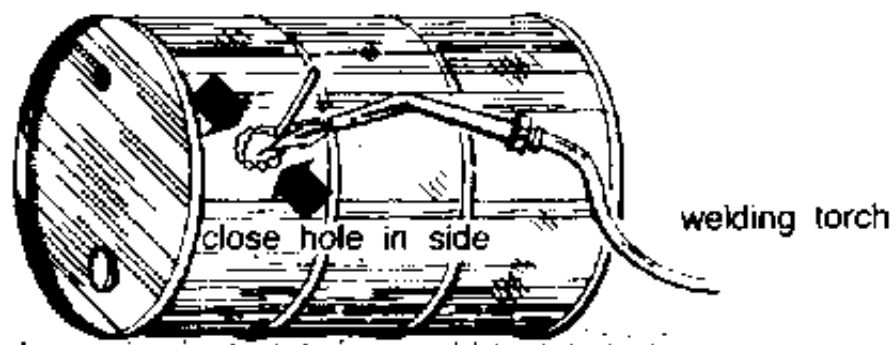

Close hole in side

30. Now you are ready to put the gas outlet in the top of the drum.

31. If your drum has two holes in the top, use the smallest one for the gas outlet. Save the largest one for putting in the waste.

32. The gas outlet is made from a piece of pipe about 15 centimetres long and about 2 centimetres in diameter. However, it should fit the hole in the drum.

33. If the hole is threaded, use an outlet pipe that is threaded on both ends. Screw it tightly into the hole.

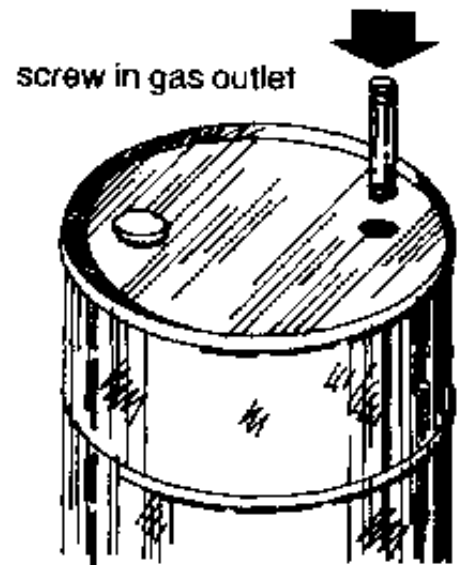

Screw in gas outlet

34. If the hole is not threaded, use an outlet pipe that is threaded on one end. Weld it into the hole with the threaded end up.

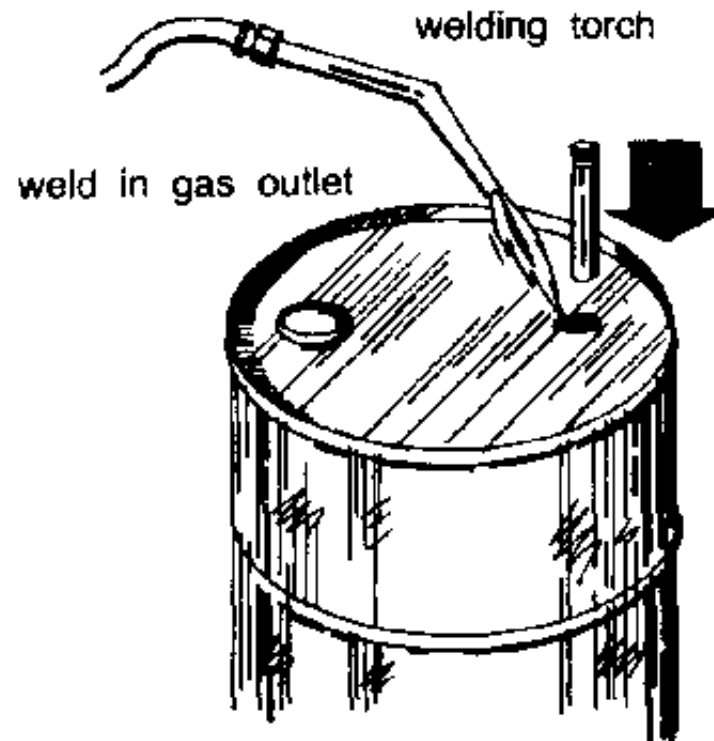

Welding torch

35. If there is only one threaded hole in the top of the oil drum, use it to put in the waste.

36. Then you will have to cut a hole about 2 centimetres in diameter for the gas outlet. Weld in a pipe that is threaded on one end, as shown in the drawing at the top of this page.

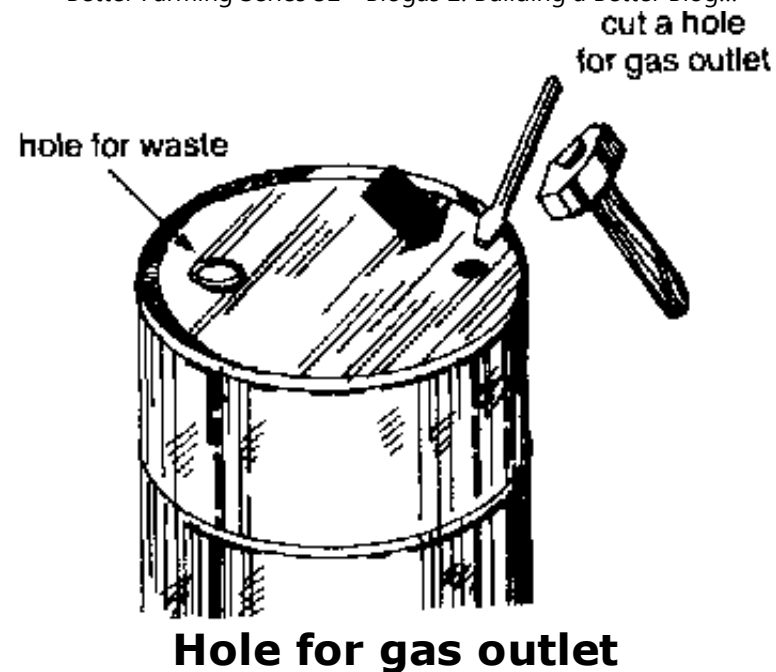

37. Now you are ready to attach the pipe T- piece, the 10- centimetre piece of pipe and the valve.

38. The valve you use must be airtight so that it will not leak gas. You must be sure to screw all of these pieces tightly to the gas outlet.

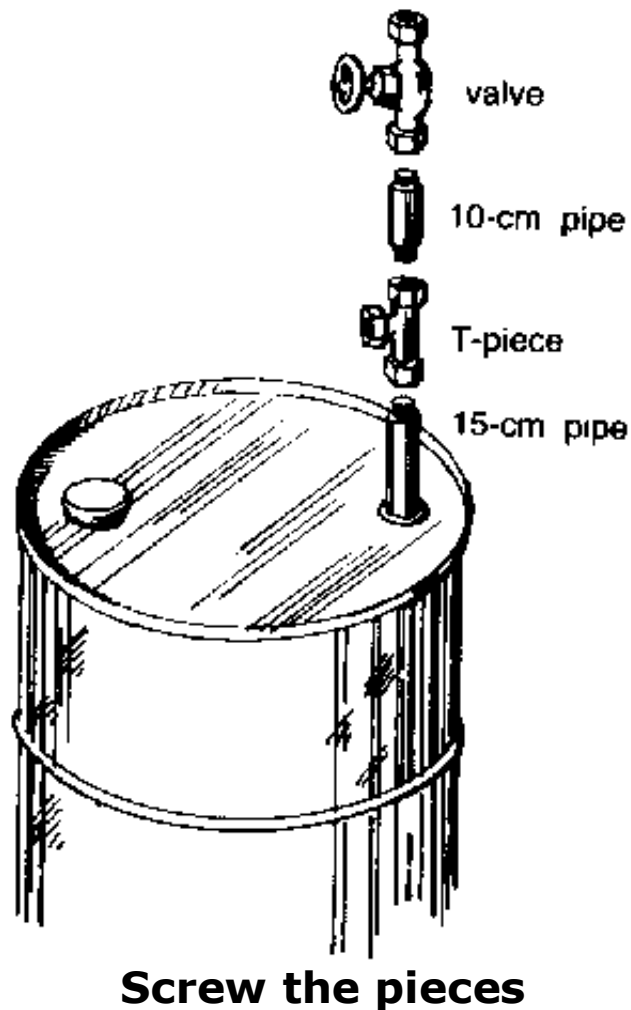

Note

If you do not have a valve, you can tie or clamp the gas line to stop the flow of gas (see Item 48 in Booklet No. 31).

Testing for leaks

39. Now you are ready to test the drum for leaks. To make biogas, the drum must

be airtight.

40. To test for leaks, open the valve, take out the metal plug in the waste hole and fill the drum with water.

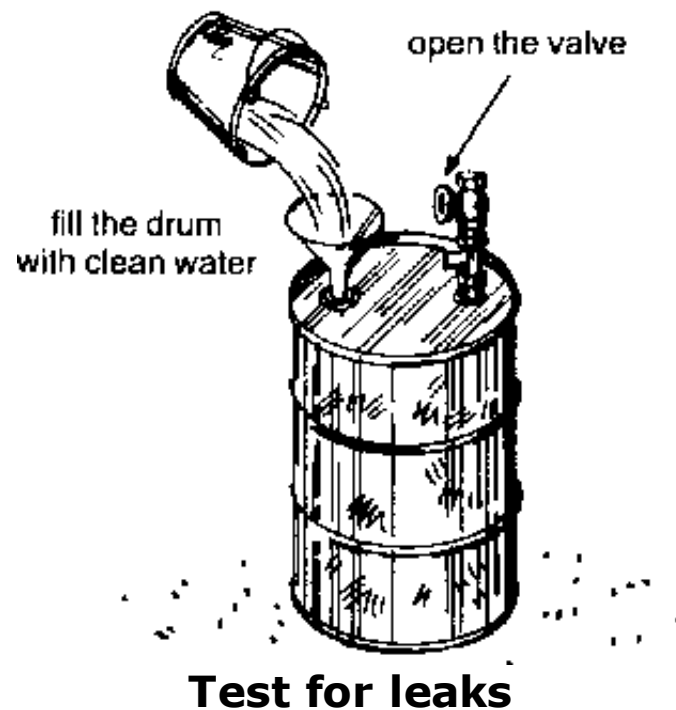

41. Be sure to fill it to the top. Then close the valve and put the metal plug back in the waste hole.

42. Use a piece of cloth to dry any water that you have spilled on the outside of the drum.

43. If you see water leaking from anywhere on the drum, mark the place of each leak.

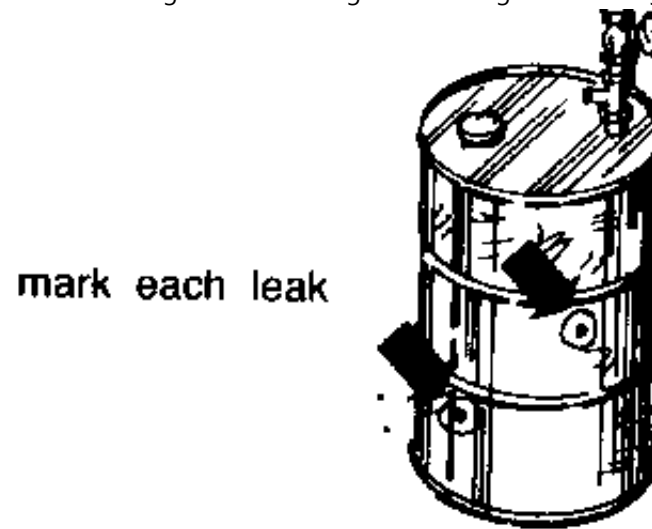

Mark leaks

44. Then turn the drum over on its side. When the drum is full of water it is very heavy, so ask someone to help you.

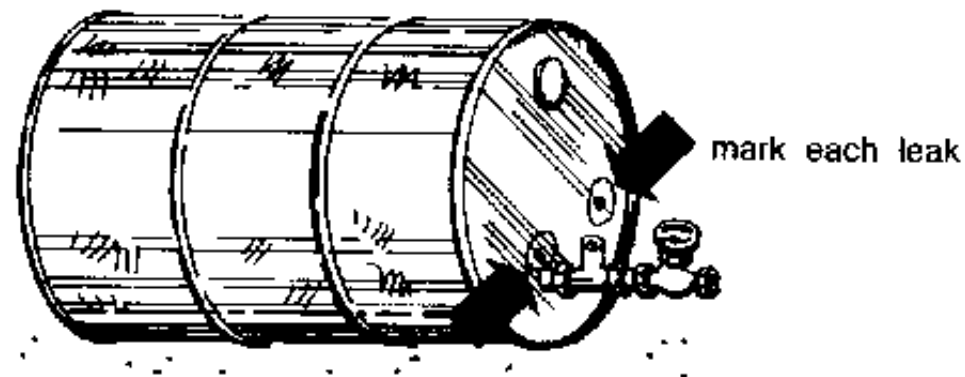

Mark leaks

45. Now check for leaks on the top part of the drum and around the gas outlet, T-piece and valve. If there are leaks here, mark them too.

46. Then open the valve, take out the metal plug and empty out the water. Raise the drum on stones with the top down so it can drain dry.

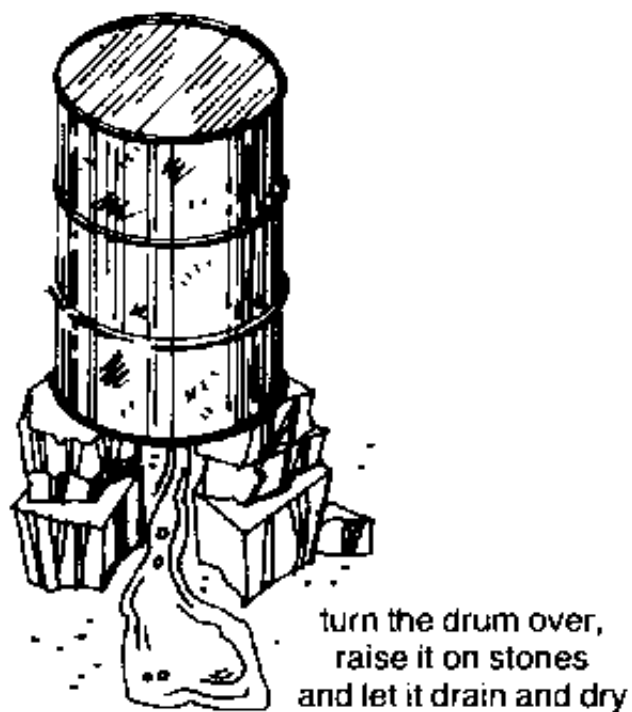
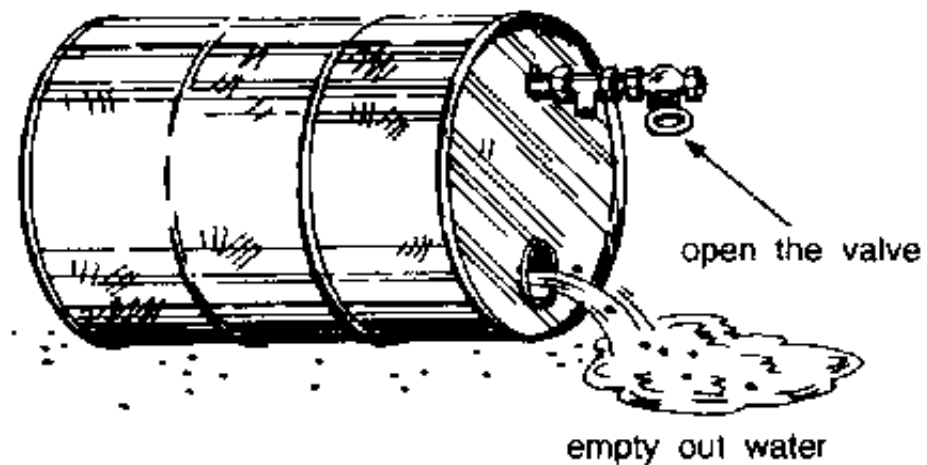

Empty out water

Note

When you put the drum on stones, be very careful not to damage the gas outlet, the pipe T- piece or the valve.

47. Seal the leaks by coating them with tar, mastic or paint. If there are any leaks around the gas outlet, tighten the outlet, T- piece and valve again. Coat the joints with tar, mastic or paint.

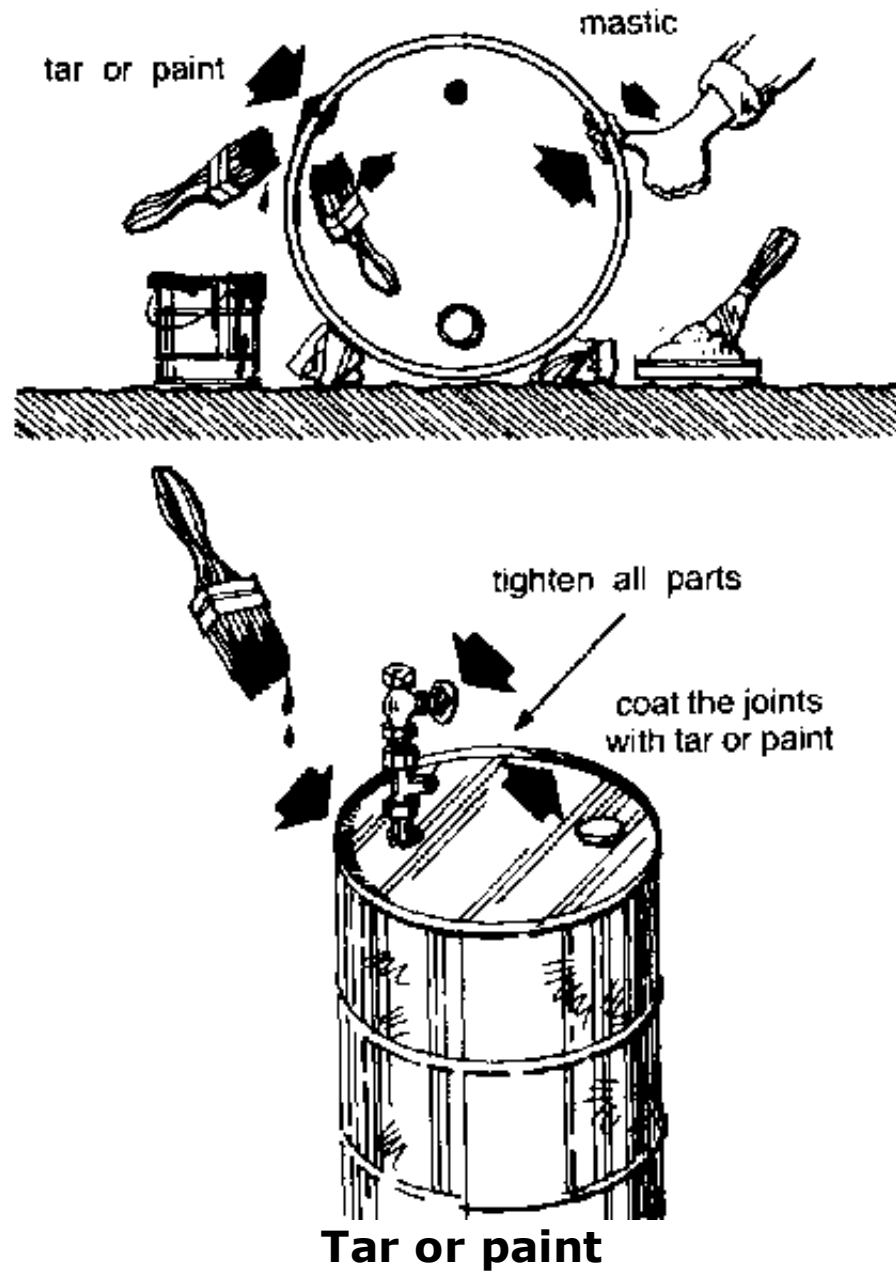

48. When the sealing is dry, fill the drum with water again. Check that all the leaks are sealed. If the drum still leaks, empty out the water and let it dry.

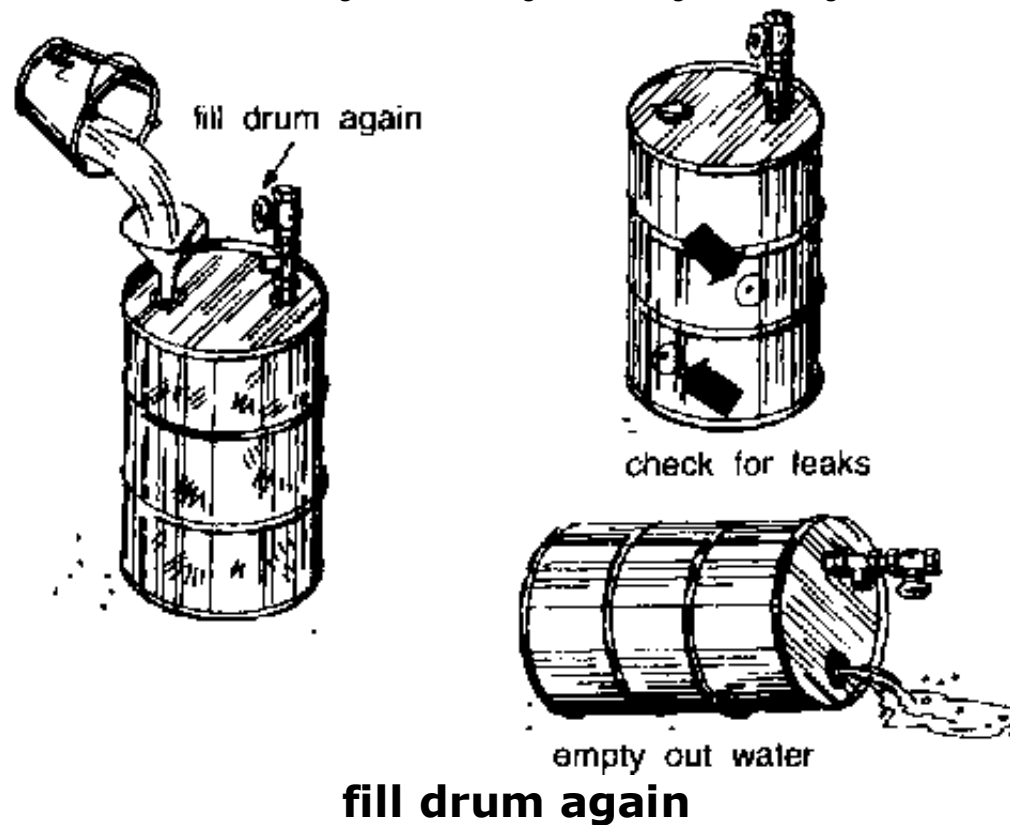

49. Put some tar or paint inside the drum. Then turn the drum around and around to coat the inside of it.

50. Fill the drum with water again. If it still leaks, start all over again. It is very important to seal all leaks carefully.

51. When the drum is well sealed and no longer leaks, let it dry completely. Now you can begin to prepare the gas holder.

Preparing the gas holder

52. As you have been told this unit has an inner tube which holds the gas.

53. If you can get a large truck or tractor inner tube, you will need only one.

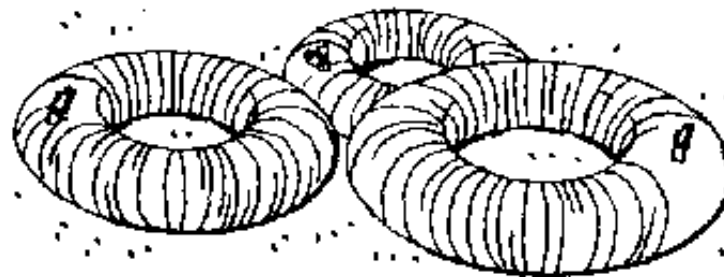

Tube

54. You can also use tubes from automobiles. However, these are smaller so you will need two or even three.

55. Try to get a large tube because it is easier to attach one large tube than two or three small ones.

56. First check each tube that you are going to use for leaks. Each tube must be airtight. To check a tube for leaks fill it with air.

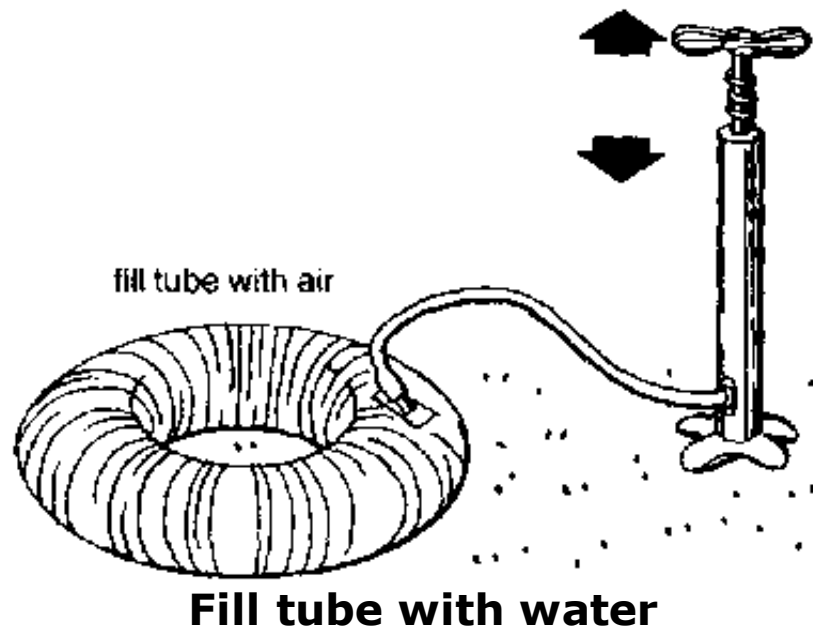

57. Then put the tube in water. You can put it in a pond or in a quiet stream.

58. Turn the tube slowly under the water. Look for air bubbles. If you see any bubbles, mark each place on the tube.

look for air bubbles

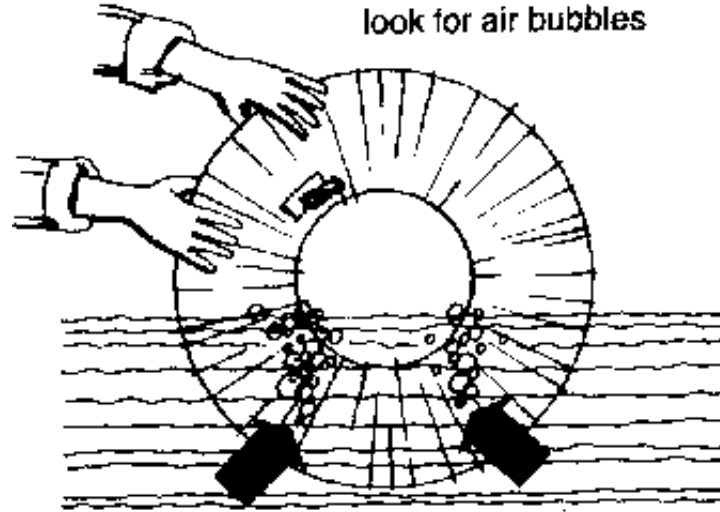

Look for air bubbles

59. Let the tube dry. When it is completely dry, repair all of the leaks.

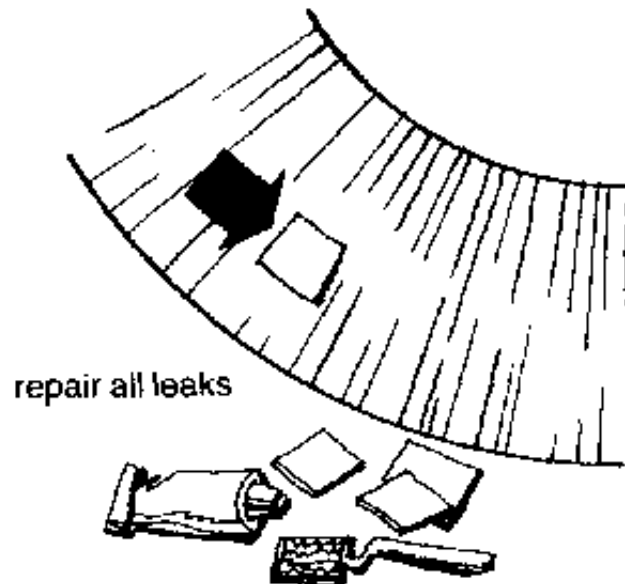

Repair all leaks

60. Fill the tube with air and put it in the water again to make sure that you have repaired all of the leaks well.

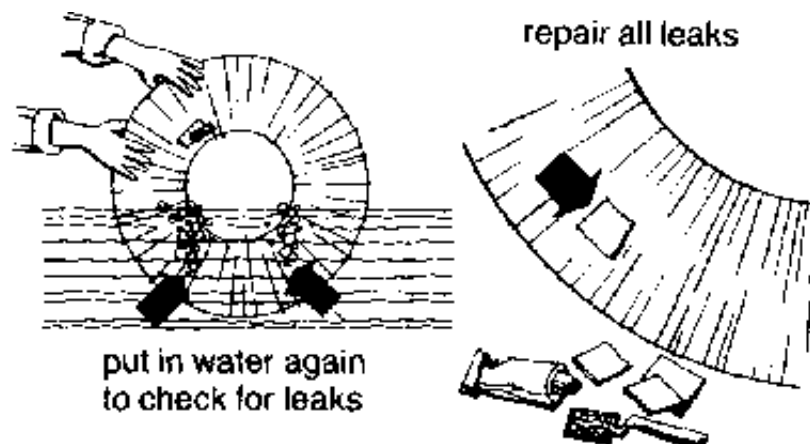

Check again for leaks

61. If there are still leaks, start all over again. It is very important to seal all leaks carefully.

62. When all the leaks are sealed let all of the air out. To do this, unscrew the cap of the air inlet and remove the valve.

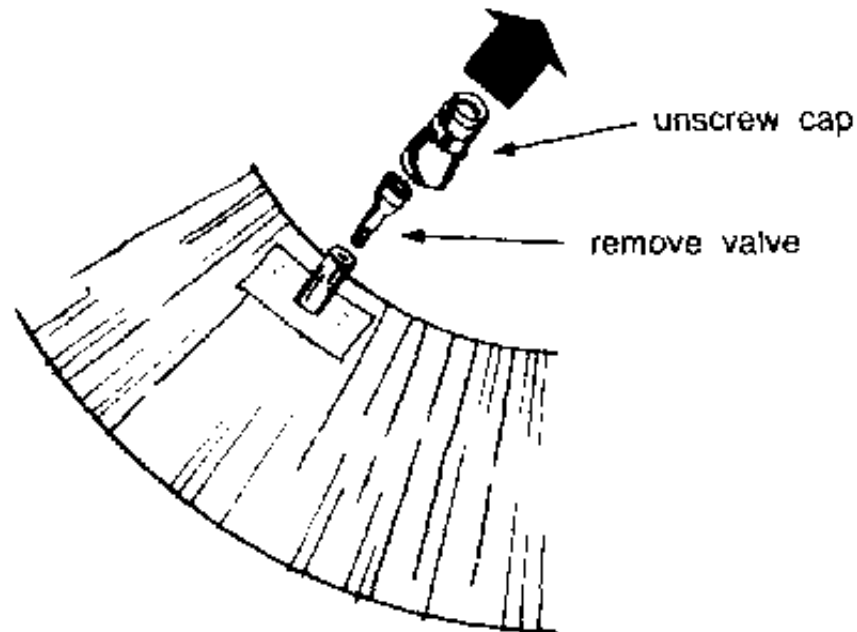

Let the air out

63. Roll the tube very tightly. If you have a smooth, round pole, you can roll the tube around this.

64. When the tube is tightly rolled and there is no air in it, screw the cap on the air inlet. This is to keep more air from getting inside.

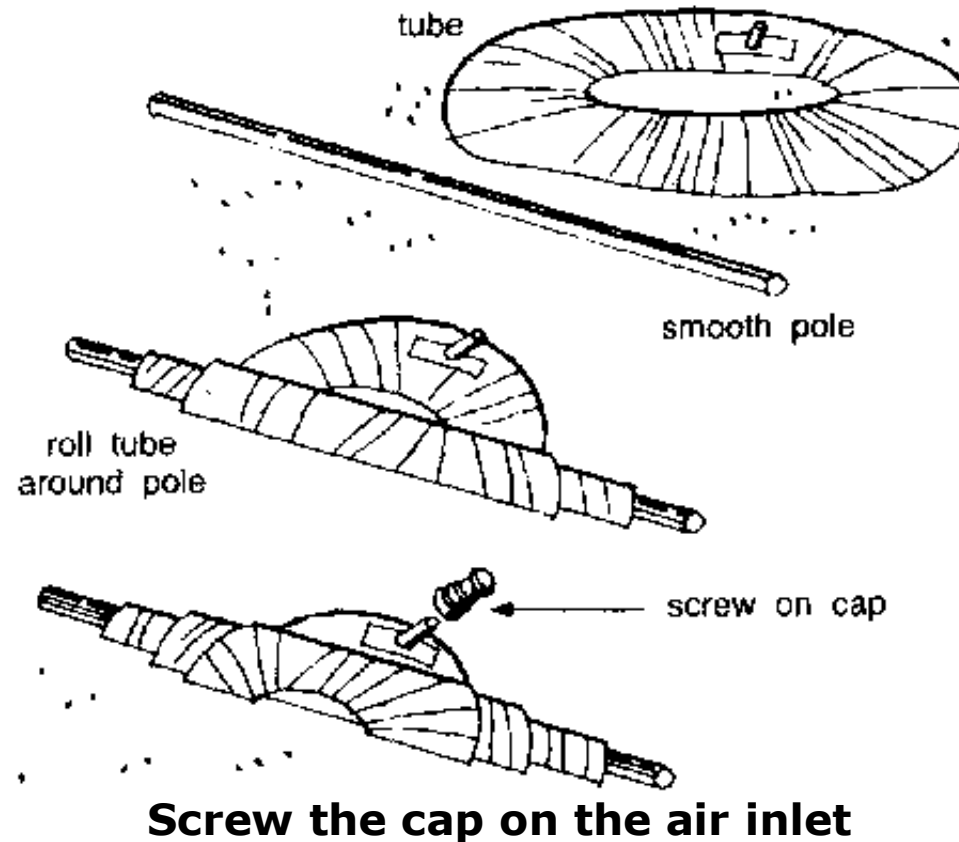

Note

When you screw the cap on the air inlet, do not put the valve back, and keep the inner tube rolled up until you attach the short gas line (see Item 70 in this booklet).

65. Now you are ready to attach the gas holder.

Attaching the gas holder

66. Cut a short piece from one end of the 12- metre gas line. This is to attach the

inner tube to the pipe T- piece on the oil drum.

67. This piece should be long enough to connect the T- piece and the inner tube without being tight. If it is too tight, it may pull off.

68. Fold the short gas line at a place near the centre. Tie the fold tightly with cord. The drawing below will show you how.

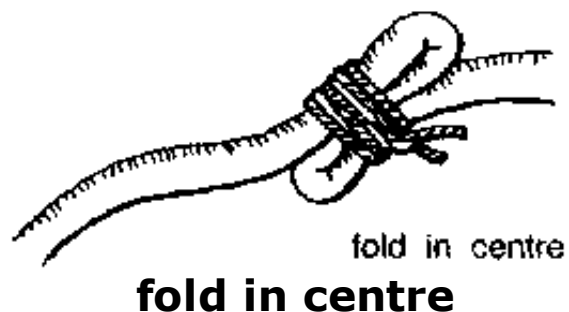

69. The fold will keep more air from getting into the inner tube when you attach it to the short piece of gas line.

70. Take the air inlet cap off the still- rolled inner tube and attach the short gas line. Be sure to attach it tightly. You may have to tie it with cord and seal it with tar or mastic. Now you can unroll the inner tube (see the drawings on the next page).

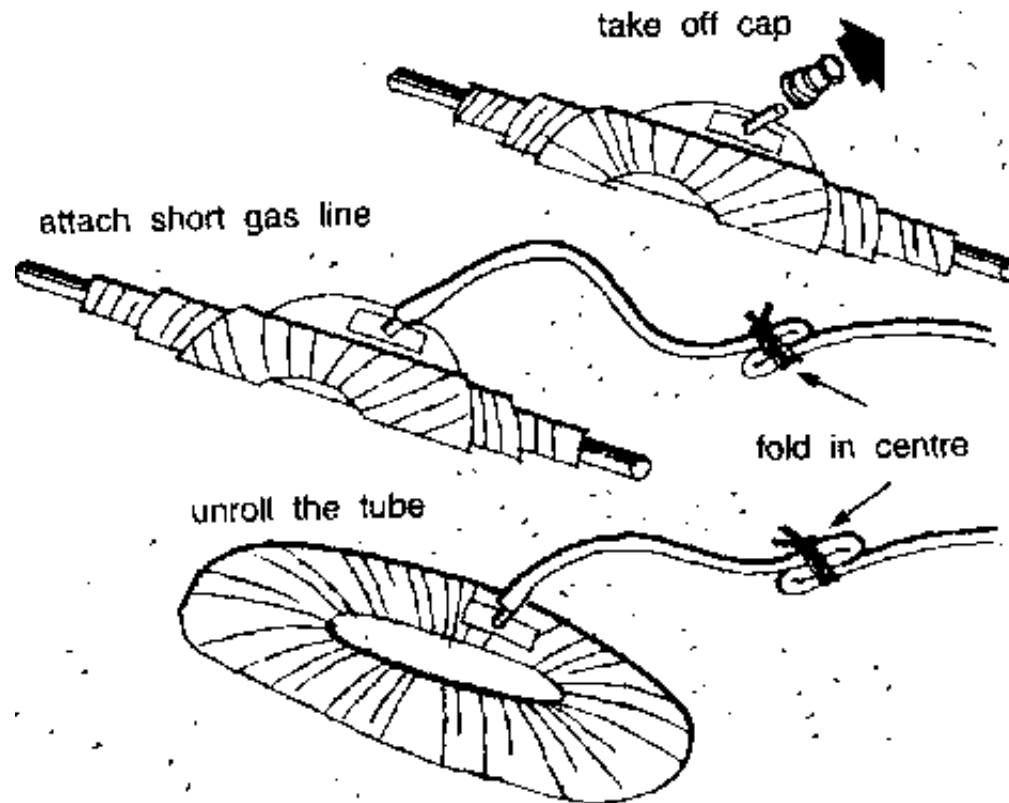

Unroll the inner tube

71. It is very important to keep the gas holder from moving or the short gas line may pull off.

72. If you are using a large inner tube, fit it over the oil drum and place it on the ground. The drum will keep the tube from moving.

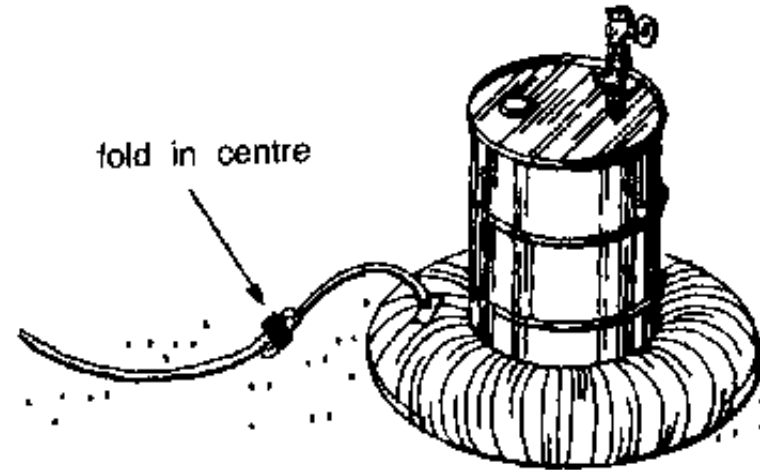

Fold in centre

73. If you are using an inner tube that is too small to fit over the oil drum, you will have to keep it in place using wooden stakes.

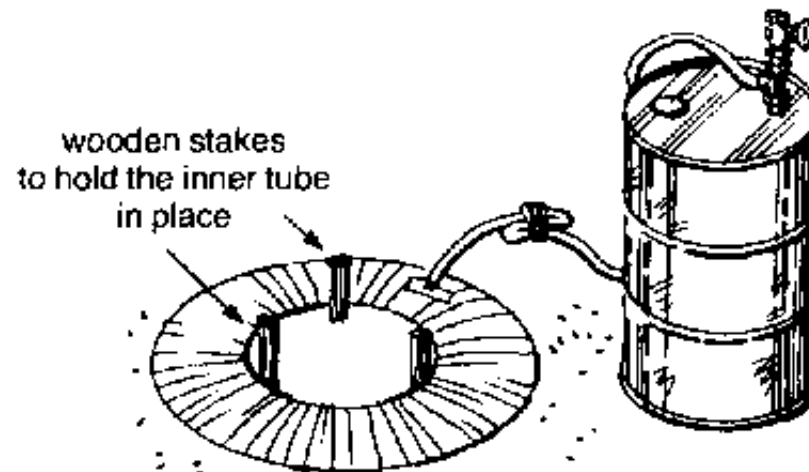

Use wooden stakes

74. Connect the top of the short gas line to the pipe T- piece on the oil drum.

connect short gas line
to T-piece

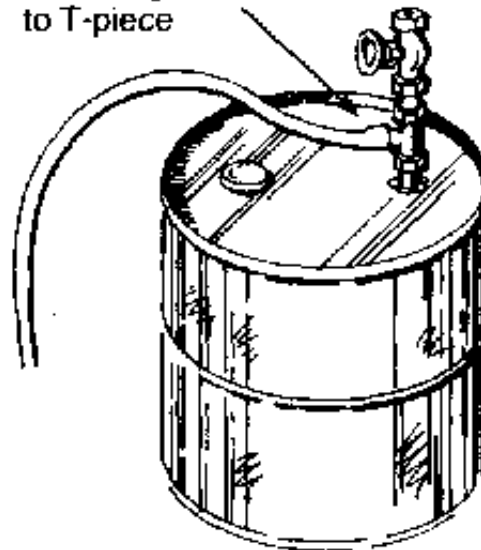

Connect short gas line

75. However, do not untie the fold in the centre of the short gas line (see Item 101 in this booklet) or attach the long gas line to the valve (see Items 89 to 122 in this booklet) until you are told to do so.

76. The drawings below show you how to connect both large and small inner tubes to this kind of biogas unit.

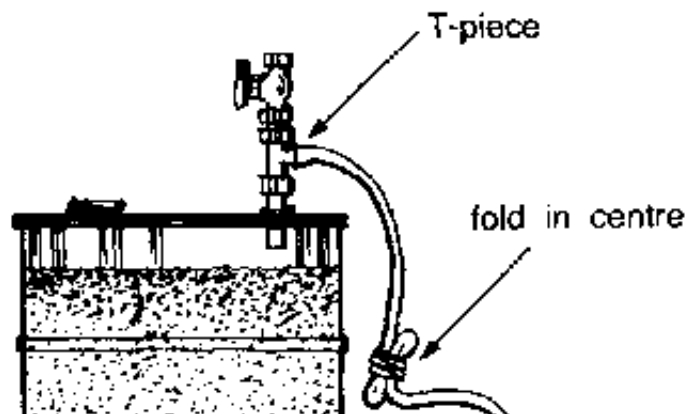

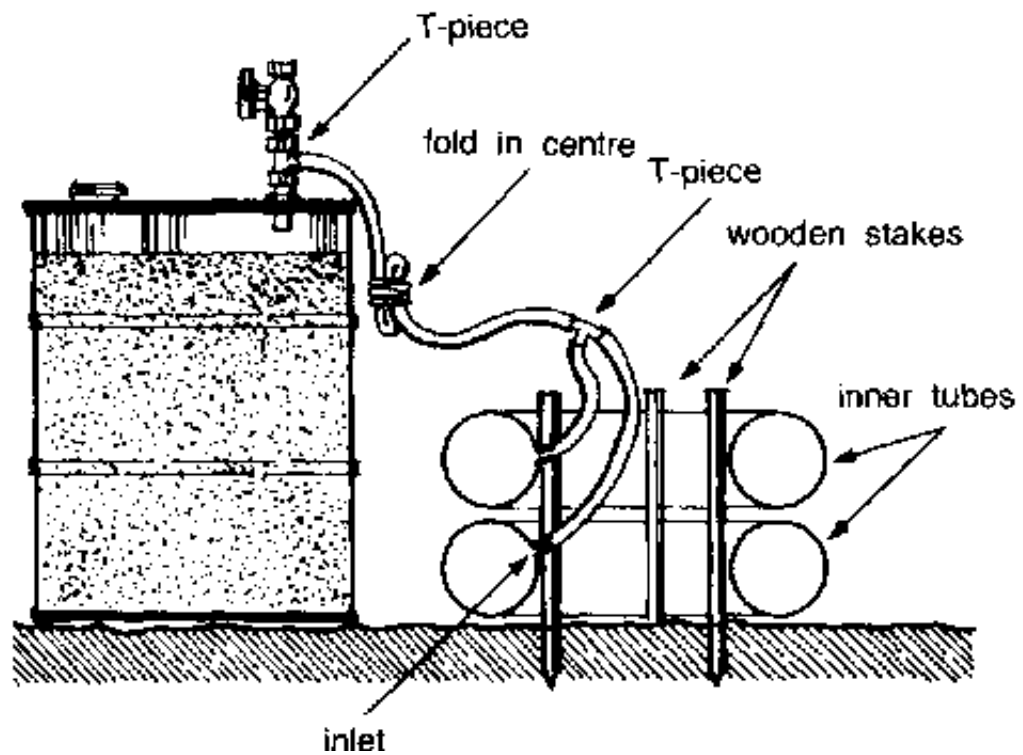
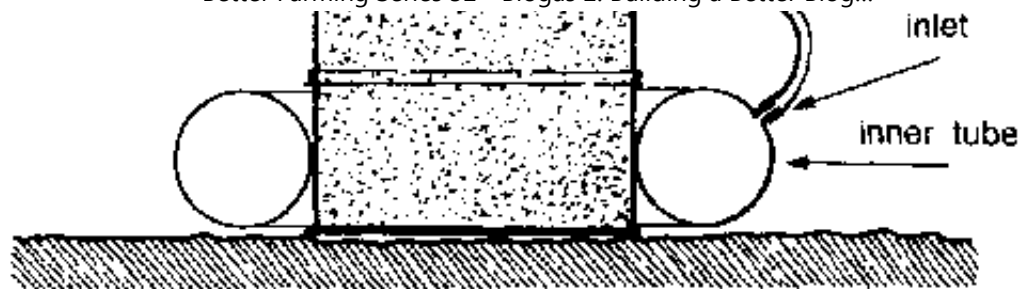

Biogas unit





77. Now you are ready to put waste into the oil drum.

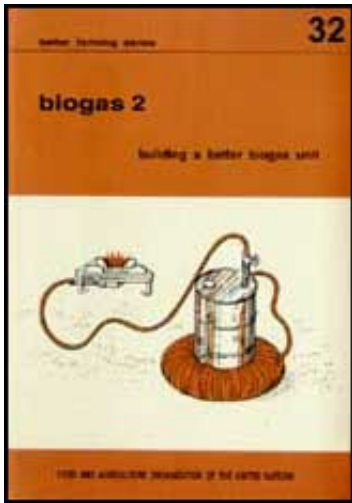

[Home](#) > [ar.cn.de.en.es.fr.id.it.ph.po.ru.sw](#)



Better Farming Series 32 - Biogas 2: Building a Better Biogas Unit (FAO, 1986, 47 p.)

- ➔  **Putting in the waste**
 -  **The waste materials**
 -  **The starter**
 -  **Putting waste in this biogas unit**
 -  **After the waste is in**

Better Farming Series 32 - Biogas 2: Building a Better Biogas Unit (FAO, 1986, 47 p.)

Putting in the waste

The waste materials

78. You have already been told that this biogas unit is very much like the one that you learned how to build in Booklet No. 31.

79. Since your new biogas unit is much the same as your old one, you can use the same kind of wastes in the same way. Items 58 to 66 in Booklet No. 31 tell you how to prepare them.



cow, pig, chicken manure

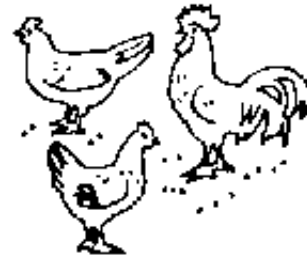

plant wastes



crop wastes

Use wastes

80. With the new unit, as with your old unit, you put in all of the waste at one time when you begin. Then, when all of the gas is made, you take out all of the waste, use it for fertilizer, and begin all over again.

81. However, be especially careful to mix the waste and water well. Once this kind of unit is closed you should not open it until all of the gas is made.

82. You cannot stir it or add more water if the waste becomes too thick as you could with your old unit (see Items 94 to 96 in Booklet No. 31).

83. So, the waste and water mixture for the new biogas unit should be thin enough to pour easily.

84. It should be about as thin as the paint or the whitewash that you use to paint your house.

The starter

85. If your old unit is working, take 4 litres of waste from it to use as a starter when you begin.

86. However, if you do not have any waste to use as a starter you will have to make some. Items 67 to 70 in Booklet No. 31 will tell you how to do it.

Putting waste in this biogas unit

87. When you are ready to add the waste, unscrew the plug in the waste hole and put it carefully aside. Put a large funnel in the hole.

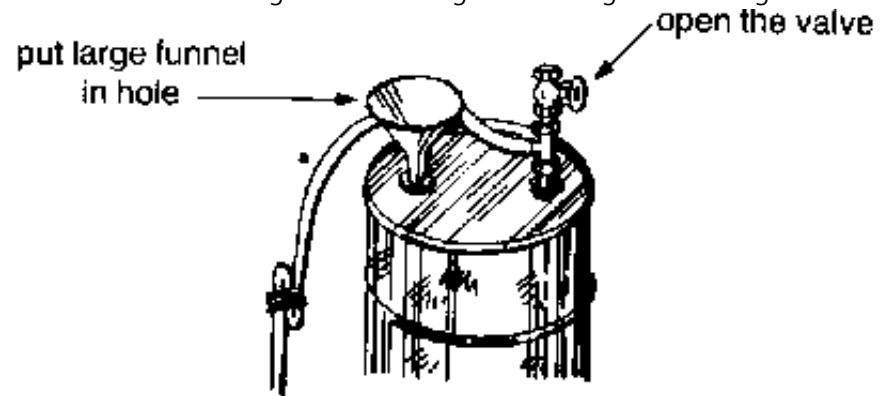

Put a large funnel in the hole

88. Open the valve so that when you add the waste the air that is inside the drum will be forced out through the gas outlet.

89. You have not yet been told to attach the gas line and you should not have done so (see Item 75 in this booklet).

90. Put three buckets of waste and three buckets of water in a large container and mix it well (see Item 84 in this booklet).

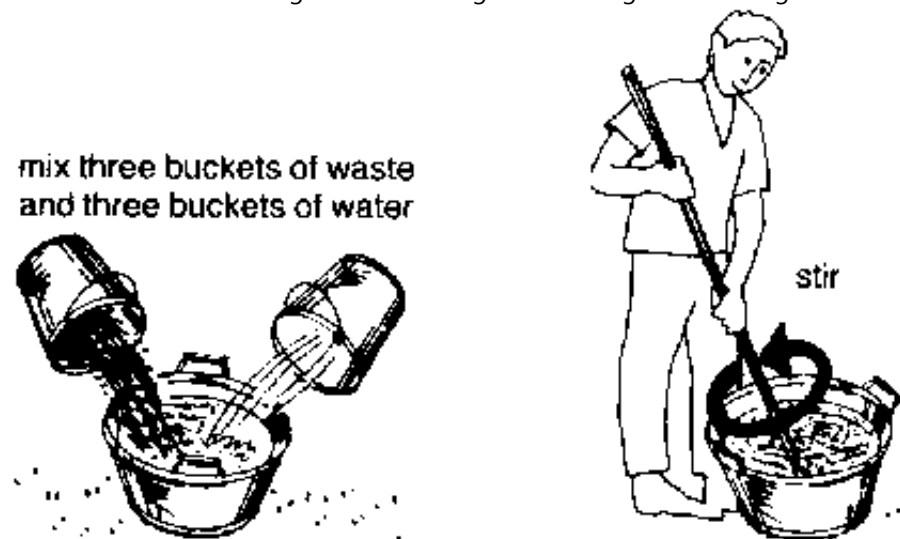

Mix waste and water

91. When the waste and water are well mixed, dip out a bucketful and pour it through the funnel into the oil drum.

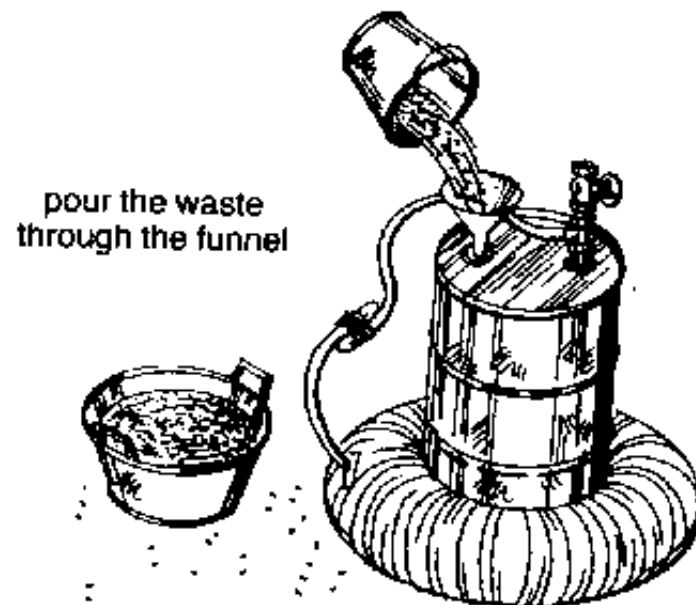

Pour waste through the funnel

92. If it does not flow through the funnel, add a little more water to the waste mixture in the large container.

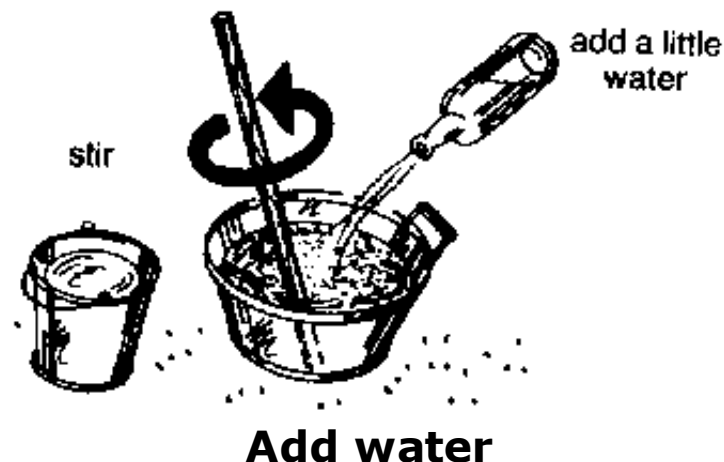

93. Then try to pour another bucketful through the funnel. If the mixture is thin enough to go through the funnel, pour the rest into the drum.

94. Again put three buckets of waste and three buckets of water in the large container and mix it as before.

95. Pour this mixture into the drum. Then take out the funnel. Put a pole long enough to reach the bottom of the drum into the waste hole and stir all the mixture well.

96. Continue in this way until the waste in the drum is about 10 centimetres from the top. Now put in about 4 litres of starter and stir it well.

pour in starter

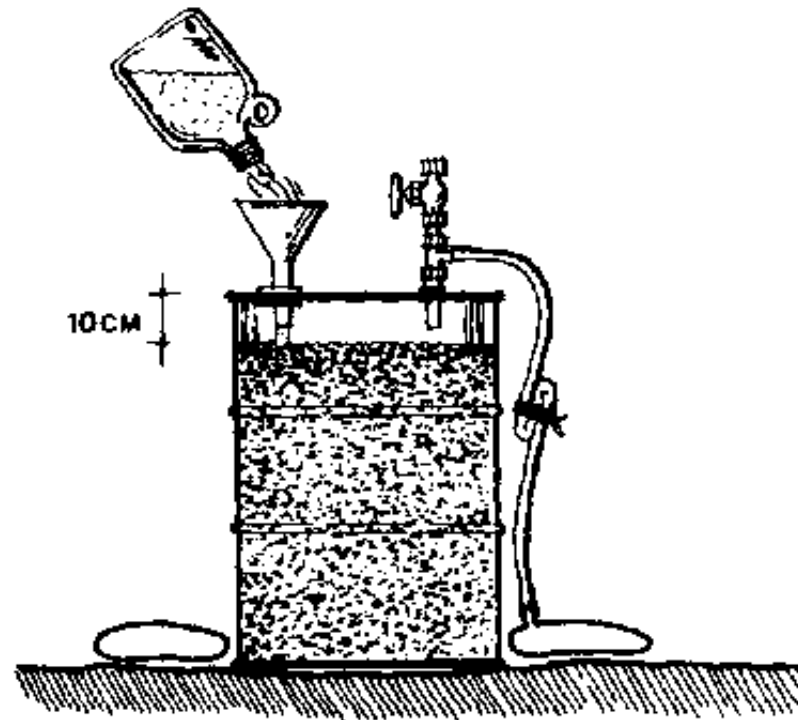

Pour in starter

97. The starter, which has already begun to work, will help you to make gas sooner.

After the waste is in

98. Close the waste hole tightly and turn off the valve. After about two weeks, open the valve and let out all the gas that has collected in the top of the drum.

99. While you are letting the gas out, be very careful not to have fire near the biogas unit.

100. Listen as the gas escapes. When you hear the sound of the gas stop, turn off the valve quickly. This is to keep air from getting into the drum.

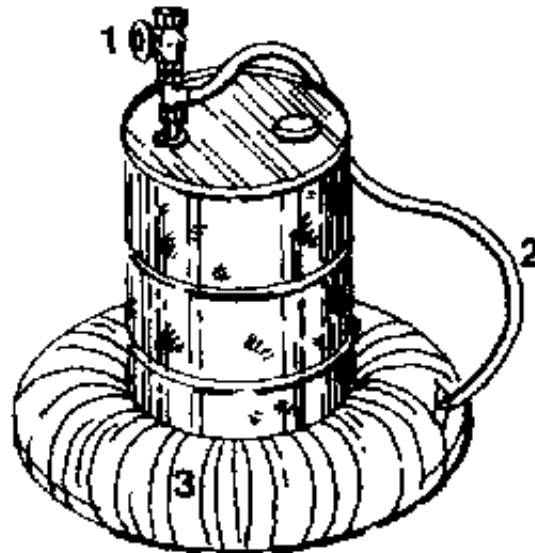

Keep air from getting into the drum

101. Now you can untie the fold in the centre of the short gas line that runs to the inner tube gas holder. When you see the tube begin to swell, you will know that gas is being collected.

102. If you find that gas is leaking from the top of the drum after the unit has begun to work, seal the leaks with tar, mastic or paint as you were told to do in Item 47 in this booklet.

103. If gas is leaking around the gas outlet, T- piece, valve or inner tube, tighten them.

Note



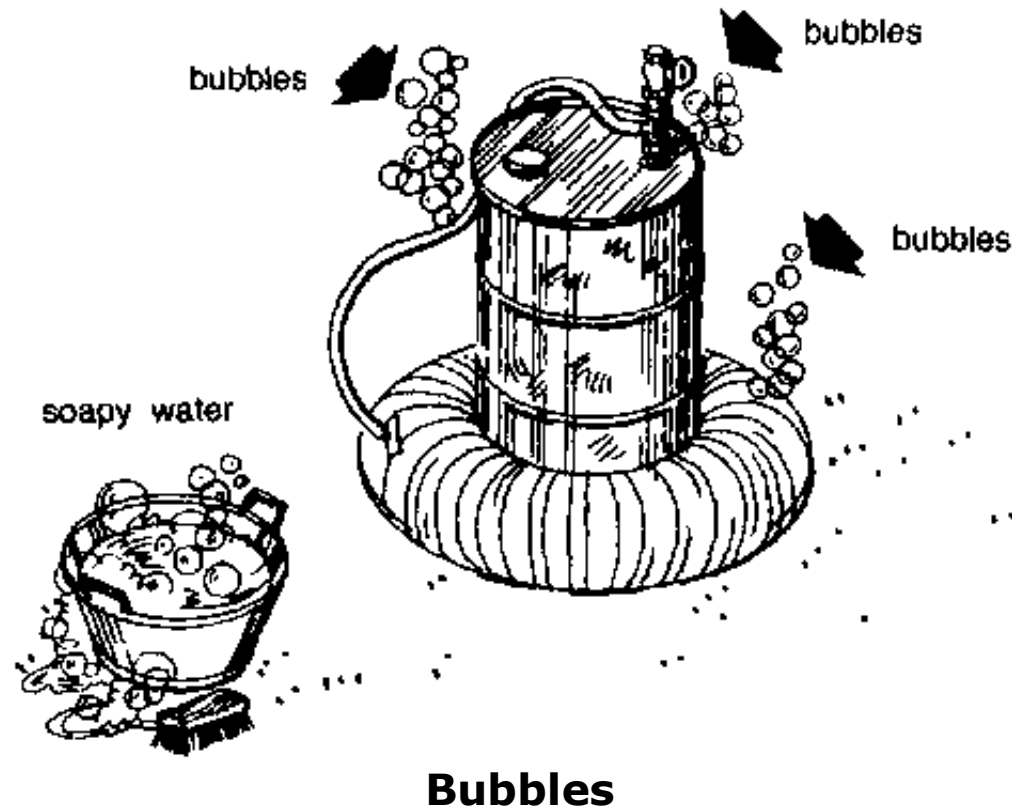





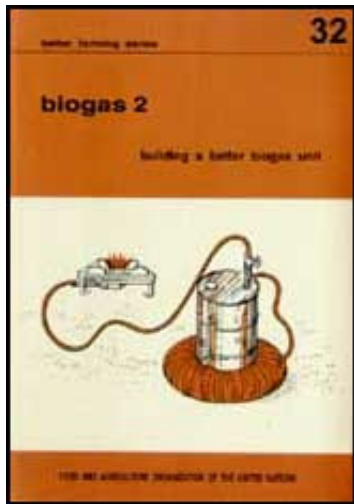



A good way to check for leaks after the biogas unit has begun to work is to put soapy water on the drum and on the joints of the parts and lines. If you see bubbles anywhere you will know that there is a leak. Seal all leaks as you have been told to do.



[Home](#) > [ar](#).[cn](#).[de](#).[en](#).[es](#).[fr](#).[id](#).[it](#).[ph](#).[po](#).[ru](#).[sw](#)

 **Better Farming Series 32 - Biogas 2: Building a Better Biogas Unit (FAO, 1986, 47 p.)**



-  **(introduction...)**
-  **Preface**
-  **Introduction**
-  **How to build a better small biogas unit**
-  **Putting in the waste**
-   **Time**
-  **Temperature**
-  **Scum**
-  **When the gas is made**
-  **Taking care of your biogas unit**
-  **Making more biogas**
-  **What more can you do?**

Time

104. It may take up to three weeks or even a month for the waste in your new biogas unit to begin making gas. After that, the unit will continue to make gas for about eight weeks.

105. During these eight weeks half of the gas will be made in the first two or three weeks and the rest in the last five or six weeks.

106. If you find that too little gas is being made in the last weeks empty the unit and start again.



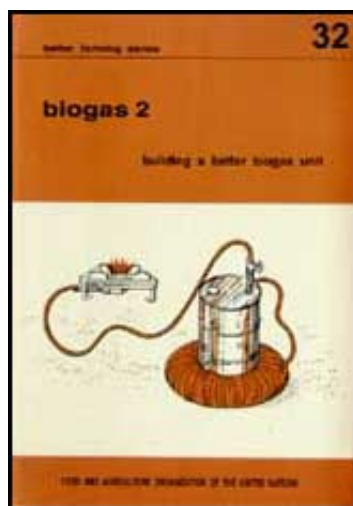

Better Farming Series 32 - Biogas 2: Building a Better Biogas Unit (FAO, 1986, 47 p.)

Temperature

 *(introduction...)*

 Cold weather protection

Better Farming Series 32 - Biogas 2: Building a Better Biogas Unit (FAO, 1986, 47 p.)

Temperature

107. You have been told in Booklet No. 31 that biogas is best produced at a temperature between 32 and 37°C. When the temperature is below 15°C, almost no gas is made.

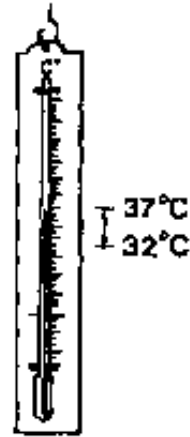

Temperatures to produce biogas

Cold weather protection

108. If the temperature where you live often falls below 15°C, you can keep the waste mixture warm by covering this biogas unit with plant materials such as leaves, grass, straw or maize stalks.

put leaves, grass, straw
or maize stalks
around the oil drum

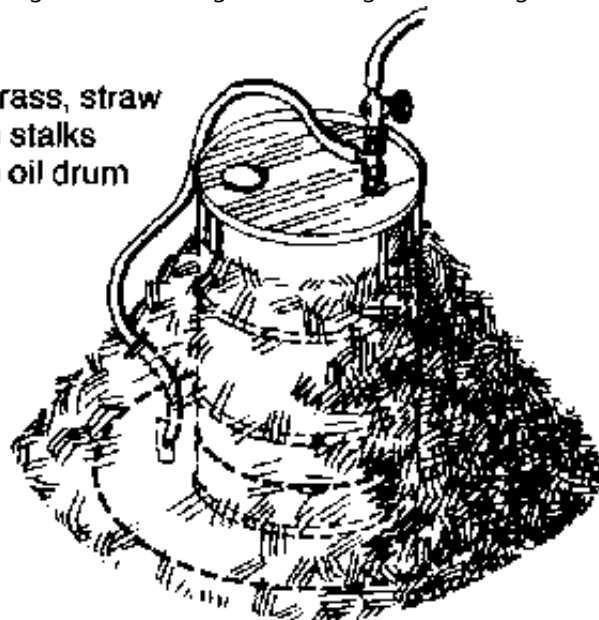

Protect the drum oil

109. However, as you were told in Item 28 in this booklet, you must not put this unit underground as you could with your old unit or you will not be able to shake it to break up the scum



[Home](#) > [ar](#).[cn](#).[de](#).[en](#).[es](#).[fr](#).[id](#).[it](#).[ph](#).[po](#).[ru](#).[sw](#)

 **Better Farming Series 32 - Biogas 2: Building a Better Biogas Unit (FAO, 1986, 47 p.)**

 ***(introduction...)***

 **Preface**

 **Introduction**

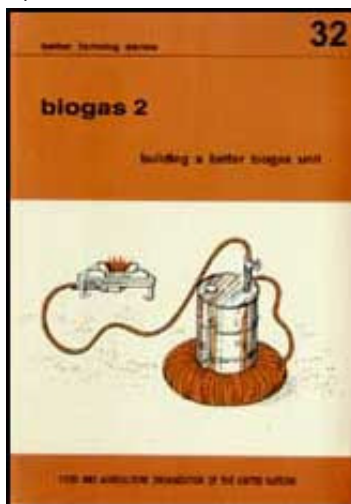

- How to build a better small biogas unit**
- Putting in the waste**
- Time**
- Temperature**
- Scum**
- When the gas is made**
- Taking care of your biogas unit**
- Making more biogas**
- What more can you do?**

Scum

110. Sometimes a hard layer of scum may form on top of the waste mixture in your biogas unit. If this happens, less gas will be made and gas will not collect in the inner tube.

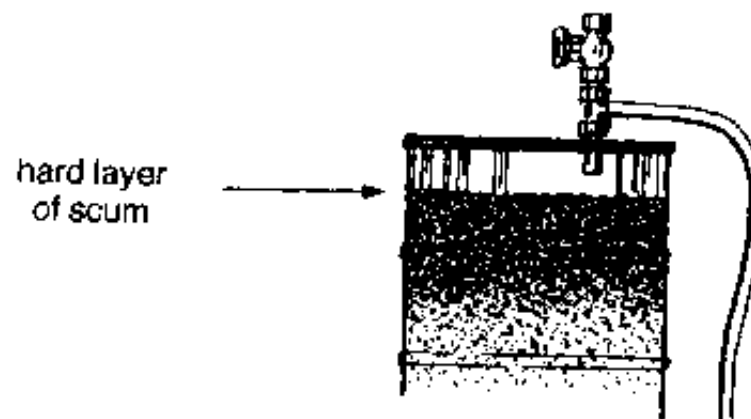

Hard layer of scum

111. If the waste is well mixed before it is put into unit, there will be less chance for scum to form and your biogas unit will make gas well.

112. Scum is more likely to form if you use plant materials than if you use only animal waste.

113. To keep scum from forming, shake your biogas unit from time to time. The drawing below shows you how.

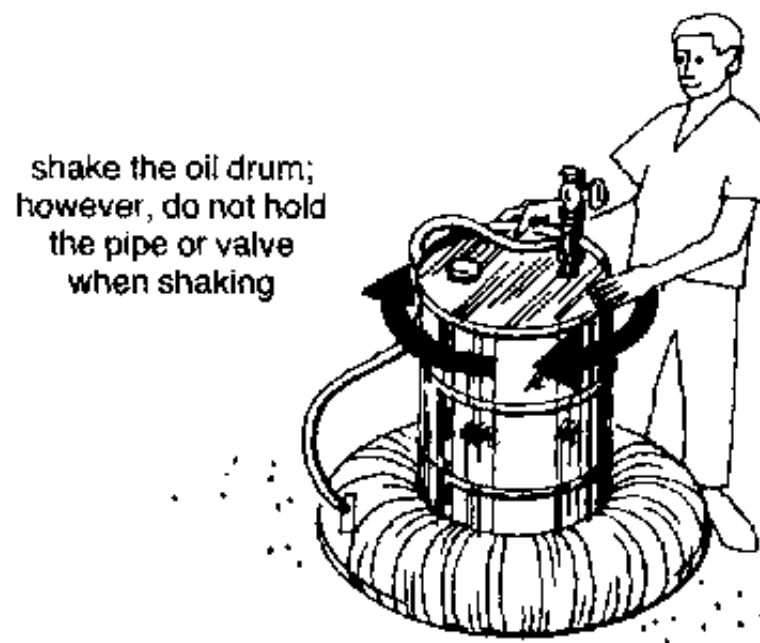

Shake the oil drum



[Home](#) > [ar](#).[cn](#).[de](#).[en](#).[es](#).[fr](#).[id](#).[it](#).[ph](#).[po](#).[ru](#).[sw](#)

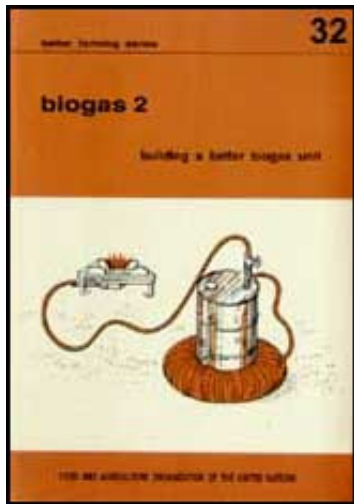

Better Farming Series 32 - Biogas 2: Building a Better Biogas Unit (FAO, 1986, 47 p.)

 **(introduction...)**

 **Preface**

 **Introduction**

How to build a better small biogas unit

Putting in the waste

 **Time**

Temperature

 **Scum**

  **When the gas is made**

 **Taking care of your biogas unit**

 **Making more biogas**

What more can you do?

When the gas is made

114. Do not burn the first gas that is made in your biogas unit. It may have air in it and could explode.

115. A few days after the inner tube has begun to swell with gas, open the valve and let out all of the gas that has been collected.

116. While you are letting the gas out be very careful not to have fire near the biogas unit.

117. After the valve is open you will have to force the gas out of the inner tube or tubes.

118. You can force gas out of a tube by rolling it as you were told to do in Item 63 in this booklet, or by putting a weight on it such as pieces of wood or stones.

119. The drawings on the next page show you how to force air out of a biogas unit with one or more inner tubes.

120. When all of the gas is out, close the valve and your biogas unit will begin to collect gas again.

121. If you have done this carefully, the next gas that is made will have no air in it and will be safe to burn. Do not open the unit again until all the gas has been made.

leave large tube
attached to the oil drum
and force out gas
with pieces of wood

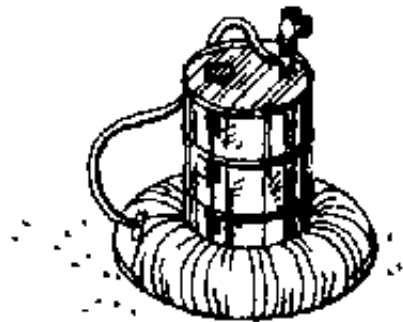

remove large tube
and force out gas

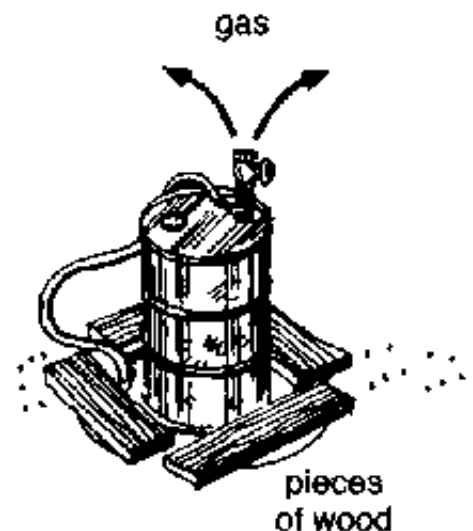

by rolling it

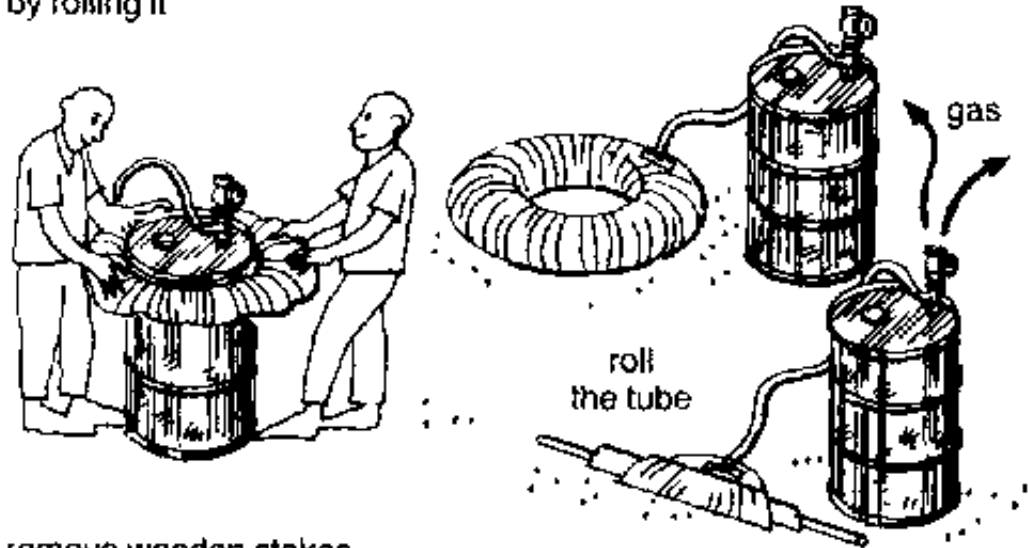

remove wooden stakes
and force out gas
with pieces of wood

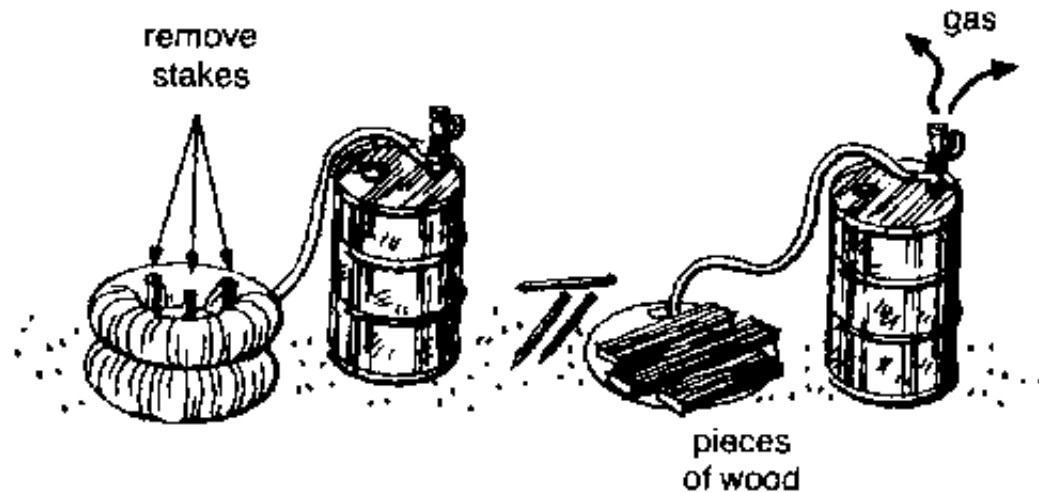

Collect gas

122. Now you can attach the gas line to the top of the valve. However, do not open the valve until the inner tube is half full. Later, you can help to push the gas out of the inner tube by putting a few stones or bricks on it.

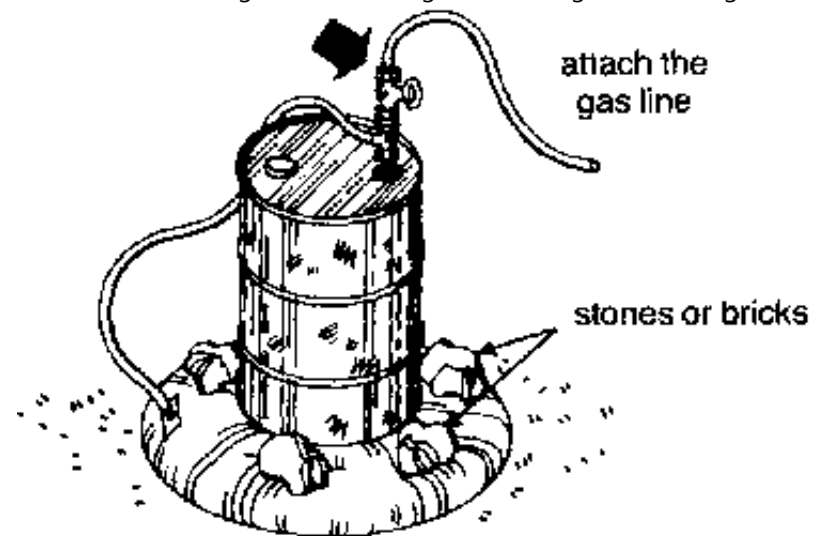

Attach the gas line

123. Items 108 to 114 in Booklet No. 31 tell you how to use biogas for cooking and how to clean the burner.

124. After all the gas has been made, take the unit apart and empty out the fertilizer. Items 115 to 118 in Booklet No. 31 tell you how to use the fertilizer.

125. However, be sure to keep about 4 litres of the fertilizer to be used as a starter for next time.

keep 4 litres
of fertilizer
as a starter



Keep fertilizer as a starter

126. Clean the unit carefully and check for leaks.

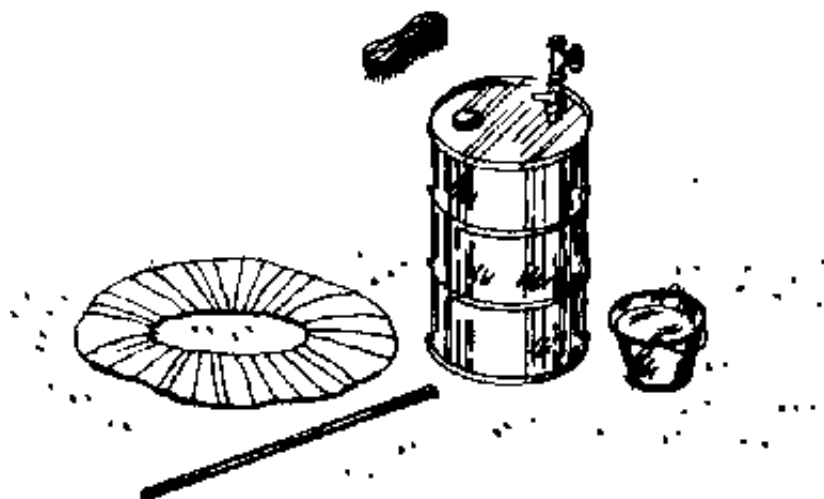

Check for leaks

127. Now fill the unit with new waste material and add the starter. Close the unit tightly and it will begin to make gas again.



Fill oil drum with waste

128. Remember, every time you start again, do not burn the first gas that is made.

