

AT MICROFICHE
REFERENCE
LIBRARY

A project of Volunteers in Asia

Solar Photovoltaic Products: A guide for development
workers

By: Anthony Derrick, Catherine Francis, & Varis Bokalders

Published by: Intermediate Technology Publications
103/105 Southampton Row
London WC1B 4HH
U.K.

In association with: The Swedish Missionary Council and the
Stockholm Environment Institute 1991

Available from: Intermediate Technology Publications
103/105 Southampton Row
London WC1B 4HH
U.K.

Reproduced with permission.

Reproduction of this microfiche document in any form is subject to the same
restrictions as those of the original document.

SOLAR PHOTOVOLTAIC PRODUCTS

A guide for development workers

Anthony Derrick, Catherine Francis and Varis Bokalders



The Stockholm Environment Institute

Swedish Missionary Council

IT Power

**REVISED
EDITION**

SOLAR PHOTOVOLTAIC PRODUCTS

NOTICE

Neither the publishers nor I T Power, the Stockholm Environment Institute, the Swedish Missionary Council or the Swedish International Development Agency make any warranty expressed or implied, or assumes any legal liability or responsibility for the accuracy, completeness or usefulness of any information, apparatus, product, or process disclosed, or represent that its use would not infringe privately owned rights. Reference herein to any specific commercial products, process, or service by trade-name, mark, manufacture, or otherwise, does not necessarily constitute or imply its endorsement, recommendations, or favouring by the authors, sponsors and publishers of this guide.

This Guide presents technical and price information on the photovoltaic products of some manufacturers and suppliers. Inclusion of the specific manufacturers or suppliers and their products does not constitute or imply endorsement nor should an omission of a manufacturer or supplier or product be considered indicative or significant in any respect. Price data where given were obtained in 1990 and will be approximate only. As a result of exchange rate fluctuations and price revision by suppliers, comparisons of the prices of products from different suppliers would be incorrect and should not be undertaken.

The authors, sponsors and publishers assume no responsibility for any personal injury or property damage or other loss suffered in activities related to information presented in this book.

Published by Intermediate Technology Publications Ltd
103/105 Southampton Row, London, WC1B 4HH, UK

© Intermediate Technology Publications and IT Power 1991

ISBN 1-85339-002-X

Printed by the Russell Press Ltd., Radford Mill,
Norton Street, Nottingham NG7 3HN.

SOLAR PHOTOVOLTAIC PRODUCTS

A guide for development workers

**Anthony Derrick, Catherine Francis
and Varis Bokalders**

REVISED EDITION

Intermediate Technology Publications in association with The Swedish
Missionary Council and the Stockholm Environment Institute 1991

FOREWORD

This book is the result of a cooperative project involving I.T. Power Ltd, the Stockholm Environment Institute and SMC, the Swedish Missionary Council, and is sponsored by SIDA, the Swedish International Development Authority. Its origin stems from the needs of SMC field staff who have found much of the information currently available on photovoltaics to be fragmented and often incompatible.

This book is an updated version of the 1988 publication with the same name, produced jointly by IT-Power, the Beijer Institute and the Swedish Missionary Council. During 1989, the Beijer institute was integrated into the new Stockholm Environment Institute .

The Stockholm Environment Institute, which has close working contacts with the SMC in the field of renewable energy, runs an information programme on renewable energy for development which has resulted in a series of publications and seminars. I.T. Power has substantial experience of renewable energy matters and for many years has taken a particular interest in photovoltaics.

Photovoltaics (PV) were a natural choice as the subject of the first cooperative project. PV is a mature technology which has already proven its reliability in several important niches, not least in many small scale applications in developing countries such as water pumping, refrigeration, lighting and telecommunications. Large numbers of PV systems are currently being installed. This proliferation of the technology has, however, created a need for accurate, reliable and objective information among field workers who seldom have time to grasp the intricacies of all the various gadgets offered to them by manufacturers and agents. PV thus differs from several other renewable energy technologies in that it has already been proven under widely varying circumstances, and that a major bottleneck to its dissemination is not connected to the technology as such (as is the case with many other renewable energy sources), but rather to the lack of availability of reliable information on its operation, cost and range of applications.

This book aims at addressing this shortfall of information, and we hope that the combined experience of our three organizations will be of assistance to other workers in the field.

Lars Kristoferson
Stockholm Environment Institute

December 1990

CONTENTS

Page

PREFACE

ACKNOWLEDGEMENTS

1. INTRODUCTION

- 1.1 What is Photovoltaics? 1
- 1.2 Why Photovoltaics? 2

2. OVERVIEW OF PHOTOVOLTAICS

- 2.1 Brief History 3
- 2.2 The Photovoltaic Process 6
- 2.3 Modules and Arrays 7
- 2.4 Systems 10
- 2.5 Overview of the Economics 13

3. IMPLEMENTATION CONSIDERATIONS

- 3.1 The Solar Resource 15
- 3.2 System Sizing 21
- 3.3 Procurement 24
- 3.4 Safety 27

4. BATTERIES, POWER CONTROL UNITS AND BATTERY CHARGING SYSTEMS

- 4.1 Batteries 28
- 4.2 Power Control Units 34
- 4.3 Battery Charging Systems 36
- 4.4 Implementation Considerations 37
- 4.5 Product Information Sheets 39

5. WATER PUMPING

- 5.1 Experiences 42
- 5.2 Relative Merits 44
- 5.3 Commercially Available Equipment 47
- 5.4 Procurement 53
- 5.5 Implementation Considerations 59
- 5.6 Product Information Sheets 60

6. VACCINE REFRIGERATION FOR HEALTH CARE

6.1	Experiences	65
6.2	Relative Merits	68
6.3	Commercially Available Equipment	70
6.4	Procurement	72
6.5	Implementation	73
6.6	Product Information Sheets	76

7. LIGHTING

7.1	Experiences	79
7.2	Relative Merits	80
7.3	Commercially Available Equipment	83
7.4	Procurement	86
7.5	Implementation	88
7.6	Product Information Sheets	90

8. RURAL TELECOMMUNICATIONS

8.1	Experiences	94
8.2	Relative Merits	95
8.3	Commercially Available Systems	95
8.4	Procurement	96
8.5	Implementation	96
8.6	Product Information Sheets	98

9. OTHER APPLICATIONS

9.1	Introduction	99
9.2	Water Treatment	99
9.3	Agricultural Applications	100
9.4	Fisheries Applications	100
9.5	Transport	100
9.6	Security Systems	101
9.7	Corrosion	101
9.8	Domestic Appliances	101
9.9	Product Information Sheets	102

10. FREQUENTLY ASKED QUESTIONS

GLOSSARY	106
-----------------	-----

APPENDIX 1	Life Cycle Costing	109
APPENDIX 2	Suppliers Name and Addresses	113
APPENDIX 3	Tender Document Format	123

PHOTOVOLTAIC PRODUCTS - A GUIDE FOR DEVELOPMENT WORKERS

PREFACE

This handbook aims to assist anyone with a little technical experience, but probably no previous knowledge of photovoltaic (PV) systems to decide:

- if a power supply is suitable for the purpose in mind
- the type of equipment needed;
- how to proceed in implementing a project using PV products

This guidebook has been prepared by I.T. Power Ltd of Eversley, UK and the Stockholm Environment Institute, Sweden for the Swedish Missionary Council Office for International Development Cooperation.

Contact persons at these Institutions are:

Anthony Derrick	Varis Bokalders	Karl-Erik Lundgren
I.T. Power Ltd The Warren Bramshill Road Eversley, Hants RG27 0PR, UK Tel: +44-734-730073 Tlx: 846852 Fax: +44-734-730820	The Stockholm Environment Institute Box 2142 Jarntorget, 84 S-10314 Stockholm Sweden Tel: +46-8-16 04 90 Tlx: 17148 Fax: +46-8-7230348	Swedish Missionary Council Office for International Development Cooperation Tegnergatan 34 n.b. 113 59 Stockholm Sweden Tel: +46-8-30 60 50 Tlx: 19248 Fax: +46-8-31 58 28

ACKNOWLEDGEMENTS

The authors wish to thank the Swedish International Development Authority for supporting this guide and gratefully acknowledge the information provided by the photovoltaic systems industry. The authors also wish to thank their colleagues at I.T. Power and Stockholm Environment Institute for useful comments received. Particular thanks are due to Mr Karl-Erik Lundgren of the Swedish Missionary Council.

1. INTRODUCTION

1.1 WHAT IS PHOTOVOLTAICS?

Photovoltaics is a technology that can convert light directly into electricity. (The term photovoltaic is often abbreviated to PV.)

The sunniest regions of the world receive a vast amount of energy from the sun every day. At the peak of the day the power from the sunshine falling over one square kilometre of Kenya is equivalent to the total being supplied by the country's electric grid. Solar energy can be converted directly into electricity. The technology used to do it is called photovoltaics.

Photovoltaic systems are being used in developing countries to provide power for water pumping, lighting, vaccine refrigeration, electrified livestock fencing, telecommunications cathodic protection, water treatment and many other applications.

Some tens of thousands of systems are currently in use yet this number is insignificant compared to the vast potential for PV applications.



Installing the Solar Array of a Solar Powered Refrigeration and Lighting System for a Health Centre In Zaire (IT Power)

1.2 WHY PHOTOVOLTAICS?

The majority of the population in developing countries live in dispersed communities in rural areas. The provision of an electricity supply to these areas is difficult and costly; extension of the mains grid over difficult terrain is generally not economic for small power loads and the use of diesel generator sets relies on the availability of fuel supplies and maintenance skills.

Photovoltaic modules provide an independent, reliable electrical power source at the point of use making it particularly suited to remote or inaccessible locations. PV systems are technically and economically viable. Their principal advantages are:

- **PV systems have no fuel requirements:**
In remote areas diesel or kerosene fuel supplies are erratic and often very expensive. The recurrent costs of operating and maintaining PV systems are small.
- **PV systems are modular:**
A solar array is composed of individual PV modules so each system can be sized to meet the particular demand.
- **PV systems can be used to improve quality of life:**
For example, the provision of lighting in a rural school allows evening educational or community activities. Refrigeration at a health centre improves effectiveness of immunization programmes.
- **PV systems are highly reliable:**
The reliability of PV modules is significantly higher than of diesel generators or wind generators.
- **PV systems are easy to maintain:**
Operation and routine maintenance requirements are simple.
- **PV modules have a long life:**
There is little degradation in performance over 15 years.
- **PV systems provide national economic benefits:**
Reliance on imported fuels such as coal and oil is reduced.
- **PV systems are environmentally benign:**
There is no harmful pollution through the use of a PV system and no contribution to "greenhouse gases".
- **PV systems are economically viable:**
On a life cycle cost basis and taking into consideration the higher reliability of PV, many small scale applications can be more economically powered by PV than with diesel systems, or other small power supplies.

2. OVERVIEW OF PHOTOVOLTAICS

2.1 BRIEF HISTORY

Until recently, price has been the main barrier to the widespread use of photovoltaics. In 1975, this was over \$30/Watt. Since then, improvements in manufacturing technology and production volumes have reduced prices to their present 1991 level of around \$4 per Watt. This has resulted in making photovoltaic power economic in areas remote from mains electricity grids.

The photovoltaic effect was first observed by the French scientist Becquerel in 1839 who noticed that when light was directed onto one side of a simple battery cell, the generated current could be increased.

The first practical photovoltaic devices were selenium and cuprous oxide cells used for photographic exposure meters and light sensors. Light to electricity efficiencies of about 1 per cent were achieved in the early 1940s.

It was not until the late 1950s, however, that crystalline silicon solar cells were developed with high enough conversion efficiencies to be used for power generators. A major impetus for the development of these cells was the space programme. The first solar-powered satellite, Vanguard I, was launched by the USA in 1958. The output for terrestrial PV modules matured in 1983 with the introduction of automated PV production plants (see Figure 2.1).

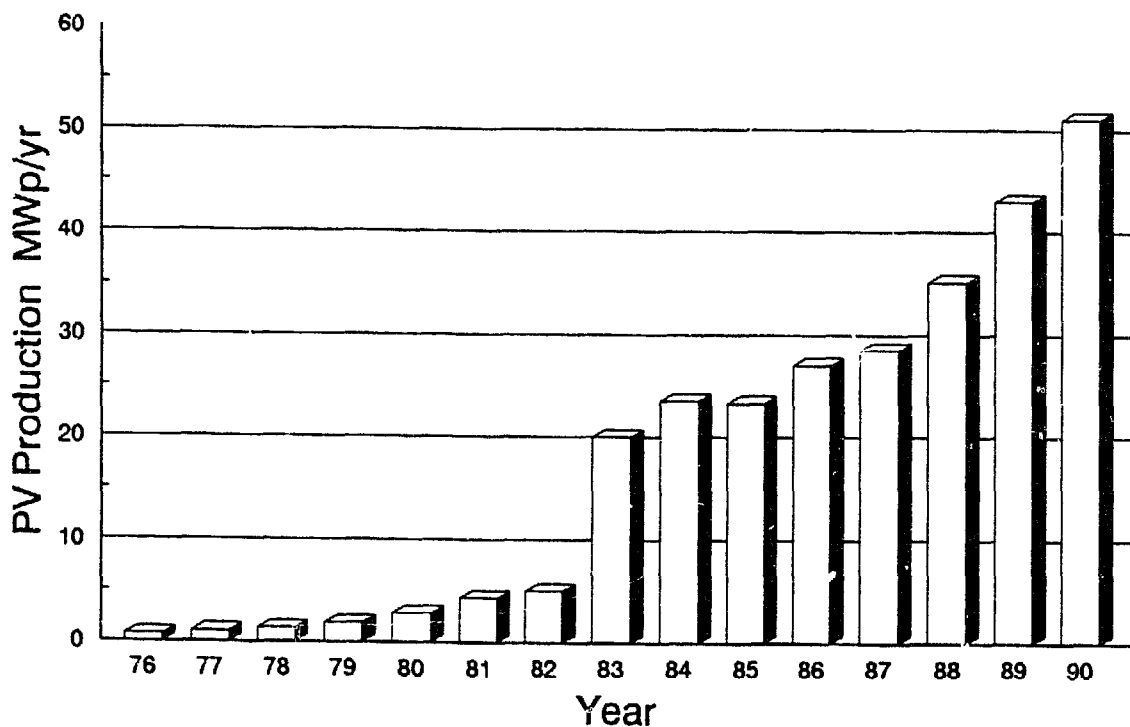

Figure 2.1 PV Module Production in Recent Years

2.1.1 Technology and Prices

Over the last ten years, the price of photovoltaic modules and systems has been steadily falling in real terms. Module prices for both forms of crystalline silicon are currently around \$4/Wp (exclusive of delivery or taxes) for large orders. Bearing in mind that the cells account for about 60 per cent of the module price, some further price reductions, possibly down to about \$2-\$3/Wp, are foreseen through the introduction of cheaper silicon and larger, fully automated manufacturing plants. Much lower costs, even down to \$1/Wp or less, are potentially attainable with thin film cells. In view of the large efforts being made world-wide to develop different thin film technologies including Cadmium Telluride, CIS and Multijunction devices, it is probable that large-area thin film cells will become available with much improved efficiency and stability compared with current products. Some researchers maintain that crystalline silicon cells could continue to be competitive with thin film processes for several years.

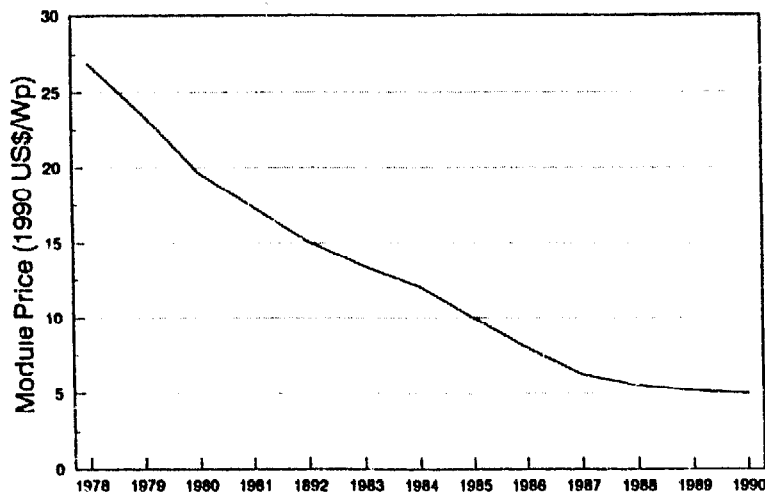

Figure 2.2
PV Price History

2.1.2 The Future Market

Market prospects are largely dependent on prices of photovoltaics in relation to alternative energy sources, but other factors are important, such as government incentives, availability of finance and the general perception of the technology held by

YEAR	LOW PRICE SCENARIO			HIGH PRICE SCENARIO		
	Modules \$/Wp	Systems \$/Wp	Sales MWp/yr	Modules \$/Wp	Systems \$/Wp	Sales MWp/yr
1990	4.0	8-15	52	4.0	8-15	52
1995	2.0	3-7	700	3.0	6-10	100
2000	1.5	2.5-5	1000	3.0	5-9	200

Table 2.1 Projection of PV Prices and Sales to - 2000 (1990 US\$)

potential customers. Although it is not possible to predict with precision what the future market will be, Table 2.1 indicates what the future sales of photovoltaic systems worldwide might be for two scenarios. The low price scenario assumes that large area thin film cells with adequate performance are utilised for power applications within the next two to three years; the high price scenario is based on the assumption that the technical or cost targets for thin film cells remain elusive, leaving crystalline silicon as the dominant technology for power applications.

For the low price scenario, with module prices falling to around \$1.5/Wp, total annual sales are projected to grow rapidly, from the 1990 level of about 52 MWp to as high as 1000 MWp by AD2000, with continued expansion thereafter. Most of the output would be in and for developing countries for rural off-grid applications using stand-alone systems, but there would also be many applications in industrialized countries for consumer systems, professional systems and remote houses and villages. Grid-connected applications (central power and distributed) could begin to become a significant market in some countries by the late 1990s.

For the high price scenario (now increasingly looking a pessimistic scenario), with crystalline silicon modules prices falling to about \$3/Wp and thin film cells not able to compete for power applications, the total market would grow much more slowly, possibly levelling out at about 200 MWp per annum by AD2000. Most of the sales would be for consumer systems and professional systems, with relatively little going to rural electrification, because of the high capital costs involved. However, in some countries, there would be good markets among more wealthy private customers for powering isolated houses and for consumer systems, particularly for the tourist and leisure markets. This scenario also assumes systems installed by national governments and public utilities would be relatively limited, probably only a few megawatts per annum.

2.1.3 Market Development

Developing countries have always been considered as a very large potential market but, due to financing problems, actual commercial sales in these countries are at present very small. In fact, the greater part of the systems installed to date in developing countries has been assisted by foreign governments and/or the international aid agencies. Developing countries are rightly concerned to ensure that at the right time photovoltaic technology is transferred to them, rather than find themselves dependent yet again on an imported energy technology. In due course, it is likely that most developing countries will have their own PV industry, but this will take many years to establish, during which time there will be a need to import systems for demonstration projects, professional applications and key community applications. At present photovoltaics are manufactured in Brazil, China and India on a commercial scale in the developing world.

Significant markets can be expected to develop for professional systems, particularly for telecommunications, village water supplies and generators for police posts and health centres. If system costs can be brought down to about \$5/Wp rural electrification using photovoltaics will become a viable option in many situations, with market potential reckoned in many hundreds of megawatts per annum.

2.2 THE PHOTOVOLTAIC PROCESS

When light falls on the active surface, the photons in a solar cell become energised, in proportion to the intensity and spectral distribution of the light. When their energy level exceeds a certain point a potential difference, or open circuit voltage (V_{oc}), is established across the cell. This is then capable of driving a current through an external load.

Most modern photovoltaic devices use silicon as the base material mainly as mono-crystalline or multi-crystalline cells but recently also in amorphous form.

The main features of a mono-crystalline silicon cell are shown in Figure 2.3. It is made from a thin wafer of a high purity silicon crystal, doped with a minute quantity of boron. Phosphorus is diffused into the active surface of the wafer. The front electrical contact is made by a metallic grid and the back contact usually covers the whole surface. An anti-reflective coating is applied to the front surface.

The process of producing efficient solar cells is costly due to the use of expensive pure silicon and the energy consumed. Research work to develop new manufacturing technologies continues.

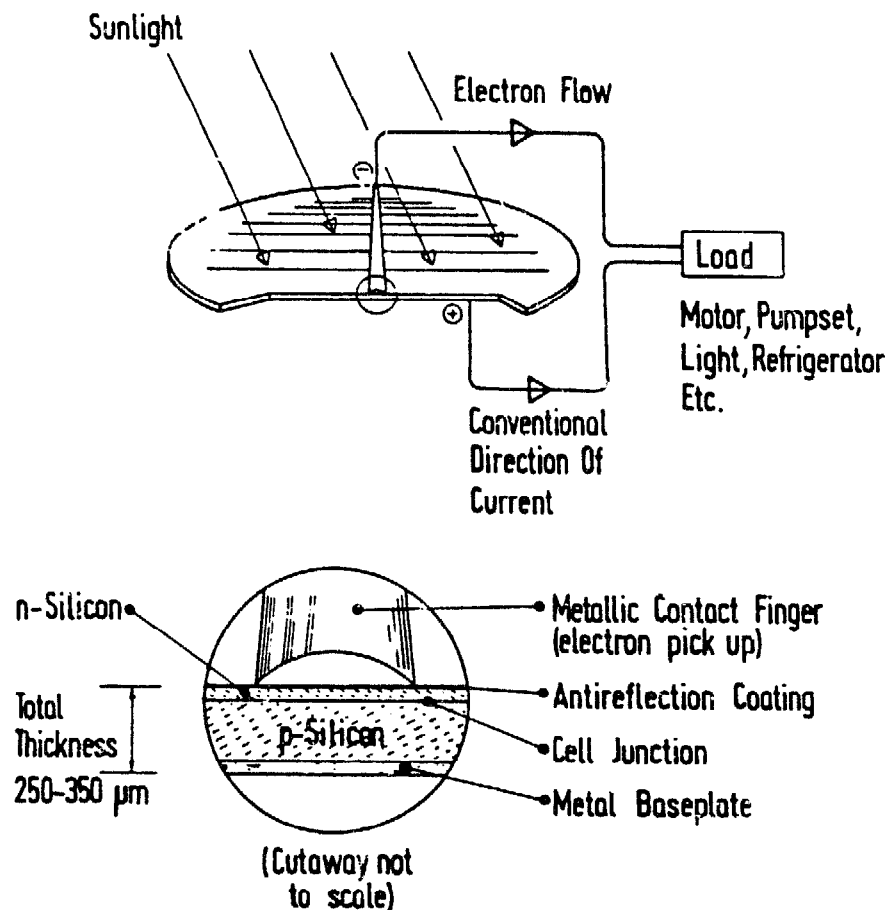

Figure 2.3 Features of a Mono-Crystalline Silicon Solar Cell

2.3 MODULES AND ARRAYS

Solar cells are interconnected in series and in parallel to achieve the desired operating voltage and current. They are then protected by encapsulation between glass and a tough resin back. This is all held together by a stainless steel or aluminium frame to form a **module**. These modules form the basic building block of a **solar array**. Modules may be connected in series or parallel to achieve the required solar array characteristics.

Thus, with no moving parts and all delicate surfaces protected, the modules can be expected to provide power for 15 years or more. Many suppliers give warranties of 10 years or more.

Commercially available modules fall into four types based on the solar cells used. These are:

- **mono-crystalline cell modules** where highest cell efficiencies of around 16% are obtained. Figure 2.4 shows the construction of a mono-crystalline silicon PV module. The cells are cut from a mono-crystalline silicon crystal.
- **multi-crystalline cell modules** where the cell manufacturing process is of lower cost but cell efficiencies of only around 13% are achieved. A multi-crystalline cell is cut from a cast ingot of multi-crystalline silicon and is generally square in shape.
- **amorphous silicon modules** are made from thin films of amorphous silicon where efficiency is much lower (5-9%) but the process uses less material. The potential for cost reduction is greatest for this type. Unlike mono-crystalline and multi-crystalline cells with amorphous silicon there is some degradation of power output with time.
- **multijunction types** where different layers of thin film photovoltaic material are used with each layer receptive to a particular part of the solar spectrum thereby achieving higher efficiencies.

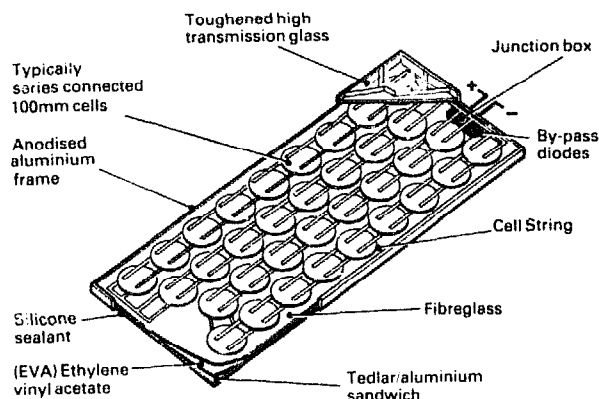

Figure 2.4 Construction of Mono-crystalline PV Module (BP Solar)

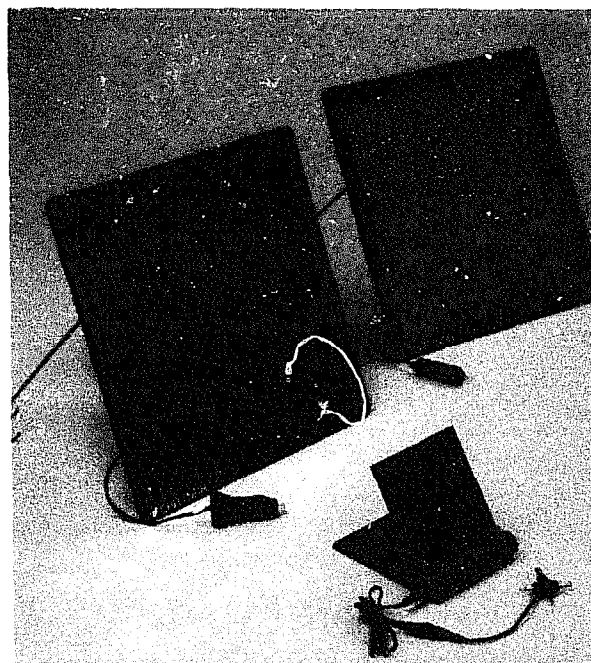

Figure 2.5 Amorphous Silicon Modules

The current-voltage relationship (I-V) for a typical module is dependent on solar irradiance and temperature. As the level of solar irradiance increases so the output current will increase proportionately. Conversely, as cell temperature increases, the current will increase slightly but the voltage will decrease significantly, resulting in a decrease in power. Figure 2.6 illustrates these characteristics.

The main importance of Figure 2.6 is to show that:

- It is desirable to operate the cells at as low a temperature as possible.
- The maximum power output realisable from a PV cells is when the operating conditions are at the "knee" of the I-V curve. This is referred to as the "Watt Peak" - W_p - of the cell. For comparative purposes, this is measured at an irradiance level of 1000 W/m^2 and a temperature of 25°C .

An array can vary from one or two modules with an output of 10W or less, to a vast bank of severai kilowatts. Figure 2.7 shows a typical installation for a remote dwelling with a few modules on the roof to charge a battery typically for lighting use. This can be compared to the array shown in Figure 2.8 which provides the needs of a community and requires large battery storage, power conditioning equipment and a mini-grid distribution system.

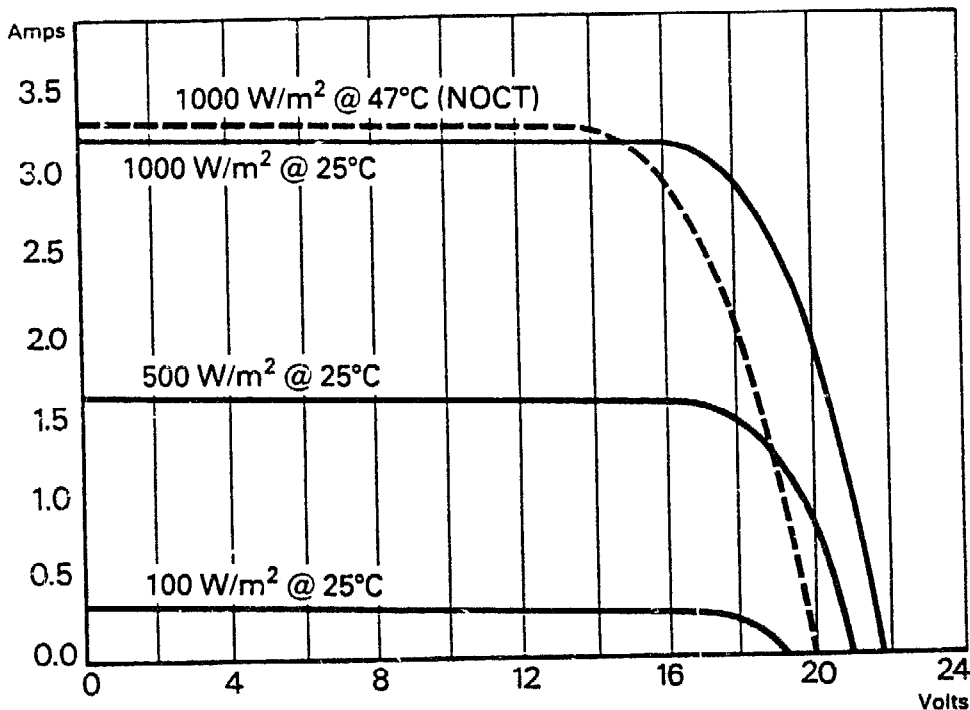

NOCT = Nominal Operating Cell Temperature

Figure 2.6 Electrical Characteristics of a Typical PV Module

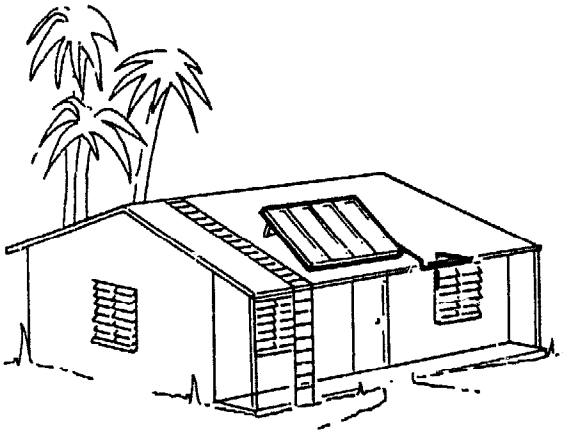

Figure 2.7 Individual Dwelling Electrification

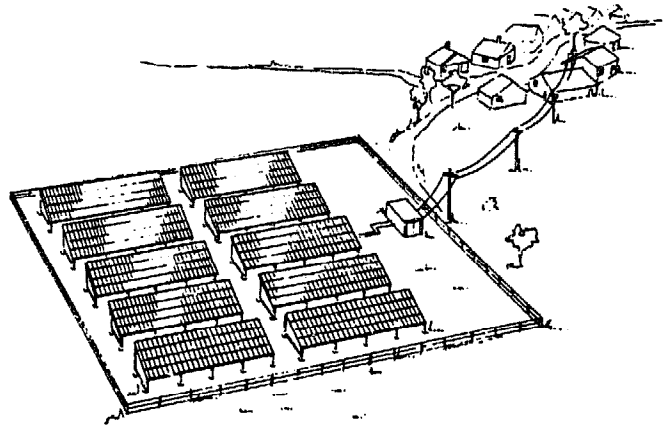

Figure 2.8 Photovoltaic Array Supplying a "Mini - Grid"

Flat plate arrays which are held fixed at a tilted angle and face towards the equator are most common. The angle of tilt should be approximately equal to the angle of latitude for the site. A steeper angle increases the output in winter; a shallower angle gives more output in summer. It should be at least 10 degrees to allow for rain runoff (Figure 2.9).

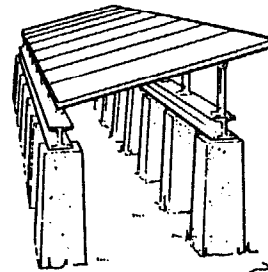

Figure 2.9 Fixed Flat Plate Array

Tracking arrays follow the path of the sun during the day and thus theoretically capture more sun. However, the increased complexity and cost of the equipment rarely makes it worthwhile.

Mobile (portable) arrays (Figure 2.10) can be of use if the equipment being operated is required in different locations such as with some lighting systems or small irrigation pumping systems.

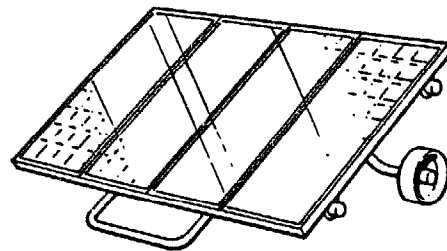

Figure 2.10 Mobile Array

2.4 SYSTEMS

The term "system" is used to describe the complete set of equipment used in converting solar energy to the final requirement, eg light, pumped water or refrigeration. PV systems are mainly used as stand-alone systems to provide a power supply independent of any grid. They are the main concern of this guide. However, PV arrays may also be used as a central generator connected to a local grid network or as a power station for a mains grid.

A stand-alone system can notionally be divided into three parts:

The **PV array** (comprising the photovoltaic modules and support structure) which converts solar energy to d.c. electricity.

The **power conditioning equipment** which is optional, but typically includes:

- cabling
- controller which may include battery overcharge protection to prevent gassing and loss of electrolyte from the battery, an automatic load disconnect facility for when battery voltage is low (to prevent damage to the load) and maximum power point tracking (array/load impedance matching).
- batteries: these should only be included when storage of electrical energy is required, eg, for lighting. When not essential batteries should be avoided due to the additional cost and maintenance requirements batteries impose.
- an inverter: to convert d.c. to a.c. electricity. As significant energy losses are always incurred in the conversion process it is preferable to use d.c. appliances and avoid the need for an inverter.

Load or end use equipment, eg lights, pumps and refrigerators. Most commercial suppliers now prefer to supply complete systems rather than individual components. These are sized for the specific location and energy demand required.

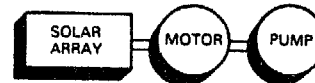

PV System Without Batteries (Solar Pump)

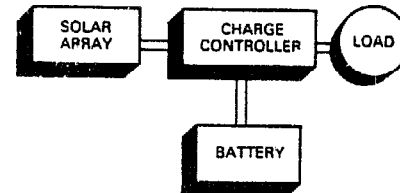

PV System with Battery

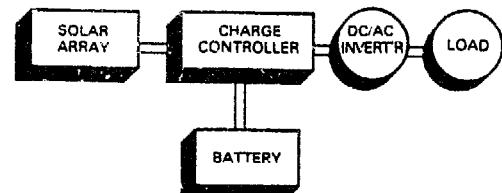

PV System with Inverter

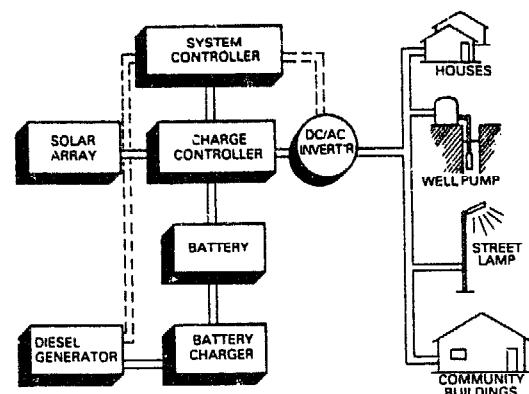

PV System with Multiple Load and Diesel Back-up

Applications of Photovoltaics

RURAL ELECTRIFICATION

- lighting and power supplies for remote buildings (mosques, farms, schools, mountain refuge huts)
- power supplies for remote villages
- battery charging stations
- portable power for nomads

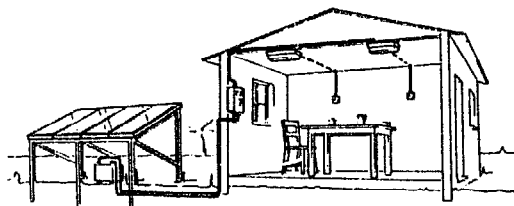

WATER PUMPING AND TREATMENT SYSTEMS

- pumping for drinking water
- pumping for irrigation
- de-watering and drainage
- ice production
- saltwater desalination systems
- water purification
- water circulation in fish farms

PV lighting for a Community Building

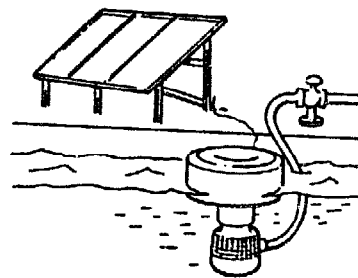

HEALTH CARE SYSTEMS

- lighting in rural clinics
- UHF transceivers between health centres
- vaccine refrigeration
- ice pack freezing for vaccine carriers
- sterilisers
- blood storage refrigerators

Floating Solar Powered Pump

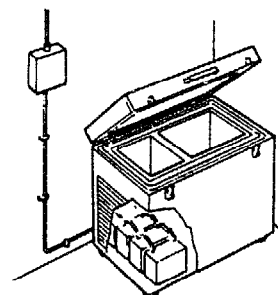

COMMUNICATIONS

- radio repeaters
- remote TV & radio receivers
- remote weather measuring
- mobile radios
- rural telephone kiosks
- data acquisition and transmission (river levels, seismographs)
- emergency telephones

PV Refrigerator for Vaccine Storage

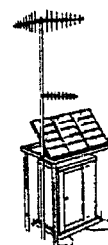

AGRICULTURE

- livestock watering
- irrigation pumping
- electrical livestock fencing
- stock tank ice prevention

PV Power for a Radio-Telephone Systems

TRANSPORT AIDS

- road sign lighting
- railway crossings and signals
- hazard and warning lights
- navigation buoys
- fog horns
- runway lights
- terrain avoidance lights
- road markers

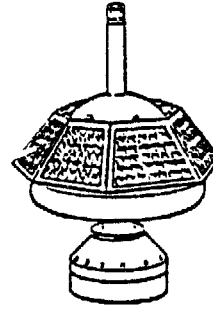

PV Powered Navigation Buoy

SECURITY SYSTEMS

- security lighting
- remote alarm system

CORROSION PROTECTION SYSTEMS

- cathodic protection for bridges
- pipeline protection
- well-head protection
- lock gate protection
- steel structure protection

MISCELLANEOUS

- ventilation systems
- camper and recreational vehicle power
- calculators
- automated feeding systems on fish farms
- solar water heater circulation pumps
- path lights
- yacht/boat power
- vehicle battery trickle chargers
- earthquake monitoring systems
- battery charging
- fountains
- emergency power for disaster relief
- aeration systems in stagnant lakes

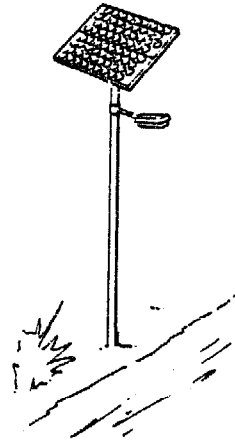

PV Street Lamp

INCOME GENERATION

- battery charging stations
- TV and video pay stations
- village industry power
- refrigeration services

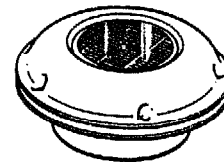

PV Powered Ventilator

2.5 OVERVIEW OF THE ECONOMICS

In an analysis of a potential PV system its viability must be assessed relative to the alternatives. In general, PV is most competitive where relatively small amounts of energy are required in areas remote from the grid. Typical viable demands are less than 50 kWh/day.

The economic characteristics of PV systems are different to that of most small power systems in that:

- the initial outlay on purchasing the equipment (the capital cost) is high
- there are no fuel costs
- maintenance costs are low
- reliability is high such that replacement costs are low
- the output of a system depends on its location, so its economic viability has to be assessed, for each case.

In undertaking an economic evaluation, the following parameters should be considered:

- the life cycle costs-which are the sum of the costs and benefits of the system accrued over its lifetime, expressed in present day value
- payback period - which is the length of time it takes for the total costs to be "paid for" by the value of benefits gained from the system
- rate of return - which is the value of the benefits gained from the system compared to the initial investment made.

The viable applications for photovoltaics include village water supplies, and livestock water pumping, lighting and refrigeration. The relative economics will, however, be dependent on local conditions including the solar resource at the site, local fuel costs and the particular application. Figure 2.11 shows how the comparative costs of PV, diesel generator and grid supplied electricity vary with solar energy received, fuel cost, demand and remoteness, from a grid.

Life cycle costing is the most complete analysis and normally undertaken to determine if an application is economic. A brief description of how to undertake life cycle costing is given in Appendix 1.

In practice, it is necessary to take into account the availability of funds. Larger amounts of money are required initially for PV systems to cover capital costs but then recurrent costs are lower. Hence, if there is uncertain funding in the future for fuel or maintenance, PV has an advantage. The World Health Organisation for example is promoting the use of PV to provide income generation for sustaining rural health care.

PV also offers less financially quantifiable advantages arising from its high reliability such as improved immunisation programmes (from more reliable vaccine refrigeration).

A brief description of the economic viability of each application is covered in the applications sections of this book.

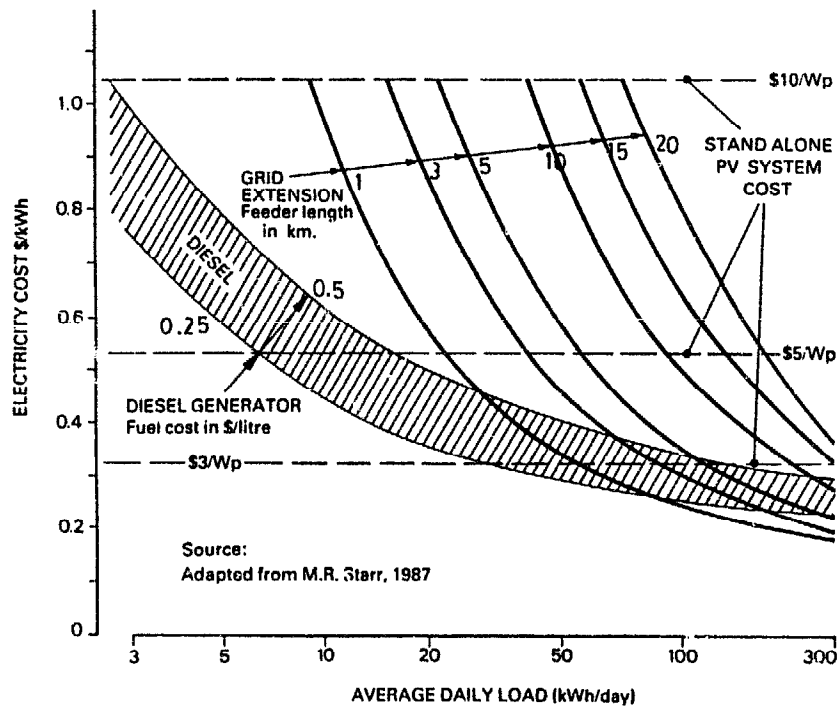

Figure 2.11 Comparative Costs of PV and Diesel Power

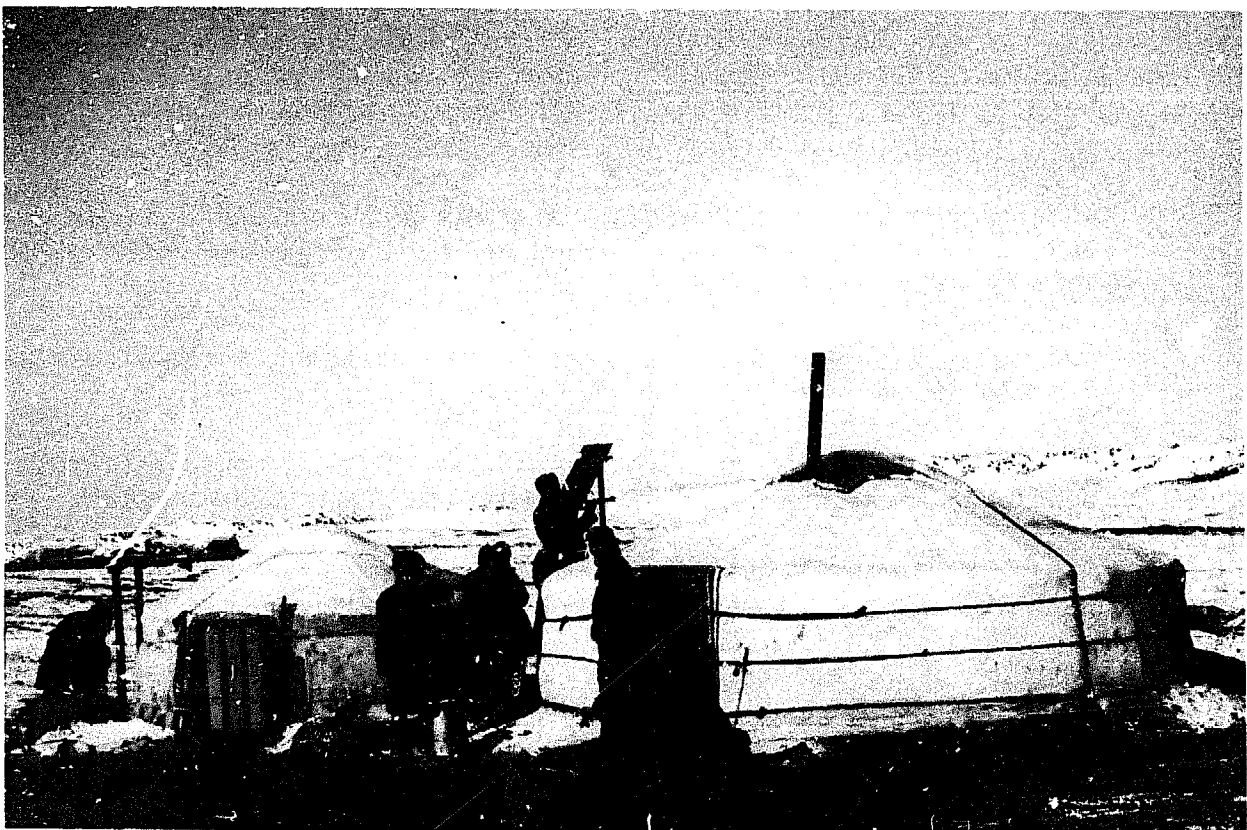

Figure 2.12 An Economic Application: Household Electricity in Mongolia

3. IMPLEMENTATION CONSIDERATIONS

3.1 THE SOLAR RESOURCE

The output of a solar array depends on the amount of sunlight or solar irradiance, falling on it, so it is important to determine how much solar energy is available at the site. Solar irradiance levels vary during the day with the angle of the sun, with season, with latitude and with climate.

The solar irradiance at ground level is made up of a direct component and a diffuse component. The sum of these two components on a horizontal plane is termed the 'global irradiance'. The diffuse component can vary from about 20 per cent of the global on a clear day, to 100 per cent in heavily overcast conditions. On a clear day in the tropics, with the sun high overhead, the global irradiance can exceed 1000 W/m^2 , but in northern Europe it rarely exceeds 900 W/m^2 , falling to less than 100 W/m^2 on a cloudy day.

Of most interest to potential users of photovoltaic systems is not, however, the instantaneous solar irradiance at a site but the total solar energy received in a day over a specific area. This is known as the daily solar irradiation or insolation. On the horizontal surface, this is typically 5 to 7 kWh per square metre per day in the tropics but can be less than 0.5 kWh per square metre per day on a winter's day in northern Europe. An example of the variation in the solar resource from month to month and day to day is shown in Figures 3.1 and 3.2.

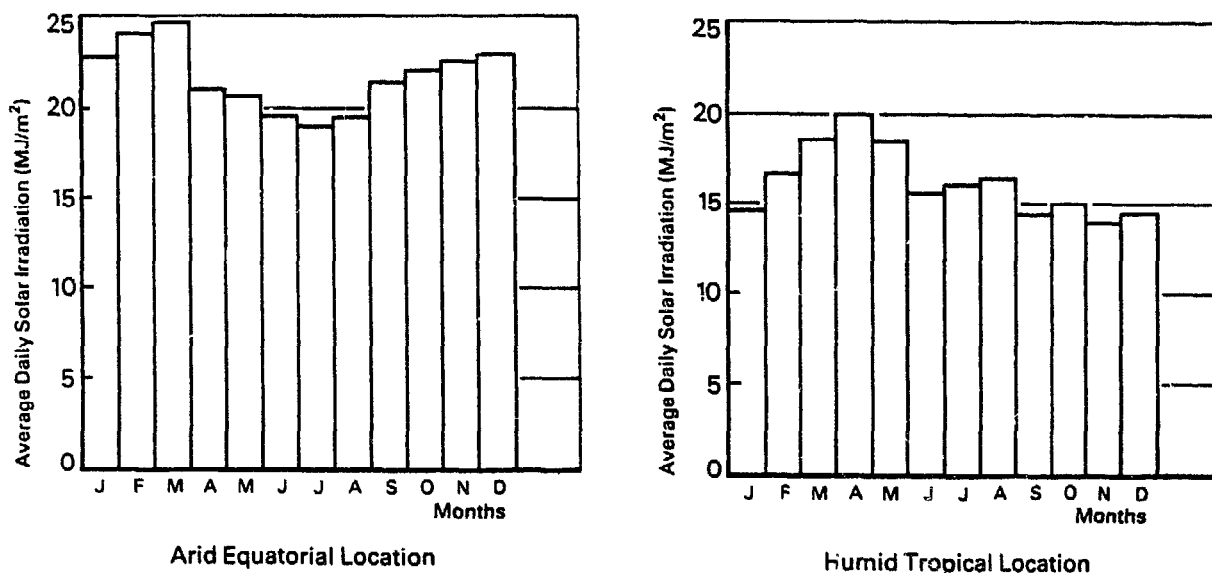

Figure 3.1 Typical Monthly Variations of Solar Energy Availability

As discussed earlier, it is normal to tilt a solar array to maximize the solar energy received. The world distribution of solar energy received on an array tilted at latitude angle is shown in Figures 3.3 to 3.6. In order to determine the required size of a PV system, it is necessary to know the levels of solar irradiation and temperatures that can be expected throughout the year. This is specified in terms of the average daily insolation and average ambient temperature for each month.

It must be emphasised that all leading and reputable suppliers of PV systems have detailed data files on the solar resources throughout the world. Thus, it is only necessary to specify to a supplier where you wish to use the PV system. However, it is important that the location should be specified quite accurately as the solar resource can vary within some countries quite significantly between, for example, the coastal, inland or highland areas.

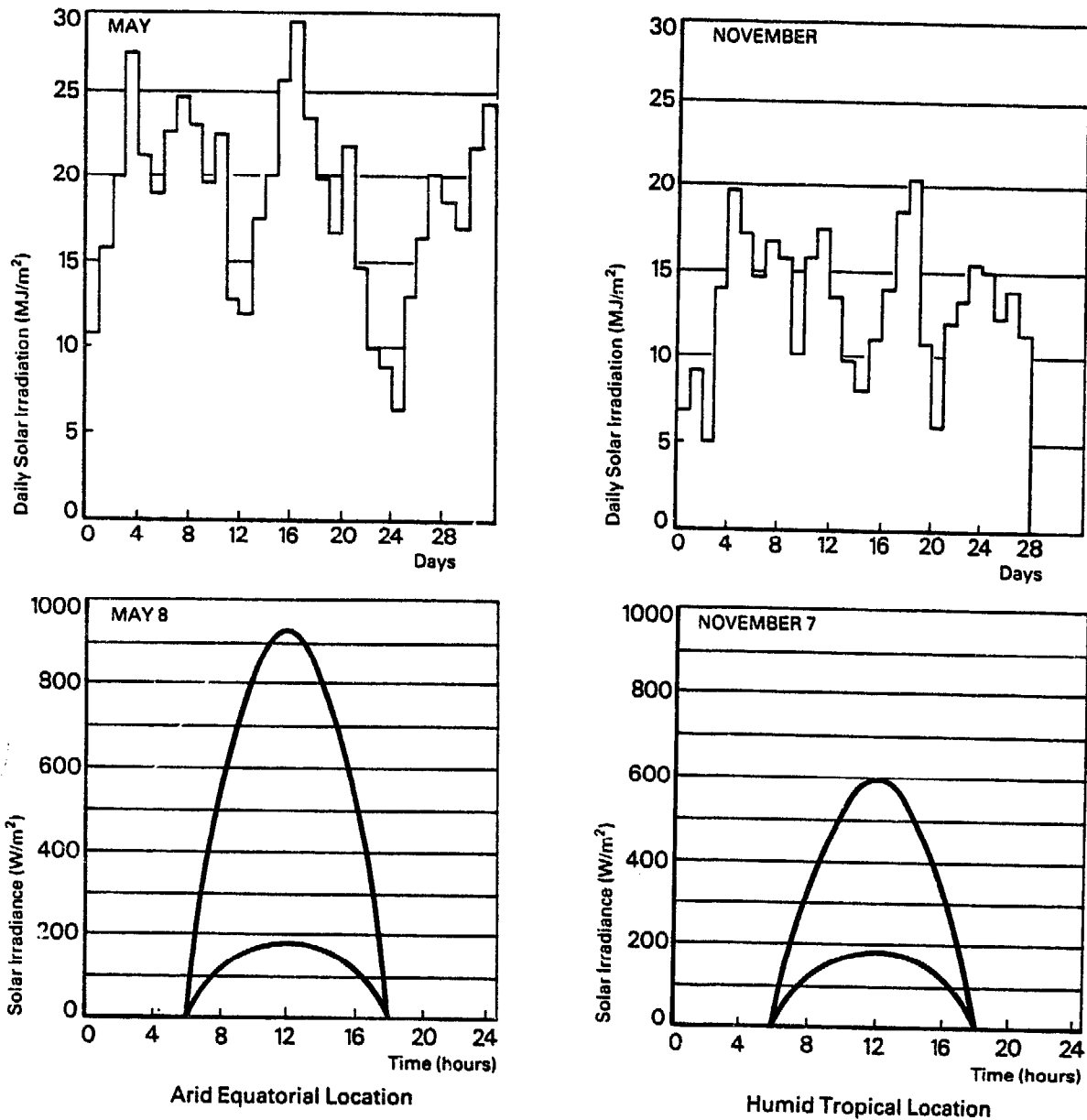

Figure 3.2 Typical Hourly and Daily Variations in Solar Energy Availability

Adapted from Sandia Report 87-0804.UC-63

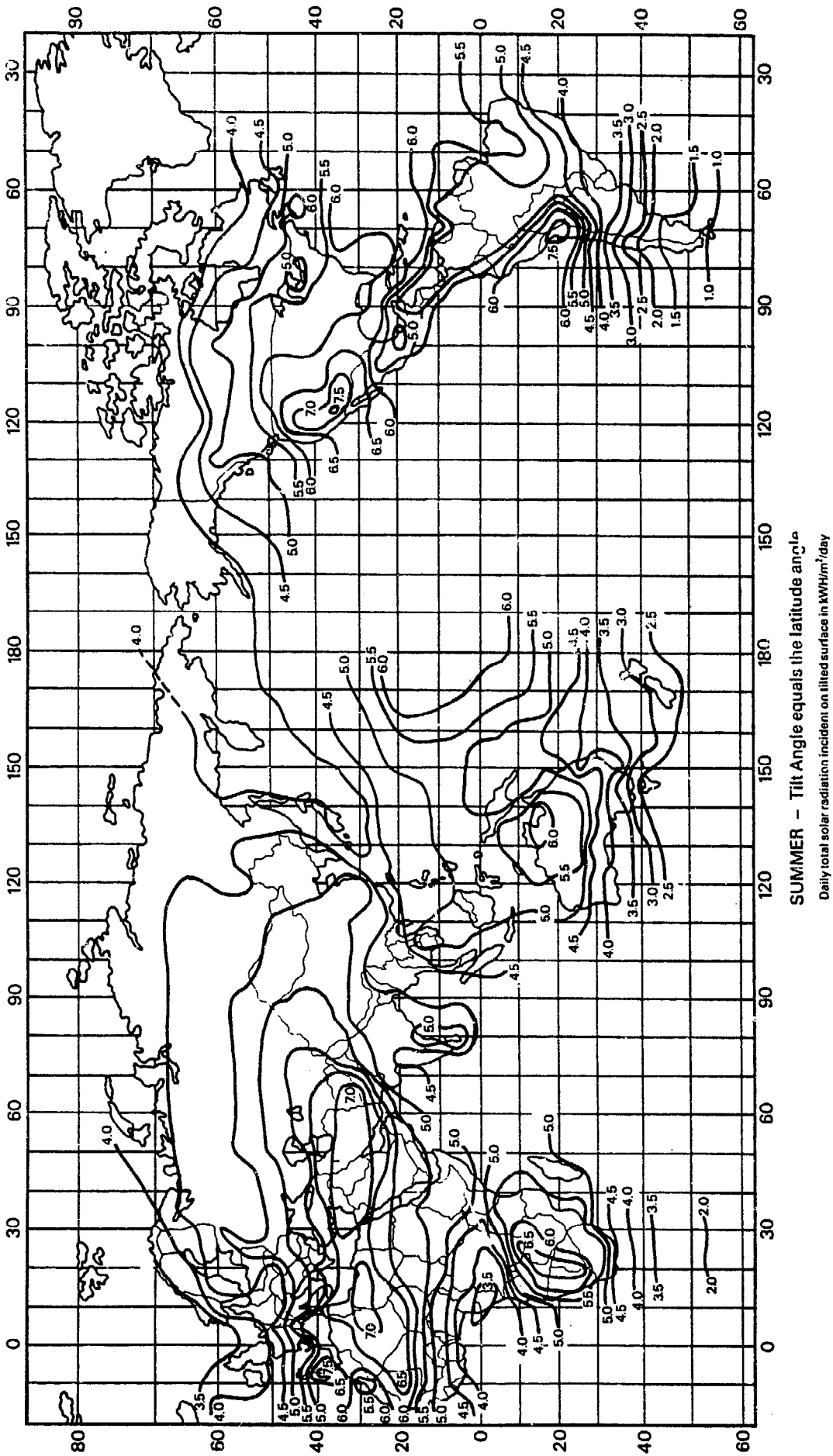
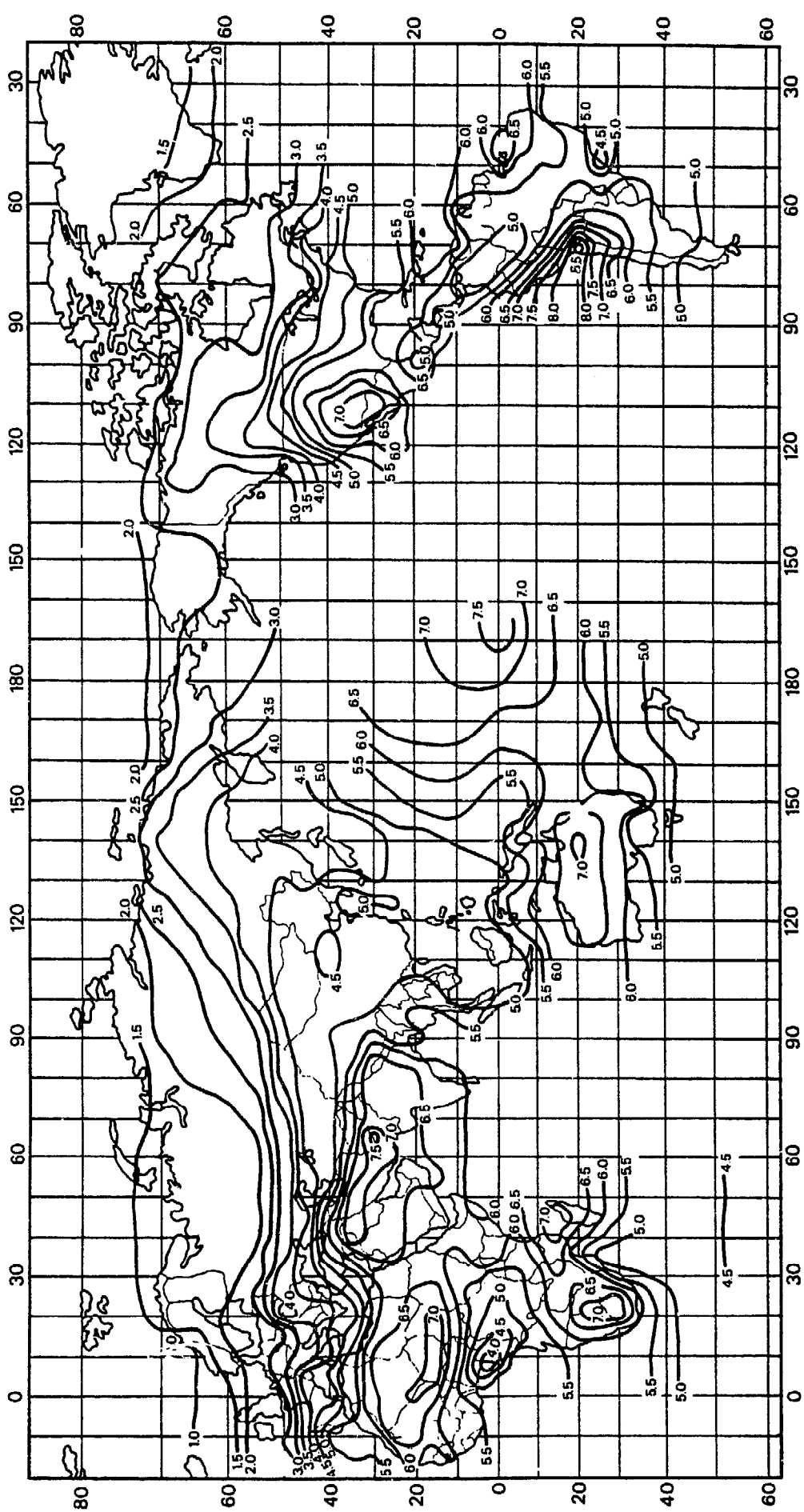

Figure 3.3 Solar Energy Distribution in Summer (June to August)

Adapted from Sandia Report 87-0804.UC-63



AUTUMN - Tilt Angle equals the latitude angle

Daily total solar radiation incident on tilted surface in kWh/m²/day

Figure 3.3 Solar Energy Distribution in Autumn (September to November)

adapted from Sandia Report 87-0804.UC-63

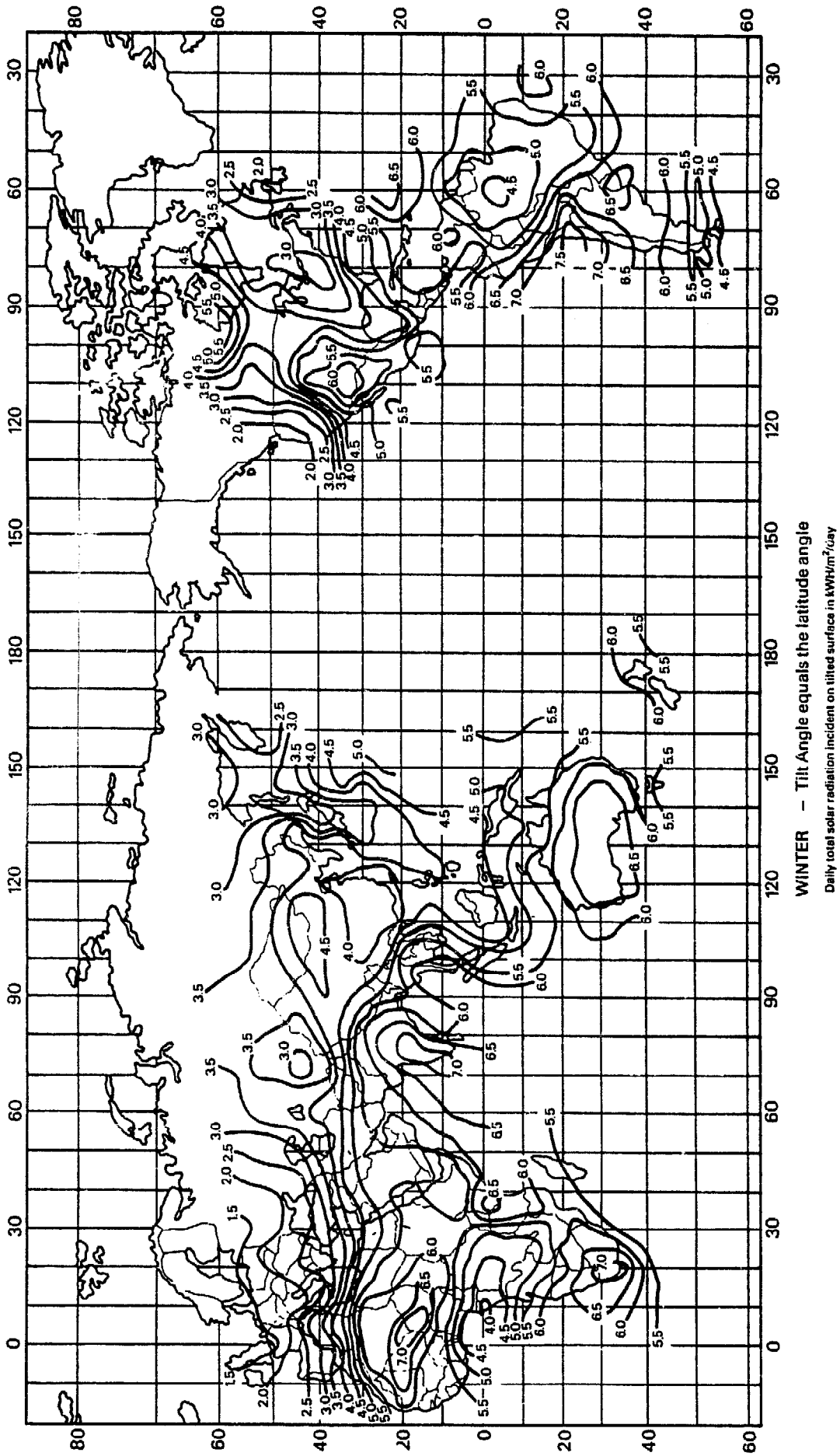
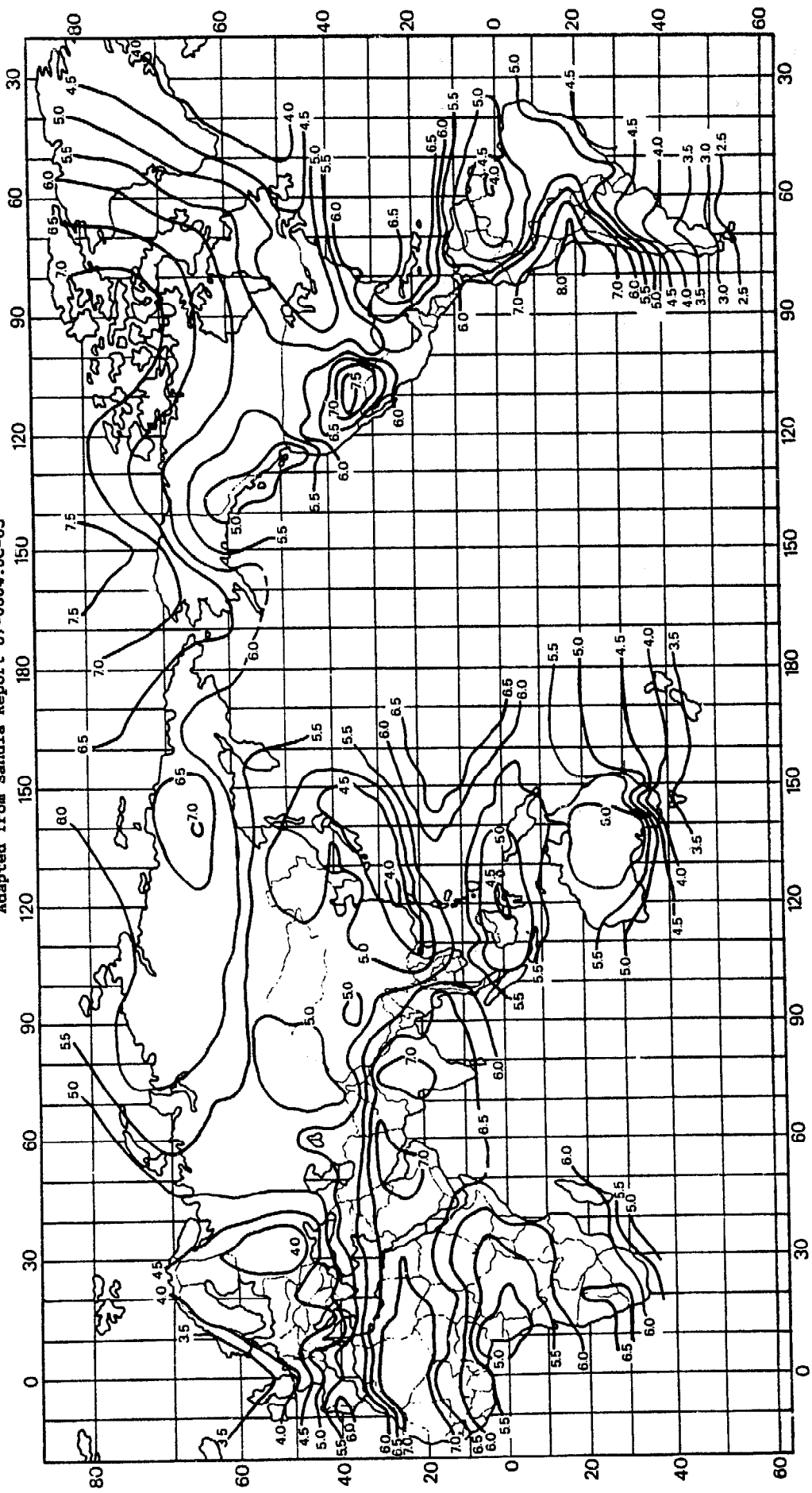

Figure 3.5 Solar Energy Distribution in Winter (December to February)

Adapted from Sandia Report 87-0804.UC-63



SPRING - Tilt: Angle equals the latitude angle
Daily total solar radiation incident on tilted surface in kWh/m²/day

Figure 3.6 Solar Energy Distribution in Spring (March to May)

3.2 SYSTEM SIZING

3.2.1 How Big a PV Solar Array do I Need?

Normally when you buy a PV system the supplier will determine the size and power of PV array you require using a computer based model. This is a service which should be taken advantage of.

You will be asked to supply information regarding the intended location of the equipment and user's needs, eg quantity of water or hours of light required per day. Satisfactory performance of the final system will depend on it being correctly sized at this stage. It is therefore important to provide as full and accurate details as possible regarding the proposed site and use of the required systems.

An appreciation of system sizing is valuable in order to check supplier's recommendations. It is also useful to obtain recommended sizes from several suppliers for comparison. Suggestion by any one supplier that the load can be met with a small PV array would indicate that their sizing assumptions may be too optimistic.

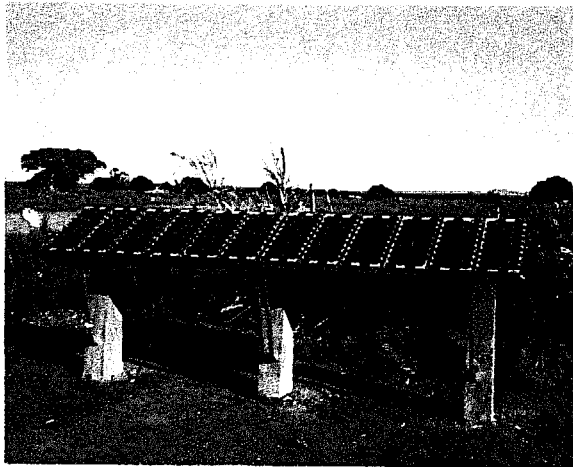

Figure 3.6 420 Wp Array for a PV Pump in Brazil (Heliodinamica)

A general nomogram for estimating the array size required for a given daily load energy demand is shown in Figure 3.7.

To use the nomogram:

- a) determine the average daily energy demand for the month being assessed and locate it on the axis OB
- b) trace a line horizontally from the point on OB to intercept with the line which corresponds to the average daily efficiency of your load equipment
- c) move from this point vertically upwards to intercept the average daily insolation in the month
- d) move from this point horizontally to intercept the line OA from which the approximate PV array size in watts peak is derived.
- e) repeat the procedure for each month. The array size required is the highest value derived from the twelve monthly assessments.

The nomogram can be used in the reverse mode to determine the monthly system output if the array size, insolation and sub-system efficiency are known.

Note also that the nomogram can be used for large or small values of daily energy demand by factoring by 10 on axis OB and then factoring the array size indicated also.

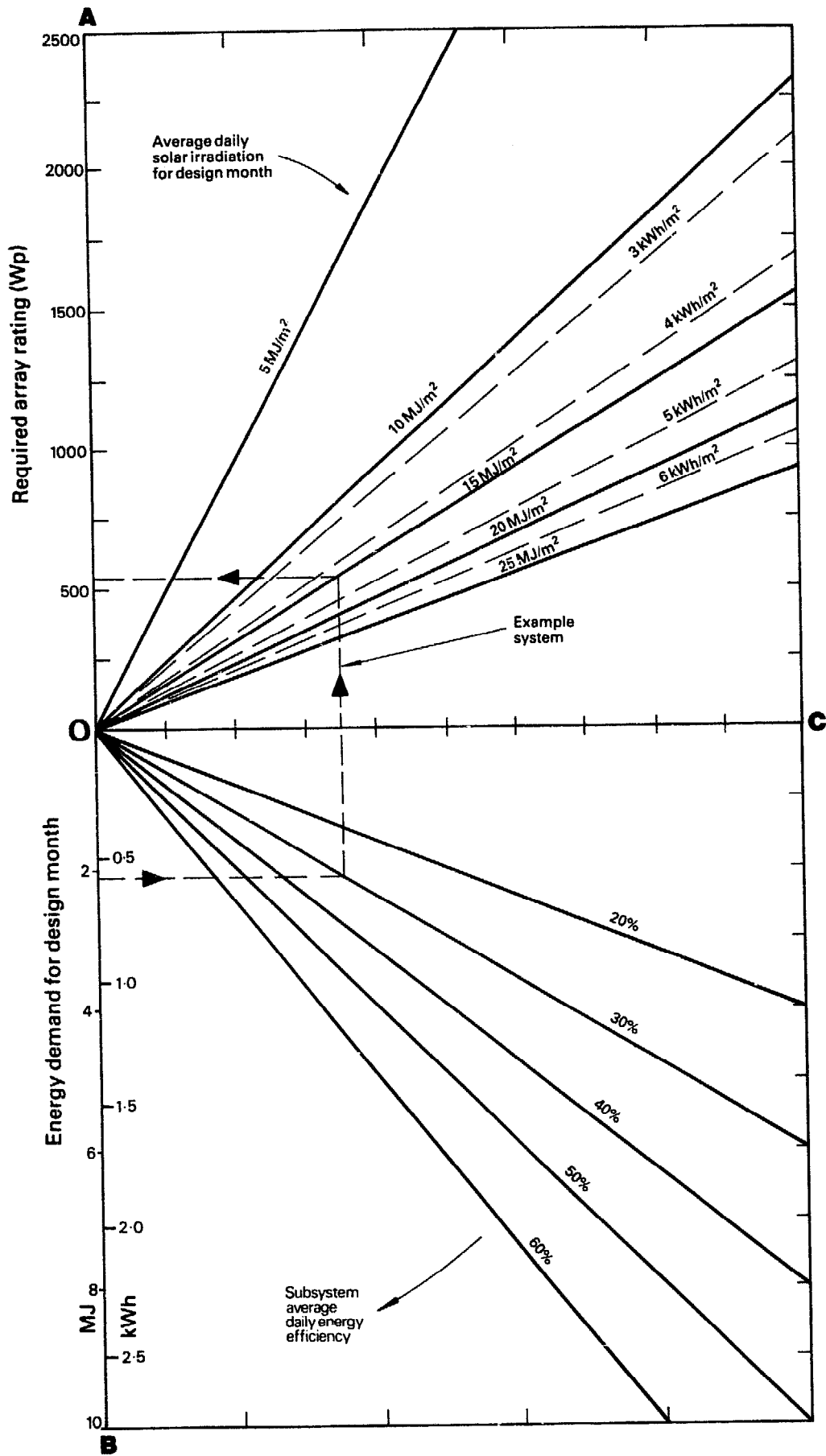

Figure 3.7 Nomogram for System Sizing

3.2.2 Assessing the End Use Requirements

In general, to size arrays it is necessary to determine the daily energy demand in kWh/day to fulfill the requirements of the user(s). This will have to take account of the power rating of the equipment to be used and estimated daily hours of operation. Where there are seasonal variations in demand the period with the highest ratio of energy demand to solar energy availability should be used.

<u>IF YOUR REQUIRE</u>	<u>YOU NEED TO KNOW</u>
A SOLAR PUMP	<ul style="list-style-type: none">● WATER SOURCE TYPE (well, river, canal, borehole)● WELL/BOREHOLE CHARACTERISTICS (diameter, yield)● HEAD (total static lift in metres)● WATER DEMAND (month by month average daily demand and peak requirements).● WATER STORAGE AND DISTRIBUTION SYSTEM
A SOLAR REFRIGERATOR	<ul style="list-style-type: none">● INTERNAL VOLUME REQUIRED● MAXIMUM AMOUNT OF ICE OR GOODS TO BE FROZEN PER DAY● THE NORMAL AMBIENT TEMPERATURE
LIGHT (S)	<ul style="list-style-type: none">● NUMBER OF LIGHTS REQUIRED● WATTAGE OF EACH LIGHT● AVERAGE HOURLY USAGE OF EACH LAMP
TELECOMMUNICATIONS	<ul style="list-style-type: none">● CONTINUOUS STANDBY POWER FOR THE EQUIPMENT.● TRANSMITTING/RECEIVING POWER● NUMBER OF HOURS OF TRANSMITTING/RECEIVING.

Table 3.1 Load Parameters Needed to Determine System Size

A summary of the load parameters to be specified when ordering PV systems is given in Table 3.1. The appropriate application chapters have more detailed information on assessing the load requirements for each application.

3.3 PROCUREMENT

3.3.1 Where to Obtain Photovoltaic Systems - (see Appendix II)

Solar photovoltaic systems are commercially available from many companies throughout the world. There are some indigenous companies manufacturing or assembling PV systems in Brazil, China, India, Indonesia, Senegal, Thailand, Vietnam and Zimbabwe though the majority are based in Europe, USA, Japan and Australia. Many of the latter group have agents and representatives in the Developing World.. A summary of the areas of particular experience for some leading companies is given in Table 3.2.

3.3.2 Selecting Equipment

Equipment should be selected on the basis of technical viability, cost, experience of the manufacturer and supplier and ease of implementation.

Technical viability - the system should have the capability to perform the required function in the specified location. Field experience has shown the actual load (ie, kilowatt-hours consumed) is often greater than anticipated. A safety margin of 20% should be added to allow for this. Ensure it is clear exactly which components are included in the system, and which necessary components are not included and hence are assumed to be readily available locally (eg, pipework in a solar pumping system). Check these components are available locally.

Simplicity of the system is often a major factor in obtaining reliable and effective performance in the field. This is particularly so in rural areas of developing countries.

A cost comparison of all systems which fulfill the technical requirements should be made taking account of initial purchase, transport to site, installation, operation and maintenance of the system.

The experience of the manufacturer and supplier should be considered. Much information can be gained by an examination of other units already operating in a similar situation.

Practical considerations of procurement, transportation and installation should be made. Determine if after sales service is available locally for spares supply and repair. Enquire if training courses in the operation and maintenance of the equipment are available.



Figure 3.8 Delivering a PV System to a Health Clinic in Zaire

Company	Country	Modules	Pumping	Refrigeration	Battery Charging and Lighting	Village Telecoms	Water Treatment and Desalination	Other CT = Commercial Telecomms (CP = Cathodic Protection)
BP Solar	UK, Australia	• •	• •	• •	• •	• •	• •	Nav-Aids, CP, CT
BHEL	Spain, Thailand	•						
CEL	India	•	•			•		
Chloride Solar	UK			•		•		
Chronar	UK, France	• •	•		• •			
Dinh Co	USA		•					Nav-Aids, CT
Dulas Eng.	UK			•				
FNMA	Zaire			• •	• •			
Grundfos	Denmark		• •					
Hellodinamica	Brazil	• •	• •	• •	•	•		
Hiltec	UK							Educational Kits
Hitachi	Japan	•					•	CT, Fans
Hoxan	Japan	• •				•		
Hydrasol	USA		• •			•		Nav-Aids, CP, Fans, CT
Intersolar/Solarpak	UK		•	•		•	•	
IPC	USA							Mobile Power, Towable Arrays CT, Home Power Kits CT, Nav-Aids
Isototon	Spain	•					•	
Italsolar	Italy	•		• •		•		
K.S.B.	Germany		• •					
Kyocera	Japan	• •	• •	•	•		•	
MBB	Germany	•						Tunnel Lighting, TV Fencing
McDonald A.Y. CO	USA		• •					
Mitsubishi Elec.	Japan	•				•		
Mobes	Germany							
Mono Pumps	UK, Australia		• •					
Neste	Finland/Sweden		•	• •	• •	• •	•	Nav-Aids, CT
Noack Solar	Norway			• •		•		Air cooler
Photocomm	USA							
Photowatt	France	•	•			•		
Polar Products	USA			• •		•		
Portsol	Portugal							Home Power Kits, Fencing Nav-Aids, Home Power Kits Home Power Kits
R&S	Netherlands	•	•	•	• •	•		
Rade Koncar	Yugoslavia	•						
S.E. I.	Italy							
S.E. T.	Germany		•	• •		•		
Siemens	Germany	•		•		•		TV, Nav-Aids, CT Nav-Aids, CT Home Power Kits
Solarex	USA/Australia	• •	• •	• •	• •	• •	•	
Solarwatt	Australia		•			•		
Solems	France	•						
Soltech	Belgium	•	•					
Sovonics	USA	•						Home Power Kits
Sun Frost	USA			• •				
Suryovonics	India	•	•	•		•		Home Power Kits
Suntron	Australia		• •					
Telefunken	Germany	• •	• •	• •	• •	• •	•	
Total Energie	France		• •	• •	•	•		
Transcoast	Belgium						•	

Table 3.2 Principal Suppliers of Photovoltaic Systems

3.3.3 Tender Procedure and Evaluation

Here are some things you should think of during the tender procedure.

- **Assess the viability of using PV with regard to technical, social, institutional, cost and practical considerations.** If PV appears to be sensible then:
- **Prepare site details** including location, factors which may affect installation and if available, local meteorological data.
- **Prepare details of load requirements** for each month. These should be expressed as monthly average daily values with any specific peak demands noted.
- **Prepare a tender document** to send to potential suppliers. Allow adequate time for suppliers to respond (4 weeks typically).
- **Undertake preliminary assessment** of tenders for
 - completeness of tender including spares, tools, manuals
 - delivery period
 - warranty
- **Undertake a detailed assessment** for
 - compliance with the specification and estimate of the safety margin in the array size over the worst case daily load
 - the extent and credibility of the information supplied
 - suppliers credibility and availability of back-up services
 - cost competitiveness
- **Select the preferred supplier** and ensure you have answers to all queries on the equipment before ordering.



Figure 3.9 Carrying a PV Array onto a Roof



Figure 3.10 Installing a Roof Mounted Array

3.4 SAFETY

Although photovoltaics modules and systems are no more dangerous than any other small-scale power source, users must always take the following precautions:

Solar Array

Photovoltaic modules have a glass cover; always carry and transport them carefully.

There is a risk of receiving an electric shock from a solar array. Although most modules have output voltages of less than 20 volts, if several modules are connected together such that the voltage is greater an electric shock risk is present.

Always take the following precautions when undertaking servicing or repair work on PV systems:

- cover the solar array with a sheet or cloth
- disconnect the array from the load
- use insulated tools.

Solar arrays may need regular cleaning. With roof mounted arrays there is a risk of falling off a roof or ladder.

- make sure that the user has easy and safe access to clean the array.
- always use good ladders and position them firmly.
- use crawling boards when walking on roofs.

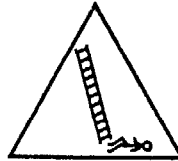
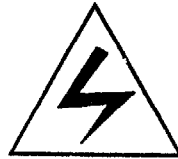

Batteries

Batteries contain acid which can cause acid burns on skin or blindness if in contact with the eye. The acid will also damage clothes.

- avoid spilling or splashing battery acid especially in transport.
- always keep the batteries upright.
- carry batteries carefully (do not carry them on your head).
- always use a funnel or plastic bottle with a spout to add distilled water.
- do not let children near batteries and keep batteries in locked, ventilated containers.

Batteries also give off gases which are explosive

- make sure that the battery containers provided are well ventilated and that they are placed in a well ventilated room.
- keep naked flames and lighted cigarettes well away from batteries.
- use insulated tools to prevent sparks.

4. BATTERIES AND BATTERY CHARGING SYSTEMS

4.1 BATTERIES

4.1.1 The Case for Batteries

The amount of electricity produced by a photovoltaic array will vary throughout the day and be zero at night. Some applications need an electric supply at times when no electricity is being produced by the module, for example night lighting. In these instances, batteries are used to store the electricity for use at a later time.

For some applications, batteries are not important. For example, if water is being pumped into a storage tank it is not critical when it happens only that sufficient water is pumped to meet the day's demand. Batteries are thus not needed in this type of system.

In other cases the supply of electricity needs to be constantly available, for example, for refrigerator or tele-communications loads.

In many countries, particularly in Asia, batteries are routinely used in rural areas to power lights, fans and radios. PV systems may be used to recharge these systems which otherwise have to be undertaken by transporting the batteries to urban areas.

Battery charging is a source of employment and economic activity in many rural areas and is being promoted as a source of income for health centres, for example.

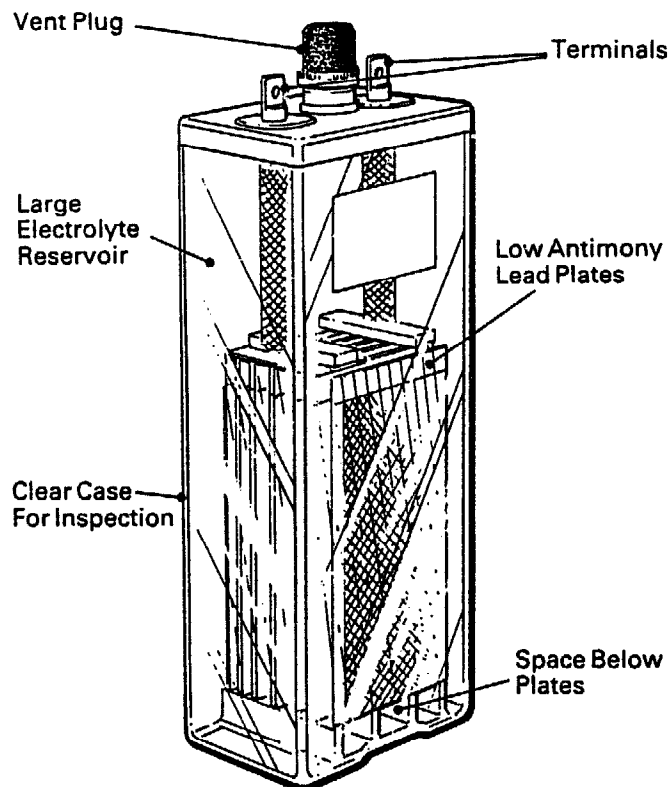

Figure 4.1 Desirable Features of a Battery for Photovoltaic Use

4.1.2 Batteries for Photovoltaic Systems

Batteries come in all shapes and sizes, each designed to suit a particular use. The characteristics of most importance for use with PV are: ability to be repeatedly charged and discharged without damage, the storage capacity of the battery, the ability to hold charge when not in use, a need to be charged and discharged with minimum loss of electrical energy and a requirement to operate for long periods with little or no maintenance.

These characteristics, (described in terms used by manufacturers), are discussed below. Actual data should be requested from the suppliers.

- **Cycle Life** - is the number of times a battery can be discharged and recharged. This is happening continuously in a PV system so it is essential that the battery has a high cycle life. Some types of batteries are designed with a longer cycle life than others.

The cycle life for any particular type of battery will depend on the extent to which it is discharged. If only a small amount of power is taken from the battery before recharging, the cycle life will be much longer (see Figure 4.2).

- **Rated Storage Capacity** - a battery's size is expressed by the amount of charge it can hold and is measured in terms of Ampere-hours (Ah). A battery of 100 Ah used to run a light which consumes a 2A current will operate for 50 hours.

The actual, or available, storage capacity can be significantly less than rated and depends on battery type, manufacture and operating conditions.

- **Depth of Discharge (DOD)** - is the extent to which a battery should be allowed to discharge in normal operation. Beyond the maximum permissible DOD permanent damage will be caused to the battery.

DOD is expressed as a percentage of the rated battery capacity, and typically varies from 50 to 100% depending upon type of battery. Those with a high DOD are called deep-cycle batteries and are most suitable for use with PV systems.

For any type of battery, the DOD is affected by operating temperature. In low ambient temperatures, the allowable DOD will be significantly reduced.

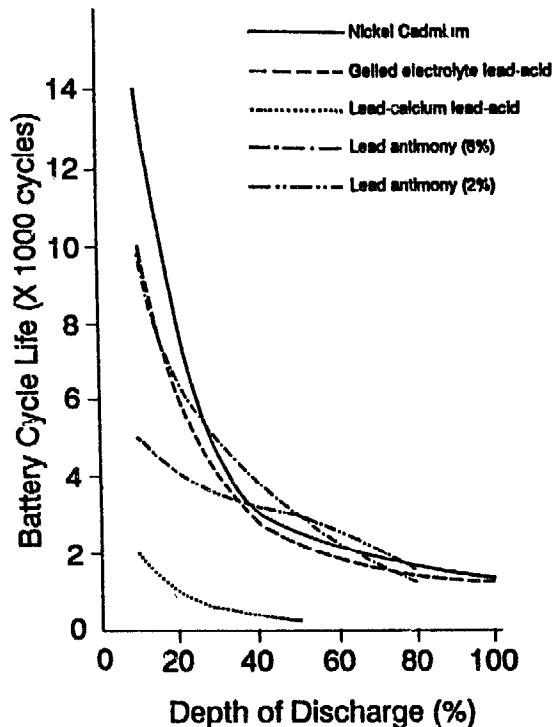

Figure 4.2 Variation in Battery Cycle Life with Depth of Discharge

- **Self-Discharge Rate** - if left unused, all batteries will slowly lose their charge but some types self-discharge faster than others, as shown in Figure 4.3. A loss of 0.1 to 0.3% of capacity per day is typical. This can be greater at high ambient temperatures.

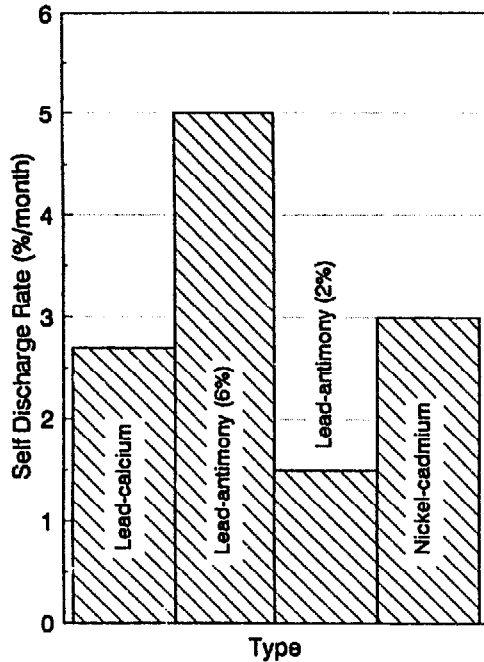

Figure 4.3 Self Discharge Rate by Battery Type

- **Charge Rate** - charging a battery with a high current causes excessive heat to build up and can cause damage. Normally a battery can be safely charged with a current equal to one tenth of its amp hour capacity or less. The lower the charge current, the greater the efficiency of recharging.

- **Temperature** - a battery's capacity is usually quoted at 25°C. Above this the available capacity will be greater but beyond 40°C the capacity will decrease again. Temperature below 25°C will also increasingly reduce battery capacity to 75-90% of rated capacity. At 0°C freezing of electrolyte particularly in lead-acid batteries can cause permanent damage. Temperature also affects battery cycle life. Continuous operation above 25°C will cause a significant reduction in life.

- **Maintenance** - the battery is often the component of a PV system with highest maintenance requirements. If sited at remote locations or without frequent maintenance services, a low maintenance battery should be chosen. Maintenance requirements vary with the battery type and operating conditions.

- **Discharge Rate** is the period of time in which a battery is designed to deliver its full storage capacity. A 100Ah battery with a discharge rate of 50 hours is designed to deliver a current of 2A. The available storage capacity of a battery will be greater if it is discharged over a longer period or less if the discharge rate is increased.

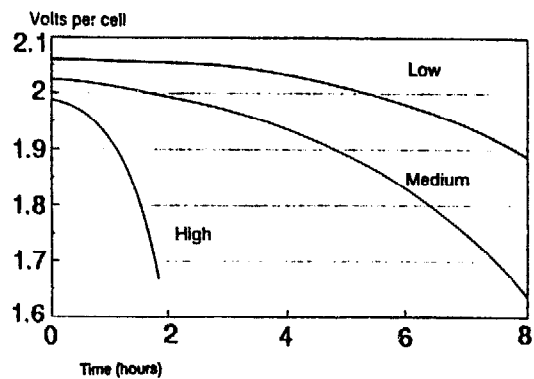

Figure 4.4 Effect of Discharge Rate on Battery Voltage

4.1.3 Commercially Available Batteries

Two principal battery types are used with PV systems. These are lead acid batteries and nickel-cadmium batteries.

LEAD ACID BATTERIES can be further divided into:

Lead Calcium - they are most commonly used for automotive applications. Calcium is added to the lead plates to increase their strength. The result is a battery able to deliver a high current, but with a poor cycle life. Self-discharge rate and water loss is low.

Lead Antimony - these have a small amount of antimony in the lead plates to improve the deep cycle characteristics. They can tolerate repeated discharging to 50-80% of rated capacity. The presence of antimony in the battery increases both its rate of water loss and self-discharge rate. The extent of these effects are proportional to the amount of antimony used. High water loss can be counteracted by a large electrolyte reserve. These batteries are commonly used as traction batteries for electric vehicles.

Lead-alloy with gelled electrolyte - have been developed to provide a sealed, spill-proof battery. The internal design minimises gassing and eliminates water loss. They require no topping up and hence maintenance requirements are minimal. Cycle life is variable depending on the design. Certain types have no antimony in the plate alloy in which case, cycle life can be poor.

Those with a medium to long cycle life are suited to use in PV systems, however, their cost is high and will limit their widespread use. Similarly, the number of manufacturers producing this type of battery is very small.

Sealed Batteries - both lead antimony and lead calcium are available in sealed casings. They require no topping up throughout their life so maintenance requirements are low. This is achieved by a large electrolyte reserve and a catalytic recombination plug which reabsorbs the gasses back into the battery as water.

NICKEL CADMIUM BATTERIES have very different characteristics. They are not liable to sudden failure because plates are not "used up" in chemical reactions. They can be fully discharged without damage and they have a high tolerance to being overcharged. Nickel cadmium batteries can operate for long periods without replenishment of electrolyte and they have a long cycle life, if shallow discharged.

This gives nickel cadmium (ni-cd) batteries advantages for use with PV systems because the depth of discharge is maximised. A battery with a smaller rated capacity than that necessary with a lead-acid type may be chosen whereby easing storage and transportation requirements. They can operate successfully without sophisticated voltage regulation units.

However, nickel cadmium batteries have not been as widely used in PV systems as lead acid types because of higher initial cost and poor availability in developing countries. When greater depth-of-discharge and longer life expectancy are taken into account, their life cycle costs are however often comparable with lead-acid batteries.

PLATE TYPE	LEAD CALCIUM	LEAD-CALCIUM ANTIMONY (6%)	LEAD-CALCIUM ANTIMONY (<2%)	NICKEL CADMIUM
ELECTROLYTE	Liquid	Liquid	Liquid	Liquid
TYPICAL DOD	50%	80%	80%	100%
DESIGN USE	Automotive	Traction	Emergency Power supplies and PV	Low Maintenance Needs, PV
SELF-DISCH RATE	Low	Medium	Low	Low
CYCLE LIFE	Low	Medium-Long	Long	Long
SEAL	Vented	Vented	Vented	Vented
TOPPING-UP REQUIRED	Infrequent	Frequently	Infrequently	Minimal
CAPITAL COST	Low	Mid-range	Mid-range	Very High
SUITABILITY TO PV USE	Not Recommended	Recommended	Highly Recommended	Highly

Table 4.1 Comparison of Battery Types Commonly Used with PV Systems

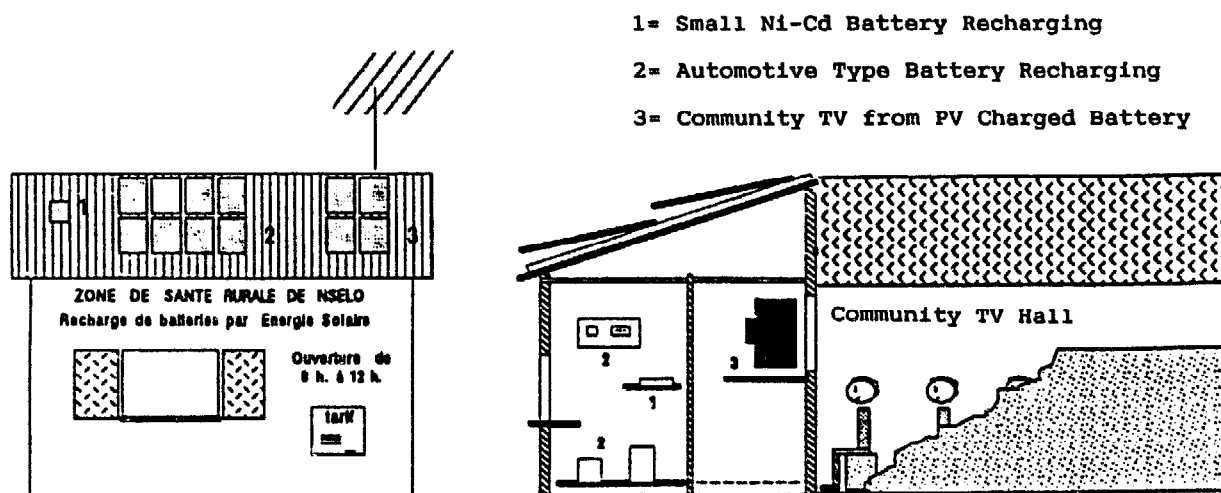

Figure 4.5 Commercial Battery Charging in Zaire

4.1.4 Battery Sizing

A storage battery is the balancing factor between the pattern of energy production from the array and the pattern of energy used by the consumer. If too small, the battery will be completely discharged at times and overcharged at others. (A lead acid battery will suffer permanent damage if used in this way.)

Determining the correct size of battery to use can be complex due to the range of factors which should be considered. The two methods commonly used are by deciding either:

- the number of days or hours of autonomous operation required, ie the length of time the energy stored in the battery will operate the load when no power is produced by the array.
- the required availability of the power supply (expressed as a percentage of time when there is low probability of a power failure). For high value loads, such as vaccine refrigerators or commercial telecommunication equipment, very high availability is required. For non-essential services such as lighting or household electrification, a lower availability can be tolerated. Lower availability will result in a smaller array and battery size along with lower cost. Typical battery sizes for equatorial regions have 3-5 days storage capacity for low status loads and 5 to 10 days where high reliability is required.

Lead acid batteries are made up of 2 volt cells connected in series to create 6, 12 or 24 volt units. Ni-Cd batteries contain 1.2 volt cells connected together. They may be connected in series or parallel configurations to achieve the required operating voltage and current conditions. Figure 4.6 illustrates typical wiring configurations.

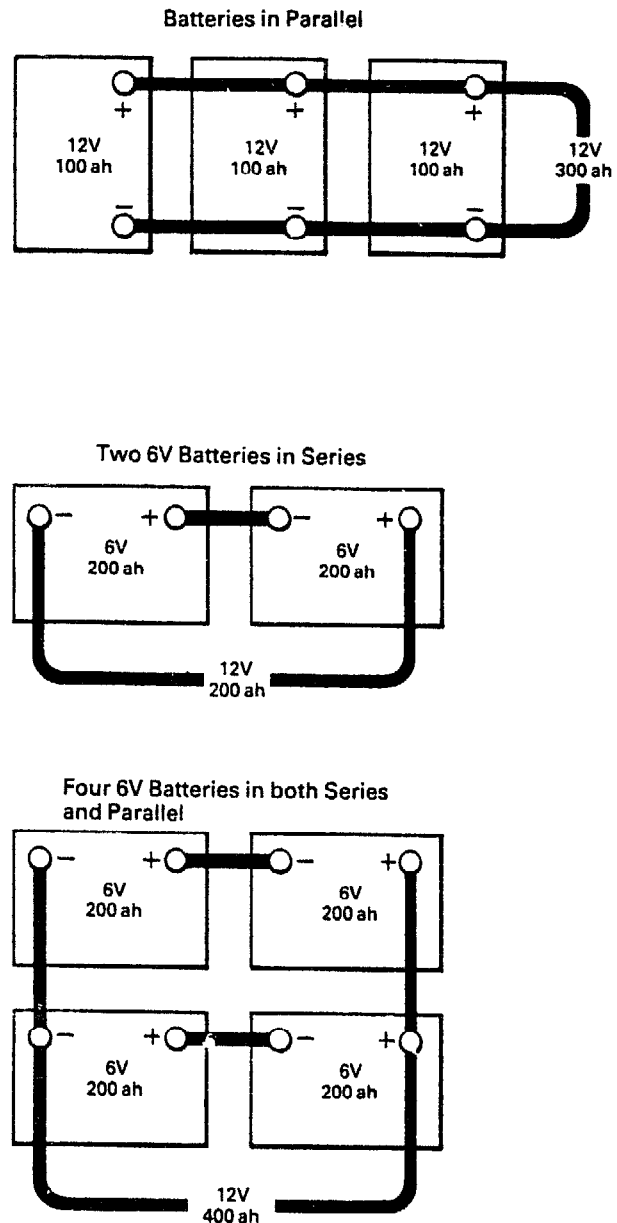

Figure 4.6 Wiring of Batteries

4.2 POWER CONTROL UNITS (PCU)

As already said, the power produced by a PV array is continually varying. Most electrical equipment will only tolerate small variations in the voltage and frequency of the electrical supply. Power control units essentially manage and refine the system to enable smooth and efficient operation.

The principal functions of a PCU will depend on the type of system. Commonly used PCUs are:

Charge Regulators - are required for battery charging systems, particularly those using lead acid batteries. Their main purpose is to prevent damage to the battery by over charging or discharging. Initially the regulator will allow all the power from the PV array to be used to charge the batteries. As the battery voltage approaches a fully charged level the charge from the array will be cut to a float or 'top-up' charge level. This is just sufficient to maintain full charge, but will prevent gassing and subsequent loss of water. If a battery is near the fully discharged voltage the regulator will cut the supply to the equipment - or warning lights are illuminated to indicate the low state of charge of the battery.

These regulators operate on the voltage level of the battery. However, the available capacity of a battery depends on its operating temperature. In low temperatures, the battery voltage can be relatively high yet the available charge will be substantially reduced. Similarly, battery voltage can be temporarily reduced if a large current is being drawn to power equipment.

Good quality charge regulators will therefore include temperature and current "compensation" features. It should be noted that the better the quality of regulator, the longer the batteries are likely to last.

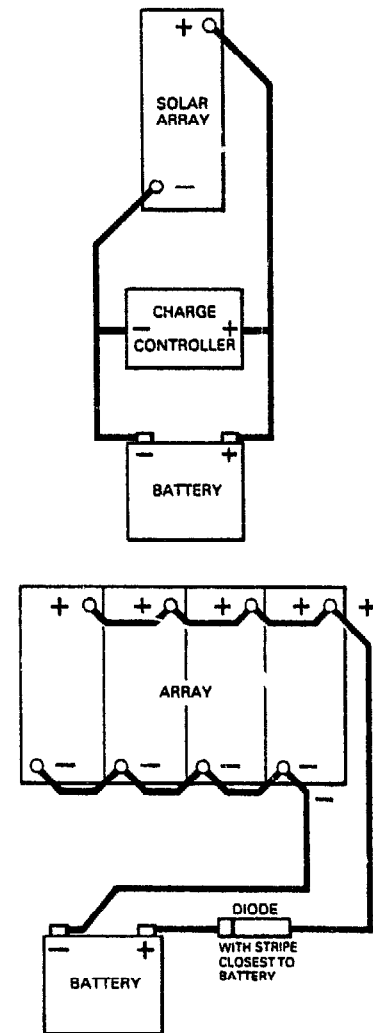

Figure 4.7 Charge Regulator and Blocking Diode Positions

Blocking Diodes - are used in battery charging systems. They are connected in line between the array and the battery to prevent discharge of the battery through the array. This would otherwise occur when the battery voltage is greater than that produced by the array (such as night).

Inverters - are necessary only when a.c. electrical appliances - eg, normal domestic appliances and some pump types. They convert the direct current (d.c.) electricity produced by the array, or stored in the battery, into alternating (a.c.) current. Inverters are expensive and introduce power losses, so where possible the use of d.c. appliances is preferred, eg, d.c. lights, fan units, etc.

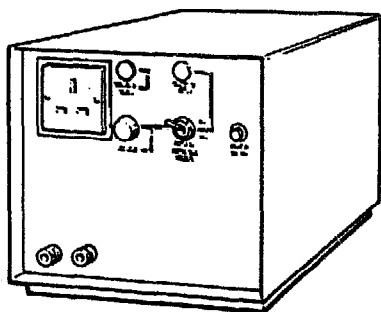

Figure 4.8 Typical 400 W Inverter

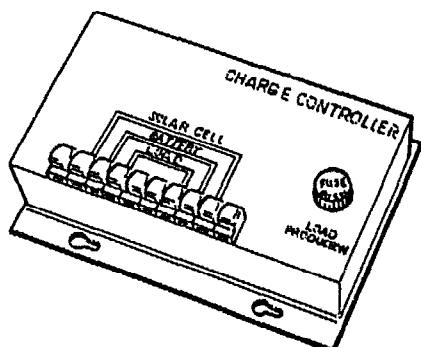

Figure 4.9 A Charge Controller

System Indicators - display how the system is functioning. This may be a light to show power is being produced in the array, or state of charge of the batteries. It may include a voltmeter to show battery voltage and an ammeter to indicate the array output.

Junction Box - the control unit can provide a useful point to join cables at installation of the system. A terminal block is usually provided.

Maximum Power Point Trackers - are quite sophisticated controllers used to maximize the amount of power produced by the array by optimising the impedance match between the array and the load. They usually employ a micro-processor which looks at the array power output (typically every 30 milliseconds) and steps up the array output voltage by means of impedance adjustment. If the power output has increased since the last sample, the array voltage is increased again. If the array power has decreased, the controller will decrease the voltage. Hence the controller hunts for a point of maximum power output.

MPPT'S are sometimes used in PV pumping systems. The controller itself consumes power and has an associated cost so only in a few systems are they cost-effective. In general, power control units should be used with discretion. Sophisticated electronic controllers can be self-defeating if their unreliability disrupts the system to the extent of outweighing the benefits of improved efficiency. This is particularly relevant in areas where regular maintenance or electronic repair services are not readily available.

The choice of PCU will usually be dictated by the system supplier. Whilst their advice should not be ignored, the information given in this chapter should enable a qualitative evaluation of the types available and their appropriateness for the intended application.

4.3 BATTERY CHARGING SYSTEMS

In many remote locations or countries where the extent of grid electricity supply is very limited, batteries are used as a source of power. PV systems are now being increasingly considered as a means of recharging batteries, either at battery charging stations or in dedicated systems. In Zaire the income from PV battery charging stations is used to maintain health centres.

The conventional methods of battery charging in rural areas are periodically transporting the batteries to a mains supply or by using diesel or gasoline generators.

The use of PV for battery charging has the advantage that local charging points can be established remote from the grid network, there are no inherent fuel costs or fuel supply problems, and unattended operation of equipment at remote sites is possible.

It can be considered suitable in areas of medium to high levels of insolation (above about 3.0 kWh/m²/day). When assessing economic viability of PV battery charging compared to its alternatives, associated operational and maintenance factors should be considered as well as capital cost and relative output. These will vary considerably for each site and application.

When comparing systems from alternative suppliers, it is necessary to look at array size, battery size and type, charge rate specified for a given level of insolation and which components are supplied with the system. Some suppliers include batteries in their systems, others leave this for local purchase.

The inclusion of a power control unit will depend on supplier and type of battery used. Reliability is an important factor as electronic controls have proved the least reliable part of many PV systems. For unattended operation, particularly with lead acid batteries, a control unit with voltage regulation is essential. Simple units from suppliers with proven experience and reliable back-up services are the safest choice.

Typical system costs range from US\$10-20 per Wp of array rating.

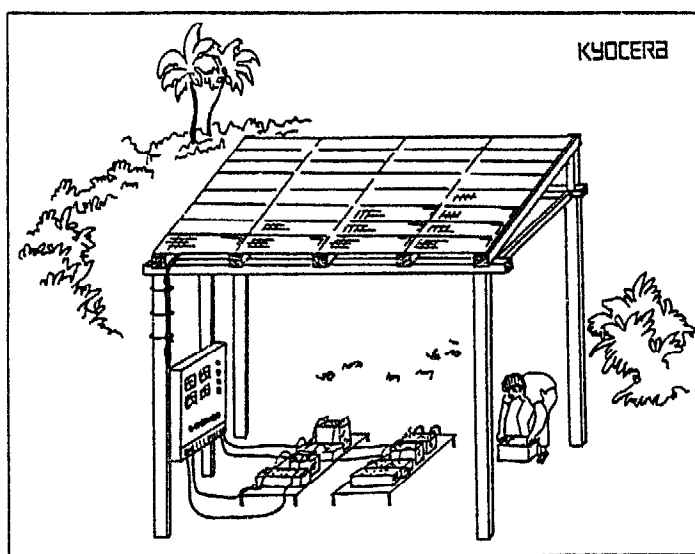

Figure 4.10 A 1400 Wp Battery Charging Station

4.4 IMPLEMENTATION CONSIDERATIONS

4.4.1 Procurement

You will need to specify to the supplier:

- the site location (country, nearest town, latitude and longitude)
- your month by month daily charge required in Ampere hours
- full details of the load on the battery
- the type of batteries you intend to charge
- which type of batteries you prefer to buy with the PV battery charger and your preference for either high quality (and high cost), long life batteries and controllers or for lower cost equipment which will require more frequent maintenance and replacement.

4.4.2 Transportation

If batteries are being transported over long distances and/or kept in storage before use, this should be done in a "dry" condition (without electrolyte). It is then important to ensure the supplier provides both acid and distilled water to fill the batteries prior to use.

4.4.3 Siting

Batteries should be sited in a dry, well-ventilated position. This should not be in a living area. They should be protected from unwanted interference especially from children and animals. Always keep them upright.

4.4.4 Maintenance

Regular checks are necessary to ensure that:

- the electrolyte level is sufficient to cover the internal plates
- batteries are clean and dry to prevent losses from the terminals
- there is no build up of corrosion around the terminals
- casing is sound without cracks or leakage

The amount of charge in each cell of a battery can be checked by measuring the specific gravity of the electrolyte with a hydrometer (see Figure 4.12). It is important that the battery cell is kept at a good state of charge. Any discrepancy can be rectified by boost charging the battery - ie, maintaining a high charge rate until full charge level is reached in all cells.

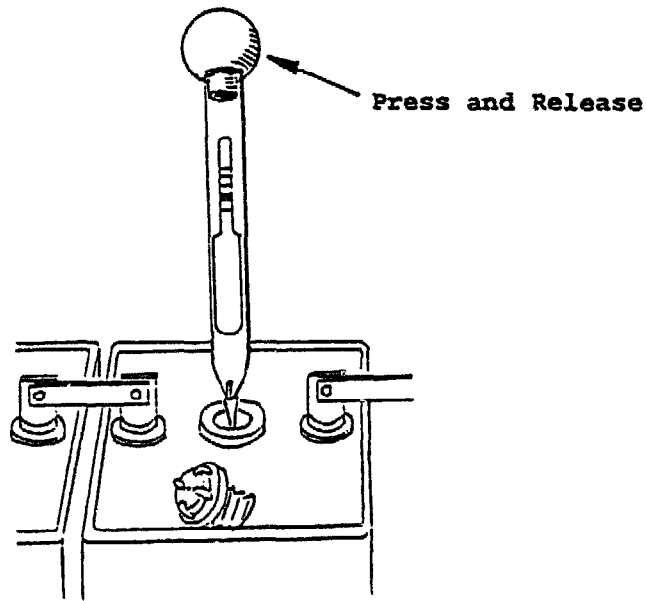

Specific Gravity at 15°C

Temperature Correction from 15°C

State of Charge %	Specific Gravity	Electrolyte Temperature °C	Correction to Specific Gravity
100	1.225	55	+0.028
90	1.216	50	+0.024
80	1.207	45	+0.021
70	1.198	40	+0.017
60	1.189	35	+0.014
50	1.180	30	+0.010
40	1.171	25	+0.007
30	1.162	20	+0.003
20	1.153	15	0.000
10	1.144	10	-0.003
0	1.135	5	-0.007

STATE OF CHARGE VS SPECIFIC GRAVITY TABLE

Figure 4.11 Checking the Battery State of Charge

Product: BATTERY CHARGING SYSTEM

Includes: Self regulating module, support structure, wiring and connectors

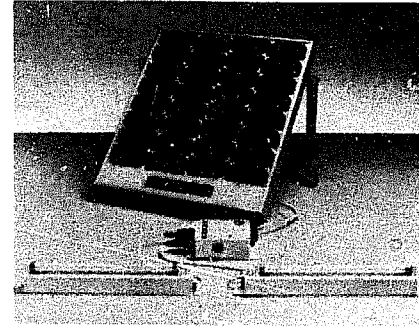

MODEL NO.	ARRAY Wp	OUTPUT Wh/day	PRICE U.S. \$
BP 320 CH	20	90 @ 5 kWh/m ² /d	425

Company: CURRIN CORPORATION

PO Box 1192, Midland MI 48641, USA

Product: BATTERY CHARGING KIT AND POWER SUPPLY

Includes: PV module, charge controller, discharge controller, warning light circuit breaker, connectors and manual.

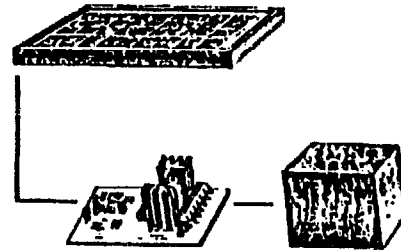

MODEL NO.	ARRAY Wp	OUTPUT Wh/day	PRICE U.S. \$
SPC 15	5	15	180
SPC 60	18	60	370
SPC 120	36	120	630
SPC 180	60	180	860

Company: KYOCERA Chiba Sakura, Ohsaku, Chome Sakura - shi, Chiba-Pref, 285, Japan

Product: BATTERY CHARGING STATION

Includes: PV array & support structure, charge controller and multiple battery charging facility for 6, 12, or 24V batteries

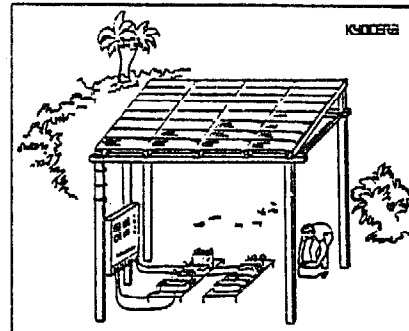

MODEL NO.	ARRAY Wp	OUTPUT Wh/day	PRICE U.S. \$
charge station	1440	charge rate: ten 100Ah 12v batteries in 3 days	refer to supplier

EXAMPLES OF PRODUCTS AVAILABLE - BATTERY CHARGERS

Company: RADE KONCAR

Fallerovo Setaliste 22, 4100 Zagreb, Yugoslavia

Product: VEHICLE BATTERY CHARGING SYSTEM

Includes: PV Module and Connectors

MODEL NO.	ARRAY Wp	OUTPUT Wh/day	PRICE U.S. \$
RK-PV	4	15Wh/day at 5kWh/m ² /day	Refer to supplier

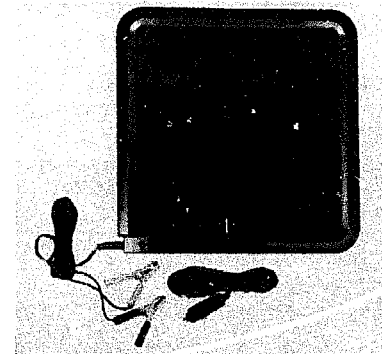

Company: R & S RENEWABLE ENERGY SYSTEMS P.O. Box 45, 5600 AA Eindhoven, The Netherlands

Product: BATTERY CHARGING SYSTEM

Includes: Module & mounting bracket, battery charge regulator with overcharge protection, manual, all necessary tools & installation materials. Does not include battery, optional low battery voltage protection

MODEL NO.	ARRAY Wp	OUTPUT Wh/day	PRICE U.S. \$
SOLARC I	45	180 @ 5 kWh/m ² /d	340

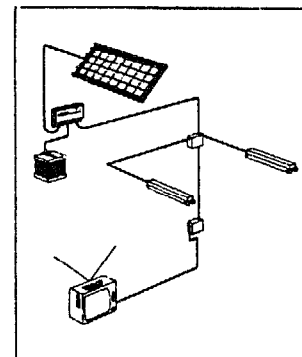

Company: SIEMENS

Buchenallee 3, D-5060, Bergisch Gladbach, W. Germany

Product: DOMESTIC BATTERY CHARGING STATION

Includes: PV module, 100Ah battery, charge controller, cable junction box, instruction manual and optional array support and battery box.

MODEL NO.	ARRAY Wp	OUTPUT Wh/day	PRICE U.S. \$
		approx @5kWh/ m ² /d	
SG1	35	140	550
SG2	70	280	1,270
SG3	105	420	1,590
SG4	140	560	2,050
SG6	210	820	3,100

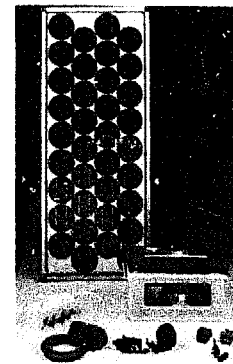

Company: SOLAPAK LTD

Factory 3, Cock Lane, High Wycombe, Bucks, HP13 7DE, UK

Product: PORTABLE BATTERY CHARGING SYSTEMS

Includes: PV modules, carrying case and charge regulator

MODEL NO.	ARRAY Wp	OUTPUT Wh/day	PRICE U.S. \$
			approx
HDS	106	250 - 350	1,700
Portapak Chargeabout	10.8	30 - 50	800

The most versatile of **solapak's** portable power range, the solar **Chargeabout** is supplied in a folding canvas pouch which may be carried on a belt or a back pack.

EXAMPLES OF PRODUCTS AVAILABLE - BATTERY CHARGERS

Company: SOLAR ENERGIE TECHNIK Postfach 1180, D-6822, Altlussheim, W Germany

Product: BATTERY CHARGING SYSTEM

Includes: PV Modules and support structure, battery and charge controller

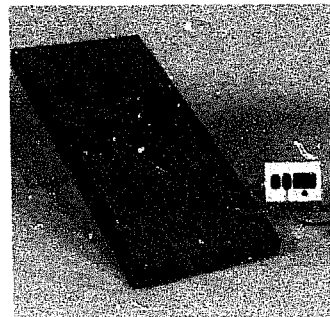

MODEL NO.	ARRAY Wp	OUTPUT Wh/day	PRICE U.S. \$
1SM55/12V	53	265	554
4SM55/12V	212	1060	1,760
8SM55/24V	424	2120	3,376

Company: SOVONICS 1100 West Maple Road, Troy, Michigan 48084, USA

Product: BATTERY CHARGING SYSTEMS

Includes: FET switching, battery charge controllers for PV applications

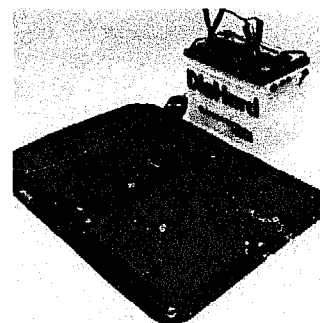

MODEL NO.	ARRAY Wp	OUTPUT Wh/day	PRICE U.S. \$
SP 102	2	10	refer
SP 105	6	25	to
SP 110	12	50	supplier

Company: SUNTRON 2/861 Doncaster Road, Doncaster East, Vic 3109, Australia

Product: BATTERY CHARGING SYSTEMS

Includes: FET switching, battery charge controllers for PV applications

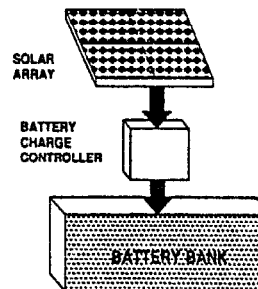

MODEL NO.	OUTPUT	PRICE U.S. \$
BCC1203	12 volt, 3 Amp	refer to supplier
BCC1230	12 volt 30 Amp	
BCC2424	24 volt 24 Amp	

Company: TOTAL ENERGIE 7 Chemin du Plateau, ZI. Le Tronchon, 69570 Dardilly France

Product: BATTERY CHARGING SYSTEMS

Includes: Module and support structure, battery box charge controller with battery overcharge & discharge protection. Optional kit form support structure. (TGP series).

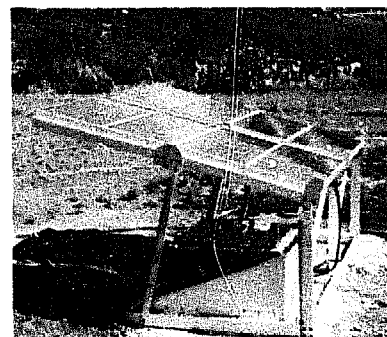

MODEL NO	ARRAY Wp	OUTPUT Wh/day @6kWh/m2/d	PRICE U.S. \$
TGP 45	45	170 Wh/day	1,690
TGP 180	180	700 Wh/day	4,900
TGP 270	270	1000/ Wh/day	7,200
TGP 360	360	1400 Wh/day	9,200
TGP 540	540	2100 Wh/day	11,800

5. WATER PUMPING

5.1 EXPERIENCES

More than 10,000 PV pumps are known to be operating throughout the world and experiences have been good. Solar pumps are used to pump from boreholes, open wells, rivers and canals to provide rural water and irrigation supplies. Less common applications include de-watering drainage pumping and water circulation for fish farms.

With technical problems now largely resolved, experience suggests that reports of poor performance are largely caused by incorrectly specified solar, water resource and water demand data. Proper consideration must be given to these parameter and also the well characteristics (yield and draw down) to ensure correct system operation.

A comprehensive UNDP and world Bank study, completed in 1983 included testing of systems in Egypt, Mali, Philippines and the Sudan. This did much to demonstrate that solar pumps are technically and economically viable and ready to meet the pumping needs of rural areas.

Particular project experience includes:

Mali: provides a good example of solar pumping experience. Over the past 11 years more than 150 PV pumping systems have been installed, mainly under the auspices of Mali Aqua Viva, a charitable organisation. A high degree of local involvement has been insisted upon, especially with construction work on water tanks, foundations, access, etc. This has provided up to 25% of the initial cost of any one project and generated a high level of enthusiasm within the locality.

Borehole centrifugal pumps have been the type most widely used in Mali, originally coupled to surface mounted d.c. motors. More recent installations have changed to using pumps with

submerged a.c. motor/pump sets because of their lower maintenance costs. Reliability of the equipment in the harsh Sahelian environment has been good with the solar pumping systems operating for more than 99% of the time. Most recent installations have operated faultlessly and effectively since being commissioned. Monitoring of over 70 pumps for 8 years showed mean time between failures of greater than 12 years.



Figure 5.1 A Solar Pump in Mali

Bolivia: in co-operation with the World Bank and the Government of Bolivia, the US Department of Energy has installed three pumping systems in the altiplano region of Bolivia near Lake Titicaca. The systems have operated flawlessly in providing a potable water supply, since installation in 1986. A submerged centrifugal pump/motor combination is used with photovoltaic arrays ranging from 160 to 320 Watts. Acceptance by the users was immediate, resulting in a higher usage than that originally anticipated and considerable interest for further system in the area.

India: the largest number of solar pumps in one country is in India, where more than 500 systems have been installed for vilage water supplies. Good responses have been reported along with wide user acceptance. The modules and systems have been manufactured by Central Electronics Limited (CEL) in India. The potential of PV in India is so great that other companies have started PV production including Bharat Heavy Electricals Limited (BHEL), Rajasthan Electronics and Instruments Limited (REIL), Tata-BP Solar and Suryovonics.

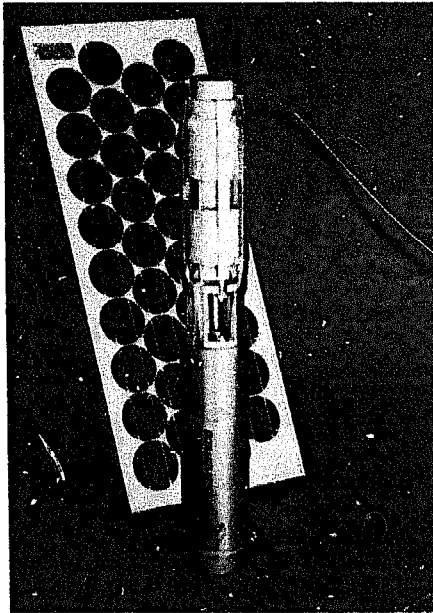

Heliodinamica (Brazil)

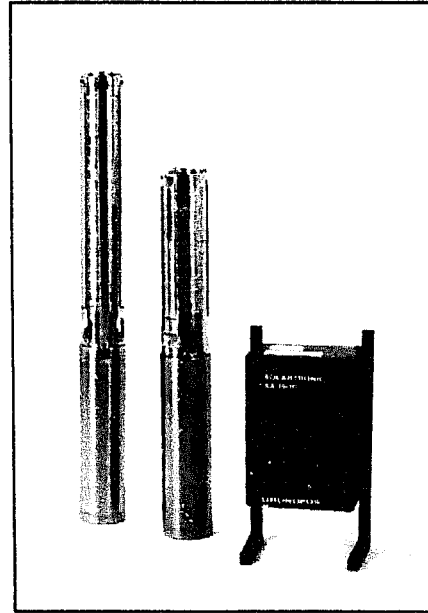

Grundfos (Denmark)



KSB (Germany)

Typical Commercially Available Products

5.2 RELATIVE MERITS

Water pumping has a long history so many methods have been developed to pump water with a minimum of effort. These have utilised a variety of power sources, namely human energy, animal power, hydro power, wind, solar and fossil fuels (diesel and gasoline) for small generators.

The relative merits of these are laid out in Table 5.1.

	<u>Advantages</u>	<u>Disadvantages</u>
Hand pumps	<ul style="list-style-type: none"> ● local manufacture is possible ● easy to maintain ● low capital cost ● no fuel costs 	<ul style="list-style-type: none"> ● loss of human productivity ● often an inefficient use of boreholes ● only low flow rates are achievable
Animal driven pumps	<ul style="list-style-type: none"> ● more powerful than humans ● lower wages than human power ● dung may be used for cooking fuel 	<ul style="list-style-type: none"> ● animals require feeding all year round ● often diverted to other activities at crucial irrigation periods
Hydraulic pumps (eg. rams)	<ul style="list-style-type: none"> ● unattended operation ● easy to maintain ● low cost ● long life ● high reliability 	<ul style="list-style-type: none"> ● require specific site conditions ● low output
Wind pumps	<ul style="list-style-type: none"> ● unattended operation ● easy maintenance ● long life ● suited to local manufacture ● no fuel requirements 	<ul style="list-style-type: none"> ● water storage is required for low wind periods ● high system design and project planning needs ● not easy to install
Solar PV	<ul style="list-style-type: none"> ● Unattended operation ● low maintenance ● easy installation ● long life 	<ul style="list-style-type: none"> ● high capital costs ● water storage is required for cloudy periods ● repairs often require skilled technicians
Diesel and Gasoline Pumps	<ul style="list-style-type: none"> ● quick and easy to install ● low capital costs ● widely used ● can be portable 	<ul style="list-style-type: none"> ● fuel supplies erratic and expensive ● high maintenance costs ● short life expectancy ● noise and pollution

Table 5.1 Comparison of Pumping Techniques

The wind, solar and water powered stand-alone systems will operate without input from other resources. This makes them most applicable to very remote or inaccessible sites - BUT they involve the introduction of a new technology so time is required for:

- assessing the availability of the resource
 - acquiring the equipment
 - familiarisation and training in operation and maintenance.
-
- **Handpumps** - are the most common type of water pumping device because of their low cost and relative simplicity. They are appropriate for low lifts (<20m) and where the demand is small. Handpumps do have hidden costs, namely the time spent by people queuing and pumping water and the limitation on the output of a borehole they impose.
 - **Animal powered pumps** - Some 200 million draft animals are in use in developing countries mainly in South East Asia. Many of these are used for powering Persian wheels, Mohtes, Sakias and other animal driven pump designs. In many countries these devices are gradually being replaced by diesel pumps.
 - **Water powered pumps** - can be used in one of two forms, to drive small hydro-electric plant which can then be used to power electric pumps or for water driven pumps - hydraulic rams or river current turbines. The use of water power is also very site specific - there has to be a sufficient amount of water in the right place and with reasonable access. Generally, if these conditions are fulfilled, the use of hydraulic powered pumps is often very appropriate.
 - **Windpumps** are considered appropriate in relatively windy locations where average wind speeds are over 2.5m/s in the least windy month. Windpump performance is very site specific. The output is dependent upon the wind availability and often the windy areas are not where the water resources are, ie wind is generally more available on hills while water is in the valleys. Windpumps almost always utilize reciprocating positive displacement pumps and can pump from boreholes and wells and lift water more than 200 metres.
 - **Photovoltaic pumping systems** should be considered in sunny locations (where worst month insolation exceeds 2.8 kWh/m²/day and in areas where supply of other fuels is difficult. Solar pumps are not normally economic for very large pumping needs (where a 3 kWp or more PV array is required).
 - **If diesel or gasoline engine pump sets** are to be considered (ie, if the wind or solar resource is poor) then it is essential that fuel and spare parts supplies are reliable.

A decision chart to assist in identifying the appropriate water pumping option is shown in Figure 5.2.

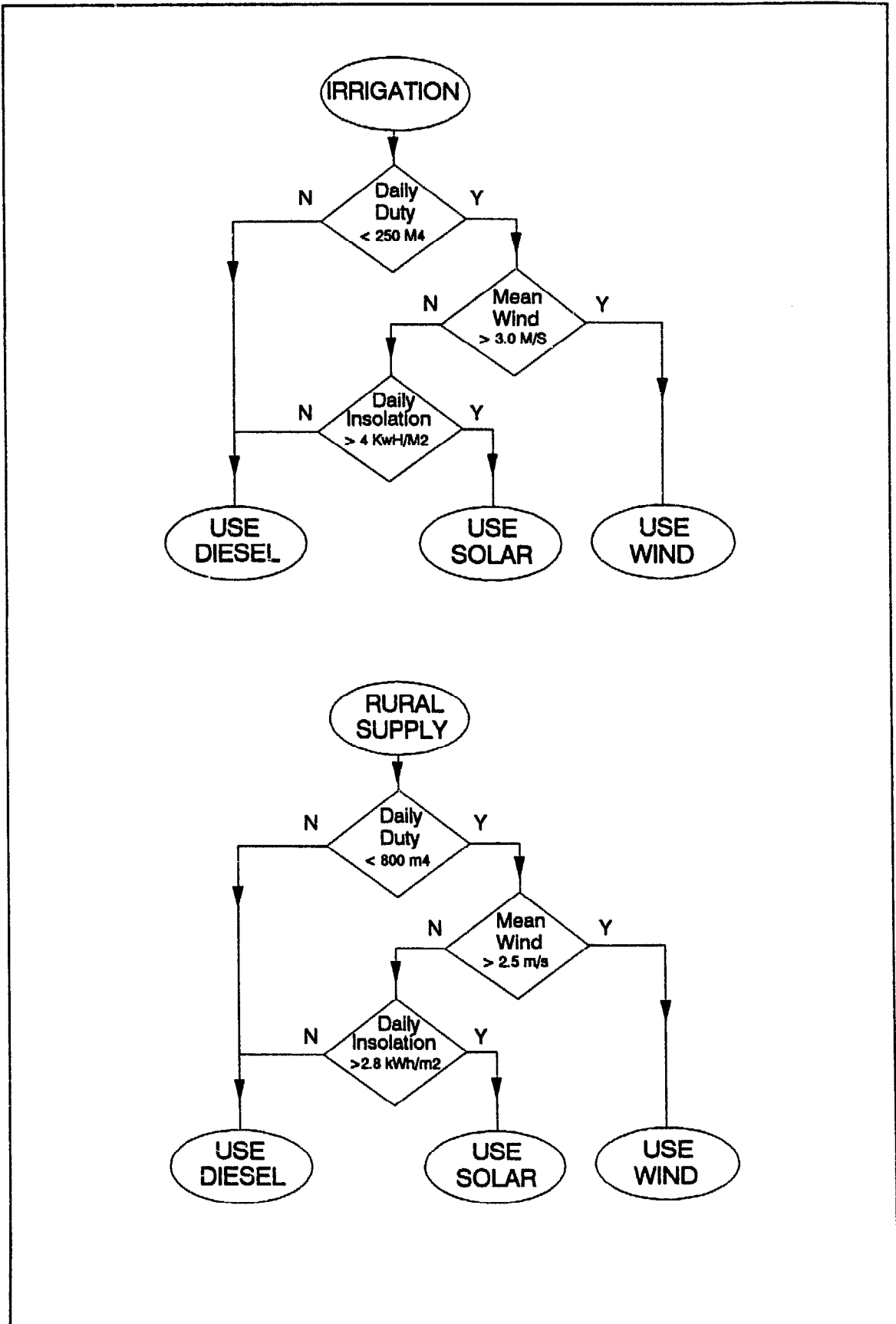

Figure 5.2 Decision Charts for an Appraisal of Solar Pump Appropriateness

5.3 COMMERCIALY AVAILABLE EQUIPMENT

5.3.1 Applications

Solar pumps are used principally for two applications, Village Water Supply (including livestock water supply) and Irrigation.

A solar pump for village water supply is shown schematically in Figure 5.3. With village water supply a constant water demand throughout the year occurs although there is need to store water for periods of low insolation. Typically in Sahelian Africa the storage would be 3 to 5 days of water demand. In environments where rainy seasons occur the reduced output of the solar pump during this period can be offset by rain water harvesting. The majority of solar pumping systems installed to date are for village water supply or livestock watering. Systems typically have arrays of less than 3 kWp and pump at heads of 20 - 60m.

A solar irrigation system needs to take account of the fact that demand for irrigation water will vary throughout the year. Peak demand during the irrigation seasons is often more than twice the average demand. This means that solar pumps for irrigation are underutilized for most of the year. Attention should be paid to the system of water distribution and application to the crops. The system should minimize water losses without imposing significant additional head on the pumping system, and be of low cost.

The suitability of major irrigation systems for use with solar pumps is shown in Table 5.1.

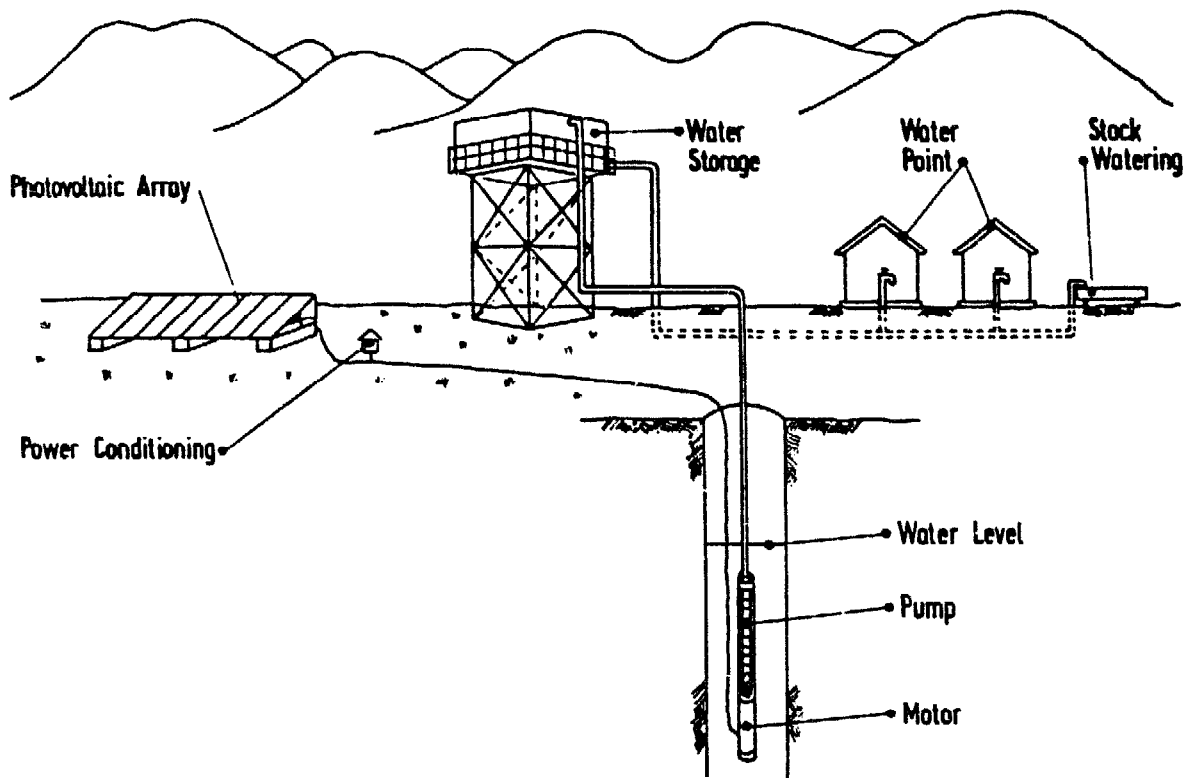

Figure 5.3 Schematic of A Solar Powered Village Water Supply System

Distribution Method	Typical Application Efficiency	Typical Head	Suitability for use with Solar Pumps?
Open channels	50 - 60%	0.5 - 1m	Yes
Sprinkler	70%	10 - 20 m	No
Trickle	85%	1 - 2 m	Yes
Flood	40 - 50%	0.5m	No

Table 5.2 Suitability of Major Irrigation Methods for use with Solar Pumps

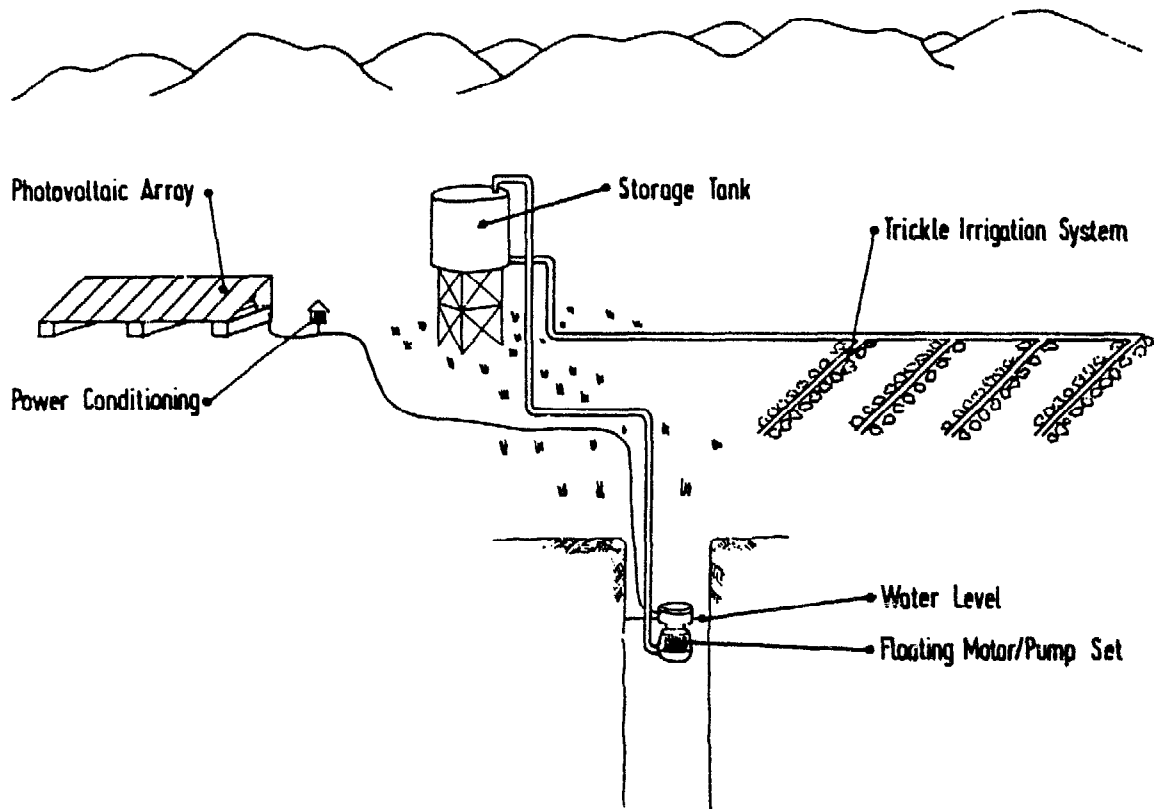

Figure 5.4 Schematic of A Solar Irrigation Pumping System

5.3.2 The Technology

Systems are broadly configured into 5 types as described below:

Submerged multistage centrifugal motor pumpset (Figure 5.5).

This type is probably the most common type of solar pump used for village water supply. The advantages of this configuration are that it is easy to install often with lay-flat flexible pipework and the motor pumpset is submerged away from potential damage.

Either a.c. or d.c. motors can be incorporated into the pumpset although an inverter would be needed for a.c. systems. If a brushed d.c. motor is used then the equipment will need to be pulled up from the well (approximately every 2 years) to replace brushes. If brushless d.c. motors are incorporated then electronic commutation will be required. The most commonly employed system consists of an a.c. pump and inverter with a PV array of less than 1500 Wp.

Submerged pump with surface mounted motor (Figure 5.6).

This configuration was widely installed with turbine pumps in the Sahelian West Africa during the 1970s. It gives easy access to the motor for brush changing and other maintenance.

The low efficiency from power losses in the shaft bearings and the high cost of installation have been disadvantages.

In general, this configuration is largely being replaced by the submersible motor and pumpset.

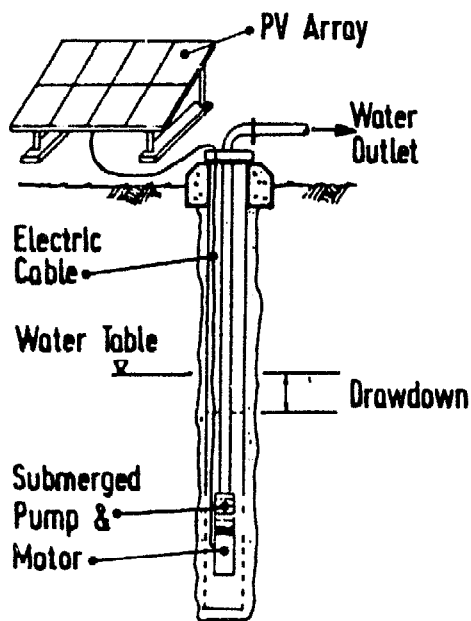

Figure 5.5 Submerged Centrifugal Pumpset Configuration

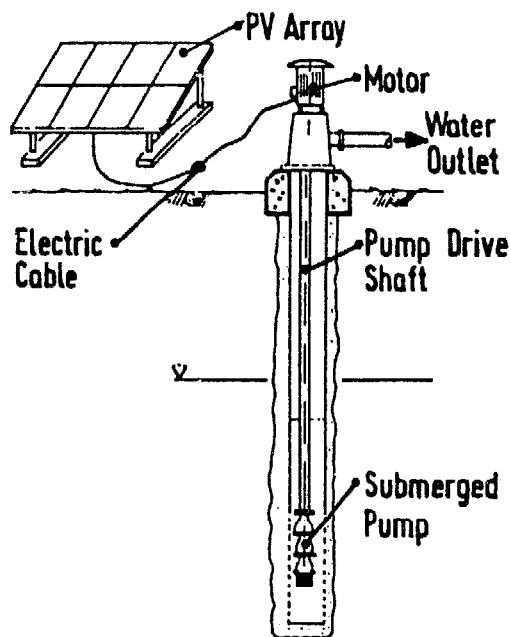

Figure 5.6 Surface Motor-Submerged Pump Configuration

Reciprocating positive displacement pump (Figure 5.7).

The reciprocating positive displacement pump (often known as the jack or nodding donkey) is very suitable for high head, low flow applications.

The output is proportional to the speed of the pump. At high heads the frictional forces are low compared to the hydrostatic forces, often making positive displacement pumps more efficient than centrifugal pumps for this situation. Reciprocating positive displacement pumps create a cyclic load on the motor which, for efficient operation, needs to be balanced. Hence the above ground components of the solar pump are often heavy and robust and power controllers for impedance matching often used.

Floating motor-pump sets (Figure 5.8).

The versatility of the floating unit set makes it ideal for irrigation pumping from canals and open wells. The pumpset is easily portable and there is a negligible chance of the pump running dry.

Most of these types use a single stage submersed centrifugal pump. The most common type utilize a brushless (electronically commutated) d.c. motor. Often the solar array support incorporates a handle or 'wheel barrow' type trolley to enable transportation.

Surface suction pumpsets (Figure 5.9)

This type of pumpset is not recommended except where an operator will always be in attendance. Although the use of priming chambers and non-return valves can prevent loss of prime, in practice self start and priming problems are experienced. It is impractical to have suction heads of more than 8 metres.

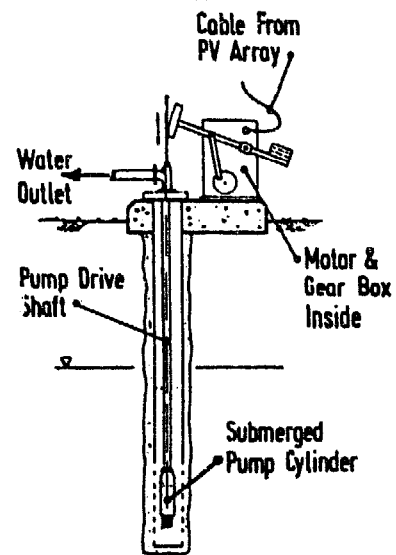

Figure 5.7 Positive Displacement 'Jack' pump

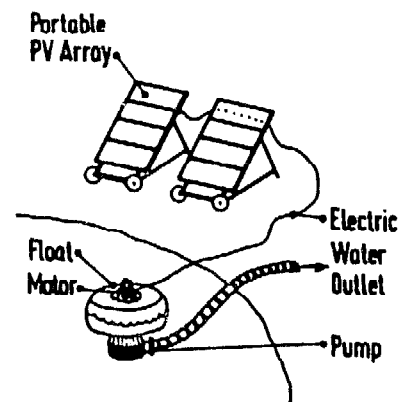

Figure 5.8 Floating Motor-pump Configuration

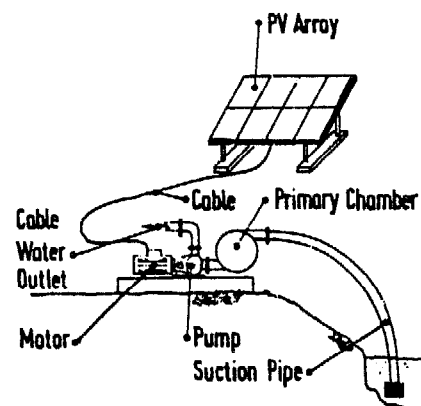

Figure 5.9 Surface Suction Configuration

5.3.3 Performance

The performance of some commercially available products is shown in Figure 5.10. It can be seen that solar pumps are available to pump from anywhere in the range of 1.5m to 200m head and with outputs of up to 250m³/day.

Solar pumping technology continues to improve. In the early 1980s the typical solar energy to hydraulic (pumped water) energy efficiency was around two per cent with the photovoltaic array being six to eight per cent efficient and the motor pumpset typically 25 per cent efficient. Today, an efficient solar pump has an average daily solar energy to hydraulic efficiency of more than four per cent.

Photovoltaic modules of the monocrystalline type now have efficiencies in excess of 15 per cent and more efficient motor and pumpsets are available. A good sub-system (that is the motor, pump and any power conditioning) should have an average daily energy throughput efficiency of at least 30% or ideally more than 40%.

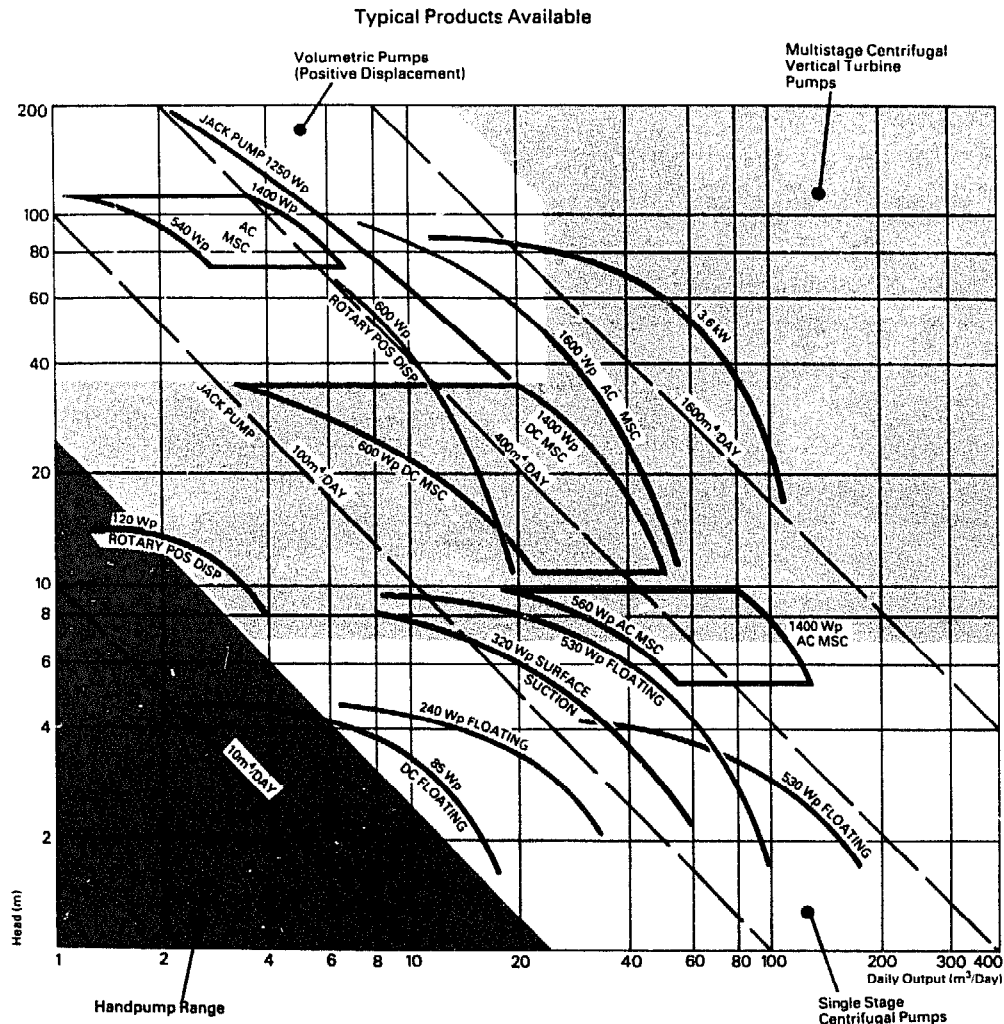

Figure 5.10 Performance of Commercially Available Solar Pumping Systems

5.3.4 Costs

A PV pumping system to pump 25m³/day through 20m head requires a solar array of approximately 800 Wp in the Sahelian regions. Such a pump would cost approximately \$9,000 FOB. Other example costs are shown in Table 5.2.

A range of prices is to be expected, since the total system comprises the cost of modules, pump, motor, pipework, wiring, control system, array support structure and packaging. Systems with larger array sizes generally have a lower

cost/Wp. The cost of the motor pumpsets varies according to application and duties; a low lift suction pump may cost less than \$800 whereas a submersible borehole pumpset costs \$1500 or more.

Motor Pump/configuration	Output (m ³ / day) @ 5kWhm ² /day Insolation	Head (m)	Solar Array (Wp)	System Price US\$ FOB
a) Submerged borehole motor pump	40 25	20 20	1200 800	12,000 - 15,000 9,000 - 10,000
b) Surface motor / submerged pump	60	7	840	8,000 - 9,000
c) Reciprocating positive displacement pump	6	100	1200	9,500 - 11,000
d) Floating motor/pumpset	100 10	3 3	530 85	5,500 - 7,500 2,000 - 2,500
e) Surface suction pump	40	4	350	3,500 - 4,500

Table 5.2 Typical PV Pumping Systems

A life cycle cost analysis of a solar pumping system is shown in Table 5.3

<u>System</u>		<u>Life cost Analysis</u>	
Location	: Sahel	Period of Analysis	: 15 years
Array Size	: 1400Wp	Discount Rate	: 10%
Head	: 10m		
Annual Output	: 27,200m ³	Replacement Costs (2 spare pumps)	: \$3,500
System Cost	: \$16,500	- present worth (bought with system)	: \$3,500
Transportation and Installation	: \$8,300	Recurrent Costs (Maintenance)	: \$250 / yr
		- present worth	: \$1,902
Total Installed:	: _____	Total Present worth of life cycle costs	: \$30,202
Cost	: \$24,800	Annualised Life Cycle Costs	: \$3,960
		Unit Water Cost	:
		If 100% of Output utilised	: \$0.15 per m ³
		If 50% of Output utilised	: \$0.29 per m ³

Table 5.3 Life Cycle Cost Analysis for Solar Pumps

5.4 PROCUREMENT

5.4.1 Assessing Requirements

The output of a solar pumping system is very dependent on good system design derived from accurate site and demand data. It is therefore essential that accurate assumptions are made regarding water demand and pattern of use and water availability including well yield and expected drawdown.

Domestic water use per capita tends to vary greatly depending on availability. The long term aim is to provide people with water in sufficient quantities to meet all requirements for drinking, washing and sanitation. Present short term goals aim for a per capita provision of 40 litres per day, thus a village of 500 people has a requirement of 20 cubic metres per day. Most villages have a need for combined domestic and livestock watering.

Irrigation requirements depend upon crop water requirements, effective rainfall, groundwater contributions and efficiency of the distribution and field application system. Irrigation requirements can be determined by consultation with local experts and agronomists or by reference to FAO document "Cropwater requirements" (J Doorenbos, W O Pruitt, FAO, Rome, 1977). Typical figures are given in Table 5.4.

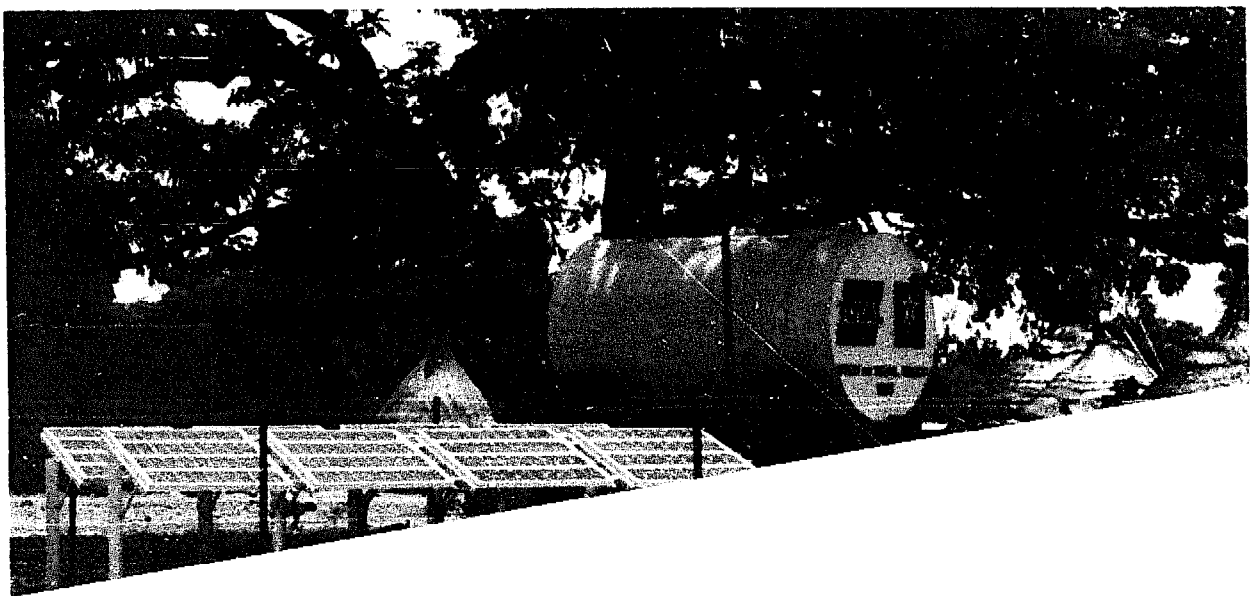

Generally accepted water requirements for community water supply, livestock and irrigation are given in Table 5.4.

COMMUNITY litres/day/person	LIVESTOCK litres/day/animal	IRRIGATION m ³ /day/hectare cultivated
To survive 8	goats/sheep 8	potatoes 30
Subsistence level 20	pigs 15	vegetables 50
	donkeys/camels 20	coffee 55
Present aims 40	cattle/horses 45	rice 100

Table 5.4 Typical Daily Water Requirements

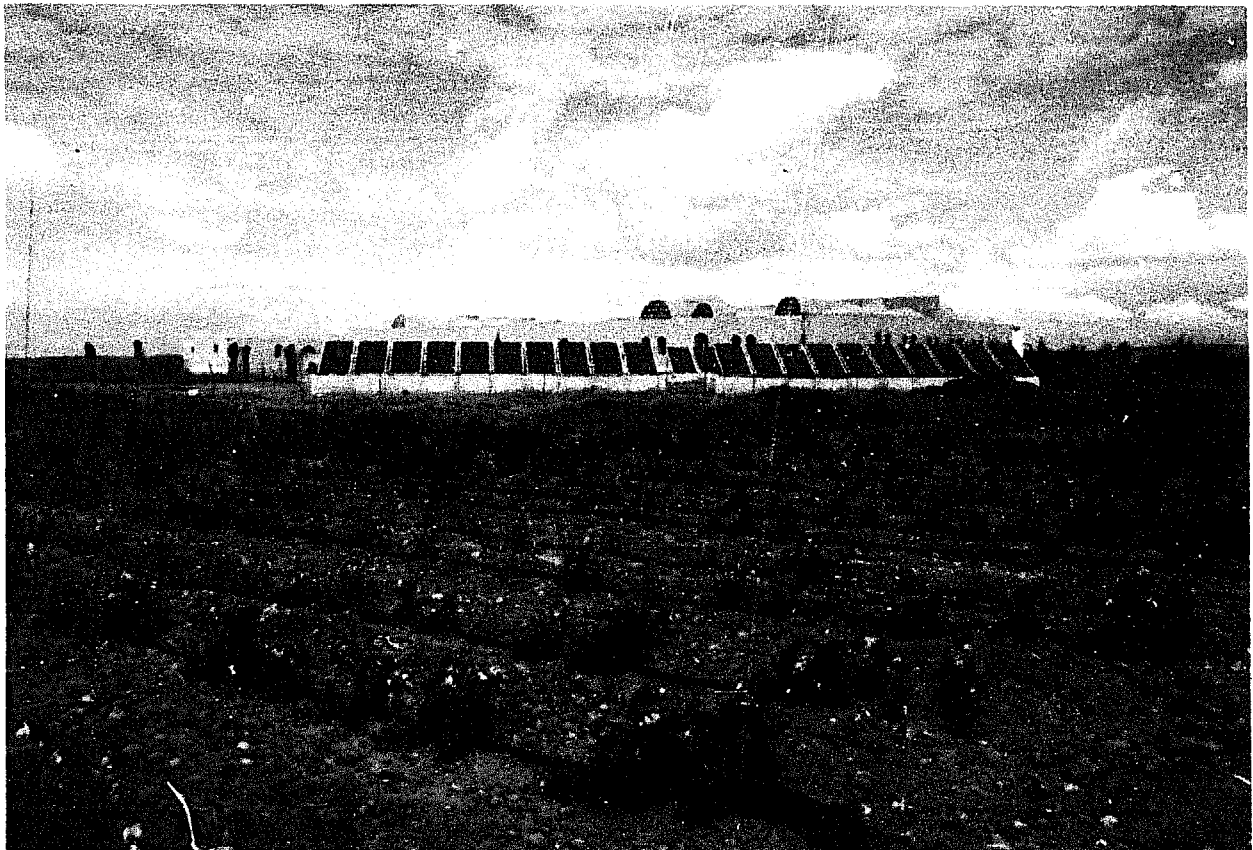

Figure 5.12 PV Irrigation System in Egypt

5.4.2 Assessing Water Availability

Several water source parameters need to be taken into account and where possible measured. These are the depth of the water source below ground level, height of the storage tank or water outlet point above ground level and seasonal variations in water level. The draw-down or (drop in water level after pumping has commenced) also needs to be considered for well and borehole supplies. This will depend on the ratio between pumping rate and the rate of refill of the water source. It is useful to present site details to the supplier in the format laid out in Figure 5.13. The pattern of water use should also be considered in relation to system design and storage requirements. Water supply systems should include sufficient covered water storage to provide for daily water requirements and short periods of cloudy weather. Generally two to five days water demand is stored.

Ground Water Supply	Surface Water Supply
	
<p>Height of storage tank A:</p> <p>Depth of well B:</p> <p>Distance of tank from pump C:</p> <p>Diameter of well or borehole D:</p> <p>Depth of water level E:</p> <p>Drawdown F:</p> <p>Pipe diameter</p>	<p>Height of storage tank A:</p> <p>Suction elevation B: (surface mounted pump only)</p> <p>Distance of tank from pump C:</p> <p>Pipe diameter</p> <p>Seasonal variation of A or B (+ or -) :</p>

Figure 5.13 Pro-forma Specification for PV Pumping System Layout

5.4.3 Selection of Equipment

1. Determine the Viability of Solar Pumps

Using the decision chart on page 46, determine if, on economic grounds, solar pumps are appropriate. Consideration should then be given to associated social and institutional factors, such as the present systems being used for water pumping in the vicinity and compliance with national standardisation plans. Different systems will affect existing patterns of water supply and use. How these fit in with the local skill levels and experience should be considered.

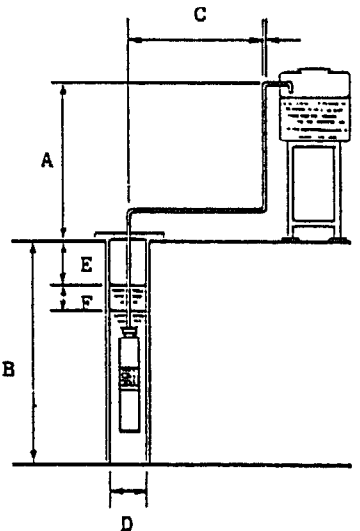
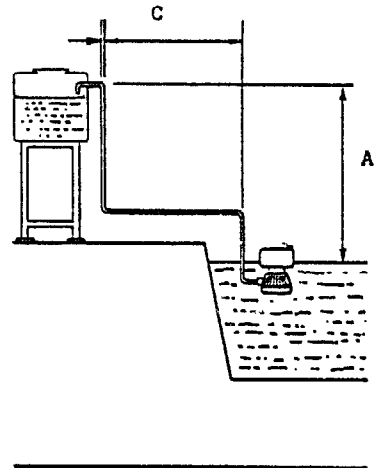
2. Prepare Pro-forma Specification Sheets

Complete the site layout and water demand pro-forma sheets (Figures 5.13 and 5.14 respectively).

3. Issue Request for Tender

By reviewing the product information sheets listed at the end of this chapter, select five or so companies to send a request for tender. Also take into consideration companies that are known to have representation in the region where the equipment is to be installed (see Appendix 2).

A general tender document is given in Annex 3. This can be modified to suit particular applications and specifications. Figure 5.15 shows a performance sheet which should be completed by the supplier. Forward the tender document, the two pro-forma specification sheets you have prepared, plus a blank performance sheet to each company selected.

4. Compare the Costs with Alternative Pumping Systems

When quotations have been received from the manufacturers, it is necessary to check that buying a solar pump will be a sensible use for development funds. In almost all cases, a solar pump will cost more on an initial capital cost basis, but will have lower running costs than a diesel pumpset. Ideally, life cycle costing should be undertaken using present worth analysis of future costs and benefits. This is described in Appendix III. An example shown in Table 5.5 compares life cycle costs for a solar and a diesel pump. It can be seen that although the solar pump costs more to buy, over its life the unit cost of pumping water is less expensive than if a diesel pump is used.

5. Place the Order

Select the most appropriate solar pump to meet your requirements and budget. Ensure you are satisfied that solar pumping is the most appropriate use of funds available, that satisfactory answers have been received from the manufacturers on all queries relating to the equipment, that all the necessary components, special tools and accessories necessary to complete the installation have been ordered and that spare parts sufficient for 5 years' operation have been ordered.

Pro Forma Specification Sheet – <u>To be completed by user</u>												
Location:	Latitude:			Longitude:								
Water source:												
Application												
water supply or irrigation:												
no. of users or area to irrigate:												
Site Details: (Complete layout information on next page also):												
Month:	Jan	Feb	Mar	Apr	May	Jun	Jul	Aug	Sep	Oct	Nov	Dec
Average Daily Water Need (m ³)												
Static Head (m)												

Figure 5.14 Water Demand Pro-Forma Sheet: To be Completed by User

System Details and Performance – <u>To Be Completed By Supplier</u>												
System specification												
Arrav Wp:						Pipe diameter: mm						
Tilt angle:						Pipe lengths supplied: m						
Motor Voltage: Volts						Motor Type:						
Pump Type:						Type:						
Water Store: m ³						Type:						
Distribution System Details and Type:												
.....												
Month:	Jan	Feb	Mar	Apr	May	Jun	Jul	Aug	Sep	Oct	Nov	Dec
Dynamic Head (m)												
Insolation Assumed MJ/m ² /d												
Average Daily Water Output (m ³)												

Figure 5.15 Performance Specification Sheet: To be Completed by Supplier

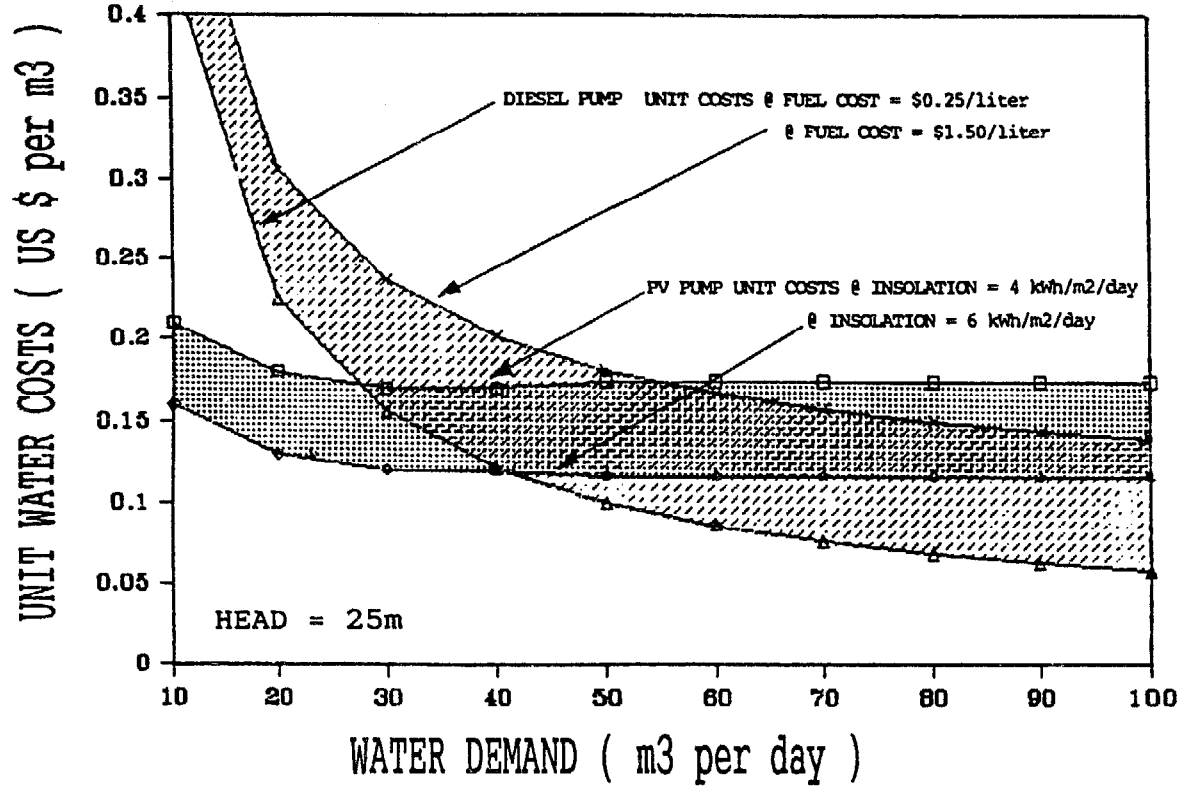

PV PUMP SYSTEM CHARACTERISTICS

Depth of Water Supply, Head	25m
Annual Average Daily Water Demand	20 m ³ /day
Annual Max Daily Water Demand	30 m ³ /day
Insolation	5.0 kWh/m ² /day
PV Array Peak Power	1.11 kWp
PV Pumping System Capital Cost	12.00\$/Wp
PV Pumping System Availability	95%
PV Array Life	20 yrs
Pump Life	5 yrs
Normal Discount Rate	10 %
Inflation Rate	5%
PV Annualised Life Cycle Cost	\$0.14/m ³

DIESEL PUMP CHARACTERISTICS

Depth of Water Supply, Head	25m
Annual Average Daily Water Demand	20 m ³ /day
Annual Max Daily Water Demand	30 m ³ /day
Diesel Generator Power Rating	3.0 kW
Average Load Factor	45.4%
Diesel Fuel Cost	\$0.75 /litre
Diesel Gen-Set pump Capital Cost	\$1.59/W
Diesel Pump Availability	90%
Diesel Gen-Set Life	6 yrs
Pump Life	5 yrs
Diesel Annualised Life Cycle Cost	\$0.26 /m ³

Table 5.5 Example of Comparative Life Cycle Costs of Solar and Diesel Pumps

5.5 IMPLEMENTATION CONSIDERATIONS

5.5.1 Installation

When installing the equipment, ensure:

- manufacturers' instructions are followed accurately
- the array is kept covered throughout installation of the system
- the solar array faces towards the equator and is tilted at the angle of latitude plus 10 degree or as recommended by the supplier
- the solar array cannot be shaded by trees or buildings during the day except before 0730 or after 1630
- there is safe access to the array for cleaning
- all cable lengths are kept to a minimum in order to reduce power losses
- power controllers and junction boxes are shaded and protected from rain penetration
- you position the motor-pumpset in the well to allow for drawdown and possible long term water table drop
- pipe lengths and number of bends and restrictions in the pipework are kept to a minimum to reduce head losses
- water storage tank and stand pipe configurations do not impose high static lifts (or shade the array)
- pipe diameters are sufficiently large so as not to impose additional head losses
- any paint or sealants used are safe and do not contain harmful additives.

5.5.2 Maintenance

Regular maintenance will help ensure maximum performance is obtained from a solar pump. The following should be undertaken as often as possible:

- clean the solar array with water and a cloth
- clear the pump inlet filter and strainer of leaves and other particles that may impede the flow into the pump
- check cables for evidence of damage or loose connections
- commutator brushes of d.c. motors may need changing every 2-5 years
- Routine maintenance as specified by the supplier must be undertaken.

Product: SUBMERSIBLE BOREHOLE PUMPING SYSTEM - TYPE SPTP

Includes: PV array and support structure. MPPT control unit, inverter, flexible riser pipe, submersible a.c. motor pumpset, cable and necessary fittings

Applications: Boreholes and rivers. Head range 10-120m

MODEL NO.	WATTS PEAK	PERFORMANCE @ 5.0 kWh/m ² /day			PRICE U.S.\$
		HEAD RANGE m	HEAD m	m ³ /day	
BP SP1	1225	80 - 120	100	5	P.O.A.
BP SP2	1225	30 - 80	50	15	18,000
BP SP3	1225	5 - 35	20	36	15,300
BP SP4	1225	8 - 20	15	52	12,000
BP SP5	1225	5 - 11	8	86	9,500
BP SP6	1225	5 - 80	6	130	6,700

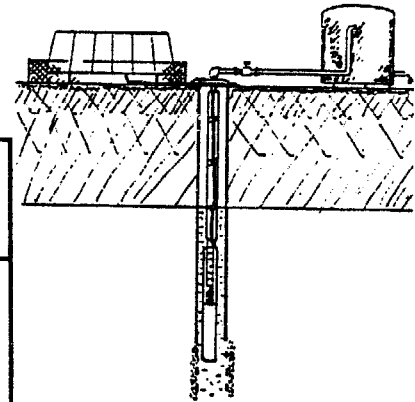

Company: CHRONAR FRANCE - 3 Allee Edme, Lheureu, 94340 Joinville - Le Pont, France

Product: SUBMERSIBLE SOLAR PUMPING SYSTEM

Includes: 8 PV modules, support structure, cables, pumpset and instruction manual

Applications: Boreholes and rivers. Head range 10 - 80m

MODEL NO.	WATTS PEAK	PERFORMANCE @ 5.0 kWh/m ² /day				PRICE U.S.\$
		HEAD	m ³ /day	HEAD m	m ³ /day	
ESPOIR	88	10	1.8	6.0	0.7	2,300

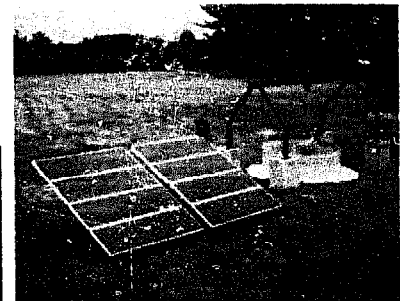

Product: SUBMERSIBLE SOLAR PUMPING SYSTEM

Includes: Subsystems for submersible water pumping, submersible pump/motor, DC-AC inverter and accessories.

Applications: Boreholes and rivers. Heads up to 120 m, flow up to 250 m³/day

MODEL NO	WATTS PEAK	PERFORMANCE @ 5.0 kWh/m ² /day		PRICE U.S.\$
		HEAD m	Watts Peak	
SP 1 - 28		80 - 120	750 - 1500	Refer to Supplier
SP 2 - 18		30 - 80	500 - 1500	
SP 4 - 8		5 - 40	250 - 1500	
SP 8 - 4		8 - 20	500 - 150	
SP 27 - 1 (ex.)		5 - 8	750 - 1500	
		----- examples -----		
SP 2 - 18	1484	60	14,5m ³ /day	
SP 4 - 8	1484	20	46,7m ³ /day	
SP 16 - 2	1484	10	99,2m ³ /day	

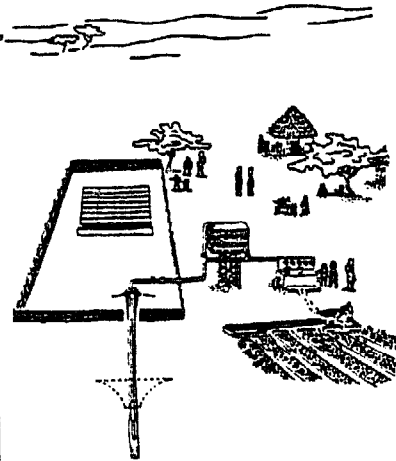

Company: HELIODINAMICA

Caixa Postal III, 06730 Vargem Grande Paulista, SP, Brazil

Product: SUBMERSIBLE SOLAR PUMPING SYSTEM

Includes: PV array with support structure and DC submersible pumpset

Applications: Boreholes, wells and rivers

MODEL NO.	WATTS PEAK	PERFORMANCE @ 5.0 kWh/m ² /day				PRICE U.S.\$
		HEAD	m ³ /day	HEAD	m ³ /day	
SB 37	735	14	39	38	13	11,600
SB 46	840	14	42	54	10	13,400
SB 47	980	14	45	58	10	15,000
SB 56	1050	15	45	63	10	15,800

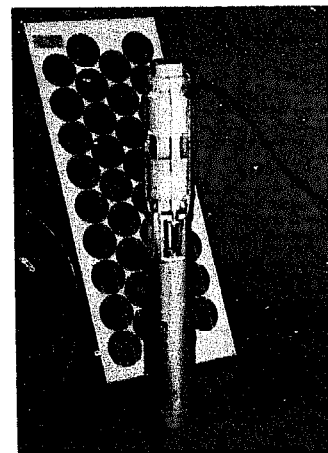

EXAMPLES OF PRODUCTS AVAILABLE - BOREHOLE PUMPING SYSTEMS

Company: SOLAR ENERGIE TECHNIK Postfach 1180, D-6822, Altlußheim, W. Germany

Product: SUBMERSIBLE SOLAR PUMPING SYSTEM

Includes: PV array, support structure, cable submersible motor pumpset

Applications: Boreholes small volume - high head

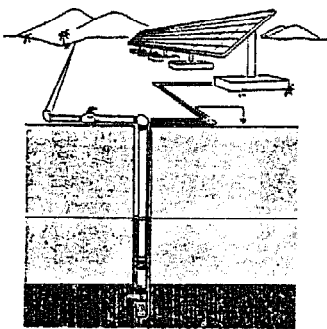

MODEL NO.	WATTS PEAK	PERFORMANCE				PRICE U.S.\$
		Low head		high head		
		HEAD m	m ³ /day	HEAD m	m ³ /day	
SDS	106	20	0.3	65	0.13	1,300

Company: TELEFUNKEN SYSTEMTECHNIK Industrie strasse 23, 2000 Wedel, Holstein, Germany

Product: SUBMERSIBLE BOREHOLE PUMPING SYSTEM

Includes: PV array, steel support structure, inverter submersible a.c pumpset, dry run protection

Applications: Boreholes, wells and rivers



MODEL NO.	WATTS PEAK	PERFORMANCE @ 5.0 kWh/m ² /day				PRICE U.S.\$
		HEAD	m ³ /day	HEAD	m ³ /day	
		21 - 3/61-28	1050	80	4.5	
21 - 3/26-28	1050	30	18	80	3	
21 - 3/46-18	1050	10	47	40	11	
28 - 4/2-18	1400	30	24	80	7	
56 - 4/4-15	2800	40	32	75	14	
70 - 5/4-19	3500	50	32	95	12	

Company: TOTAL ENERGIE 7 Chemin du Plateau, Z.I LeTronchon, 69570 Dardilly France

Product: SUBMERSIBLE BOREHOLE PUMPING SYSTEMS - TYPE TSP

Includes: PV array, anodised aluminium support structures, control box, with inverter, centrifugal submersible a.c. pumpset and fitting accessories

Applications: Wells or boreholes, heads from 10 - 120m, output from 10 to 150 m³/day

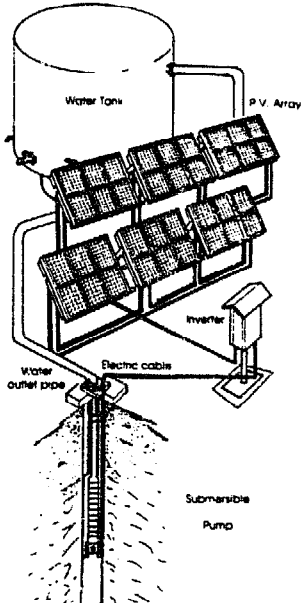

MODEL NO.	WATTS PEAK	PERFORMANCE				PRICE U.S.\$
		Low head		High head		
		HEAD m	m ³ /day	HEAD m	m ³ /day	
TSP 720	720	10	36	25	15	17,400
TSP 1080	1080	10	60	45	12	23,000
TSP 1440	1440	10	75	60	16	28,000
TSP 1800	1800	10	115	60	20	31,400
TSP 2160	2160	10	133	100	11	42,300
TSP 2520	2520	10	148	120	8	46,800
TSP 2880	2880	10	162	120	11	51,000
TSP 3240	3240	20	99	120	15	55,500
TSP 3600	3600	20	107	120	18	60,500
TSP 3960	3960	20	113	120	21	63,000

EXAMPLES OF PRODUCTS AVAILABLE FLOATING AND SUBMERSIBLE SYSTEMS FOR OPEN WELLS/RIVERS

Company: **BP SOLAR** 36 Bridge Street, Leatherhead, KT22 8BZ U.K.

Product: FLOATING PUMP SYSTEM

Includes: PV array, on mobile support structure, floating motor pumpset with centrifugal pump and integral brushless DC motor

Applications: Open channels or wells, low lift, irrigation

MODEL NO.	WATTS PEAK	PERFORMANCE				PRICE U.S.\$
		Low head		High head		
		HEAD m	m ³ /day	HEAD m	m ³ /day	
BP FM	312	4	45	8	10	6,000
	418	4	75	8	35	8,300
BP FL	312	1	210	3	90	6,000
	418	1	260	3	120	8,400

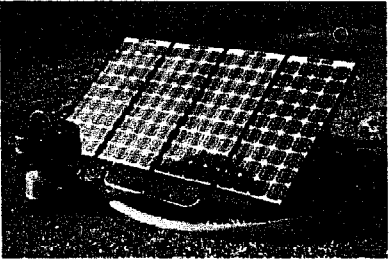

Company: **HYDRASOL CORPORATION** 1001 Alt AIA, Jupiter, Florida 33477, USA

Product: FLOATING PUMPING SYSTEM

Includes: Floating pumpset, PV array and support structure 20m of cable and connectors

Applications: Open wells or rivers, low lift irrigation

MODEL NO.	WATTS PEAK	PERFORMANCE @ 5.0 kWh/m ² /day				PRICE U.S.\$
		Low head		High head		
		HEAD m	m ³ /day	HEAD m	m ³ /day	
HF450 - 100	450	3	130	4.2	93	5,848
HF450 - 110	450	3	138	5	83	5,848
HF - 800	800	5	164	7.5	109	9,446
HF - 1000	1000	5	158	9	103	11,524

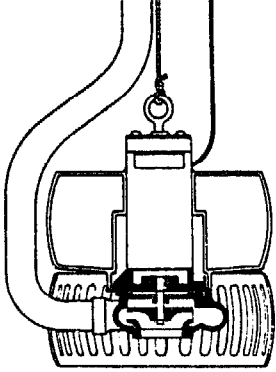

Company: **KYOCERA** Chiba Sakura, Ohsaku, Chome Sakura, Chiba - Pref. 285, Japan

Product: SUBMERSIBLE DC SOLAR PUMPING SYSTEM

Includes: PV array, support structure, cable submersible pump

Applications: Open wells or rivers, low lift irrigation

MODEL NO.	WATTS PEAK	PERFORMANCE @ 6kWh/m ² /day				PRICE U.S.\$
		Low head		High head		
		HEAD m	m ³ /day	HEAD m	m ³ /day	
SMB - 50	96	6	5	10	2	Refer to supplier
SMB - 200	384	3	50	6	30	
SMD - 750	864	9	40	32	10	
SMD - 750	1344	12	50	35	20	

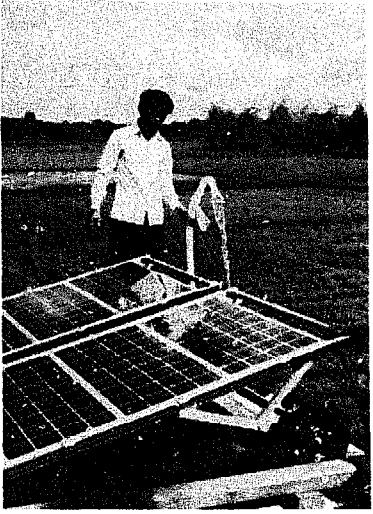

EXAMPLES OF PRODUCTS AVAILABLE

SURFACE MOUNTED SYSTEMS

Company: BP SOLAR

36 Bridge Street, Leatherhead, KT22 8BZ U.K

Product: SURFACE MOUNTED PORTABLE PUMP SYSTEM

Includes: PDI: Surface mounted double-acting positive displacement pump, PV array mounted on mobile trolley, pre-wired with plug and socket connections, d.c. electronic control unit, riser pipe and intake filter.

Utility: Module, support, pumpset and hose.

Applications: Open channels, wells, mobile applications, low volume requirements, low-medium head

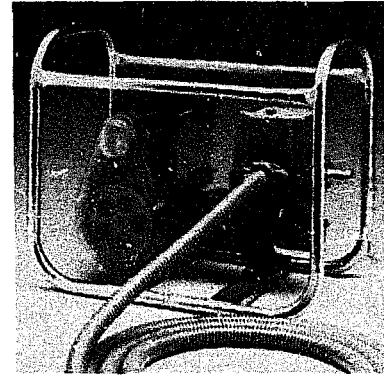

MODEL NO.	WATTS PEAK	PERFORMANCE				PRICE U.S.\$
		@ 5 kWh/m ² /day				
		Low head		High head		
HEAD m	m ³ /day	HEAD m	m ³ /day			
BP PD1 Utility	175	5	3.5	30	2.5	4,000
	40	5	2.5	15	1.0	900

Company: DINH CO. INC.

Box 999, Alachua, Florida 32615, USA.

Product: SURFACE MOUNTED PISTON PUMP

Includes: Surface mounted piston pump, permanent magnet d.c. motor, PV array with concentrating reflectors mounted on tracking support structure, MPPT control unit

Applications: Low head, irrigation medium output

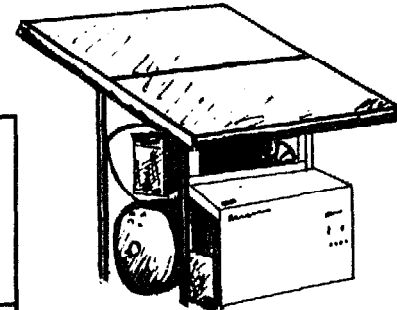

MODEL NO.	WATTS PEAK	PERFORMANCE				PRICE U.S.\$
		@ 5 kWh/m ² /day				
		Low head		High head		
HEAD m	m ³ /day	HEAD m	m ³ /day			
HP 500	80	9	5.7	24	1.9	1,788
HP 900	120	9	10	24	3.4	2,340

Company: A.Y. McDONALD MANUFACTURING CO.

4800 Chavenelle Rd, Dubuque, IA 52001, USA

Product: SURFACE MOUNTED PRESSURISED PUMPING SYSTEM

Includes: PV array, surface mounted pump with permanent magnet d.c. motor and 100Ah battery, Jet ejector provides pressurised water supply

Applications: Open wells rivers and boreholes with water source within 7m of ground level

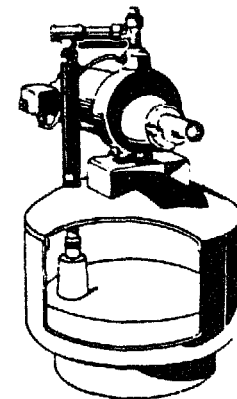

MODEL NO.	WATTS PEAK	PERFORMANCE				PRICE U.S.\$
		@ 6 kWh/m ² /day				
		Low head		High head		
HEAD m	m ³ /day	HEAD m	m ³ /day			
810103DS	40	2	0.76	20	0.3	1000
810203DS	80	2	1.66	20	0.8	1500

6. VACCINE REFRIGERATION FOR HEALTH CARE

6.1 EXPERIENCES

6.1.1. Why PV Refrigerators?

Extensive immunization programmes are in progress throughout the developing world in the fight against the six common communicable diseases. To be effective, these programmes must provide immunization services to rural areas.

Solar power for refrigerators has great potential for lower running costs, greater reliability and longer working life than kerosene refrigerators or diesel generators. Over the past five years, at least 3000 photovoltaic medical refrigerators have been installed.

All vaccines used have to be kept within a limited temperature range throughout transportation and storage. The provision

of refrigeration for this, known as the Vaccine "Cold Chain", is a major logistical undertaking in areas where electricity supplies are non-existent or erratic. The performance of refrigerators fuelled by kerosene and bottled gas is often inadequate. Diesel powered systems frequently suffer fuel supply problems. Solar power is therefore of great importance to health care.

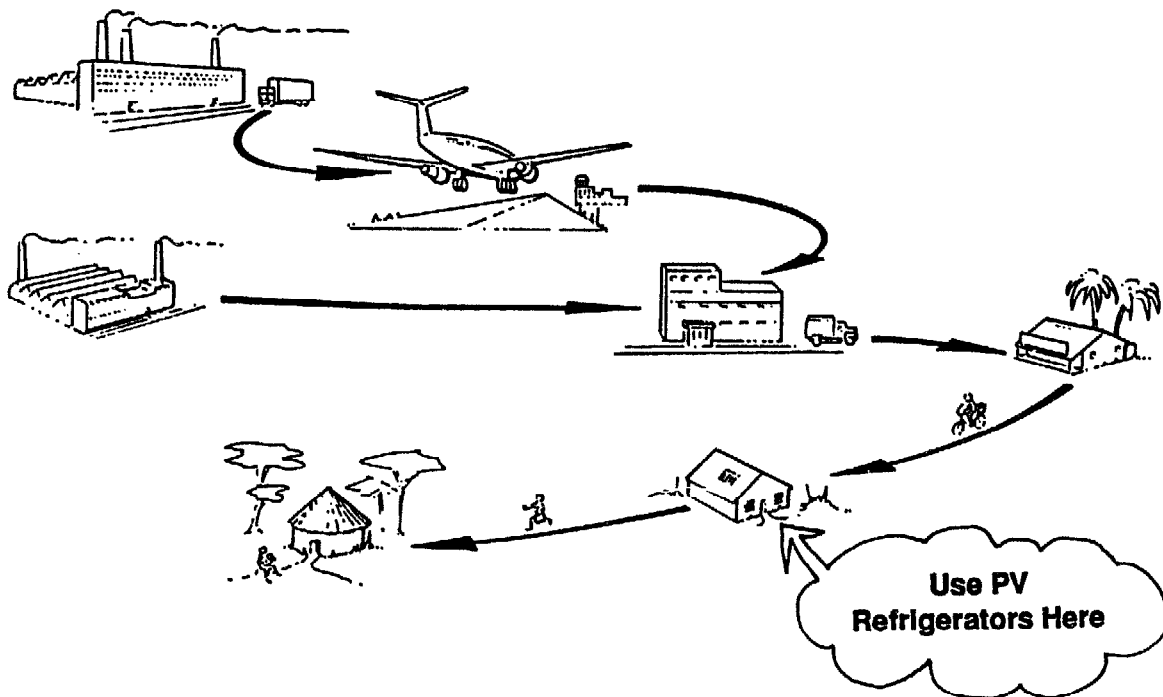

Figure 6.1 The Vaccine "Cold Chain"

6.1.2 International Field Testing and Evaluation Programmes

Much work has been carried out on the field testing and evaluation of PV refrigerators, the most significant being under the World Health Organization's Expanded Programme on Immunization and USAID/NASA/CDC Programmes. These have involved field testing of over 50 systems in more than 30 countries - the first systems being installed in 1981.

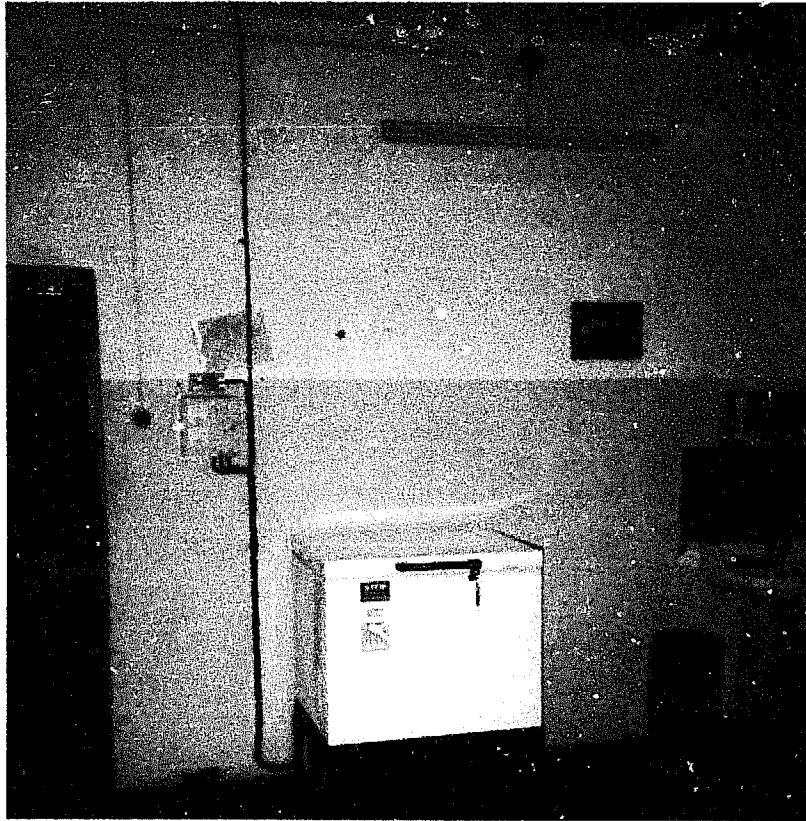

Figure 6.2 One of more than 850 PV Refrigeration and / or Lighting Systems being Manufactured and Installed in Zaire

Field trials organised by the NASA Lewis Research Centre in the USA reported favourable user reaction and that correct operating temperature was achieved for at least 83% of the time. Reasons cited for temperature deviating outside the specified limits were:

- defective components - temperature controls, voltage regulators.
- excessive amounts of warm material being placed in the unit at one time.
- incorrect setting of the thermostat.
- shadowing of the array.

The performance of these early units exceeded the reliability of kerosene refrigerators but was poor in comparison to recently installed systems. Correct operation for over 98% of the time is now routine.

6.1.3 Project Experience

Major programmes to utilize solar refrigerators are underway notably in:

Zaire - The Department of Public Health and Social Affairs in Zaire, with the technical and financial assistance of the European Economic Community (EEC), is carrying out a programme of installing 100 photovoltaic refrigerators (and 750 lighting systems) in rural hospitals and health centres. This operation will equip roughly 400 health establishments spread out over more than 20% of Zaire's territory. A Zairian firm FNMA designed and now produces the refrigerator utilizing imported compressors and batteries.

User reaction has been good, and the systems have demonstrated greater reliability than kerosene fridges. In 1986, the World Health Organization undertook an evaluation of the installations. Their conclusions were very supportive.

Indonesia : More than 100 solar refrigerators are being installed in Sudan as part of a world bank health programme

Mali - over six years of trials have taken place in Mali leading to the conclusion by the Laboratoire de l'Energie Solare that with periodic maintenance checks, the rate of equipment failure is negligible.

Uganda - a project to install initially 100 solar refrigerators and eventually more than 400 systems in Uganda is underway.

Africa - Projects involving significant numbers of solar refrigerators are also now underway in Chad, Ghana, Kenya, Mozambique and Sudan.

Pakistan - In the desert town of Diplo in the Thar desert region of Sind province, a solar refrigerator was installed by UNICEF in 1987. With the enthusiastic support of the health centre staff, the total installation time was less than 5 hours. In addition to UNICEF, other agencies such as the Aga Khan Foundation are using solar refrigerators in Pakistan.

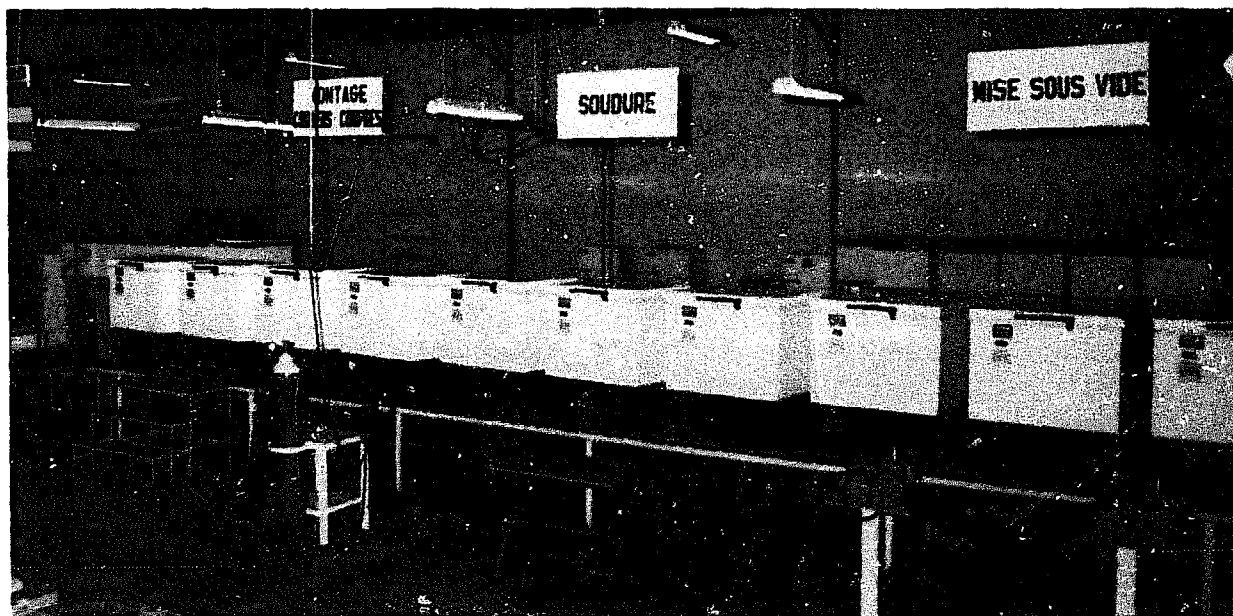

Figure 6.3 PV Refrigerator Assembly in Zaire (FNMA)

6.2 RELATIVE MERITS OF USING PV REFRIGERATORS

6.2.1 Advantages of PV Refrigerators

Compared to kerosene or bottled gas fuelled refrigerators, PV systems have the following advantages:

Improved vaccine storage facilities as a result of:

- elimination of fuel supply problems
- elimination of fuel quality problems
- greater refrigerator reliability
- better refrigerator performance (and temperature control).

Reduced running costs as a result of:

- elimination of kerosene fuel costs
- elimination of kerosene transportation costs
- reduced vaccine losses
- lower refrigerator maintenance costs
- reduced need for back-up refrigerators where there are fuel supply or repair problems.

Cold chain management benefits due to:

- longer equipment life (PV array 15 years, battery 5 years, refrigerator 10 years)
- reduced logistical problems arising from non-availability of working refrigerators and associated vaccine losses.

The above operational advantages of introducing solar refrigerators into the cold chain indicate that solar refrigerators can provide a more sustainable vaccine cold chain.

6.2.2 Disadvantages of PV refrigerators

Failure of a main component, such as the compressor control unit, requires repair or replacement by skilled technicians.

As each system is site specific, more time is necessary for planning and implementing a project with solar refrigerators.

User training demand
overload



6.2.3 Comparative Costs

A true comparison of solar refrigerators and comparable kerosene and bottled gas fuelled refrigerators can only be made through a life cycle cost analysis. A solar photovoltaic refrigerator is likely to cost around \$3000 to \$6000 and will cost more to install than a kerosene unit.

A kerosene refrigerator will cost only \$600-\$800 but will use 0.5 to 1.0 litres of fuel per day, require frequent maintenance and have a shorter life. In general life cycle costs are approximately the same for solar and kerosene refrigerators, but because of their greater reliability and resultant savings in wasted

vaccine solar refrigerators are the preferred option. Table 6.1 shows the relative costs of utilizing a PV or kerosene refrigerator in a health centre in Pakistan, serving a population of 12,000 with a crude birth rate of 4.5%. It can be seen that a PV refrigerator is the most economic option.

	KEROSENE Rs	PHOTOVOLTAIC Rs
Array (125 Wp - 15 yr life)	-	13,047
Battery (2400 Wh - 5 yr life)	-	5,107
Refrigerator	10,400	22,409
Installation Costs	<u>2,880</u>	<u>7,219</u>
Total Installed Cost	13,280	47,864
Annual Maintenance Costs	1,400	479
Annual Fuel Costs (3.08 Rs/Litre)	675	-
Annualised Refrigerator Life Cycle Cost (ALCC)	5,579	8,894
Refrigerator Reliability/Availability	60%	97%
Potent Vaccine Doses Available	3,600	5,820
ALCC per potent vaccine dose	1.55	1.53
EPI Programme Cost per outlet	21,300	21,300
Programme Cost per Potent Vaccine Dose	5.92	3.66
<u>Total Cost per Effective Dose (Rs)</u>	<u>7.47</u>	<u>5.19</u>

Table 6.1 Costs of Photovoltaics vs Kerosene Refrigerators for Vaccine Storage in Pakistan (6,000 Doses/year required at a Health Centre)

6.3 COMMERCIALLY AVAILABLE EQUIPMENT

6.3.1 The Technology

The Refrigerator - Photovoltaic refrigerators operate on the same principle as normal compression refrigerators but incorporate low voltage (12 or 24 v) d.c. compressors and motors, rather than mains voltage a.c. types. A PV refrigerator has higher levels of insulation around the storage compartments to maximise energy efficiency, a battery bank for electricity storage, a battery charge controller and a compressor controller which converts the power from the battery to a form required by the compressor motor.

Typical refrigerator components are shown in Figure 6.6. Most refrigerators include a freezer compartment for ice pack freezing. Other systems have separate units to provide solely for refrigeration or freezing. Sizes available range between 10 and 200 litres of vaccine storage capacity with ice production rates of up to 5 kg per 24 hours.

Batteries - The type most commonly used are lead acid batteries. Long life, deep cycle batteries are preferred. A capacity to run the refrigerator for 5 days without sun is recommended.

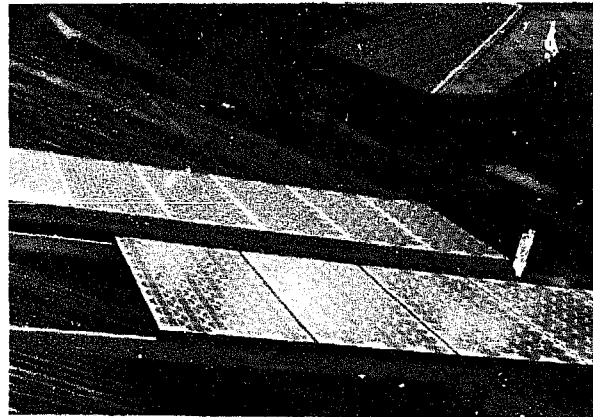

Figure 6.5 PV Array on Rural Health Clinic

Charge Regulator - The regulator maintains the power supply within the current and voltage range tolerated by the refrigerator and prevents overcharge of the battery. Some models include an audible alarm or warning light to signal when battery voltage becomes low. Lightning surge protection must be provided for tropical areas.

Array and Support Structure - The solar array can be for roof (Figure 6.5) or ground mounting. The array size for a refrigeration system is calculated to meet the power requirements for the proposed site. The typical requirement is 150 to 200 Wp of photovoltaic modules.



Figure 6.6 A Typical Solar Refrigerator (R &S)

6.3.2 Performance

Vaccine refrigerators are required to maintain vaccine between +0°C and +8°C at all times. In addition, there is normally a requirement for a separate freezer compartment to freeze ice packs which are used for transporting vaccines in cold boxes.

The performance of a refrigerator or freezer is dependent on the ambient temperature, therefore specifications are usually defined at 32°C and/or 43°C. The following criteria are used to assess performance:

- internal temperature distribution and variation within the permissible range of +0°C to +8°C.
- the rate of icepack freezing in kilograms per 24 hours.
- holdover time during loss of power. This is the length of time for which the internal temperature of the refrigerator will remain below 8°C when the power supply has been disconnected.

For system sizing, the energy consumption per 24 hours in kilowatt

hours, whilst freezing icepacks and/or without icepack freezing is required.

The energy consumption of a PV vaccine refrigerator is typically 300 to 500 Watt hours per 24 hours for a 100 litre refrigerator without icepack freezing and at +32°C ambient temperature. At +43°C ambient temperature and freezing 2 kg of icepacks per 24 hours, the energy consumption of the same refrigerator would rise to about 600 to 1200 Watt hours per 24 hours. It is very important not to overload a solar refrigerator as this increases energy consumption considerably.

A good (well insulated) vaccine refrigerator should be able to maintain correct internal temperatures for at least ten hours in the event of it being disconnected from the battery and solar array.

6.3.3 Costs

The output of a PV array will vary according to the location at which it is to be installed and the refrigerator energy consumption will depend on local climate. Therefore the size of the solar array, the battery storage capacity and hence system cost will vary depending on location. Typical system costs are in the range of US \$3000-\$6000 excluding transport and installation.

6.3.4 Products Available

At the end of this chapter, product information sheets are listed presenting brief details of some commercially available products. The World Health Organization, in its EPI Technical Series, publishes a document entitled "The Cold Chain Product Information Sheets". This catalogues equipment which have undergone tests to verify the performance is of a standard acceptable to the WHO and UNICEF. The document may be obtained from:

The Cold Chain Unit, Expanded Programme on Immunization, World Health Organization, 1211 Geneva 27, Switzerland.

6.4 PROCUREMENT

6.4.1 Assessing Requirements

The points below should be considered when estimating the required refrigerator capacity. Full details are given in the WHO document EPI/CCIS/86.3 - "A Guide to Estimating Capacity of Equipment for Storing and Transporting EPI Vaccines".

It is necessary to delineate the functions required of the system to fulfill the immunization programme. This should take account of:

- the type of vaccine to be used and its required storage temperature
- the population figure targeted for immunization in the area allowing approximately 4 litres storage capacity to fully immunize 150 infants and their mothers
- the frequency at which vaccines are likely to be delivered
- the requirements for icepack freezing (for use in cold boxes)
- storage space required for other medical supplies, eg blood bags
- likely future requirements for approximately 10 years.

From these can be determined:

- vaccine storage capacity required
- ice pack freezing capability required

6.4.2 Selection of Equipment

Selection of the model of solar refrigerator should be made with regard to:

- required vaccine storage capacity and ice production capability
- cost competitiveness
- operating experience of local health sector personnel with the type of equipment being considered
- the local availability of backup services for spares and repairs.

Some technical points to look for are:

- thermostat position (this may be better concealed to prevent unauthorised tampering) and indicators supplied
- batteries - are they sealed? If not, will distilled water be available? do they come with a lockable ventilated battery box or do they fit within the refrigerator cabinet?

6.4.3 Placing the Order

When placing the order, the type of number of spare parts should be specified. The recommended spare parts (per 10 systems) are given below.

SPARE PARTS REQUIRED	QUANTITY / 10 SYSTEMS
1. Photovoltaic modules	2
2. Battery charge regulators	2
3. Battery sets	1
4. Array cables	1
5. Compressor or complete cooling unit, as recommended by the manufacturer	1
6. Spare electronic control cards	3
7. Thermostat or temperature control cards	3
8. Condenser fans (if used)	2

Ensure also that instruction manuals for the user and technician are ordered for the correct language for the country of use.

Purchase of complete system from WHO approved suppliers given in the WHO/ UNICEF Cold Chain Product Information Sheets is recommended.

6.5 IMPLEMENTATION

Documents are available from WHO, Geneva, which are of direct use in implementing a solar refrigeration project. They include:

- (a) "A User's Handbook for PV Refrigerators"
- (b) "Fault Finding and Repair of PV Refrigerators"
- (c) "Installation of PV Refrigerators"
- (d) "Instructor's Notes for PV Refrigerators" (for training courses).
- (e) "Guide to Infrastructure requirements for PV Refrigerators"

Training courses for solar refrigerator technicians are periodically organised by WHO. For information on these contact your local WHO office or WHO, Geneva.

6.5.1 Installation

Ensure:

- the solar array is not likely to be shaded
- the solar array can be easily and safely cleaned
- cable lengths are reduced to a minimum
- the refrigerator is located in the coolest room of the clinic
- there is good air circulation around the refrigerator
- the sun does not shine on the refrigerator
- the batteries are mounted in a well ventilated protective case away from the reach of children.

QUALIFIED REFRIGERATORS

Model	Country	Net Vaccine Capacity (litres)	Gross Freezer Volume (litres)
BP Solar VR50	U.K.	38	5
Dulas V50	U.K.	37	-
Dulas I50	U.K.	-	54
Electrolux RCW42	Luxembourg	14	-
Electrolux RCW42	Luxembourg	-	27
FNMA 75	Zaire	27	13
NESTE - NAPS	Norway	30	2
Polar Products	USA	80	27
SASA 60	Australia	26	11
SET KT180/24	Germany	56	55
Sunfrost RFV - 4	USA	17.5	34
UM Tropic	Germany	30	20

APPROVED SYSTEM SUPPLIERS

Ansaldo	Italy	Noack Solar	Norway
Budimex/FNMA	Belguim	Polar Products	USA
BP Solar	U.K.	Rand S	Netherlands
Chloride Solar	U.K.	Solapak	U.K.
FNMA	Zaire	Solarex	USA
Italsolar	Italy	Telefunken	Germany
Neste - NAPS	Norway	Soltech	Belgium

Table 6.2 WHO Qualified Refrigerators and System Suppliers

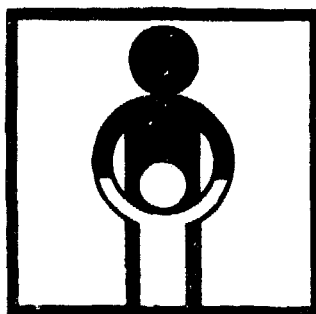

6.5.2 Maintenance

Each day:

- record the temperature in a log book each morning and afternoon
- check the indicator lights for correct operation
- check the ventilation grill is not obstructed.

Each week:

- check the freezer evaporator for build up of ice - defrost if more than 5 mm thick
- clean the solar array.

Each month:

- clean the condenser and compressor with a soft brush
- check for shadowing of array early in the morning and afternoon.

Six monthly:

- check the level of acid electrolyte mixture in the batteries and top up with distilled water if necessary
- check all mountings, fixtures and cables for loose connections
- check the lid seal - if there is a gap between the seal and lid or refrigerator, replace it or glue it back on.

6.5.3 Fault Finding and Repair

It is outside the scope of this handbook to give detailed fault-finding procedures but:

If the refrigerator will not run:

- check the fuse in the compressor controller
- check the array cables

If the refrigerator is too warm but does run:

- adjust the thermostat setting
- check battery state of charge with a voltmeter or hydrometer
- check the refrigerator is not overloaded or that there has been an exceptional persistence of cloud
- check the array is not shaded at times.

If the refrigerator is too cold:

- adjust the thermostat
- check the freezer/refrigerator thermal barrier is not damaged or missing.

EXAMPLES OF PRODUCTS AVAILABLE

VACCINE REFRIGERATORS

Company: BP SOLAR

36 Bridge Street, Leatherhead, KT22 8BZ U.K.

Product: REFRIGERATOR/ICEPACK FREEZER SYSTEM

Includes: PV array and support structure, cable battery, charge regulator, BP VR50 refrigerator/freezer unit, controller and alarms, instruction manual, tools and spares kit.

Performance: @ 32 deg.C ambient temp.:

Ice pack freezing	2.6	kg/10 hrs
Internal temp. range	2-7	deg. C
Holdover time	4	hours

Vaccine Storage Capacity:

Refrigerator	38	litres
Freezer	5	litres

Price: US\$ - depending on insolation and ice needs

\$3,500 - \$6,000

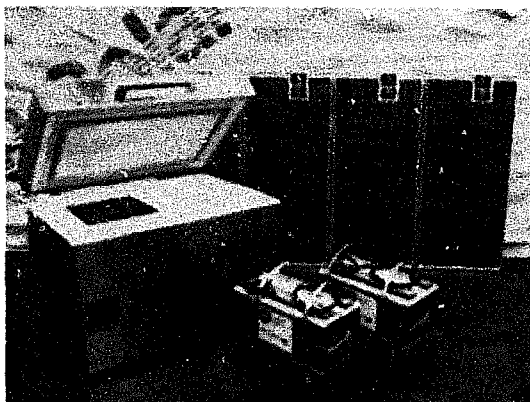

Company: CHLORIDE SOLAR

The Lansbury Est. Knaphill, Woking, Surrey. GU21 2EW. U.K.

Product: MS3: COMBINED VACCINE REFRIGERATION AND LIGHTING SYSTEM

Includes: PV array (288Wp), support structure, FNMA 75 refrigerator/freezer unit, minimum-maintenance (300Ah + 120Ah) batteries, control unit. 8 x 8 Watt fluorescent lights, cables, accessories and installation handbook

Performance: @ 5kWh/m2/Day, and 32°C. ambient temperature:

Ice pack freezing	2.7kg/24hrs
Internal temp range	1 - 7 C.
Holdover time	5.6 hrs

Vaccine Storage Capacity:

Refrigerator	27 litres
Freezer	13 litres (gross)

Lighting: Up to 3 hrs per night from each of the eight lights depending on the refrigerator usage

Price: US\$ 5,740.00

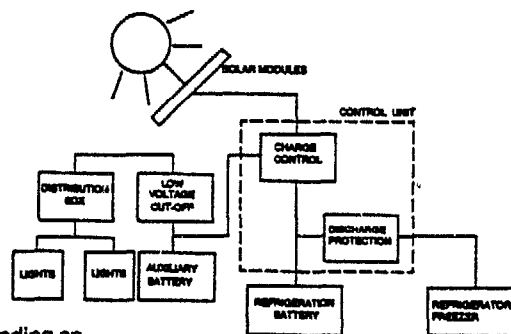

Company: FNMA

14 Rue Limete, BP 1967, Kinshasa 1, Zaire

Product: REFRIGERATOR/ICEPACK FREEZER SYSTEM

Includes: PV array (120 - 160 Wp) and support structure, cable, battery, charge regulator, FNMA 75 refrigerator/freezer unit and instruction manual

Performance: @ 32 deg.C ambient temp.:

Ice pack freezing	2.7	kg/24 hrs
Internal temp. range	1-7	deg. C
Holdover time	5.6	hours

Vaccine Storage Capacity:

Refrigerator	27	litres
Freezer	13	litres (gross)

Price: US\$ - depending on insolation and ice needs

\$3,500 - \$5,000

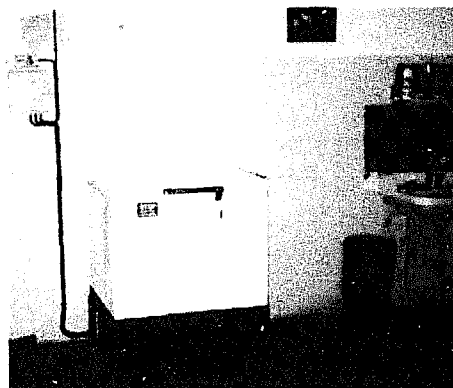

EXAMPLES OF PRODUCTS AVAILABLE

VACCINE REFRIGERATORS

Company: NESTE Advanced Power Systems

Ralssitie, SF - 01510 Vantaa, Finland.

Product: MOBILE PV VACCINE REFRIGERATOR SYSTEM

Includes: PV array (3 x 48Wp), special array structure for mobile use. Sealed batteries in a special box, which includes charge controller Mobile refrigerator CFM49, 49 litre gross internal volume

Performance: @ 32 deg.C ambient temp.:

Ice pack freezing	2.4	kg/12 hrs
Internal temp. range	1 - 8	deg. C (max)
Holdover time	6 - 8	hours

With std solar day of 5kWh/m²/day, it can operate continuously at ambient temperatures of upto 41 deg C (no or occasional icemaking), or up to 25 Deg C with 2.4kg icemaking every day

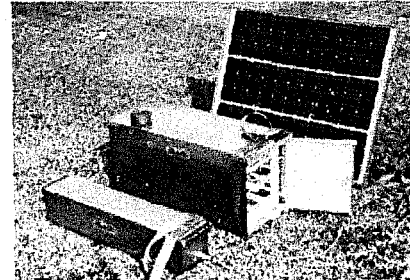

Vaccine Storage Capacity:

Refrigerator	20	litres
Freezer	7	litres (gross)

Price: US\$ \$4,720 (3 module system as above)

Company: POLAR PRODUCTS

2808 Oregon Court, Bldg. 4, Torrance, California, USA

Product: REFRIGERATOR/FREEZER SYSTEM

Includes: PV array (235 - 282 Wp) and support structure, cable, battery, charge regulator, Polar Products refrigerator freezer unit, manuals and thermometer

Performance: @ 32 deg. C ambient temperature:

Ice pack freezing	2.1	Kg/24hrs
Internal temp range	4 - 7	deg. C
Holdover time	4	hrs

Vaccine Storage Capacity:

Refrigerator	80	litres
Freezer	20	litres

Price: US\$ depending on insolation and ice needs. Refer to supplier

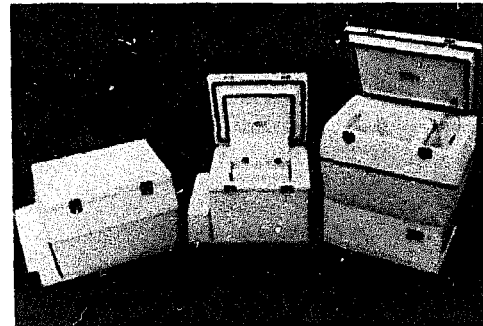

Company: R & S RENEWABLE ENERGY SYSTEMS BV PO Box 45, 5600 AA Eindhoven, Netherlands

Product: REFRIGERATION SYSTEM

Includes: PV array (135 - 180 Wp) and support structure, cable, battery, charge regulator, with low battery alarm and Electrolux RCW42DC refrigerator.

Performance: @ 32 deg.C ambient temp.:

Ice pack freezing	2.1	kg/24 hrs
Internal temp. range	3 - 6	deg. C
Holdover time	4	hours

Vaccine Storage Capacity:

Refrigerator	14	litres
Freezer	7	litres (gross)

Price: US\$ \$3,200 - \$4,200

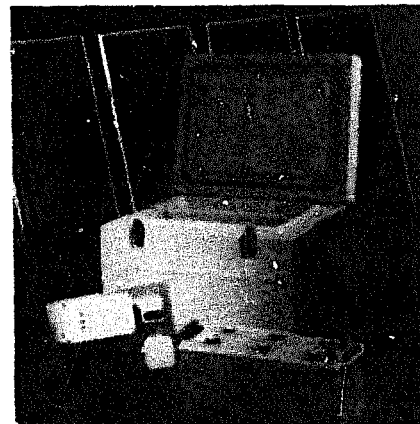

EXAMPLES OF PRODUCTS AVAILABLE

VACCINE REFRIGERATORS

Company: SOLAREX 135 Piccard Dr., PO Box 6008, Rockville, Maryland 20850, USA

Product: REFRIGERATOR/FREEZER SYSTEM

Includes: PV array (168 - 208 Wp) and support structure, cable, battery, charge regulator, Polar Products refrigerator unit, manual, and alarms

Performance: @ 32 deg.C ambient temp.:

Ice pack freezing	2.1	kg/12 hrs
Internal temp. range	4 - 7	deg. C (max)
Holdover time	4	hours

Vaccine Storage Capacity:

Refrigerator	80	litres
Freezer	20+	litres (gross)

Price: US\$ Depending on insolation and ice needs

Refer to supplier

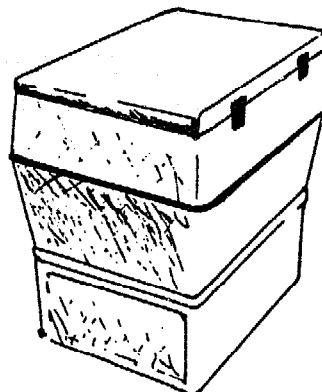

Company: SOLAR ENERGIE TECHNIK Postfach 1180, D-6822, Allflusheim, Germany

Product: REFRIGERATOR/FREEZER SYSTEM

Includes: PV array cable, battery, charge regulator, SET KT 180 (24V) refrigerator/freezer unit two 100Ah batteries, array support and instruction manual

Performance: @ 32 deg. C ambient temperature:

Ice pack freezing	2.4	kg/24hrs
Internal temp range	1-8	deg. C
Holdover time	3.9	hrs

Vaccine Storage Capacity:

Refrigerator	56	litres
Freezer	35	litres (gross)

Price: US\$ Depending on insolation and ice needs.
\$2,600 - \$3,400

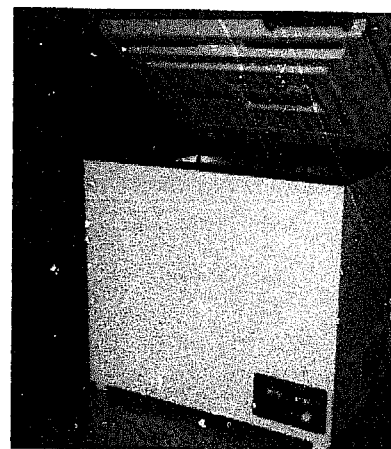

Company: TELEFUNKEN SYS. TECHNIK GMBH Industriestr. 23 - 33, 2000 Wedel, Holstein, Germany.

Product: VACCINE REFRIGERATOR SCS 200

Includes: PV array (180 - 400Wp) incl. support structure and cabling, refrigerator/freezer, electronic temperature regulator, lead acid battery, charge regulator

Performance: @ 32 deg.C ambient temp.:

Ice pack freezing	2.4	kg/24 hrs
Internal temp. range	2 - 7	deg. C
Holdover time	3	hours

Vaccine Storage Capacity:

Refrigerator	56	litres
Freezer	55	litres (gross)

Price: US\$ Refer to supplier

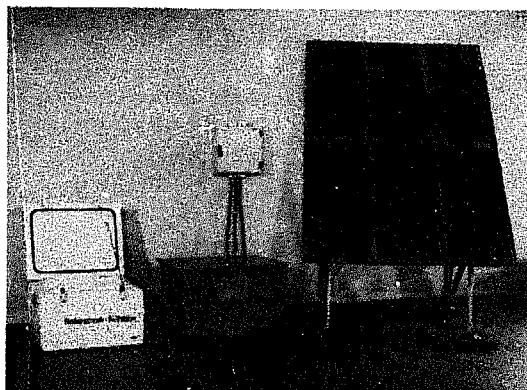

7. LIGHTING

7.1 EXPERIENCE

In terms of number of installations, lighting is presently the biggest application of photovoltaics with tens of thousands of units installed worldwide. They are mainly used to provide lighting for domestic or community buildings, such as schools or health centres. PV lighting is also being increasingly used for security, street and tunnel lighting.

User experiences have been excellent with increasing demand for more systems in the locality where a PV light is installed. Specific examples of lighting experience include:

French Polynesia - Where more than 1000 homes on the islands have been PV powered with anything from 2 to 20 roof mounted modules. The scheme had a 25% grant from the government with the remainder coming from private resources or loans. As a commercial project, the extent of uptake has been high with favourable responses. The users reported PV to be less expensive than diesel.

Dominican Republic - Approximately 70% of the rural population have no access to the utility grid in the Dominican Republic. In 1984, a PV based rural electrification project was set up, using USAID seed money to install PV lighting systems. The income from charging for these systems has allowed further equipment to be bought and the project is now self-financing, with more than 1000 systems now installed.

Thailand - In many villages in Thailand, lighting is achieved by sending automotive batteries into towns for charging and then running 12 volt lamps from the batteries. With Japanese seed funding, the ministry of Rural Electrifications has installed 500 Wp PV battery charging stations. Due to savings on replacement battery, and transportation costs, a PV system will pay for itself in three years or less.

Zaire - Here the Departement de la Sante Publique has been installing 850 PV lighting systems in health centres and clinics, in conjunction with 100 refrigerators. One side effect of the project is that the provision of lighting has given medical staff a significant incentive to work or to continue to work in rural areas, thereby contributing to improved health care services.

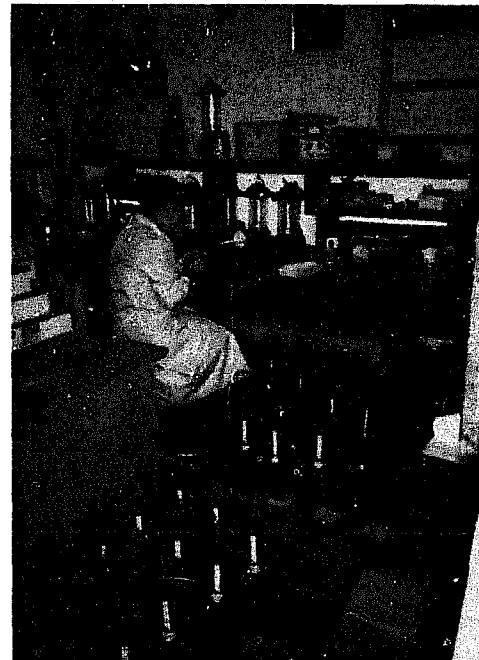

Figure 7.1 PV Light Assembly in Mongolia

Lighting is taken for granted in the industrial countries and in most of the urban areas of developing countries. In areas without access to mains electricity, lighting is restricted to candles or kerosene lamps. Torches (or flashlights) powered by expensive, throw-away dry-cells are used intermittently as a portable source of light.

7.2 RELATIVE MERITS

Common means of lighting where mains electricity does not exist, or is impractical, include:

- candle
- kerosene lamp
- kerosene hurrican lamp
- diesel generator for electric lamps
- automotive batteries for electric lamps

Kerosene lamps and candles have the obvious drawback of producing only a low light output and being a fire hazard. They do, however, have the lowest purchase price, but are expensive and inefficient to run. In comparison the convenience, relative safety and brightness of the electric light is generally accepted as preferable. The use of fluorescent lamps rather than filament lamps is necessary for efficient use of the electricity.



Figure 7.2 PV Lighting Kit

The output and power use efficiency of lamps are summarised in Table 7.1.

TYPE OF LIGHT	ENERGY SOURCE	INTENSITY (LUMENS)	POWER USE EFFICIENCY (LUMEN/WATT)	USE PV?
candle	parraffin wax	1	.01	NO
kerosene lamp (wick)	kerosene	10	.1	NO
hurricane lamp (wick)	kerosene	100	.2	NO
oil lamp (mantle)	Kerosene	1000	1	NO
gas lamp (mantle)	butane	1000	1	NO
filament lamp 3W	dry batteries	10	3	NO
filament lamp 40W	electricity	400	10	NO
flourescent 15W	electricity	600	40	YES
20W	electricity	1000	50	YES
mercury 80W	electricity	3200	40	YES
sodium SOX 35W	electricity	4500	128	YES

Table 7.1 Lamps: Power and Efficiency

The relative merits of providing light by diesel generators, battery recharging and photovoltaics is given in Table 7.2.

System	Advantages	Disadvantages
Diesel Generators	<ul style="list-style-type: none"> ● widespread operating and maintenance experience ● moderate capital cost ● easy to install ● can be combined power supply for additional uses 	<ul style="list-style-type: none"> ● creates noise and fume pollution ● require a reliable fuel supply ● high running costs ● high maintenance costs ● low operating efficiency often achieved
Automotive Battery Recharging	<ul style="list-style-type: none"> ● low capital cost ● easy to install ● batteries locally available 	<ul style="list-style-type: none"> ● relies on transporting to charging stations ● high charging fees often apply ● short battery lifetimes
Photovoltaics	<ul style="list-style-type: none"> ● high reliability ● low maintenance requirements ● low running costs ● suited to most locations ● long life expectancy for main components 	<ul style="list-style-type: none"> ● involves the introduction of a new and often poorly understood technology ● high capital cost ● spares not widely available ● not physically robust so vulnerable to damage ● specialised batteries not widely available

Table 7.2 Comparison of Power Sources for Electric Lighting

Even though individual PV lamps may be more expensive to buy initially, in general they are cost-effective on a life-cycle cost basis, compared to kerosene lighting and in addition provide a better quality light. The relative economics of PV versus kerosene lighting is shown in Table 7.3.

CONVENTIONAL	PHOTOVOLTAIC
Weekly Fuel Requirements:	Weekly Energy Requirements:
Kerosene Pressure Lamp = 2.8 litres	Fluorescent Lamps 2 x 8 W
Hurricane lamp = 1.2 litres	= 64 Wh
	But battery charging efficiency is only 80%, hence requirements = 80 Wh
Weekly Energy Costs:	
Kerosene at \$0.3 Litre \$ 1.20	Average Daily Insolation 5 kWh/m ²
	Required Array Size 18 Wp
Annual Total \$ 62.40	Capital Costs: \$150.00
Capital costs:	PV Array
Pressure lamp \$ 20.00	Battery (100 Ah x 12 v) \$140.00
Hurricane Lamp \$ 5.00	Flourescent Lights (2) \$ 34.00
	Voltage Regulator \$ 50.00
Total \$ 25.00	Total \$374.00
Recurrent Costs:	Recurrent Costs:
Present Worth of Fuel Discounted at 10% over 15 yrs = \$62.4 x 7.61 = \$475.00	Battery (replace 5 years) PW = \$141.00
	Tubes (replace 2 yrs) PW = \$ 28.00
	Voltage Regulator (replace 8 yrs) PW = \$ 24.00
	Total \$193.00
Lamps are replaced every 2 years. Present Worth Of Replacements = \$ 95.00	
Total Life Cycle Costs (15 years) = \$25.00 + \$475.00 + \$95.00 = \$595.00	Total Life Cycle Costs (15 years) = \$374.00 + \$193.00 = \$567.00
Annualised LC Cost = \$ 7 8.00	Annualised LC Cost = \$ 74.00

Table 7.3 Life Cycle Cost Comparison of Conventional and PV System

The use of photovoltaic systems for lighting should therefore be considered where:

- kerosene fuel supplies are erratic or expensive;
- good quality lighting is required (eg, in schools and home industries - such as needlework)
- solar irradiation levels are moderate to high (>3 kWh/m²/day).

7.3 COMMERCIALLY AVAILABLE EQUIPMENT

7.3.1 Applications

PV lighting systems can broadly be categorised as suitable for use in one of the following applications:

- domestic or community building lighting (homes, schools, community centres, mosques, churches)
- street, area or security lighting (car parks, industrial areas, warehouses)
- portable light units.

Specialised commercial lighting such as terrain avoidance lighting for aircraft and other navigational aids are briefly described in Chapter 9.

7.3.2 The Technology

The main difference between photovoltaic and other electric lighting systems is that a d.c. supply is produced, thus the use of d.c. lights is preferred. A.c. lights may be used by incorporating an inverter into the system, but this will introduce significant additional electrical losses, hence a larger array will be needed.

Many d.c. lights are now commercially produced, but the most efficient in terms of light output (lumens) per watt of power consumed are low voltage fluorescent tubes. If these are not available, conversion of a.c. tubes is possible by changing the a.c. starter and ballast components to produce a d.c. version. Figure 7.3 shows common types of d.c. lights for use with PV systems.

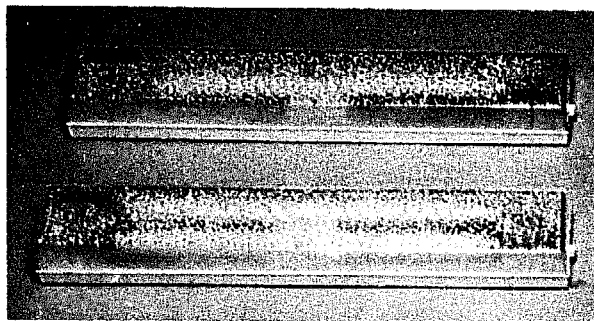

Domestic or Community Building Lighting

Usually systems are dedicated for use in one building, normally providing one or two lights, but often up to about eight lights. Complete system packages are available, comprising of:

- PV array including one or two modules and mounting structure;
- fluorescent lights usually 8 W, 13 W, 16 W or 20 W;
- battery
- charge control regulator;
- cabling, installation tools.

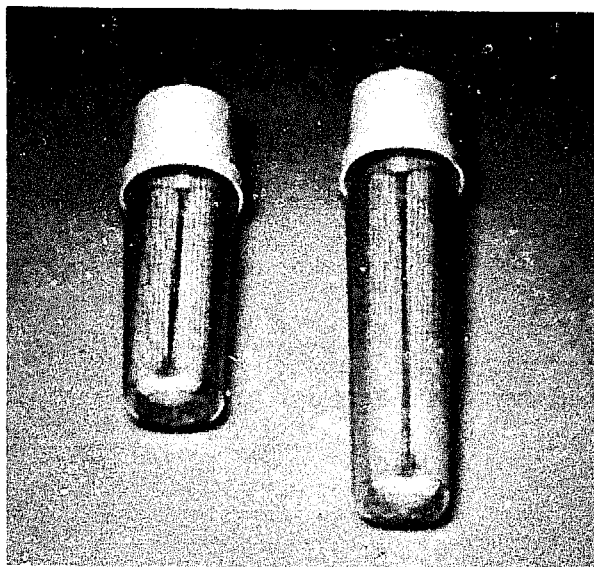

Figure 7.3 12 Volt Fluorescent lamps

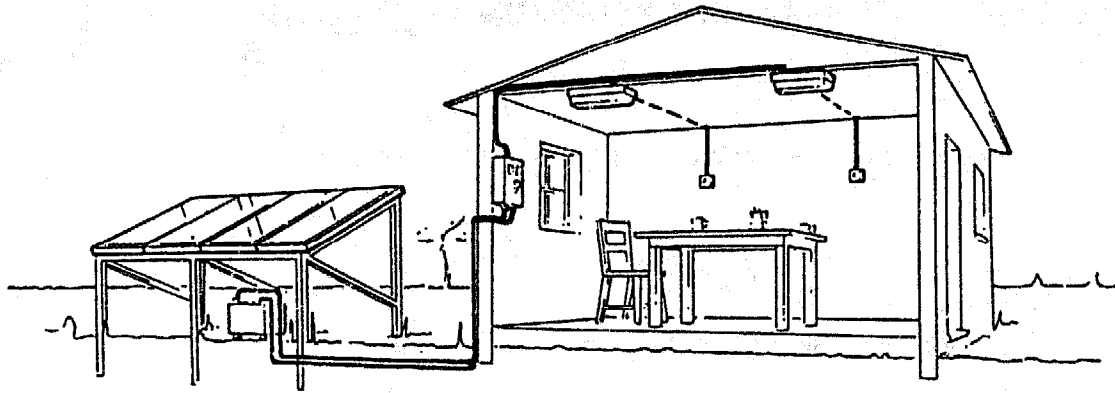

Figure 7.4 Typical PV Lighting System

Street, Area or Security Lighting

Specific systems, usually pole mounted, have been developed for this purpose and typically include:

- PV modules; (typically 40 - 120 Wp)
- support structure - (usually pole-mounted);
- battery;
- lamp - generally d.c. fluorescent tubes, low pressure sodium or mercury vapour lamps;
- controller - including charge regulation and optional automatic on/off switching (set by timer or light sensitive switch).

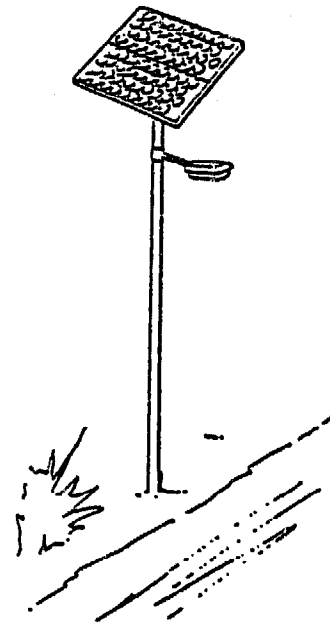

Figure 7.5 Area or Security Light

Portable Lighting Systems

Small systems have been designed to be easily carried by hand. One model developed with user acceptability in mind has a hand lamp based on the conventional kerosene lamp design, but fitted internally with a fluorescent tube. Many systems combine PV module, battery and lamp in an integral unit, whilst others have a detachable PV module.

Typical specifications:

array size:	4-10 Wp
lamp:	4-8 Watts
performance:	3-5 hours/day

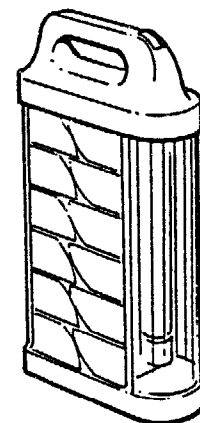

Figure 7.6 Portable Light with Integral PV Cells

7.3.3 Costs

Typical costs for the three applications of lighting considered are shown below. It should be noted that in all cases, although the PV option is higher capital cost, the life cycle cost is lower than in comparison to kerosene systems.

APPLICATIONS	SYSTEM	INITIAL CAPITAL COST \$
Home or Community Building	1 x 20 Wp PV Module 2 x 8 Wp fluor. lamps	430
Security Light	2 x 40 Wp PV module 2 x 20 Wp fluor. lamps pole mounting battery & regulator	1600
Portable Light	5 Wp of PV module 6 W fluor lamp 15 Wh sealed battery	150

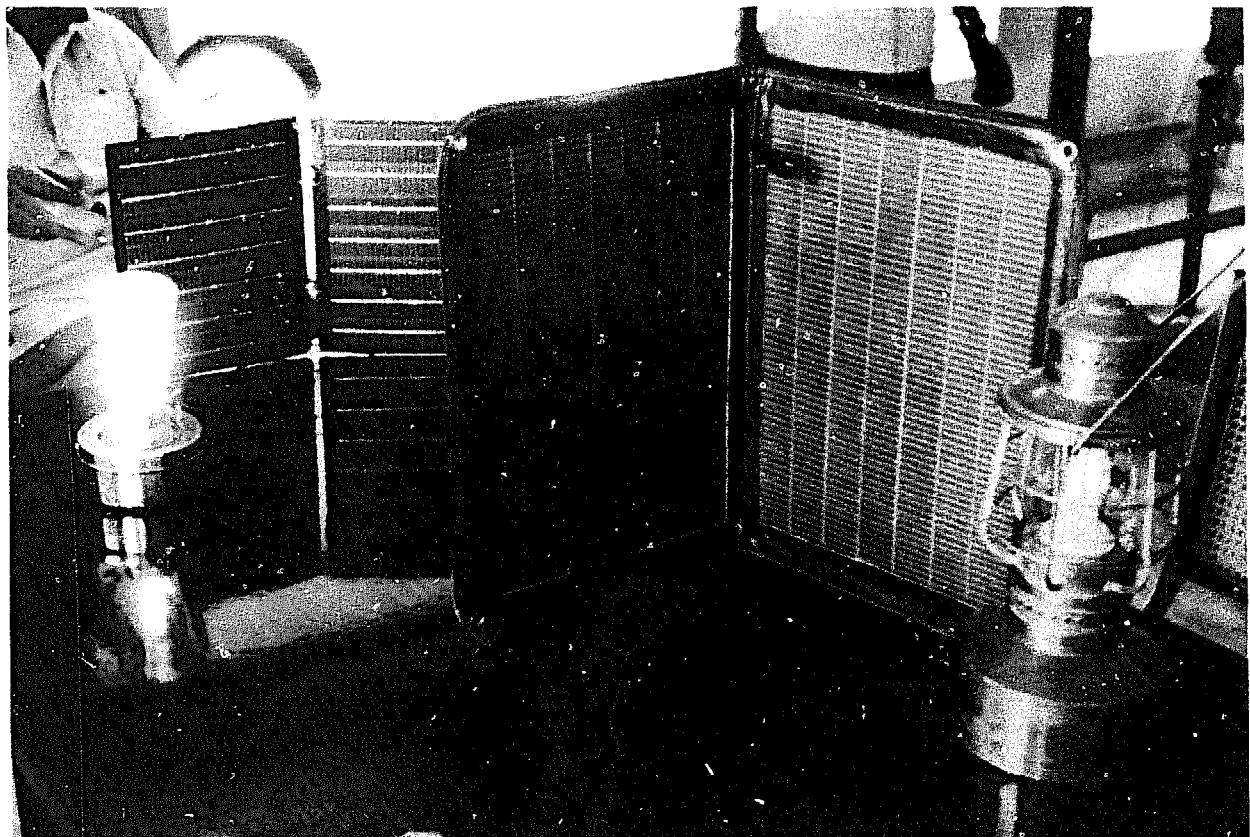

Figure 7.7 Portable PV Lighting Systems (Suryovonics, India)

7.3.4 Products Available

There are many types of PV lighting products available. Details of some typical products are given at the end for this section. In fact, almost all the suppliers listed in this book are able to supply lighting systems.

7.4 **PROCUREMENT**

7.4.1 Assessing Requirements

The requirements of a lighting system should be appraised in terms of:

- quality and intensity of light required
- number of lights and their proposed location
- daily hours of operation
- the anticipated pattern of use of the lighting system
- how requirements may change and future demands.

It is preferable to over-estimate demand but financial resources often prove to be the limiting factor. It is important to look at the overall system and operating procedure when designing the system configuration, eg:

- if several lights are required in dispersed locations, it may be better to use
- several small systems rather than one large;
- portability of lights may be a requirement;
- automatic switching of outside lighting or timers may be required.

A pro-forma sheet for determining the approximate system sizing required is given in Table 7.6. An example is shown below in Table 7.5. If specific component efficiencies are not available, battery and regulator efficiencies of 0.8 and 0.9 respectively should be used.

Requirements:	=	one 8 W lamp plus one 20 W lamp for 4 hours per day
Insolation level:	=	4 kWh/m ² /day
System nominal voltage:	=	12V
Maximum Battery Discharge	=	20%
Energy consumption	=	(8W x 4h) + (20 W x 4h)
	=	112 Wh/day
Array Load	=	112 / (battery and regulator efficiency)
	=	112 / (0.8 x 0.9)
	=	155 Wh/day
Array Size	=	Array Load/(Insolation x mismatch factor)
	=	155 / (4 x 0.85)
	=	46 Wp
Battery Size	=	$\frac{\text{Daily lamp consumption}}{\text{Max. discharge} \times \text{nominal voltage}}$
	=	112/ (0.20 x 12)
	=	47 Ah

Table 7.5 Example of Simple System Sizing

SIZING PV LIGHTING SYSTEMS

1. How many and what size of lights are required?
- 2.. How many hours of lighting are required each day?

3. Calculate daily energy consumption:

- a) lamps at Watts, for hours = Wh
- b) lamps at Watts, for hours = Wh
- c) lamps at Watts, for hours = Wh

Total daily energy consumption = Wh

4. Calculate PV array daily energy load:

$$\begin{aligned} \text{Array load} &= \frac{\text{daily energy consumption}}{\text{battery effic.} \times \text{charge regulator effic.}} \\ &= \dots\dots\dots \text{ Wh} \end{aligned}$$

5. What is the average daily insolation in the lease sunny month?

6. Calculate PV array size required from:

$$\text{array size} = \frac{\text{Array load}}{\text{insolation} \times \text{mismatch factor (mismatch factor} = 0.85)}$$

7. Calculate minimum battery capacity

$$\begin{aligned} \text{Battery Capacity} &= \frac{\text{daily energy consumption}}{\text{max. allowable discharge (\%)} \times \text{nominal voltage}} \\ &= \dots\dots\dots \text{ Ah} \end{aligned}$$

Table 7.6 Pro Forma for PV Lighting Systems

7.4.2 Equipment Selection

Unless there is good reason for doing otherwise, equipment should be purchased as a complete package from one supplier. The components included in the package will vary from supplier to supplier. Points to look for when comparing systems include:

- array size in Wp;
- number of lights provided;
- the output (in lumens) of the lights per Watt of energy consumption and estimated hours of use per day;
- if switching for the lights is included;
- type of support structure, if included, and its suitability for proposed site;
- ease of installation with tools and facilities available;
- battery capacity in ampere hours;
- maximum permissible depth of discharge of the battery;
- controller functions (automatic load disconnection at low battery voltage is recommended and lighting protection is essential for tropical regions);
- sufficient cable lengths and wall fixings.

7.5 IMPLEMENTATION

7.5.1 Installation

PV lighting systems are generally easy to install because normally they only require one or two modules, which may be roof mounted, pole mounted, or, for small systems, hung on walls or porches. The module should face the equator and be tilted at an angle recommended by the supplier (approximately latitude plus 10 degrees).

This ease of installation presents one major problem in that they are easy to remove and hence vulnerable to theft (if not integral in a lantern). Except for portable systems, a secure roof mounting fixture is thus preferred.

The battery should be located in a ventilated locked battery box. It should be out of the reach of children. This is very important in a domestic installation.



Figure 7.8 Lighting in a Rural Health Clinic

7.5.2 Maintenance

The principal maintenance requirements will be to:

- clean the PV module(s) each week (if accessible)
- check cables and connections weekly
- check the battery electrolyte level monthly.

If the battery electrolyte requires topping up, it is essential to use distilled water.

7.5.3 Fault Finding and Repair

If the light does not work at all:

- check the fluorescent tube on another 12 volt battery.

If the light comes on but for fewer hours than expected:

- check the battery state of charge
- check for loose connections.

If the battery is completely discharged, check the fuse in the charge regulator (if fitted). The battery may be recharged by disconnecting the lamp for a few days (to allow the battery to be recharged by the modules). Alternately, the battery can be taken to the nearest town for commercial recharging.

EXAMPLES OF PRODUCTS AVAILABLE

DOMESTIC AND COMMUNITY LIGHTING SYSTEMS

Company: BP SOLAR 36 Bridge Street, Leatherhead, KT22 8BZ, UK

Product: DOMESTIC OR COMMUNITY LIGHTING

Includes: A complete kit with self regulating 40Wp PV module, support structure for roof or ground mounting, 4 x 8W fluorescent lights with 10m of cable, pre-wired plug and socket connections, distribution box, installation fastenings and instruction manual



MODEL NO.	ARRAY Wp	LIGHT HOURS/DAY	PRICE U.S. \$
Lighting kit	40	16hr @ 5kWh/m ² /d	580

Company: BP SOLAR ESPANA Calle Primera Valportillo 5, Alcobendas, Madrid, Spain

Product: DOMESTIC OR COMMUNITY LIGHTING

Includes: A complete package with 45W module, support structure for roof or ground mounting, 3 x 15W and 1 x 9W lights, 10m of cable, accessories and manual

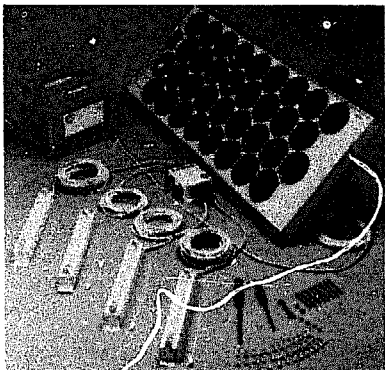

MODEL NO.	ARRAY Wp	LIGHT HOURS /DAY	PRICE U.S. \$
L-PAK	45	4.5 hrs @ 5kWh /m ² /day 6.0 hrs @ 7kWh/m ² /day insolation	720

Company: CHLORIDE SOLAR, The Lansbury Estate, Knaphill, Woking, Surrey, GU21 2EW U.K.

Product: DOMESTIC AND COMMUNITY LIGHTING SYSTEM

Includes: Self regulating 43 Wp PV module, support structure, 105Ah battery and home lighting kit comprising 3 x 8W fluorescent lights, distribution box with three light switches and low voltage cut out, plugs, connectors, 2 x 5m cables, 3 x 10m cables, 1.5m battery cable, fuse, terminals, clips and screws

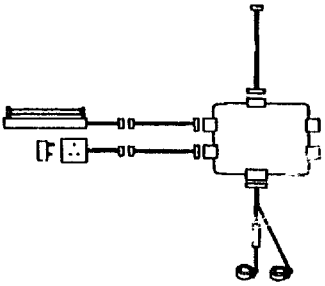

MODEL NO.	ARRAY Wp	LIGHT HOURS /DAY	PRICE U.S. \$
LK1	43	7 hrs @ 5kWh /m ² /day	594

Company: HELIOS TECHNOLOGY 1 - 35015 Galliera Veneta, (PD), Via PO, 8, Italy

Product: DOMESTIC OR COMMUNITY LIGHTING SYSTEM

Includes: One PV module, control unit, 4 x fluorescent lamps, 100Ah battery, installation fittings and handbook

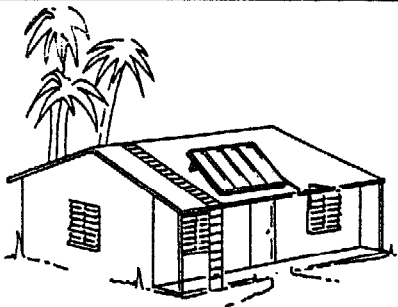

MODEL NO.	ARRAY Wp	LIGHT HOURS /DAY	PRICE U.S. \$
M 40	40	6 hrs @ 5 kWh/m ² /day	Refer to supplier

EXAMPLES OF PRODUCTS AVAILABLE DOMESTIC AND COMMUNITY LIGHTING SYSTEMS

Company: IBC

Am Kreuzberg 5, PO Box 1107, D- 8628 Staffelstein, Germany

Product: DOMESTIC LIGHTING SYSTEM

Includes: Complete kit with PV module, support structure, 2 x 8 W fluorescent lights, 15m cables, 12v, 50Ah battery, switch, junction box, fittings and manual

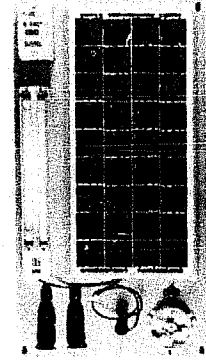

MODEL NO	ARRAY Wp	LIGHT HOURS/DAY	PRICE U.S. \$
4050	11	3 hrs	395
4055	24	8.5 hrs	450

Company: KYOCERA

Chiba Sakura, 4-3 Ohsaku 1- Chome Sukura Shi, Chiba 285 Japan

Product: COMMUNITY BUILDING LIGHTING SYSTEM

Includes: PV Module, structure, battery, controller 2 x 20W fluorescent lamps and manual

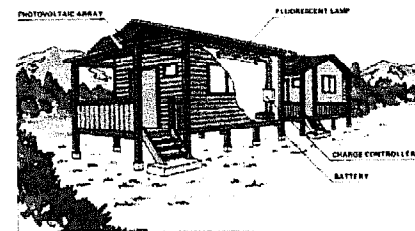

MODEL NO.	ARRAY Wp	PERFORMANCE	PRICE U.S. \$
KLK 41	96	4 hrs @ 4kWh/m2/day 7 hrs @ 5kWh/m2/day 8 hrs @ 6kWh/m2/day	2,500

Company: NESTE Advanced Power Systems

Ralsitie, SF-01510 Vantaa, Finland

Product: LIGHTING SYSTEMS

Includes: PV modules mounting brackets, control unit, battery, switches and cables plus 4 x 13W fluorescent lamps and one 10W spotlight per module

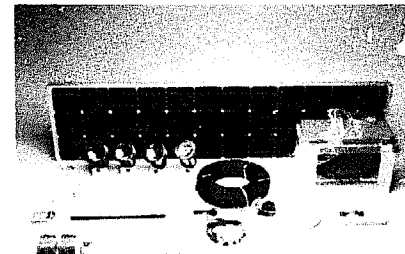

MODEL NO.	ARRAY Wp	LIGHT HOURS /DAY	PRICE U.S. \$
LK 1 1 module	48	180 Wh available per day	630
LK 2 2 modules	96	360 Wh available per day	1050
LK 3 3 modules	144	540 Wh available per day	1475

Company: SOLAPAK LTD

Factory 3, Cock Lane, High Wycombe, Bucks HP13 7DE U.K.

Product: DOMESTIC OR COMMUNITY LIGHTING SYSTEM

Includes: Modules, support structure, regulator, 60Ah battery and enclosure, 1050 Lumen fluorescent lamp (s)

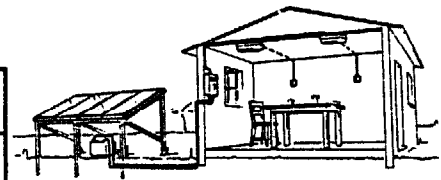

MODEL NO.	ARRAY Wp	LIGHT HOURS /DAY	PRICE U.S. \$
A53-1 lamp	53	@ 5 kWh/m2/d insolation 4 hrs	800
A106-1 lamp	106	8 hrs	1,300
B106-2 lamps	106	4 hrs	1,400

EXAMPLES OF PRODUCTS AVAILABLE STREET AND AREA LIGHTS

Company: BP SOLAR

36 Bridge Street, Leatherhead, KT22 8BZ, U.K.

Product: STREET LIGHTING SYSTEM

Includes: 2 PV modules, 4.5m pole, 200 Ah battery, electronic control unit, 8W or 35W sodium lamps

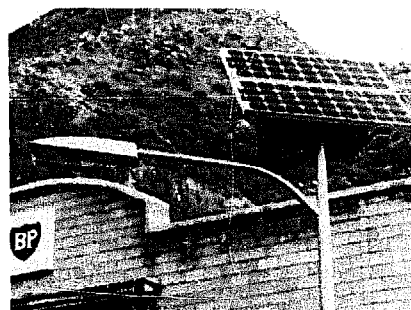

MODEL NO.	ARRAY Wp	LIGHT HOURS/DAY	PRICE U.S. \$
SL 90	90	10 hrs @ 4kWh/m ² /d	2,765
SL 110	110	10 hrs @ 4kWh/m ² /d	3,250

Company: IBC

Am Kreuzberg 5, PO Box 1107, D-8623 Staffelstein, Germany

Product: STREET LIGHTING SYSTEM

Includes: 2 PV modules, 5 m pole, 100 Ah battery, electronic control unit, 18W sodium lamp.

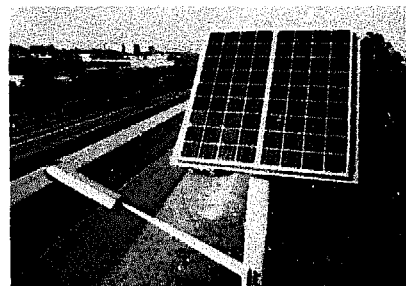

MODEL NO.	ARRAY Wp	PERFORMANCE	PRICE U.S. \$
4080	96	12 hrs @ 5kWh/m ² /day	2,280

Company: SOLTECH

Boekterheide 30 - 3550 Zolder, Belgium

Product: STREET LIGHTING SYSTEM

Includes: PV modules, pole, battery, charge and load controller, 18W fluorescent lamp

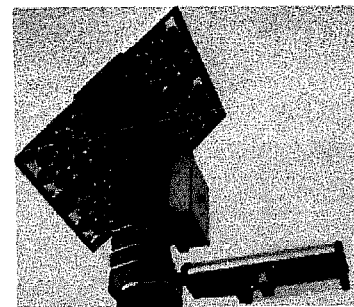

MODEL NO.	ARRAY Wp	LIGHT HOURS /DAY	PRICE U.S. \$
SL 80	80	12 hrs @ 5kWh/m ² /day	from 1,600

Company: TOTAL ENERGIE

7 Chemin du Plateau, ZI Le Tronchon, 69570, Dardilly, France

Product: SOLAR LAMP POST

Includes: 2 PV modules, 3.5m aluminium pole, 200Ah battery electronic control unit, 11W fluorescent lamp or 18W sodium on LP 90-s)



MODEL NO.	ARRAY Wp	LIGHT HOURS /DAY	PRICE U.S. \$
LP45	45	6 hrs @ 5kWh/m ² /day	2,000
LP90	90	12 hrs @ 5kWh/m ² /day	2,600
LP90-S	90	12 hrs @ 5kWh/m ² /day	3,000

EXAMPLES OF PRODUCTS AVAILABLE PORTABLE LAMPS

Company: **BP SOLAR** 36 Bridge Street, Leatherhead, KT22 8 BZ U.K.

Product: **PORTABLE LANTERN**

Includes: **10 Wp PV panel, nickel-cadmium battery and 8W fluorescent light all in a moulded plastic case. The total weight is 4 kg**

MODEL NO.	ARRAY	LIGHT HOURS / DAY	PRICE U.S. \$
SL48	10	5.0 @ 7kWh/m ² /d	300

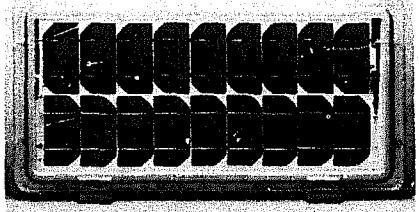

Company: **CHRONAR FRANCE** 3 alle E. L'heureux, 94340 Joinville - Le Pont, France

Product: **PORTABLE LANTERN**

Includes: **9W PV module, 9w fluorescent lamp and battery in conventionally styled lantern with rugged case**

MODEL NO.	ARRAY Wp	LIGHT HOURS/DAY	PRICE U.S. \$
AFRICA	9	5 hours @ 5kWh/m ² /day	130



Company: **NESTE Advanced Power Systems** Ralssitie, SF - 01510 Vantaa, Finland

Product: **PORTABLE LANTERN**

Includes: **Detachable 5W PV module, light and battery in robust container with 12V output socket for other devices**

MODEL NO.	ARRAY Wp	LIGHT HOURS DAY	PRICE U.S. \$
BEDOQUIN	5	5hrs @ 3.3 kWh/m ² /d	170

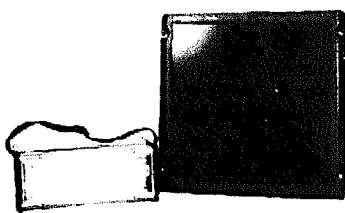

Company: **SOLTECH** Boekterheide 30, 3550 Zolder, Belgium

Product: **PORTABLE LAMP**

Includes: **10 Wp PV module, 6Ah battery with charge controller and two fluorescent lamps in a conventinally styled lantern**

MODEL NO.	ARRAY Wp	LIGHT HOURS / DAY	PRICE U.S. \$
Lantern	10	4 - 8 Hours	300



8. RURAL TELECOMMUNICATIONS

8.1 EXPERIENCE

Small scale communications systems can play an important role in rural development, those of most relevance are radio transceivers, radio telephone links, radio receivers, community television and public address systems. To operate they need a small, but reliable power supply. Photovoltaics is an ideal power supply for these applications. A significant number of systems have already been installed almost always with good user responses. In fact, the level of use of the equipment has often far exceeded expectations.

Specific examples include:-

The Jungle Aviation and Radio Service (JARS): USA has shipped more than 1000 PV systems to development workers throughout the developing world.

Panama: At Boca del Monte, a radio station is powered by a 180 Wpk array. The cost of the PV modules, transmitter, studio equipment, fan and lights was less than \$3000.

Liberia: At ELRB radio station in Monrovia, a 360 Wp PV array provides power for lighting, ventilation and standby transmitters.

India: More than 250 community television systems have been installed in India, under the National Solar PV Energy Demonstration Programme. Many of the systems were combined with community lighting to provide a range of educational activities.

Gambia: In the Gambia, VHF transceivers are being used to provide communication of urgent information between health centres.

Pan Africa: The Panaftel telecommunications network has seen increased availability since the introduction of PV on key repeaters.

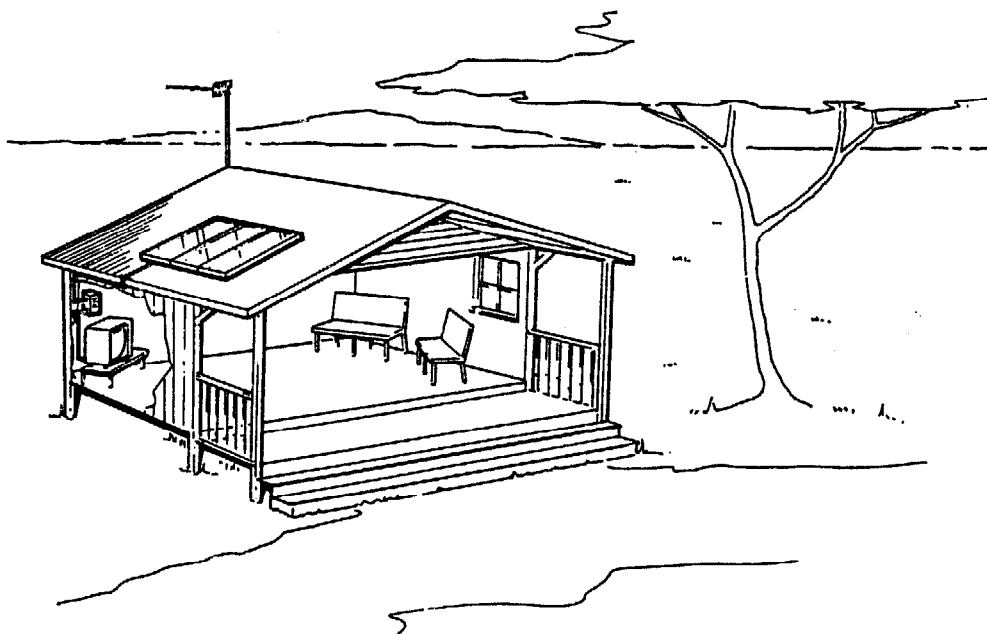

Figure 8.1 Community Centre with PV Operated Television

8.2 RELATIVE MERITS

PV has several attributes which make it particularly suited to telecommunications applications. They include:

- reliability - PV systems are the most reliable power source;
- size - PV systems can be sized to provide the relatively small amounts required for transmission and receipt of signals;
- unattended operation - PV systems will operate for long periods with little or no maintenance;

8.3 COMMERCIALLY AVAILABLE SYSTEMS

8.3.1 The Technology

Suppliers are packaging systems for use in a range of applications, namely:

Radio receivers - radios of 1.5 to 20 Watts output are available. The solar module typically 1-2 Wp may be incorporated into the side of the radio or more commonly a separate module is used with connection via an extendible lead. The battery and charge regulator are integrated into the radio.

Television receivers - comprising array, batteries, charge regulator and TV.

Public address loud speaker systems - pole mounted array and loud speaker with battery, charge controller, amplifier and microphone.

Radio Transceivers - typical systems incorporate a 100 W transmitter, 30-50 Wp PV array, 105 Ah 12 volt battery and transceiver equipment. The solar array is sometimes pole mounted on the antennae of the transmitter.

Due to the wide range of different receivers and transmitters available or specified by users, it is common for PV companies to offer solar powered battery charging systems suitable for 12 Volt telecommunication equipment.

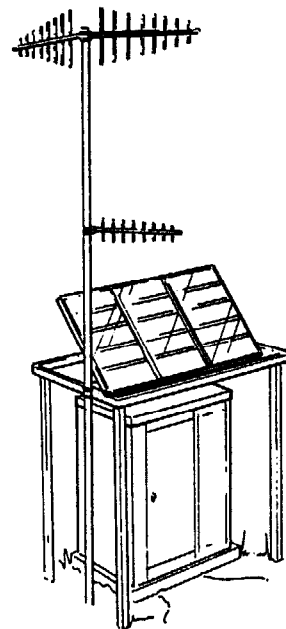

Figure 8.2 PV Powered Radio Telephone System

8.3.2 Costs

Typical complete system costs are given in Table 8.1.

System	Performance	Price \$
Radio:	1.5 Watts output	75
	20 Watts output	500
Transceiver:	100 Watts	3000
TV System:		2000
Public Address System:	100 Watts	3000

Table 8.1 Typical Costs of Small PV Telecommunications Systems

8.4 **PROCUREMENT**

8.4.1 Assessing Requirements

This should principally cover two areas, the telecommunication functions required of the equipment, taking account of likely changes in future needs and the daily usage levels in operating hours per day and number of users.

It should be noted that some equipment will have different power consumption levels when receiving, transmitting and on standby. Hence, if it is necessary to source the telecommunications equipment separately from the photovoltaic power supply, careful consideration of daily energy consumption should be made.

Having determined the average daily energy load in watt-hours, the PV array and battery sizes can be determined in the same manner as for a lighting load (steps 6 and 7 on Table 7.6).

8.5 **IMPLEMENTATION**

8.5 Installation

The principal considerations to be given which are specific to the installation of PV powered telecommunication equipment are:

- adequate lightning protection for the telecommunications equipment;
- ensure the antennae of the transmitter (or anything else) does not shade the array.

Maintenance

The recommended maintenance of PV powered telecommunications equipment includes:

- clean the solar array weekly (if accessible)
- check battery electrolyte level monthly and top up with distilled water, if necessary.

Fault Finding and Repair

The suggested fault finding and repair of the PV array and battery power supply is the same as that described for lighting systems in Section 7.5 of this guide.

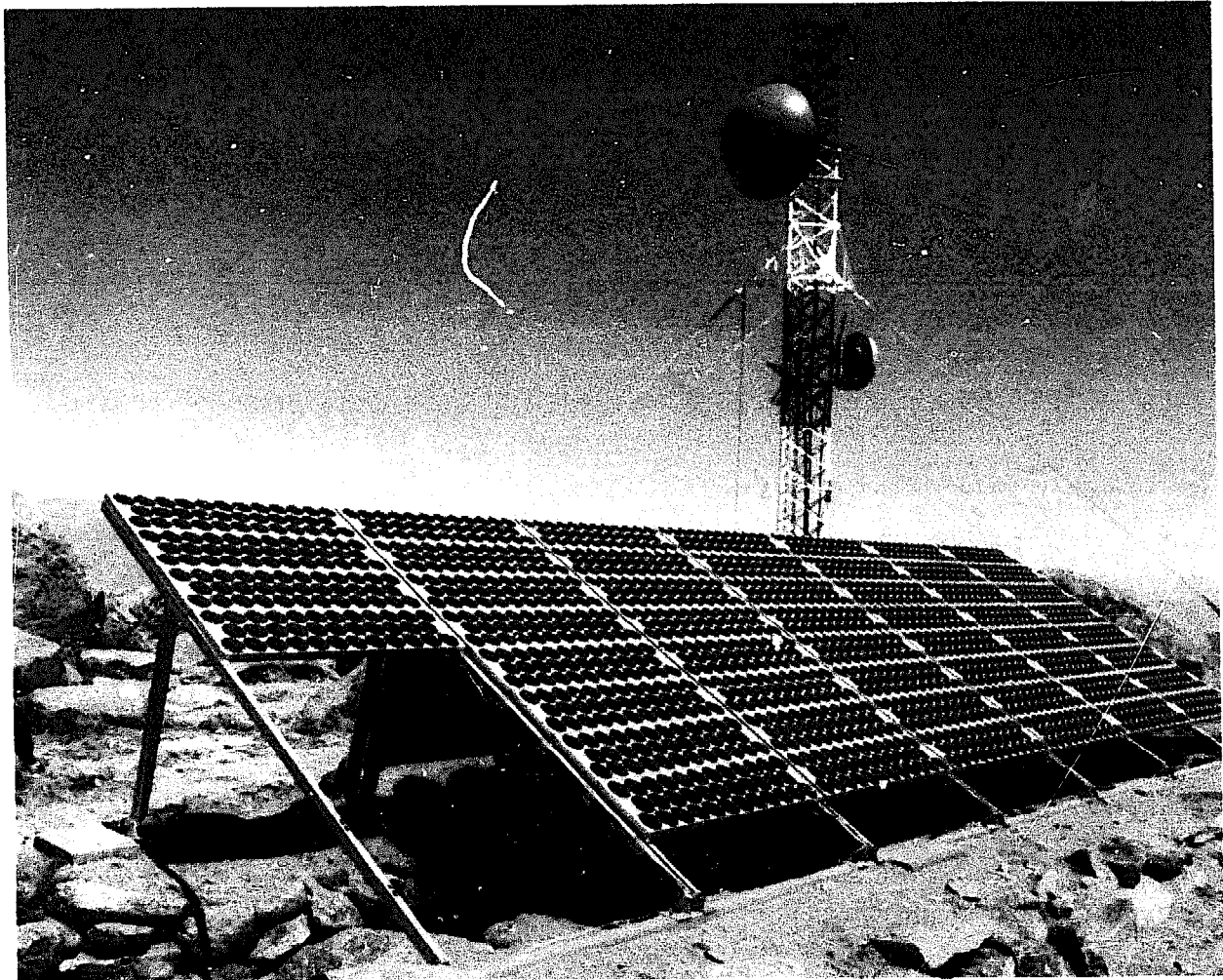

Figure 8.3 PV Telecommunications Repeater (NAPS - Sweden)

EXAMPLES OF PRODUCTS AVAILABLE T.V. VIDEO AND BROADCASTERS

Company: CODAN 6 Grove Park, Mill Lane, Alton, GU34 2QG, U.K.

Product: SOLAR POWERED TRANSCEIVER

Includes: 30 W SSB transmitter and receiver, 2 channels, steel case, microphone and 10Wp PV module for 6Ah battery pack.

Applications: Health centres, schools and outposts

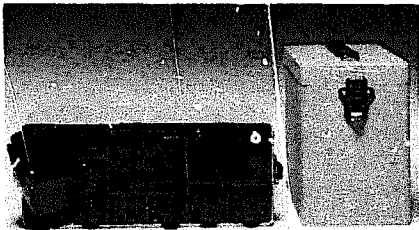

MODEL NO.	ARRAY Wp	PERFORMANCE	PRICE U.S. \$
6924B	10	30W SSB TRANSMITTER	3,500

Company: KYOCERA Ohsakui 1 - Chome - shi, Chiba Pref - 285, Japan

Product: LOUD SPEAKER SYSTEM

Includes: PV module, control unit with charge regulator battery, amplifier (20W), microphone, cassette player and two 15W speakers

Applications: Schools, parks, mosques and campsites



MODEL NO.	ARRAY Wp	PERFORMANCE	PRICE U.S. \$
SP-152PT	48	2 hrs/day	4,070

Company: NESTE Advanced Power Systems Raisitie, SF - 01510 Vantaa Finland

Product: EDUCATION SYSTEM

Includes: PV modules, control unit, 3 fluorescent lights, TV receiver, video recorder, inverter and cabling, battery (150 Ah)

Applications: Remote educational viewing



MODEL NO.	Array Wp	PERFORMANCE	PRICE (USD)
EC-2	96	360 Wh/day available	2,160

Company: SIEMENS SOLAR GmbH Buchenallee 3, D - 5060, Burgish Gladbach, Germany

Product: TV SYSTEM

Includes: PV array, charge regulator, television, battery, module support and aerial.

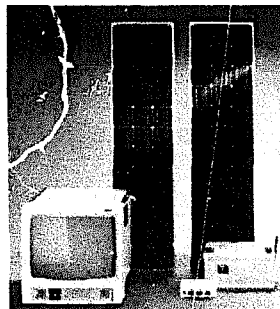

MODEL NO.	ARRAY Wp	LIGHT HOURS /DAY	PRICE U.S. \$
SM 36-18 A2 FC 918	70 100	51cm colour T.V. 40cm colour T.V.	Refer to Supplier

9. OTHER APPLICATIONS

9.1 INTRODUCTION

Photovoltaics can be used as a power source whenever small amounts of energy are required in a rural or remote location. The range of applications are thus numerous. Those of principal interest to development workers are described here.

9.2 WATER TREATMENT

Water Purification

In many parts of the world, drinking water is taken from polluted water sources. In fact, it is estimated that more than half the illnesses in the developing world are attributable to water related infection.

Solar powered water treatment plants are in operation in Kenya, Nigeria, Indonesia and several other countries. Although chemical dosing and ultraviolet sterilization are technically feasible practices, a simpler approach is to combine a solar-powered water pump with slow-sand filtration where many of the components, particularly the storage and settlement tanks, can be obtained and assembled locally. Such installations are found in Indonesia, Kenya and Nigeria

Desalination

PV Desalination equipment to remove the salt from water is available commercially, but costs are very high due to the high energy consumption of the desalination process.

Desalination is of particular interest to island communities with no fresh water sources. Thus demonstrations have been set up in the Asia and Pacific regions. In Japan a 25 kWp system is installed on Ohshima Island where approximately 5 cubic metres per day of clean water is produced, from the sea water. The salt content is reduced from 35,000 mg/litre to 400 mg/litre.

Other installations of PV desalination can be found in Australia, Indonesia and the Middle East.

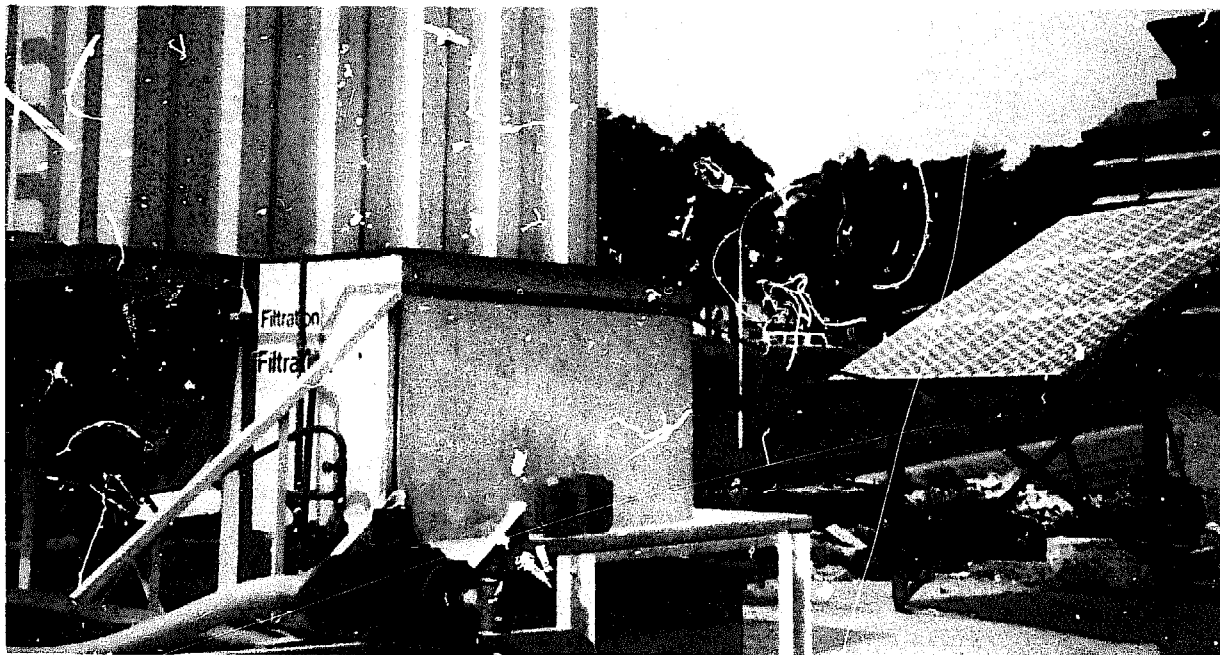

Figure 9.1 PV Water Purification Plant in Nigeria (Satec)

9.3 AGRICULTURAL APPLICATIONS

In addition to irrigation pumping covered in Chapter 5, PV can be used for:

- electrified cattle fencing
- grain milling
- produce cooling.
- freeze protection in stock tanks

PV powered electric fence systems are in widespread use with several thousand systems installed. A small PV array of 10 Wp with battery can electrify several kilometres of fence.

A PV powered grain mill has been operating successfully for eight years in Tangaye, Burkina Faso. It forms part of a 3.6 kWp PV system which also includes a water pump. The overall availability has been reported as over 90%. A similar unit is operating successfully in Tanfa, Mali. PV powered grain mills are not a commercially available "off-the-shelf" product.

PV powered cold stores are a rarity with only a few demonstration units operating such as the 45 kWp 275 m³ cold store on Giglio Island, Italy. Generally, these units are also not "off-the-shelf" items and are very expensive because of the high energy consumption.

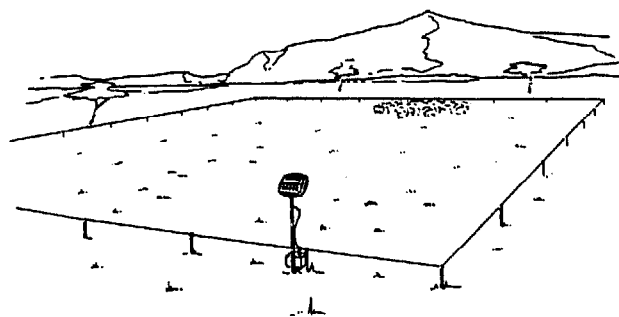

Figure 9.2 PV Powered Electrical Fencing

9.4 FISHERIES APPLICATIONS

Within the fisheries industries, the principal applications for PV are:

- shore-based navigational aids for fishing boats;
- lights on fishing boats;
- aeration and circulation pumps at fish farms;
- ice production for transporting fish;
- insect traps.

The main products being sold for the fisheries industry are lights and circulation pumps which can be used in fish farms. Suspended lights are used to attract insects thereby providing a concentration of insects for the fish to catch.

Ice production requires large amounts of energy and hence few photovoltaic products are available commercially. A PV-diesel hybrid system has been installed on the Red Sea Coast in Egypt for demonstration purposes.

9.5 TRANSPORT AIDS

Photovoltaics has become well established for powering transport aids particularly in:

- railway crossings and signalling
- obstacle lights
- terrain avoidance lights
- navigational buoys
- navigational lights on coasts
- runway lights
- highway signalling
- tunnel lighting
- navigational lights
- emergency phones

In Zambia and Zimbabwe, photovoltaics are used for railway signalling and communications. The Sudan Civil Aviation Authority uses PV power navigation aid equipment in Sudan.

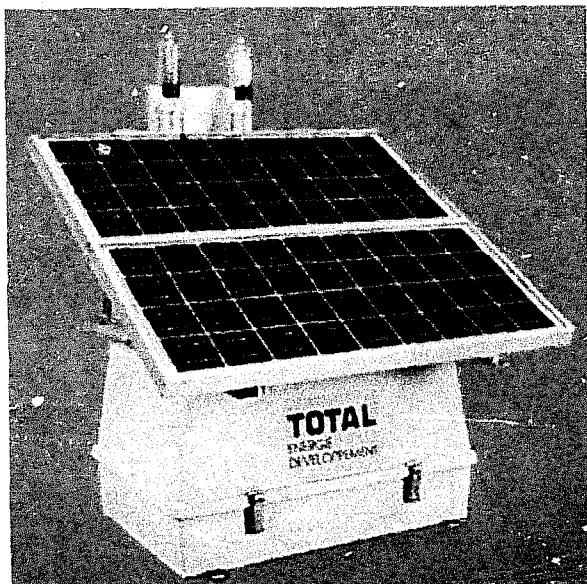

**Figure 9.3 Rural Airfield Lighting
(Total Energie)**

Of particular relevance to development workers are the new range of runway lighting and airfield equipment such as illuminated windsocks for use at small airfields.

Solar power is recognised as the best option for off-shore navigational aids because the need to make refuelling visits is thus eliminated. Not only are these devices used in the equatorial countries, but also throughout the coast of Europe and North America, even at high latitudes. Some 3000 systems are installed in Canada.

9.6 SECURITY SYSTEMS

Photovoltaics is used to power both lighting and also remote alarm systems using infra-red detectors. In Pakistan, a PV alarm system in use at a rural agricultural engineering training centre successfully alerted a night watchman that an intruder had entered the area where expensive agricultural equipment was stored (including PV pumps!).

9.7 CORROSION PROTECTION SYSTEMS

Photovoltaics has been utilised in many developing countries to protect steelwork from corrosion. In Pakistan, PV protects pipelines in the Badin gas fields. In China, lock gates are protected by PV and in India PV is used for off-shore platform protection. Photovoltaics is also being used to protect well-heads in many oil and gas fields and has recently been applied to the protection of bridge structures.

9.8 DOMESTIC APPLIANCES

Several domestic appliances can now be obtained to operate from a 12 volt power supply and thus are suitable for a solar-powered battery charging system. In addition to lighting covered in chapter 7, these include:

- circulation pumps for solar water heating systems
- domestic refrigerators
- PV fan powered evaporative coolers
- fans and ventilation systems
- television, radios and video machines
- air compressors
- chain saws, drills, soldering irons and other tools.

It is important, when selecting any of these appliances, to consider its rated power consumption. Equipment with the lowest power consumption is preferred to minimise the load on the PV system.

As described in Chapter 7, the total daily load of all appliances should be calculated in watt-hours to determine the PV array and battery size required. Alternatively, for a given PV array and battery combination, it is possible to calculate the maximum time available to operate the appliances for a particular location and season.

EXAMPLES OF PRODUCTS AVAILABLE WATER TREATMENT SYSTEMS

Company: **BP SOLAR** • 36 Bridge Street, Leatherhead, KT22 8BZ, U.K.

Product: SAND FILTRATION WATER TREATMENT SYSTEM

Description: A PV pump lifts water which feeds through a slow sand filter plant providing clean water to W.H.O standards. System supplied ready to assemble

Includes: PV pumping unit, raw water storage tank, filtration tank, clean water tank, control unit

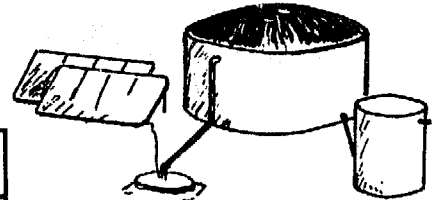

MODEL NO.	WATER OUTPUT m ³ /day	PRICE U.S. \$
BPP 250	12.5	Refer to Supplier
BPP 500	25	
BPP 1000	50	

Company: **TRANSCOAST LTD**

Ave de Gaulle 28, 1050 Brussels, Belgium

Product: WATER TREATMENT SYSTEM

Description: A containerised (Wasol) water treatment system of sand filtration and ultra-violet light sterilisation

Includes: PV pumping unit, sand and carbon filters, U.V. sterilizer, clean water storage tank, batteries, controller, distribution system

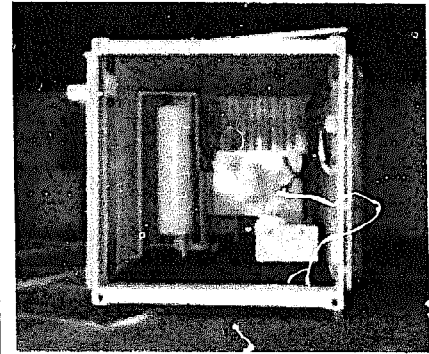

MODEL NO.	ARRAY Wp	WATER OUTPUT m ³ /day	PRICE U.S. \$
Ref 100	840	6 - 20 (100 - 30m)	59,600

HOME POWER (A.C.) SYSTEMS

Company: **RADE KONCAR**

Tezački put bb, 5800 Split, Yugoslavia

Product: HOME UTILITY KIT (220V, 50Hz)

Includes: 4PV modules, charge controller, 300 VA inverter, 78 Ah battery, support structures and wiring.

Applications: Where a.c. power is required

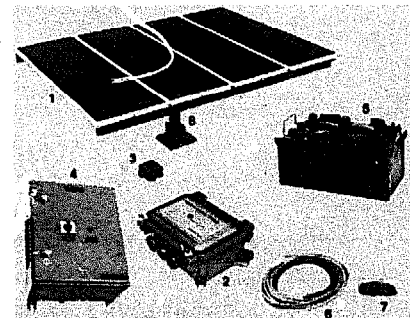

MODEL NO.	ARRAY Wp	PERFORMANCE	PRICE U.S. \$
Utility Kit	48	200 Wh/day typical	Refer to supplier

EXAMPLES OF PRODUCTS AVAILABLE AGRICULTURAL SYSTEMS

Company: HELIODINAMICA · Caixa Postal 11 - 06730 Vagem Grande Paulista, S.P., Brazil

Product: ELECTRIC FENCE
 Includes: PV module, battery, fence electrifier support structure, cables
 Applications: Livestock fencing

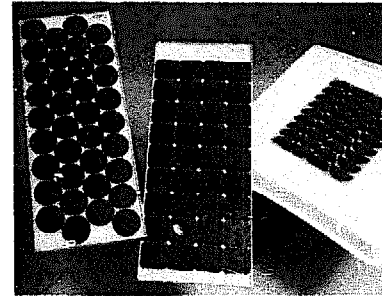

MODEL NO.	ARRAY Wp	PERFORMANCE	PRICE U.S. \$
EF	9	for 10km fence	380

Company: MOBES GMBH Bergiusstraße 40-44, Berlin 44, Germany

Product: ELECTRIC FENCING UNIT
 Description: A range of electric fencing systems use in a variety of locations
 Includes: Pole Mounted PV module, fence energiser sealed battery and voltmeter display



MODEL NO.	PERFORMANCE	PRICE U.S. \$
W4000 GNI	For medium - high sunshine areas, larger fences .	refer to supplier
W4000 CNI	For abundant sunshine areas smaller fences.	

Company: SOUTHERN CROSS PO, Box 155 Darra, Qld 4076, Australia

Product: ELECTRIC FENCE
 Includes: PV module, battery, fence electrifier for (30W) support structure, cables

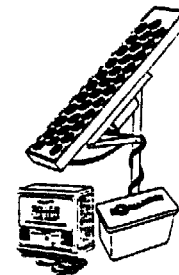

MODEL NO.	ARRAY Wp	PERFORMANCE	PRICE U.S. \$
346	30	for 40km of fence	990

Company: ZOME WORKS PO Box 25805, 1011A Sawmill Rd, Albuquerque NM 87125, USA

Product: STOCK TANK ICE BREAKER
 Includes: PV module, module mount, pipe, pole air lift pump, nozzle, enclosure.
 Applications: Stock tank and trough ice breaking

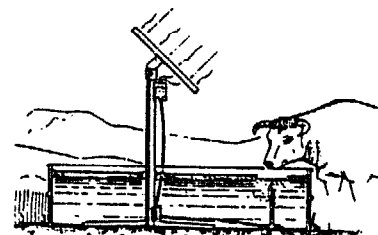

MODEL NO.	ARRAY Wp	PERFORMANCE	PRICE U.S. \$
De-icer	18	up to 50 cms ice prevented	550

EXAMPLES OF PRODUCTS AVAILABLE MISCELLANEOUS

Company: HILTEC SOLAR Unit 24D North Tyne Ind. Est. Whitley Road, Newcastle-U-Tyne, NE 12 U.K.

Product: EDUCATIONAL PRODUCTS

Includes: Ranges of kits, cells, small motors, fans, battery chargers, clock, etc for school projects

MODEL NO.	WATTS PEAK	Performance	PRICE U.S. \$
SK01	-	cells, motor etc	22
SK03	-	Water pumping kit	50
SK04	-	Battery charging Kit	22

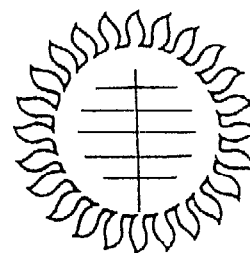

Company: INTERSOLAR LTD

Cock Lane, High Wycombe, Bucks, HP13 7DE 1DQ, U.K.

Product: EXTRACTOR FANS

Description: An extractor fan unit with integral PV cell for surface mounting in glass or wall structure. Complete unit ready for installation Automatic or manual operation. Optional battery for night time use.

MODEL NO.	output air changes/day	PRICE U.S. \$
Type 21	20 - 40	50
Type 22	15 - 30	64
Type 25	40 - 80	60
Type 26	20 - 50	76

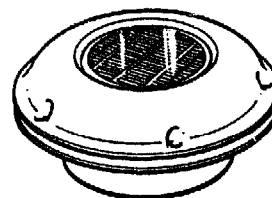

Company: KOMATSU ELECTRONICS

2612 Shinomiya, Hiratsuka, Kamagova, Japan

Product: SOLAR VENTILATOR

Description: A free-standing ventilation fan with PV module for direct operation during daylight hours

Includes: PV module, ventilator fan and motor unit

MODEL NO.	ARRAY Wp	OUTPUT	PRICE U.S. \$
KB - 1802	9	12W Fan	refer to supplier



Company: PHOTOCOMM INC.

930 Idaho - Maryland Road, CA 95945, USA

Product: AIR CONDITIONING UNIT

Description: Evaporative cooler with PV powered fan

Includes: PV module, support structure, 12v evaporative cooler unit with fan and pump. Battery optional for night time cooling

MODEL NO	ARRAY Wp	PERFORMANCE	PRICE U.S. \$
New Breeze	30 - 40	suitable for areas with relative humidity <75%	refer to supplier

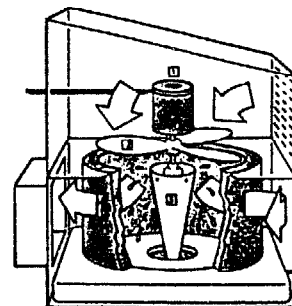

10. FREQUENTLY ASKED QUESTIONS

1. How long will a PV system last?

PV modules will last twenty years or more and many suppliers will give a five to ten year warranty. Generally, the component with the shortest life will be the battery which may have to be replaced each three to five years.

2. Is there enough sun in my area - I often have cloudy days?

In general, PV can be economically applied to all regions between the latitudes of 40° N and 40° S. Having cloudy days or rain is not necessarily a problem because batteries can store electricity for these days. In the case of solar pumps water can be stored in storage tanks. With many applications, there is good correlation between supply and demand. For example, a solar irrigation pump is not needed if it is raining!

3. Is the application I'm considering likely to be economic for PV power?

If the average daily energy consumption of your application equipment (motor/pump, refrigerator, lights, etc) is less than 50 kWh per day, PV is likely to be economic.

4. Should PV be used only where there is no electric grid?

In general - yes. If you have access to grid electricity it is more economic to connect to the grid. If the grid electricity is unreliable it may be less expensive to buy a mains battery charger and batteries for the power cut periods rather than buy PV.

5. Can I get an electric shock from a PV array?

Yes, treat PV arrays as potentially dangerous as any other electricity supply.

6. I cannot run my lights and other appliances as often as I want to. What can I do?

Most PV systems are modular. You can add more PV modules to increase the energy available and add additional battery capacity if necessary. Seek advice from your supplier before doing this.

7. Is PV an "appropriate technology" for countries?

Yes, Just because it's considered advanced technology doesn't make it inappropriate. PV is reliable, has a long life, is environmentally clean and economic for small scale applications. PV systems are now being manufactured in Brazil, China, India, Mongolia, Tunisia, Vietnam, Zimbabwe and other developing countries.

Alternating current (A.C.) - Electric current in which the direction of flow is reversed at frequent intervals. Opposite of direct current (D.C.).

Amorphous - The condition of a solid in which the atoms are not arranged in an orderly pattern; not crystalline.

Annual equivalent life cycle cost (ALCC) - The total life time costs of a system expressed as a sum of annual payments.

Balance of system (BOS) - Parts of a photovoltaic system other than the array.

Cathodic protection - A method of preventing oxidation (rusting) of exposed metal structures such as bridges by imposing between the structure and ground a small electrical voltage that opposes the flow of electrons, and is greater than the voltage that is present during oxidation.

Clearness index - The ratio of global solar irradiation to extraterrestrial solar irradiation.

Concentrator - A photovoltaic array which includes an optical component such as a lens or focusing mirror to direct incident sunlight onto a solar cell of small area.

Conversion efficiency (cell). The ratio of the electric energy produced by a solar cell (under full sun conditions) to the energy from sunlight incident upon the cell.

Czochralski process - Method of growing a perfect crystal of large size by slowly lifting a seed crystal from a molten bath of the material under careful conditions of cooling.

Deep discharge - Discharging a battery to 20 per cent or less of its full charge.

Design month - For the purpose of sizing a solar photovoltaic system, it is necessary to choose a 'worst month' in relation to the solar resource for which the system must meet the load requirements. This month is termed the design month.

Diffuse radiation - Solar radiation scattered by the atmosphere.

Direct radiation - Solar radiation transmitted directly through the atmosphere.

Direct current (D.C.) - Electric current in which electrons are flowing in one direction. Opposite of alternating current (A.C.).

Dynamic head - The head loss in pipes caused by the flow of water through the pipes.

Extra-terrestrial irradiation - The solar energy received outside the earth's atmosphere.

Fill factor - The ratio of maximum output of a PV cell under reference conditions to the product of open circuit voltage and short circuit current/under the same conditions.

Flat plate (module or array) - An arrangement of solar cells in which the cells are exposed directly to normal incident sunlight. Opposite of concentrator.

Global irradiance - The sum of diffuse and direct solar irradiance incident on a horizontal surface.

Hydraulic energy - The energy necessary to lift water.

Impedance matching - The process of matching the output of one device to the input of another device such that there is a maximum transfer of power between the two.

Insolation - Sunlight, direct or diffuse (not to be confused with insulation).

Inverter - Device that converts D.C. to A.C.

I-V curve - A graphical presentation of the current versus the voltage from a photovoltaic cell as the load is increased from the short circuit (no load) condition to the open circuit (maximum voltage) condition. The shape of the curve characterises cell or module performance.

Kilowatt (kW) - 1,000 Watts.

Kilowatt hour (kWh) - 1,000 Watt hours.

Life Cycle Costs (LCC) - The lifetime costs associated with a pumping system expressed in terms of today's money.

Load - Any device or appliance that is using power.

Maximum Power Point Tracker (MPPT) - Impedance matching electronics used to hold the output of the PV array at its maximum value.

Parallel connection - A method of interconnecting two or more electricity-producing devices, or power-using devices, such that the voltage produced, or required, is not increased, but the current is additive. Opposite of series connection.

Peak Watt or Watt peak - The approximate amount of power a photovoltaic device will produce at noon on a clear day (insolation at 1000 Watts per square metre) when the cell is faced directly toward the sun.

Photovoltaic - Pertaining to the direct conversion of light into electricity.

Photovoltaic array - An interconnected system of photovoltaic modules that functions as a single electricity-producing unit. The modules are assembled as a discrete structure, with common support or mounting.

Photovoltaic cell - A device that converts light directly into electricity. A solar photovoltaic cell, or solar cell, is designed for use in sunlight. All photovoltaic cells produce direct current (D.C.).

Photovoltaic collector - A photovoltaic module or array which receives sunlight and converts it into electricity.

Photovoltaic module - A number of photovoltaic cells electrically interconnected and mounted together, usually in a common sealed unit or panel of convenient size for shipping, handling and assembling into arrays.

Photovoltaic system - A complete set of components for converting sunlight into electricity by the photovoltaic process, including array and balance-of-system components.

Polycrystalline silicon; polysilicon - Silicon which has solidified at such a rate that many small crystals have formed. The atoms within a single crystal are symmetrically arrayed, whereas in polysilicon crystals they are jumbled together.

Power conditioner - The electrical equipment used to convert power from a photovoltaic array into a form suitable for subsequent use, as in supplying a household. Loosely, a collective term for inverter, transformer, voltage regulator, meters, switches and controls.

Present worth - The value of a future cost or benefit expressed in present day money.

Prime mover - The power source for a system.

PV - Abbreviation for photovoltaic.

Series connection - A method of interconnecting devices that generate or use electricity so that the voltage, but not the current, is additive one to the other. Opposite of parallel connection.

Short circuit current - Of a PV cell, module or array is the current that flows when the output terminals of the device are joined together.

Solar irradiance - The power received per unit area from the sun.

Solar irradiation or insolation - The energy received per unit area from the sun in a specified time period. In this handbook, the time period is generally taken to be a day and the solar irradiation is expressed in MJ per m² per day or kWh per m² per day (1 kWh = 3.6 MJ).

Stand alone - An isolated photovoltaic system not connected to a grid; may or may not have storage, but most stand-alone applications require a battery or other form of storage.

Tilt factor - The ratio of solar irradiation incident on a tilted PV array to global irradiation.

Watt, wattage - A measure of electric power, or amount of work done in a unit of time. One amp of current flowing at a potential of one volt produces one Watt of power.

Watt hour (Wh, Whr) - A quantity of electrical energy (electricity). One Watt hour is consumed when one Watt of power is used for a period of one hour.

1. Introduction

Economic considerations are important when comparing Photovoltaics with other power sources. PV systems are technically viable but where alternatives exist the evaluation of the alternatives must include economic and technical and environmental considerations.

When economic viability is considered, a distinction should be made between economic and financial assessment. The economic approach seeks to make a true comparison of the value to society as a whole, and as such must use costs and benefits that are free from taxes, subsidies, interest payments, etc. Conversely, a financial assessment is an evaluation from the purchaser's viewpoint; so taxes, subsidies and the effect of spreading the capital cost over several years by means of a loan, are all taken into account.

2. Methodology

The most complete approach to economic appraisal is to use life cycle costing because all future expenses are then taken into account. In this method, all the future costs and benefits are discounted to "present day" values. The underlying concept in this approach is that investors would be indifferent as to whether they had \$100 now or \$110 in a year's time if the \$100 could be invested at an interest rate of 10%. Hence the Present Worth (PW) of an expenditure of \$110 in one year's time would be \$100 when discounted at a rate of 10%.

The calculation of PW involves the use of a discount rate which reflects the opportunity cost of capital. Values of discount rate that are used for other projects in the country concerned can usually be taken as a guide, typical values are 10-12%. High discount rates mean that a low value is placed on future costs and benefits. For example, at a discount rate of 50%, an expenditure of \$100 in one year's time has a PW of only \$66.67.

However it should be noted that such economic analysis doesn't take into consideration such factors as environmental benefits (PV doesn't add to Global Warming like diesel engines) nor the benefits of superior service (e.g. higher reliability of PV).

3. Calculation of Present Worth

For a future cost or benefit (Cr), payable in N years, which is inflating at a fixed percentage "i" each year and discounted at a rate "d", the Present Worth is given by:

$$\begin{aligned} \text{PW} &= \text{Cr} \cdot \text{Pr} \\ \text{with } \text{Pr} &= \left[\frac{(1 + i)^N}{(1 + d)^N} \right] \end{aligned}$$

For a payment or benefit C_a (\$) occurring annually for a period of N years which is inflating at a rate "i" per year and discounted at a rate d , the Present Worth is

$$PW = C_a.P_a$$

$$\text{with } P_a = \frac{(1+i)}{(1+d)} \left[\frac{(1+i)^N}{(1+d)^N} - 1 \right]$$

$$\frac{(1+i)}{(1+d)} - 1$$

Tables 1 and 2 give the factor P_r and P_a respectively for selected values of N , i and d .

4. Examples

- (a) To find the PW of a single cost of \$10,000 occurring in 5 years time at an inflation rate of 5% per annum and discounted at a rate of 10% per annum. The factor P_r from Table 1 for $d = 0.1$, $i = 0.05$ and $N = 5$ is found to be 0.79. Hence the $PW = (10,000 \times 0.79) = \7900 .
- (b) To find the PW of an annual benefit of \$2000 occurring for a period of 10 years which has an annual inflation rate of 5% per annum and is discounted at a rate of 15% per annum. The factor P_a from Table 2 for $d = 15\%$, $i = 5\%$, $N = 10$ is found to be 6.27. Hence the $PW = \$2,000 \times 6.27 = \$12,540$

It is usual to carry out economic evaluations in real terms; the interest rates and discount rates used should be relative to general inflation. Hence costs are only assumed to inflate or deflate if their prices are changing relative to all other prices. However, as long as both discount and inflation rates are expressed in the same way (ie, both excluding general inflation or both including general inflation) the resulting Present Worth will be the same. Hence, normally inflation rates in Table 1 and 2 are assumed to be zero (general inflation excluded).

5. Considerations

When undertaking an economic comparison of different technologies it is important to consider if, some costs have subsidies, taxes or duties included. For example if diesel fuel is subsidised in a country then a solar photovoltaic pump may not appear to be competitive to the user on a life cycle cost basis compared to a diesel pump (if the subsidised diesel fuel price is used). However if the unsubsidised cost of the fuel is used the use of solar pumps may be found to be economic for the country.

Discount Rate (d)	Inflation Rate (i)	Factor Pa for given number of years				
		<u>5</u>	<u>10</u>	<u>15</u>	<u>20</u>	<u>30</u>
0.00	0.00	5.00	10.00	15.00	20.00	30.00
	0.05	5.80	13.21	22.66	34.72	69.76
	0.10	6.72	17.53	34.95	63.00	180.94
	0.15	7.75	23.35	54.72	117.81	499.96
	0.20	8.93	31.15	86.44	224.03	1418.26
0.05	0.00	4.33	7.72	10.38	12.46	15.37
	0.05	5.00	10.00	15.00	20.00	30.00
	0.10	5.76	13.03	22.21	33.78	66.82
	0.15	6.62	17.06	33.51	59.44	164.68
	0.20	7.60	22.41	51.29	107.59	431.39
0.10	0.00	3.79	6.14	7.61	8.51	9.43
	0.05	4.36	7.81	10.55	12.72	15.80
	0.10	5.00	10.00	15.00	20.00	30.00
	0.15	5.72	12.87	21.80	32.95	64.27
	0.20	6.54	16.65	32.26	56.38	151.24
0.15	0.00	3.35	5.02	5.85	6.26	6.57
	0.05	3.84	6.27	7.82	8.80	9.81
	0.10	4.38	7.90	10.71	12.96	16.20
	0.15	5.00	10.00	15.00	20.00	30.00
	0.20	5.69	12.73	21.44	32.22	62.04
0.20	0.00	2.99	4.19	4.68	4.87	4.98
	0.05	3.41	5.16	6.06	6.52	6.87
	0.10	3.88	6.39	8.02	9.07	10.19
	0.15	4.41	7.97	10.85	13.18	16.58
	0.20	5.00	10.00	15.00	20.00	30.00

Table 2 Selected Values of Present Worth Factors Pa for an Annually Recurring Cost

<u>Discount Rate (d)</u>	<u>Inflation Rate (i)</u>	<u>Factor Pr for given number of years</u>				
		<u>5</u>	<u>10</u>	<u>15</u>	<u>20</u>	<u>30</u>
0.00	0.00	1.00	1.00	1.00	1.00	1.00
	0.05	1.28	1.63	2.08	2.65	4.32
	0.10	1.61	2.59	4.18	6.73	17.45
	0.15	2.01	4.05	8.14	16.37	66.21
	0.20	2.49	6.19	15.41	38.34	237.38
0.05	0.00	0.78	0.61	0.48	0.38	0.23
	0.05	1.00	1.00	1.00	1.00	1.00
	0.10	1.26	1.59	2.01	2.54	4.04
	0.15	1.58	2.48	3.91	6.17	15.32
	0.20	1.95	3.80	7.41	14.45	54.92
0.10	0.00	0.62	0.39	0.24	0.15	0.06
	0.05	0.79	0.63	0.50	0.39	0.25
	0.10	1.00	1.00	1.00	1.00	1.00
	0.15	1.25	1.56	1.95	2.43	3.79
	0.20	1.55	2.39	3.69	5.70	13.60
0.15	0.00	0.50	0.25	0.12	0.06	0.02
	0.05	0.63	0.40	0.26	0.16	0.07
	0.10	0.80	0.64	0.51	0.41	0.26
	0.15	1.00	1.00	1.00	1.00	1.00
	0.20	1.24	1.53	1.89	2.34	3.59
0.20	0.00	0.40	0.16	0.06	0.03	0.00
	0.05	0.51	0.26	0.13	0.07	0.02
	0.10	0.65	0.42	0.27	0.18	0.07
	0.15	0.81	0.65	0.53	0.43	0.28
	0.20	1.00	1.00	1.00	1.00	1.00

Table 1 Selected Values of Present Worth Factor Pr for a Cost in N Years Time.

EUROPE

Atersa

Fernando Poo, 6
28045 Madrid
SPAIN
Tel: +34-1. 4747211
Fax: +34-1. 4647467

BP Solar Ltd

36 Bridge Street
Leatherhead
Surrey KT22 8BZ
UK
Tel: +44 - 372 377899
Tlx: 263320 BPSIL
Fax: +44 - 372 377750

BP Solar Espana

Poligono Industrial de Valportillo
Calle Primera 5
Alcobendas, Madrid
SPAIN
Tel: +34 - 1. 6534422
Fax: +34 - 1. 6535771

Benelux Solar

Gagelveld 7-A
4844 Re Therheijden
THE NETHERLANDS
Tel: +31 - 16. - 934143
Fax: +31 - 16. 934138

Budimex

Rue Van Eyck, 11C
1050 Brussels
BELGIUM
Tel: +32 - 2.647 8515
Fax: +32 - 2.647 8788

Chloride Solar Ltd

Lansbury Estate
Lower Guildford Road
Knaphill
Woking GU21 2EW
UK
Tel: +44 - 483. 797773
Tlx: 589791
Fax: +44 - 483. 797269

Chronar France

3 Allee Edme Lheureux
Immeuble Vancouver
94340
Joinville - Le - Pont
FRANCE
Tel: +33 1. 48 85 1333
Fax: +33 1. 48 85 2221

Chronar Ltd

Waterton Ind.I Est.
Bridgend
Wales
CF31 3YN
Tel: +44 - 656. 61211
Fax: +44 - 656. 63182

Codan (UK) Ltd

6 Grove park
Mill Lane
Alton
Hants
GU34 2QG
UK
Tel: +44 - 420 80121
Fax: +44 - 420 541098

Duba N.V.

Kasteeldreff 1
B9200 Wetteren
BELGIUM
Tel: +32 - 91. 693496
Fax: +32 - 91. 695752

Dulas Engineering

Old School House
Eylwystach
Machynlleth
Wales SY20 8SX
UK
Tel: +44 - 654. 74332
Fax: +44 - 654. 74390

Dynhelios

2A Du Buisson
76350 Oissel
FRANCE
Tel: 35 64 9747
Tlx: 770204
Fax: 35 64 0318

Ecosolaire

19 Rue pavee
75004 Paris
FRANCE
Tel: +33 - 1. 48 87 4360
Fax: +31 -1. 48 87 8627

ENE

Avenue van der Meerschen 108
B-1150
Brussels
BELGIUM
Tel: +32 - 2. 771 13 28

Flachglas Solar Technik
Muhlgasse 7
D-5000 Koln 1
GERMANY
Tel: +49 - 221 235191
Tlx: 172214258
Fax: +49 221 243811

Fluxinos
Viale Europa 6/b
20060 Bussere, MI
ITALY
Tel: +39 - 2. 95039089
Tlx: 500433
Fax: +39 - 2. 95039089

Grundfos
DK-8850
Bjerringbro
DENMARK
Tel: +45 - 86.68 1400
Tlx: 60731 GFOS DK
Fax: +45 - 86.68 4472

Helios Technology
Via PO 8
Galliera 1-35015
Veneta (Padova)
ITALY
Tel: + 39 - 59 65655
Fax: +39 - 59 58255

Hiltec
Unit 24 D
North Tyne Industrial Estate
Whitley Road
Longbenton
Newcastle-Upon - Tyne
UK
Tel: +44 - 91.2663478
Fax: +44 - 91.2818430

Hydrasol
Industriestrasse 100
6919 Bammental
GERMANY
Tel: +49 6223 47532
Fax: +49 6223 48159

IDEA
Via G. Rossi 13/3
40138 Bologna
ITALY
Tel: +39 - 51.393639
Fax: +39 - 51.394839

IBC
P O Box 1107
D-8623 Staffelstein
GERMANY
Tel: +49 - 9573 3066
Fax: +49 - 9573.3832

ICPE PV Co.
T Vladimirescu Bd
45 - 47,
79623 Bucharest
ROMANIA
Tel: +40 - 0.314100
Tlx: 010486

Intersolar Ltd
Unit Two
Cock Lane
High Wycombe
Bucks HP13 7DE
UK
Tel: +44 - 494. 452945
Tlx: 837383
Fax: +44 - 494 - 437045

Isofoton S.A
Miguel Angel, 16
28010 Madrid
SPAIN
Tel: +34 - 1. 4012354
Tlx: 49944
Fax: +34 - 1. 4105989

Italsolar
Via A. D'Andrea, 6
Nettuno 00048 (RM)
ITALY
Tel: +39 - 6. 9850246
Tlx: 612441
Fax: +39 - 6. 9850269

MBB
Energie und Prozesstechnik
Postfach 801109
D-8000
GERMANY
Tel: +49 - 89 46005357
Tlx: 5287117
Fax: +49 - 89 46005332

Mobes Nach, GmbH
Bergiusstrasse 40-44
1000 Berlin 44
GERMANY
Tel: +49 - 30.684 8094
Tlx: 183432

Mono Pumps Ltd
Cromwell Trading Estate
Cromwell Road
Bredbury
Stockport SK6 2RF
UK
Tel: +44 61. 494 6999
Tlx: 668762
Fax: +44 61. 494 5802

NAPS-UK
PO Box 83
Abingdon
Oxon OX14 2TB
UK
Tel: +44 - 235 529749
fax: +44 - 235 553450

NAPS Sweden
Stensatravagen
S-127 35 Skarholmen
SWEDEN
Tel: +46 - 8.979 565
Fax: +46 - 8. 463 205

NAPS Finland
Ralssitie 7
SF - 01510 Vantaa
FINLAND
Tel: +358 - 0.8701611
Fax: + 358 - 0. 826 301

NAPS Norway
PO Box 96
Rislokka
N - 0516 Oslo 5
NORWAY
Tel: +47 - 2. 723012
fax: +47 - 2. 722435

Noack Solar
Kjelsaavelen 160
Box 79
Kjelsaas
0411 Oslo 4
NORWAY
Tel:+ 47-2. 227460
Tlx: 71128 NOACK N
Fax: +47 - 2151808

Photronics
Hermann-Oberth Str 9
D-8011 Putzbrunn
GERMANY

Photowatt Intr! S.A
55, Av du Mont Valerien
92500 Rueil-Malmaison
FRANCE
Tel: +47 - 080505
Tlx: 202084

Portsol
Rua Polincarmo
Anjos 62
Lisbon
PORTUGAL
Tel: 4198523
Tlx: 63668

Pumpen Fabrik Wangen GmbH
Ampatal 8
D-8049 Unterbruck
W. GERMANY
Tel: 08133 2071
Tlx: 5270504 PULE D

Rade Koncar
Tezacki put bb
58000 Split
YUGOSLAVIA
Tel: +38 - 58.512 299
Fax: +38 - 58.512 138

R & S Renewable Energy Systems
PO Box 45
5600 AA Eindhoven
THE NETHERLANDS
Tel: +31 - 40. 520155
Tlx: 59030 RES NL
Fax: +31 - 40. 550625

SAB Nife
Box 515
S-261-24 Landskrona
SWEDEN
Tel: 46 418 16280
Tlx: 72416

Siemens Solar GmbH
Buchenallee 3
D-5060, Bergisch Gladbach
GERMANY
Tel: 49 - 89 - 3500
Tlx: 884 891 SSOL
Fax: 49 - 89 - 35002573

Sistemi Energetici Integrati
Via S Jacopo
32-50047 Prato
ITALY
Tel: 0574 24051
Tlx 570045

Solar Energie Technik
Postfach 1180
D/6822 Altlussheim
GERMANY
Tel: +49 - 6205. 3525
Tlx: 465 849
Fax: +49 - 6205.3528

Solems
3 rue Leon-Blum
Z.I Les Glaises
1120 Palaiseau
FRANCE
Tel: 1 60 133440
Tlx: 604549
Fax: 1 60 133743

Soltech
Boekteerheide 30
3550
Zolder
BELGIUM
Tel: +32 - 11.530181
Fax: +32 - 11.539574

Sunpower
localita Pannellia
33030 Sedegliano
ITALY
Tel: +39 - 434. 571760
Fax: +39 - 434.571554

Telefunken System Technik
Industriestrasse 23-33
D-2000 Wedel (Holstein)
GERMANY
Tel: +49 - 4103.600
Fax: +49 - 4103.604700

Total Energie
7 Chemin du Plateau
Z.I. Le Tronchon
69570 Dardilly
FRANCE
Tel: +33 - 78 47 4455
Fax: +33 - 78 64 9100

Textronica
Av.Colegio Militare 153-B
1500 Lisboa
PORTUGAL
Tel: +351 - 1. 715 5684
Fax: +351 - 1. 715 2123

Transcoast Ltd
Ave de Gaulle 28
1050 Brussels
BELGIUM
Tel: +32 2 647 7504

Transelektro
1394 Budapest
P O B 377
HUNGARY
Tlx: 224571

Vergnet SA
66, rue Hoche
92240 Malakoff
FRANCE
Tel: +33 - 1.47461616
Fax: +33 - 1.47460686

VIESH
1st Veschnjakovskij Str, 2
109456 Moscow
USSR

Windsol
18 Chatzopoulou St
17671 kallithea
GREECE
Tel: +30 - 9232943
Tlx: 226551

AFRICA

Animatics Ltd
PO Box 72011
Nairobi
KENYA
Tel: +254 - 2. 331 722
Tlx: 22233

BP Solar East Africa Ltd
Fedha Tower
Muindi Mbingu St
Nairobi
KENYA
Tel: +254 - 2. 336396
Fax: +254 - 2. 331756

BP Solar Zambia
PO Box 31999
Mutaba House
Cairo Road
Lusaka
ZAMBIA
Tel: +260 - 1.215390
Tlx: 41180

CDK Engineering Ltd
29 Nassar Road
PO Box 1173
Kampala
UGANDA
Tel: +256 - 41.259902

Ecological Designs
PO Box 780
Masvinga
ZIMBABWE
Fax: +263 - 39.2215

FNMA
14me Rue Limete
BP 1967
Kinshasa 1
ZAIRE
Tel: +243 - 12. 77264/23482
Tlx: 22080

Intertec Contracting
(C Africa) Ltd
PO Box 409
Blantyre
MALAWI
Tel: 636825
Tlx: 4544 INTEC MI

Kensid
Abcon House
Baricho Road
PO Box 18511
KENYA
Tel: 555622
Tlx: 22774

Kenital Solar Electricity
Elgeyo Marakwet Close 381
Nairobi
KENYA
Fax: +254 - 2.562295

NORD Industrie
26 Avenue Kheireddine Pacha
Tunis
TUNISA
Tel: +216 - 1. 288746
Tlx: +14906

Scan African Trading Ltd
PO Box 40490
Gaborone
BOTSWANA
Tel: 313638
Tlx: 2638 SCANT BD

SEI Nairobi
PO Box 47384
Nairobi
KENYA
Tel: 335056
Tlx: 22347 PANELAER

Solarcomm
PO Box ST319
Southerton
Harare
ZIMBABWE
Tel: +263 - 0.64341
Tlx: 26482

Somatrec
Rue Enseigne Froger
BP800
Bumako
Mali
Tel: +223 - 225584
Tlx: 425

West African Batteries
16 Keffi Street
S/W Ikoyi,
PO Box 2341
Lagos
NIGERIA
Tel: +234 - 1. 685095
Fax: +234 - 1. 685182

WSG Hitech
PO Box ST 319
Southerton
Harare
ZIMBABWE
Tel: +263 - 0.64320
Tlx: 2386

INDIA & PAKISTAN

BHEL
PV Division
Vikasnagar
Mysore Road
INDIA

CEL
4 Industrial Area
Sahibabad 201 010
UP
INDIA
Tel: 869157/201071
Tlx: 592203

HMA Investments Ltd
11 West Wharf Road
PO Box 5266
Karachi 2
PAKISTAN
Tel: 202737
Tlx: 25499 HMAI PLC

Hydrasol Ltd
7-2-21A Begumpet
Hyderabad 500 016
INDIA
Tel: +91 - 842.33827
Fax: +91 - 842.222483

IMFA
Therubali Dist
Koraput Orissa 765018
INDIA

REIL
D-37 Madho Singh Road
Bani Park
Jaipur 302006
INDIA
Tel: 62601
Tlx: 365403

Suryovonics Ltd
7 - 1 - 21A Begumpet
Hyderabad 500 016
INDIA
Tel: +91 - 842.33827
Fax: +91 - 842.222483

Tata-BP Solar
A101 Block II
KSSIDC Multistorey Blocks
Electronic City
Hebbagodi
Hosur Road
Bangalore 562 158
INDIA
Fax: +91 - 8114.2417
Tlx: 8408 224

SE ASIA

AWA Ltd
47 Forster Road
Walu Bay
Suva
FIJI

BP Solar Malaysia
37th Floor
Menara Maybank
100 Jalan Tun Pesak
50734 Kuala Lumpur
MALAYSIA
Tel: +60 - 3. 232 6322
Fax: +60 - 3. 232 7642

BP Solar Papua New Guinea
PO Box 569
Speybank Street
Lae
PAPUA NEW GUINEA
Tel: +675 - 422200
Fax: +675 - 424401

BP Thai Solar Corporation Ltd
13th Floor
Sitthivorakil Building
5, Soi Pipat
Silom Road
Bangkok
THAILAND
Tel: +66 - 2.2368160
Fax: +66 - 2.2368169

China PV Centre
91 Huang Cheng Xi Lu Road
Hangzhou
CHINA P.R.
Tlx: 35069

NAPS East Asia
Rcom 808 Wingon Plaza
62 Mody Rd
Tsimshatsui E.
Kowloon
Hong Kong
Tel: +852 - 739 6565
Fax: +852 - 3115289

Neimeng Gu Solar Factory
Park Road,
Donghe Di Triet
Bao Tou Neimenggu
CHINA P.R.

Ningbo - Solar
590 Xijiao
Road
Ningbo
Zehejiang
CHINA P.R

Solarex Electric Ltd
18th Floor, Sincere Insurance Bldg
4 Hennessey Road
HONG KONG
Tel: 852 5 285717
Tlx: 780 61254
Fax: 852 5 279704

Solarindo
PT Centronix
J1 Matraman Raya 36
Jakarta 13150
INDONESIA
Tel: +62 - 21.884187
Tlx: 48216

Showa Arco Solar
10 Anson Road 18-24
International Plaza
SINGAPORE 0207
Tel: 2212 433
Tlx: RS 20061 ASIS PR
Fax: 22 58002

Solar Lab
Trung Tam Vat Ly
01 Mac Dinh Chi
Q1. TP
Ho Chi Minh City
VIETNAM
Tel: 22028

Solar Power Division
PT Kemenangan
JL Gunung Sahari, 75
PO Box 2628
Jakarta
INDONESIA
Tel: +62 - 21.420 0823
Fax: +62 - 21.420 0052

WEST ASIA

AL Jazirah Solar Energy
Riyadh
SAUDI ARABIA
Tel: +966 - 1. 464.0050
Fax: +966 -1. 464.0053

BP Solar Arabia
PO Box 85652
Riyadh 11612
SAUDI ARABIA
Tel: +966 - 1.498 4864
Fax: +966 - 1.498 4796

Grundfos Gulf
Jebel Ali Free Port
Dubai
UAE
Tel: +84 55166
Fax: +84 55135

JAPAN

Hitachi Ltd
6 Kanda-Surugadai
4-Chome
Chiyoda-Ku
JAPAN
Tel: +81 - 3.258 1111
Tlx: 22395.

Hoxan
13-12 Ginza
5-Chome Chuo-Ku
Tokyo 104
JAPAN
Tel: +81 - 3. 543 2017
Tlx. 02524470
Fax: +81 - 3. 546 1637

Komatsu Electronics
2612 Shinomiya
Hiratsuka
Kanagawa
JAPAN
Tel: +91 - 463 231301
Tlx: 47995 KEMS

Kyocera
Chiba-Sakura Plant
4-3 Ohsaku 1-Chome Sakura-Shi
Chiba - Pref 285
JAPAN
Tel: +81 - 434.981231
Fax: +81 - 434 982215

Mitsubishi Electric
2-3 marunouchi
2-Cho, Chiyoda-Ku
Tokyo 100
JAPAN
Tel: 031 218 3535
Tlx: 24532

Showa Shell
Tokyo Bldg
7-3 Marunouchi 2-Chome
Chiyoda - Ku
Tokyo 100
JAPAN
Tel: 3 215 9661
Tlx: 22373

AUSTRALASIA

BMK
PO BOX 92
Fortitude Valley
Qld 4006
AUSTRALIA
Tel: 07 52 7600
Tlx: 1846
Fax: 07 525505

BP Solar Australia
98 Old Pittwater Road
Brookvale
NSW 2100
AUSTRALIA
Tel: +61 - 2. 938 5111
Fax: +61 - 2. 939 1548

Mono Pumps Pty Ltd
338-348 Lower Dandenong Road
Mordialloc
Vic 3195
AUSTRALIA
Tel: +61 - 3 580 5211
Fax: +61 - 3 580 6659

Rankin Solar
2A Gatwick Road
Bayswater North
Victoria 3153
AUSTRALIA
Tel: 03 729 5177
Tlx: 37489
Fax: 03 729 9234

SAB NIFE
Jungnergatan
Box 3,
S57201 Oskarshumn
SWEDEN
Tel: +46 - 491.16000
Tlx: 43982

Solarex Pty Ltd
78 Biloela Street 2163
Villawood
PO Box 204,
Chester Hill 2162
NSW
AUSTRALIA
Tel: +61 - 2.727 4455
Fax: +61 - 2. 727 7447

Solarwatt
Box 379
Hamilton Central 4007
Queensland
AUSTRALIA
Tel: 617 8541053
Tlx: 41846 AA
Fax: 617 525505

Southern Cross
PO Box 155
Darra
Qld 4076
AUSTRALIA
Tel: +61 - 7.375 3944
fax: +61 - 7.375 4553

Suntron
2/861 Doncaster Road
Doncaster East
Victoria 3109
AUSTRALIA
Tel: +61 - 3. 848 8944
Tlx: 151224
Fax: +61 - 3.848 4873

USA

Armech
PO Box 7906
Atlanta
Georgia 30309
USA
Automatic Power Inc
PO Box 18738
Houston
Texas 77223
USA

Chronar Corporation
PO Box 177
Princeton
NJ 08542
USA
Tel: 609 587 8000
Tlx: 843 394

Currin Corporation
PO Box 1191
Midland
MI 48641
USA
Tel: +1 - 517. 835 7387

Dinh Compnay
Box 999
Alachua
Florida 32615
USA
Tel: +1 - 904.462 3464
Fax: +1 - 904.462 2041

ECD/Sovonics Canon
1100 W Maple Road
Troy MI 48084
USA
Tel: +1 - 313. 362 4170
Tlx: 230648
Fax: +1 - 313. 362 4442

Hydrasol Corp
1001 Alt AIA
Jupiter
Florida 33477 USA
Tel: +1-407 747 3388
Fax:: +1-407.746 1055

Intergrated Power Corporation
7524 Standish Place
Rockville
Maryland 20855
USA
Tel: +1 - 301 294 9133
Tlx: 79 7799
Fax: +1 - 301 294 0809

InterSol Power Corporation
11901 W Cedar Avenue
Lakewood
Colorado 80228
USA
Tel: 303 989 8710
Tlx: 45 4592

Jade Mountain
PO Box 4616
Boulder Co 80306
USA

Jonco Pump Inc
100 Waldron Drive
Durant
Oklahoma 74702
USA
Tel: +1 - 405. 920 2473

A Y Mcdonald Manufacturing Co
4800 Chavenelle Road
Dubuque
Iowa 52001
USA
Tel: +1 - 319 583 7311
Tlx: 43 9020 AYMCE DUQU
Fax: +1 - 319. 588 0720

Midway Labs
2255 E 75th Street
Chicago IL 60649
USA
Tel: +1 - 312.9332027

Photocomm Inc
930 Idaho Maryland Road
Grass Valley
CA 95945
USA
Tel: +1 - 916.477 5121
Fax: +1 - 916.477 5751

Photron Inc
77 W. Commercial Street
Willits
CA 95490
USA
Tel: 707 459 3211
Fax: 707 459 2165

Polar Products
2808 Oregon Court
Bldg K-4
Torrance
CA 90503
USA
Tel: +1 - 213 320 3514
Tlx: 4940451 POLAR LSA

Real Goods
966 Mazzoni St
Ukiah
CA 95482
USA
Tel: +1 - 707 468 9214
Fax: +1 - 707 463 0301

Siemens Solar Inc
PO Box 6032
Camarillo
CA 93010
USA
Tel: +1 - 805 388 6335
Tlx: 6716260

Solarex Corporation
1335 Piccard Drive
Rockville
MD 20850
USA
Tel: +1 - 301. 948 0202
Tlx: 64358
Fax: +1 - 301. 948 7148

Solar Engineering Ltd
1210 Homann Drive SE
Lacey
WA 98503
USA
Tel: +1 - 206. 438 2110
Fax: +1 - 206.438 2115

Solarjack
13901 North 73rd St
Scottsdale
AZ 85260
USA
Tel: +1 - 602.443 - 3655
Fax: +1 - 602.443 - 3657

Speciality Concepts Inc.
9025 Eton Avenue
Suite A
Canoga Park
CA91304
USA
Tel: +1 - 818. 998 5238
Tlx: 662914 SCU CNPK UD
Fax: +1 - 818.998 5253

Sunfrost
PO Box 1101
Arcata CA 95521
USA
Tel: +1 - 707.822 9095
Fax: +1 - 707.822 6213

Zome Works Corporation
PO Box 25805
Albuquerque
NM 87125
USA
Tel: +1 - 505. 242 5354
Fax: +1 - 505. 243 5147

CANADA

Candian Agtech
5037 50th Street
PO Box 2457
Olds AB TOM IPO
CANADA
Tel: +1 - 403.556
Fax: +1 - 403 556 7799

Photron Canada
PO Box 136
Colinton
Alberta TOG 0R0
CANADA
Tel: +1 - 403.675 2586

Intersolar Group Canada
4044 Aberdeen Road
Beamsville
Ontario
LOR 1B6
CANADA
Fax: +1 - 416 563 - 0539

SolarPac
1535 Meyerside Drive
Misissauga
L5T 1MG
CANADA
Tel: +1 - 416 674 1616

CENTRAL AND SOUTH AMERICA

BP Solar
Apartado Aereo 59824
Bogota
COLOMBIA
Tel: +57 1 218 3029
Tlx: 45822 BPCO

Eneressin
PO Box 90880
Bogota
COLOMBIA

Heliodinamica
Rodovia Raposa Tavares KM 41
Caixa Postal 111
06730 Vargem Grande Paulista (SP)
BRAZIL
Tel: +55 - 11.790 0888
Fax: +55 - 11.790 1280

Repprice
Calle 13 Etre Carrera 23Y
24 No. 23 - 66 Barquisimetro
VENEZUELA
Tel: +58 - 51 51250
Fax: +58 - 51 518016

1. INSTRUCTIONS TO TENDER

1.1 Tender Procedure

Tenders are required for a complete solar photovoltaic system as described in the specification. The Schedule for the purchase of system is as follows:

Tender forms issued by(day).....(month).....(year)
Completed tenders to be returned by(day).....(month).....(year)
Tenders awarded by(day).....(month).....(year)
Systems to be delivered by(day).....(month).....(year)

The original tender shall be in the language and shall be filled out in ink or typewritten and will be made a part of the awarded contract.

1.2 Adjudication Process

Tenders will be primarily considered for:

- Performance
- Durability
- Cost effectiveness
- Experience of the tender

The purchaser will not be bound to award a contract to the lowest, or any Tender.

2. SPECIFICATION

2.1 Scope

This specification is for the design, manufacture, supply and delivery of:

The system to be supplied shall include:

- Photovoltaic modules and array support structure
- Load equipment to be specified
- All control equipment and wiring
- All fixings and ancillaries necessary for complete construction and commissioning
- Tools needed for assembly and maintenance
- Spare parts
- Documentation

2.2 Design

The complete system shall be robust, and capable of withstanding hard usage in a harsh environment. It shall be resistant to damage from accidental misuse and reasonably resistant to vandalism and the attentions of animals, wild or domestic.

The system shall be designed for assembly, operation and servicing by unskilled personnel under the guidance of a trained technician. The requirement for special tools or instruments to install and maintain the system shall be minimised and all tools needed for installation shall be supplied with the system. Foundations or other preparatory work shall be as simple as practicable.

The system shall be designed for assembly from units which can be packed in containers small enough to be easily man-handled and transported on small vehicles. The maximum permitted dimensions for any one unit are:

The system shall be designed to operate for a long lifetime with minimum deterioration of performance. The design life of the whole system shall be at least ten years with a minimal need for replacement of components. Routine maintenance shall be minimised and maintenance work necessary shall be as simple as possible, requiring only a few basic tools for its execution.

2.3 Environmental Conditions

The system shall be designed to meet the requirements of this Specification under the following environmental conditions:

- (i) Ambient air temperature between and (eg: 5°C and 45°C).
- (ii) Relative humidity up to at an ambient temperature of (eg: 90% and 45°C).
- (iii) Wind speed up to km/hr (eg: 150 km/hr) (for fixed installations).
- (iv) A maximum altitude above sea level of m (eg: 2000m).

The system should also be resistant to the following extremes of environment eg:

- (i) Sand storms
- (ii) Typhoon or hurricane winds
- (iii) Overnight freezing temperatures

The Contractor shall state the limits of environmental conditions under which the system is designed to operate.

2.4 Standards

Photovoltaic modules shall comply with the test requirements of the current Photovoltaic Module Control Test Specifications of the Commission of the European Communities Joint Research Centre (Ispra Establishment).

2.5 Performance Requirement

2.5.1 Location

The system to be supplied is to be located as detailed below:

- Name of nearest village/town:
- Country:
- Latitude:
- Longitude:

2.5.2 Required Performance

The required performance of the system is summarized in Table 1, along with the typical environmental conditions for the locations. The system should provide average daily output as specified in Table 1 for each month, provided that the specified monthly mean average daily solar irradiation for the month is met or exceeded. The tenderer shall state the output of the system expected for each month of the year. (The user should supply Table 1).

2.5.3 Installation Details

The sketch of the site is shown in Figure 1. (The user should add this).

2.6 Spare Parts

The Contractor shall supply with the system sufficient consumable items (such as motor brushes and fuses) which may need replacement to last for 2 years of operation. Space nuts, bolts, washers etc, likely to be lost during shipment and erection shall also be supplied at the time of shipment.

2.7 Packing for Shipment

All equipment shall be carefully and suitably packed for the specific means of transportation to be used, so that it is protected against all weather and other conditions to which it may become subject.

Complete assembly and operating instructions are to be included in packing.

2.8 Documentation

Prior to shipment of the equipment, the Contractor shall submit to the Purchaser the following documents: (Copies also should be shipped with system).

- (i) A list of components and assemblies to be shipped including all spare parts and tools
- (ii) The size, weight and packing list for each package in the shipment
- (iii) Assembly instructions
- (iv) Operating instructions
- (v) Instructions for all maintenance operations and the schedule for any routine maintenance requirements
- (vi) Sufficient descriptions of spare parts and components to permit identifications for ordering replacement
- (vii) Revised drawings of the equipment as built if different from the approved proposals

All documents shall be in the language.

2.9 Tools

The Contractor shall provide two sets of any special tools and other equipment that are required for erecting, operating, maintaining and repairing the equipment. Special tools shall include such items as Allen or socket keys, box spanners, feeler gauges, grease guns etc. A single set of all other tools required for erection shall also be supplied.

2.10 Insurance

The contractor shall arrange for the equipment to be comprehensively insured for its full value from the time it leaves his premises until clearance from customs at the point of entry into the country of installation.

2.11 Warranty

The contractor shall specify the period of the warranty together with a list of items covered under the warranty.

3. QUESTIONNAIRE FOR TENDERS

Tenders are asked to supply the following information to demonstrate their ability to meet the requirements of the project. All information will remain confidential.

3.1 General Information

Name of Company:

Individual Contract:

Address:

Tel:

Telex:

Fax:

Legal status (eg: limited company)

Country in which registered:

Total number of employees:

3.2 Experience of Tenderer

Number of years of experience with photovoltaic (PV) system:

Product Experience (list number in use of each main product type eg: pumps, lights, refrigerators etc):

-
-
-
-
-

3.3 Sources of Supply for Equipment Tendered

Items manufactured by Contractor:

Items bought in from Suppliers:

3.4 Maintenance Requirements (detail and frequency)

-
-
-
-
-

3.5 After Sales Service

Tenderers to list names, addresses, telex and telephone number of persons and organisation who may be contacted for advice during the period of installation and operation of the equipment.

4. PRICE AND DELIVERY

Terms of payment % on order
..... % on delivery
..... % on satisfactory operation

Item	Description	Currency	Price
1.	Equipment		
2.	Transportation (from place of manufacture to point of entry) of complete pumping system, including insurance by air/ship		
3.	Other		_____
	Total Contract Price		Total:

4. Spare parts (list prices of spare parts:
- -
 -
 -
 -
 -

Delivery of complete system to be weeks from receipt of order.

Small solar-electric (photovoltaic) powered devices are gradually being introduced into developing countries for water pumping, vaccine refrigeration, lighting, battery charging and other important development applications. Most of these have been purchased in small numbers by individuals, private voluntary organizations and donor agencies. The number of systems currently in use (although numbering tens of thousands) is extremely small compared to the potential demand. A major reason for this is a lack of awareness of how to go about purchasing and using these devices and a scarcity of information on products available in a form suitable for development workers. Recognizing this lack of information, the Swedish Missionary Council, IT Power and the Stockholm Environment Institute produced this guide.

The authors of this book are photovoltaic applications specialists with IT Power and the Stockholm Environment Institute. IT Power is an international firm of engineering energy consultants which specializes in the implementation of new and renewable energy technologies for rural development. For further information contact IT Power Ltd., The Warren, Bramshill Road, Eversley, Hants RG27 0PR, UK.

The Stockholm Environment Institute (SEI) is an international research organization specializing in environmental technology and management. The main themes of activities are at present global energy futures, climate change, biotechnology in agriculture, and the areas of economics, ethics and environmental value. A major component of SEI's energy programme is related to Third World energy utilization and technologies. The Institute's headquarters are in Stockholm, with branch offices in Boston (USA) and York (UK).

The Swedish Missionary Council is an organization dedicated to sustainable progress in less developed countries through missionary work and project support.

ISBN 1 85339 091 7



The Intermediate Technology Development Group was founded by the late Dr E.F.Schumacher. Intermediate Technology enables poor people in the Third World to develop and use technologies and methods which give them more control over their lives and which contribute to the long-term development of their communities.

Intermediate Technology Publications is the publishing arm of the Intermediate Technology Development Group and is based at 103/105 Southampton Row, London WC1B 4HH, UK.