

Auto-Electric Basic Technology – Part 1

Table of Contents

| | |
|---|----------|
| Auto-Electric Basic Technology – Part 1 | 1 |
| <u>1. Fundamentals of electricity</u> | 2 |
| Electricity..... | 2 |
| Electron Theory of Electricity..... | 2 |
| Size of atoms..... | 3 |
| Insulators and Conductors..... | 4 |
| Speed of electricity..... | 4 |
| Types of electrical circuits..... | 6 |
| Measuring resistance..... | 7 |
| Direction of current..... | 9 |
| <u>2. Batteries and service of them</u> | 10 |
| Battery functions..... | 10 |
| Battery construction..... | 10 |
| Elements..... | 12 |
| Battery inspection..... | 14 |
| Battery problems..... | 16 |
| Change of a battery..... | 18 |
| Automotive battery/TV-battery..... | 18 |
| <u>3. Lighting and signal circuits – Accessories and wiring</u> | 20 |
| Lighting and signal circuits..... | 20 |
| Switches..... | 23 |
| Electrical circuits..... | 25 |
| Connections..... | 27 |
| Bulbs..... | 28 |
| Fault finding..... | 29 |
| <u>Technical drawing of circuit diagrams</u> | 30 |

Auto–Electric Basic Technology – Part 1

CRYSTAL

Lehr– und Lernmittel,
Informationen, Beratung

Educational Aids
Literature, Consulting

Moyens didactiques,
Informations, Service–conseil

Material didáctico,
Informaciones, Asesoría

DED–Namibia



Deutsche Gesellschaft für
Technische Zusammenarbeit (GTZ) GmbH

AUTO – ELECTRIC/BASIC – TECHNOLOGY

Special edition in the field of Vocational Training in Namibia

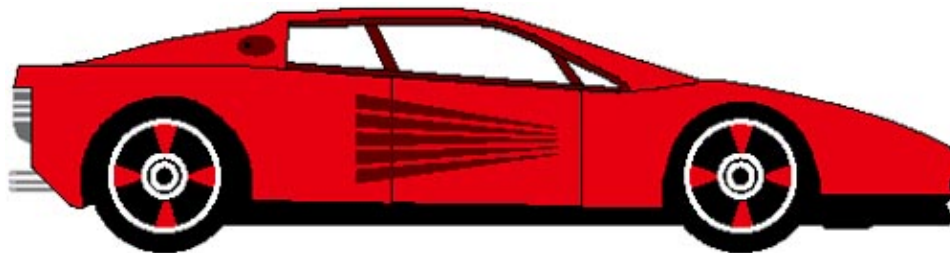

WRITTEN BY:

**HARTMUT ARLITT/GERMAN DEVELOPMENT SERVICE IN NAMIBIA INSTRUCTOR AT THE RUNDU
VOCATIONAL TRAINING CENTRE**

BY USING PARTS OF:

1. Automotive Encyclopedia/Fundamental Principles, Operation, construction, Service and Repair 1995 Edition; South Holland, Illinois; The Goodheart–Willcox Company, Inc.
2. Different information material of the BOSCH company Germany
3. Different teaching material from the Deutsche Gesellschaft fuer Technische Zusammenarbeit (GTZ) GmbH
4. Own material, scripts and circuit diagrams

November 1997

1. Fundamentals of electricity

Electricity

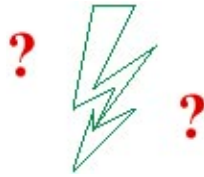

Electricity has a vital role in the safe and reliable operation of modern automotive vehicles.

In such cases we do speak about a simple circuit by using only one consumer (i.e. a bulb) and one switch as well as about complete electrically systems (i.e. starting systems, recharging systems, ignition systems, lighting and signal systems).

If someone wants to be successfully as an auto-electrician concerning maintenance, troubleshooting or reparation he or she will have to have a clear knowledge to the following basics.

Electron Theory of Electricity

Many different theories have been advanced regarding the nature of electricity but no one can just explain what electricity really is. Today is generally accepted the **electron theory**.

This theory proposes that all matter (earth, rocks, minerals, elements, etc.) consist of tiny particles called **molecules**. These molecules are made of two or smaller particles called **atoms**. The atoms are divided further into smaller particles called **protons, neutrons and electrons**.

Protons, neutrons and electrons are the same in all matter like gases liquids or solids. The different properties or characteristics of all these matters are to see according to the **arrangement and number of protons, neutrons and electrons** to build in the end a specific atom.

Proton



The **proton** has a **positive charge** of electricity naturally.

Electron



The **electron** has a **negative charge** of electricity naturally.

Neutron



The **neutron** has **no charge** at all, but **adds the weight** to the matter.

Central core of an atom

Protons and neutrons form the *nucleus* (central core) of the atoms. The electrons revolve around the nucleus.

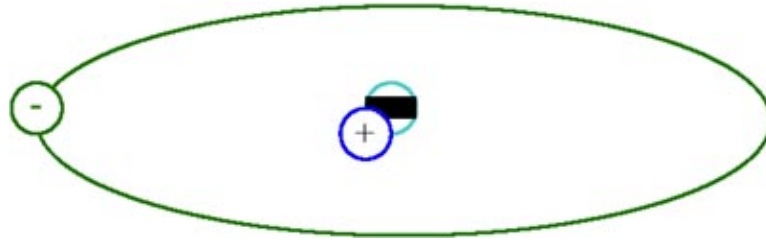

The **simplest atom is the hydrogen atom** (see above). It consists of one positive charged proton and one negative charged electron.

Other atoms are much more complicated. For example a copper atom has 29 electrons revolving around the nucleus in four different orbits.

Size of atoms

0,000 000 000 000 000 000 000 000 911

To understand the size of an atom is really difficult.

For example the mass of an electron in gram (like physicists established it) contains behind the comma first after 27 zeros the numbers 911.

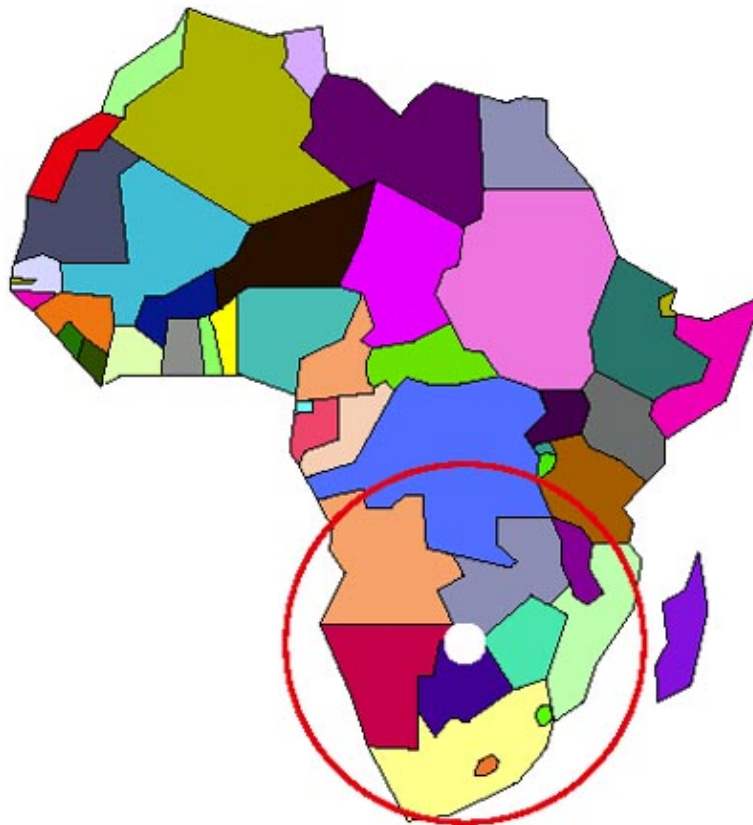

And for an atom let's use another example.

If we would think the size of a proton from a hydrogen atom could have the size like a football and could be located in Victoria Falls then its orbit would reach from the Atlantic coast of West Africa to the Pacific coast of East Africa. Now think about a piece of copper: 10 mm thick, 10 mm long and 10 mm wide. Such small pieces mean, **atoms and also electrons and protons are extremely small and relatively vast distances separate them.** There should be a clear understanding when we speak about the flow of electrons!

Insulators and Conductors

Insulators

In most of the elements the nucleus is surrounded by closely held electrons that never leave the atom. These are called **bound electrons**.

If these **bound electrons are in the majority** in an element or compounded material **then the material is called an insulator** (non-conductor of electricity).

Conductors

In other types of material the nucleus is surrounded by electrons that can move freely from one atom to another one if they are forced by applied electricity.

These electrons are known as **free electrons**. Materials made with these atoms are called **conductors** of electricity.

Speed of electricity

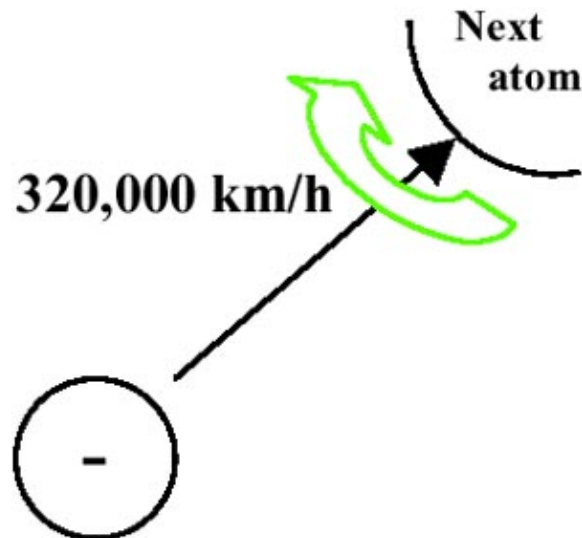

Free electrons in a conductor material are pulled from one atom to another one and so on. By moving that extremely short distances in the case of being forced through electricity, the electricity it self develops a speed of around 320,000 km/h.

As the electrons are moving they temporarily rotate around each new centre. We already know an electron carries a negative charge of electricity and so the **electron flow (current flow) is assumed to be from negative to positive.**

Electron drift

The rate of drifting of the free electrons from atom to atom determines the amount of current. To create a drift of electrons through a circuit we must have an **electrical pressure, the voltage.**

The more electrons the stronger the current.

That means i.e. **in the case of a starter battery,** the greater the concentration of electrons at a battery, **the higher the pressure between the electrons and the greater that pressure is, the greater is the flow of electrons.**

Volts, Amperes, Ohms, Watts

The **pressure between the electrons**, namely **voltage**, is measured in **volts (V)**.

One unit of volt is the Potential Difference (P. D.) between two points of a conductor by a constant current flow of one ampere (1 A) when the power dissipated between these points is equal to one watt (1 W).

The **flow of electrons, the current**, is measured in **ampere (A)**.

One unit of ampere is that constant current (I) that (if maintained in two parallel rectilinear conductors of infinite length of negligible cross section and placed at a distance of one meter apart in vacuum) **would produce between the (these) conductors a force equal to 2×10^{-7} Newton per meter length.**

Opposing the flow of electrons is the resistance of the conductors **measured in ohms (?)**.

One unit of electrical resistance (R) is the resistance between two points of a conductor if a constant Potential Difference of one volt (1 V) applied between these points produces a current of one ampere (1 A) and the conductor isn't the source of an electromotive force.

Some materials offer a bigger resistance to the electron flow than others. For example the **resistance of iron is higher than the resistance of copper**, but the **resistance of silver is less than the one of copper**. Also the **length and the size of a wire are important facts to look for** in that case.

The **electric power (P) is the product of voltage (E) and current (I)** and is measured in **watt (W)**.

$$P = E \times I; (P = U \times I)$$

Electrical loads such as i. e. electric motors, coils and bulbs **will consume power**.

Ohm's Law

The **Ohm's Law is the understanding of the mathematical relationship between voltage (E), current (I) and resistance (R) in an electrical circuit**. Each and every one affects the other one.

The formula of Ohm's Law: $E = I \times R$

(voltage = current x resistance)

Sometimes you will find the formula is written in another way:

$$\frac{V}{IR}$$

or so:



All that is the same and that means:

The Potential Difference (PD = voltage) in a conductor is under constant conditions equal to the current flow multiplied with resistance (oppose directed to the current) of the conductor.

The current through a conductor under constant conditions **is proportional to the difference of potential**

across the conductor.

$$I = \frac{E}{R}; \left(I = \frac{V}{R}; I = \frac{U}{R} \right)$$

By using Ohm's Law is it possible to calculate

- voltage: $V = I \times R$;
- current: $I = V/R$;
- resistance: $R = V/I$.

Types of electrical circuits

We do know three general types of electrical circuits:

Series circuit; **Parallel** circuit; **Series-parallel** circuit. For all circuits there are a need for an electricity source (battery), electrical equipment (switch, bulb, etc.) and electrical conductors (wires) to connect the equipment with the source.

Series circuit: The current passes from the power source to each device in turn and then flows back to the other terminal of the source (**only one path has the current**). The amount of current will be the same in all parts of the circuit.

Parts of a simple electrical circuit:

- source of electricity
- switch
- cable
- consumer

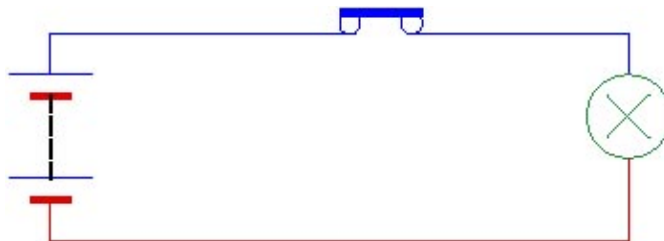

Parallel circuit: One terminal of each device is connected to a common conductor, which leads to one terminal of the source. There is **more than one path for the current to flow** and therefore each and every path has a separate amount of current flow depending on the equipment by forcing a weaker current flow or stronger one.

Parts of a circuit:

- one source of electricity
- cable and eventually cable connectors
- the quantity and kind of switches and consumer depends on the kind of the circuit

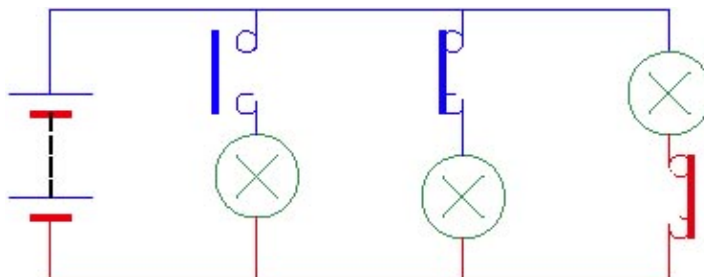

Series-parallel circuit: Such kinds of circuits have electrical devices connected in series and others connected in parallel. That means we do have **more than one path for the current to flow**.

Make sure what parts of the circuit are connected in series and/or in parallel.

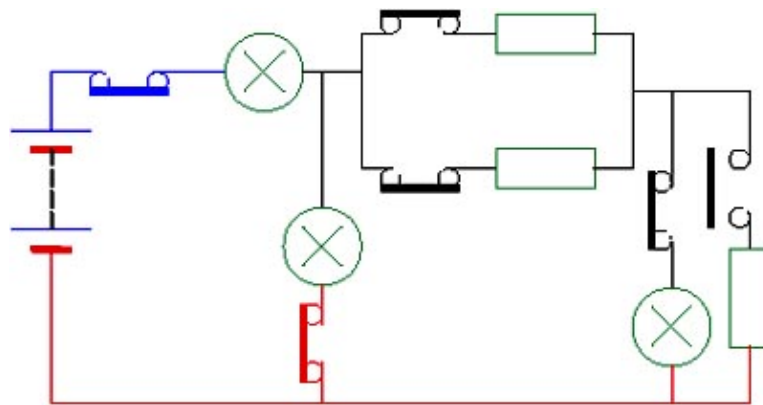

Measuring resistance

To find the total resistance (R_T) of a *series circuit* is to add the resistance of each device.

This means as well, **when a number of resistance's are connected together in series the *current* is the same in every part of the circuit.**

In series the ***P. D. (Potential Difference)*** across each resistance is in general different. The overall ***P. D.*** is equal to the sum of all ***P. D.*** across the individual resistances.

Remember: There is only one path for the current flow.

$$R_T = R_1 + R_2 + R_3 \quad R_1 = 2?$$

$$R_2 = 5?$$

$$R_3 = 4?$$

$$R_T = 2 + 5 + 4 + 1 = 12? \quad R_4 = 1?$$

The flowing current in this circuit can be found by applying Ohm's Law:

$$V = I \times R \quad \curvearrowright \quad I = V/R \quad V = 12 \text{ V}$$

$$I = 12 \text{ V}/12?$$

$$I = 1 \text{ A}$$

In a ***parallel circuit*** we do have more than one path for the current flow. **Therefore the total resistance of all the devices will be less than the resistance of any single device.**

Resistance is the ability of any wire or electrical component to oppose the flow of current.

Conductance is the reciprocal (opposite) of resistance.

To find the total resistance in a parallel circuit the easiest way is to use the conductance formula:

$$\frac{1}{R_T} = \frac{1}{R_1} + \frac{1}{R_2} + \frac{1}{R_3} + \frac{1}{R_4}$$

$$R_1=3?$$

$$R_2=6?$$

$$R_3=4?$$

$$R_4=4?$$

$$\frac{1}{R_T} = \frac{1}{3} + \frac{1}{6} + \frac{1}{4} + \frac{1}{4}$$

Invert both sides of the equation (equal factors).

$$\frac{1}{R_T} = \frac{4}{12} + \frac{2}{12} + \frac{3}{12} + \frac{3}{12} = \frac{12}{12} = 1\Omega$$

The total current flow through the circuit will be:

$$I_T = V/RT$$
$$I_T = 12 \text{ V}/1 \text{ ?}$$
$$I_T = 12 \text{ A}$$

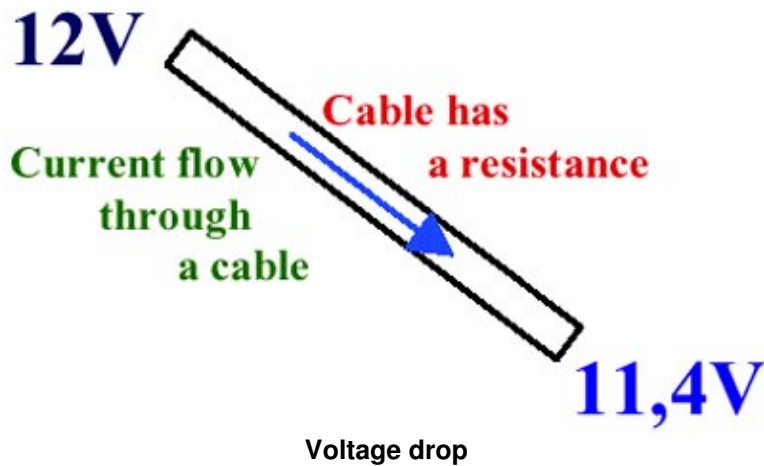

The **decrease in voltage** as current passes through a resistance is known as **voltage drop**. The sum of individual voltage drops is equal to the total voltage on For **calculation of the voltage drop** in all the different parts of the circuit can be used Ohm's Law.

Let's use the examples we had already ($R_1 = 2?$; $R_2 = 3?$; $R_3 = 5?$):

Series circuit: Current = 1 A (all over)

$$\text{Voltage drop} \Rightarrow V = I \times R$$

1. part 1 A \times 2 ? = 2 V
2. part 1 A \times 5 ? = 5 V
3. part 1 A \times 4 ? = 4 V
4. part 1 A \times 1 ? = 1 V

$$= 2 + 5 + 4 + 1 = 12 \text{ V}$$

Parallel circuit: Voltage drop $\Rightarrow V = I \times R$

1. part 4 A \times 3 ? = 12 V
2. part 2 A \times 6 ? = 12 V
3. part 3 A \times 4 ? = 12 V
4. part 3 A \times 4 ? = 12 V

Direction of current

The **positive ions in liquids move from the positive to the negative pole** (technical direction of current flow).

The **electrons in a liquid flow** in the opposite direction, **from negative to positive**. **Electric current can flow only in a closed circuit.**

Loads and conductors close a circuit and a switch will control the circuit. The **current flow in a circuit goes on from positive to negative.**

Alternating current (AC)

The **current changes its strength and direction periodically.**

The free electrons oscillate to and from along the conductor axis.

One complete oscillation is a period or a cycle and the **amount of complete periods per second is called frequency, measured by using the unit Hertz (Hz).**

Direct current (DC)

Direct current flows always in the same direction and at a constant current strength as long as the circuit resistance doesn't change.

The free electrons move continuously at the same speed as well.

This kind of current flow we do have in all the motor vehicles by connecting the different consumers.

There is one difference only.

The **recharging system** in motor vehicles is in modern cars **equipped with an alternator.**

This **alternator generates** for the recharging process an **alternating current**. For getting useable that current in a motor vehicle is it **therefore** necessary to **rectify the current as a direct current** what is done by a diode assembly as rectifier unit.

On each and every consumer in a motor vehicle the amount of voltage is 12 V.

It is important to understand why we will find that most of the consumers in motor vehicles are connected in parallel to the power source.

Electrical work and power

The **electrical unit for work** is called **joule**.

One joule is equal to one ampere flowing for one second under the pressure of one volt.

$$1 \text{ J} = 1 \text{ A/s} * 1 \text{ V}$$

Work is done when energy is expended.

Work is the product of force multiplied by the distance through which it acts in overcoming resistance.

An electrical force may exist without work being done. This is the **condition** that exists **between the terminals of a battery when no equipment is connected** to them.

When a piece of equipment is connected to the terminals of a battery then current will flow and work will be done.

Power is the **rate of doing work:**

$$\text{Power} = \frac{\text{work}}{\text{time}}; \text{electrical power} = \frac{\text{electrical work}}{\text{time}} = W$$

The **electrical unit of power** is **Watt**.

One watt = to one joule of electrical work per second

$$\text{Watt} = \frac{\text{Joules}}{\text{Seconds}} = \frac{\text{Volts} \times \text{Amperes} \times \text{Seconds}}{\text{Seconds}}$$

$$P (W) = E (V) * I (A)$$

$$\text{Watt} = \text{Volts} \times \text{Amperes}$$

That means, if in an electrical circuit by using 12 V one bulb is connected and a current of 1,75 A is flowing than the number of watt is 21 W.

$$P = E \times I; P = 12 \times 1,75; \underline{P = 21 W}$$

2. Batteries and service of them

Batteries in motor vehicles

The battery is an electrochemical device that **converts chemical energy into electrical energy**. When the battery is connected to an external load (consumer), such as a lamp, a starter motor or a radio, the energy conversion takes place and so electricity flows through the circuit. In modern cars we will find the **lead-acid storage batteries**.

Battery functions

Lead-acid storage battery has three main functions:

1. It is the **source of power** for the starter motor and the ignition system when cranking and starting an internal combustion engine.
2. It is the **stabiliser of voltage** for the entire automotive electrical system.
3. It **gives current for a limited time** when electrical demands exceed the alternator output.

Battery construction

Most of the used batteries are constructed as **12 V batteries**. In several types of motor bikes there are small **6 V batteries** also used. Lorries with 24 V electrical systems are using two 12 V batteries (in series connected).

The material of the battery case can be hard plastic or hard rubber. Inside this case are the walls for the cells that completely insulate one cell from the other one. The plates and connectors are made from lead alloy.

A typical **12 V lead-acid storage battery is made up of six cells connected in series**. Inside the cells do separators separate positive plates and negative plates. The **cells are filled with electrolyte** (sulphuric acid diluted with distilled water).

Each cell produces (if fully charged) **2,1 V**. This means a **fully charged battery** with 6 cells (series connection) **has a voltage of 12,6 V**.

The **cells** itself **are separated** by each other. The positive and negative separated plates inside each cell are in the top of the **plates connected with plate straps**. From there the whole **battery is cell by cell connected in series**.

We know **conventional batteries** (wet, moist or dry charged), **low-maintenance batteries**, **maintenance-free batteries** (low water loss) and **hybrid batteries** (negative plates with a lead callium alloy). All of these types in their basic construction are very similar.

Sizes and types

Lead-acid storage batteries vary in size, capacity and cranking power.

The main point is that **a bigger surface of the plates brings a higher capacity of the battery**. A bigger battery by using more plates per cell and/or higher and wider plates has therefore a higher capacity.

In an automotive battery there **are many thin plates** to give those big surface area of plate material to the electrolyte **to generate** also **a very high current for a short while** (starting process). Such kind of battery is not suitable for powering a TV.

Cells, plates, separators

Each of the six cells of a 12 V battery contains **plates**. Negative plates and positive plates are **composed of special active material contained in grids**.

Pure lead is too soft for manufacturing of grids, so it is **alloyed with** a small percentage of **antimony for strength**. Every cell contains **one negative plate more** than positive plates. The reason is that the active material of the positive plates is softer than the one from the negative plates. By having one negative plate more there is on every side of the positive plates a negative one and the active material from the positive plates cannot break out so easily.

The **purpose of the grids** is to provide a supporting **framework for the active material** and also to conduct current. The positive and negative grids are made **by pasting them with a muddy mixture of lead oxide, sulphuric acid and water**. Fibre additives give cohesion (stick ability) to keep the active material connected to the grids.

Expanders are added to the negative plate paste to prevent the negative material from contracting during operation and changing into an inactive state, which would inhibit the constant chemical reaction in normal operation i. e. it keeps the plates spongy.

The paste is mechanically applied into the plates and than the plates go on a partial drying process.

Positive plates are now **pink**.

Negative plates are **slightly grey** due to expander material and binders.

The plate grids can have the following structure:

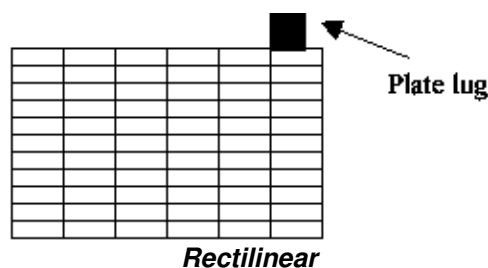

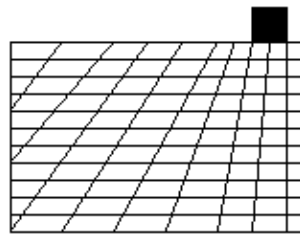

Radial

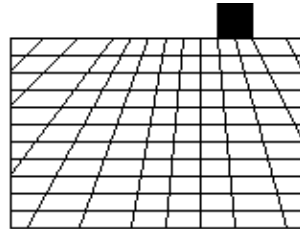

Centre Lug Radial

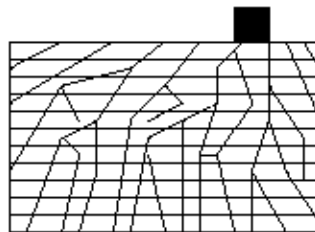

"Tree"

Separators are *thin porous sheets with insulating abilities*. They are sandwiched between positive and negative plates to prevent shorting.

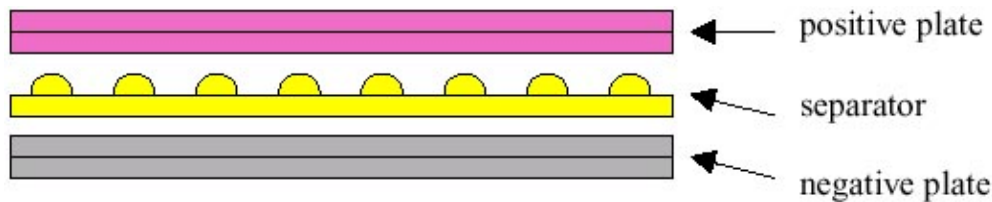

Fine pores allow *free electrolyte movement* around and through the separators. **Ribs** allow gas bubbles to surface and as the positive plate needs 1,6 times as much electrolyte to operate, ribs are pointed **towards** the **positive plate**.

An alternative type of separator is the **envelope separator** (polyethylene envelope).

Elements

Varying numbers of plates are held together by soldering or pressing the **lugs** of the negative plates and separate of this by soldering or pressing the lugs of the positive plates together. This is formed in the cells, **cell packs called elements** by using separators between the negative and positive plates to insulate them from each other.

Remember:

- there is always one negative plate more in the cells.
- more plates = more surface area = greater capacity = higher cranking capacity = greater efficiency.

Terminal posts are formed on the first and the last cell elements of a battery. Short circuit tests are performed on all elements. **Cells** are inserted into **containers** and soldered or pressed **through holes** in the

cell walls (by using cell connectors) **in series**.

- **2,1 V per cell**/element (regardless of size);
- = **12,6 V** by using a battery with **6 cells**.
- = **6,3 V** by using a battery with **3 cells**.

The **cover** (in top of the battery) with the posts is **heat bonded** to the container and normally checked with compressed air for leaks.

Today heavy-duty batteries only have external cell connectors sealed by a special sealing compound (bitumen based). All the smaller batteries have the cell connectors under the battery cover.

Vent plugs and vents

Vent plugs have various designs. They usually have a hole where the **gas can escape** but the **electrolyte splashed into the vent will drain back into the cell**. The plugs may be screw type or push-in type.

Electrolyte

The battery is activated by addition of electrolyte.

Electrolyte is a mixture of sulphuric acid and distilled water. This **solution causes** the **chemical actions** to take place **between** the **lead dioxide** material of the **positive plates** and the **lead** material of the **negative plates**.

The **electrolyte is** also the **carrier** by moving **of the electric current** between the positive and the negative plates **through the separators**.

Lead-acid batteries use a concentrated solution of sulphuric acid and water.

The **density (specific gravity) of electrolyte in a fully charged battery**

= **1,260 g/cm³ and above**.

The density in a **half charged battery**

= **1,190 g/cm³**.

The density in a **discharged battery**

= **1,120 g/cm³**.

The **specific gravity of water**

= **1,000 g/cm³**.

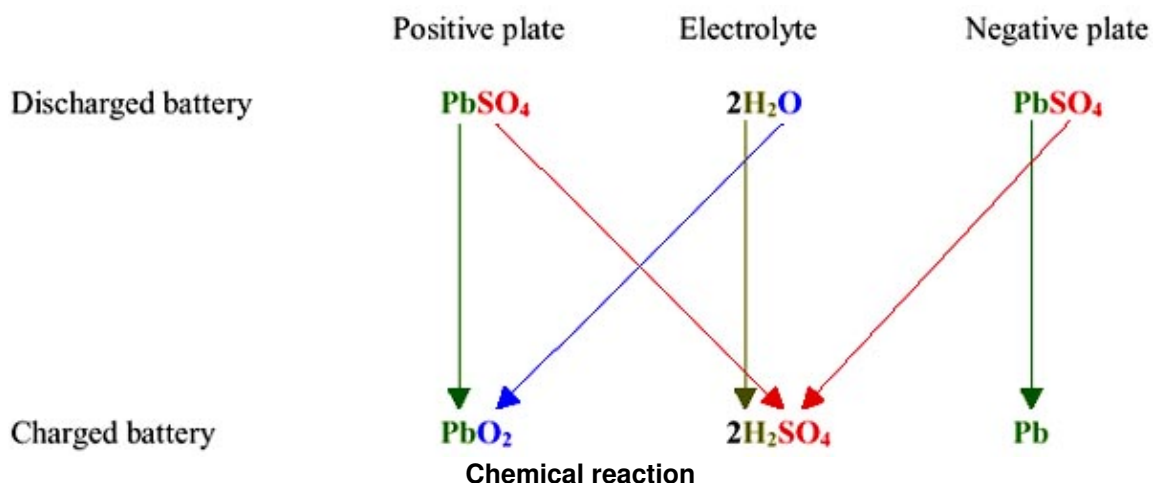

| Specific gravity reading | % state of charge |
|---------------------------------|--------------------------|
| 1260 and above | 100 % |
| 1225 | 75 % |
| 1190 | 50 % |
| 1155 | 25 % |
| below 1155 | discharged |

Battery inspection

A **visual inspection** is the first step if you should test a used battery. Look carefully for defective cables, eroded cable clamps, accumulated corrosion deposits, cracks in the battery case or cover and loose or broken hold-down devices. Clean, repair and/or replace the parts as required.

Testing with a hydrometer

Handling the hydrometer:

1. Suck up sufficient electrolyte to float the float.
2. Hold the hydrometer vertically; the float must not rub on the tube wall.
3. Read hydrometer on the bottom of meniscus.
4. Keep the hydrometer clean by rinsing after each battery test.

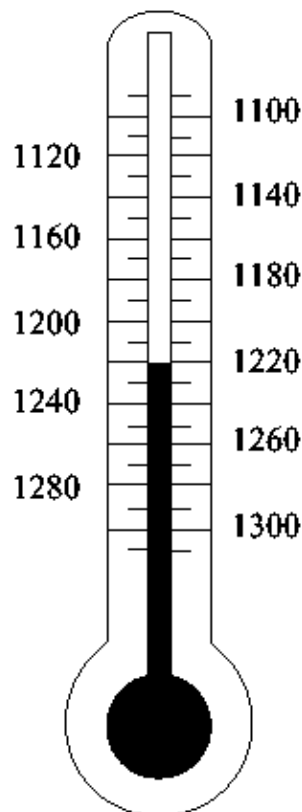

Float of the hydrometer with scale

Test with the hydrometer **after topping up** (if necessary) with distilled water needs **a boost-charge** of the battery for 15 minutes by +/- 20 A to mix H_2O with H_2SO_4 and to obtain an accurate reading. That should be **the only use of a boost charge**.

The **electrolyte level** must always be between 1,0 and 1,3 cm over the top of the plates.

Do not overfill the battery with electrolyte. If that is done the **electrolyte will splash out** by using the battery in a car and so it may create problems (see at "visual inspection").

By doing the **hydrometer test** is to **check each cell of the battery**. Compare the lowest and the highest readings. If the difference is higher than 50 points (i.e.: 1. cell = 1250 and the 2. cell = 1190 equals to a **difference of 60 points**) the **battery should be charged for 8 hours**. After that the **density should be taken again**. If the difference **didn't change under 50 points**, then we have to realise that the battery is **not serviceable anymore**.

If the above mentioned situation isn't like that, then the battery should get fully charged. And also after charging, the density of the electrolyte should be taken again to ensure it is right.

A good possibility can be to give all the cells numbers. So it is easy to follow up the later readings without getting confused by handling more than one battery. **Note:** Heated fluid is less dense. Therefore the float will sink. The **right reading** can be taken **by a temperature of 27°C**. After charging the battery should stand for a while to cool off before the next hydrometer test. Another possibility is to **add 0,004 points** of the read density **for every 5,5°C above 27°C** and to **subtract 0,004 points for every 5,5°C below** the normal temperature factor.

Load test

The load test of a battery takes place by using a **battery load tester**.

The following steps are important to do:

1. **Determine the load** to be used (as found in the code print).
2. **Do not exceed** this figure.
3. With removed vent caps the tester has to be in switched off position and **care should be taken** by connecting the battery.
4. The **tester is to activate** by adjusting it to the right amount flowing current (see point 1.) and the test is to run **for a full 15 seconds** (but not longer).
5. During that test the **voltage should not drop below 9,4 – 9,6 V** on a 12 V battery.
6. If one or more cells experience a high rate of **gassing during that load test**, the battery is **suspect**.

Open-circuit voltage test

If the **battery fails the load test** than is to check its state of charge by making a stabilised **open-circuit voltage test**. But **after the load test** the battery should be given a time of at least **10 minutes to recover**.

This test is to do by the use of a voltmeter. The battery must have a **temperature** between 15°C and 35°C. If the battery is in good condition than the voltmeter should show 12,4 V. If the **state of charge is below 75%** the battery should **be recharged and load tested again**. **Fails the battery** the load test the **second time**, the **battery should be replaced**.

Examples for **cold crank capacities** in the case of battery codes:

619 622H 650

106/3/A/Y

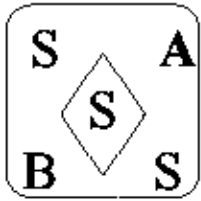

AUTOBAT
(106)

106/4/A/Y

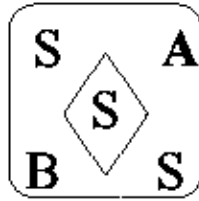

AUTOBAT
(160)

180/3/A/Y

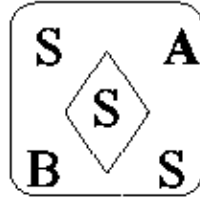

AUTOBAT
(180)

Battery problems

Most batteries fail due to various forms of abuse. The most common causes are:

1. **Dirty and corroded battery terminals** which lead to high resistance in the electrical circuit.
2. **Loose battery terminals** cause the melting of the terminals and can result in sparks, which will lead to an explosion in the battery (very dangerous!).
3. **Vibration.** Holding clamps, which are not properly fixed, tightened results in the active material parting from the grids and the capacity of the battery get reduced.
4. **Over-tightening of hold down clamps.** The container will crack or cause damage to other parts of the vehicle.
5. **Hammering on battery poles** will loosen the terminals or break the internal components. Always use correct sizes of the spanners when replacing/removing terminal clamps. Never loosen by force.
6. **Dirt and damp** on the battery will cause a gradual selfdischarge.
7. **Overcharging** causes an excessive loss of water and consequently causes the plates to shake off their active material (reducing capacity and service life).
8. **Undercharging** causes the plates to sulphate (reducing capacity and service life).
9. **Standing in a discharged state** will, too, force in the battery plates sulphation and irreversible damage.
10. **A faulty regulator or alternator** will lead to the contents of the points 7. and 8. (see above).
11. **A loose fan belt** leads to the discharge of the battery. Periodic attention to the battery as well as to the remainder of the electrical system, including the fan belt tension, is essential for trouble-free service in any vehicle.
12. **Incorrect electrolyte levels.** If these are too low, plates dry out and sulphate. If these are too high, electrolyte escapes through the air holes, which can lead to acid damages.
13. **Adding acid instead of water** increases the density of electrolyte to the point where it attacks the plates.

The battery is the first item to be blamed when a vehicle does not start.

But do you check always the causes shown above?

Charging methods

Follow up the ***manufacturer's operating instructions***. Untrained staff should not be allowed to use test- and charging equipment.

Observe safety precautions. Never connect or disconnect testing or charging equipment unless they are switched off.

Generally: ***Charge at or under 6A***. Specific charging rates cannot be specified because of different capacities as well as differences of temperatures, state of charge and battery ages.

Stick to the 6A rule and you cannot go wrong.

Five identical batteries charged in parallel by using a charger output = 20 A, gives each battery 4 A.

Batteries ***charged in series*** receive the full current output of the charger. Batteries with ***different capacities*** can be charged in series, too. But the ***charging rate*** of the ***lowest capacity*** must be used.

High rate charge or boost charge is not recommended except for short periods to mix added water with the electrolyte. If the electrolyte ***density is 1,225 g/cm³ or higher***, than ***never try charge on a higher rates***.

Constant potential charging:

Starts at high rate and as the battery voltage builds up, rate tapers automatically to lower value.

Constant current charging:

Set the charging rate at 2 – 3% of cold crank capacity – as a general rule keep rate under 6 A. It may take 2 – 3 days at slow rate to restore a partially sulphated battery.

Floating charge:

Battery is continuously connected to charging source.

Trickle charge:

Battery gets charged with less than 1A – it is useful for home use.

Battery stocking:

The stocked batteries need to get proofed of the charging situation. If the voltage drops down below 12,4 V – recharge! Stock rotating is necessary (first in = first out).

When battery self discharges below 11,1 V or below 1,010 g/cm³ of the electrolyte density, it will not recover when recharged.

REMARK: If the battery suddenly (***overnight***) becomes ***discharged*** (i.e. by headlights) that will not create a problem like mentioned above. In all it will accept a charge and ***go back into normal charged situation***.

Jump-starting

Jump starting (booster cable instruction) as a general rule: **Do not jump start vehicles fitted with any computer-operated equipment!** Check manufacture recommendations before jump starting vehicles with electronic fuel injection or board computer.

Jump-starting:

- After looking for the mechanical safe situation on both of the cars (gearbox; handbrake) first of all ensure that both cars are negative grounded.
- Now connect the "dead" positive terminal to "life" positive terminal with red cable.
- Connect one end of black cable to "live" negative terminal and the other end of black cable to the chassis or engine block of the "dead" car. Never connect the black cable to the "dead" negative terminal.
- Ensure that the cables are far enough from fan blades and other rotating parts.
- Start "life" car; bring the engine speed on +/-2000 r.p.m. and attempt to start "dead" car.
- If "dead" car isn't starting within 15 seconds, stop the process and check for fuel or ignition problems.
- If "dead" car starts, allow the engine to idle and remove the cables in reverse order (as above mentioned).

Activating of dry charged battery

A dry charged automotive battery contains no electrolyte until it is used in service. The cell elements are given an initial charge on special equipment at the factory. Then they are thoroughly washed, dried and assembled into battery cases.

A dry charged battery will retain its full charge indefinitely if moisture does not enter the cells. **When ready for service, the battery has to be filled with electrolyte and (generally) is given a boost charge.**

After boost charge the battery at 15 A the electrolyte should have a density of 1,250 g/cm³ or higher by a temperature not under 16°C.

The **electrolyte level is after the boost charge to control** and if necessary add only distilled water.

Change of a battery

If there is to replace a battery of a car than it should be a battery with the **correct Ah – rate** suitable for that car. But before replacing we should also ask our selves:

- is it the **battery it self** to create problems?
- will **the same problem** occur **after replacing** the blamed battery?
- can it be **another fault** what causes a discharged battery always again?
- is the **charging system** suspect and/or is the fan belt may be slipping?

We have to make sure what is going on in that cases to get a satisfied customer.

Automotive battery/TV–battery

An **automotive battery is designed for many shallow cycles.** At 10 starts per day = 3,600 starts p.a. +/- 10 – 12,000 starts during the time of service life is expected. For that strong forcing cycles **an automotive battery has many thin plates** to give a big surface area and **to generate very high current for a short while.**

An automotive battery is not suitable for powering a TV–set!

A **TV battery is designed especially for repeated deep cycles.** The **internal construction is different** which results in a good life cycle when powering a TV–set. The **TV battery will be discharged slowly as the TV draws current.** Care should be taken not to discharge the battery too much. That can cause internal damages and shortens the useful battery life (reduces the number of times the battery can be recharged).

Terminology

| | |
|-------------------------------|---|
| Active mass: | That part of the battery (pressed into the plate grids) which is subject to chemical change when current is passing (charging; discharging). |
| Internal resistance: | The internal resistance is the sum of various resistances' of the internal battery circuit. Transfer resistance between the electrodes and the electrolyte, resistance of the electrodes to the flow of electrons, resistance of the internal connecting parts, etc. |
| Capacity: | Is the quantity of electricity in ampere–hours, which can be drawn from a battery. It is used to classify the batteries. |
| Terminal voltage: | It is the voltage between the two terminals of the battery. |
| Charging voltage: | The charging voltage depends on the state of charge of the battery, the charging current and the temperature. It is always higher than the off–load voltage. |
| Charging current: | It is the current at which a battery gets charged. |
| Service life: | The normal service life of a battery has a duration of three years but it depends on how well the battery is maintained, the operation conditions and the leakage current. |
| Nominal voltage: | It is a fixed value and is set at 2,1 V in the case of one lead acid cell. |
| Nominal capacity: | Nominal value in the case of 20 hours discharge with a discharge current equivalent to one tenth of the nominal capacity. The acid temperature should has +27°C. The final discharge voltage per cell = 1,75 V. |
| Acid relative density: | It is also called "specific gravity". Battery in charged state 1.260 g/cm ³ or above; battery in half–charged state 1.190 g/cm ³ ; battery in discharged state 1.120 g/cm ³ . |
| Sulphation: | If a battery is allowed to remain in a discharged condition for a prolonged period, the fine lead sulphate formed during the discharging reaction may transform into coarse lead sulphate which can only be converted back with very great difficulties – if it can be converted back at all. |
| Unfilled, charged | In this case we do speak about "dry charged" batteries as well. |

batteries:

The battery plates are in a charged condition but for the only reason of a better storability the battery has been supplied without electrolyte. The battery is ready for service within a short time after the electrolyte is being added.

3. Lighting and signal circuits – Accessories and wiring

Lighting and signal circuits

Concerning the **basic electrical information** you do know already what is the need for a simple circuit:

- battery;
- switch;
- consumer (i.e. a lamp);
- conductors (wires and negative connection over the car body).

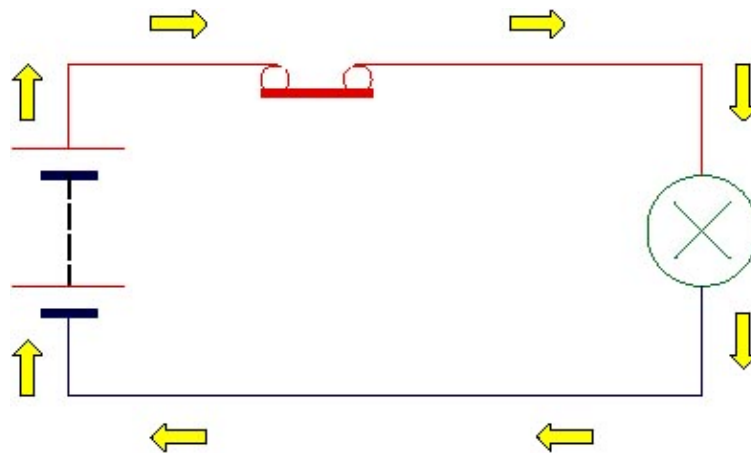

Current flow direction: →

Let's think in a practical way:

We want to know, how the **stoplights on a car** are connected. According to the simple circuit shown above there must be a connection for both of the **bulbs** for the stoplight. A **switch** must be inserted (by working mechanically over the brake pedal or by using the pressure of the brake fluid over the main brake cylinder). The connection to the **battery** must be there for some way and we do need a **fuse** to protect that circuit in the case of an eventually short circuit. And of course, all that parts are connected on the **positive side by using wires** and on the **negative side** by using a **short wire connection to the car body**. From there back **to the negative terminal of the battery over the chassis, the engine block and the battery negative cable**.

Let's see how a **stoplight circuit** can be done. See diagram below:

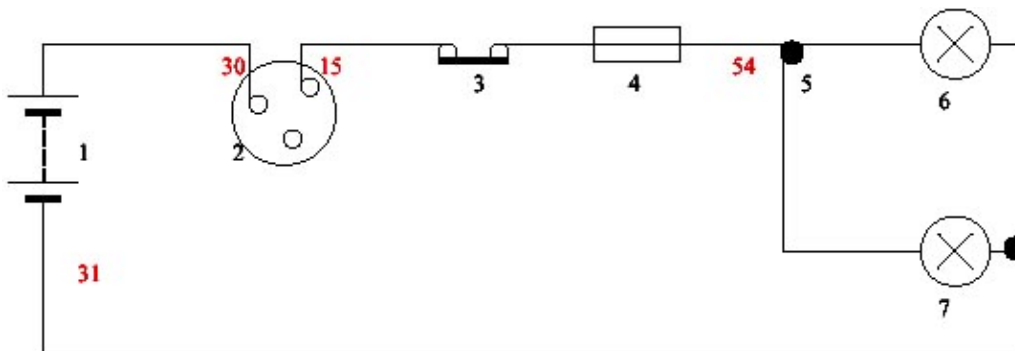

- 1 – battery
- 2 – ignition switch

- 3 – stoplight switch
- 4 – fuse
- 5 – cable connection
- 6; 7– stoplight bulbs

What's new?

The **ignition switch** is connected direct or over the starter motor to the battery (positive terminal). Most of the circuits in a car are connected over fuses (by using a fuse box).

The **circuit** shows, too, **several numbers** (30; 15; 54; 31). That numbers are part of a **number code** to indicate connections:

- "30" = direct connection to the battery;
- "15" = connected only than when ignition switch is switched on;
- "54" = indication number for the stoplights and several other consumers;
- "31" = indication for negative connection.

In our example the stoplights are only working if the ignition switch is switched on (over "15").

If over the wire on the long way to the stoplights **a short circuit is coming up, then the fuse blows up** and so the other wire connections inside the car are **protected** in case of developing heat and burning out.

Think about this: A modern and fully equipped car has between 50 and 70 interior and exterior lamps and many different other consumers as well!

Generally speaking the lighting and signal circuits are known as **single wire systems** since they are used of the car frame for the return connections.

Complete lighting and signal circuits are separated into **individual circuits** by using one or more switches and lights or other consumers.

Note the following difference: The lighting and signal **consumers are connected in parallel but the controlling switches are in series to the circuit groups and the battery.**

Signs of electrical equipment

Battery:



or

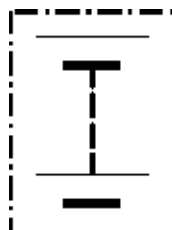

or

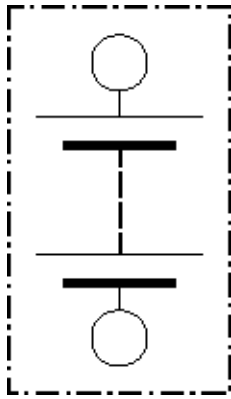

Bulb single filament:

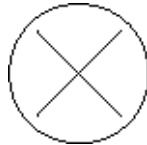

-with wire connection:

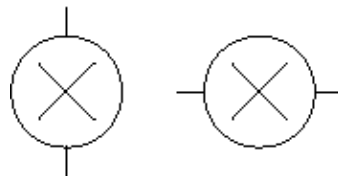

Bulb double filament:

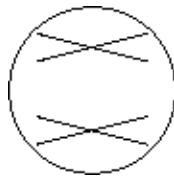

-with wire connection:

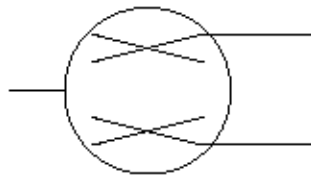

One way switch open:

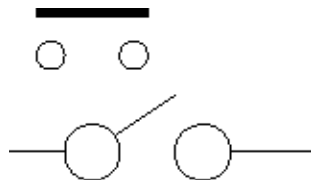

-and closed:



Two way switch open:

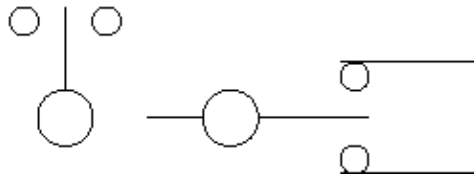

-and closed on one side:

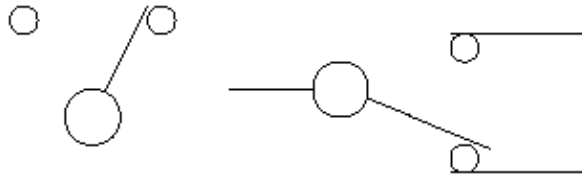

Multi way switches:

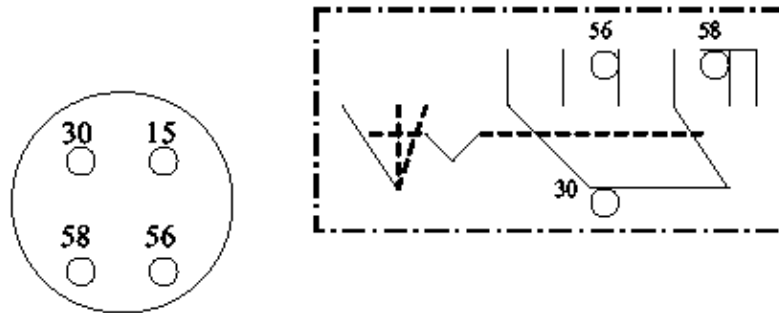

Fuse (generally):

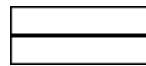

-with named "A":

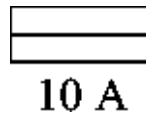

Across wires:

(without electrical connection)



Wire connection:

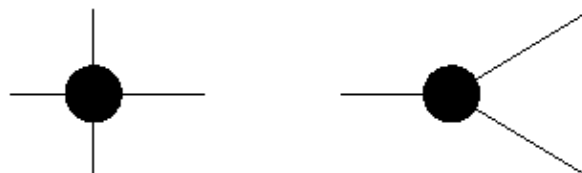

Switches

As shown already above there are different needs for switches in cars. For example: In a horn circuit a **one-way switch** is mostly used. And so is used a **mechanical one-way switch**. Also the stoplight circuit may have a mechanical one-way switch, but there is another possibility by using an oil-pressure one-way

switch that is included into the brake fluid circuit and therefore placed on the main brake cylinder.

In an indicator circuit must be at least a **two-way switch** for switching on the left side or the right side of the indicator lamps.

But **multi way switches (provided for special purposes)** are in use as:

Ignition switch (switched off; switched on; starting),

Light switch (switched off; side/rear light switched on; side/rear light and headlight switched on),

Wiper switch (switched off; slowly speed switched on; faster speed switched on; interval wiper moving switched on; wiper motor single movement and/or windscreen washer unit switched on –by shortly pressing–).

Fuses, fuse boxes

As mentioned before we do need **fuses to protect circuits in case of a short circuit**. What does it mean?

It can happen that a positive wire loses its connection and comes i. e. on the frame of the car = **short circuit**. A wire can rub on a part of metal and after the insulation is rubbed through = **short circuit**. And **also an accident of a car can create something like that**. **Another important reason for using fuses** is the possibility that an **overload occurs in a circuit**.

In all that cases the **fuse** for the specific circuit **burns out/blows up** and open up the circuit. **No further damage will result**. In connection with a **circuit breaker** (relay) that breaker **remains open** until the problem is solved.

If there is no protection by using fuses then an electrical unit of the car can be affected and unfortunately that car can burn up.

Fuses are mostly placed in fuse boxes or include some different relays and other components in so-called central units.

We do know **glass fuses, ceramic (continental) fuses** and **rectangular fuses**. The most usable ampere strength are 7,5 A, 8 A, 10 A, 15 A, 20 A, 25 A, 30 A and on several vehicles possibly up to 70 A.

Information can be seen on the following tables:

– what current strength is flowing by using different consumers:

| Several electrical circuits | Flowing current in ampere (A) |
|-----------------------------|-------------------------------|
| Ignition | 5 A |
| Starting unit | 100 A – 300 A |
| Headlights | 12 A – 20 A |
| Side/rear lights | 2 A – 4 A |
| Stop lights | 4 A |
| Wipers | 6 A |
| Air conditioning | 12 A – 20 A |
| Interior lights | 1 A – 2 A |
| Radio | 1 A – 1,5 A |

Note: That values are depending on the manufacturer of a specific vehicle and its type. The equipment it self develop further and we will find changes by the value of the flowing ampere as well as new components placed inside cars (i. e. board computer).

– and what ampere value of fuses can be in use in several electrical circuits:

| Electrical circuits | Ampere value of fuses |
|--|-----------------------|
| Gauges; alarm system | <u>7.5 A</u> |
| Side/rear lights; head lights; interior lights; electric arial; electric mirrors | <u>10 A</u> |
| Wipers; washers; stop lights; cigarette lighter; hazard unit; indicator circuit | <u>15 A</u> |
| A/C clutch; blower motor | <u>25 A</u> |
| Electrical movable seats; central locking unit; electric windows | <u>30 A</u> |

Note: See information under first table.

Electrical circuits

(examples):

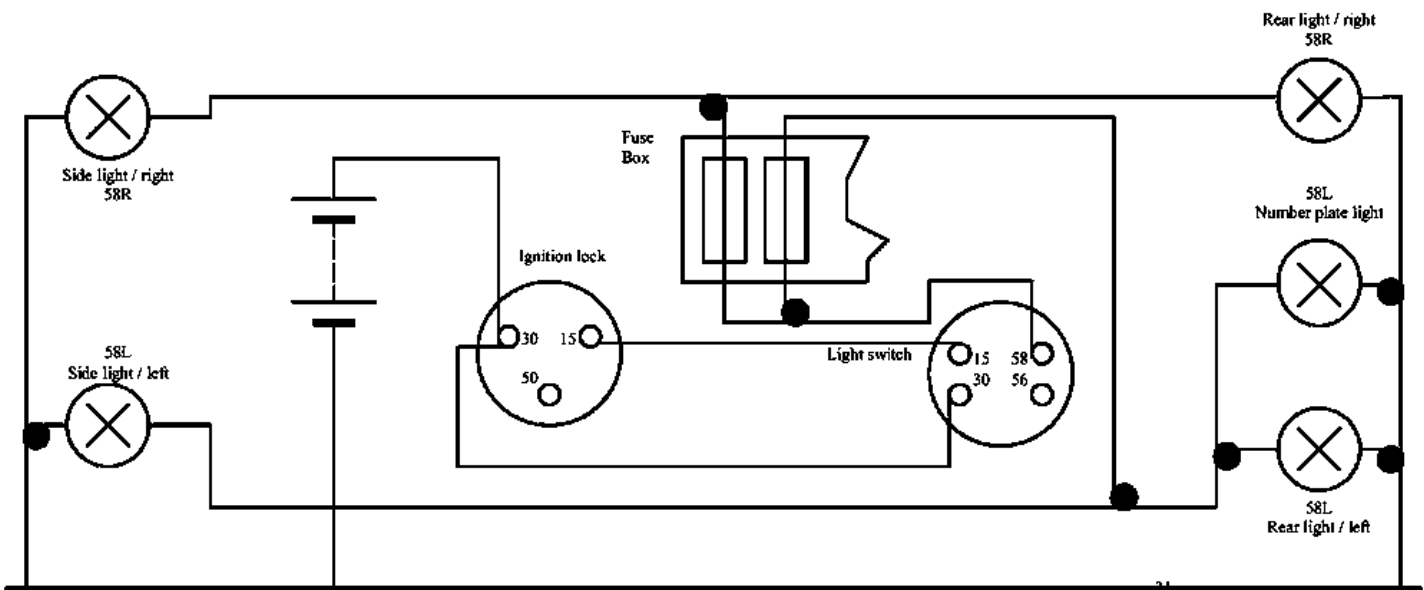

1SIDE/REAR LIGHT CIRCUIT

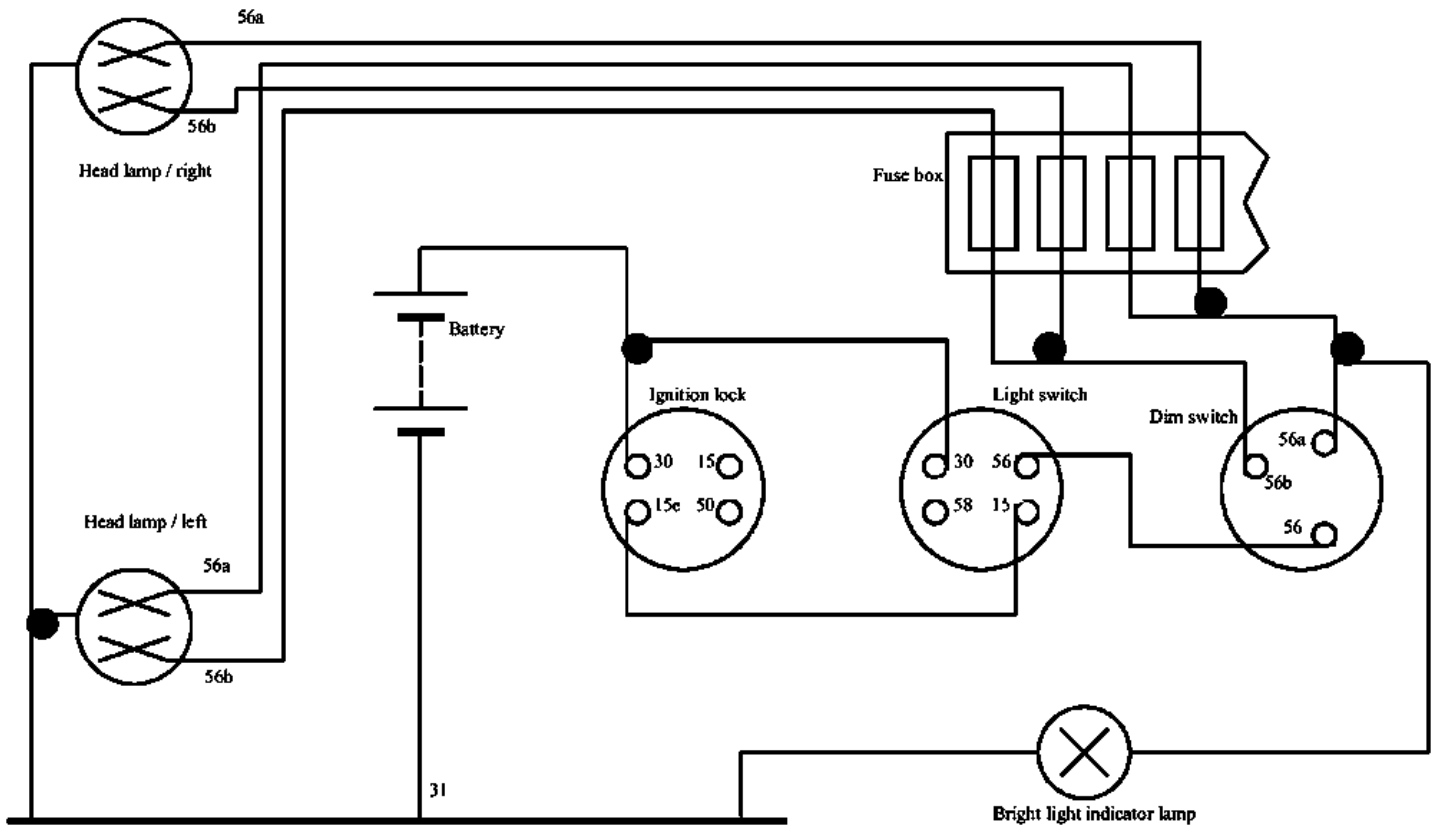

HEADLIGHT CIRCUIT

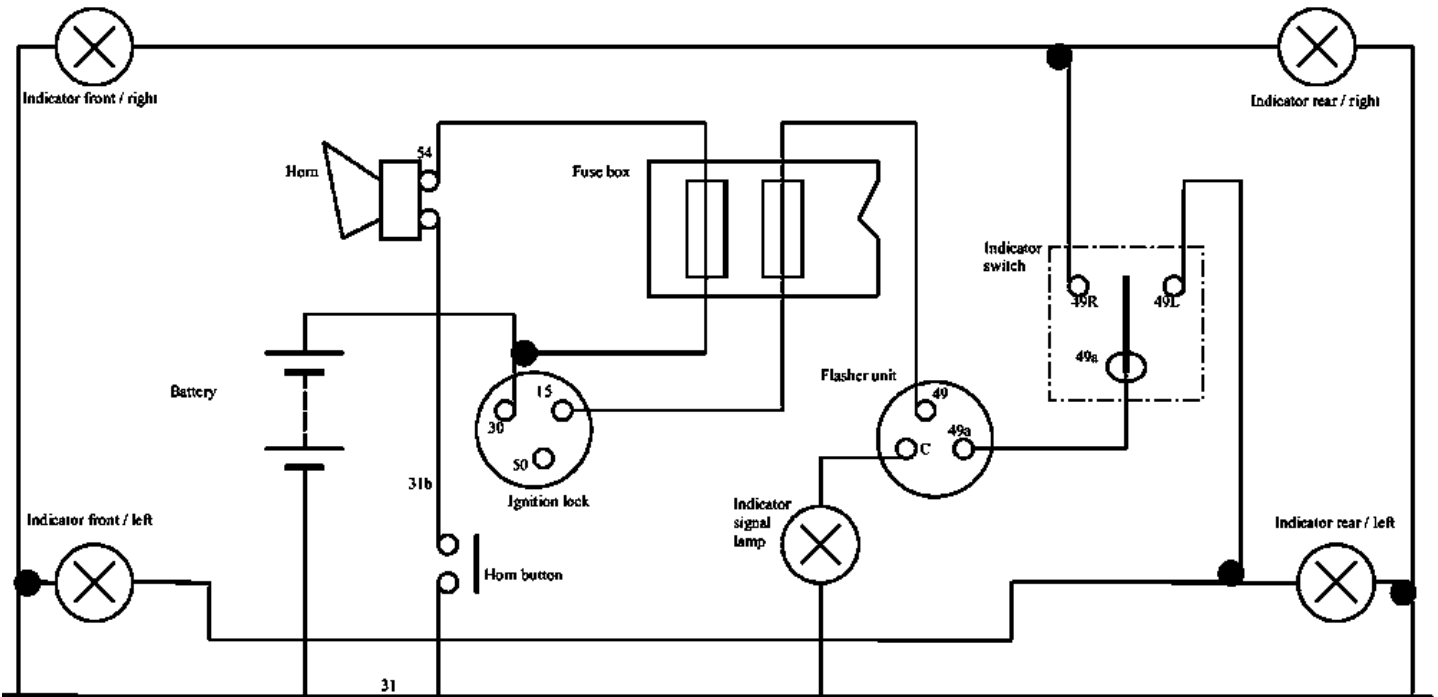

INDICATOR CIRCUIT AND HORN CIRCUIT

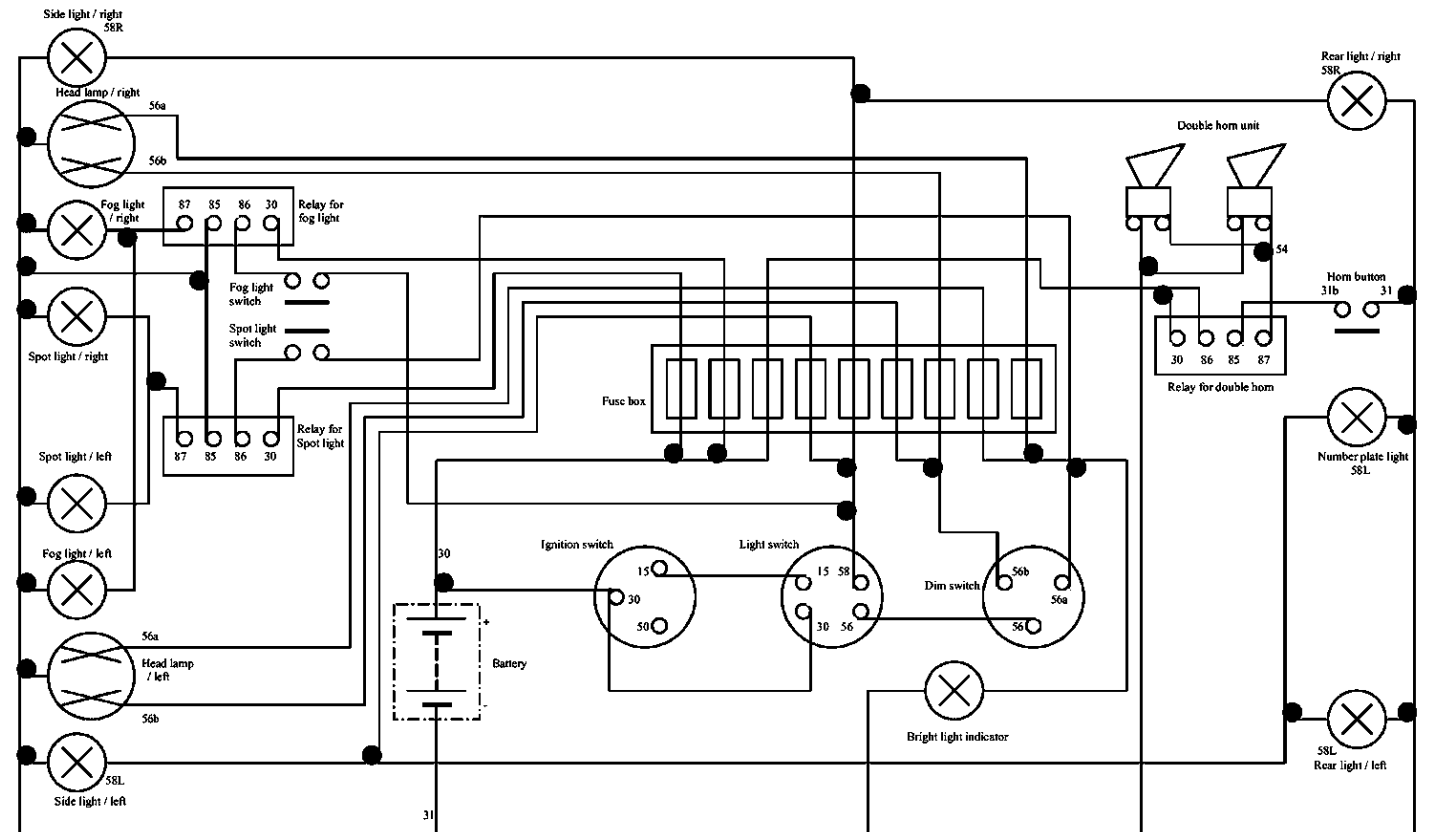

HEADLIGHT, SIDE / REAR LIGHT, SPOTLIGHT, FOGLIGHT AND DOUBLE HORN CIRCUITS AS ONE COMPLETE CIRCUIT DIAGRAM

NOTE: There are still more lighting and signal circuits. The circuits shown above are again only examples. That means we do find differences in the case of connection of circuits from the side of the manufacturers.

Further information to different electrical circuits will be given during the course it self.

Connections

As is to find in the examples of different circuits there are different possibilities to connect them:

- **Side/rear light** circuits are always connected over the connection number "30". These lights are usable without switching on the ignition lock. Often these kind of circuits are connected **over two fuses** and so separately for right (side/rear light) and left (side/rear light) side.

In countries with left traffic (like Namibia, too) the numberplate light has to be connected together with the left rear light.

- **Headlight** circuit can be connected over the connection number "30", "15" or "15e". Connected over "15" means the headlight is working if the ignition lock is switched on. Connected over "15e" means in that case the ignition lock must be switched on before the headlight is working, but during the starting process it goes automatically off. Mostly the headlight is connected over two or four fuses.

Two fuses: Bright (main beam) light is separated from the dim (dip beam) light.

Four fuses: Each and every filament of the headlights is going separately over one fuse.

The bright light indicator lamp on the dashboard is a must in case of the traffic rules and regulations and always has to work by using the bright light and it has to be a BLUEISH colour.

- **Indicator** circuit is mostly connected over "15" by using one fuse. This enables us to protect the circuit included the flasher unit. The **flasher unit** (an electromagnetic or electronically switch) is responsible for

flashing of the indicator lights. If **one signal lamp** for both of the sides of the indicator is indicating on the dashboard, than there is a connection of that signal lamp direct to the flasher unit "c". When there are **two signal lamps** (separately for right and left side), than these 36 are connected to the different sides of the indicator circuit it self. **The signal lamp(s) has(ve) to be green.**

– **Spotlights** are often connected, mostly by **using a relay**, over the connection number "**56a**" (bright light of the headlight) and also if the spotlights are switched on, they work only than when the bright lights are working. **One fuse** before the relay is normally used.

– **Fog lights** (by using a relay, too) can be connected over "**58**" (side/rear light) or over "**56b**" (dim light of the headlight). **One fuse** before the relay is in the circuit.

– **Horn circuit.** Mostly used in cars that are **single horn and double horn** units by using electromagnetic horns. Also **pneumatic horns** working over an electromagnetic air pump are in use. Those different circuits are connected over "**30**" or "**15**" by using **one fuse**. A double horn unit is working with a relay. That is necessary because of its higher current flow.

Cables/wires

Cables are provided to **carry the electrical energy** from one point to another **according to the existing connection** with a minimum of energy loss. The **cable conductor is made from many strands of copper wire bunched together to form a core**. These kinds of cables that are used in motor vehicles are important because of its **higher flexibility** than a single large diameter strand. Another important aspect is, if one or more strands are damaged and fail to carry the energy, then the remaining strands will share out the additional electrical load and continue to conduct.

To carry a large current without a considerable voltage drop and without generating excessive heat, the cable must have a minimum of electrical resistance. **The resistance is direct proportional to the length and the size of the conductor.**

| Number and diameter in mm of strands | Size of cable in mm² | Maximal current rating in A | Voltage drop per m of conductor (12 V units) | Application |
|---|--|------------------------------------|---|--|
| 14/0,30 | 1,0 | 8,75 | 0,0189 | Side/rear lights |
| 21/0,30 | 1,5 | 12,75 | 0,013 | Headlights |
| 65/0,30 | 4,5 | 35,00 | 0,004 | Alternator circuit; Ammeter circuit |
| 37/0,71 | 15,0 | 105,00 | 0,0013 | Battery cable in petrol cars (sedan) |

Bulbs

According to the different electrical units in vehicles there might be a need for 6V, 12 V or 24 V bulbs. **The type of bulbs, their sizes and the strength of the filaments depend on what those bulbs are used for.**



a) Festoon



b) Miniature Edison screw



c) Miniature centre contact



d) Capless glass



e) Single-contact small



f) Single-contact small bayonet cap bayonet cap

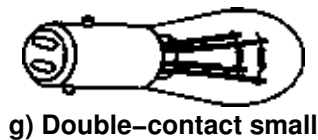

g) Double-contact small

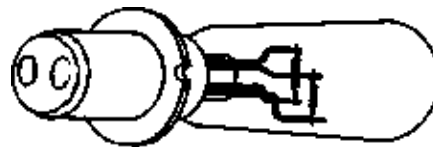

h) Pre-focus double filament

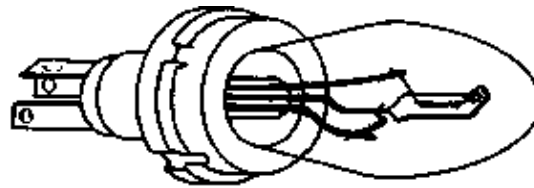

i) Pre-focus shielded double filament

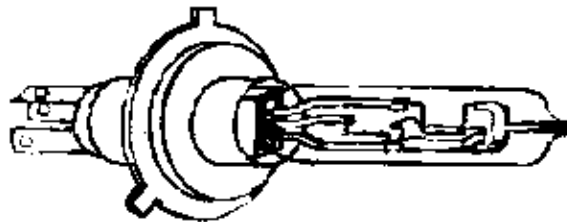

j) Pre-focus tungsten-halogen

Fault finding

To find a fault in a circuit is it necessary to know how that circuit is connected.

In some cases **manufacturer instructions** may help, but an auto-electrician must be able to follow up a faultfinding process by knowing what he or she is doing.

Helpful is the **colour code** of the cables in many cars as well. Unfortunately there will not always be the right cable colour. It is possible that several cables are replaced or an additional installation was made by the use of some different coloured cables.

The **test lamp** is an important tool that can be used to find out where or how far the connection of a circuit is still in order. In another case we can also follow up a disconnection as well as a short circuit.

Also usable in such cases like that is a **voltmeter**. It is important to know how to handle that specific instrument.

If a fuse is blown up in a circuit, then **there is never to replace that fuse only**. It must be clear what was the reason for the fuse to blow up. **The fault is concrete to find before that circuit is properly in order again.**

During the course we will follow up what different main faults may occur and how to go about fault finding.

Lighting systems/ Signal systems

Why we do speak about lighting and signal systems?

By the use of a **lighting system** we want to ensure that with these different types of lighting circuits **we can see** especially at night where to drive and we must **see** as well **we are seen** by the other traffic members.

Such circuits like **side/rear light** included number plate light and dashboard light, **headlight**, **fog light**, **fog rear light**, **spotlight** belong to the lighting system.

Examples for the **signal system** are the circuits of the **horn**, **indicator**, **hazard**, **stoplight**, special warning lights (i. e. for the police, vehicles with abnormal loads). Of course, a stoplight is a light as well and you may think now it belongs to the lighting system as well. But in that case is to realise **a signal**, even it is a light, **gives to the other traffic members a special message** and this is the first priority of a signal.

There is only one unit what we can accept to belong to both of the systems. The **reverse light** let us see what is going on behind the car if we want to drive backwards and it is a message for the others that car will drive backwards.

Technical drawing of circuit diagrams

Before we may start drawing circuit diagrams we have to ensure that all the parts of the *drawing equipment* are *complete and in order*.

- *Handle the drawing paper in a way to avoid dirtiness.*
- *Work with cleaned hands.*
- *Use more than one pencil for the different strength of the lines.*

Hardness of pencils:

6B; 5B; 4B = very soft,
2B; HB = soft,
H:F = average,
2H; 3H = fairly hard.

- *Rubber, rubber shield, compass and extension, protractor, drawing set squares, drawing square (T-square) and scale ruler are the further parts of equipment to ensure a proper drawing result.*

Construction line: _____

Outline: _____

Dotted line:

Center line: - - - - -

Dimension line: _____

And of course all your drawing equipment has to be clean and functional in order.

Using more than one pencil are important for the *different strength of lines*. Construction-lines i. e. should be very thin to make it possible removing them easily if they disturb the circuit. But these lines can also be inside a finalised circuit when you were working very careful and those lines are not disturbing the circuit and its connections.

Negative ground-lines and cable connection direct from the battery can be made thicker than the normal used dimension lines for all the other wire connections.

All the wires should be drawn in the same strength. There is a difference allowed for the ground line and for the direct connection of/from the battery; they can be made stronger.

Projection line: _____

Arrows: 

Before you really start to draw circuit diagrams, find out which components have to be included.

You should follow up what components do you need for each and every circuit and think about to make first a list of all the different electrical circuits include the components you plan (and of course, it must be right). That means you really have to **ensure all the switches, fuses, lamps, relays, gauges and other accessories are included**.

On the other hand, there is also to **clear up on what position the electrical parts are to place** in the drawing by **finding a way that the wire connections are relatively easy to follow up and by avoiding unnecessary crossing of wires**. Make sure for your self, to draw circuit diagrams is not a drawing exercise only; all your **connections must be right** and you have to think about such things as:

- **where in a circuit is to bring in a switch and other equipment by thinking to bring the wire connection into a good position and by having enough space for all the wires in the diagram;**
- **what position is important for a fuse and especially for a fuse box by drawing more complicated circuits with many fuse connections;**
- **how is the right connection of a relay to be done and what other demand is may be given to follow up several details of a relay, a switch, a electric motor, a coil;**

Find out what you have really to do:

- **what kind of circuit you have to draw?**
- **do you need to include the battery, the ignition system or another not named circuit (or a part of a circuit) to complete the circuit exercise?**
- **do you have to write down the terminal numbers and/or the names of the electric parts?**
- **can you really be sure (if you got a paper with shown electrical parts) all the necessary parts are already prepared on that drawing paper?**

It is important to read careful the demands out of the given exercise. One example in this case:

A) Draw included the battery and the ignition lock an indicator circuit by connection of two signal indicator lamps for the dashboard.

B) Draw an indicator circuit starting by a connection point "15" in connection with one signal indicator lamp for the motor vehicle and one for the trailer.

Did you find out the differences between A) and B)?



Try to answer this question by your self, find a possible result and than discuss your result with the instructor.

And please, always you have to **draw on a concentrate way**. Mistakes can be done fast and such things are often difficult to clean up again.

If you prepared a list for all the necessary parts than use that list to mark step by step what is already taken over in your drawing. **If you made a free hand sketch** first than ensure that all of them is properly included and connected there and after you are sure follow up that sketch by working out the final drawing.

Note (AND NEVER FORGET!)

In a Technical Drawing is **never allowed**:

-  to draw a line free hand!
-  to write or draw something into the drawing by using a pen!
-  to write numbers and letters without to take care about the equal size and direction!

Basics of the function of relays (additional theme)

Kinds and function of relays

Basically we do know three different kinds of relays:

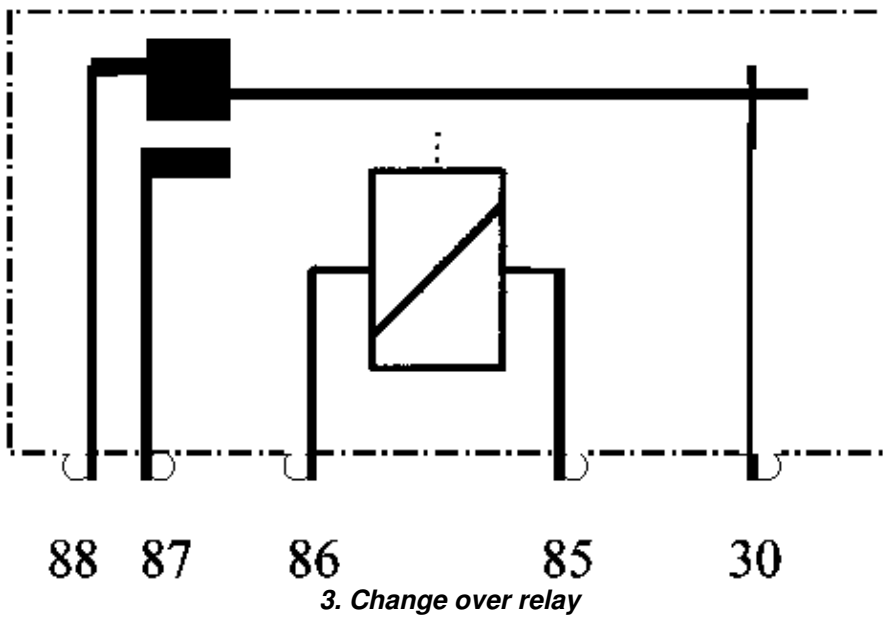
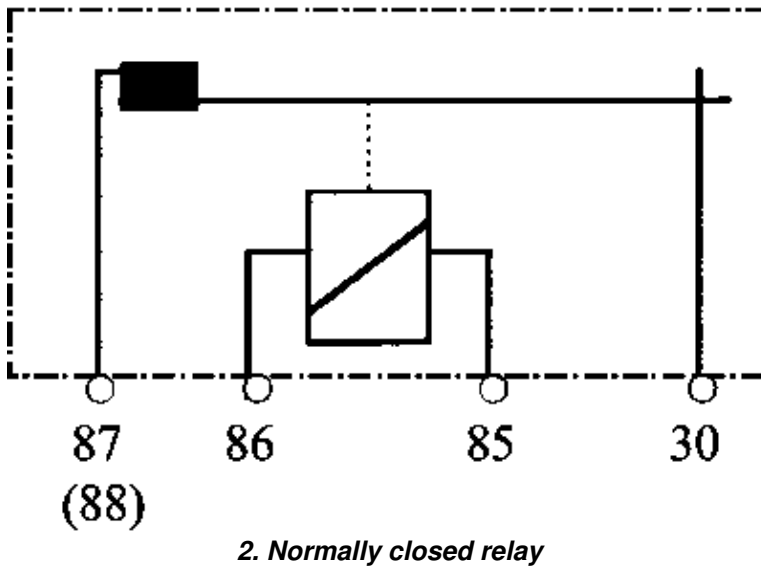
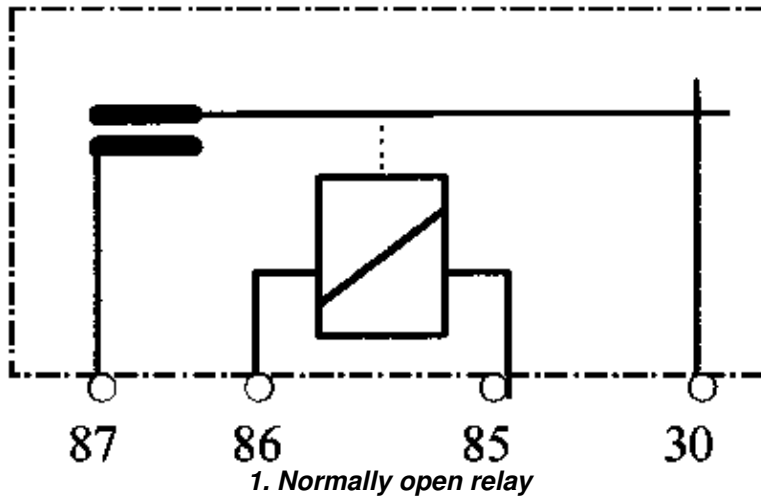

How a relay works?

Let's find out by explaining the *function of a normally open relay*.

The *main parts of a relay* are the *winding*, the *iron core*, the *movable arm* in top of the iron core, the *contact points* and the *terminals*.

By using a relay we have to realise there are "**two internal circuits**" in use: the "**steering circuit**" between the terminals 85 and 86 and the "**main circuit**" between the terminals 30 and 87.

By **connecting the terminal "85" to the ground and the terminal "86" to the positive**, there are a so-called **steering circuit** that gets current. In addition: **the winding around the iron core get energised**. If this happens then **the iron core is building up a magnetic field**. Now through that **the movable arm in the top of it (between the terminals "30" – from positive and "87" – to the consumer) pulls downwards and the contact points will closed**. By closing the contact points the so-called **main circuit** is closed.

The **reason to use a relay** is given **because of a higher current flow** for example in double horn, fog light or spotlight circuits.

A **stronger current follows up on a shorter way by using a steering and a main circuit that does not have such long cables** is **economically useful** by less used stronger cable and the further usability of the normal switches with the small contact points. There is also a **safety aspect** in the case of shorter ways for several main circuits with higher current flow and by saving the small contact points to get fast damaged because that material is too soft for the higher current flow.

As it is explained above **there is no possibility for using a permanent magnet in a relay**. It must be an electromagnet (by using a winding and an iron core) to switch on and off that relay.
