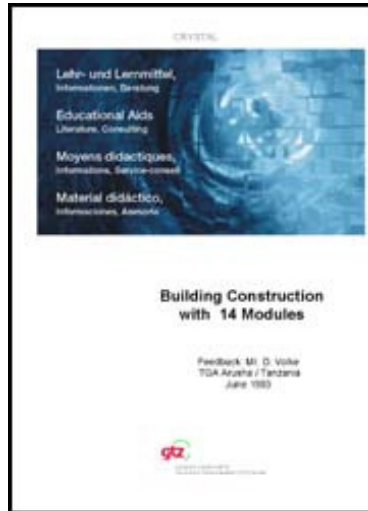

[Home page](#) | [Help](#) | [Clear](#)[English](#) | [French](#) | [Spanish](#) | [German](#)[Search](#) | [Subjects](#) | [Titles A-Z](#) | [Courses](#) | [Illustrations](#) | [Topics](#) | [e-Course builder](#)[Contract TOC](#)[Expand Document](#)[Contract Chapter](#)[Add to e-Course](#)[Preferences](#)

Printable version

Export document
as HTML file [Help](#)

Export document
as PDF file

Building Construction with 14 Modules (TCA; 1983; 618 pages)

1. ARCHITECTURAL DRAWING I

1.1 AIMS AND PURPOSE OF ARCHITECTURAL DRAWINGS

1.1.1 CONTENTS OF ARCHITECTURAL DRAWINGS

1.2 DRAWING EQUIPMENT

1.2.1 PENCILS

1.2.2 DRAWING PENS

1.2.3 COMPASSES

1.2.4 DRAWING BOARDS

1.2.5 T-SQUARES

1.2.6 SET SQUARES

1.2.7 PROTRACTORS

1.2.8 SCALES

1.2.9 FRENCH CURVES

1.2.10 TEMPLATES

1.2.11 DRAWING PINS AND OTHER FIXINGS





1.2.12 MINOR ITEMS OF EQUIPMENT

1.2.13 PRINTING PAPERS

1.2.14 TRACING PAPER, CLOTH AND FILM

 **1.2.15 BACKING SHEETS** **1.2.16 DRAWING PAPERS** **1.2.17 CARTRIDGE** **1.2.18 HANDMADE AND MOULDMADE PAPERS** **1.2.19 PLASTIC-COATED CARD** **1.3 LETTERING** **1.3.1 PRINCIPLE OF LETTERING** **1.3.2 FREEHAND LETTERING** **1.3.3 TYPES OF LETTERS** **1.3.3.1 The Roman Alphabet** **1.3.3.2 Sans Serif Letters** **1.3.3.3 Inclined Lettering** **1.3.3.4 Script Lettering** **1.3.3.5 Stencil Lettering** **1.3.3.6 Guided Pen Lettering** **1.3.3.7 Pressure-Transfer Lettering** **1.4 LINEWORK AND DIMENSIONING** **1.4.1 TYPES OF LINES** **1.4.2 PENCIL DRAWING** **1.4.3 INKING - IN** **1.4.4 BASIC RULES OF DIMENSIONING** **1.4.4.1 Types of Dimensions** **1.4.4.2 Placement of Dimensions**

 **1.5 ENLARGEMENT AND REDUCTION OF LINE DRAWINGS** **1.6 GEOMETRICAL CONSTRUCTIONS** **1.6.1 LINES AND ANGLES** **1.6.1.1 To bisect a straight line AB** **1.6.1.2 To divide a straight line AB into a given number of equal parts** **1.6.1.3 To divide a straight line AB into any ratio** **1.6.1.4 To construct an angle of 90°**  **1.6.1.5 To construct an angle of 45°**  **1.6.1.6 To construct an angle of 60°**  **1.6.1.7 To construct an angle of 30°**  **1.6.1.8 To bisect any given angle** **1.6.1.9 To construct an angle SIMILAR to a given angle** **1.6.1.10 To draw a line PARALLEL to a given line** **1.6.2 TRIANGLES** **1.6.2.1 To construct an EQUILATERAL triangle** **1.6.2.2 To construct a triangle with given BASE ANGLES and ALTITUDE** **1.6.2.3 To inscribe a circle in a given triangle ABC** **1.6.2.4 To circumscribe a triangle ABC** **1.6.3 CIRCLES** **1.6.3.1 Basic CIRCLE-Constructions** **1.6.3.2 To draw a tangent to a point A on the circumference of a circle centre O**

-  **1.6.3.3 To draw an internal tangent to two circles of equal diameter**
-  **1.6.3.4 To find the centre of a given circle arc**
-  **1.6.3.5 To join two straight lines at RIGHT ANGLES to each other by an arc of given radius**
-  **1.6.3.6 To draw a curve of given radius joining two circles**
-  **1.6.3.7 To join two straight lines by two arcs of equal radius**

1.6.4 BASIC ARCH CONSTRUCTIONS

2. ARCHITECTURAL DRAWING II

2.1 TYPES OF PROJECTIONS

2.2 ORTHOGRAPHIC PROJECTION

2.2.1 CONSTRUCTION OF ORTHOGRAPHIC PROJECTION

2.2.2 ELEVATIONS

2.2.3 PLANS AND SECTIONS

2.3 PICTORIAL DRAWING

2.3.1 AXONOMETRIC PROJECTION

2.3.2 ISOMETRIC PROJECTION

2.3.3 DIMETRIC PROJECTION

2.3.4 OBLIQUE PROJECTION

2.3.4.1 Length of Receding Lines























2.3.4.2 Construction of Oblique Drawings

2.3.4.3 Rules of Oblique Drawing

2.3.4.4 Scale of the Receding Lines

2.3.4.5 Direction of Receding Lines

 **2.3.4.6 Position of Axes** **2.4 PERSPECTIVE DRAWING** **2.4.1 PERSPECTIVE TERMS** **2.4.2 PHENOMENA OF PERSPECTIVE DRAWING** **2.4.3 SYSTEMS OF PERSPECTIVE DRAWINGS** **2.4.4 METHODS OF PERSPECTIVE DRAWINGS** **2.4.5 TWO-POINT PERSPECTIVE** **2.4.6 ONE-POINT PERSPECTIVE** **2.5 SHADES AND SHADOWS** **2.5.1 THE USE OF SHADOWS** **2.5.2 SHADES AND SHADOWS** **2.5.3 THE CONVENTIONAL DIRECTION OF LIGHT** **2.5.4 THE 45° DIRECTION** **2.5.5 THE TRUE DIRECTION OF LIGHT** **2.5.6 SHADOWS OF SOLIDS** **2.5.7 PLANES OF SHADOW** **2.5.8 PRINCIPLES OF SHADOW-CASTING** **2.6 DRAWING PRACTICE** **2.6.1 DRAWING SHEETS** **2.6.1.1 Sizes and Folds** **2.6.1.2 Layout and Identification** **2.6.2 LEVELS** **2.6.3 REFERENCING**

-  **2.6.4 ABBREVIATIONS**
-  **2.6.5 REPRESENTATION OF MATERIALS**
-  **2.6.6 GRAPHICAL SYMBOLS AND REPRESENTATION**
-  **2.6.7 HATCHING RULES**
-  **2.7 APPLICATION FOR BUILDING PERMIT**
 -  **2.7.1 PROCEDURE OF APPLYING FOR PERMISSION TO ERECT A BUILDING**
 -  **2.7.2 FORMULARS**
-  **4. CONTRACT PLANNING AND SITE ORGANISATION**
 -  **4.1 CONTRACT PLANNING**
 -  **4.1.1 BAR CHART**
 -  **4.1.2 NETWORK ANALYSIS**
 -  **4.1.3 THE OVERALL PROGRAMME**
 -  **4.1.3.1 Break down of job**
 -  **4.1.3.2 Quantities of work and time content**
 -  **4.1.3.3 Plant and Labour outputs**
 -  **4.1.3.4 Sequence and timing of operations**
 -  **4.1.3.5 The programme chart**
 -  **4.1.4 PLANNING CONSIDERATIONS**
 -  **4.1.4.1 Site conditions and access**
 -  **4.1.4.2 Nature of job**
 -  **4.1.4.3 Plant**
 -  **4.1.4.4 Scaffolding**

 **4.2 SITE ORGANIZATION** **4.2.1 PRELIMINARY WORK** **4.2.2 SITE PLANNING** **4.2.2.1 Period planning** **4.2.2.2 Weekly planning** **4.2.2.3 Progress control** **4.2.3 SITE LAYOUT** **5. FOUNDATIONS** **5.1 SOIL INVESTIGATIONS** **5.1.1 SITE EXPLORATION** **5.1.1.1 Trial holes** **5.1.1.2 Bore holes** **5.1.1.3 Sampling** **5.1.1.4 Tests** **5.1.1.5 Load or bearing test** **5.1.2 SOILS AND SOIL CHARACTERISTICS** **5.1.2.1 Rocks and soils** **5.1.2.2 Stresses and pressures** **5.2 EXCAVATIONS AND TIMBERING** **5.3 TYPES OF FOUNDATIONS** **5.3.1 CLASSIFICATION** **5.3.2 CHOICE OF FOUNDATION** **5.3.3 SPREAD FOUNDATIONS**

 **5.3.3.1 Strip foundations**

 **5.3.3.2 Deep strip foundations**

 **5.3.3.3 Stepped foundations**

 **5.3.3.4 Pad foundations**

 **5.3.3.5 Raft foundations**

 **5.3.4 PILE FOUNDATIONS**

 **5.3.4.1 Short bored pile foundations**

 **5.3.5 PIER FOUNDATIONS**

 **6. WALLS**

 **6.1 FUNCTION AND PROPERTIES OF WALLS**

 **6.2 THE BEHAVIOR OF THE WALL UNDER LOAD**

 **6.2.1 CALCULATION OF WALL THICKNESS**

 **6.3 TYPES OF WALLS**

 **6.4 STONEMWORK**

 **6.4.1 BUILDING STONES**

 **6.4.2 STONEMWORK THERMINOLOGY**

 **6.4.3 STONEMWORK CLASSIFICATION**

 **6.4.4 RUBBLE WALLING**

 **6.4.5 ASHLAR WALLING**

























 **6.4.5.1 Rules for ashlar work**























 **6.5 BRICK WORK**























 **6.5.1 BRICKWORK TERMINOLOGY**

 **6.5.2 MANUFACTURE OF CLAY BRICKS**

 **6.5.2.1 Pressed Bricks** **6.5.2.2 Wire cut bricks** **6.5.2.3 Efflorescence** **6.5.3 BRICK CLASSIFICATION** **6.5.4 CALCIUM SILICATE BRICKS** **6.5.5 CONCRETE BRICKS** **6.5.6 MORTARS FOR BRICKWORK** **6.5.7 DAMPNES PENETRATION** **6.5.8 BRICKWORK BONDING** **6.5.8.1 Common bonds** **6.5.9 METRIC MODULAR BRICKWORK** **6.5.10 JUNCTIONS** **6.5.11 QUOINS OR EXTERNAL ANGLES** **6.5.12 PIERS** **6.5.12.1 Detached piers:** **6.5.12.2 Attached Piers (or Pilasters)** **6.5.12.3 Buttresses** **6.6 BLOCKWORK** **6.6.1 CLAY BLOCKS** **6.6.2 PRECAST CONCRETE BLOCKS** **6.6.3 AERATED CONCRETE BLOCKS** **6.7 CONCRETE WALLS** **6.7.1 GENERAL**

-  **6.7.1 GENERAL**
-  **6.7.2 FOREWORK**
-  **6.7.3 PLAIN MONOLITHIC CONCRETE WALL**
 -  **6.7.3.1 Dense concrete walls**
 -  **6.7.3.2 Light-weight aggregate**
 -  **6.7.3.3 No-fines concrete walls**
 -  **6.7.3.4 Thickness of plain concrete walls**
 -  **6.7.3.5 Shrinkage reinforcement**
-  **6.7.4 REINFORCED CONCRETE WALLS**
 -  **6.7.4.1 In-Situ Cast external walls**
 -  **6.7.4.2 Concrete Box Frames**
 -  **6.7.4.3 Large precast panel structure**
-  **6.8 OPENINGS IN WALLS**
 -  **6.8.1 HEAD**
 -  **6.8.1.1 Lintels**
 -  **6.8.1.2 Arches**
 -  **6.8.2 JAMBS**
 -  **6.8.3 SILLS AND THRESHOLDS**
 -  **6.8.3.1 Sills**
 -  **6.8.3.2 Thresholds**
-  **7. FLOORS**
 -  **7.1 GENERAL**
 -  **7.2 SOLID GROUND FLOORS**
 - 

-  **7.2.1 SITE CONCRETE**
-  **7.2.2 HARDCORE**
-  **7.2.3 WATERPROOF MEMBRANE**
-  **7.3 SUSPENDED TIMBER GROUND FLOOR**
 -  **7.3.1 BUILDING REGULATIONS**
 -  **7.3.2 LAY OUT**
-  **7.4 UPPER FLOORS**
 -  **7.4.1 TYPES OF UPPER FLOORS**
 -  **7.4.2 STRUCTURE OF UPPER FLOORS**
 -  **7.4.3 SUSPENDED TIMBER UPPER FLOORS**
 -  **7.4.3.1 Floor Joists**
 -  **7.4.3.2 End Support of Floor Joists**
 -  **7.4.3.3 Trimming**
 -  **7.4.4 REINFORCED CONCRETE UPPER FLOORS**
 -  **7.4.4.1 Monolithic Reinforced Concrete Upper Floors**
 -  **7.4.4.2 Precast Concrete Upper Floors**
 -  **7.4.4.3 Hollow Block and Waffle Floors**
-  **7.5 FLOOR FINISHES**
 -  **7.5.1 JOINTLESS FLOOR FINISHES**
 -  **7.5.1.1 The most common of these is the Cement/Sand Screed**
 -  **7.5.1.2 Granolithic Concrete Finishes**
 -  **7.5.1.3 Terazzo**
 -  **7.5.2 SLAB FLOORS FINISEHES**

-  **7.5.3 SHEET FLOOR FINISHES**
-  **7.5.4 WOOD FLOOR FINISHES**
-  **8. OPEN FIREPLACES, CHIMNEYS AND FLUES**
 -  **8.1 FUNCTION OF FIREPLACES AND FLUES**
 -  **8.2 PRINCIPLES OF FIREPLACE DESIGN**
 -  **8.2.1 TRADITIONAL OPEN FIREPLACE**
 -  **8.2.2 IMPROVED SOLID FUEL APPLIANCES**
 -  **8.3 PRINCIPLES OF FLUE DESIGN**
 -  **8.4 CONSTRUCTION OF FLUE DESIGN**
 -  **8.4.1 NON-CONVECTOR OPEN FIRES**
 -  **8.4.2 CONVECTOR OPEN FIRES**
 -  **8.5 CONSTRUCTION OF CHIMNEYS**
-  **9. ROOFS**
 -  **9.1 FUNCTIONAL REQUIREMENTS**
 -  **9.1.1 STRENGTH AND STABILITY**
 -  **9.1.2 WEATHER RESISTANCE**
 -  **9.1.3 THERMAL INSULATION**
 -  **9.1.4 FIRE RESISTANCE**
 -  **9.1.5 SOUND INSULATION**
 -  **9.2 TYPES OF ROOF STRUCTURES**
 -  **9.2.1 FLAT AND PITCHED ROOFS**
 -  **9.2.2 STRUCTURE OF THE ROOF**
 -  **9.2.3 LONG AND SHORT SPAN ROOFS**

 **9.2 LONG AND SHORT OF A ROOF** **9.3 FLAT ROOFS** **9.3.1 PHYSICAL AND STRUCTURAL PROBLEMS** **9.3.2 STRUCTURE OF A FLAT ROOF** **9.3.3 THERMAL INSULATION MATERIAL** **9.3.4 SINGLE AND DOUBLE FLAT ROOF CONSTRUCTION** **9.3.5 PARAPET WALLS** **9.4 PITCHED ROOFS** **9.4.1 SHAPES OF PITCHED ROOFS IN TIMBER** **9.4.2 TERMS** **9.4.3 TYPES OF PITCHED ROOFS IN TIMBER (STRUCTURES)** **9.4.3.1 Mono-(single) pitched Roof** **9.4.3.2 Lean - to Roof** **9.4.3.3 Couple Roof** **9.4.3.4 Close couple Hoof** **9.4.3.5 Collar Roof** **9.4.3.6 Double or Purlin Roof** **9.4.3.7 Tripple or Trussed Roofs** **9.4.3.8 Trussed Rafters** **9.4.3.9 Hipped Roofs** **9.4.4 VALLEY** **9.4.5 EAVES TREATMENT** **9.4.6 OPENINGS IN TIMBER ROOFS** **9.5 ROOF COVERINGS**

9.5 ROOF COVERINGS **9.5.1 FUNCTION OF ROOF COVERINGS** **9.5.2 TYPES OF ROOF COVERINGS** **9.5.3 SUBSTRUCTURES** **9.5.4 CHOICE OF ROOF COVERINGS** **9.5.5 MATERIALS AND COVERING METHODS** **10. FRAMED STRUCTURES** **10.1 STRUCTURAL CONCEPT** **10.2 FUNCTIONAL REQUIREMENTS** **10.3 STRUCTURAL MATERIALS** **10.4 LAYOUT OF FRAMES** **10.5 BUILDING FRAMES** **10.5.1 FUNCTIONS OF BUILDING FRAME MEMBERS** **10.5.2 REINFORCED CONCRETE FRAMES** **10.5.2.1 Reinforced Concrete Beams** **10.5.2.2 Reinforced Concrete Columns** **10.5.2.3 Reinforced Concrete Slabs** **10.5.3 PRECAST CONCRETE FRAMES** **10.5.3.1 Methods of Connections** **10.5.4 STRUCTURAL STEELWORK FRAMES** **10.5.4.1 Structural Steel Frames** **10.5.4.2 Castellated Universal Sections** **10.5.4.3 Connections**



10.5.4.4 Structural Steel Connections



10.5.4.5 Frame Erection



10.5.4.6 Fire Protection of Steelwork



10.5.5 TIMBER FRAMES



10.5.5.1 Columns and Beams



10.5.5.2 Connections



10.5.5.3 Building frames in timber



10.5.5.4 Prefabrication



10.6 PORTAL FRAMES



10.6.1 THEORY



10.6.2 CONCRETE PORTAL FRAMES



10.6.3 STEEL PORTAL FRAMES



10.6.4 TIMBER PORTAL FRAMES



11. PROTECTION OF BUILDINGS



11.1 EXCLUSION OF WATER



11.1.1 PRECIPITATION



11.1.1.1 Roof Drainage



11.1.1.2 Flooding



11.1.1.3 Drought



11.1.2 DAMP RISING AND MOISTURE MIGRATION



























11.1.3 CONDENSATION



11.2 THERMAL INSULATION



11.2.1 DEFINITION

-  **11.2.1 DEFINITION**
-  **11.2.2 INSULATING MATERIALS**
-  **11.3 SOUND INSULATION**
 -  **11.3.1 DEFINITION**
 -  **11.3.2 SOUND INSULATION**
 -  **11.3.3 EXTERNAL NOISE**
-  **11.4 FIRE PROTECTION**
 -  **11.4.1 STRUCTURAL FIRE PROTECTION**
 -  **11.4.1.1 Fire Load**
 -  **11.4.1.2 Fire Resistance of Material**
 -  **11.4.1.3 Appropriate Types of Construction**
-  **12. FINISHING & FINISHES**
 -  **12.1 EXTERNAL WALL FINISHES**
 -  **12.1.1 EXTERNAL RENDERING**
 -  **12.1.2 CONCRETE FINISHES**
 -  **12.1.3 CLADDING**
 -  **12.1.3.1 CLADDINGS FIXED TO A STRUCTURAL BACKING**
 -  **12.1.3.2 CLADDINGS TO FRAMED STRUCTURES**
 -  **12.1.4 EXTERNAL PAINTS AND FINISHES**
 -  **12.2 INTERNAL WALL FINISHES**
 -  **12.2.1 PLASTERING**
 -  **12.2.2 OTHER INTERNAL WALL FINISHES**
 -  **12.2.3 PAINTING**
 -  **12.3 CEILING FINISHES**

 **12.3 CEILING FINISHES** **13. STAIRS** **13.1 INTRODUCTION** **13.2 DEFINITION OF TERMS** **13.3 TYPES OF STAIRS** **13.4 DESIGN OF STAIRS** **13.4.1 RISE - TREAD - PROPORTION** **13.4.2 SLOPE OR PITCH** **13.4.3 LANDINGS** **13.4.4 WIDTH** **13.4.5 WALKING LINE** **13.5 CONSTRUCTION OF STAIRS** **13.5.1 BRICK STAIRS** **13.5.2 STONE STAIRS** **13.5.3 CONCRETE STAIRS** **13.5.3.1 In Situ Cast R.C. Stairs** **13.5.3.2 Precast Concrete Stairs** **13.5.4 TIMBER STAIRS** **13.5.5 METAL STAIRS** **13.6 MISCELLANEOUS** **13.6.1 BALUSTRADES/HANDRAILS** **13.6.2 'SAMBA' STAIR, LADDERS, DISAPPEAR STAIRS, RAMPS** **13.6.3 ESCALATORS** **14 DOORS & WINDOWS**

 **14. DOORS & WINDOWS** **14.1 DOORS** **14.1.1 EXTERNAL DOORS** **14.1.2 INTERNAL DOORS** **14.1.3 PURPOSE MADE DOORS** **14.1.4 METHODS OF CONSTRUCTION** **14.1.4.1 Door terminology** **14.1.4.2 Panelled and glazed wood doors** **14.1.4.3 Flush doors** **14.1.4.4 Fire-check flush doors** **14.1.4.5 Matchboarded doors** **14.1.5 FRAMES AND LININGS** **14.1.5.1 Timber Door Frames** **14.1.5.2 Metal door frames** **14.1.5.3 Door linings** **14.1.6 SPECIAL DOORS** **14.2 WINDOWS, GLASS & GLAZING** **14.2.1 PRIMARY FUNCTIONS OF WINDOWS** **14.2.2 BUILDING REGULATIONS** **14.2.3 TRADITIONAL CASEMENT WINDOWS** **14.2.4 STANDARD WOOD CASEMENT WINDOWS** **14.2.5 STEEL CASEMENT WINDOWS** **14.2.6 BAY WINDOWS**



14.2.7 SLIDING SASH WINDOWS

 14.2.7.1 Vertical sliding windows (also called double hung sash windows)

 14.2.7.2 Horizontal sliding windows

 14.2.8 PIVOT WINDOWS

 14.2.9 LOUVRES

 14.2.10 GLASS AND GLAZING

 14.2.10.1 Glass

 14.2.10.2 Glazing

 14.2.11 MOSQUITO SCREENING (FLY SCREENS)

 14.2.12 SUN-BREAKERS

 14.3 IRON MONGERY

 14.3.1 HINGES

 14.3.2 LOCKS AND LATCHES

 14.3.3 MISCELLANEOUS

6. WALLS

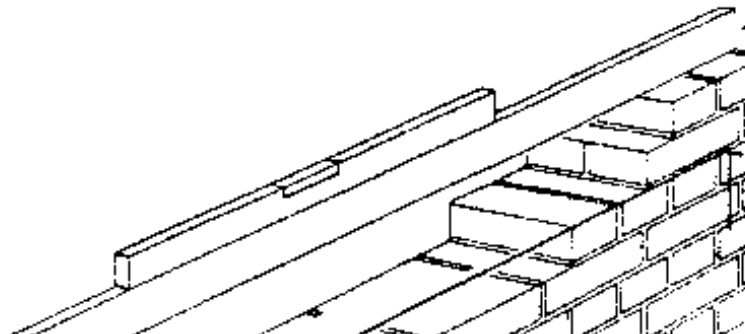

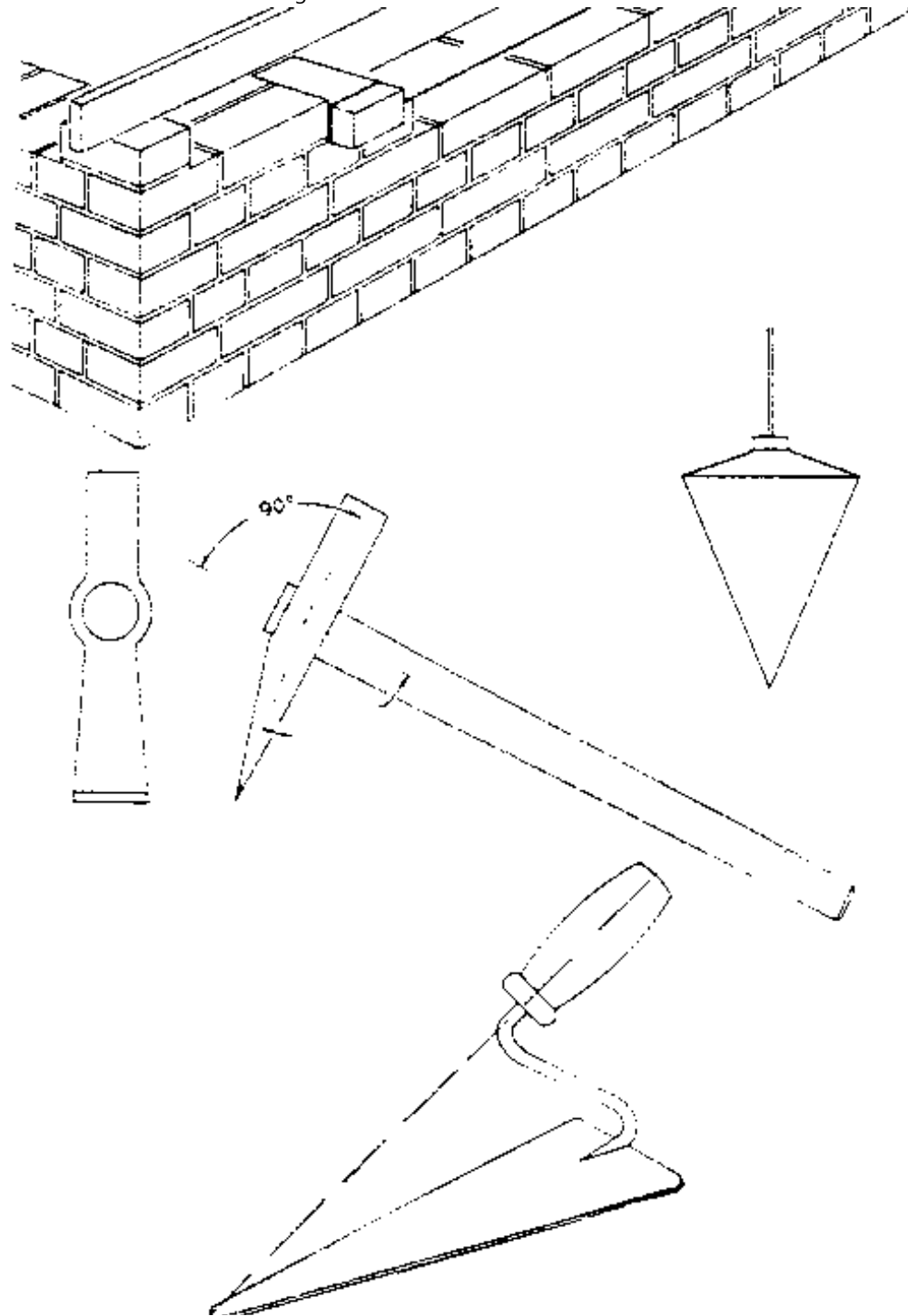

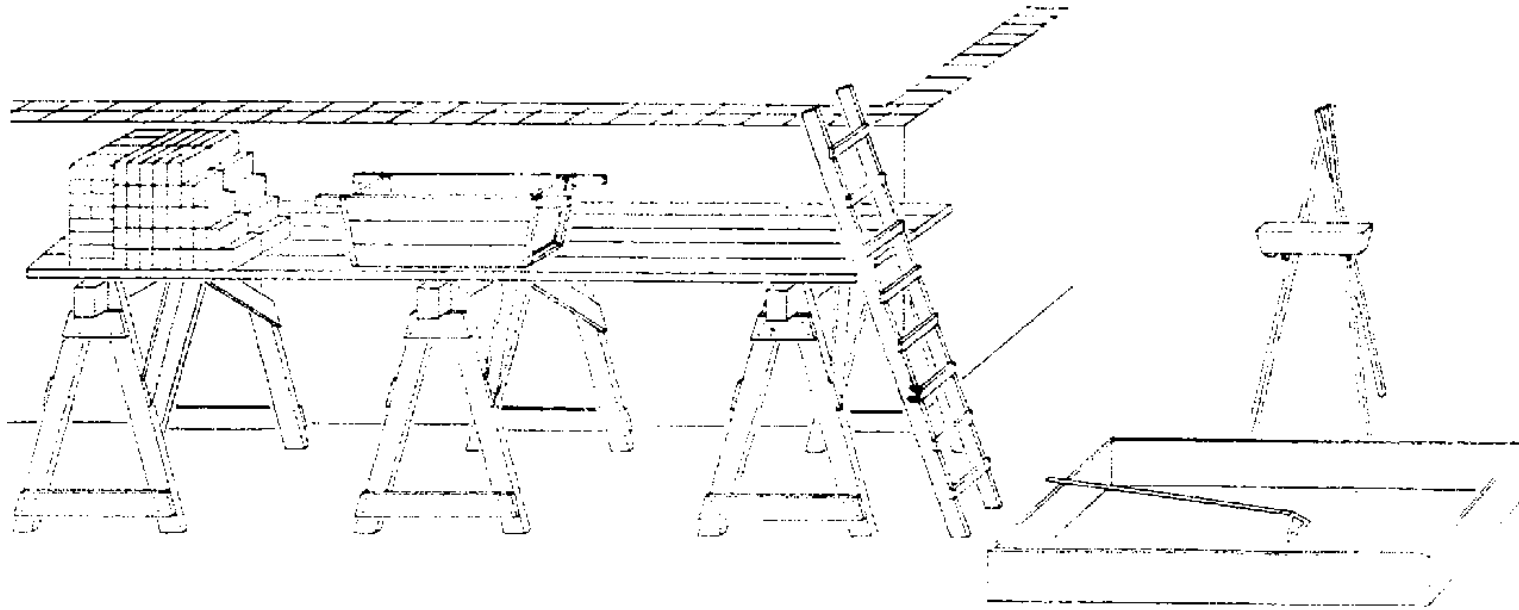

REFERENCES:

1. Jack/Stroud/Foster
MITCHELL'S BUILDING CONSTRUCTION
"Structure and Fabric"
Part 1 and 2

2. Chudley
"Construction Technology"
Vol. 1, 2, 3
Longman

3. R.L. Fullerton
"Building Construction in Warm Climates"
Vol. 1, 3.

Oxford

4. R. Barry

"The Construction of Buildings"

Vol. 1, 3rd Edition

5. J.K. McKay

"Building Construction-Metric"

Vol. 1 and 4

6. W. G. Nash

"Brickwork 1 and 2"

7. Ns. Whyte and Vincent Powell-Smith

"The Building Regulations"

5th Edition

8. E. Neufert

"Architect's Data."

6.1 FUNCTION AND PROPERTIES OF WALLS

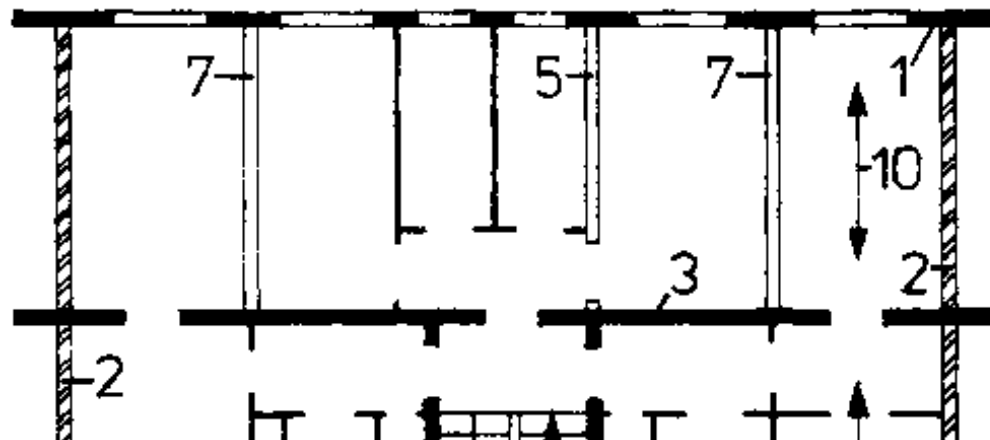



- 1 EXTERNAL WALL ; load bearing
- 2 PARTY WALL ; fire proof
- 3 INTERNAL WALL ; load bearing
- 4 CROSS WALL ; load bearing
- 5 CROSS WALL ; stiffening
- 6 STAIRCASE WALL
- 7 PARTY WALL
- 8 PARTITION WALL
- 9 EXTERNAL WALL ;
non load bearing
- 10 DIRECTION OF SPAN of the

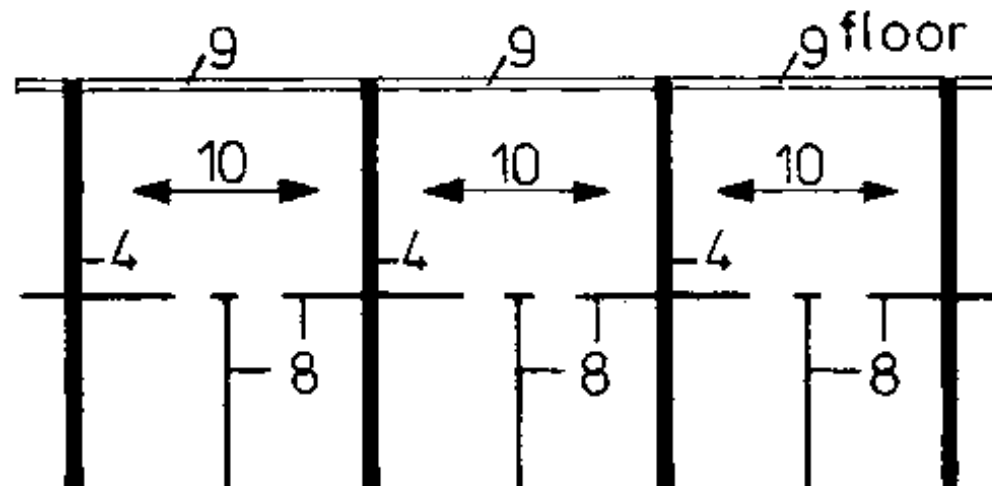



- **Walls are the vertical elements of a building**
- **They have to fulfill two functions:**
 - (1): loadbearing
 - (2): space enclosing and dividing
- **There are certain requirements which a wall must satisfy: Adequate**
 - strength and stability
 - weather resistance
 - thermal insulation
 - fire resistance

(these functional requirements are not given in order of importance, since this will vary with the main function of the wall).

- **STRENGTH and STABILITY:**

The strength of a wall is measured in terms of its resistance to the stresses set up in it

- by its own weight
- by superimposed loads and
- by lateral forces (such as wind)

Its stability in terms of its resistance to overturning

- by lateral forces and
- by buckling

caused by excessive slender-ness.

The Building Regulations (which lay down requirements for the calculation of wall thicknesses) provide means for determining thicknesses other than by calculating.

The Table below gives RULES FOR DETERMINING THE THICKNESS OF BRICK AND BLOCK WALLS (NON-CALCULATED)

TABLE 19 RULES FOR DETERMINING THE THICKNESS OF BRICK AND BLOCK WALLS (NON-CALCULATED WALLS)

Rule Number	Type of Wall	Building of which Wall Forms a Part	Height of Wall	Length of Wall	Minimum Thickness of Wall	Additional Requirements as to Thickness and Construction of Wall
1	Certain external walls and separating walls not exceeding 12 m high	1. Single storey 2. Two storeys or more if the imposed load on each floor is less than 3 kN/m ²	Not exceeding 3.6 m	Any length	200 mm for the whole height	(i) Subject to Rules 4 to 8 below the thickness of these walls shall be as in adjoining column, (ii) In addition the thickness of the wall, in any storey, for not less than one-quarter

						less than one-quarter of its length, shall not be less than one- sixteenth of the height of that storey,
			Exceeding 3.6 m but not exceeding 9 m	Not exceeding 9 m	200 mm for the whole height	
				Exceeding 9 m	300 mm from the base for the height of one storey and 200 mm for the rest of its height	
			Exceeding 9 m but not exceeding 12m	Not exceeding 9 m	Ditto	
				Exceeding 9 m	300 mm from the	

					base for the height of two storeys and 200 mm for the rest of its height	
2	Certain other and external walls and separating walls not exceeding 12 m high	Other than those in Rule 1	Not exceeding 7.5 m	Unlimited	Subject to Rules 4, 5, 7 and 8, the thickness must be not less than 300 mm (200 mm for the top storey)	(i) In addition (a) the thickness of the wall between the base and 5 m below the top shall not be less than the thickness which would be obtained if the wall were to be built solidly throughout the space between straight lines drawn on each side joining the thickness at the base to the thickness at 5 m below the top. (b) The thickness of the wall in any storey for not less than one-quarter of its length to be not

						less than one-fourteenth of the storey height, (c) No offsets allowed in the wall except at the level of lateral supports.
			Exceeding 7.5 m but not exceeding 9 m	13.5 m		
			Exceeding 9 m but not exceeding 12.2 m	10.5 m		
3	Certain internal load-bearing walls (excluding a separating wall)	Any building other than a house of one or two storeys	Heights in Rule 1 or 2 (as the case may be) with lengths twice those in Rule 1 or 2 (as the case may be)	Half the thicknesses in Rule 1 or 2 (as the case may be)		
4	Certain external walls and	Any	Heights and lengths in Rule 1 or 2 (as the case may be)	Subject to Rule 6, if the wall has piers distributed throughout its length and a pier at each end, the		

	separating walls of pier construction			mean thickness of the wall (the plan area of the wall divided by its length) shall be not less than the thickness required by Rules 1 or 2 (as the case may be) and the thickness of the wall between the piers shall not be less than 200 mm.
5	<i>Cavity walls. Tics placed 900 mm apart horizontally and 450 mm vertically, with an additional tie every 300 mm height at jambs to openings. Cavity not less than 50 mm or more than 75 mm wide.</i>	Any	Heights and lengths in Rule 1 or 2 (as the case may be)	Leaves to be not less than 100 mm thick. The overall wall thickness shall be not less than (i) 250 mm, or that required for a solid wall by Rules 1 or 2 (as the case may be) increased by the cavity width, <i>whichever is the greater</i>. Note that the <i>inner</i> leaf may be not less than 75 mm thick if: (a) the wall is of a single storey house or the upper storey of a two-storey house; and (6) the leaf is not more than 8 m long and 3 m high (5 m for a gable); and (c) the wait is built with mortar not weaker than 1: 2:9; and {d) the number of ties given in column 2 is doubled; and (e) the roof load is supported by the outer leaf.

6	External walls of certain small buildings and annexes	1. Single storey building other than a house if its width, measured in the direction of the roof span is not more than 9 m 2. An annexe not more than 3 m high (e.g., verandah, garage, tool shed, lavatory, etc.) attached to a house	Not exceeding 3 m	Any length	The walls may be not less than 100 mm thick provided:(i) it is bonded at each end and intermediately with piers or buttresses which are not less than 200 mm square on plan (including the wall thickness), or of such greater size as may be needed for stability, and so placed that the wall is divided into lengths not exceeding 3 m; and(ii) the wall is built with mortar not weaker than 1: 1:6; and(iii) the wall is not subjected to any load other than the distributed load of the roof of the building or annexe of which it forms a part and is not subject to lateral thrust from such roof.	
			Not exceeding 3 m	Any length		
7	Bays and gables over bay windows	Any			Rules 1 and 2 shall not apply to any part of an external wall which forms a bay for a bay window; and is above the level of the sill of the lowest window opening in such bay; and built with mortar not weaker than 1:2:9.	
8	Parapets	Any	Not to exceed	Any	Not less than 200	

			<p>six times the thickness</p>		<p>mm or that of the wall on which it is carried {whichever is the less}</p>	
--	--	--	---	--	---	--

NOTES

Openings. The number and size of these shall not be such as to impair the stability of the wall. (It is considered that the maximum of window lengths in a wall is three-quarters of the wall length.)

Chases. Vertical chases to be not deeper than one-third of the wall thickness (one-third of the leaf thickness in cavity walls). Horizontal chases to be not deeper than one-sixth of the wall thickness (one-sixth of the leaf thickness in cavity walls).

- WEATHER RESISTANCE:

The external walls of a building are required to provide adequate resistance to rain and wind penetration.

The actual degree of resistance will depend

- upon the height of the wall and
- upon the locality and exposure.

- Wind penetration to walls rarely presents difficulties in solid wall construction only with some types of modern walling of dry construction (consisting of external cladding or sheathing and dry internal linings on some form of frame) problems may arise.

- **Wind** has considerable influence on **rain** penetration, forcing the water through pores and cracks which otherwise it might not penetrate (especially on high buildings).

- **Rain penetration** through walls can be resisted in three ways:

- (1) by ensuring a limited penetration only into the wall thickness
- (2) by preventing any penetration through the outer surface
- (3) by interrupting the capillary paths through the wall.

o In the first the water will be absorbed by a permeable walling material and held as in a sponge, near the outer surface until dry weather conditions, permit it to evaporate

o In the second the use of an impermeable walling material (or facing) will force the water to run down the wall face without entering the wall thickness - (Both methods present difficulties)-

o The alternative to either the first or the second is the third method:

The breaking of the capillary paths by the use of a solid wall structure in which no capillary path exist such as:

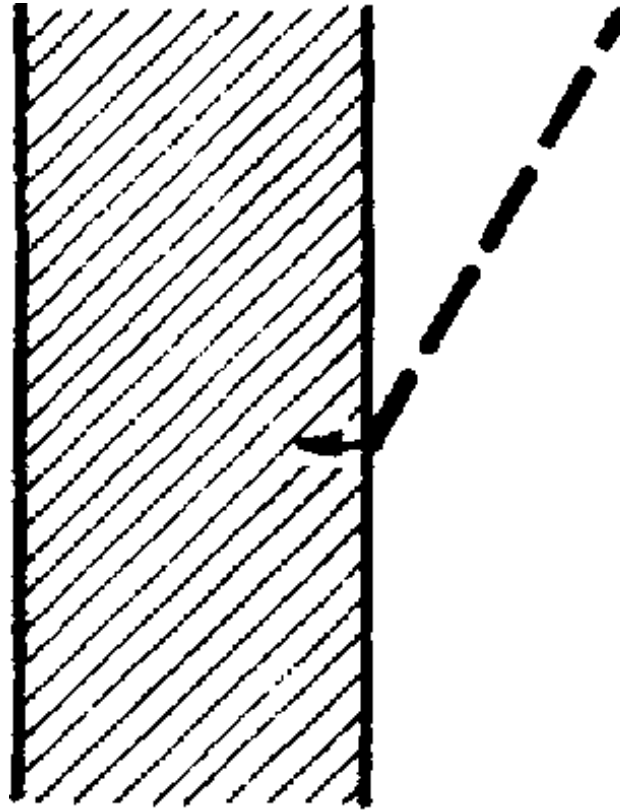

A ABSORPTION BY PERMEABLE MATERIAL

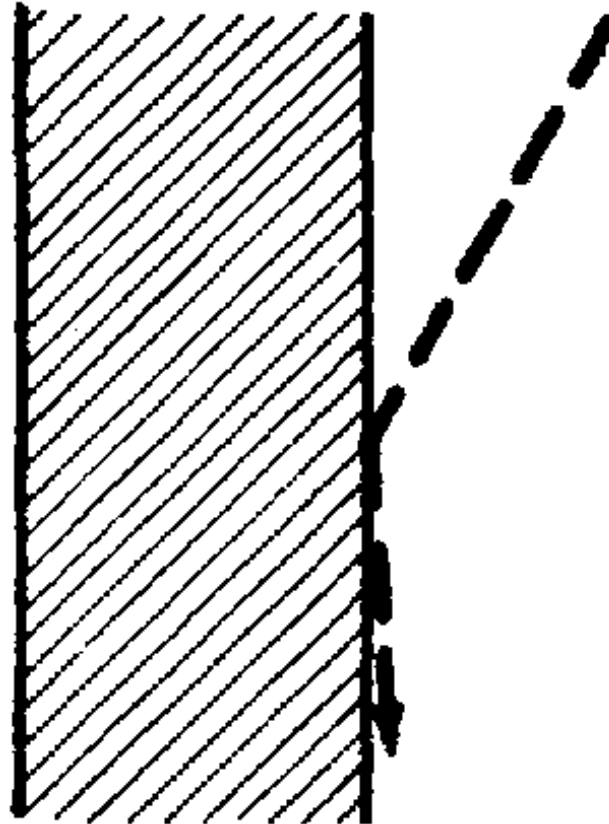

B IMPERMEABLE MATERIAL OR FACING

- no-fines concrete (composed of cement and coarsed aggregate alone, the fine aggregate being omitted) or

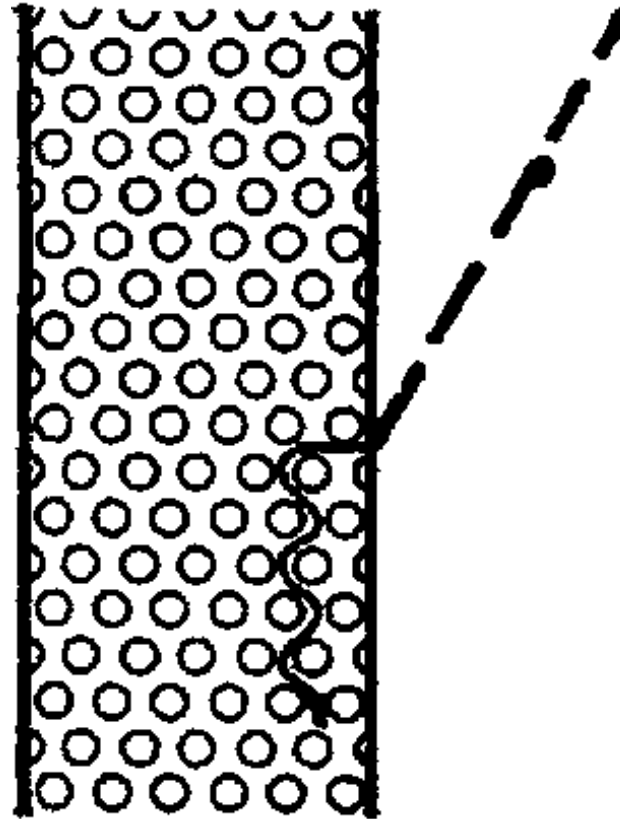

C 'NON-CAPILLARY' MATERIAL

- by the provision of an outer surface which is isolated from the inner surface by a continuous gap or cavity. The outer surface or skin may be non-load bearing (i.e. tile hanging or large suspended cladding panels, or load bearing as in cavity wall construction)

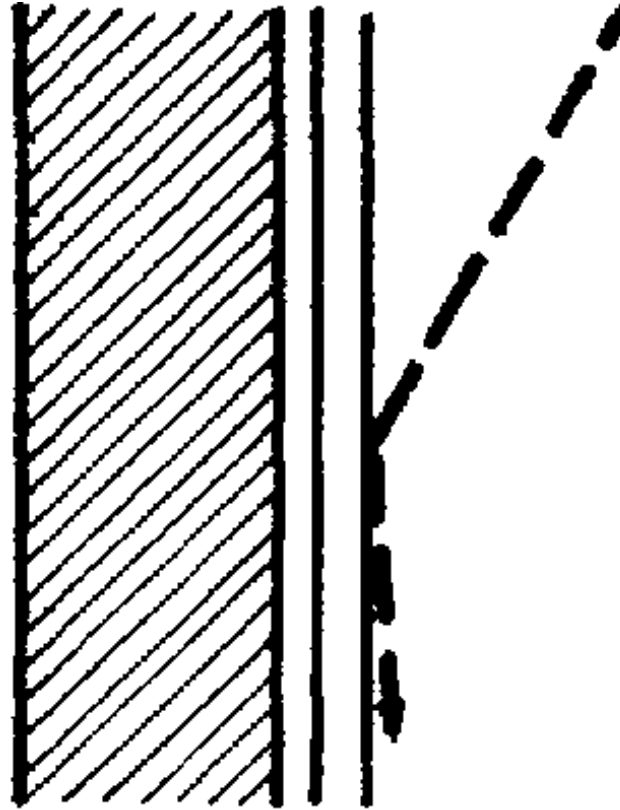

D ISOLATED OUTER SUR FACE 'ATTACHED'

- In addition to protection against lateral penetration of rain a wall must be protected at his base against ground moisture, in form of horizontal and vertical damp - proof, barriers. Protection may be also necessary against the entry of subsoil water under pressure through basement walls.

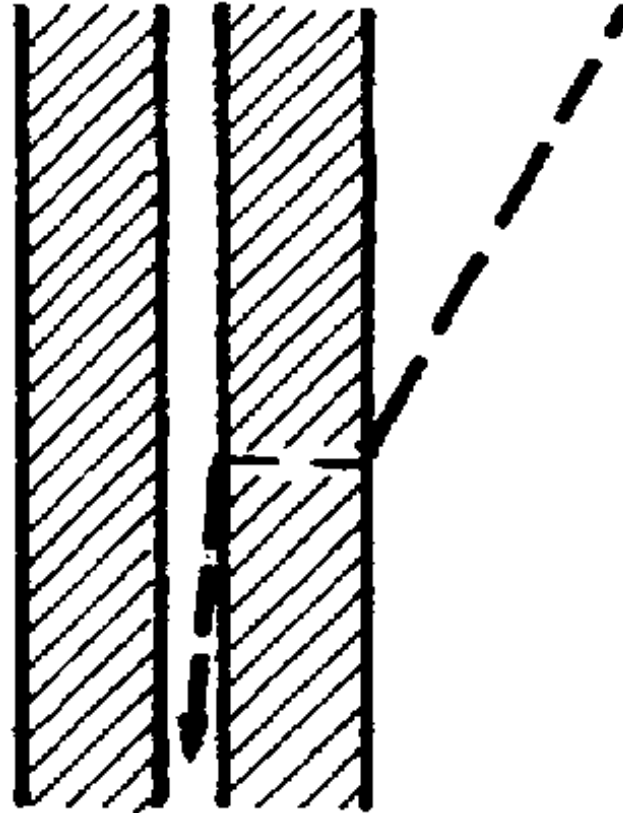

E ISOLATED OUTER SURFACE 'SELF-SUPPORTING'

- FIRE RESISTANCE:

BS 476
PART 8 1972

According to the Building Regulations chapter 5:

'FIRE RESISTANCE of an element of structure, a door, or other part of a building means the period of

FIRE RESISTANCE OF AN ELEMENT OF STRUCTURE, A DOOR, OR OTHER PART OF A BUILDING MEANS THE PERIOD OF TIME FOR WHICH A SPECIMEN CONSTRUCTION (OF THE SAME SPECIFICATION AS THE PARTICULAR ELEMENT, DOOR, ETC.) WOULD SATISFY THE REQUIREMENTS OF THE TEST BY FIRE TO" BS 476: Part 8 1972 IN RESPECT OF

- a) stability**
- b) integrity and**
- c) insulation'**

The term fire resistance is a relative term applied to elements of structure and not of material. It is not to be confused with non-combustibility.

- THERMAL INSULATION:

The external walls of a building, together with the roof must provide a barrier to the passage of heat in order to maintain satisfactory internal conditions without the wasteful use of an air conditioning system.

Adequate thermal insulation depends mainly on the locality where the building will be erected. (At the coast region other provisions have to be introduced than in regions like Arusha, Iringa or Mbeya.)

- Heat transmission values for various forms of construction are given in special handbooks (i.e. Mitchel Building Construction: Environment and Services) where the principles of thermal insulation are fully discussed.**

6.2 THE BEHAVIOR OF THE WALL UNDER LOAD

- Under vertical loading, a wall may

- crush**
- buckle or**
- settle.**

- CRUSHING:

Is caused by over-stressing the material of which the wall is constructed. This is avoided by adequate thickness at all points to keep the stresses in the wall within the safe compressive strength of the materials.

Eccentric loading (that is loading applied not through the centre of gravity of the wall) has the effect of increasing the compressive stress in the wall on the loaded side and of decreasing it on the unloaded side and tends to cause bending in the wall whatever its thickness.

The reason:

A moment is set up in the wall and to maintain equilibrium this must be resisted by an opposite moment within the wall (the forces for which must be provided by the walling material itself.)

This causes **COMPRESSION** on one side of the axis of the wall and **TENSION** on the other

The result of this can be twofold:

1 the increased compressive stress could become greater than the safe compressive strength of the walling material.

2 if the eccentricity is too great tensile stresses will be set up in the side opposite that on which the load is applied.

Fig. indicates the increasing compressive stress and the development of tensile stress with increasing eccentricity of load.

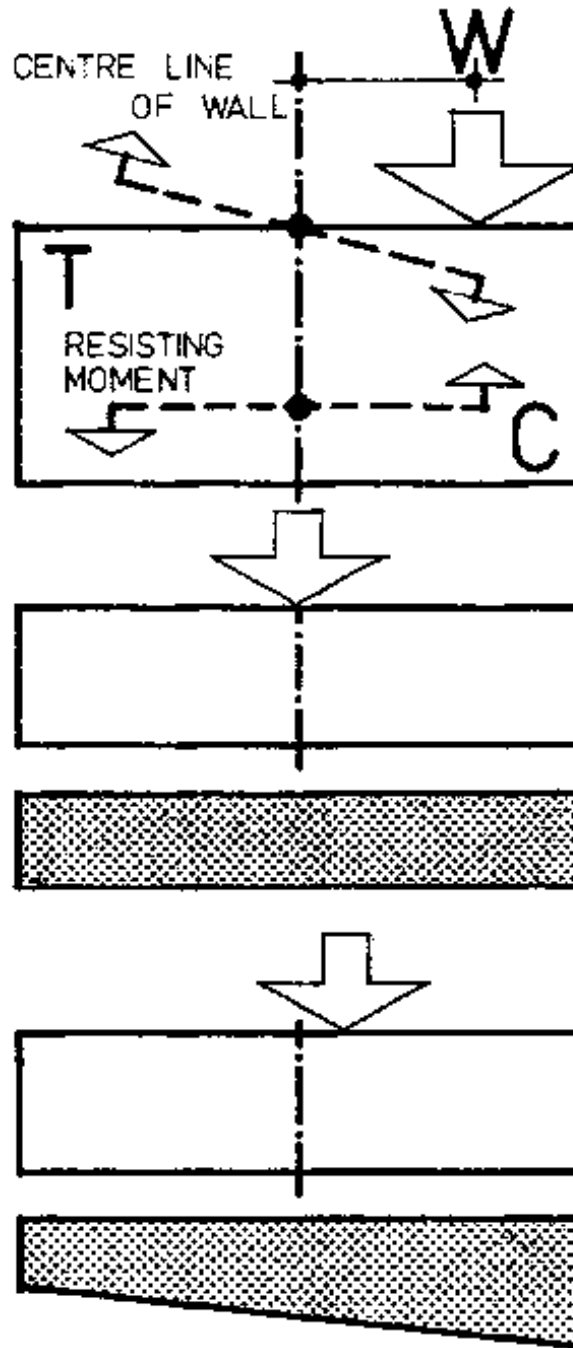

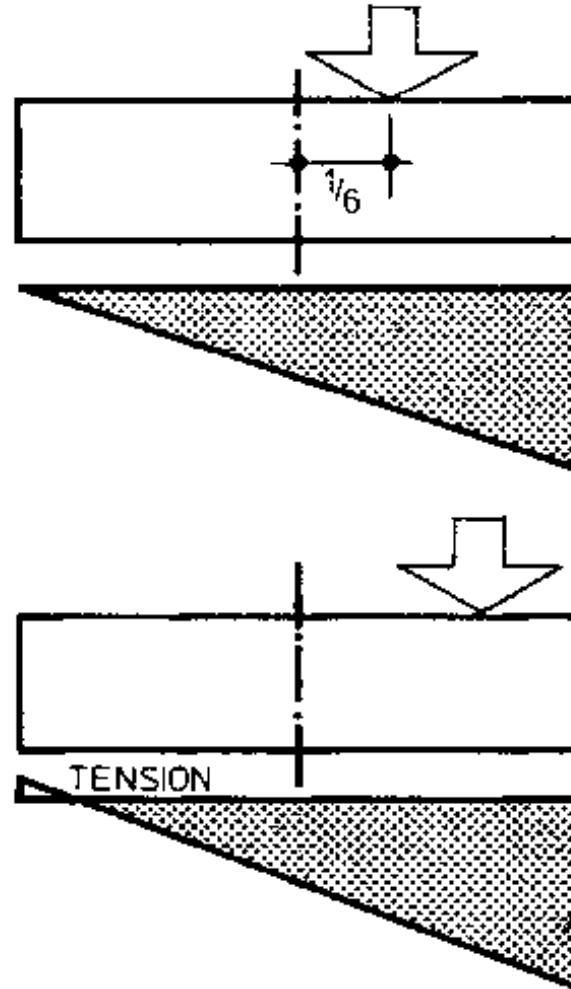

In practice the actual stresses in the wall are determined by the formula

$$\frac{W}{A} + \frac{We}{Z}$$

Where $\frac{W}{A}$ = stress due to the load applied axially

We = moment caused by eccentric loading

Z = a geometrical property relating to the shape and size of the cross-section of the wall such that

$\frac{We}{Z}$ = stress at the faces of the wall due to eccentric loading.

Z: Methods for computing this for any given section are given in standard textbooks on the theory of structures.

- tension will occur when the eccentricity is greater than 1/6 of the wall thickness.
- when the stress due to eccentric loading are too great they are reduced either by reducing the eccentricity or by increasing the thickness of the wall.

The. last has the double effect of reducing the relative eccentricity and of increasing the value of Z.

- BUCKLING

Will occur when the thickness of the wall is small relative to its height. Short walls or piers ultimately fail by crushing, but as the height increases they tend to fail under decreasing loads by buckling.

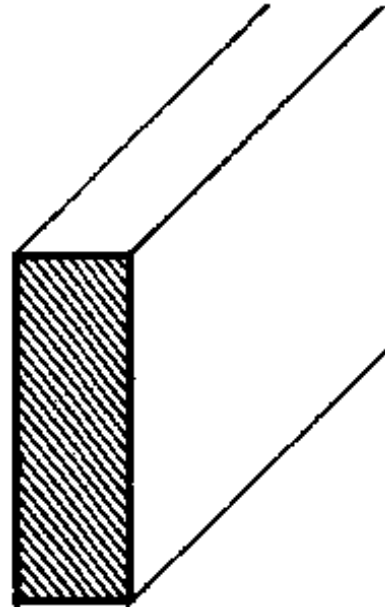

'SHORT' WALL

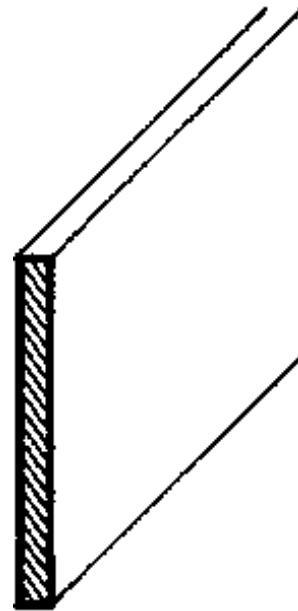

'TALL' WALL

The terms "SHORT and TALL" in this context are relative to the thickness of the wall not to its actual height. They are defined in terms of the ratio of unsupported height to horizontal thickness known as

SLENDERNESS RATIO

The greater this is the tendency to buckle. Buckling is not related to the strength of the walling material but to the stiffness of the wall.

Buckling may be controlled either by

- restricting height,
- increasing thickness
- stiffening by buttresses
- intersecting walls or by
- reducing the applied load.

- SETTLEMENT

The downward force of a wall must be resisted by an equal, upward reaction from the soil on which it rests in order to maintain equilibrium.

Soils vary in strength (some, verging on rock, are very strong, other are relatively weak).

All of these consolidate underload but rock can resist very high stresses with little consolidation while the same stresses would cause excessive consolidations in others.

This consolidation causes a vertical downward movement of the wall which is known as **SETTLEMENT**.

SETTLEMENTS OF WALLS

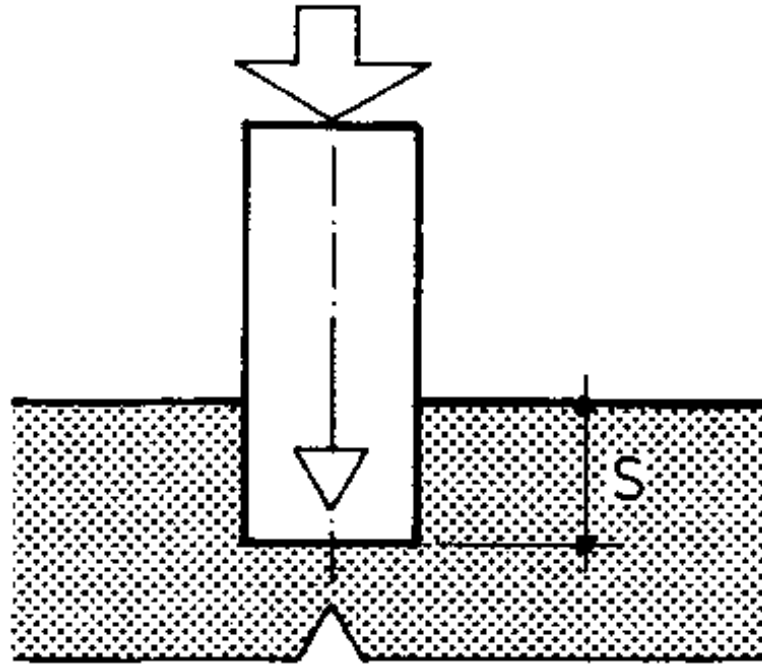

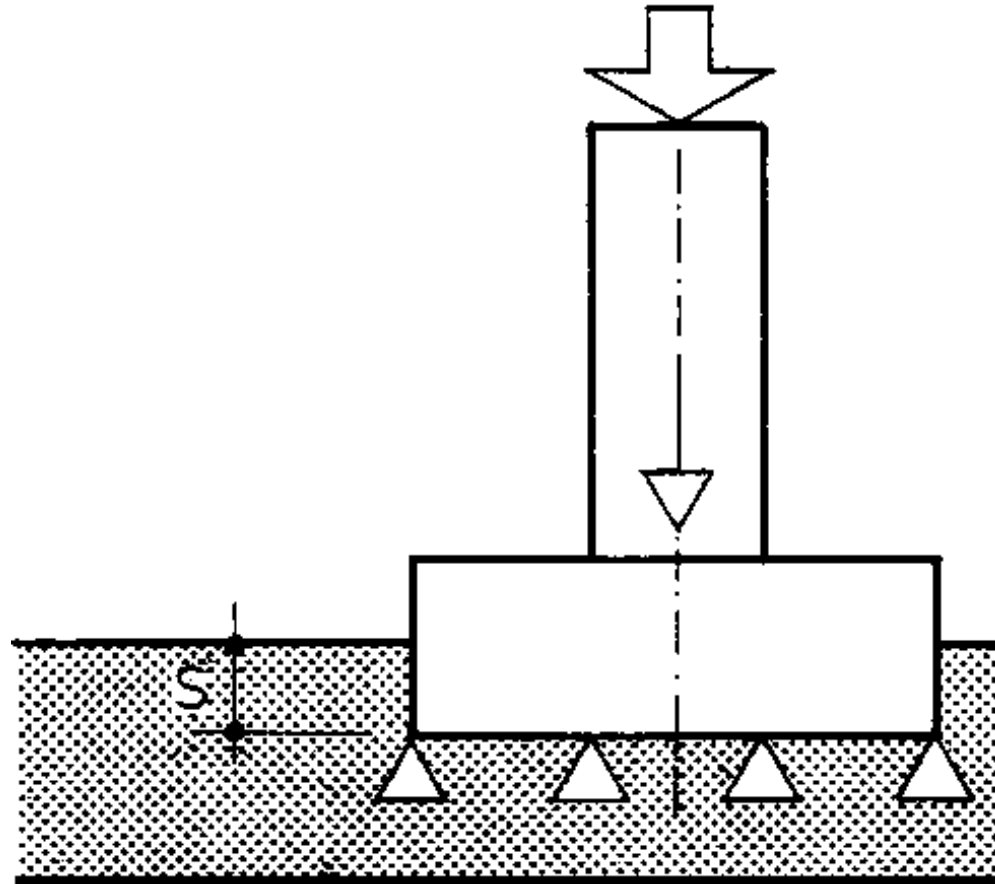

In order to keep the settlement within acceptable limits, the base of the wall has to be made of such a size that the load is distributed over a sufficiently large area of soil.

- Under horizontal loading a wall may

- slide or
- overturn

- SLIDING

Occurs more likely in a freestanding wall than in a wall forming part of a building.

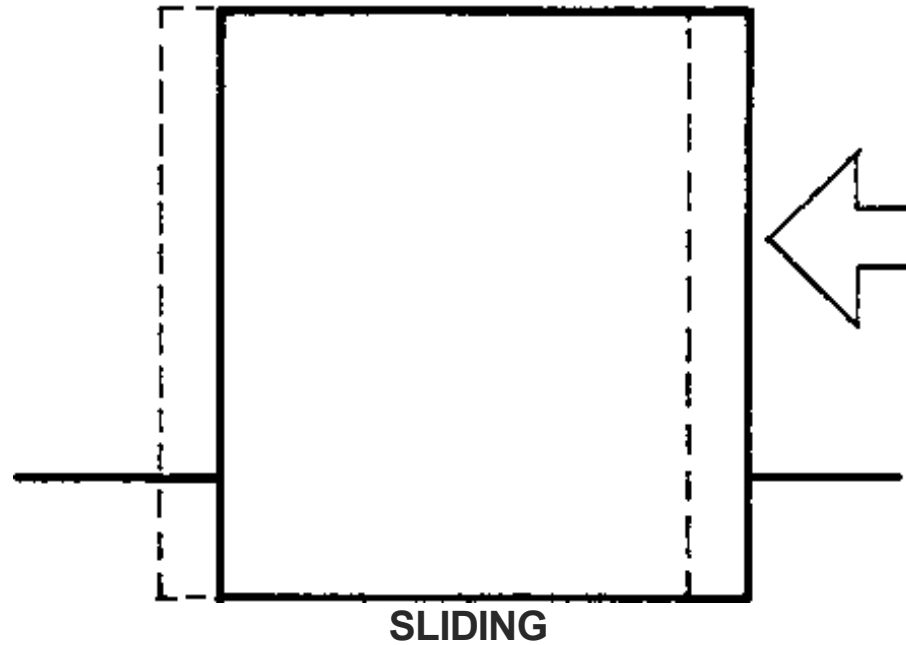

Friction and the passive pressure of the soil on which the wall rests are utilized to prevent sliding action.

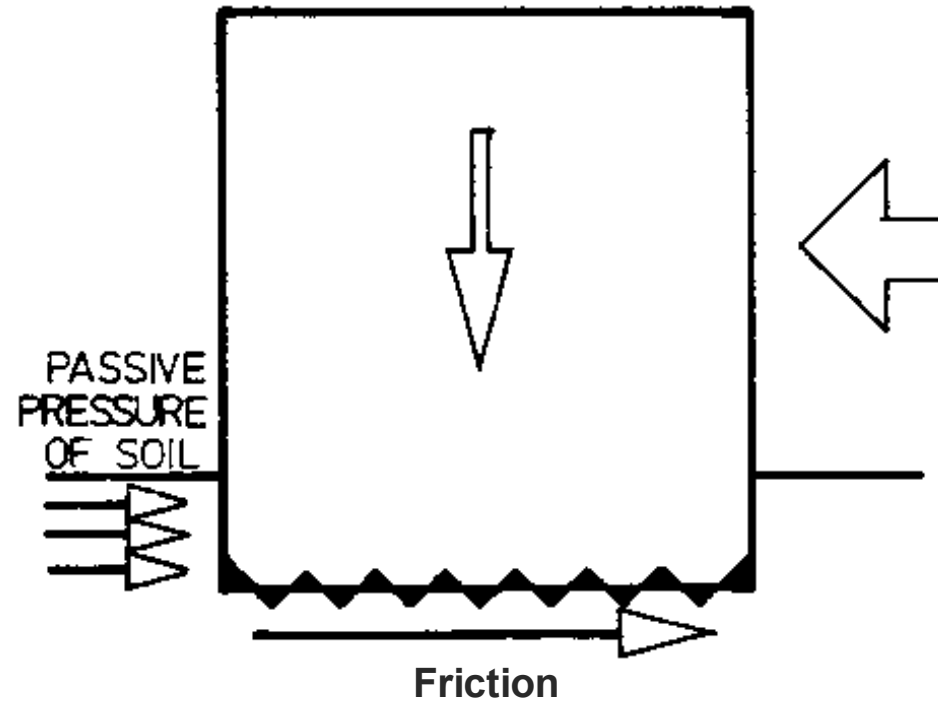

The amount of friction (or the. frictional resistance) depends upon the weight exerted on the soil. That is the pressure between the two surfaces, and upon the degree of smoothness of the surfaces

The ratio of frictional resistance to weight is constant.

The ratio is termed COEFFICIENT OF FRICTION and varies according to the types of surface in contact.

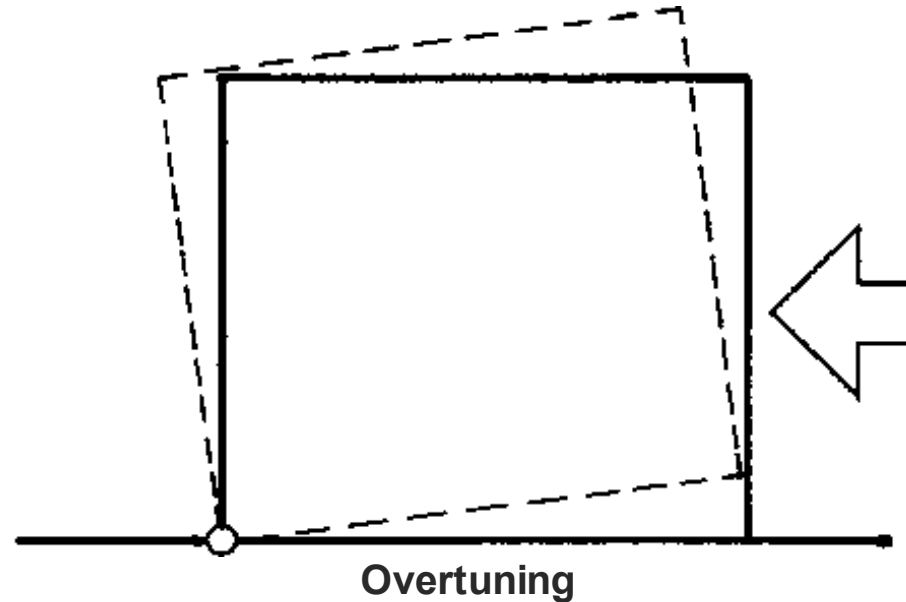

Therefore:

Frictional resistance = coefficient of friction x weight.

The other force which may resist the tendency of the wall to slide is the passive pressure of the soil.

The stresses in the soil caused by this pressure must be kept within the safe limits of the particular soil by taking the wall deeper into the soil (so that the pressure is distributed over a greater area.

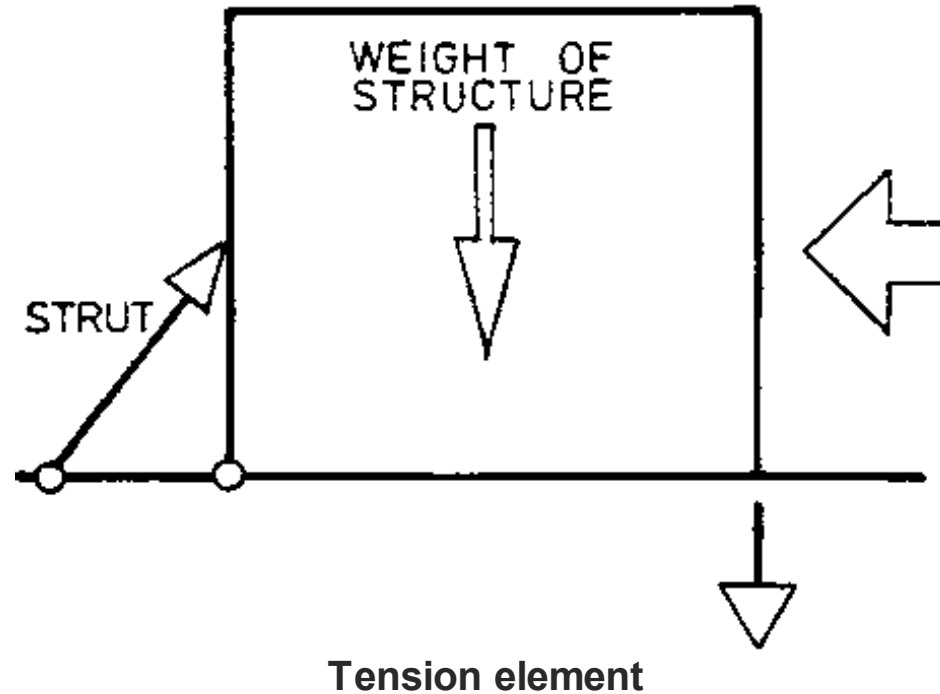

- **OVERTURNING** may be caused by

- 1 rotation or
- 2 settlement.

Overturning by rotation occurs when the counter-moment W_e set up by the weight of the wall acting through its centre of gravity is too small to resist the moment F_e set up by the overturning force.

In these circumstances the resultant of the weight of the wall W and the overturning force F falls outside the base of the wall so that the base is wholly under tension and overturning occurs.

To prevent this:

The weight of the wall can be increased by increasing

**its height
or thickness.**

The latter is most beneficial because it also increases the width of the base within which the resultant must fall.

Alternatively (or in addition) the shape of the wall may be made trapezoidal to shift its centre of gravity relative to the base towards the overturning force thus reducing the eccentricity of the resultant at the base.

Another alternative is to use Buttresses

These methods are adopted for walls having little tensile strength. Alternative and (in case of tall walls) more economic methods may be adopted when materials with adequate tensile strength are used, such as reinforced concrete.

The use of a strut to prevent rotation may be adopted and where a wall undergoing a lateral force forms part of a building a floor can often be made to function as a strut.

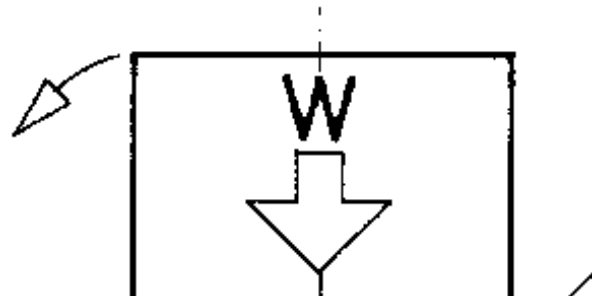

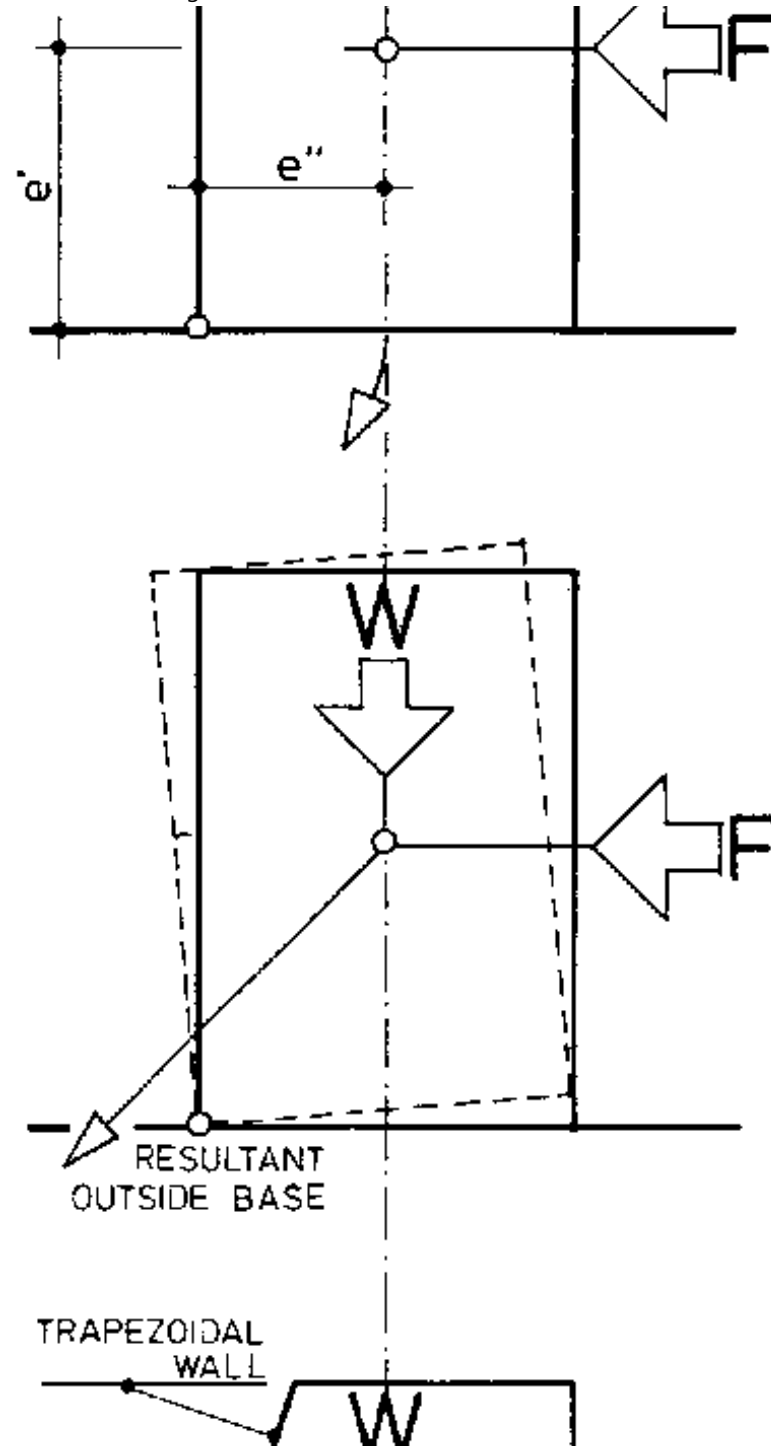

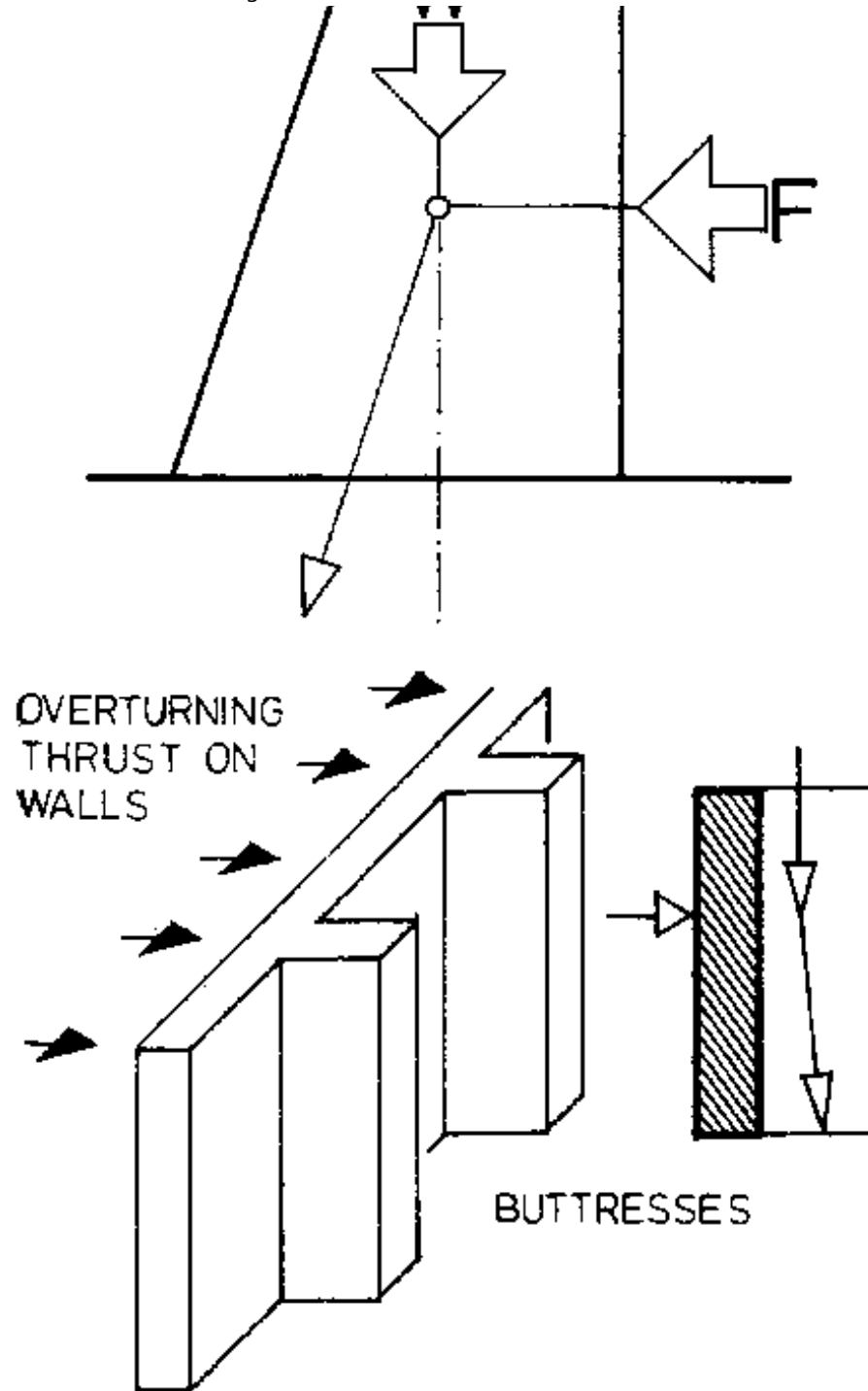

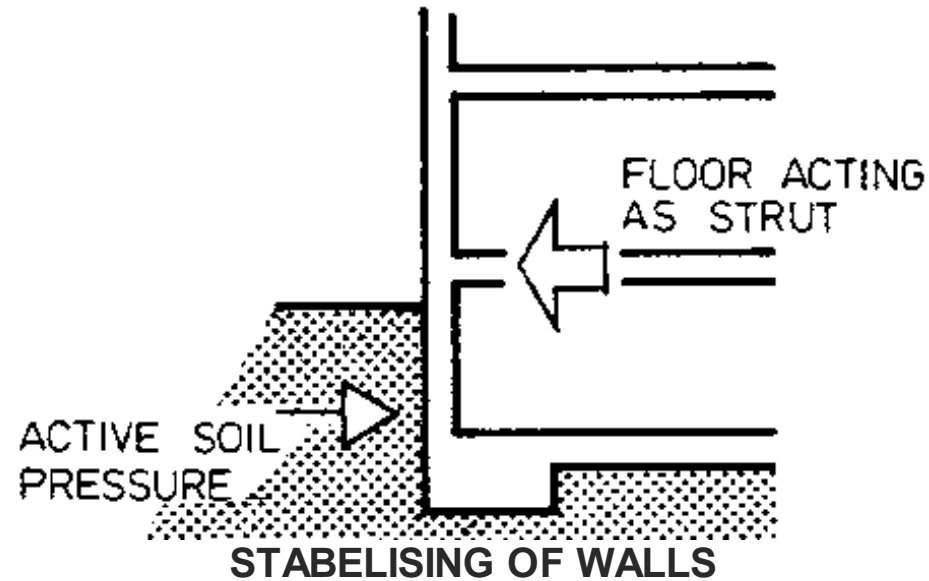

- **OVERTURNING** due to **SETTLEMENT**: may occur though overstressing of the soil causing excessive consolidation under the wall and the overturning force will always cause excentric pressure at the base of the wall leading to simular stress distributions to those in an eccentrically loaded wall.

OVERTURNING OF WALLS: SETTLEMENT

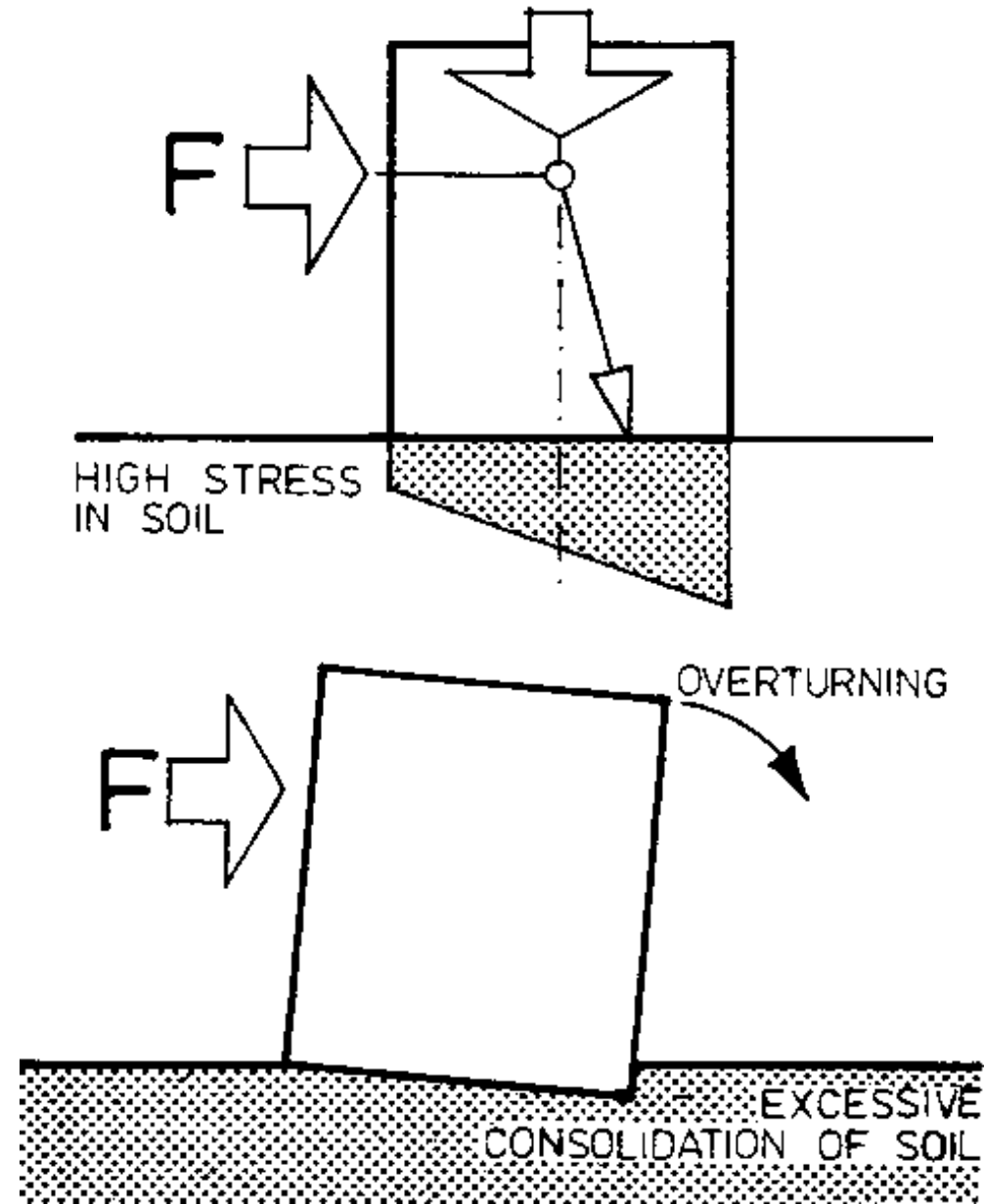

This will result in a distribution of pressure in the soil with a pressure at the toe which might be

considerably greater than the average pressure.

If this overstresses the soil, excessive consolidation might occur at this point causing overturning through unequal settlement of the wall.

This problem can be overcome by reducing the eccentricity of the resultant

- **by increasing the thickness of the wall or**
- **by increasing the width of its foundation, or**
- **by making the wall trapezoidal in shape.**

6.2.1 CALCULATION OF WALL THICKNESS

For determining the thickness of walls and piers certain terms have to be defined in relation to this.

- SLENDERNESS RATIO = the ratio of effective height to effective thickness. (But in the case of walls it may be based alternatively on the effective length.

if this is less than the effective height. This ratio is provided by vertical as well as by horizontal lateral supports

- EFFECTIVE HEIGHT = is based on the distance between adequate lateral supports provided by floors and roof and depends upon the degree of support they are assumed to provide. The greater the degree of support the smaller is the proportion of the distance between centres of support taken as the effective height. This is illustrated in the figures A to C in respect of walls and D, E in respect of columns.

Columns must be considered about both axes. If lateral support is provided in one direction only, as indicated by the beam in (D), the effective height relative to that direction will be as shown, but in the other direction it must be twice its height above the lower support. In the absence of any top support (E)

The latter value must be taken relative to both directions.

Where the wall between two openings constitutes a column as in (F) its effective height is based upon the height of the taller of the openings, Z . Where Z does not exceed $H/2$ the effective height is $1\frac{1}{2}Z$. Where Z exceeds $H/2$ it must be taken as $1\frac{1}{2}Z$ or H , whichever is the less.

Supports span on to wall

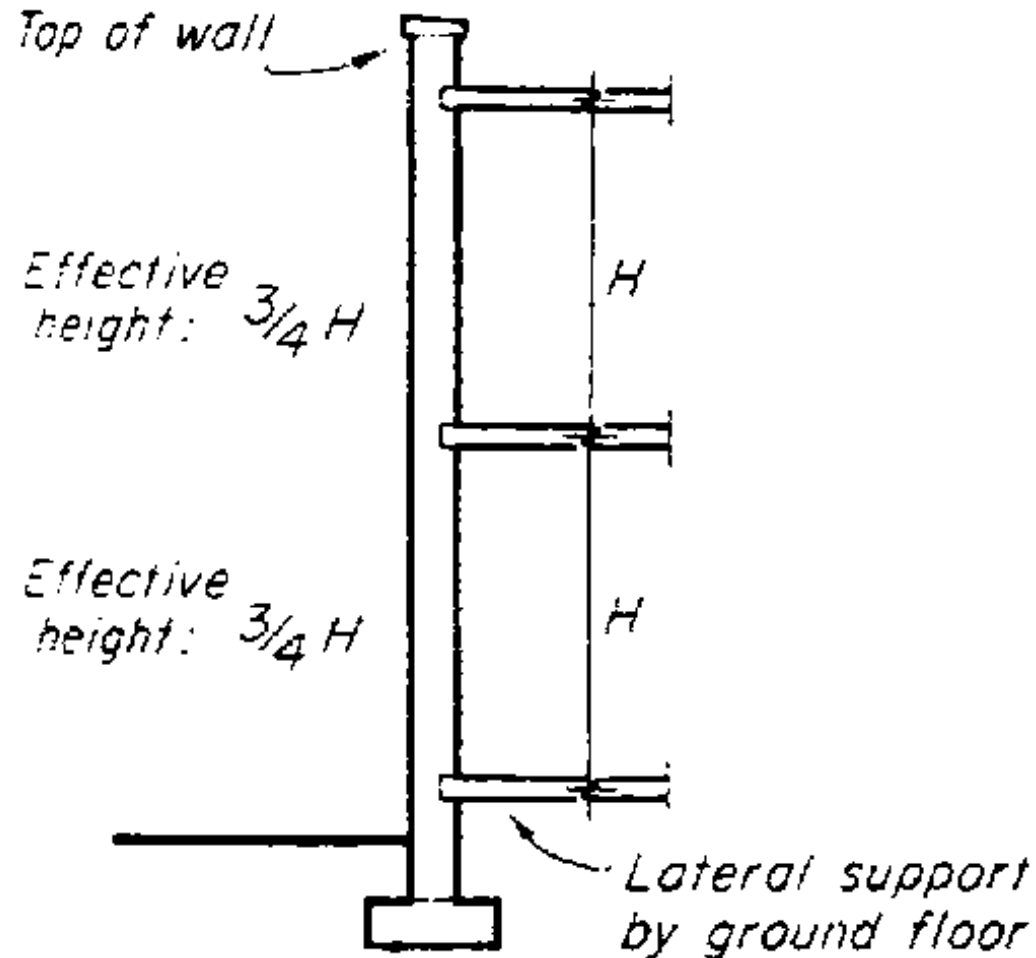

Supports parallel to wall

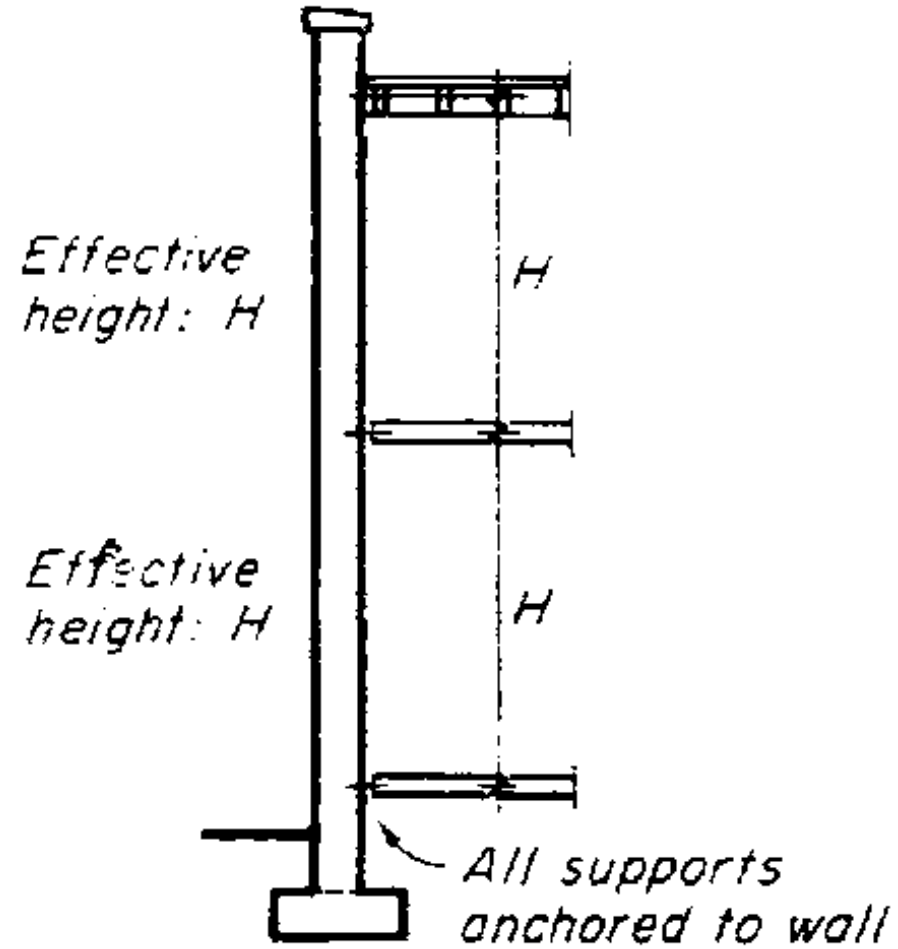

No lateral support at certain points

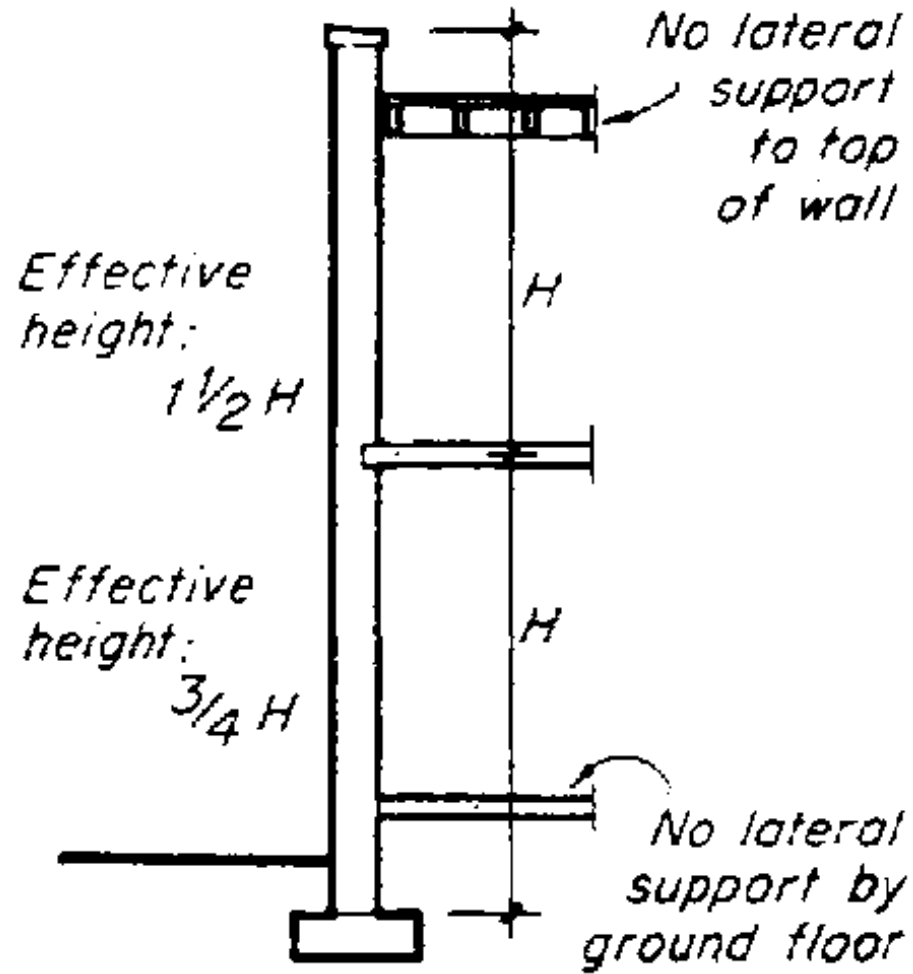

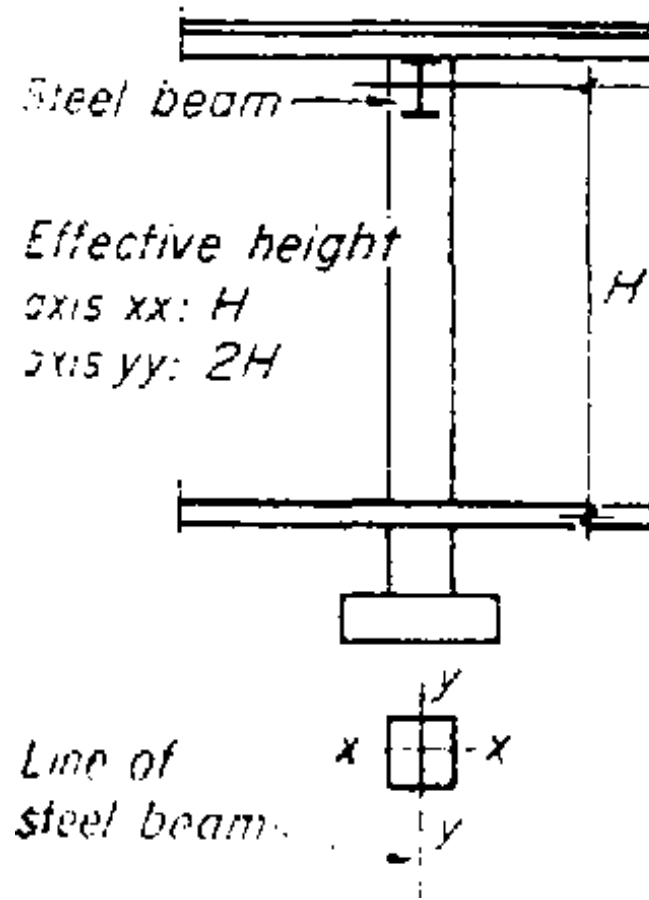

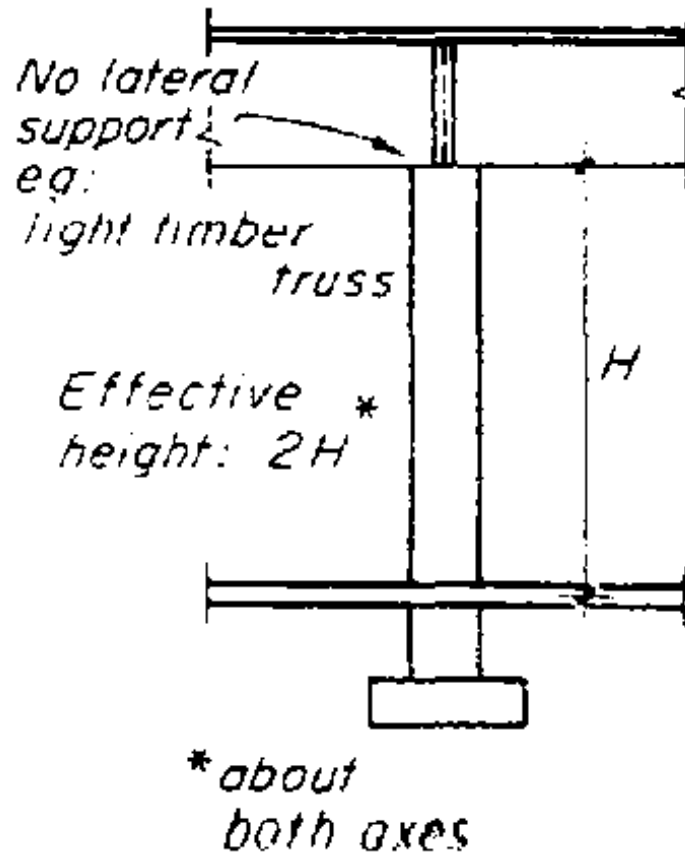

Portion of wall deemed to be a column

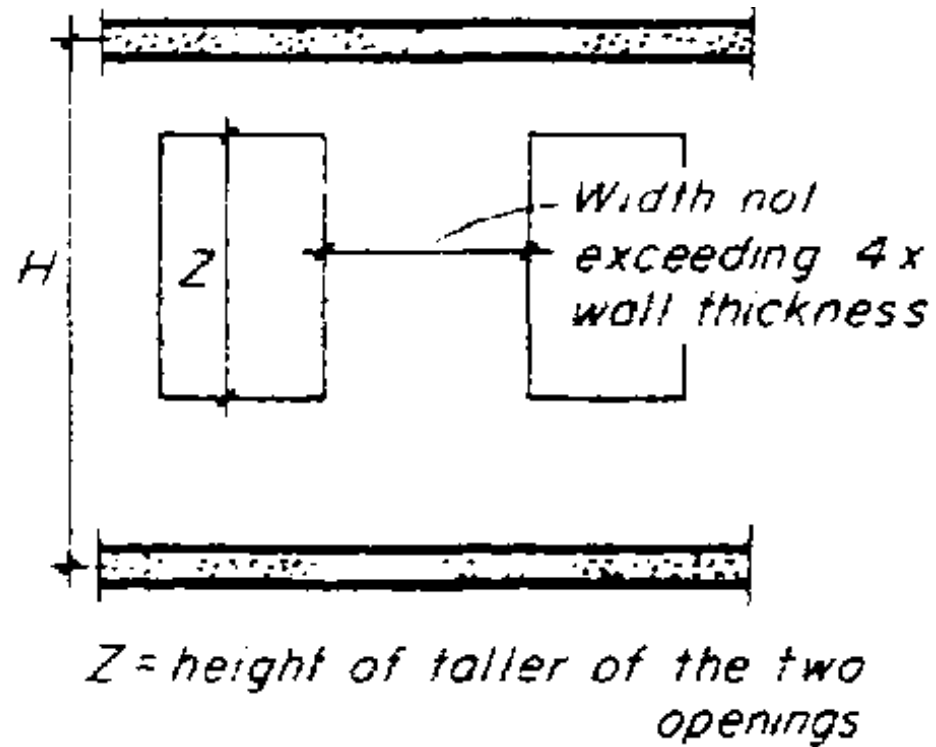

Definition of column

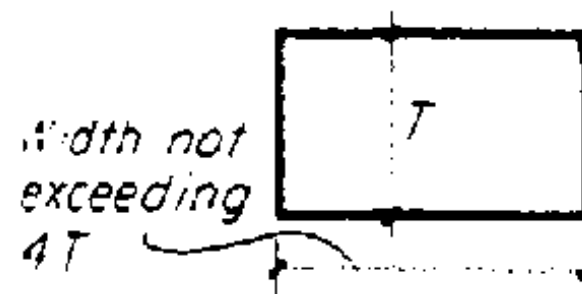

Loadbearing pier deemed to be a wall

Minimum thickness of wall to which pier is bonded

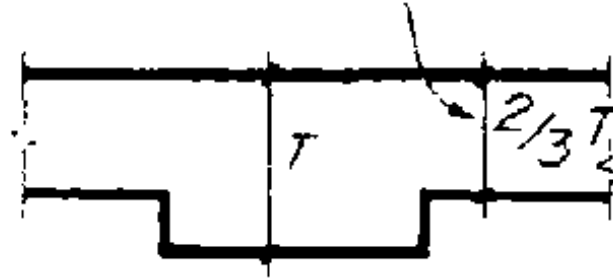

Thickness of pier

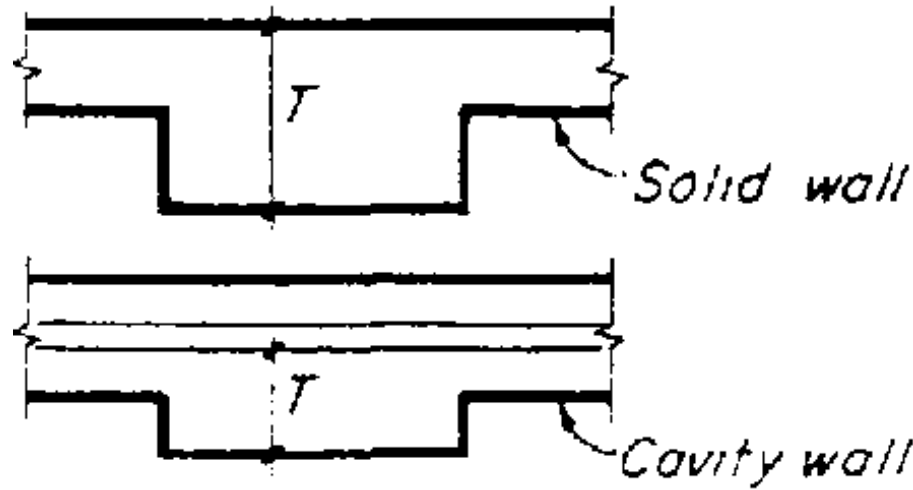

Effective length of walls

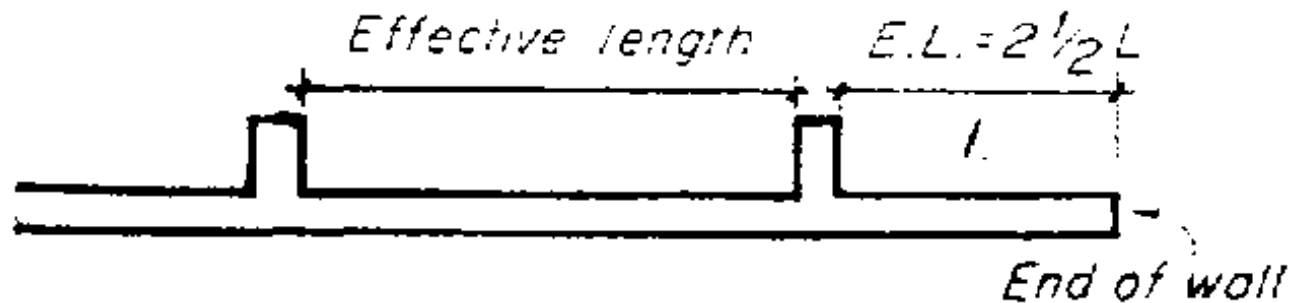

Buttressing walls

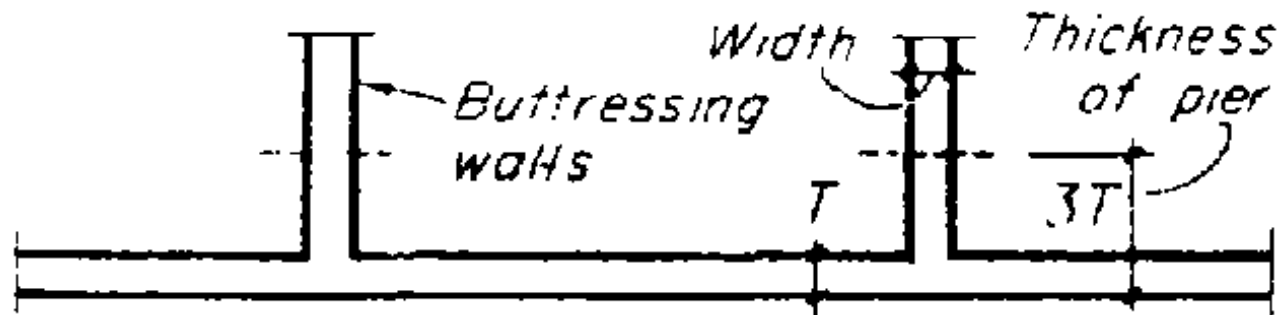

EFFECTIVE LENGTH = This is the distance between adjacent piers, buttresses or intersecting or return walls. The effective length of the end of a wall with no end stiffening is shown in the figure.

EFFECTIVE THICKNESS = This is the actual thickness of a solid wall excluding plaster, rendering, or any other applied finish or covering. Allowance is made for any stiffening piers which may be bonded to the wall by multiplying the actual thickness by a factor which varies with the size and spacing of the piers, resulting in an effective thickness greater than the actual thickness. Table 1 gives these factors. (Buttressing or intersecting walls may be considered as pier of width equal to the thickness of the intersecting wall and of a thickness equal to three times the thickness of the stiffened wall (figure).

If a column has no lateral support or has support in both directions the effective thickness will be based

If a column has no lateral support or has support in both directions the effective thickness will be based on the least dimensions, and the larger be adopted.

The maximum values for the slenderness ratio of masonry walls are shown in table 2

In many buildings where loading is light and the necessary wall thickness is small the slenderness ratio becomes the controlling factor, limiting as it does the height for any given thickness.

Table 1. Determination of effective thickness of wall stiffened by piers

	<i>Pier spacing</i>				
<i>Thickness of pier</i>	<i>Width of pier</i>				
<i>Thickness of wall</i>	6	8	10	15	20
1.0	1.0	1.0	1.0	1.0	1.0
1.5	1.2	1.15	1.1	1.05	1.0
2.0	1.4	1.3	1.2	1.1	1.0
2.5	1.7	1.5	1.3	1.15	1.0
3.0	2.0	1.7	1.4	1.2	1.0

SLENDERNESS RATIOS

Table 2. Maximum permitted slenderness ratios

<i>Type of wall</i>	<i>Maximum slenderness ratio</i>

Unreinforced brickwork or blockwork	
set in hydraulic lime mortar ditto in buildings not	13
exceeding two storeys	20
Brickwork or blockwork set in other than hydraulic lime mortar ditto in walls less than	27
90 mm thick In buildings of more than two storeys	20

Table 5 Basic stresses for masonry walls

<i>Description of mortar</i>	<i>Mix (parts by volume)</i>			<i>Hardening time after completion of work **</i>
	<i>Cement</i>	<i>Lime</i>	<i>Sand</i>	
				days
Cement	1	0-1/4*	3	7
	1	1/2	4 1/2	14
Cement-lime	1	1	6	
Cement with plasticizer §	1	-	6	14
Masonry cement 	-	-	-	
Cement-lime	1	2	9	

Cement with plasticizer §	1	-	8	14
Masonry cement 	-	-	-	
Cement-lime	1	3	12	14
Hydraulic lime	-	1	2	14
Non-hydraulic	-	1	3	28 ****

* The inclusion of lime in cement mortars is optional

** These periods should be increased by the full amount of any time during which the air temperature remains below 4.4° C plus half the amount of any time during which the temperature is between 4.4° C and 10° C

§ Plasticizers must be used according to manufacturers' instructions

|| Masonry cement mortars must be used according to manufacturers' instructions, and mix proportions of masonry cement to sand should be such as to give comparable mortar crushing strengths with the cement: lime: sand mix of the grade

**** A longer period should ensue where hardening conditions are not very favourable

Note: Where the cross-sectional plan area of a wall or column does not exceed 0.3 m², the basic stress should be multiplied by a reduction factor equal to

$$0.75 \times \frac{A}{1.2}$$

where A is the area (in m²) of the horizontal cross-section of the wall or column

PERMISSIBLE STRESS

PERMISSIBLE STRESS = The stresses permitted in a wall or column are regulated according to the strength of the bricks or blocks, the type of mortar to be used and the slenderness ratio of the wall or column. Basic stresses, arising from combined uniformly distributed dead and superimposed loads and related to the strength of the units and the type of mortar used, are shown in table 3.

*Basic stress in MN/m² corresponding to units whose crushing strength (in MS/m²) *** is:*

			<i>Brickwork member.</i>						<i>Hackwork members</i>								
2.8	7.0	10.5	20.5	27.5	34.5	52.0	69.0	96.5 or greater	2.8	3.5	7.0	0.5	14.0	21.0	28.0	35.0	52.0
0.28	0.70	1.05	1.65	2.05	2.50	3.50	4.55	5.85	0.28	0.35	0.70	1.05	1.25	1.70	2.10	2.50	3.50
0.28	0.70	0.95	1.45	1.70	2.05	2.80	3.60	4.50	0.28	0.35	0.70	0.95	1.15	1.45	1.75	2.10	2.80
0.28	0.70	0.95	1.30	1.60	1.85	2.50	3.10	3.80	0.28	0.35	0.70	0.95	1.10	1.35	1.60	1.90	2.50
0.28	0.55	0.85	1.15	1.45	1.65	2.05	2.50	3.10	0.28	0.35	0.55	0.85	1.00	1.20	1.45	1.70	2.05
0.21	0.49	0.70	0.95	1.15	1.40	1.70	2.05	2.40	0.21	0.23	0.49	0.70	0.80	1.00	1.20	1.40	1.70
0.21	0.49	0.70	0.95	1.15	1.40	1.70	2.05	2.40	0.21	0.23	0.49	0.70	0.80	1.00	1.20	1.40	1.70
0.21	0.42	0.55	0.70	0.75	0.85	1.05	1.15	1.40	0.21	0.23	0.42	0.55	0.60	0.70	0.75	0.85	1.05

***** Linear interpolation is permissible for units whose crushing strengths are intermediate between those given in the table**

REDUCTION FACTORS FOR

Table 4 Reduction factors for slenderness ratios

<i>Slenderness ratio</i>	<i>Stress reduction factor*</i>			
	<i>Axially loaded</i>	<i>Eccentricity of vertical loading as a proportion of the thickness of the member</i>		
		1/6	1/4	1/3**
6	1.00	1.00	1.00	1.00
8	0.95	0.93	0.92	0.91
10	0.89	0.85	0.83	0.81
12	0.84	0.78	0.75	0.72
14	0.78	0.70	0.66	0.62
16	0.73	0.63	0.58	0.53
18	0.67	0.55	0.49	0.43
20	0.62	0.48	0.41	0.34
22	0.56	0.40	0.32	0.24
24	0.51	0.33	0.24	-
26	0.45	0.25	-	-
27	0.43	0.22	-	-

*** Lineal interpolation between values is permitted**

**** Where in special cases the eccentricity of loading lies between $1/3$ and $1/2$ of the thickness of the member, the stress reduction should vary linearly between unity and 0.20 for slenderness ratios of 6 and 20 respectively**

For members with slenderness ratios up to six the basic stresses in the wall or column must be established by the application of a reduction factor to the basic stress. Values for this factor for varying slender-ness ratios and eccentricities of loading are given in table 4.

In order to keep the thickness of walls within reasonable limits and, preferably, of the same thickness for the full height of the building, particularly in the case of cross wall construction, variations in the types of bricks and in the mortar mixes are made according to the stresses at different heights. Excessive variation is uneconomic and leads to difficulties in supervision on the site. Sufficient flexibility in strength can, however, be obtained in most buildings by the use of three to four grades of bricks with one or two mixes of mortar.

A non-calculated brick or block wall shall have a thickness at any level not less than one-sixtieth of the height measured from that level to the top of the wall.

A minimum thickness of 190 mm at any point is required in the case of an external wall, whether calculated or not.

Walls built of materials of differing strengths bonded together are less important now as load-bearing structures since the general practice is to use a thin 'veneer' of non-structural facing material attached to a structural backing, but provision is made for dealing with such a combination in two-ways. The weaker material may be considered to be used throughout the full thickness and the permissible stress established on that basis. Alternatively, the area of that portion of the wall built of the strongest material

established on that basis. Alternatively, the area of that portion of the wall built of the strongest material only may be considered as carrying the load, in which case the permissible stress is established using a slenderness ratio calculated on the thickness of that material alone.

Random rubble walling should be based on permissible stresses of 75 per cent of the corresponding stresses for coursed walling of similar materials.

PROCESS OF DESIGN

The design process may be summarized briefly as follows:

1. Calculate total load (W) per metre run of wall or on column at level under consideration

2. Assume wall or column thickness and establish slenderness ratio.

3. Establish any eccentricity of loading.

4. Ascertain appropriate stress reduction factor (RF) (table 4)

5. Establish bearing area per metre run of wall or of column (A)

6. Establish 'equivalent basic stress' = $\frac{W}{A \times RF}$

7. Select grade of brick and mortar with strengths appropriate to the equivalent basic stress (table 3)

6.3 TYPES OF WALLS

- Walls may be divided into two types:

1 LOAD - BEARING WALLS which support loads from floors and roof in addition to their own

weight and resist side pressure (wind, stored material or objects)

2 NON-LOAD-BEARING WALLS which carry no floor or roof loads.

- Each type may be further divided into **EXTERNAL (or enclosing) WALLS** and **INTERNAL (or dividing) WALLS**

- The external -non-load-bearing wall (related to framed structures) is termed

PANEL WALL (if of masonry construction)

INFILLING PANEL (if of tighter construction)

CLADDING (when applied to the face of the structure)

- The term **PARTITION** is applied to walls (generally non-load-bearing and only one storey high) dividing the space within a building into rooms.

Internal walls which separate different excupancies within the same building ore divide the building into compartments for the purpose of fire protection are termed

PARTY (or PARTING) WALLS SEPERATING WALLS or DIVISION WALLS.

- **RETAINING WALLS:**

There primary function is to resist the thrust of soil (or subsoil water) on one side. The most important functional requirement therefore is strength and stability.

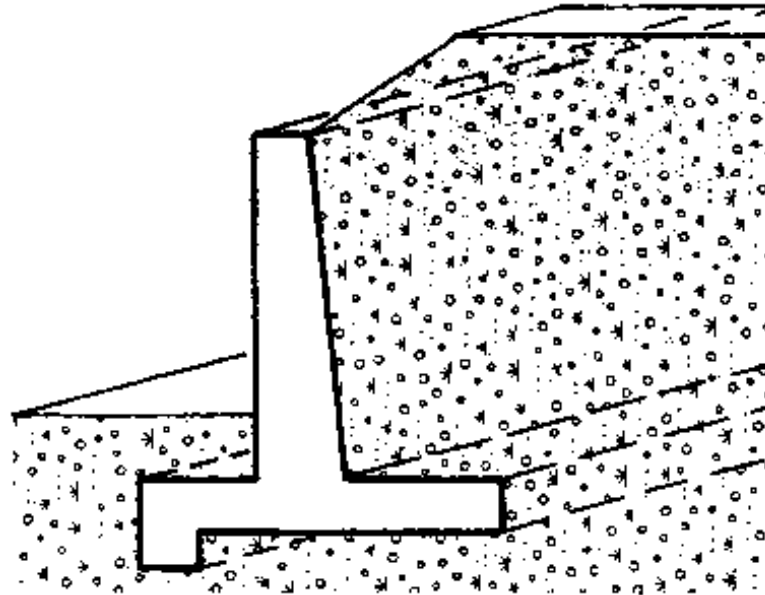

RETAINING WALLS

Regarding to the FORM OF CONSTRUCTION Walls may be described by the following terms:

- MASONRY WALL = The wall is built of individual blocks of materials, such as bricks clay or concrete blocks, stone etc., usually in horizontal courses cemented together with some form of mortar.

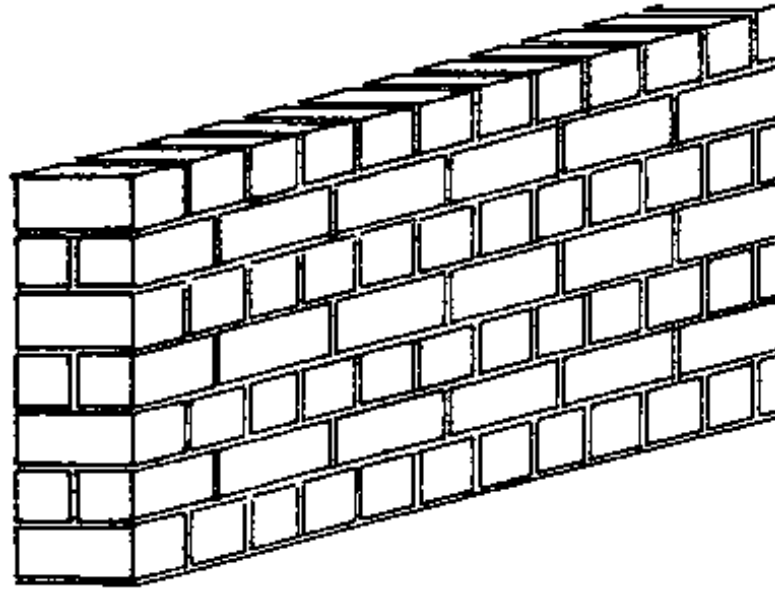

MASONRY WALL

- **MONOLITHIC WALL** = The wall is built of material requiring some form of support or shuttering in the initial stages. The traditional earth wall and the modern concrete wall are examples of this.

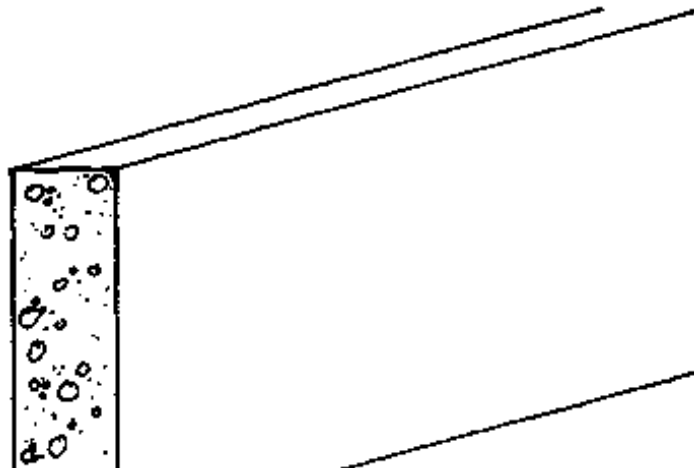



MONOLITHIC WALL

- **FRAME WALL** = The wall is constructed as a frame of relatively small members (usually of timber) at close intervals which together with facing on each side form a load bearing system.

N.B. This is a wall construction not a struct, fram of a building.

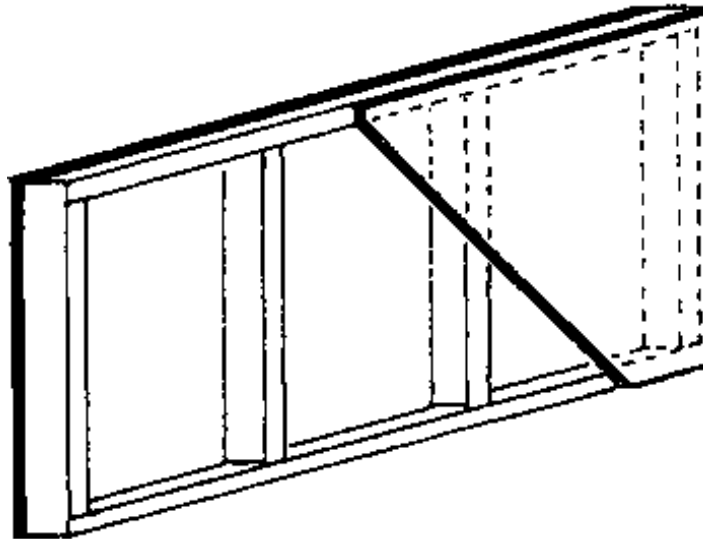

FRAME WALL

- **MEMBRANE WALL** = The wall is constructed as a sandwich: two thin skins or sheets of reinforced plastic, metal, asbestos-cement or other suitable material bonded to a core of framed plastic to produce a thin wall element of high strength and low weight.



MEMBRANE WALL

- **CAVITY WALL** = The wall is constructed in two leaves or skins with a space between, so that the outer surface of the wall is isolated from the inner surface by a continuous gap.

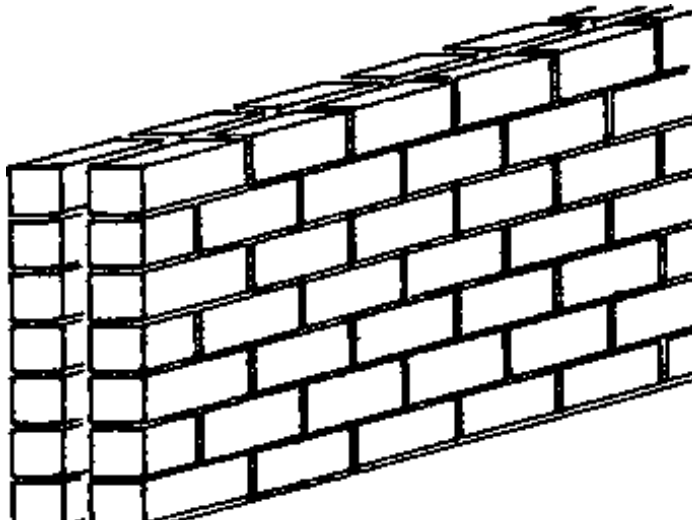

CAVITY WALL

- **Main purpose:** to prevent the penetration of rain to the internal surface of the wall.
- It is essential that the cavity is not bridged in any way as this would provide a passage for the moisture.
- **Air bricks are sometimes** used to ventilate the cavity (- at the head and the base of the wall).
- There is a tendency for the 2 leaves to move towards each other (below ground level). To overcome this problem it is common practice to fill the cavity below g.l. with a work mix, of concrete thus creating a solid wall in the ground
- It is advisable to leave out every 4th vertical joint in the external leaf at the base of the cavity and above the cavity fill, to allow any moisture to escape.

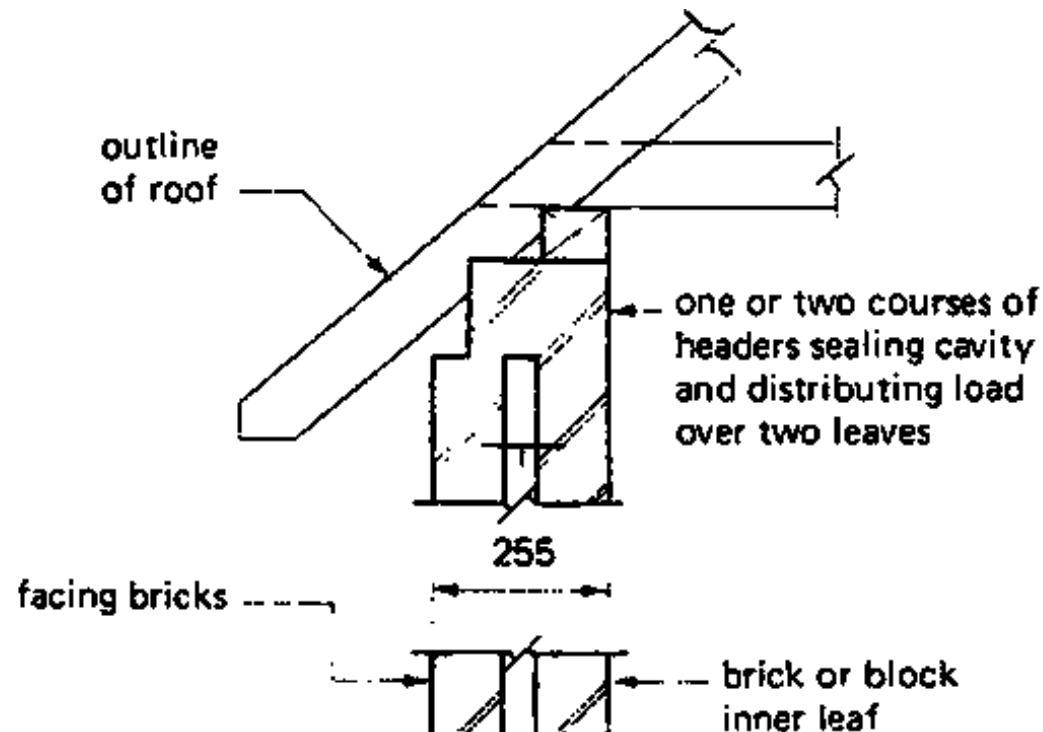

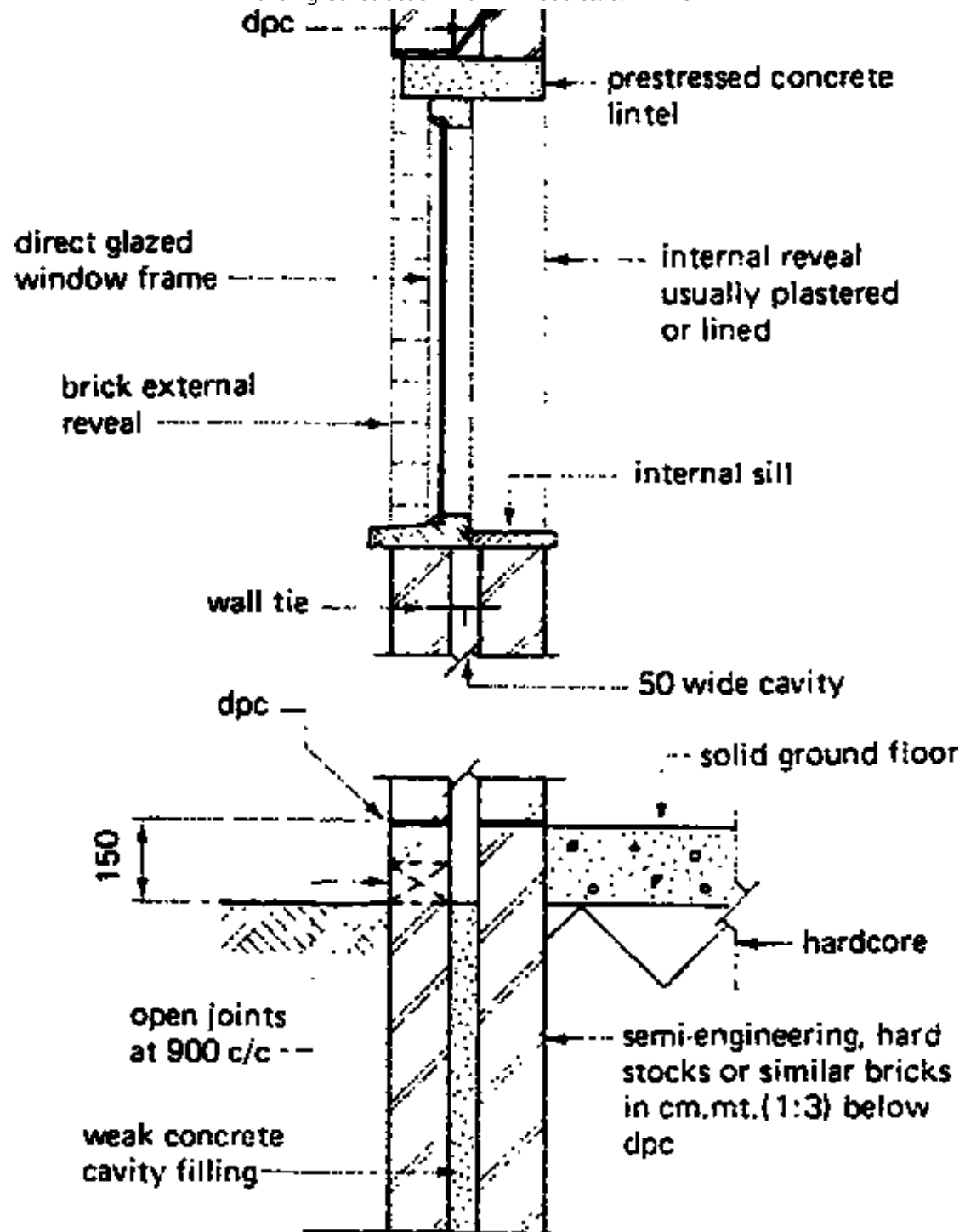

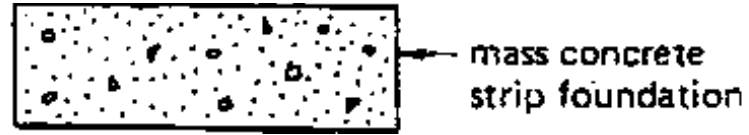

Building Regulations 1972 Schedule 7

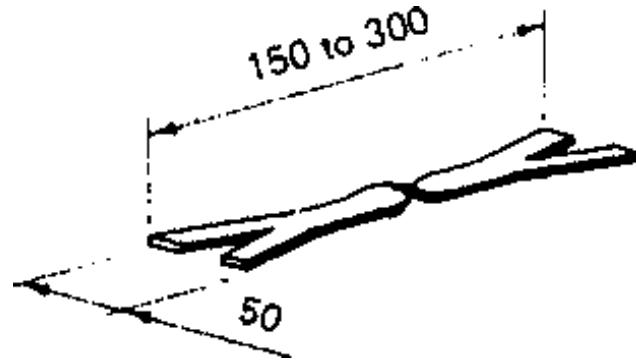

Twisted Pattern

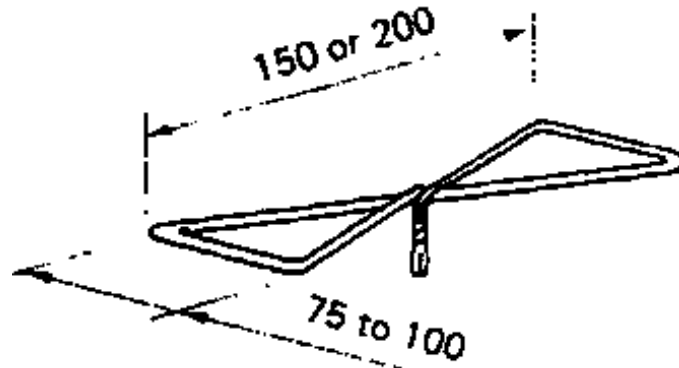

Butterfly Pattern

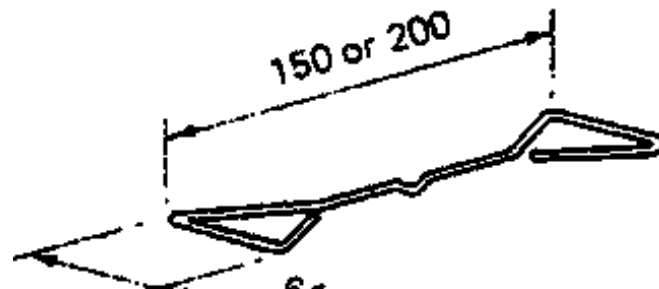

Double Triangle Pattern

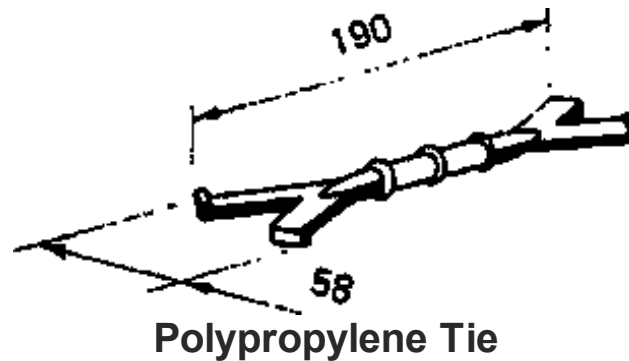

Rule 4: This gives the requirements of the strength of brick or blocks to be used in the construction of walls.

It sets out in detail the various crushing strengths and aggregate volumes of solid material required for various situations and classifications.

Rule 11: This sets out the constructional requirements for cavity walls and is of the utmost importance.

1. Bricks and blocks to comply with Rule 4 and be properly bonded and solidly put together with mortar.
2. The leaves to be securely tied together with ties complying with B.S. 1243:1964 or other not less suitable ties, details of horizontal and vertical spacing are given (Fig. 11.21)
3. The cavity shall be not less than 50 mm nor more than 75mm in width at any level.
4. The leaves shall be each not less than 100mm in thickness at any level (unless covered by paragr. 6 of Rule 11).
5. The overall thickness to comply with paragraphs 3 and 4 or thickness required by Rules 7 or 8 for

solid walls + the width of the cavity (for a nominal 255mm wide cavity wall of any length the maximum height is 3.60 m.

6.a) Inner leaf can be not less than 75mm thick if the wall forms part of a private dwelling house of one story or is the upper story of such a dwelling having only two storeys.

6.b) Inner leaf size not more than 8m in length and not more than 3m in height or 5 m in height if it is a gable wall.

6.c) A gauge mortar not weaker than 1:2:9 to be used.

6.d) Not less than twice the number of wall ties required by paragraph 2 of Rule 11.

6.e) The roof load is supported partly by the outer leaf.

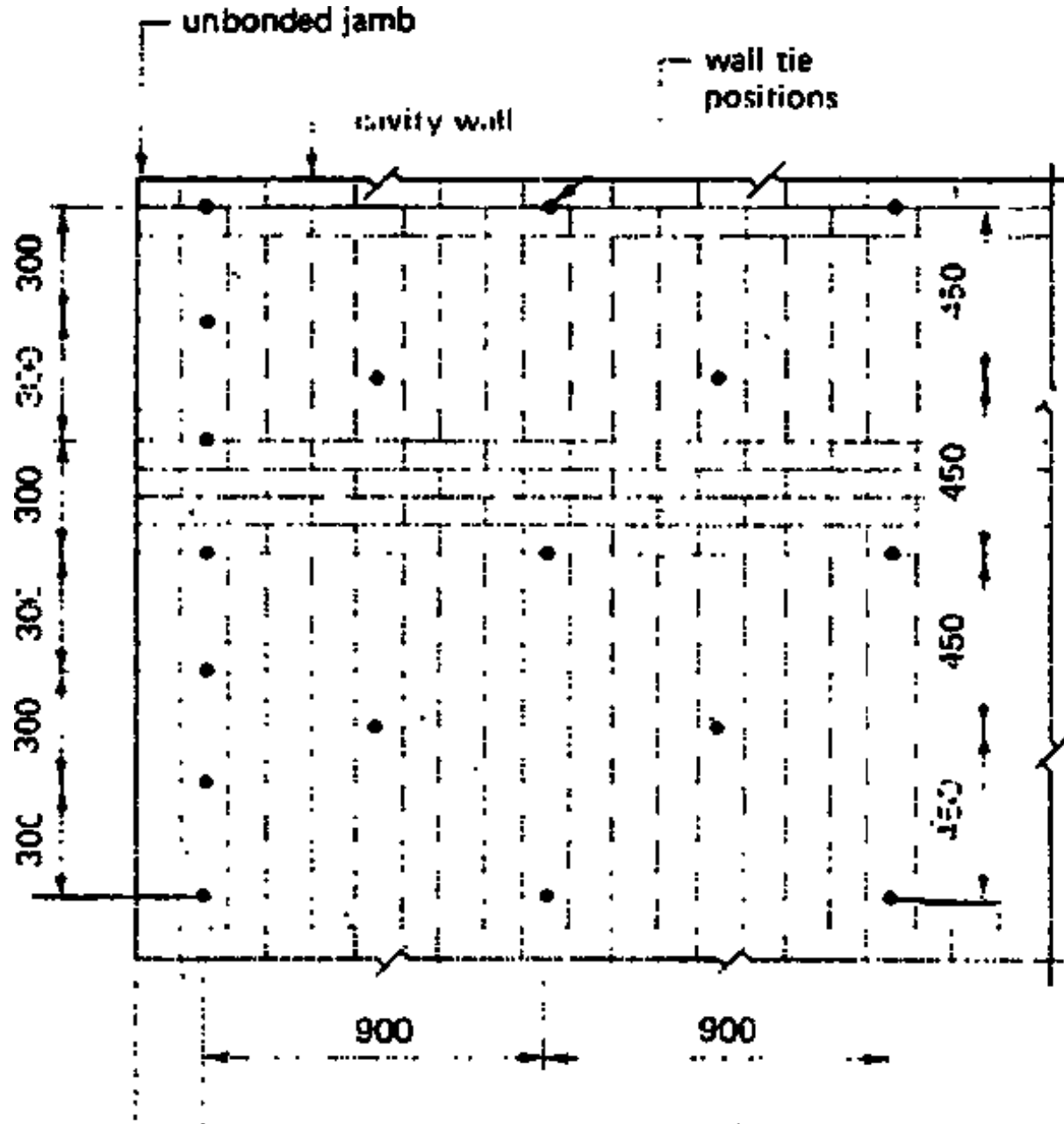

← → · as near to opening as is practicable
BUILDING REGULATIONS

Advantages of cavity wall constructions.

- a) Able to withstand a driving rain in all situations from penetrating to the inner wall surface.
- b) Gives good thermal insulation.
- c) No need for external rendering.
- d) Enables the use of cheaper and alternative materials for the inner construction.
- e) A nominal 255mm cavity wall has a higher sound insulation value than a standard one brick thick wall.

- Disadvantages of cavity wall constructions.

- a) Requires high standard of design and workmanship.
- b) The need to include a vertical D.P.C. to all openings.
- c) More expensive than a standard one brick thick wall.

- Parapets, whether solid or cavity constructions are exposed to the elements on three sides.

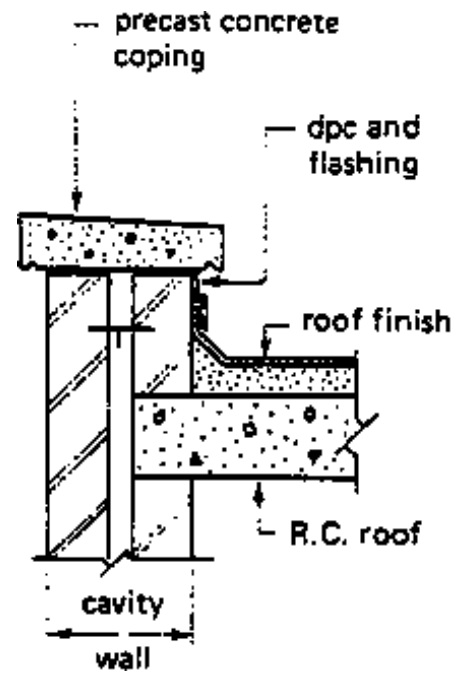

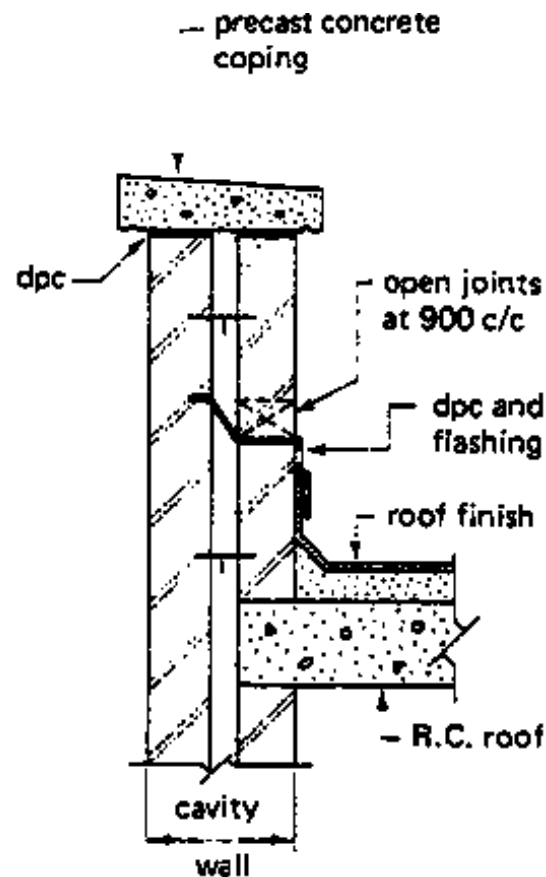

- Therefore an adequate barrier to moisture in form of d.p.c. must be provided.
- A parapet must not be less than 20 cm thick or not less than the thickness of the wall on which it is carried and its height must not exceed 6 x its thickness.

(Schedule 7, Rule 14, Build. Reg.)

- The presence of water in brick work can lead to

- **frost damage**
- **mortar failure**
- **efflorescence**

- The incorporation of adequate D.P.C. and overhanging throated copings is of importance in this form of structure.

- CROSS-WALLS

The term "cross-wall construction" is applied to buildings in which the walls at right angles to the principal axis are designed to carry the loads from the floors and roof, the lateral front and rear external walls being non-load-bearing.

Cross-wall construction being adopted for certain types of building is illustrated in its simplest form in the figure below.

- BOUNDARY WALLS

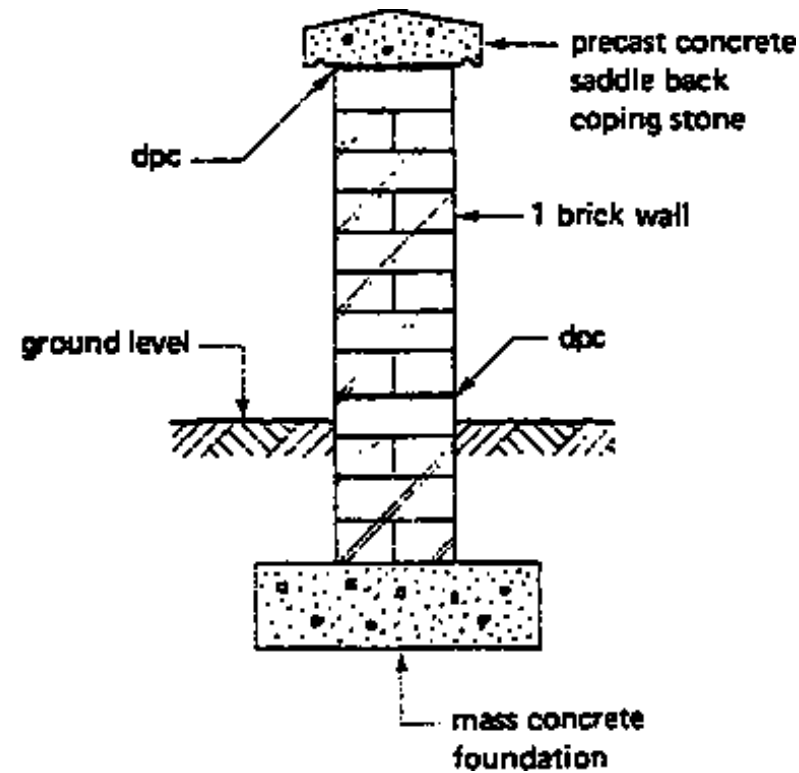

- are subjected to severe weather conditions and therefore should be designed and constructed correctly.

- as retaining walls = condition even more extrem, but the main design principle remains the same: Exclusion of water.

6.4 STONework

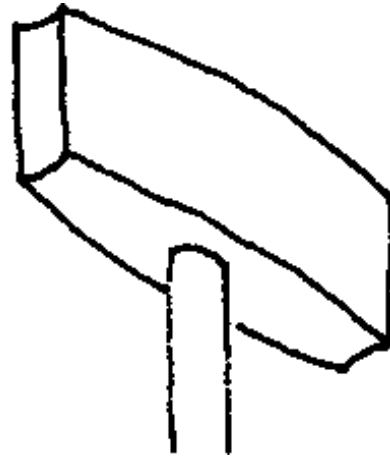

1. SPALL HAMMER



2. DUMMY

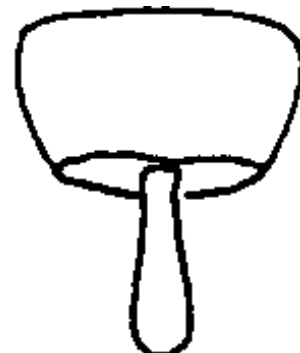

3. MALLET



4. DRAFTING CHISEL

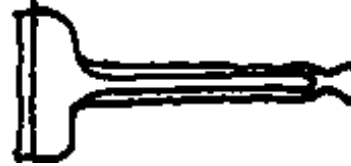

5. BROAD TOOL



6. DRAG



7. CLAW CHISEL



8. SOFT STONE CHISEL



9. JUMPER (o.5o-1.8om)

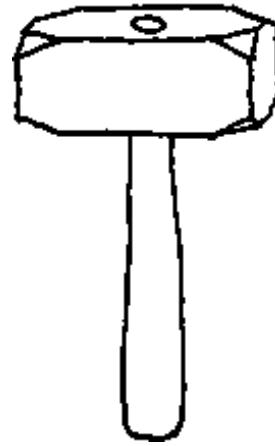

10. MASH HAMMER

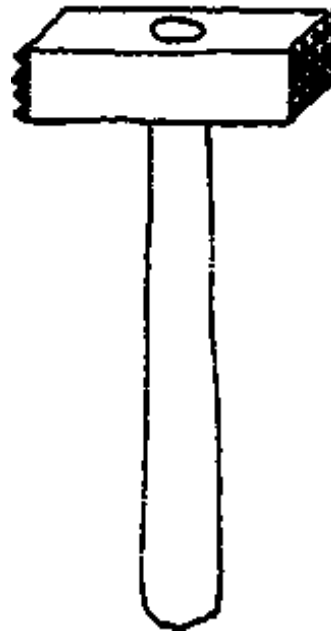

11. SCRABBLING HAM.

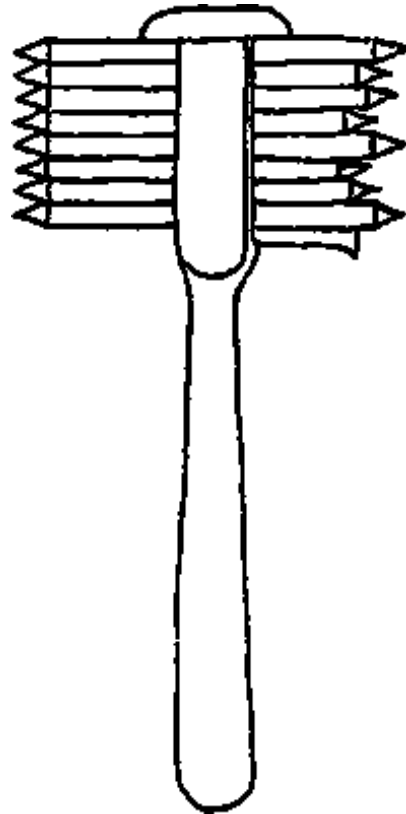

12. BUSH HAMMER

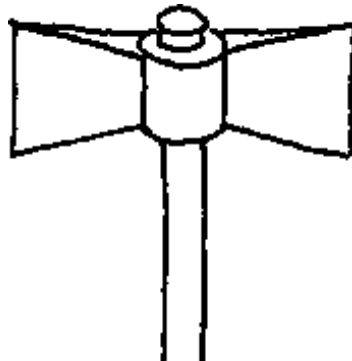



13. FLAT LUMP HAM.

SURFACE FINISHES & TOOLS

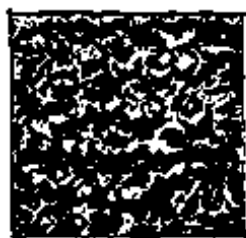

HAMMER DRESSED



BOASTED

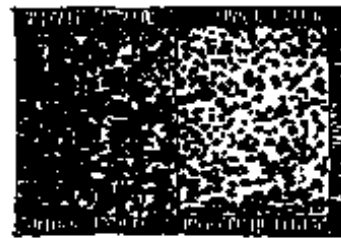

PUNCHED



PICKED

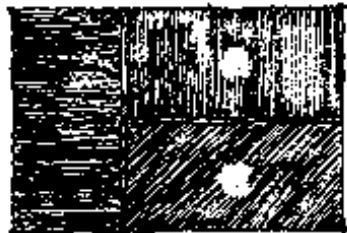

TOOLED

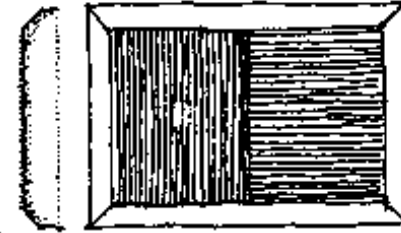

FURROWED



ROCK
FACED
BLOCK



VERMICULATED



RETICULATED

- | | |
|---|---------------|
| 1 | PITCHING TOOL |
| 2 | BOASTER |
| 3 | POINT |
| 4 | GOUGE |

6.4.1 BUILDING STONES

- Stones used in building can be divided into 3 classes as follows:

- (1): Igneous
- (2): Sedimentary
- (3): Metamorphic

- **Igneous stones**: Originate from volcanic action being formed by the crystallisation of molten rockmatter derived from deep in the earth's crust.

- **Sedimentary stones**: composed of material derived from the breakdown and erosion of existing rocks deposited in layers under the waters, which at that time covered much of the earth's surface.

- **granites** are typical of this class of stone: hard/durable and capable of a fine polished finish.

- **granites** are mainly composed of quartz, felspar and mica.

- **Sandstones and limestones** are typical examples of sedimentary stones.

• **Sandstones** are stratified sedimentary rocks, produced by the eroded and disintegrated rocks, like granite, being carried away and deposited by water in layers. The brown

and yellow tints in sandstones are due to the presence of oxids of iron.

• **Limestones** may be organically formed by the deposit of tiny shells and calcareous skeletons in the seas and rivers, or may be formed chemically by deposits of lime in ringed layers. Limestones vary considerably from heavy crystalline form to a triable material such as chalk.

- **Metamorphic stones**: have altered and may have been originally igneous or sedimentary rocks have been changed by geological processes such as

- pressure
- movement
- heat

and chemical reaction due to infiltration of fluids.

- Marbles and slates are typical examples.

• **Marbles** are metamorphic limestones, being changed by pressure.

Being capable of taking a high polish/are used mainly for decorative work.

• **Slate** is a metamorphic clay, having been subjected to great pressure and heat; being derived from a sedimentary layer it can be easily split into thin members.

- **Stones** are obtained from quarries by blasting and wedging the block away from the solid mass. They are partly worked in the quarry and then sent to store yards where they can be

- saw
- cut
- moulded
- dressed or/and
- polished.

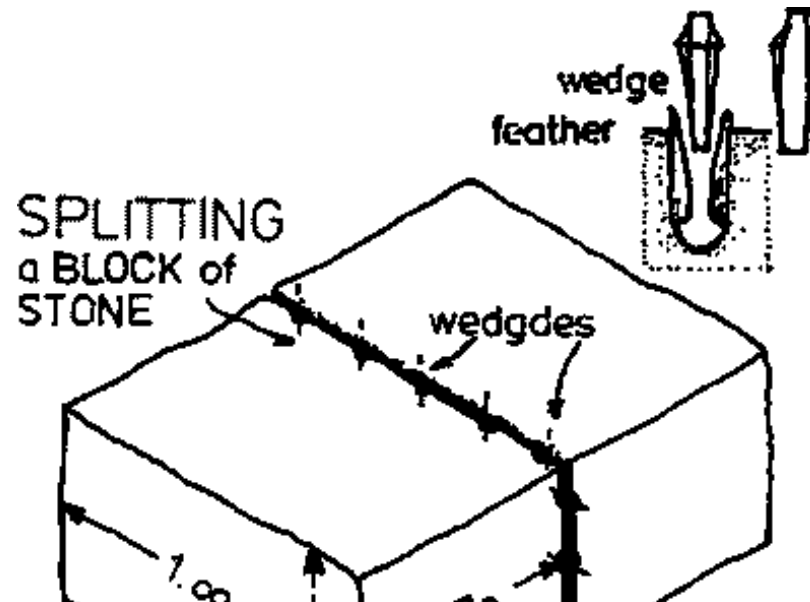
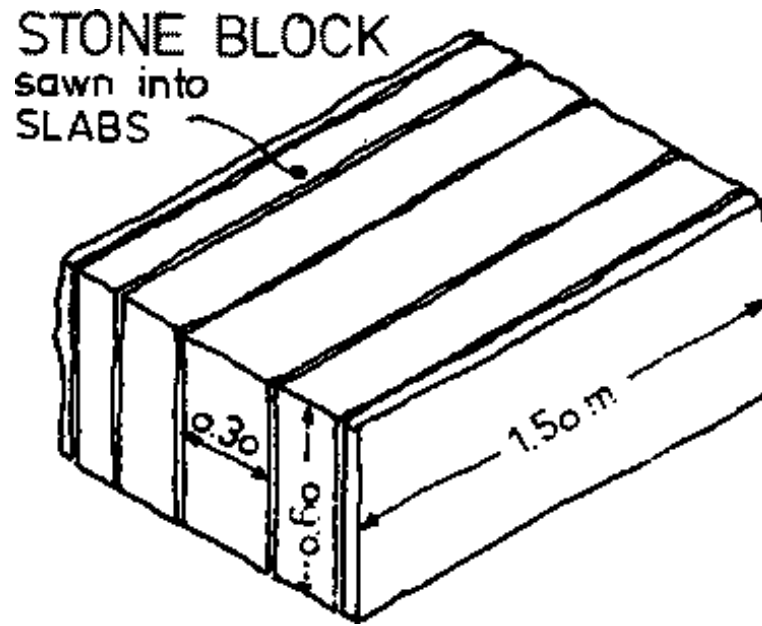

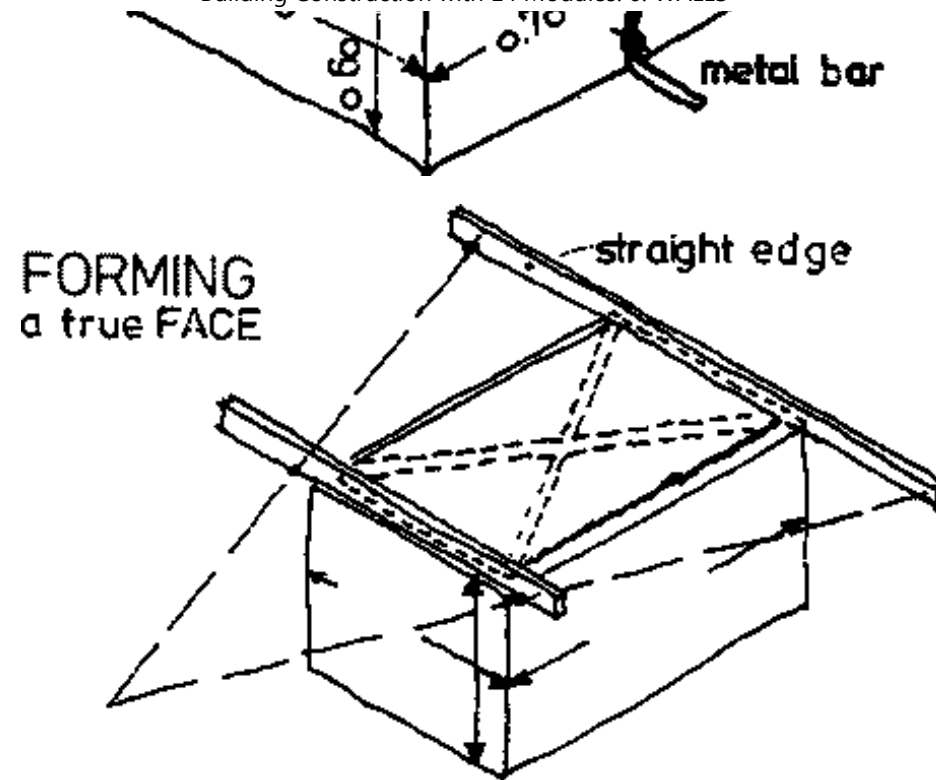

Today, natural stones are sometimes used for: -facing prestige buildings; -constructing boundary or similar walls.

- Reconstructed stones: are substitutes for natural stones. They are homogeneous throughout and therefore has the same texture and colour as the natural stones they are intended to substitute.



RECONSTRUCTED

- They can be worked in the same manner as natural stone or alternatively
 - they can be cast into shaped moulds.
- **Artificial stones:** consist partly of a facing material and partly of a structural concrete.

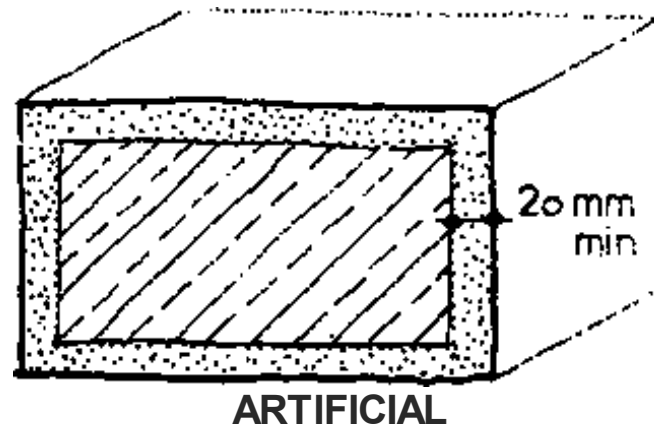

- The facing is a mixture of fine aggregate of natural stone and cement.
 - The facing should be cast as an integral part of the stone and have a minimum thickness of 20 mm.
 - They are cheaper than re constructed stones but have the disadvantage that if damaged the concrete core may be exposed.
- **DEFECTS IN STONE**

Vents. are small fissures or hollows in the stone which may cause it to deteriorate rapidly, especially if exposed. Stone with vents should not be used for building purposes.

- **Shakes or snailcreep:** are minute cracks in the stone containing calcite (a carbonate of lime) and forming hard veins which - in course of time - project beyond the general face on account of their greater durability. It is not advisable to use stone containing them on account of the difference in texture which results.
- **Sand-holes:** are cracks which appear in the stone and which are filled with sandy matter. **Clay-holes** are vents which contain matter of a clayey nature. Both are readily decomposed when subjected to the action of weather, and the stone should be rejected.
- **Mottle:** is a defect which causes the stone to have a spotted appearance due to the presence of small chalky patches. Such stone is unfit for building purpose.
- The presence of clay and oxide of iron is apt to cause disfigurement of the stone, producing brown-coloured bands which interfere with the uniformity in colour of the stone and diminish its durability.
- An inherent defect is the presence of shells fossils, cavities and flints. These are often not detected until the large blocks from the quarry are being converted into smaller units, the saw-arts revealing their presence. The affected portions must be removed and therefore waste results.

6.4.2 STONEMASONRY TERMINOLOGY

Arris: meeting edges of two worked, surfaces.

Ashlar: a square hewn stone; stonework consisting of blocks of stone finely squared and dressed to given dimensions and laid to courses of not less than 300 mm in height.

Bed joint: horizontal joint between two courses.

Bed joint: horizontal joint between two courses.

Bonders: through stones or stones penetrating 2/3 of the thickness of a wall.

Cramp: non-ferrous metal or slate tie across a joint.

Dowel: non-ferrous or slate peg morticed into adjacent joints.

Yoggle: recessed key filled with a suitable material, used between adjacent vertical joints.

Lacing: courses of different material to add strength.

Natural bed: plane of stratification in sedimentary stones.

Quarry seep: moisture contained in newly quarried stones.

Quoin: corner stone

Stool: flat seating on a weathered sill for jamb or mullion.

String course: distinctive course or band used mainly for decoration.

Weathering: sloping surface to part of the structure to help shed the rain.

6.4.3 STONEMWORK CLASSIFICATION

The various classes of stonework may be divided into:

- (1) Rubble Work and
- (2) Ashlar Work

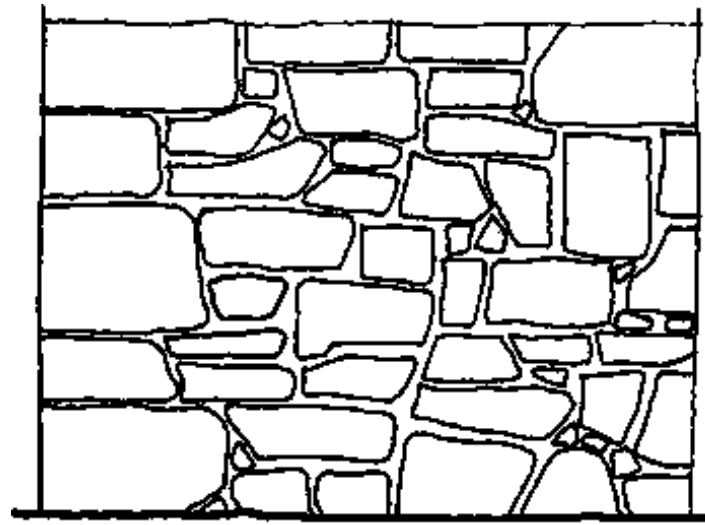

RANDOM RUBBLE uncoursed

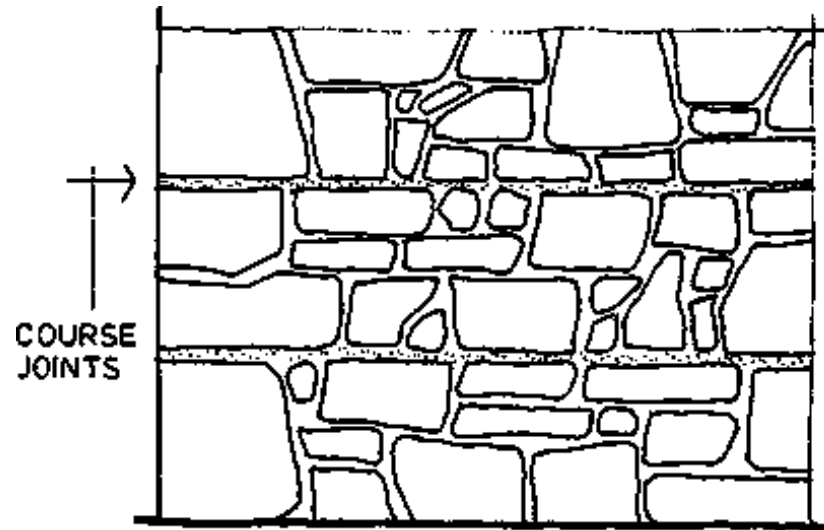

RANDOM RUBBLE brought to courses

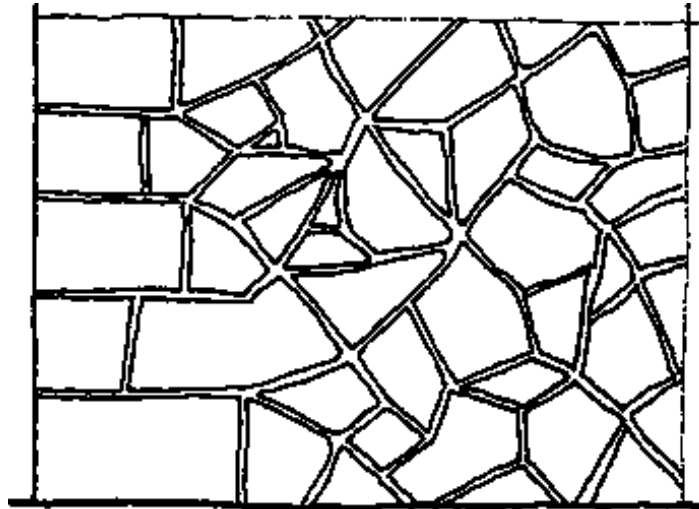

POLYGONAL RUBBLE

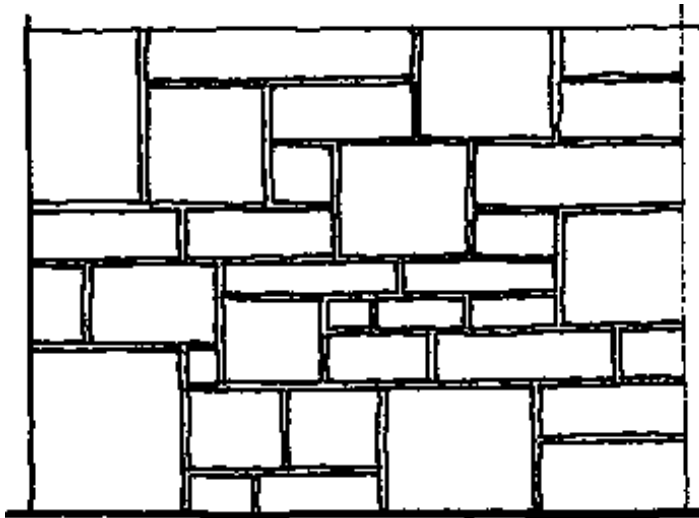

SQUARED RUBBLE uncoursed

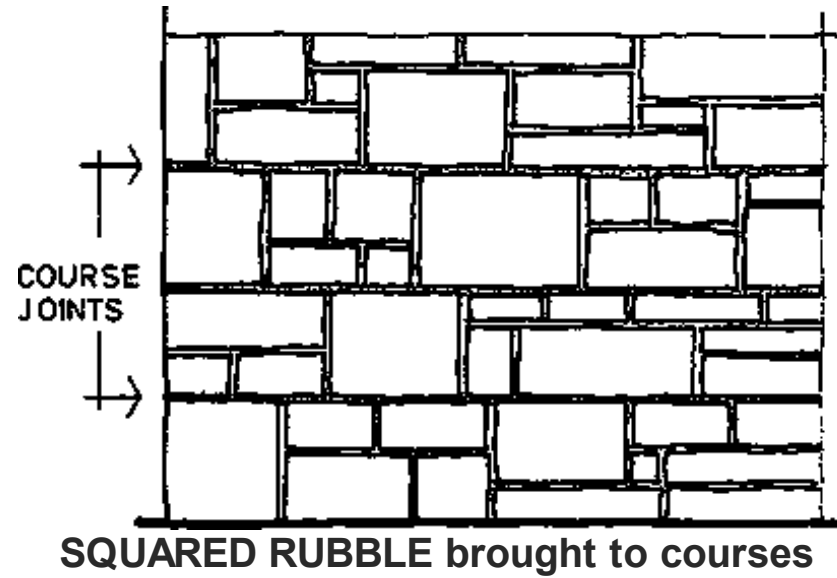
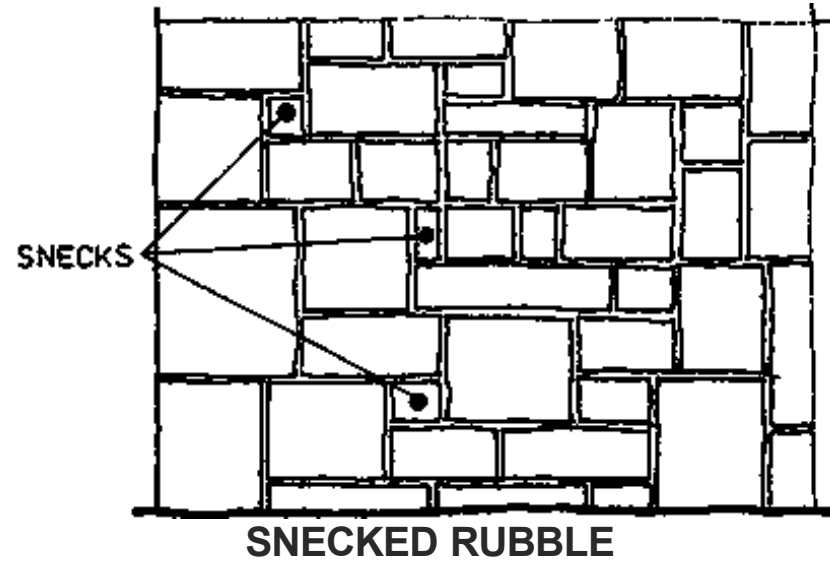

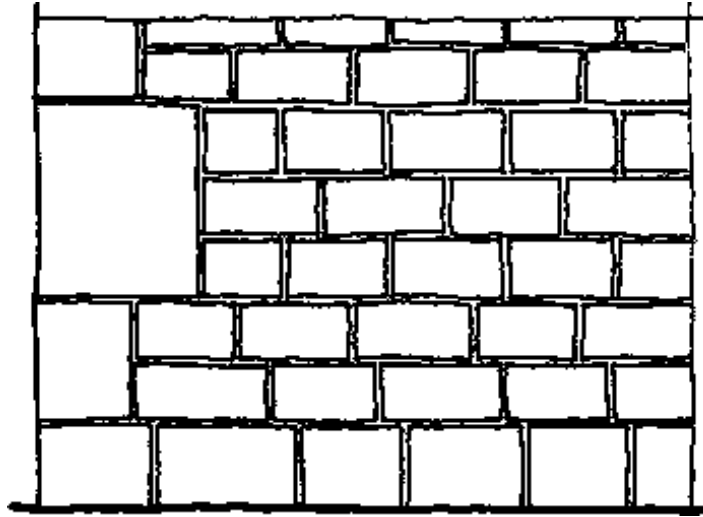

RUBBLE regular coursed

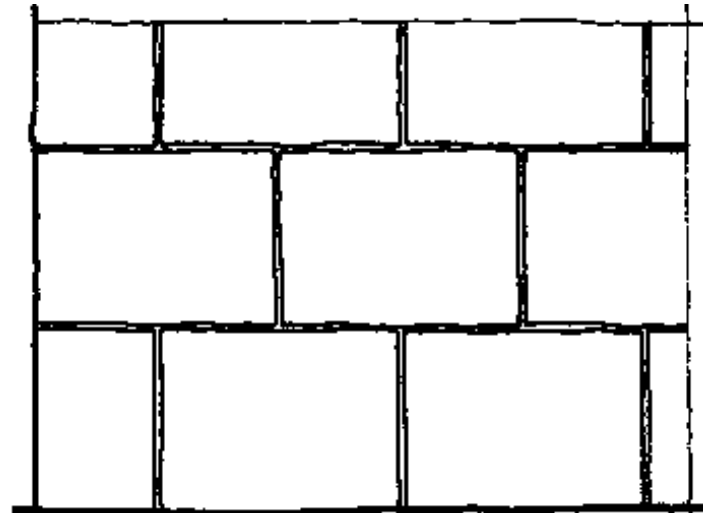

ASHLAR

6.4.4 RUBBLE WALLING

- These walls are made of stones which, are left rough or uneven thus presenting a natural appearance to the face of the wall.
- The stones are usually laid with a wide joint and are used in various forms.

They can be laid:

- dry o bedded in earth (in boundary walls)
 - bedded in Limemortar (i.e. outbuildings of farm houses)
 - bedded in cement or gauged mortar (in ashlar walls).
- Commonly the quins to corners, windows and door openings are dressed or ashlar stones.
- The face of any backing material to be treated with a suitable water-proofing coat (to prevent the passage of moisture).

Precautions in form of d.p.c. are necessary to comply with Part C - Building Regulations.

- Rubble work includes:

(a) Random Rubble

(1) uncoursed

(2) build to courses

(b) squared Rubble

- (1) uncoursed
- (2) build to courses
- (3) regular coursed

(c) Miscellaneous

- (1) polygonal walling
- (2) flint walling

KNOW HOW



SECTION

CORRECT



TOP VIEW



SECTION

WRONG



TOP VIEW
PROPPER BONDING

WRONG

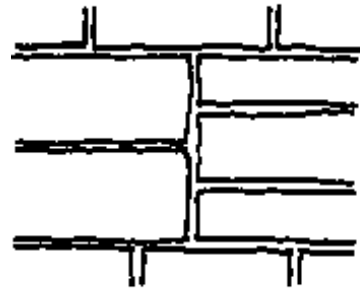

VERTICAL JOINTS
(CROSS or HEAD-
JOINTS) THROUGH
DIFF. COURSES

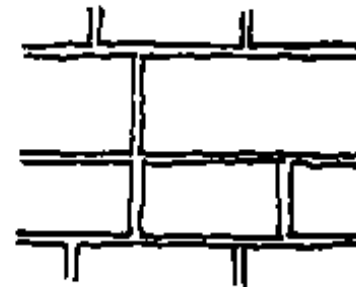

THE CROSSING
OF JOINTS

TO BE AVOIDED

JOINTS

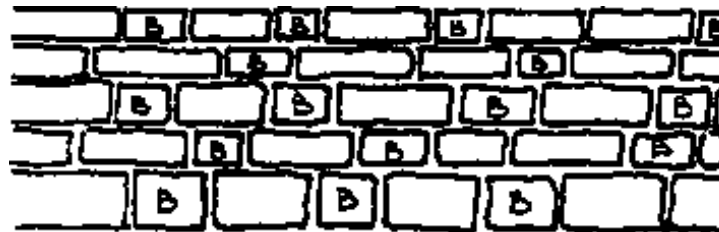

N.B. AFTER (at least) TWO STRETCHERS ONE BONDER has to follow !





N.B. THE DEPTH of a BONDER to be approx. 1 ½ the THICKNESS of the COURSE (min. 30 cm)

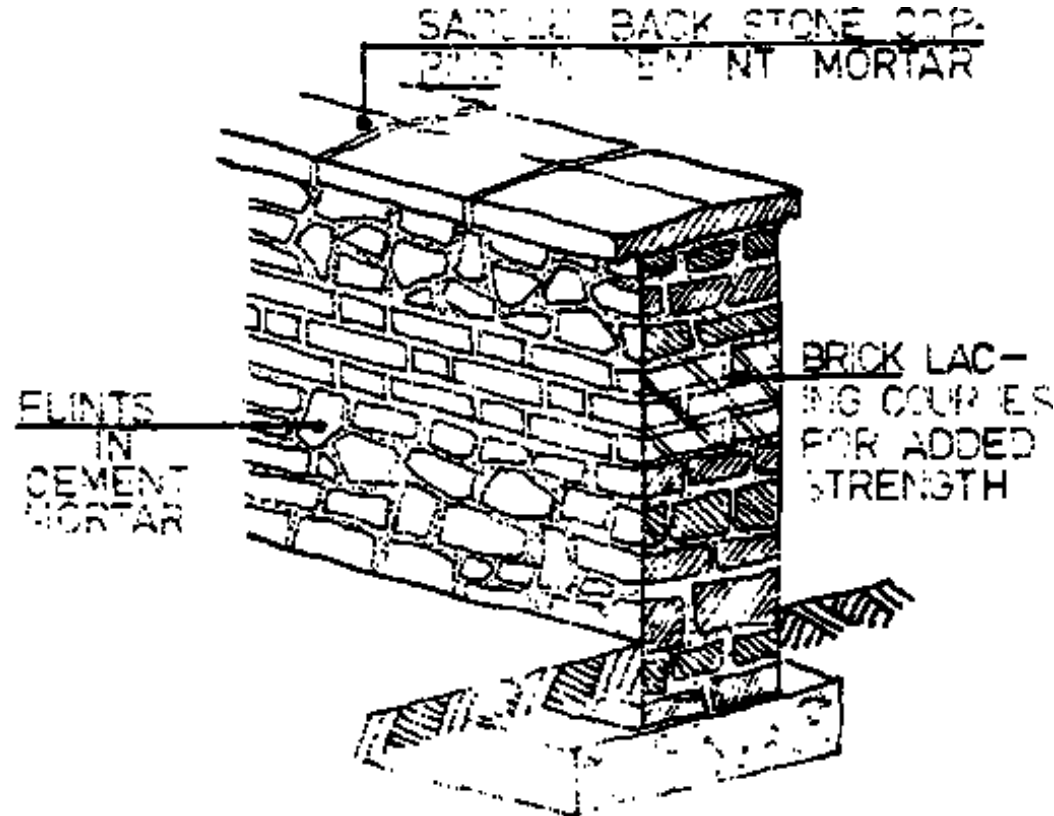

USE OF FLINT STONES

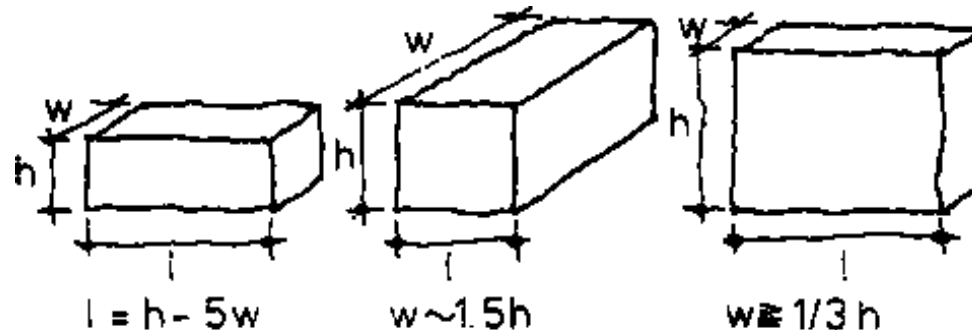

w ~ h

w ≈ 30 cm

w ≈ 11.5 cm

l ~ h

STRETCHER BONDER TILE

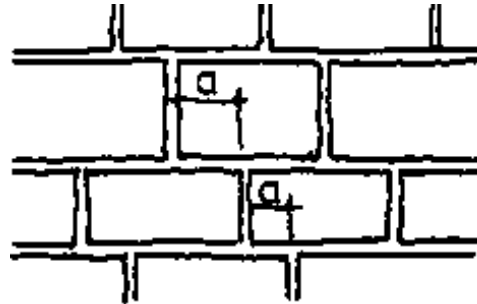

OVERLAPPING OF CROSS JOINTS

IN COURSED RUBBLE WALLS a = 10 cm

IN ASHLAR WALLS a = 15 cm

CORRECT

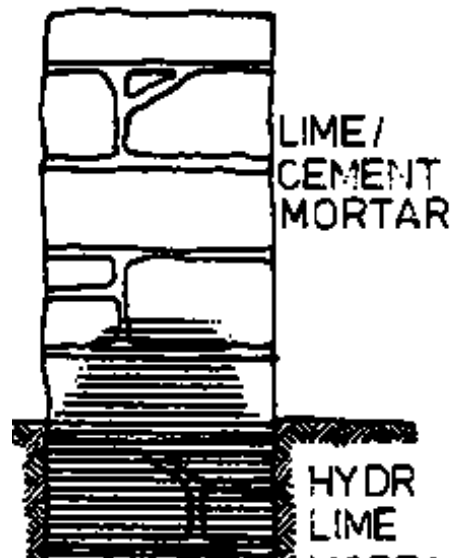

WRONG

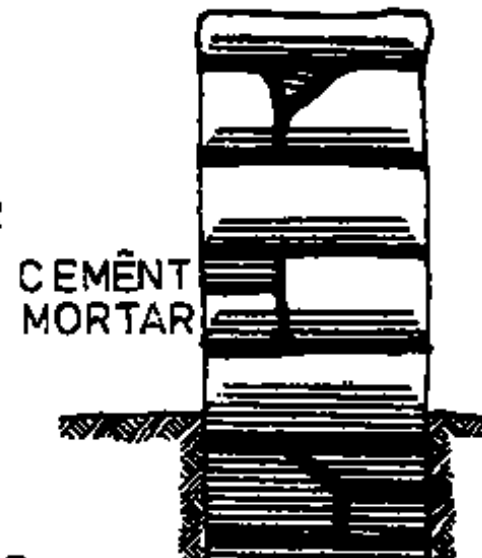

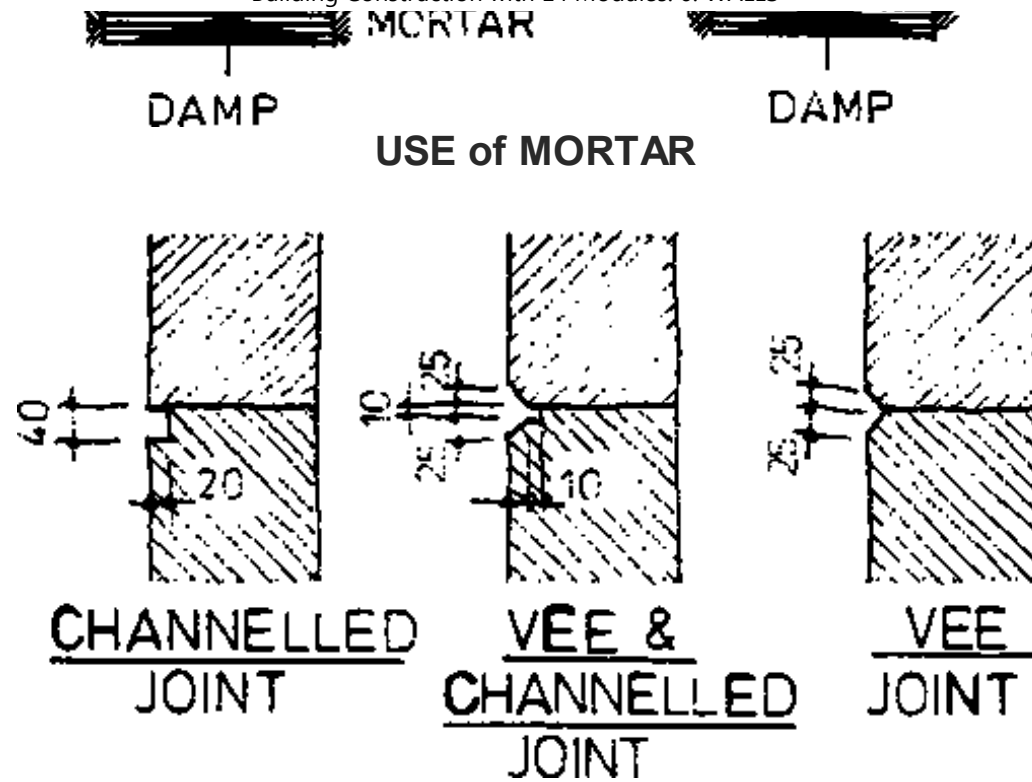

6.4.5 ASHLAR WALLING

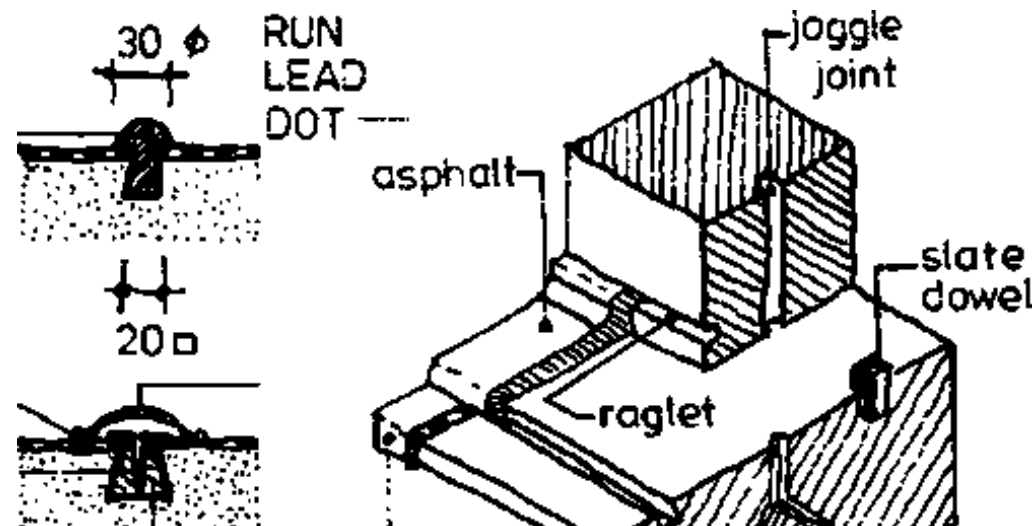

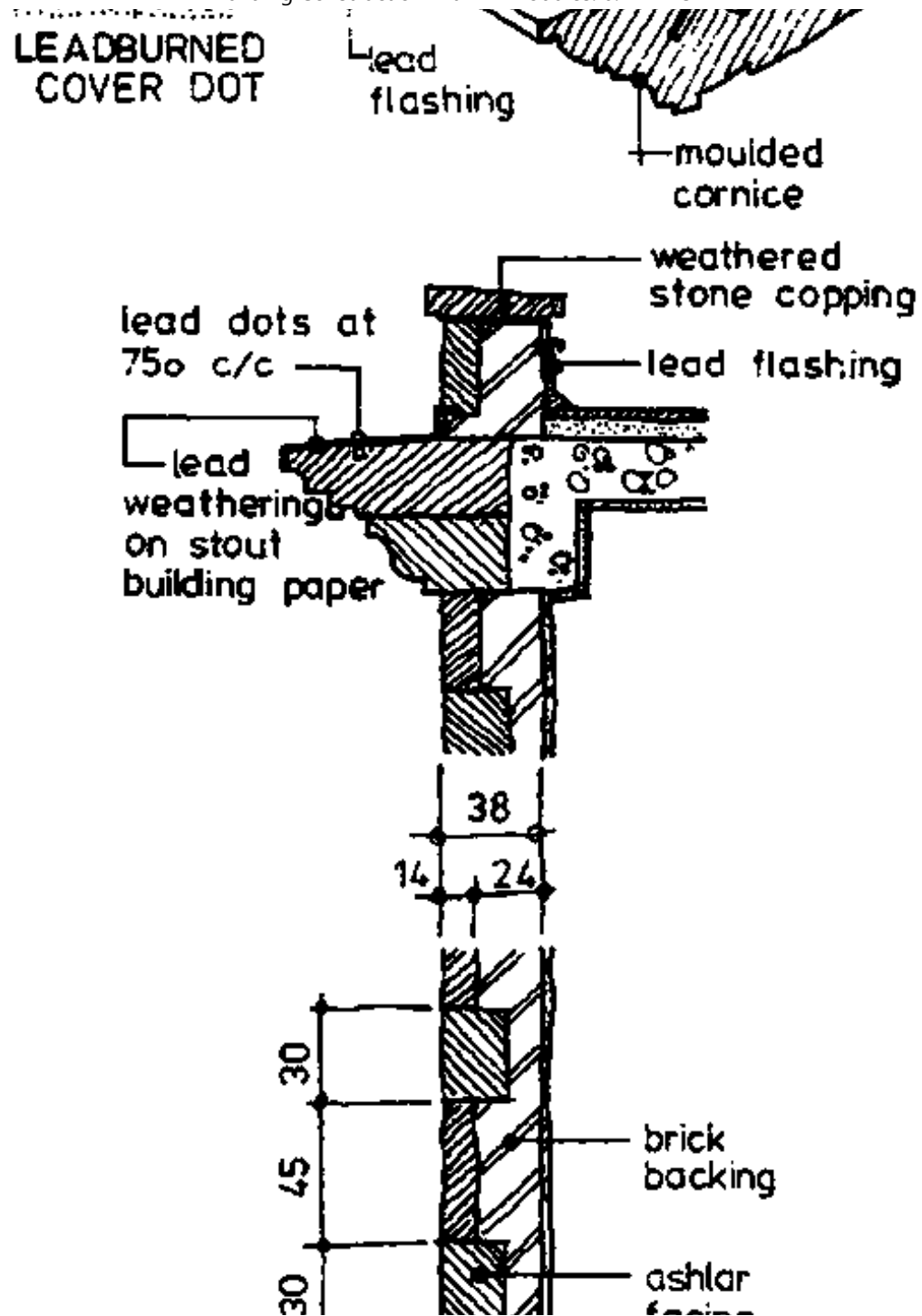

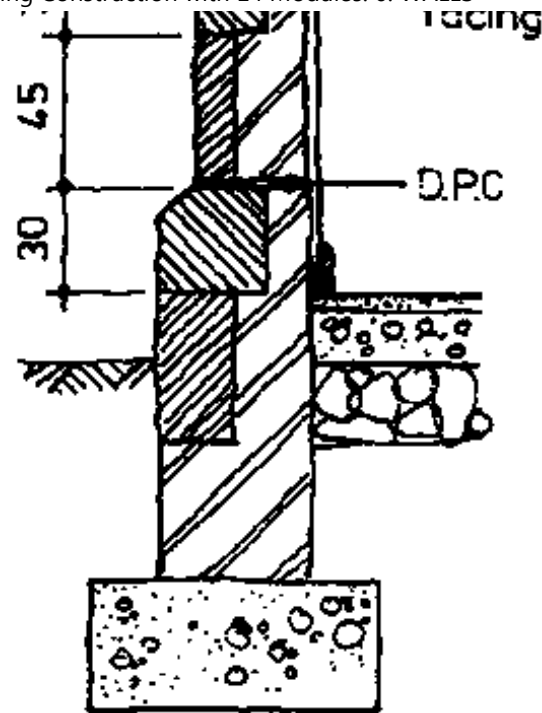

- This form of stone walling is composed of

- carefully worked stones
- regular coursed
- bonded or set with thin rusticated joints

and is used for the majority of high-class facingwork in stone.

- The quoins are sometimes given a surface treatment to emphasize the opening or corner of the building.

- Most of the ashlar work is carried out in Limestone (10- 30 cm thick) and set in mason's putty which is a mixture of stonedust/lime putty/ Portland cement.

Typical ratio: 7/5/2.

6.4.5.1 Rules for ashlar work

1. Back faces of ashlar stones should be painted with a bituminous or similar water proofing paint.
2. External stone work must not be taken through the thick ness of the wall since this could create a passage for moisture.
3. Ledges of corcices and external projections should be covered with LEAD, COPPER, or ASPHALT to prevent damage by rain or birds.
4. Moulded, cornices should be raked back at 45° to counteract the cantilever action.
5. Face of stones should be given a protective coat of slurry during construction, the slurry being washed off immediately prior to completion.

JOINTS & CONNECTIONS

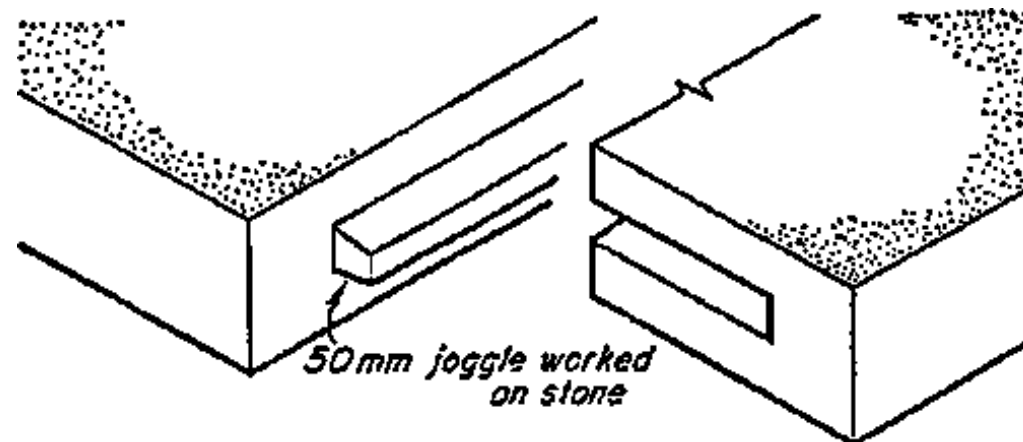

A Joggled joint

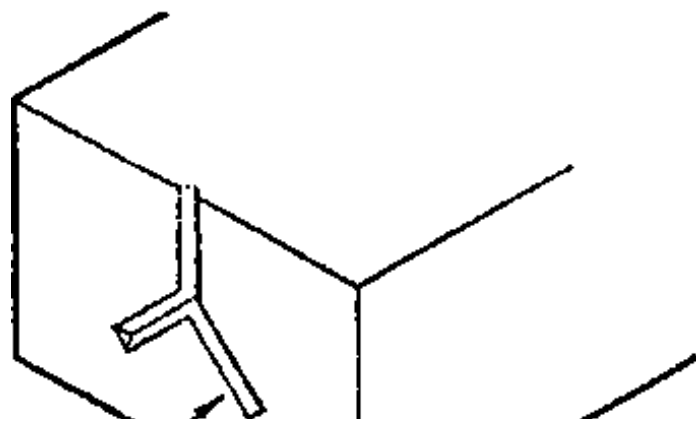
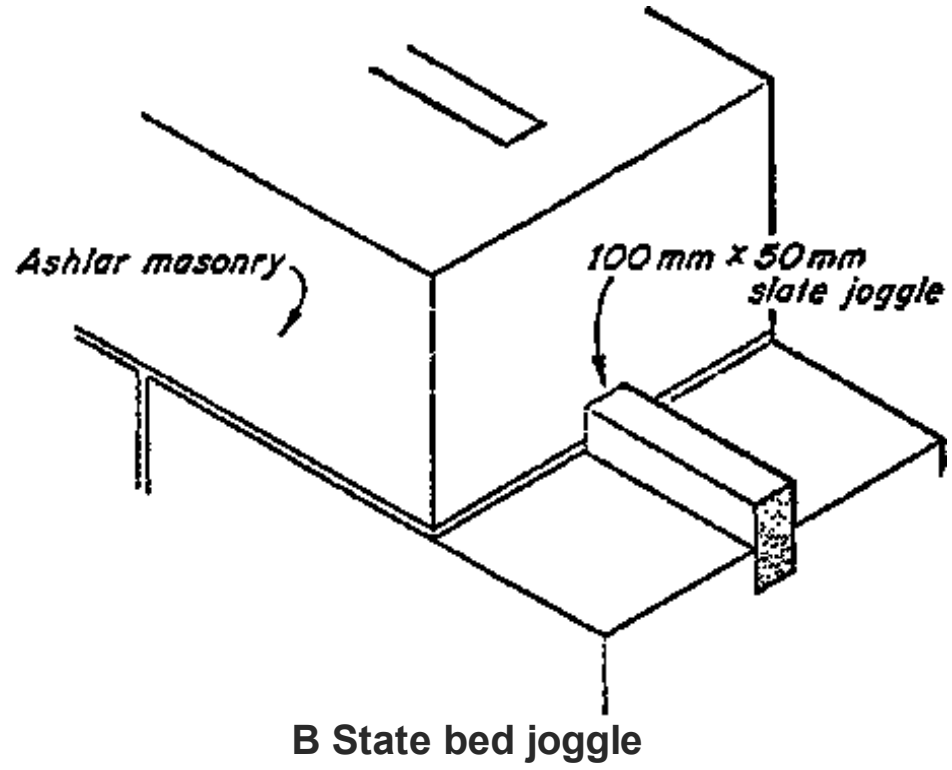

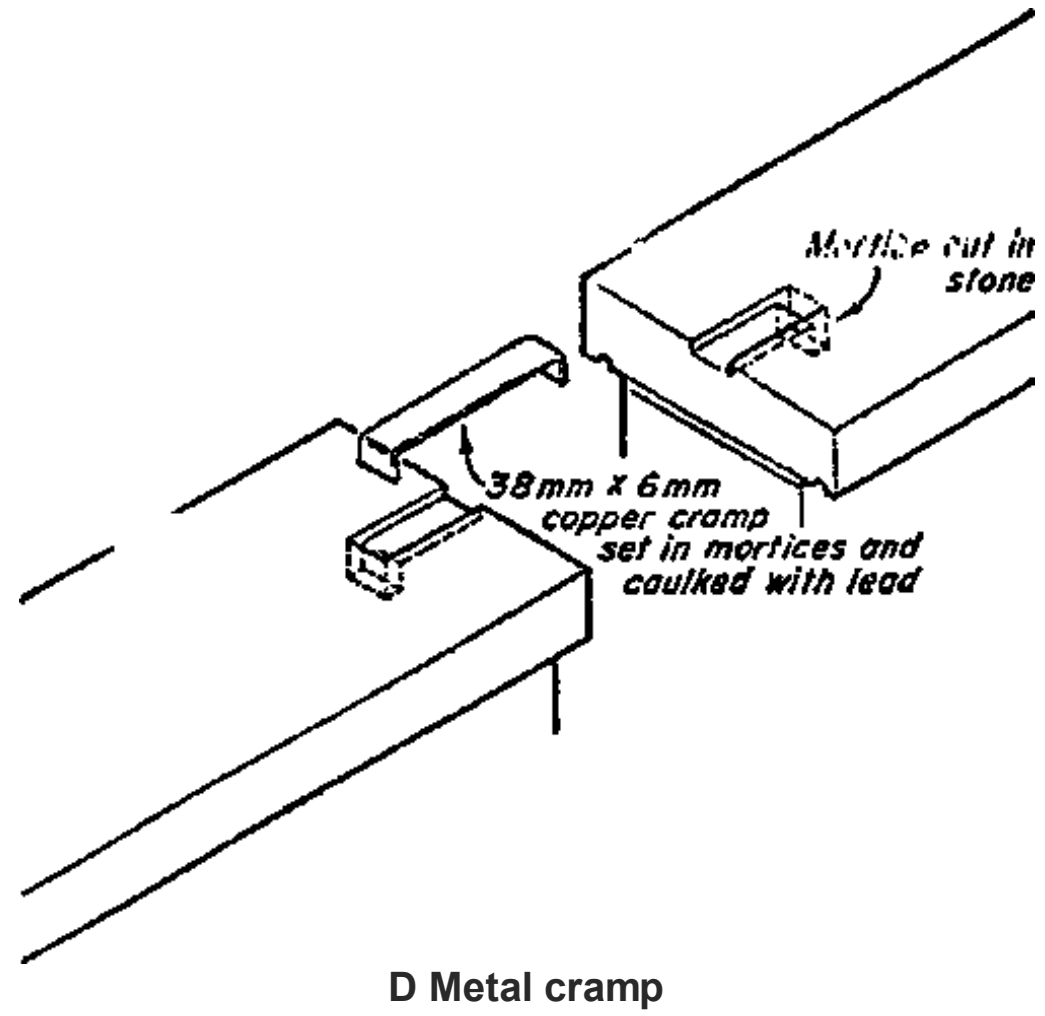
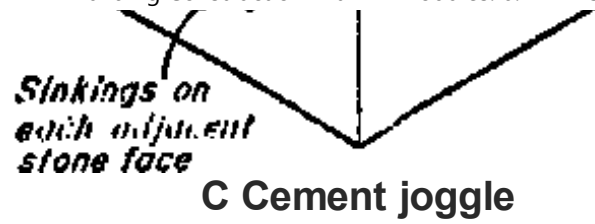

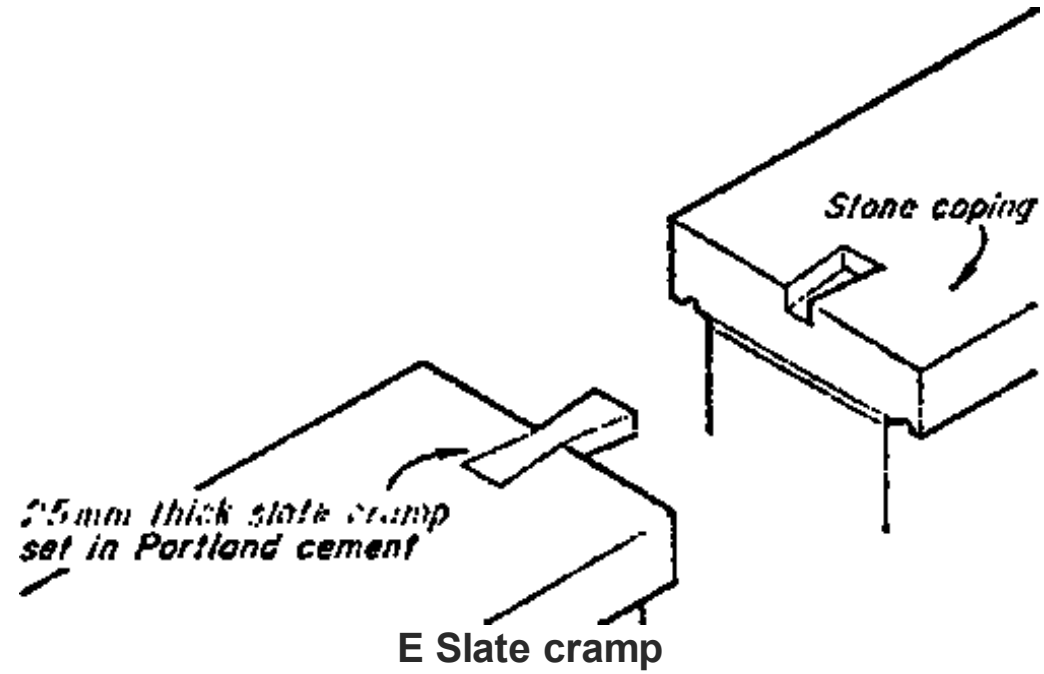

6.5 BRICK WORK

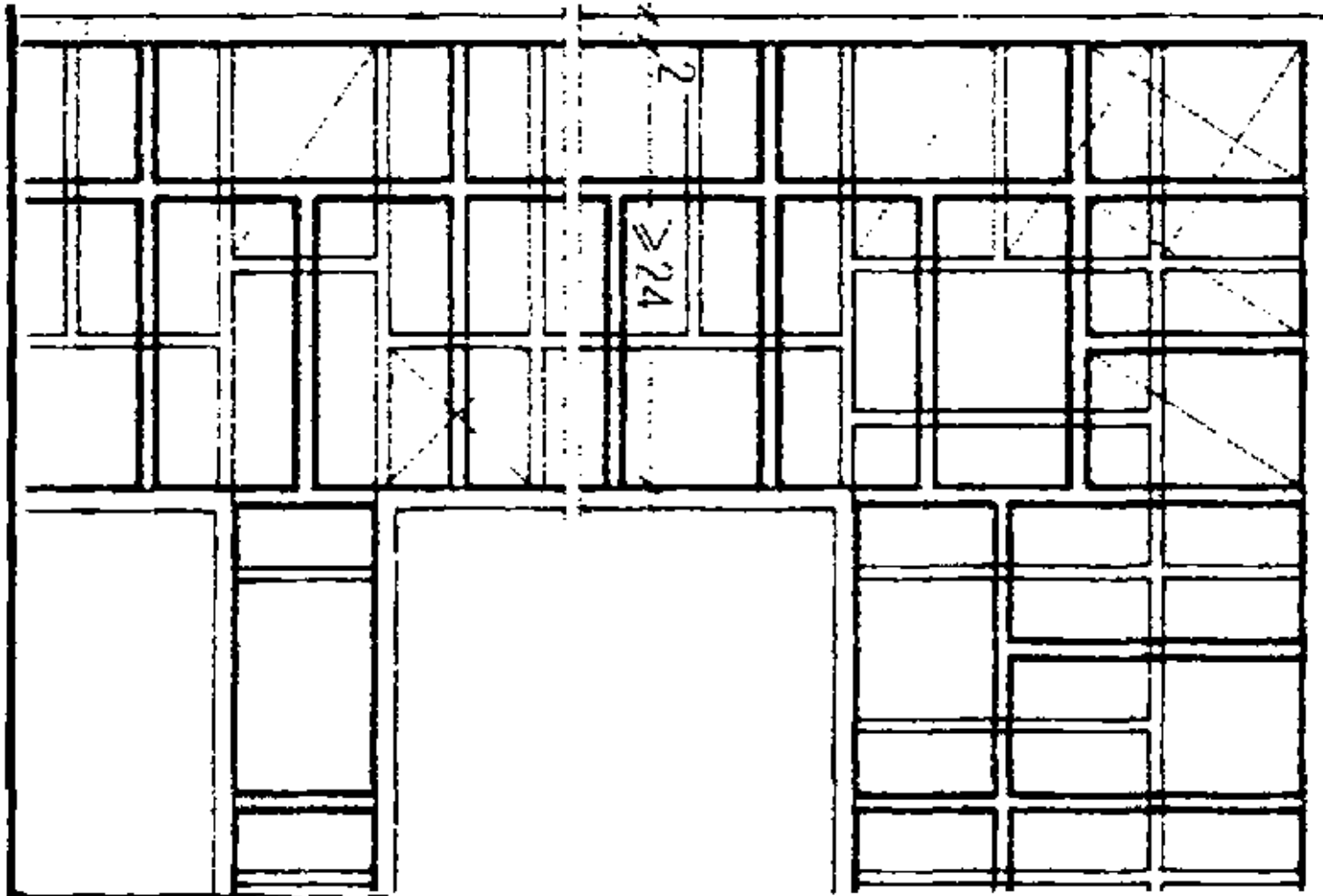

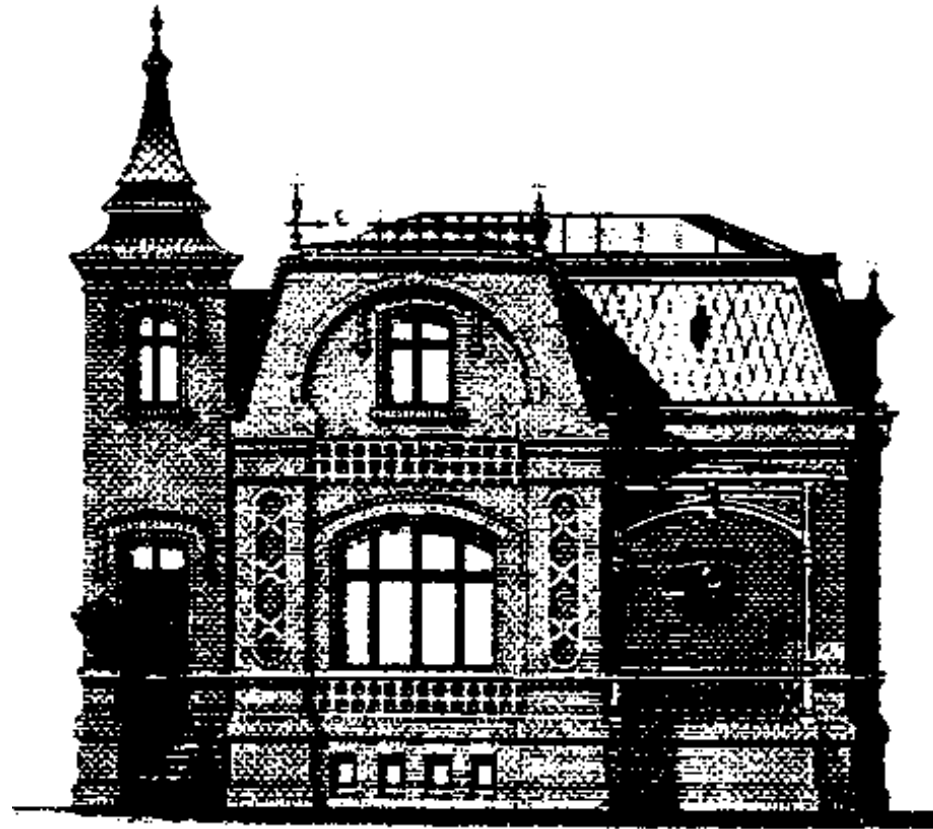

BRICKWORK: 19th CENTURY

- **In BS 3921, Part 2**, a brick is defined as a walling unit not exceeding

337,5 mm in length

225,5 mm in width

112,5 mm in height

This particular standard deals with bricks made of fired brick-earth, clay or shall; other standards deal with those made of calcium silicate or concrete.

Bricks are known by their format size (= actual size + 10 mm joint allowance to three faces).

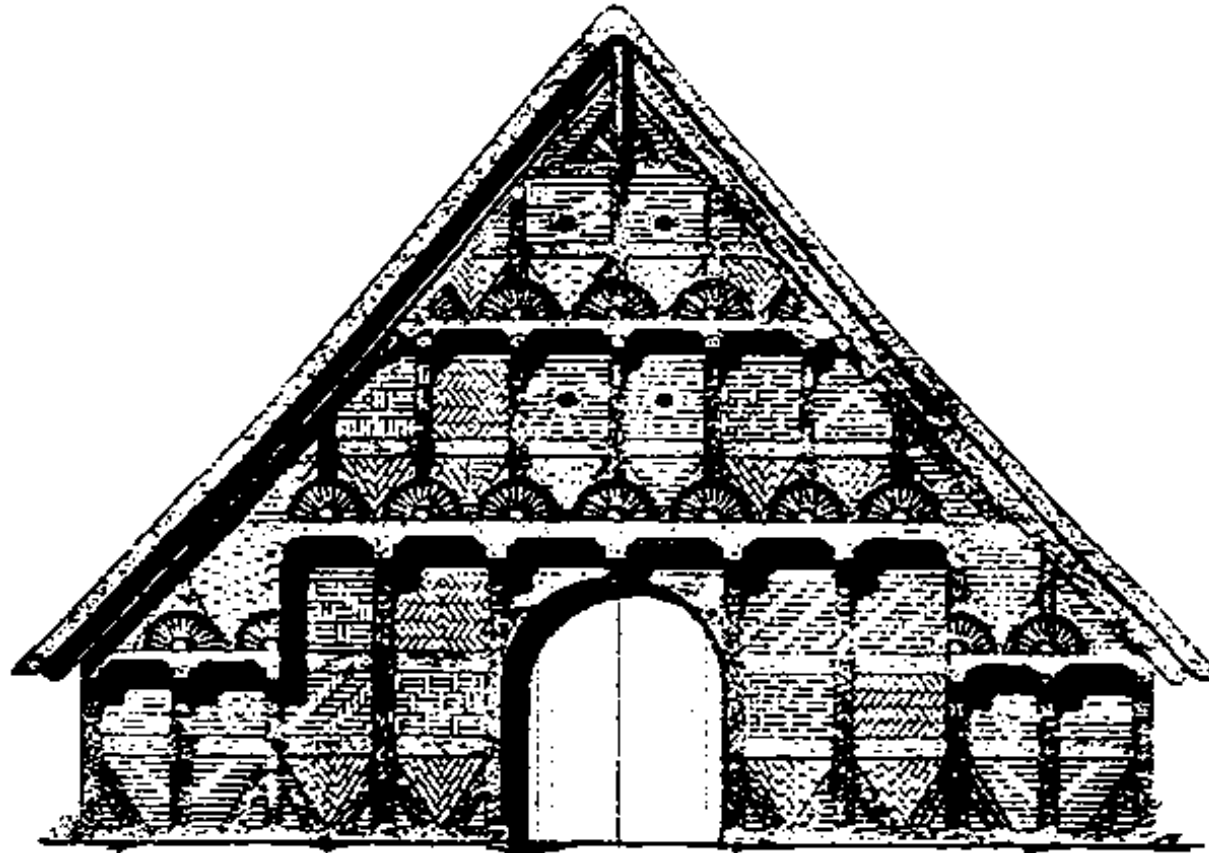

BRICKWORK: 17th CENTURY

- Brick work is used primarily in the construction of walls by bedding and jointing of bricks into established bounding arrangements.



MODERN BRICKWORK: arch. RUDOLPH

The term also covers the building in of

- hollow blocks and other
- light weight blocks.

6.5.1 BRICKWORK TERMINOLOGY

4 STANDARD BRICKS

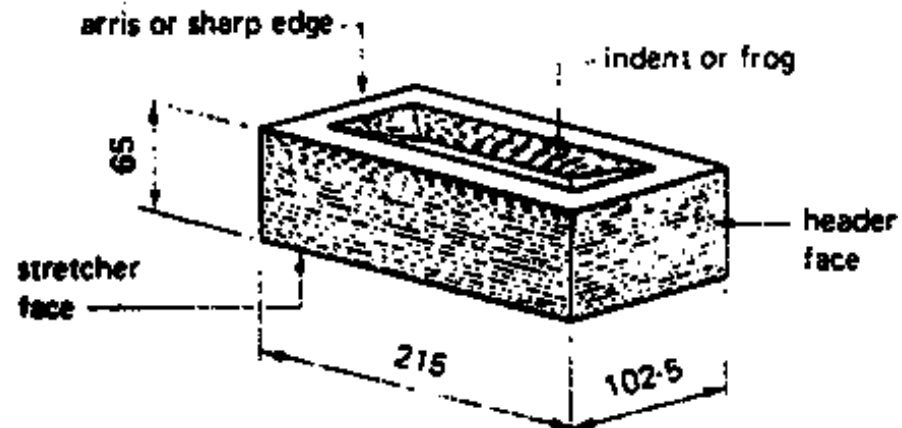
1 STANDARD BRICKS:**a) BRITISH STANDARD:****215x102.5x65 mm****b) GERMAN STANDARD:****240x115x71 mm****1 STANDARD BRICKS**

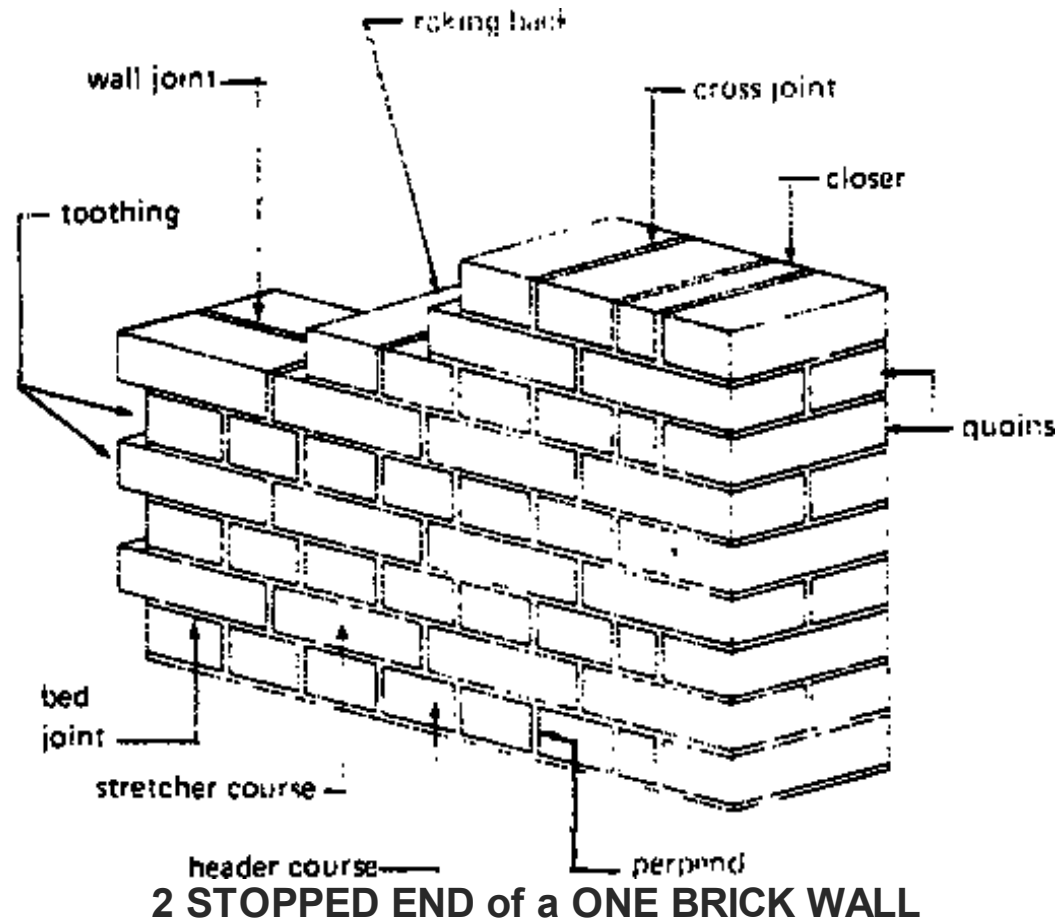



3 HALF BAT

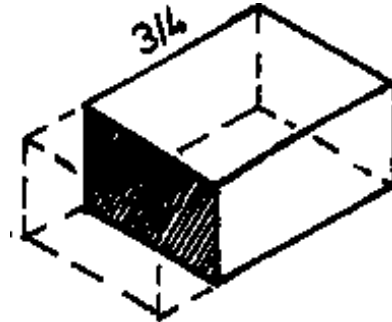

4 THREE QUARTER BAT

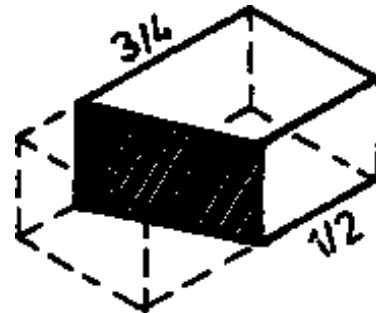

5 BEVELLED BAT-large

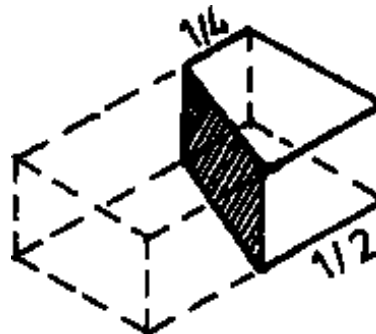

6 BEVELLED BAT-small

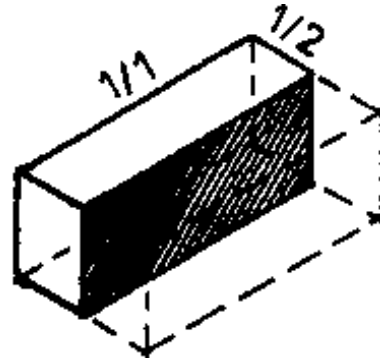

7 QUEEN CLOSER-HALF

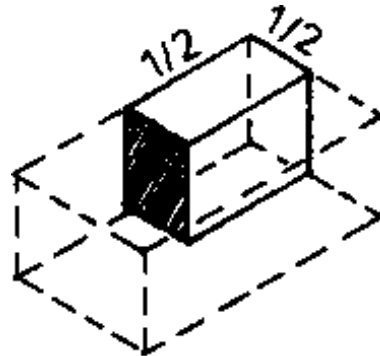

8 QUEEN CLOSER-QUART.

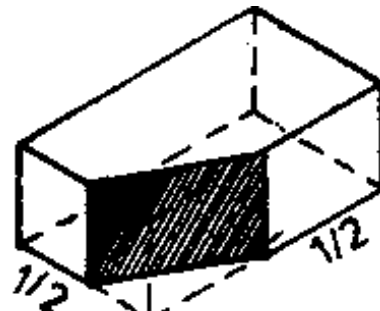

9 KING CLOSER

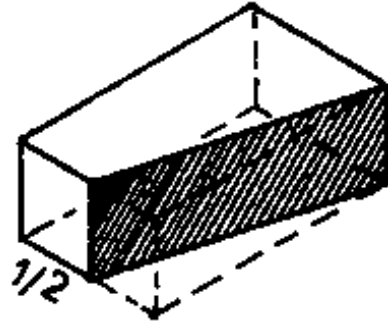

10 BEVELLED CLOSER

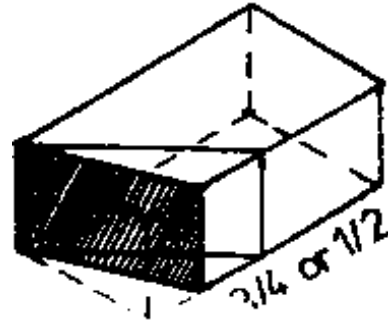

11 MITRED CLOSERS

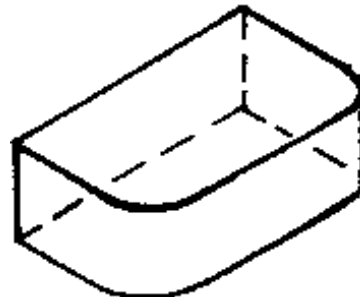

12 DOUBLE BULLNOSE

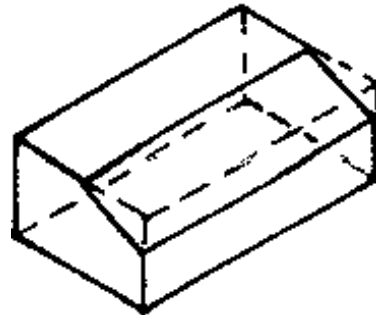

13 SPLAY-STRETCHER

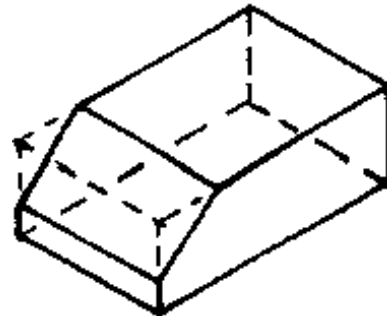

14 SPLAY-HEADER

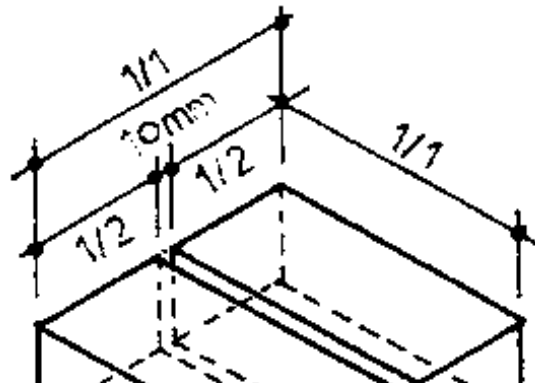

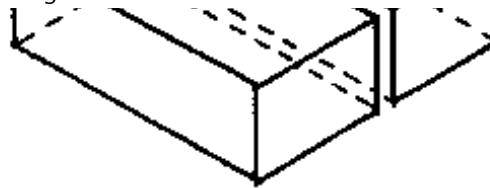

2 HEADERS + 1 JOINT (10 mm) = STRETCHER

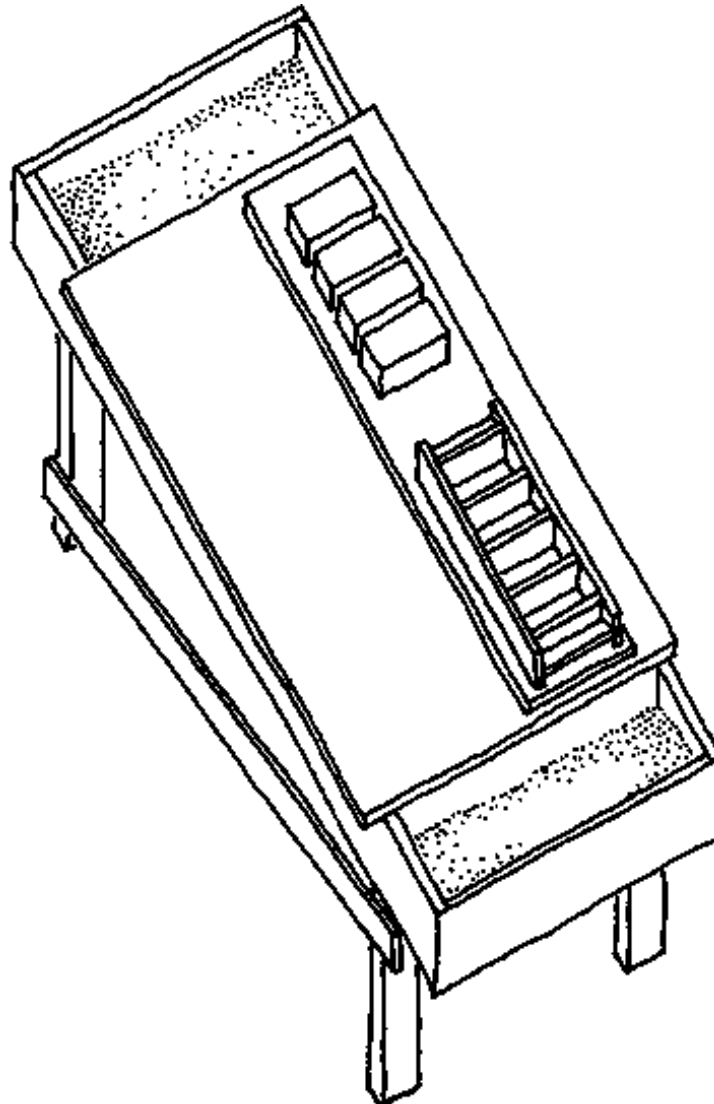

MOULDING TABLE

- Different clays have different characteristics (such as moisture content, chemical composition) therefore: distinct variations of the broad manufacturing processes have been developed.

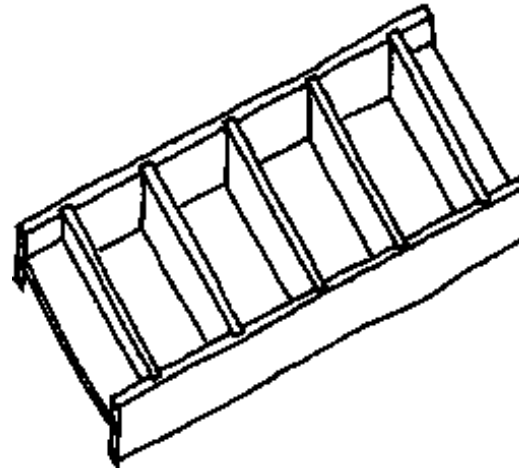

HAND-MOULD (4 bricks)

6.5.2 MANUFACTURE OF CLAY BRICKS

- The basic raw material is:

- clay
- shale or
- brickearth

- The raw material to be

- dug
- prepared (by weathering or grinding)

- mixed with water (to the right plastic condition)
- formed (into the required brickshape)
- dried (under a shed)
- fired in a Kiln.

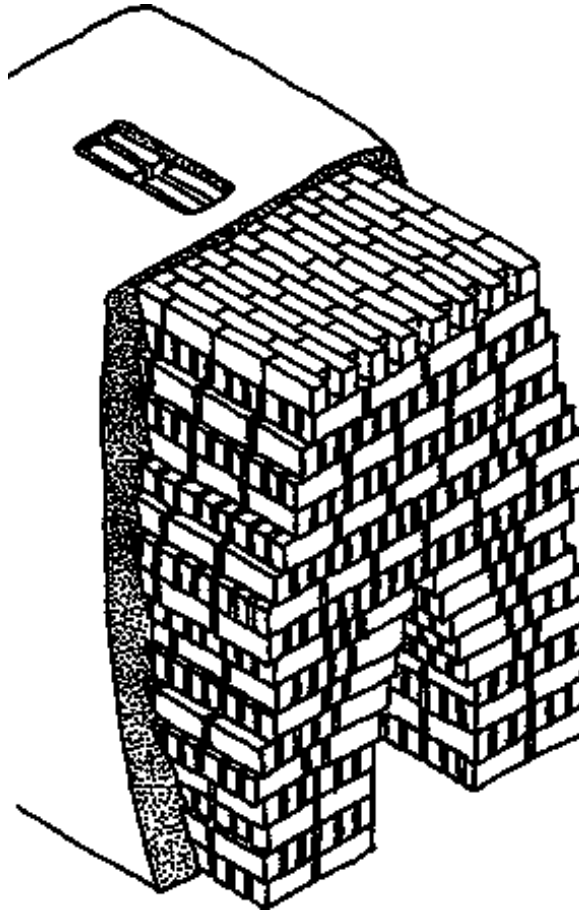

FIELD KILN

6.5.2.1 Pressed Bricks

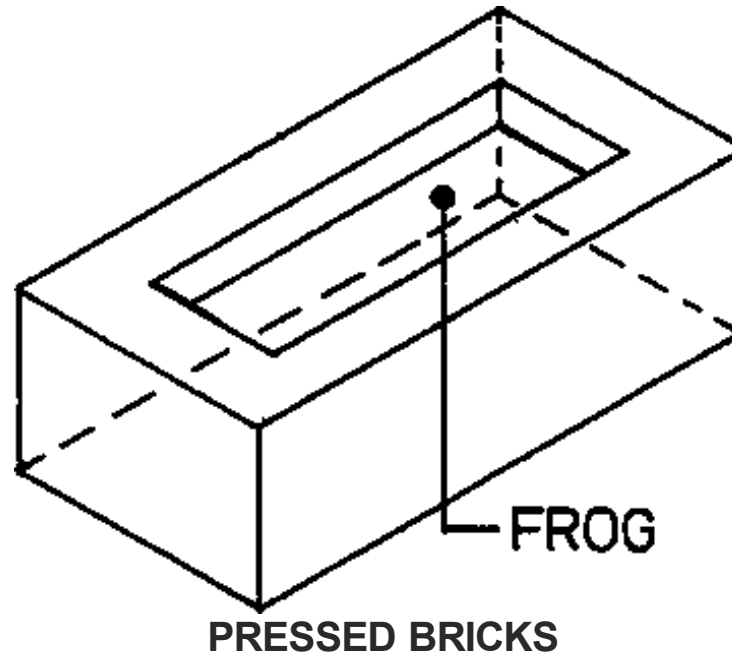

- This type of brick is the most common used.
- There are 2 processes of pressed brick manufacture:
 - (1) semi dry = clays which have a low natural plasticity. The clay is ground, screened and pressed directly into the moulds.
 - (2) stiff plastic = The clays require more grinding and the clayclust needs tempering (mixing with water) before being pressed into the mould.

Most pressed bricks contain frogs which are sometimes pressed on both bed faces. In general pressed bricks are more accurate in shape than other clay bricks with sharp arrises and plain faces.

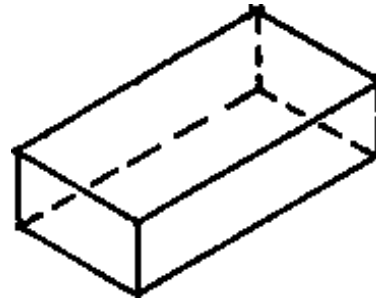

WIRE CUT BRICKS

6.5.2.2 Wire cut bricks

- The clay, which is usually fairly soft and of fine texture is extended as a continuous ribbon and is cut into brick units by tightly stretched wires spaced, at the height or depth for the required brick.
- Allowance is made during the extension and cutting for the shrinkage that will occur during firing.
- Wire cut bricks do not have frogs and on many the wire cutting marks can be clearly seen.

6.5.2.3 Efflorescence

- = White stain appearing on the face of brickwork caused by deposits of soluble salts formed on or near the surface of the brickwork as a result of evaporation of the water in which they have been dissolved,
- it is usually harmless and disappears within a short period of time,

- dry brushing or with clean water may be used to remove the salt deposit but the use of acids should be left to the expert.

6.5.3 BRICK CLASSIFICATION

- No standard system for the classification of bricks has yet been devised. Bricks are generally known by the terms given in B.S. 3921 or by the description given by the brick manufacturer (or a combination of the two).

BS 392, Part 2

This standard gives 3 headings:

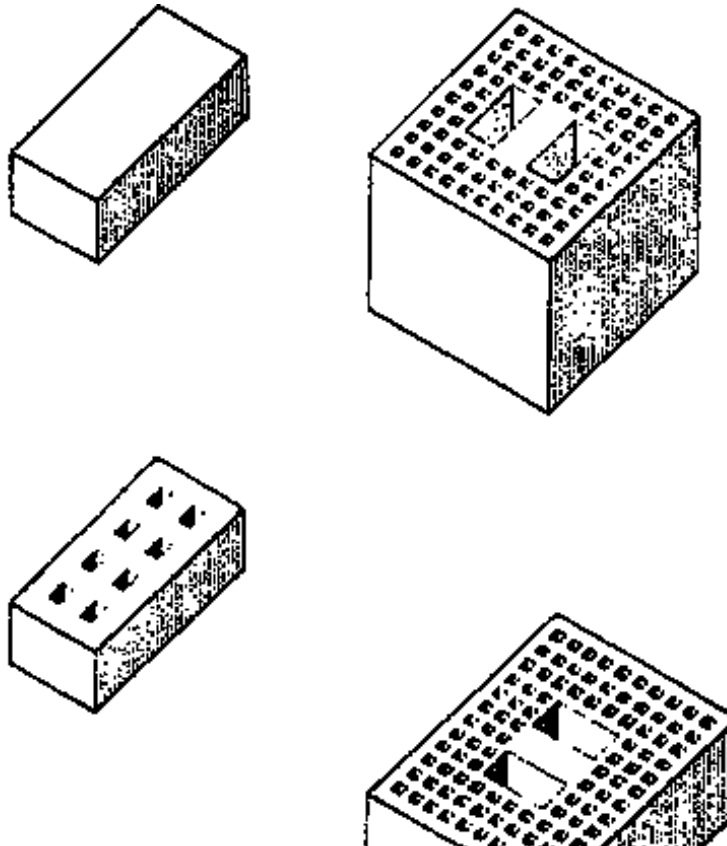

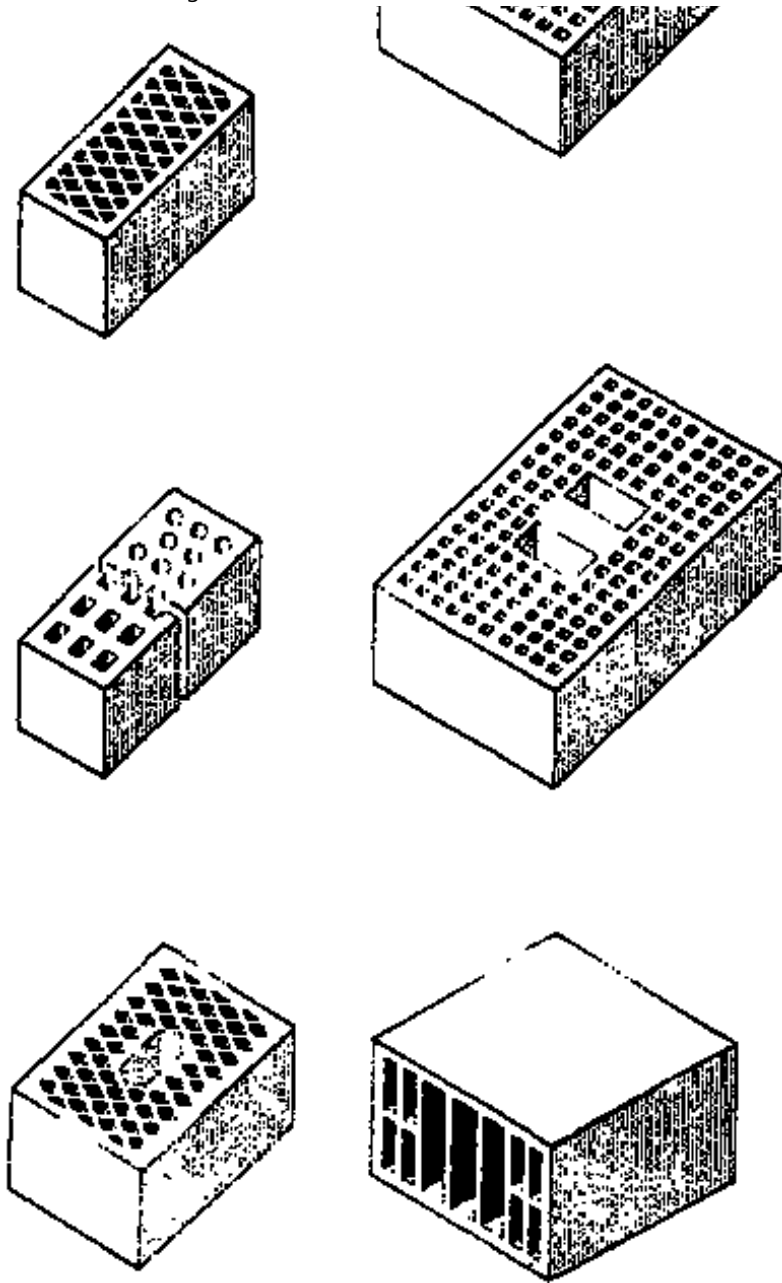

(1) Varieties:

- common

- facing
- engineering

(2) Qualities:

- internal
- ordinary
- special

(3) Types:

- solid/holes do not exceed 25% of volume. Frogs do not exceed 20% of volume.
(A small hole is defined as a hole less than 20 mm wide or less than 500mm in area).
- perforated: holes exceed 25% of volume.
- hollow: holes exceed 25% of volumes holes are larger.
- cellular: holes are close at one end and exceed 20% of the volume.

Bricks may also be classified by one or more of the following:

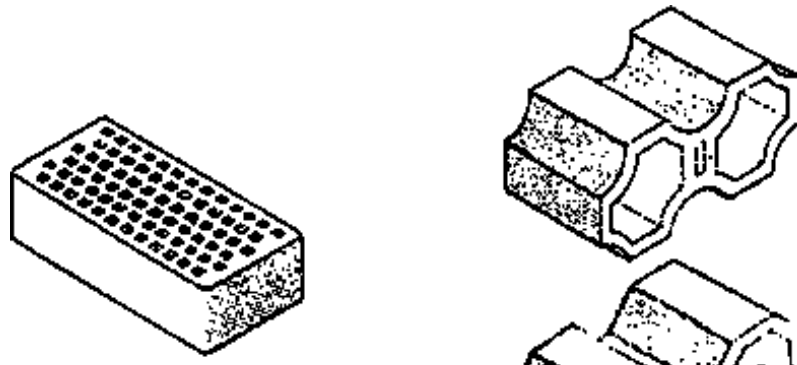



- place of origin
- raw material (i.e. clay)
- manufacture (i.e. wire cut)
- use (i.e. foundation)
- colour
- surface texture (i.e. sand-faced)

6.5.4 CALCIUM SILICATE BRICKS

- These bricks are also called sandlime and sometimes flint- lime bricks and are covered by B.S. 187, Part 2, which gives 8 classes of bricks - the higher the numbered class the stronger is the brick.
- The formate size = standard clay brick.
- These bricks are carefully selected clean sand and/or crushed flint mixed with controlled quantities of lime and water.

(At this stage colouring pigments can be added if required). The relatively dry mix is then fed into presses to be formed into the required shape.

- The moulded bricks are then hardened in sealed and steam pressurised into claves.
- This process, which takes from seven to ten hours, causes a reaction between the sand and the lime resulting in a strong homogeneous brick which is ready for immediate delivery and laying the bricks are very accurate in size and shape but do not have the individual character of clay bricks.

6.5.5 CONCRETE BRICKS

- These are made from a mixture of aggregate and cement in a similar fashion to calcium silicate bricks and are cured either by natural weathering or in an autoclave.

Details of the types and properties available as standard concrete bricks are given in B.S. 1180.

6.5.6 MORTARS FOR BRICKWORK

The mortar used in brickwork transfers the stresses, tensile, compressive and shear uniformly between adjacent brick. To do this it must satisfy certain requirements:

- 1. Adequate strength (not greater than the required for the designed strength).**
- 2. Good workability**
- 3. Plasticity long enough for the bricks to be laid.**
- 4. Durable over lay period.**
- 5. Bond well to the brick.**
- 6. Able to be produced at an economical cost.**

- If the mortar is weaker than the brick shrinkage cracks will tend to follow the joints of the brickcoat and these are reasonably easy to make good.

If the mortar is stronger shrinkage cracks will tend to be vertical through the joints and the brick thus weakening the fabric of the structure.

Typical mixes (by volume)

Cement mortar (1:3) suitable for 'brickwork in exposed conditions such as parapets and for brickwork in foundation.

Lime mortar (1:3) for internal use.

Gauged mortar (cem./lime/sand)

1:1:6 suitable for most conditions.

1:2:9 suitable for most conditions except those of severe expose.

1:3:12 internal use only.

6.5.7 DAMPNESS PENETRATION

- It is possible for dampness to penetrate into a building through, the walls by one or more of three ways:

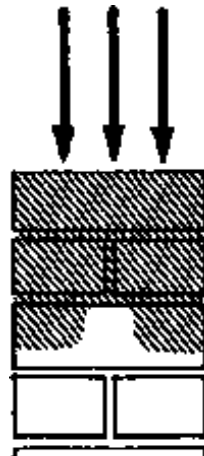

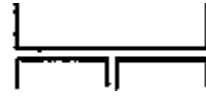

(1) through HEAD of the WALL

(1) By the rain penetrating the head of the wall and soaking down into the building below the roof level.

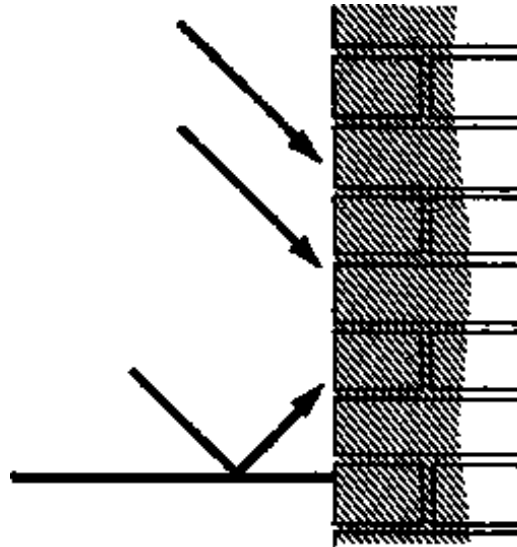

(2) against EXTERNAL WALL

(2) By the rain beating against the external wall and soaking through the fabric in to the building.

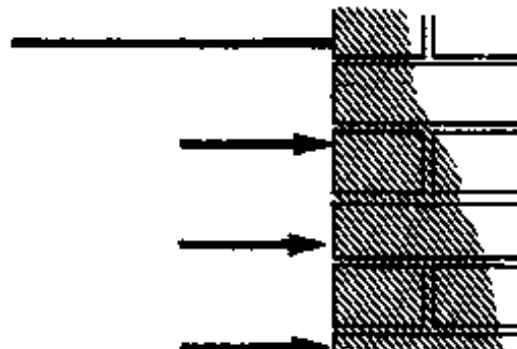

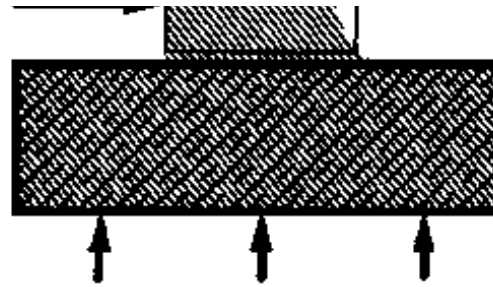

(3) by GROUND MOISTURE

(3) By ground moisture entering the wall at or near to the base and creeping up the wall by capillary action and entering the building above the ground floor level.

- Nos. 1 and 3 can be overcome by the insertion of a suitable D.P.C. in the thickness of the wall.
- No. 2 can be overcome by one of the two methods:
 - (a) Applying to the exposed face of the wall a barrier such as cement rendering or some suitable cladding like vertical tile hanging.
 - (b) By constructing a cavity wall, whereby only the external skin becomes damp. The cavity, providing a suitable barrier to the passage of moisture through the wall.

6.5.8 BRICKWORK BONDING

- Bricks are layed to bonds, in order
 - to ensure stability of the structure and to produce a pleasing appearance.

- No vertical joint in any one course to be directly above or below a vertical joint in the adjoining course.
- Special bricks are produced (or cut from whole bricks on site) to simplify this requirement (Fig. II 11)
- The various bonds are planned to give the greatest practical amount of lap to all bricks. (= not to be less than 1/4 of a brick length).
- Properly bonded brickwork distributes the load over as large an area as possible (angle at spread of the load = 60)

6.5.8.1 Common bonds

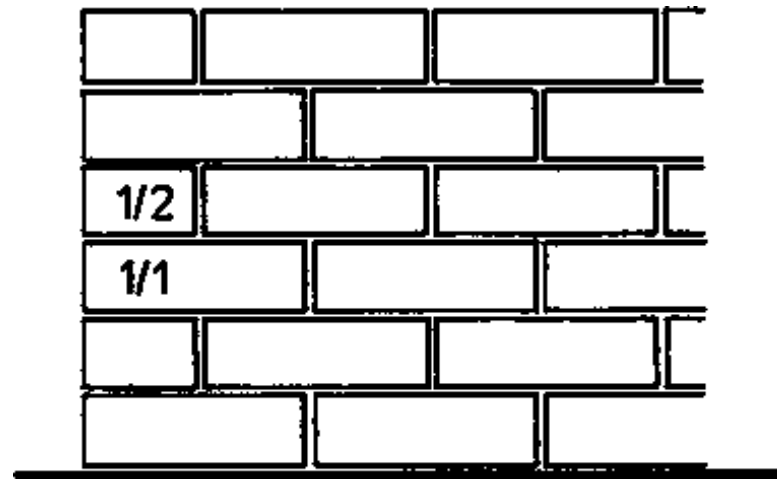

Header bond: Consists of all headers, with the bond being formed by 3/4 bats at the quoins. It is used for one-brick walls in footing courses or walling curved on plan.

Stretcher bond; consists of all stretchers in every course and is used for half brick walls and the half brick skins of hollow or cavity walls.

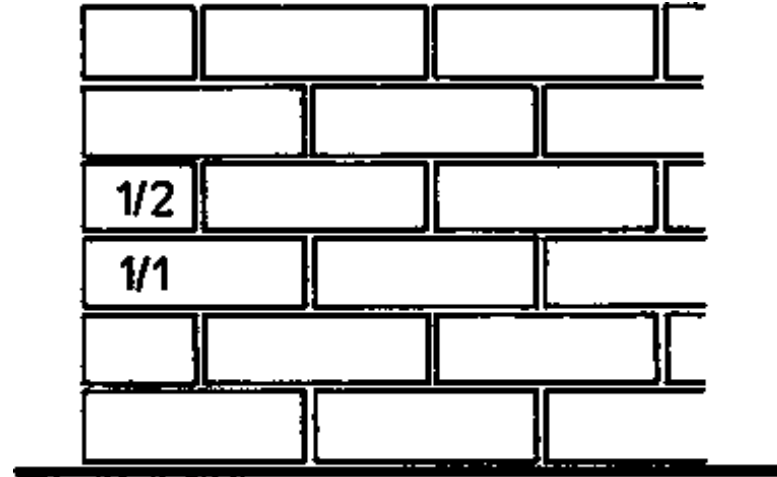

English bond: A very strong bond consisting of alternate headers and stretchers, with a queen closer placed next to the queen header to form the lap.

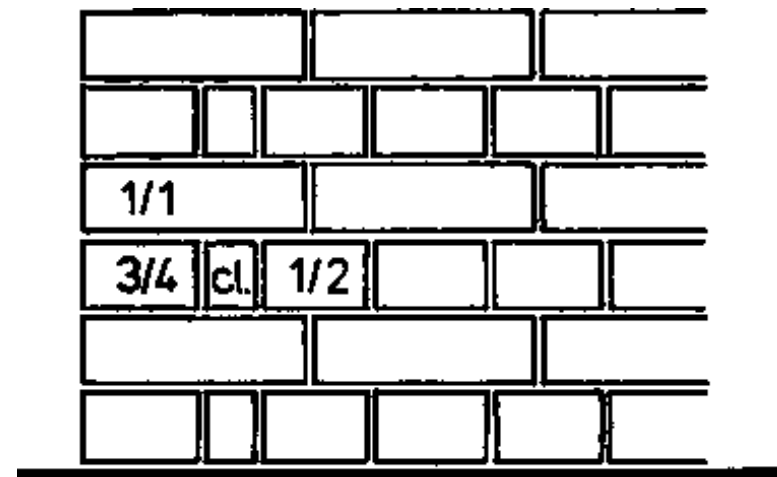

Cross bond: The strongest possible bond used for one-brick walls consisting of alternate courses of headers and stretchers, with the bond being formed by 3/4 bats at the quoins of the stretcher courses. In every second stretcher course the 3/4 bats are followed by a header.

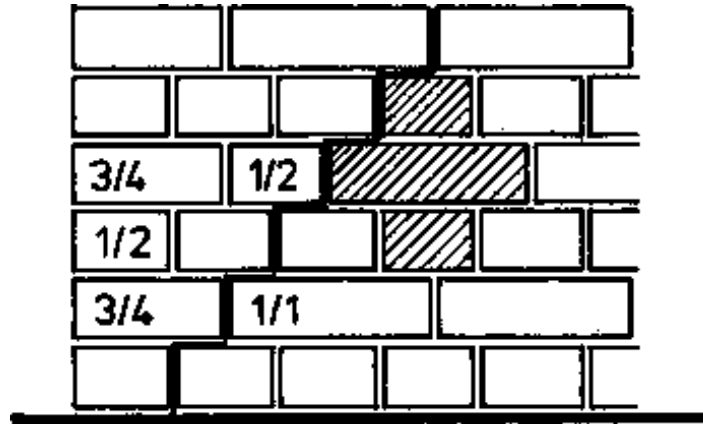

Flemish bond: each, course consists of alternate headers and stretchers, its appearance is considered to be better than English bond but it is not quite so strong. This bond requires fewer facing bricks (than *Engl-bond*) needing only 79 bricks/m² (Engl. bond: 89 bricks/m²).

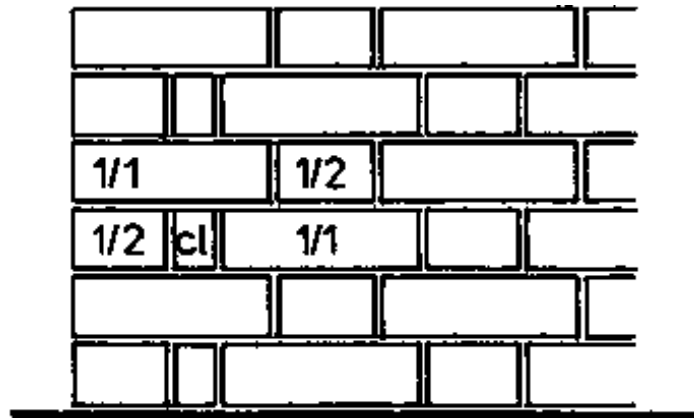

Monk bond: Consists of 2 stretchers to 1 header in each course.. The header is laid centrally over the

cross-joint between 2 stretchers in the course below.

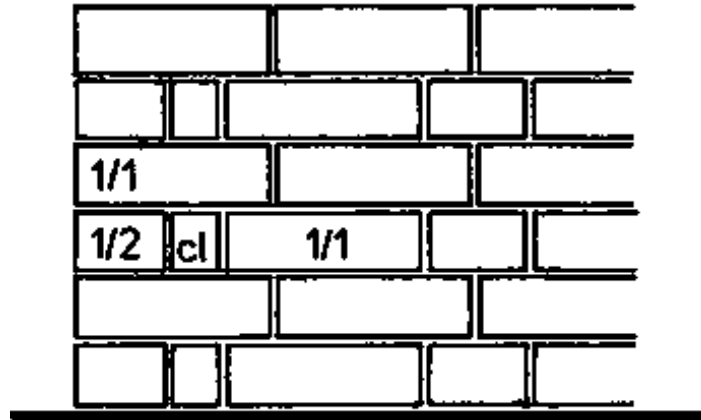

Flemish garden wall bond: = 1 header/3 stretchers in every course.

This bond is fairly economical in facing bricks and has a pleasing appearance.

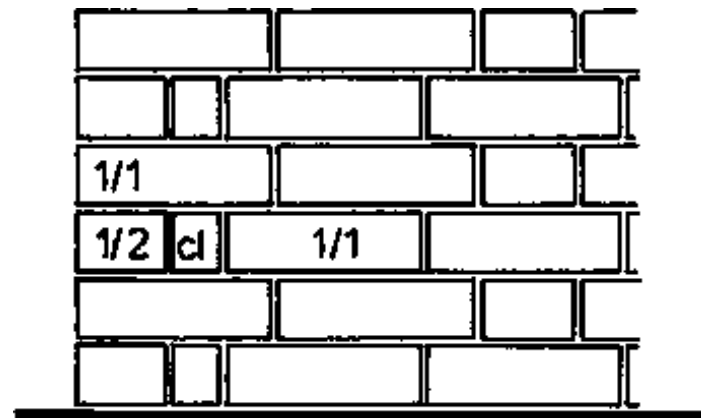

English garden wall bond: = 3 courses of stretchers/1 course of headers.

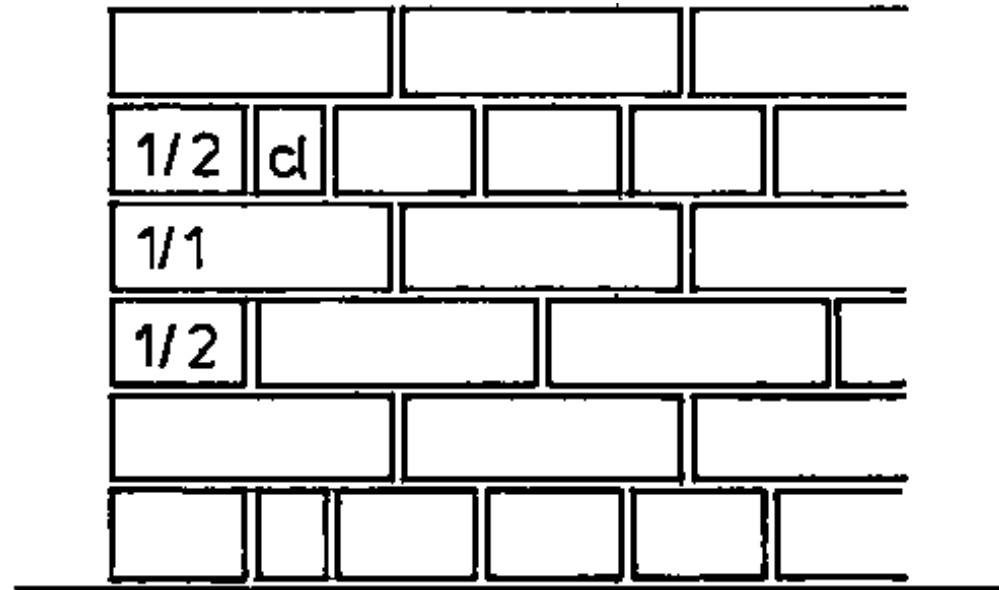

Special bonds;

Rat-trap bond (brick on edge b) Quetta bond (1 1/2 brick walls) (Fig. 11.15)

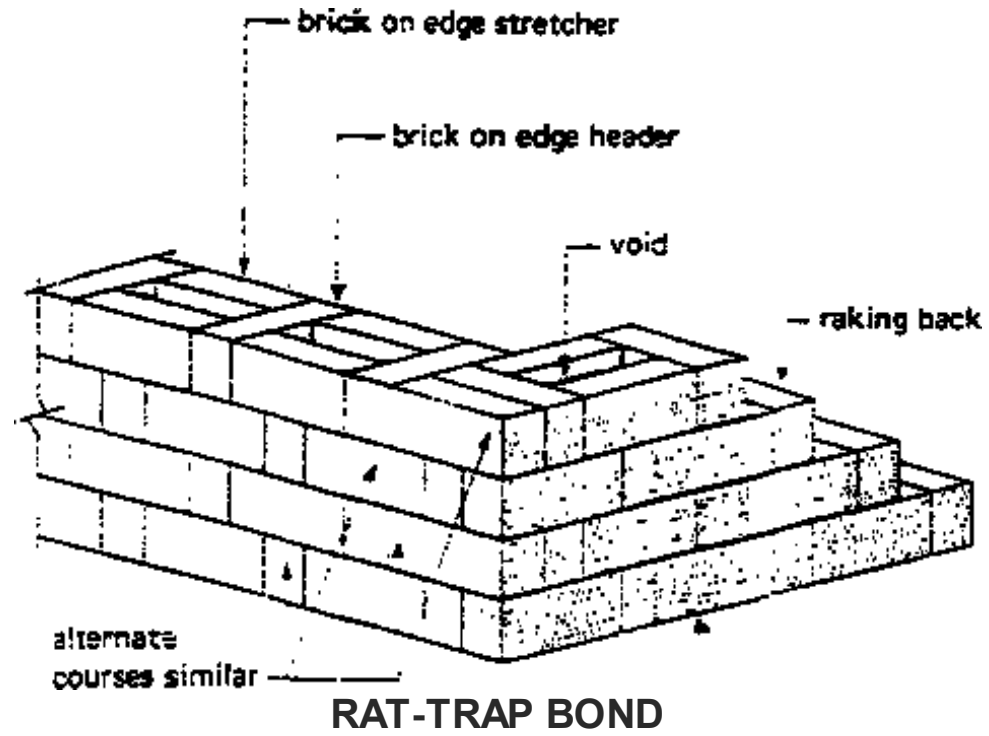

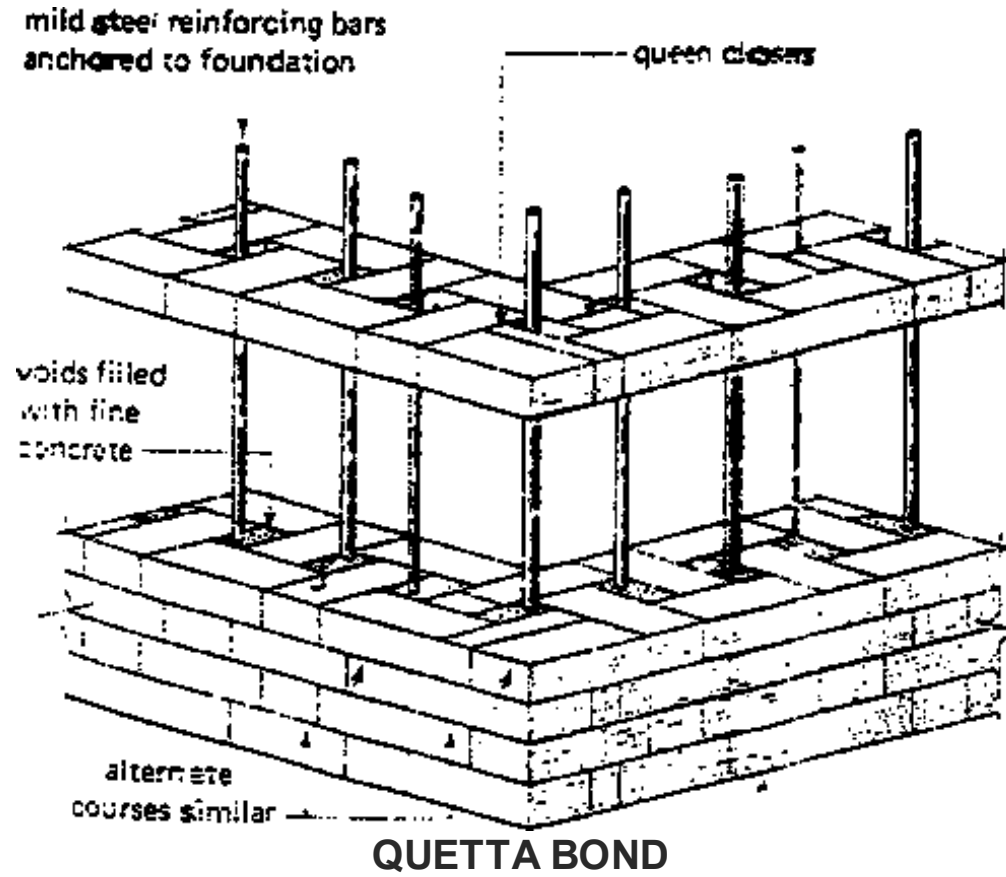

ISOMETRIC VIEW OF:

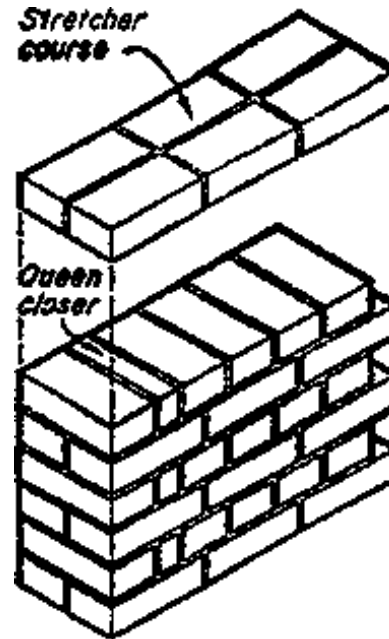

A One-brick wall 1n English bond and stopped end

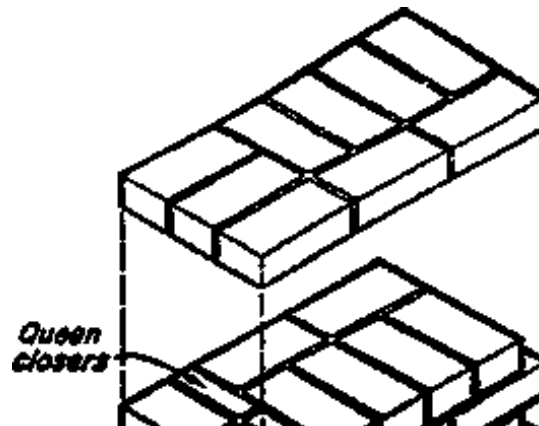

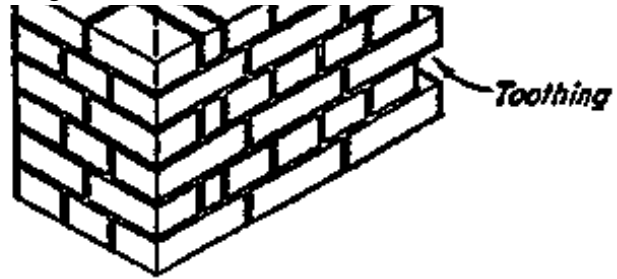

B One-and-half-brick wall In English bond and stopped end

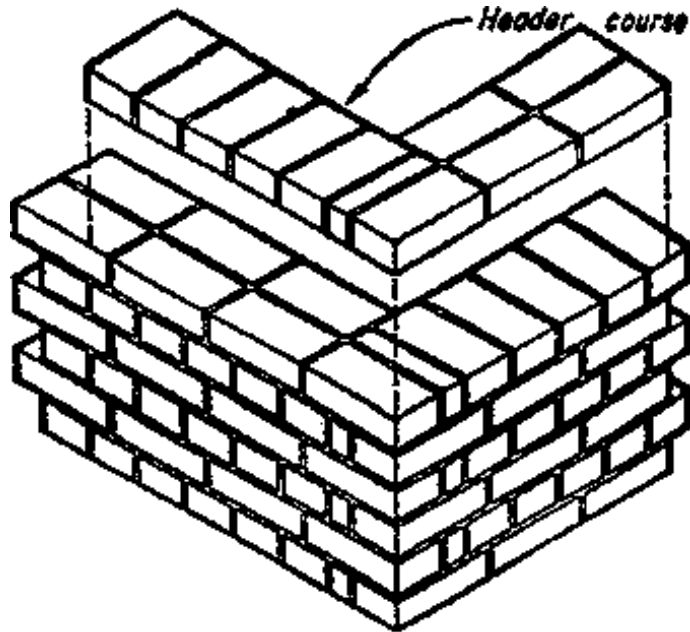

C One-brick wall in English bond and quoin

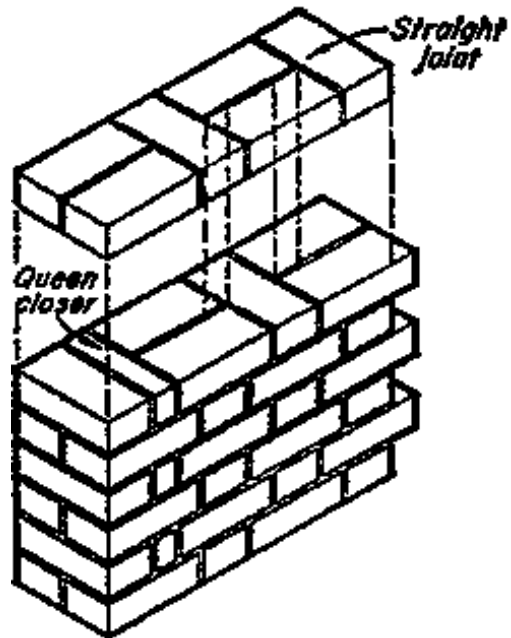

D One-brick wall in Flemish bond and stopped end

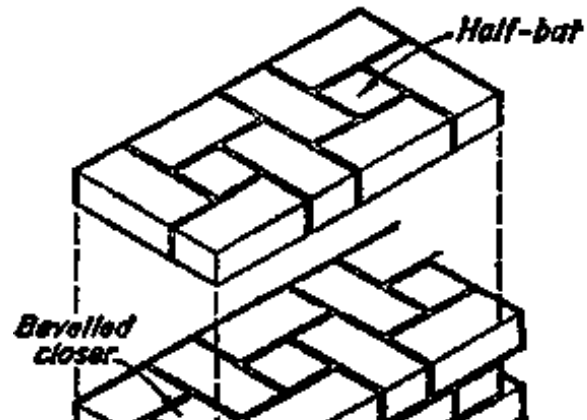

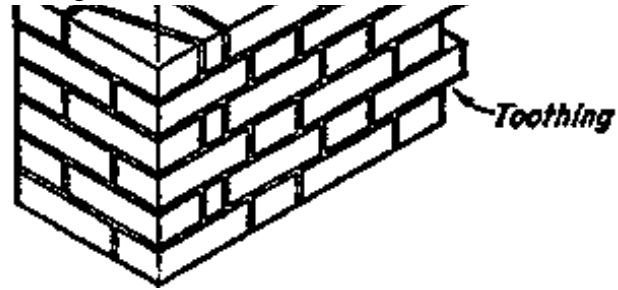

E One-and-half-brick wall in Flemish bond and stopped end

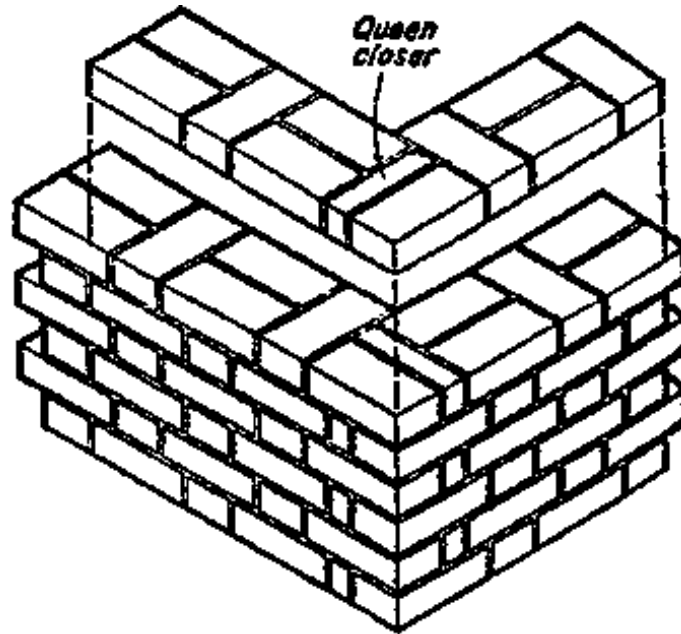

F One-brick wall in Flemish bond and quoin

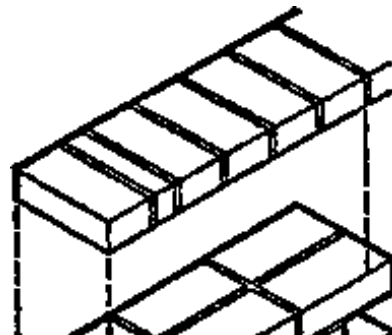

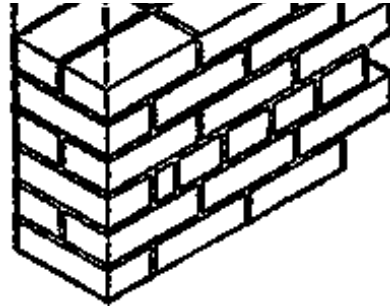

G English garden wall bond

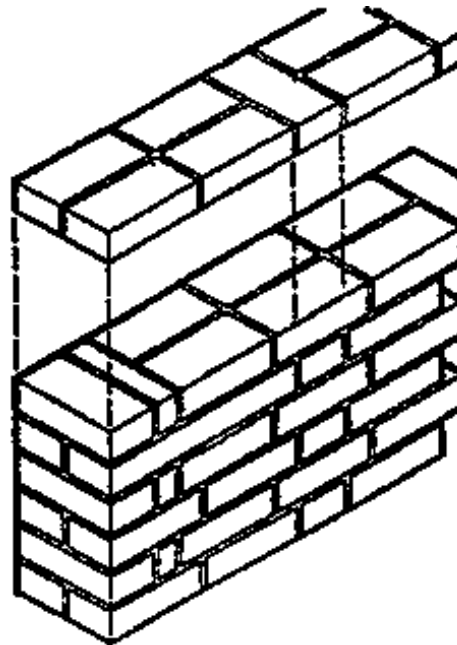

H Flemish garden wall bond

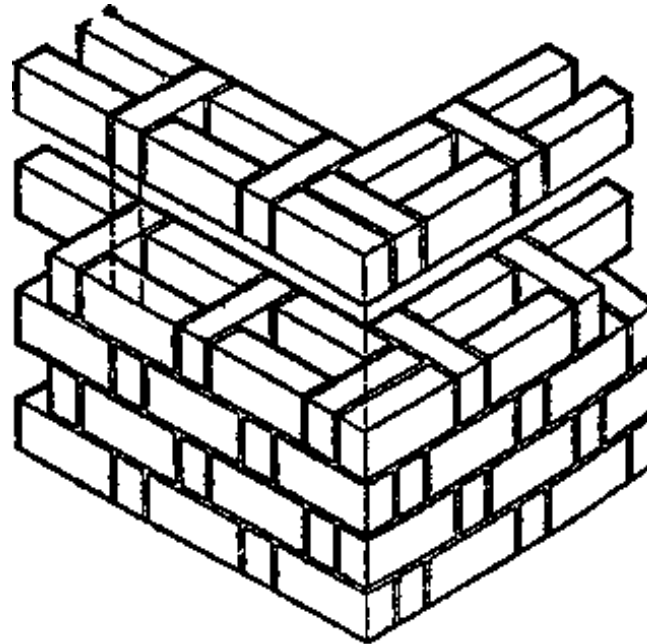

J Rat-trap bond

6.5.9 METRIC MODULAR BRICKWORK

- The standard format brick does not fit reasonably well into the system of dimensional co ordination with, its preferred dimension of 300 mm, therefore METRIC MODULAR BRICKS have been designed (4 different formats).

(Fig. 11.16)

- 300 x 100 x 100
- 300 x 100 x 75

- 200 x 100 x 100
- 200 x 100 x 75

- The bond arrangements are similar to the well-known bonds but are based on **THIRD BONDING**: overlap = 1/3 of a brick (not 1/4 as with standard bricks).

GERMAN METRIC MODULAR SYSTEM

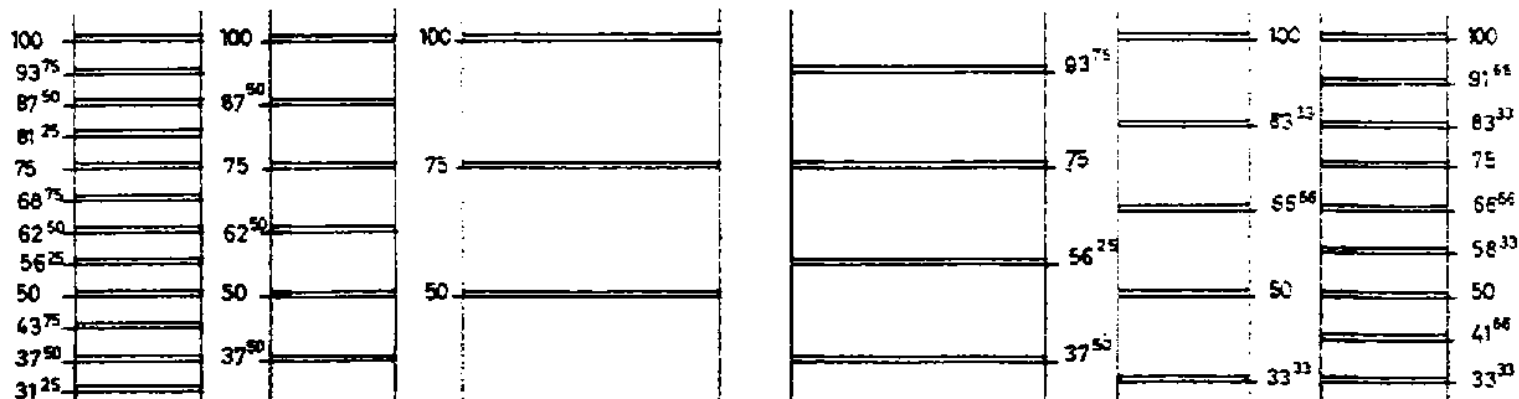
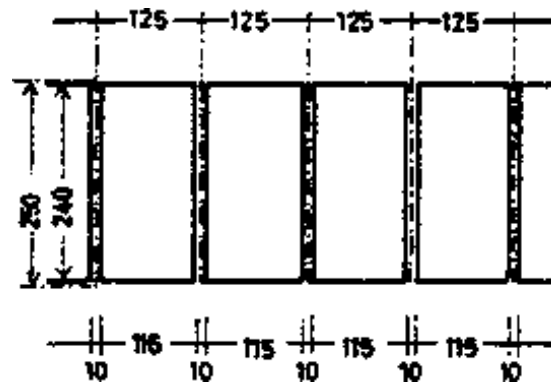

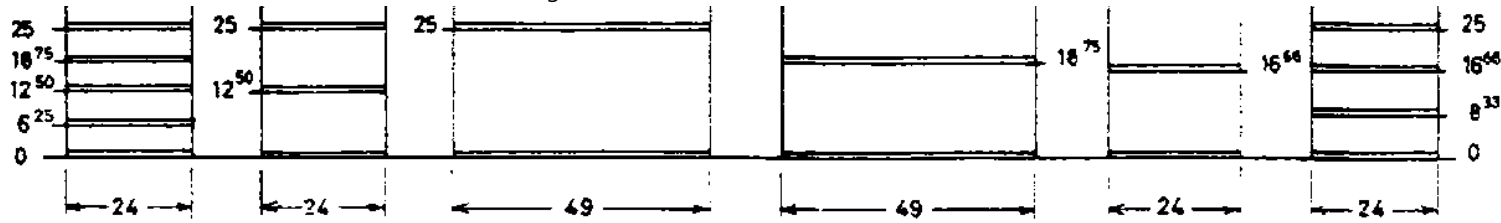

BRITISH STANDARD

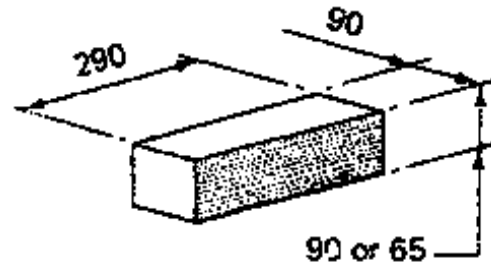

format size 300 x 100 x 100
or 300 x 100 x 75

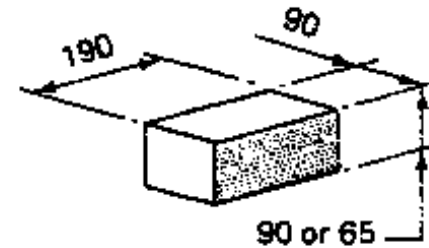

format size 200 x 100 x 100
or 200 x 100 x 75

Metric Modular Bricks

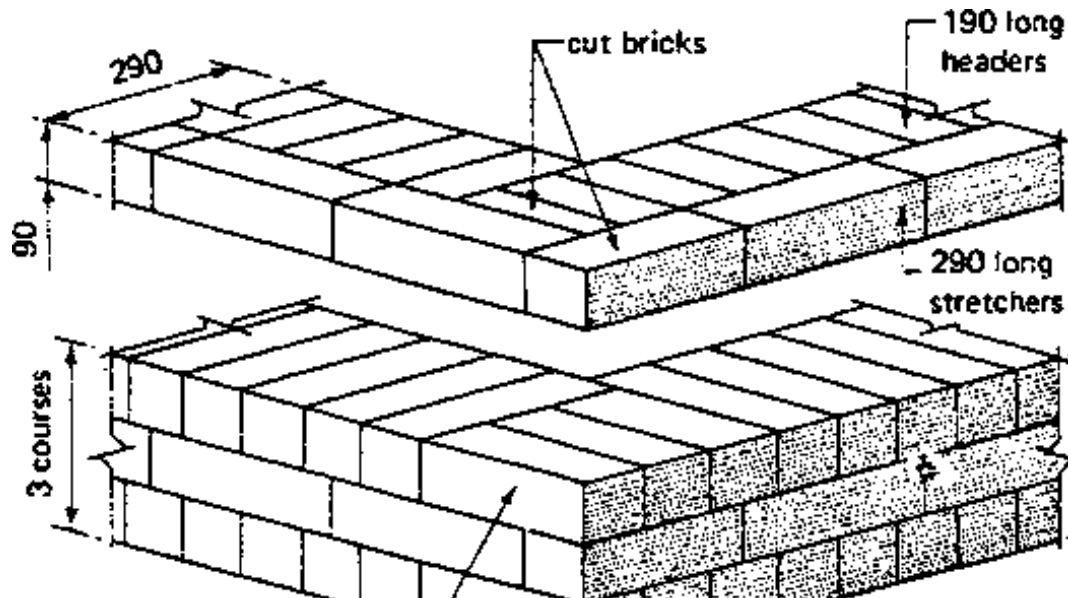

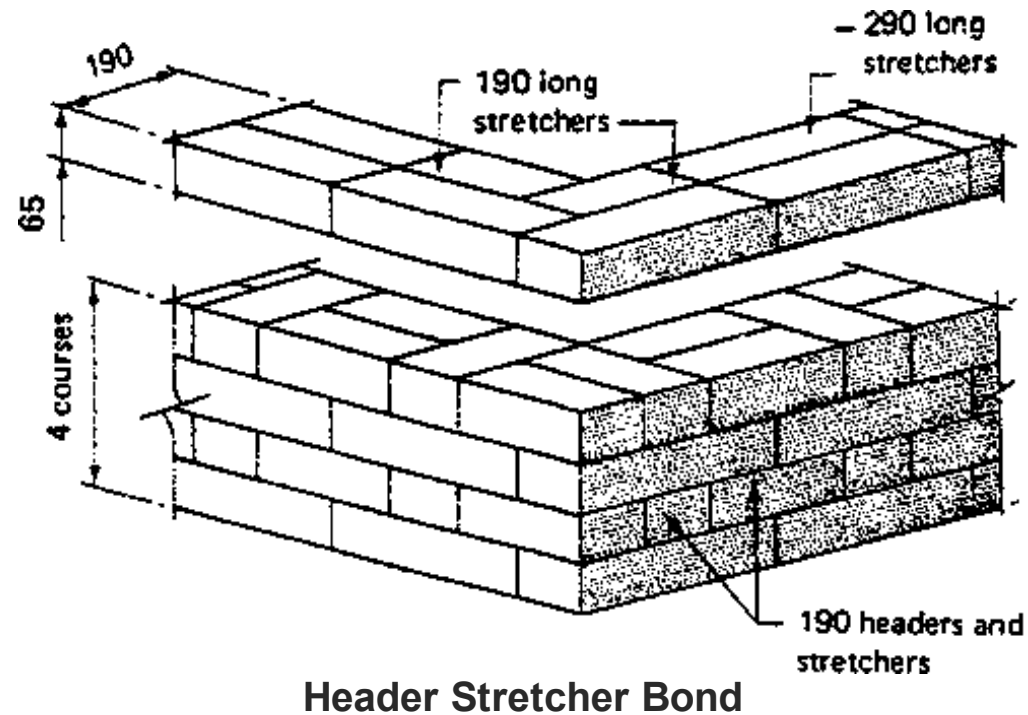

6.5.10 JUNCTIONS

- Junctions are classified into o right-angled junctions and o squint junctions.
- There are 2 forms of right- angled junctions: o tee-junctions and o cross junctions (or intersections)
- The examples shown in the figures are only few of several methods of bonding at junctions. The essential requirements are the avoidance of continous vertical joints with the employment of the

Essential requirements are the avoidance of continuous vertical joints with the employment of the minimum number of cut bricks.

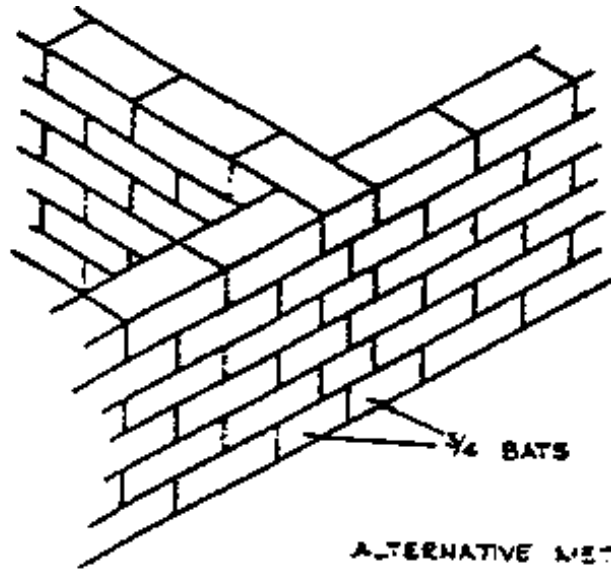

ALTERNATIVE METHODS OF BONDING A JUNCTION WALL IN STRETCHER BOND

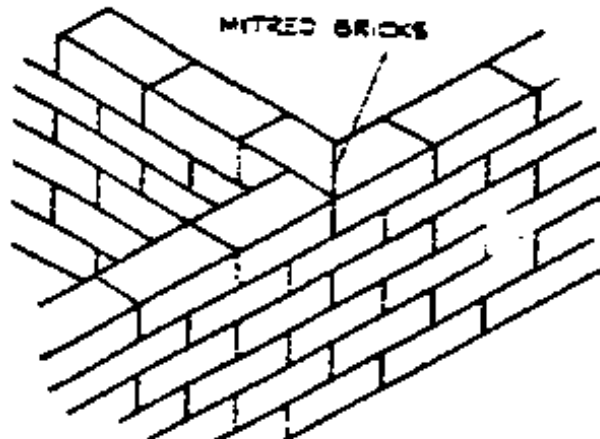

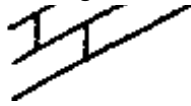

STRETCHER BOND

TEE-JUNCTION WALLS IN ENGLISH BOND

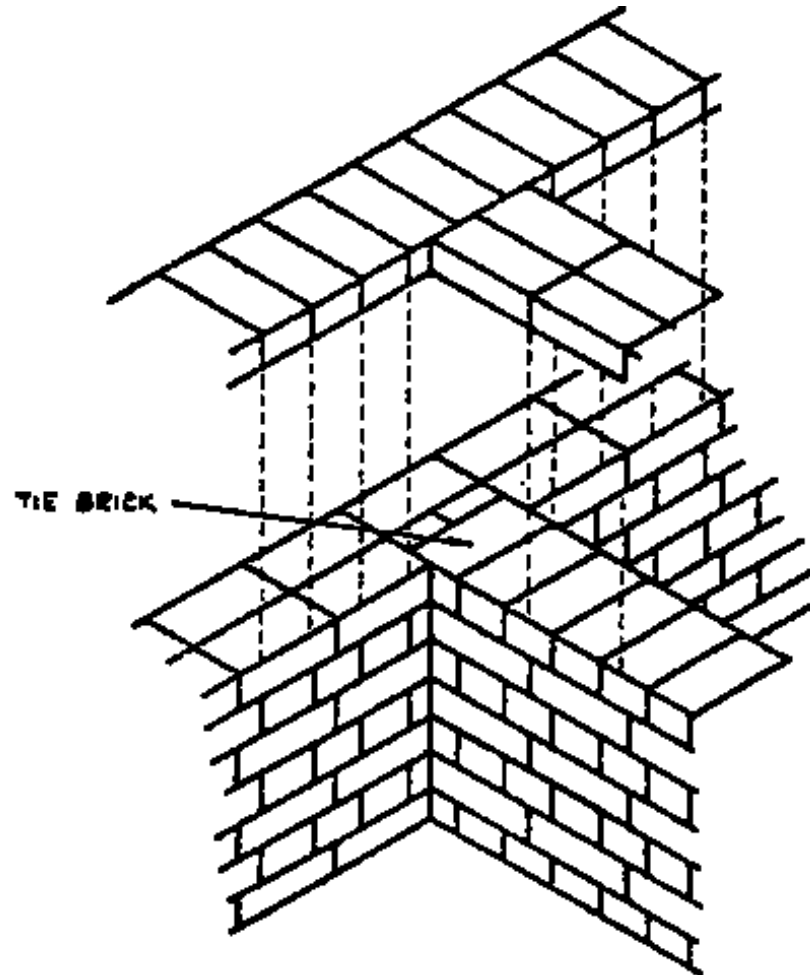

1-BRICK JUNCTION WALL ADJOINING A 1-BRICK MAIN WALL (ISOMETRIC VIEW)

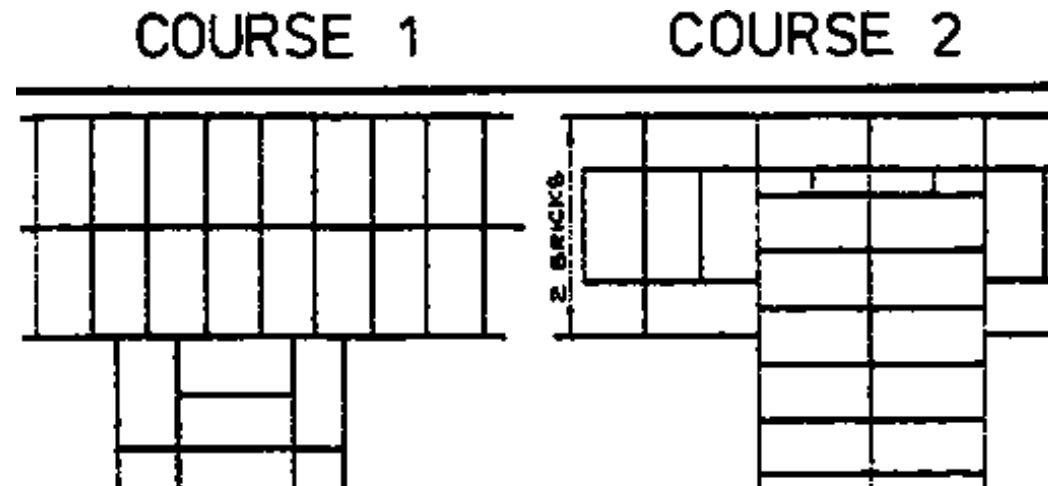
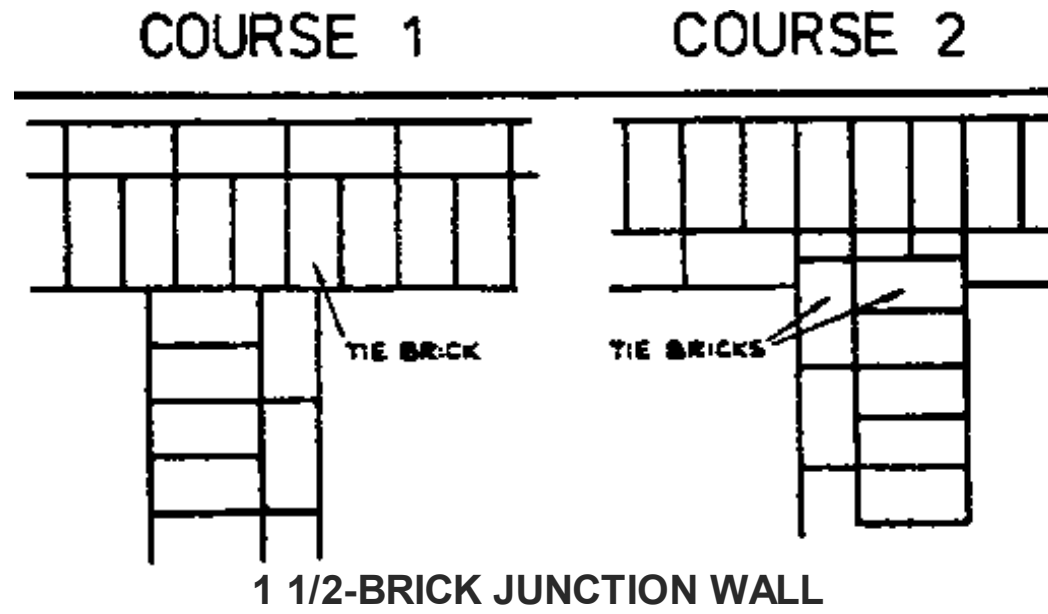

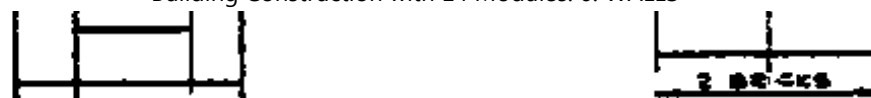

2-BRICK JUNCTION WALL

COURSE 1

COURSE 2

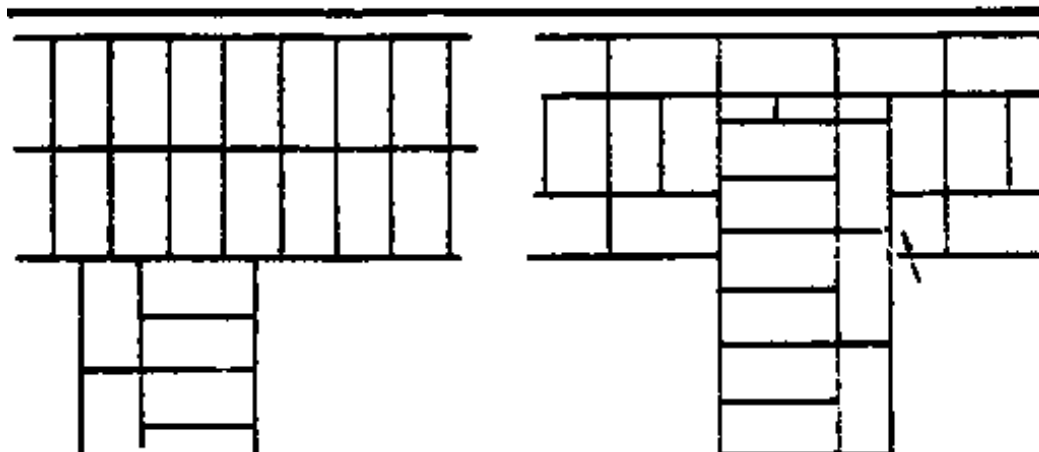

1 1/2-BRICK JUNCTION WALL INTO A 2 BRICK MAIN WALL

COURSE 1

COURSE 2

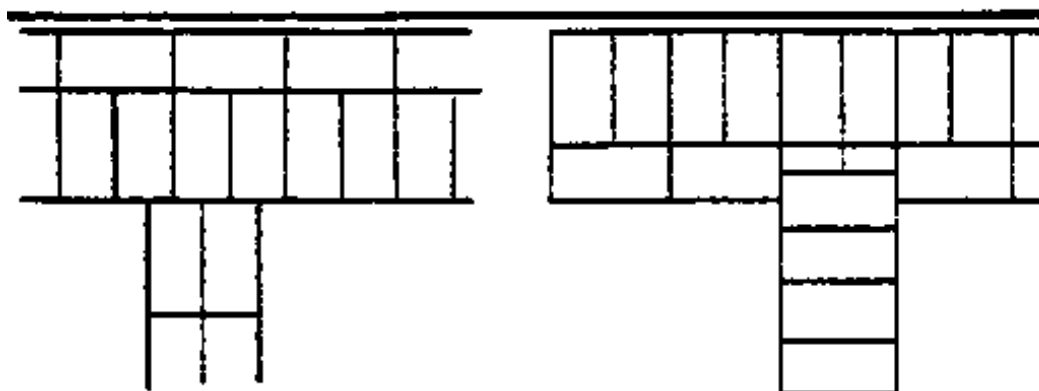

1 BRICK JUNCTION WALL INTO A 1 1/2 BRICK MAIN WALL

TEE-JUNCTION WALLS IN FLEMISH BOND

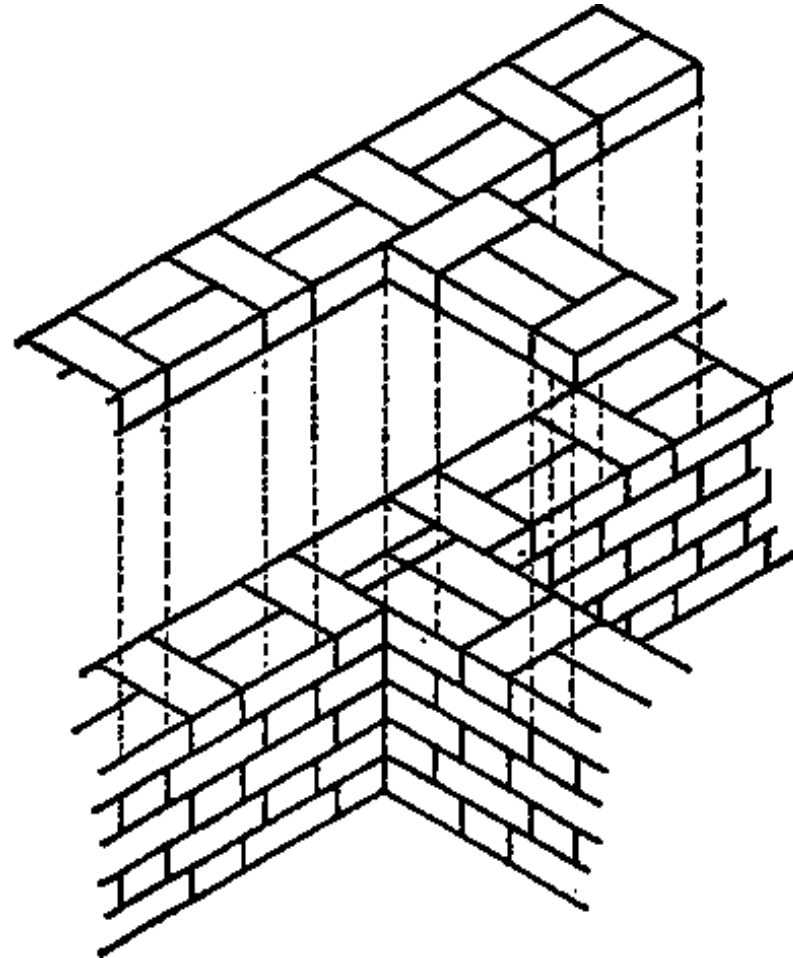

1-BRICK JUNCTION WALL ADJOINING A 1-BRICK MAIN WALL

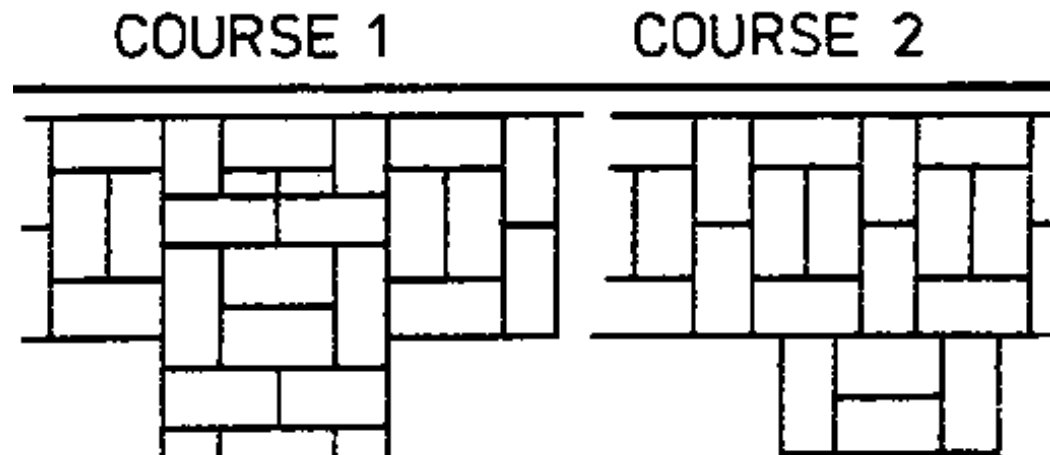
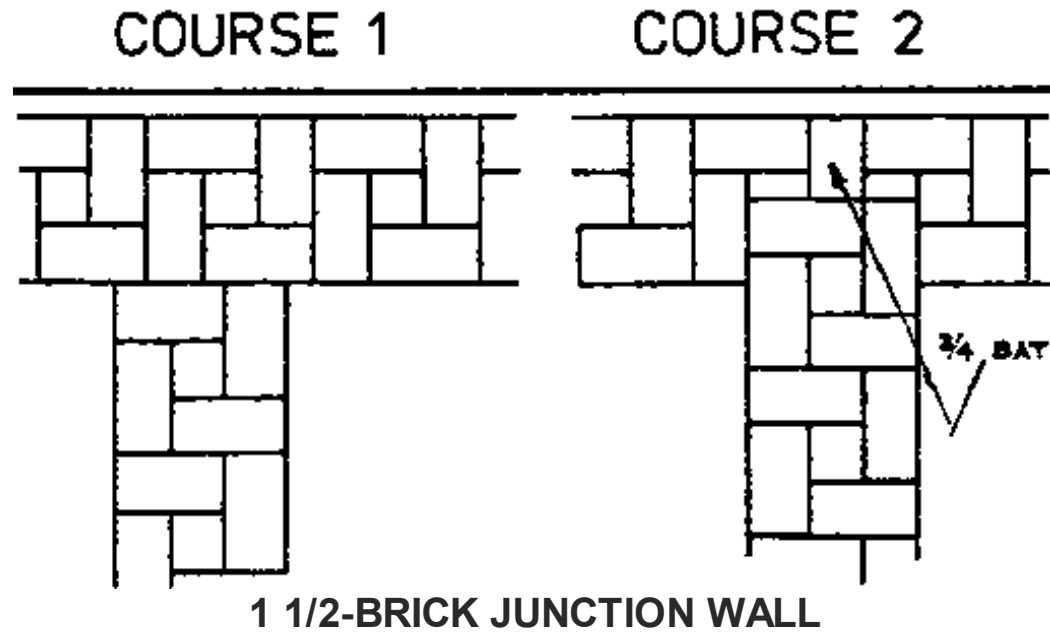

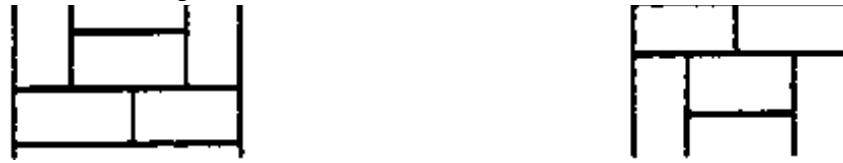

2-BRICK JUNCTION WALL

COURSE 1

COURSE 2

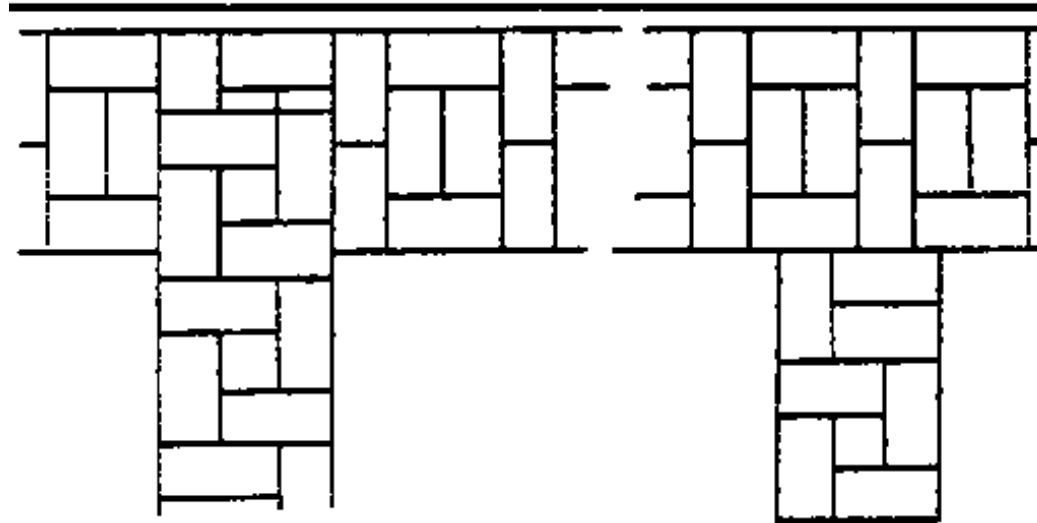

1 1/2 BRICK JUNCTION WALL INTO A 2 BRICK MAIN WALL

COURSE 1

COURSE 2

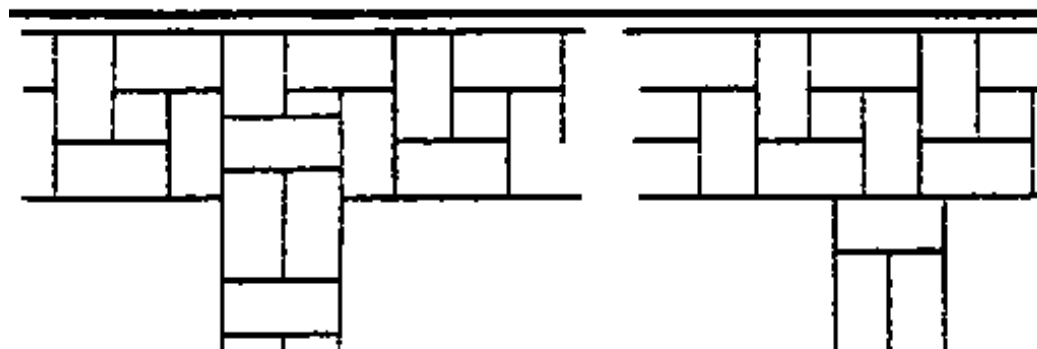



1 BRICK JUNCTION WALL INTO A 1 1/2 BRICK MAIN WALL

CROSS JUNCTION WALLS IN ENGLISH BOND

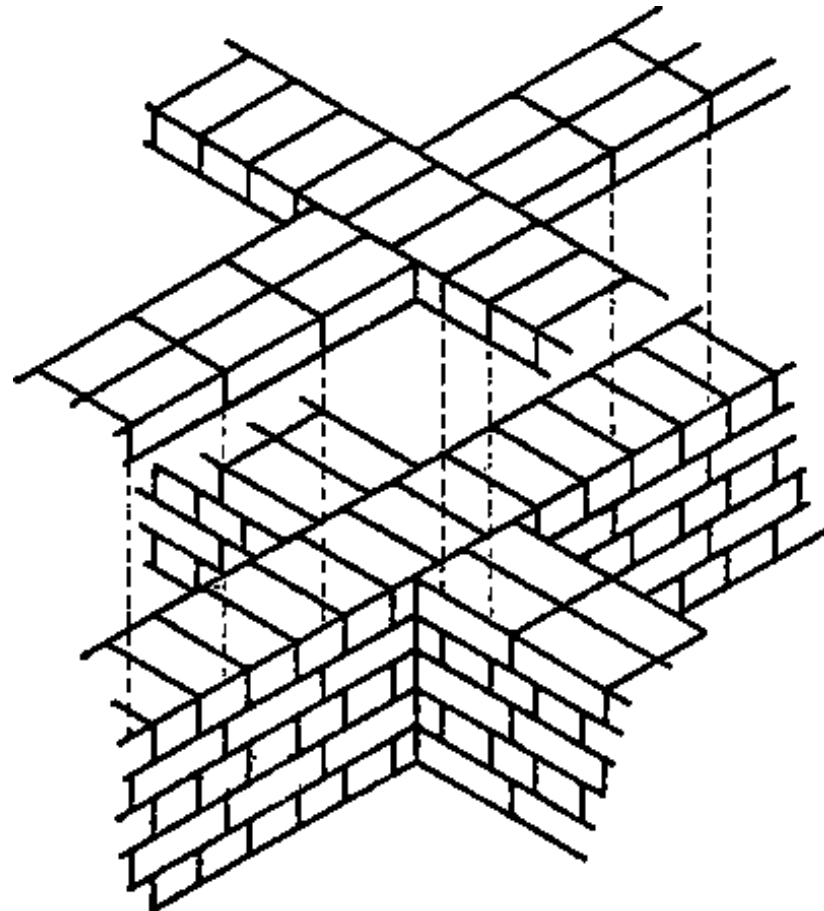

1-BRICK CROSS-WALL (ISOMETRIC VIEW)

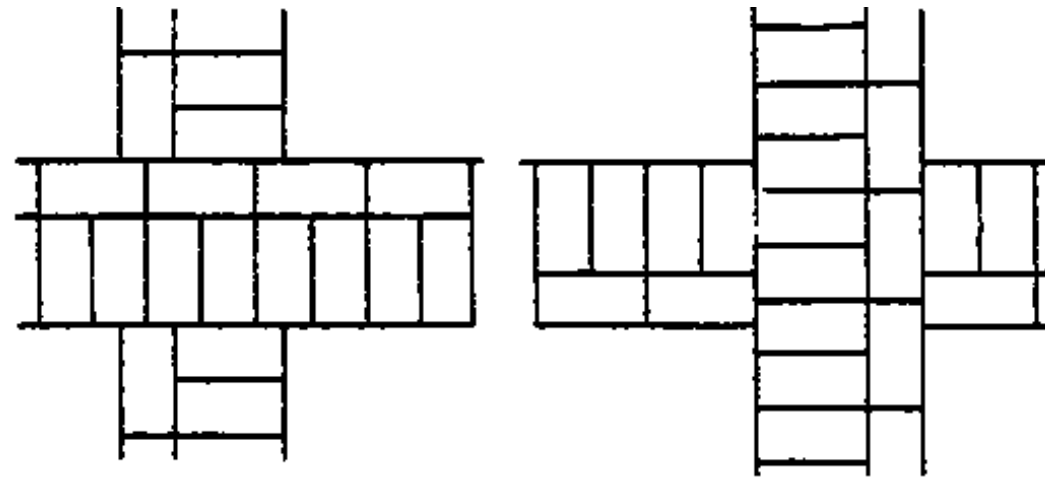

1 1/2-BRICK CROSS-WALL

COURSE 1

COURSE 2

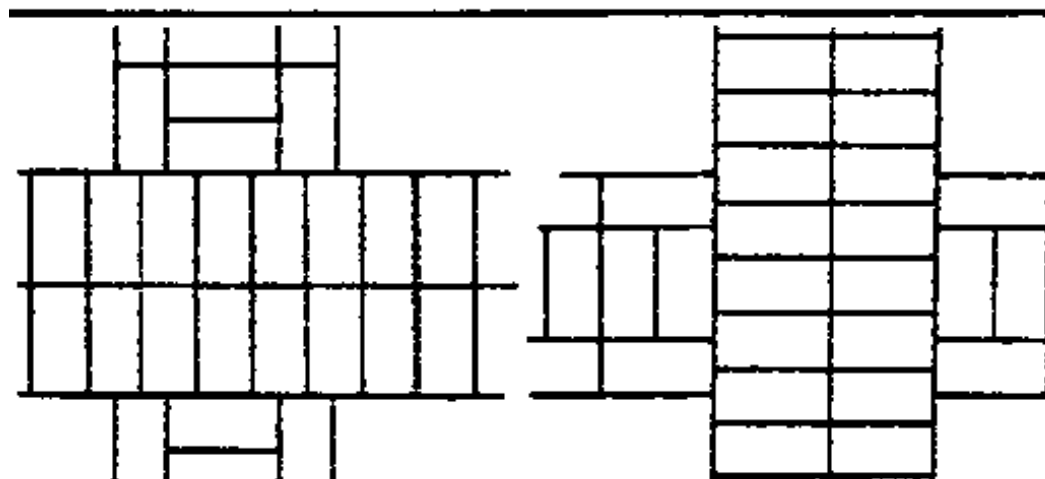



2-BRICK CROSS-WALL

COURSE 1

COURSE 2

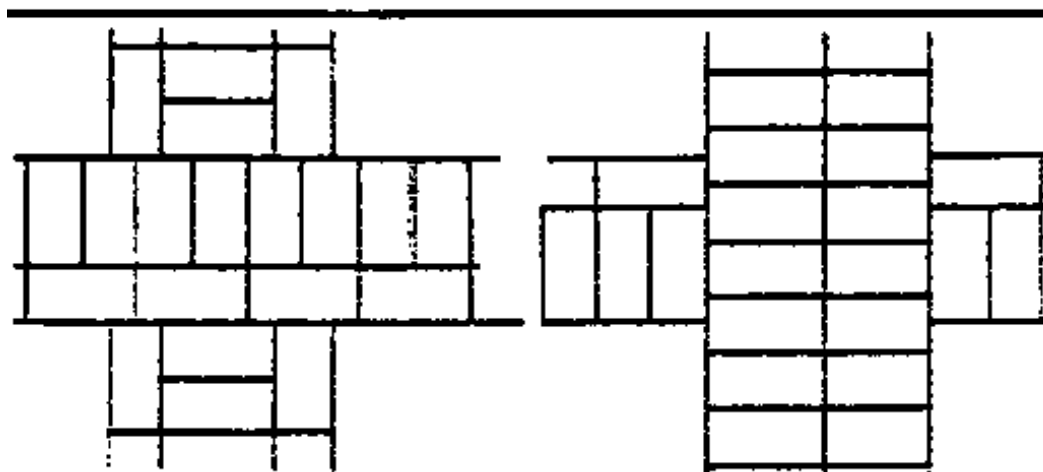

2-BRICK WALL CROSSING A 1 1/2-BRICK WALL

COURSE 1

COURSE 2

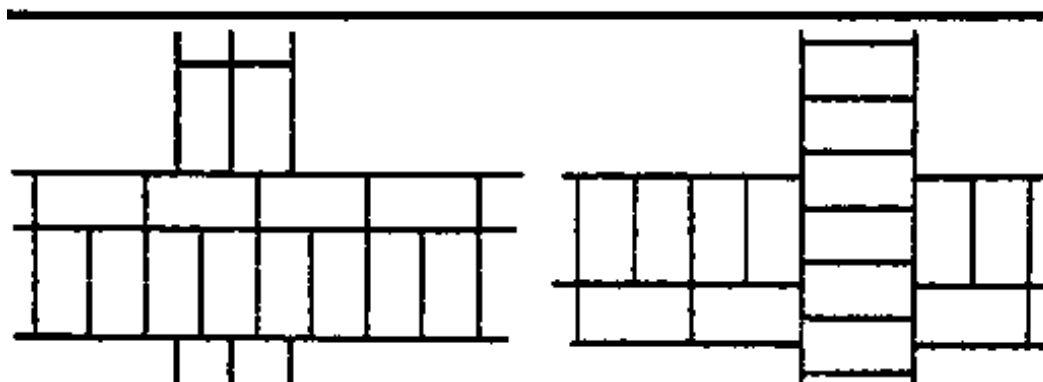



1-BRICK WALL CROSSING A 1 1/2 BRICK WALL

COURSE 1

COURSE 2

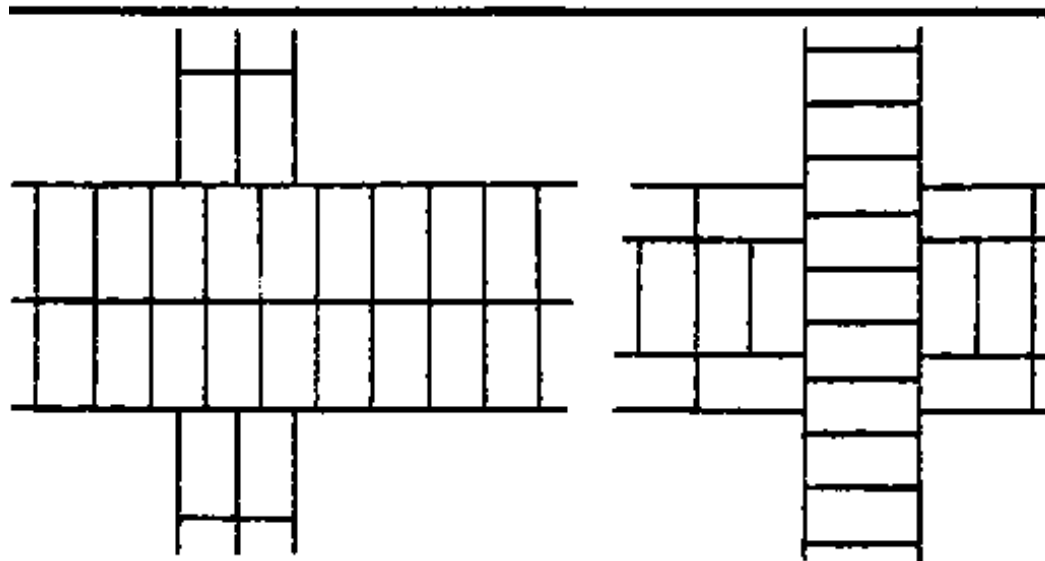

1-BRICK WALL CROSSING A 2 BRICK WALL

CROSS JUNCTION WALLS IN FLEMISH BOND

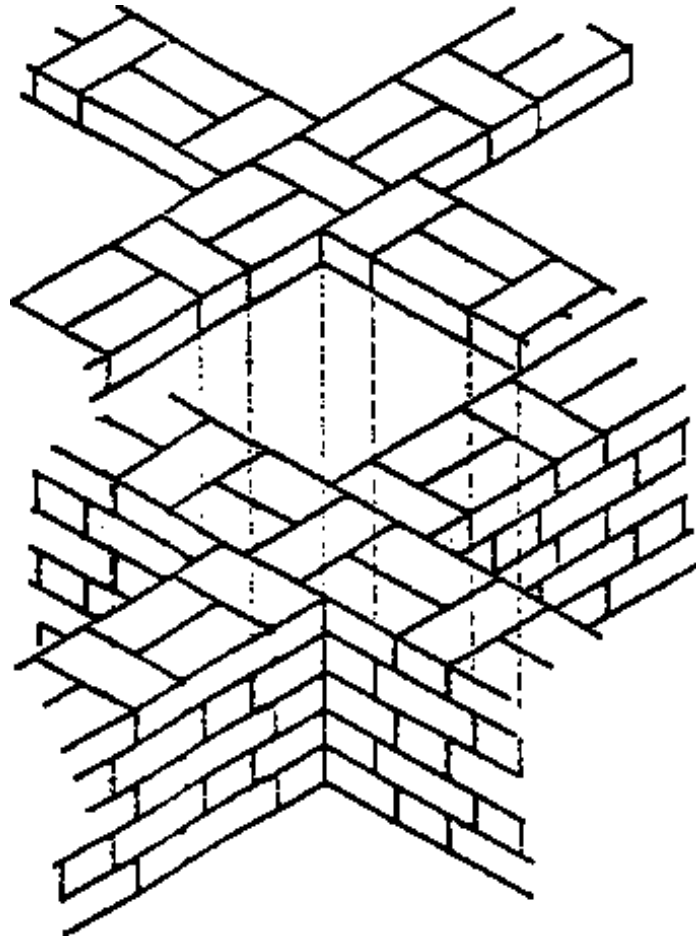

1-BRICK CROSS WALL

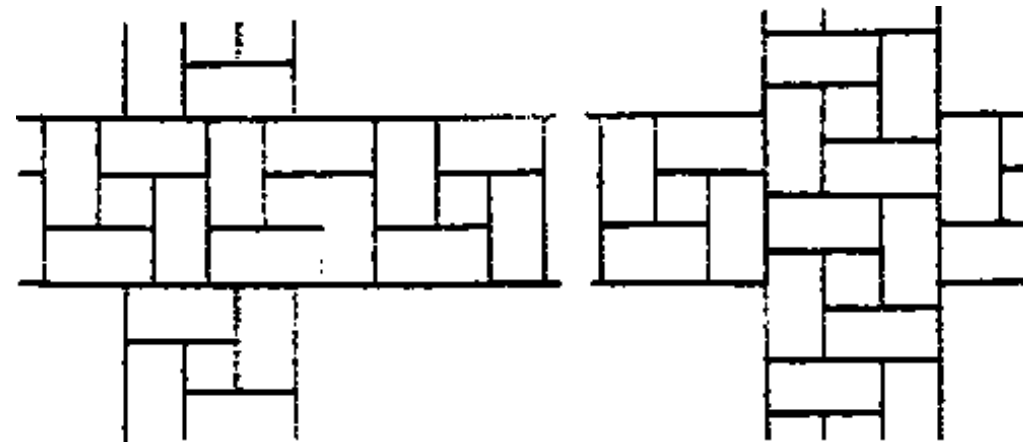

1 1/2-BRICK CROSS WALL

COURSE 1

COURSE 2

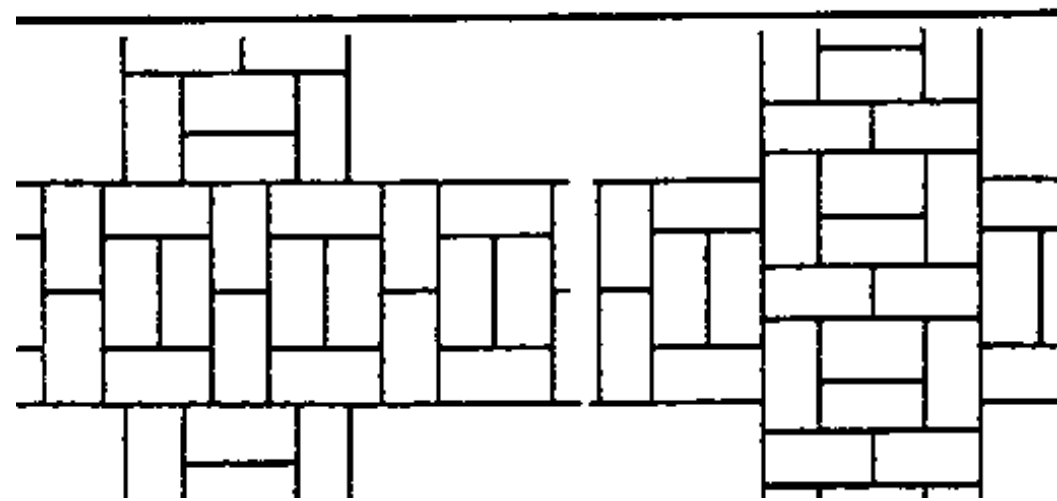



2-BRICK CROSS-WALL

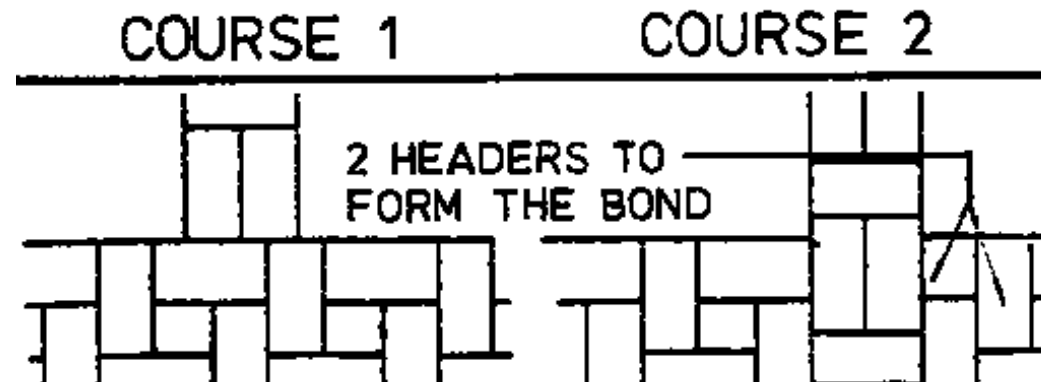
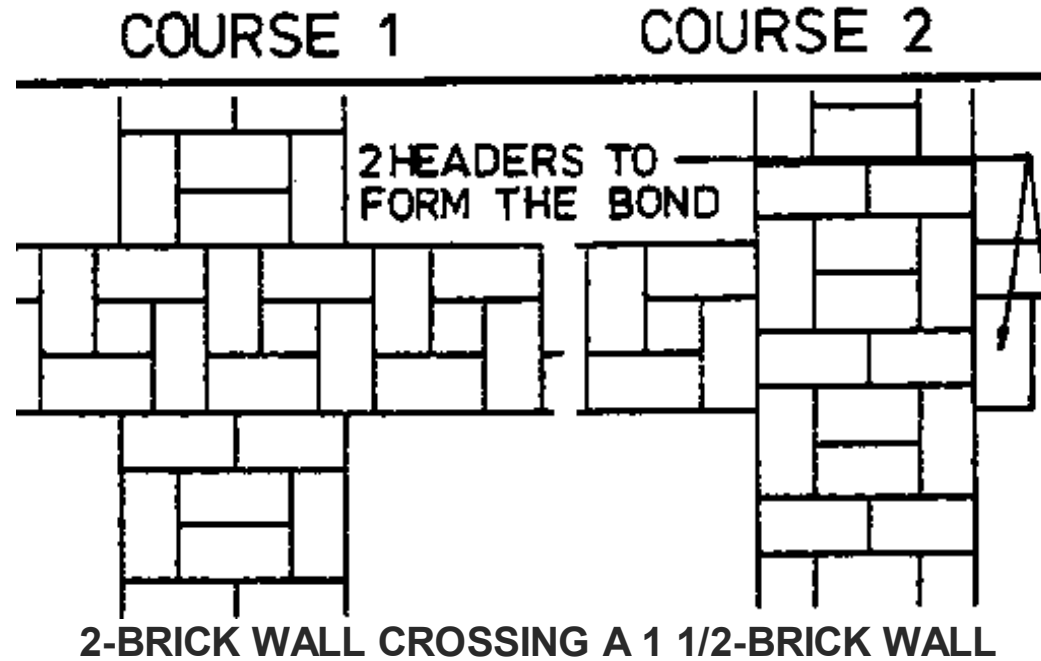

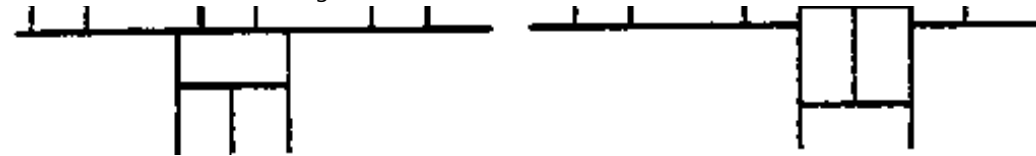

1-BRICK WALL CROSSING A 1 1/2-BRICK WALL

COURSE 1

COURSE 2

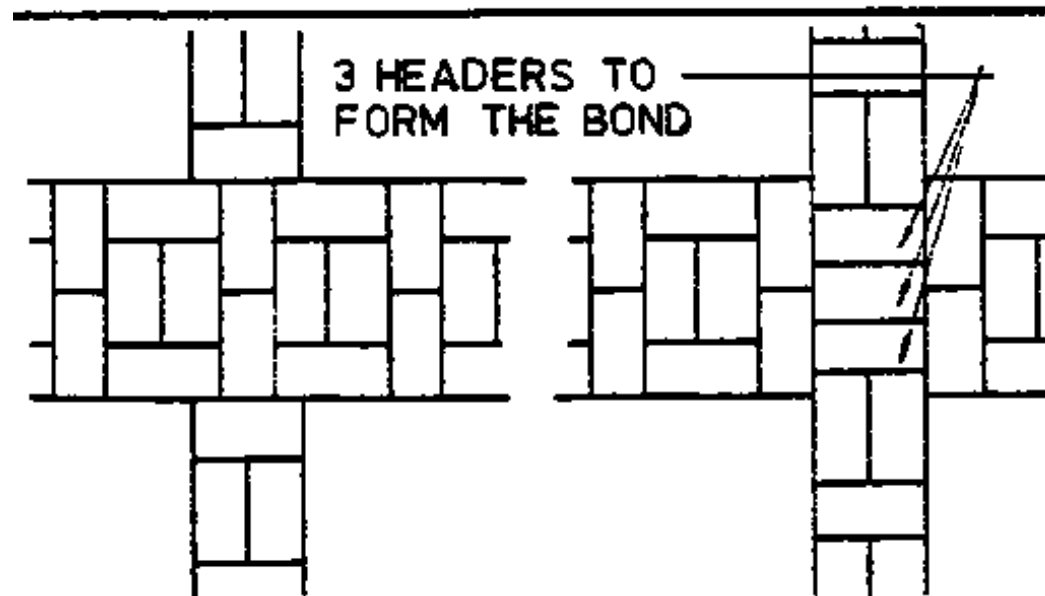

1-BRICK WALL CROSSING A 2-BRICK WALL

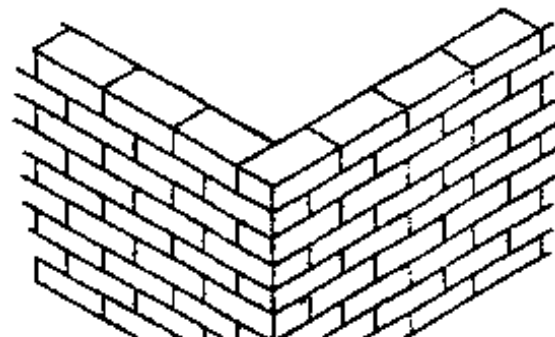

**QUOIN
HEADER**
QUOIN: 1/2 BRICK - STRETCHER BOND

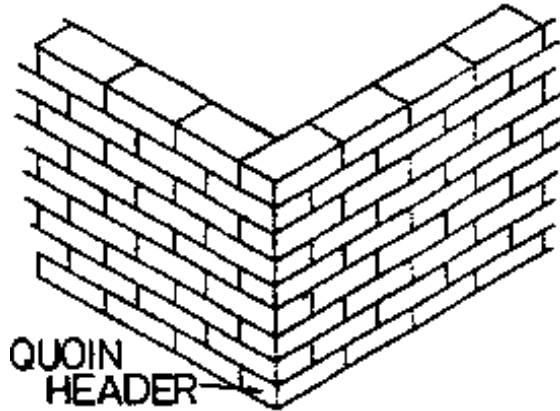

QUOIN: 1/2 BRICK - STRETCHER BOND

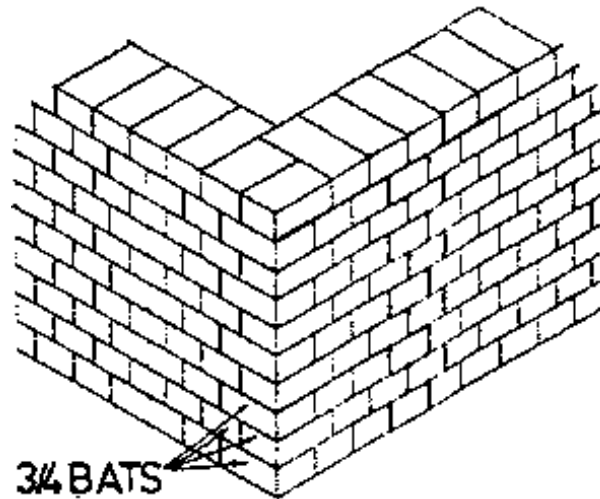

QUOIN: 1 BRICK - HEADER BOND

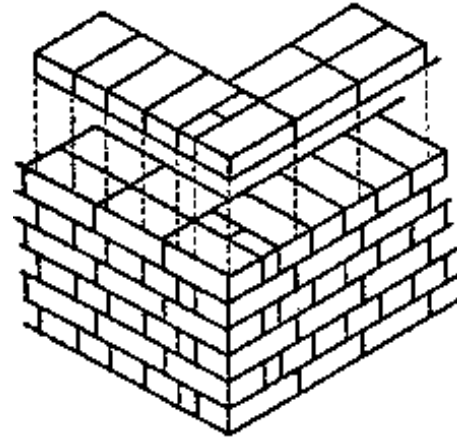

QUOIN: 1 BRICK - ENGLISH BOND

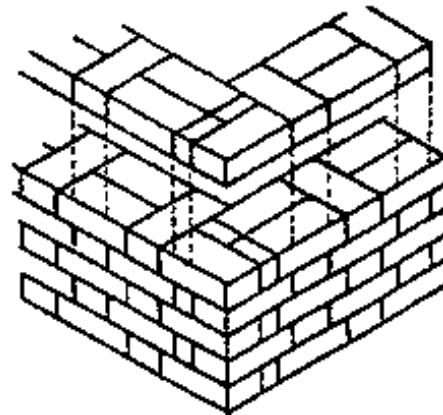

QUOIN: 1 BRICK - FLEMISH BOND

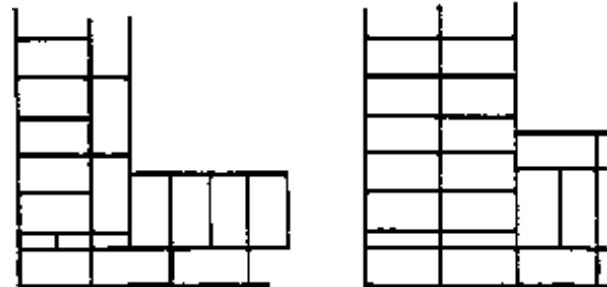

COURSE 1

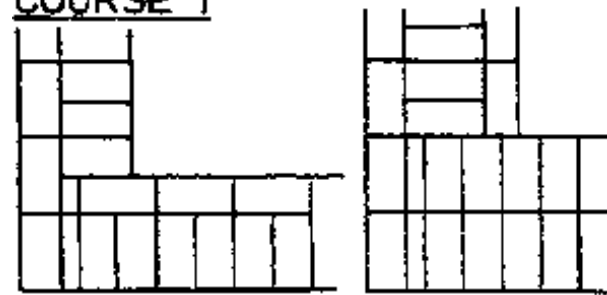

COURSE 2

1 1/2 BRICK - 2 BRICKS - ENGLISH BOND

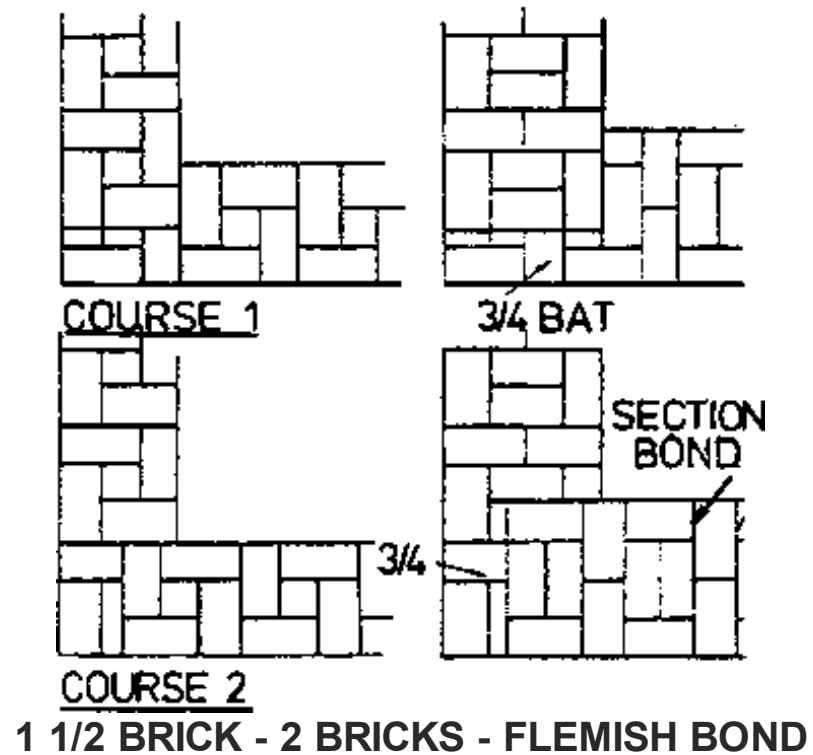

6.5.11 QUOINS OR EXTERNAL ANGLES

- There are two forms of quoins:

- right-angled (or square) quoins and
- sauint quoins.

- A right-angled quoin is formed by two walls which meet at 90°, squint quoins are of two forms:

(a) obtuse quoins (internal angle greater than 90°)

(b) acute squint quoins (internal angle less than 90°).

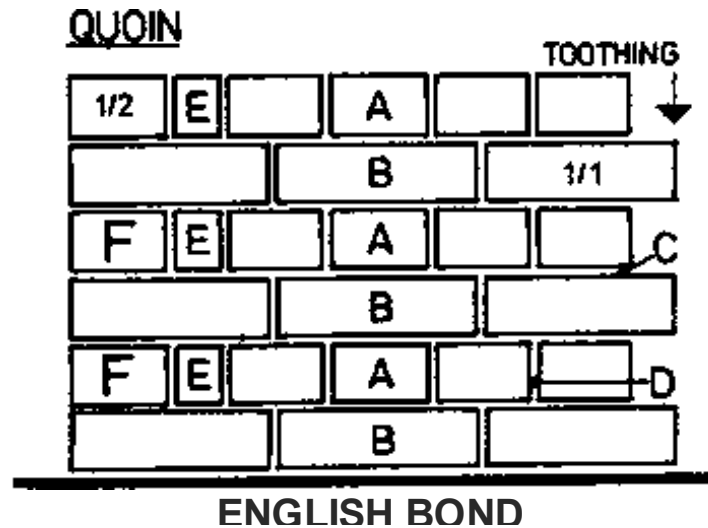
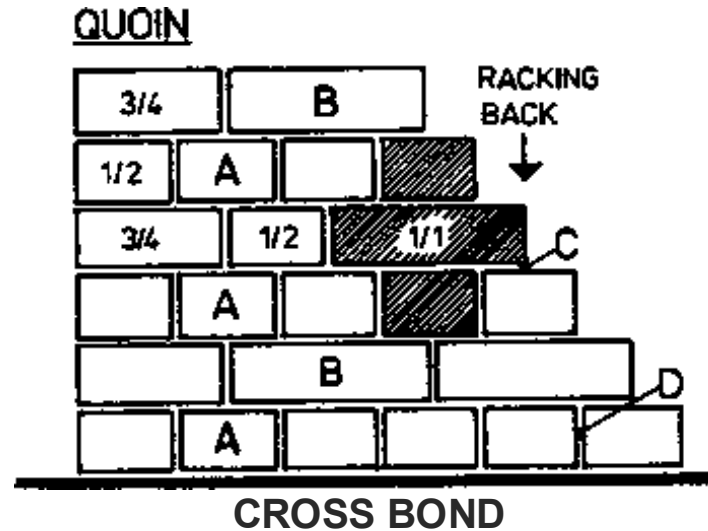

6.5.12 PIERS

Piers (also known as pillars or columns) of - brickwork are adopted either to support concentrated loads or to strengthen walls. Such piers maybe isolated (detached) or attached to walls.

- The keyplan below shows a portion of a building in which piers are employed.

(A) detached piers

(B) attached piers.

6.5.12.1 Detached piers:

Detached piers: may be either square, rectangular, circular or polygonal on pla. The figures below show some alternate details of detached piers

(1) English bond

(2) Double flemish bond

Piers may be formed with rounded arrises by using bull- nose bricks.

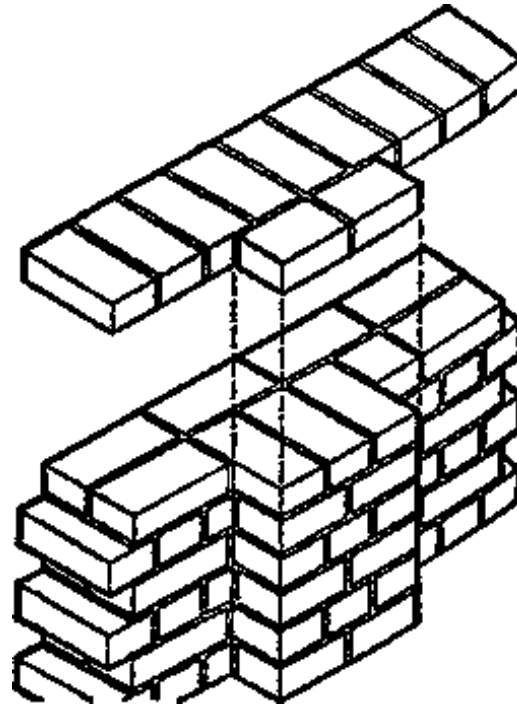

Pier in English bond

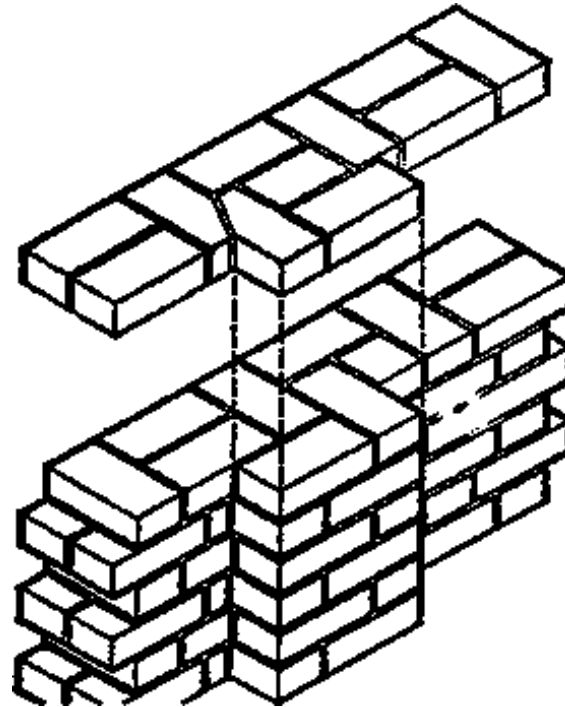

Pier in Flemish bond

6.5.12.2 Attached Piers (or Pilasters)

The figures below show some alternate plans of attached piers.

(1) English bond

(2) Double flemish bond.

The width of a pier is usually a multiple of 112 mm and the projection may be either 112 mm, 225 mm or upwards.

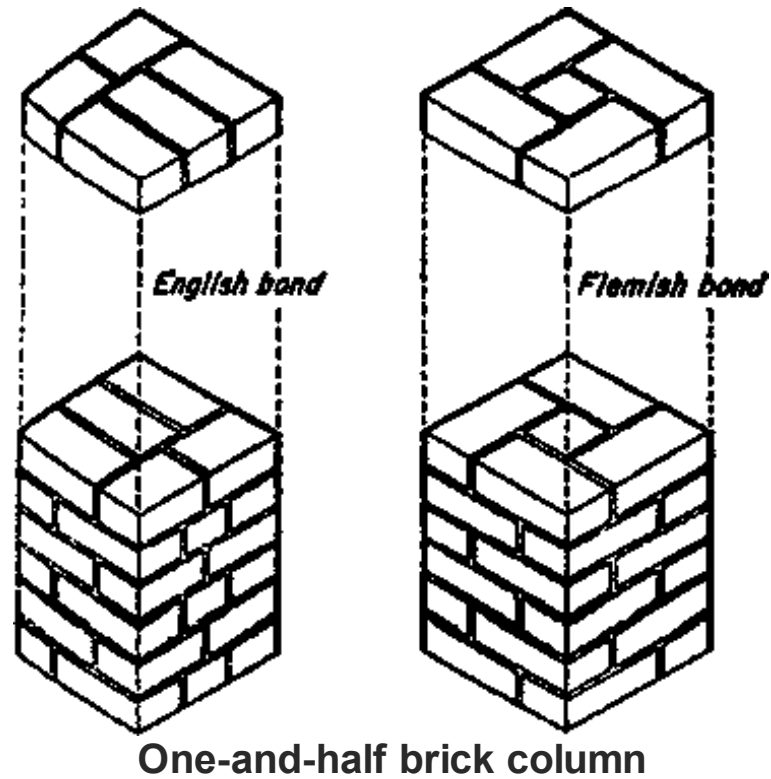

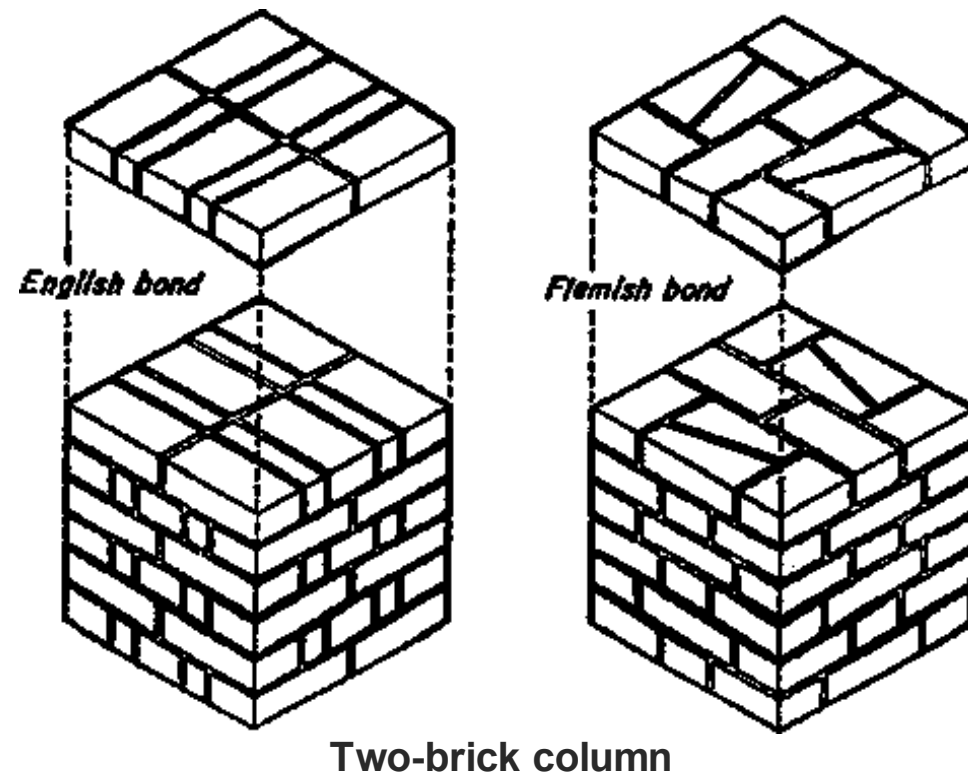

6.5.12.3 Buttresses

BUTTRESSES are piers which are provided to resist thrusts from roof trusses or to strengthen boundary walls, etc.

- Examples of buttress cappings are illustrated in the fig. below.

STOPPED ENDS

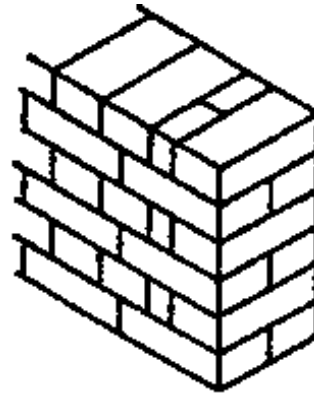

1-BRICK WALL - ENGLISH BOND

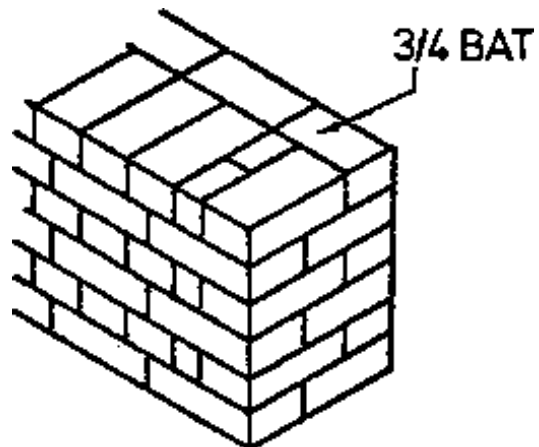

1 1/2-BRICK WALL - BOND ON THE END NOT VISIBLE - ENGLISH BOND

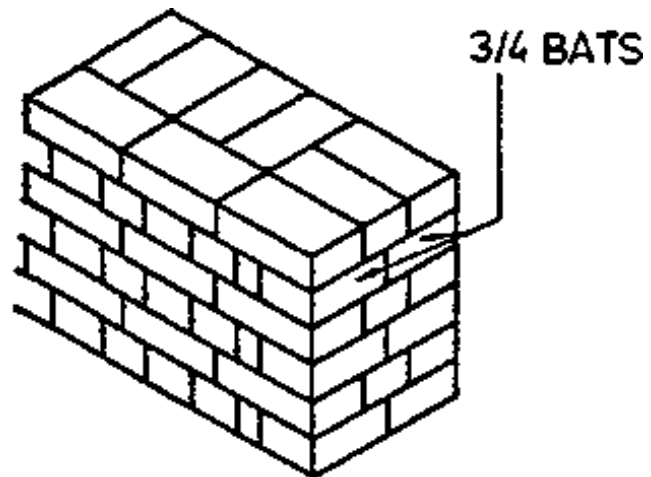

1 1/2-BRICK WALL - BOND ON THE END VISIBLE - ENGLISH BOND

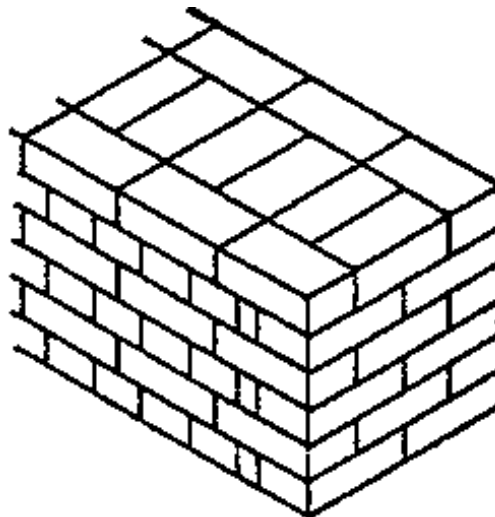

2-BRICK WALL - BOND ON THE END NOT VISIBLE - ENGLISH BOND

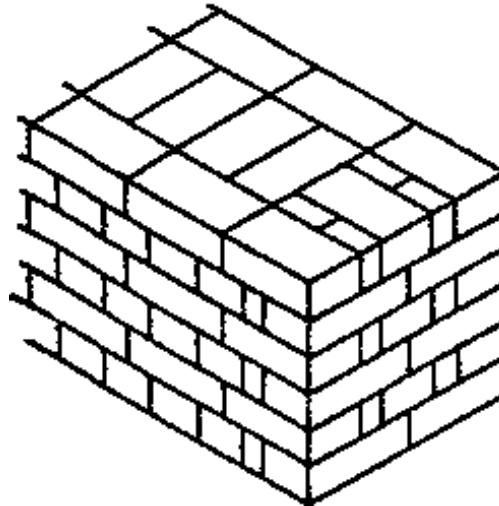

2-BRICK WALL - BOND ON THE END VISIBLE - ENGLISH BOND

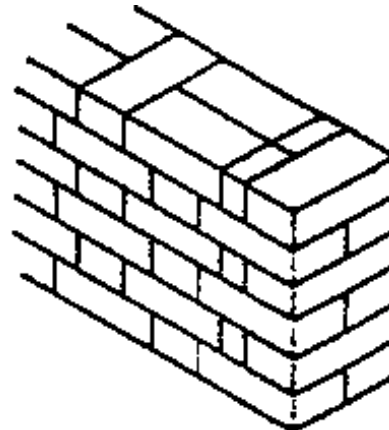

1-BRICK WALL - FLEMISH BOND

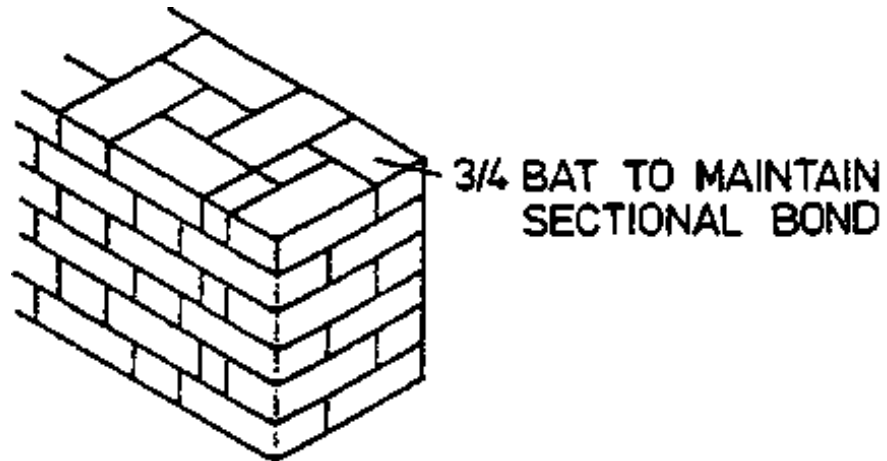

1 1/2-BRICK WALL - FLEMISH BOND

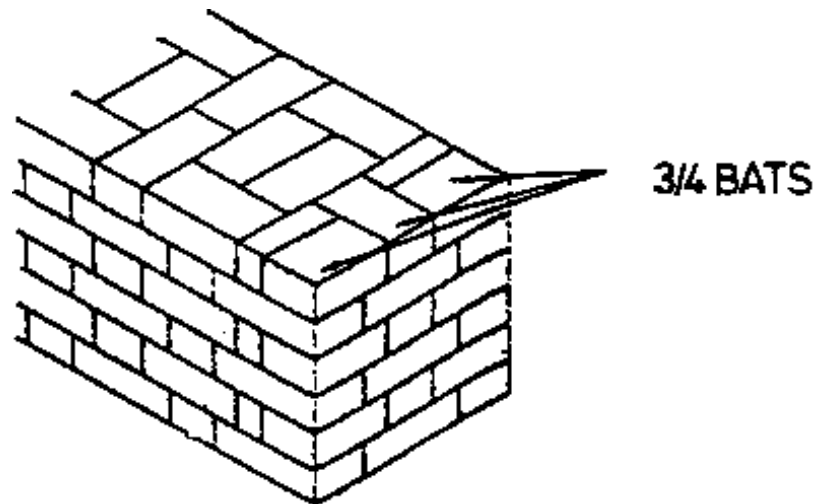

2-BRICK WALL - FLEMISH BOND

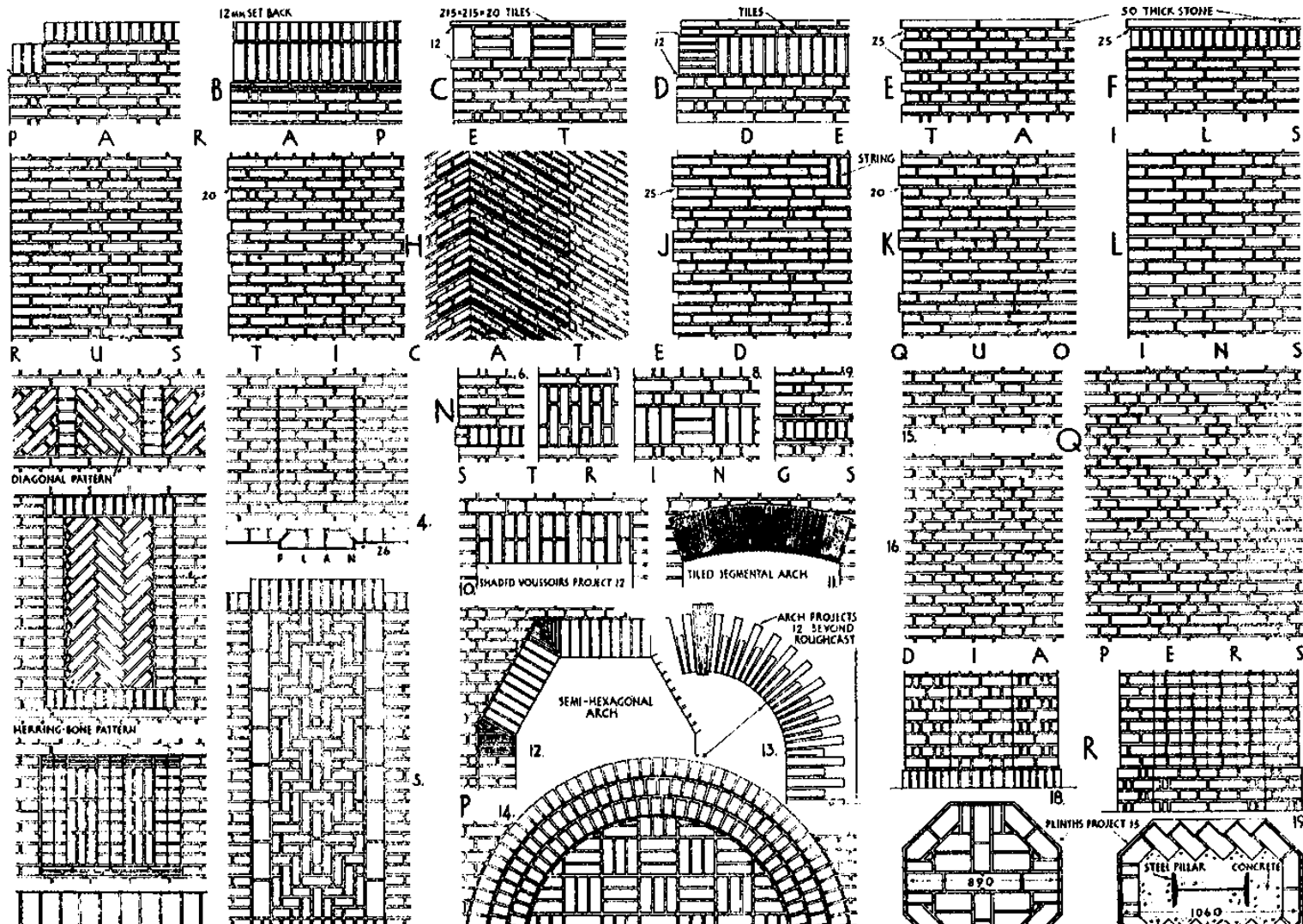

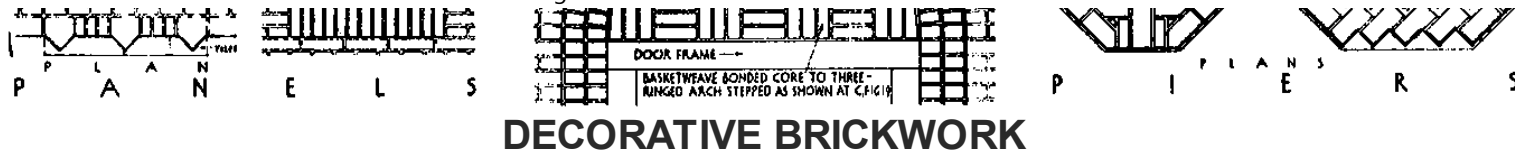

Joint and pointing

- These terms are used for the finish given to both the

- vertical and
- horizontal joints in brick work

irrespective of whether the wall is of brick, block, solid or cavity construction.

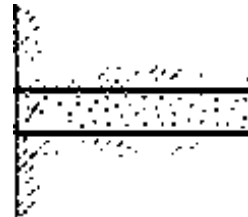

Flush Joint

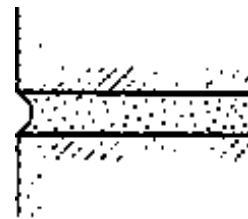

Keyed Joint

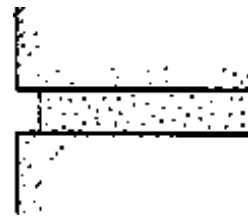

Recessed Joint

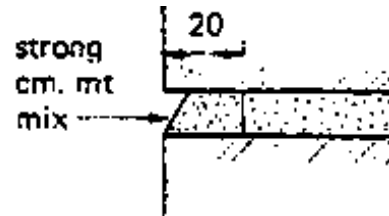
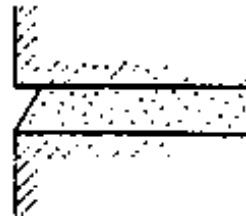
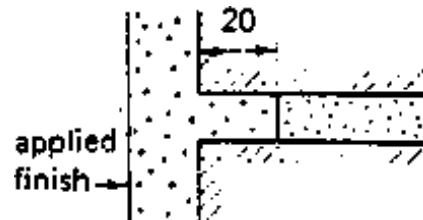
Recessed Joint**Weathered Pointing****Weathered Joint****Raked Out Joint**

- Jointing is the finish given to the joints when carried out as the work proceeds.

- Pointing is the finish given to the joints by raking out to depth of approx. 20mm and filling in on the face with a hard setting cement mortar which could have a colour additive.

This process can be applied to both new and old buildings.

6.6 BLOCKWORK

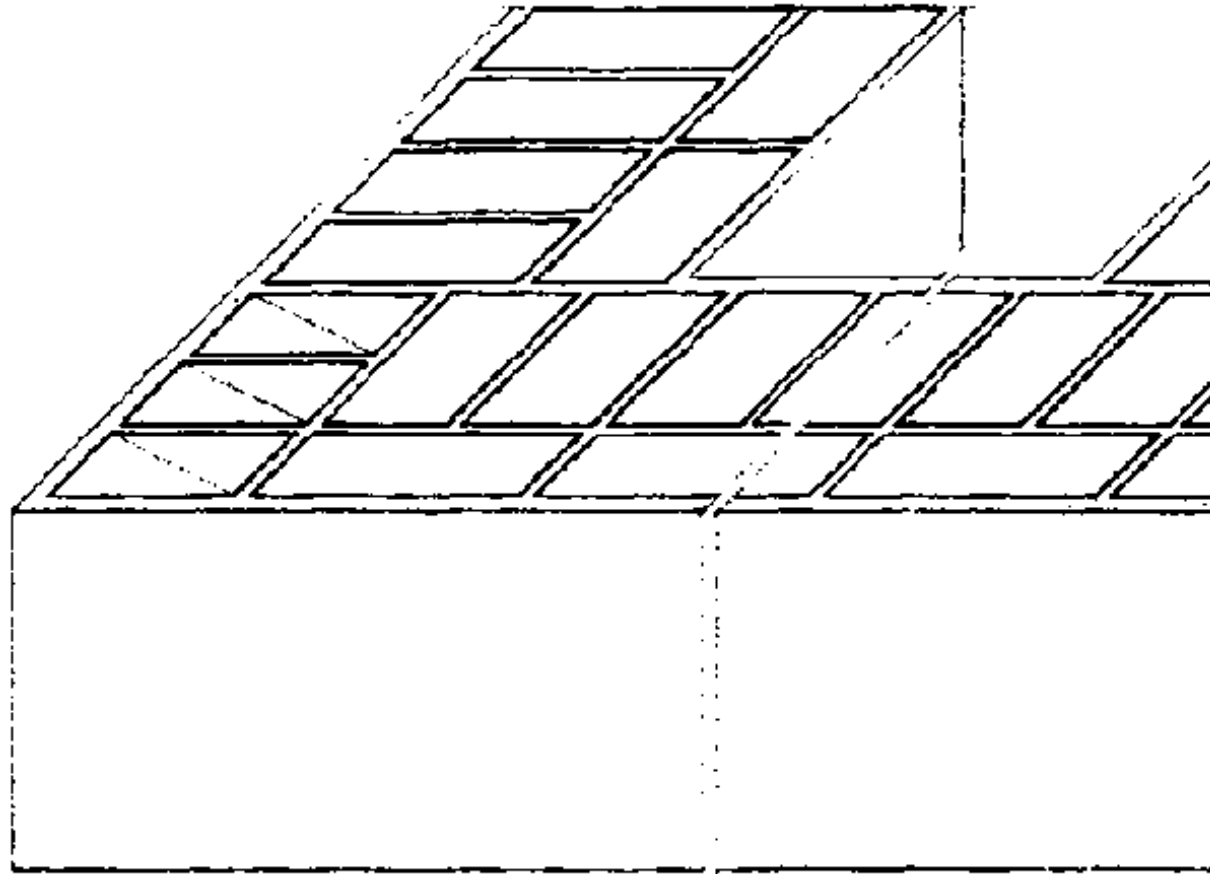

- A block is defined in BS 2028 as a walling unit exceeding the dimensions specified for bricks given in BS 3921 and that its height shall not exceed either its length or six times its thickness to avoid confusion with slabs or panels. Blocks are produced from clav. precast concrete and aerated concrete.

6.6.1 CLAY BLOCKS

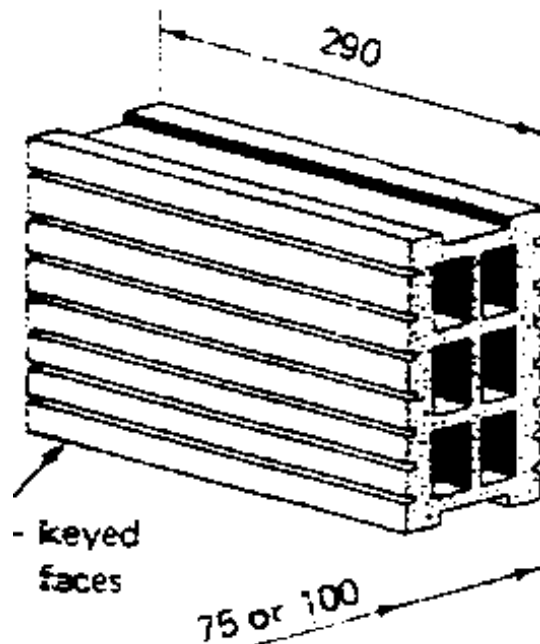

Standard Block



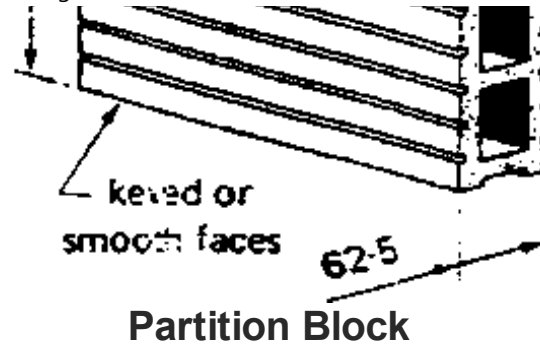

- These are covered by BS 3921 which gives a format size of 300 x 225 x 62.5; 75, 100 or 150 mm wide. These blocks, which are hollow, are made by an extrusion process and fired as for clay bricks. The standard six cavity block is used mainly for the inner skin of a cavity wall, whereas the three block is primarily intended for partition work. Special corner, closer, fixing and conduit blocks are produced to give the range good flexibility in design and layout. Typical details are shown in Fig. 11.19.

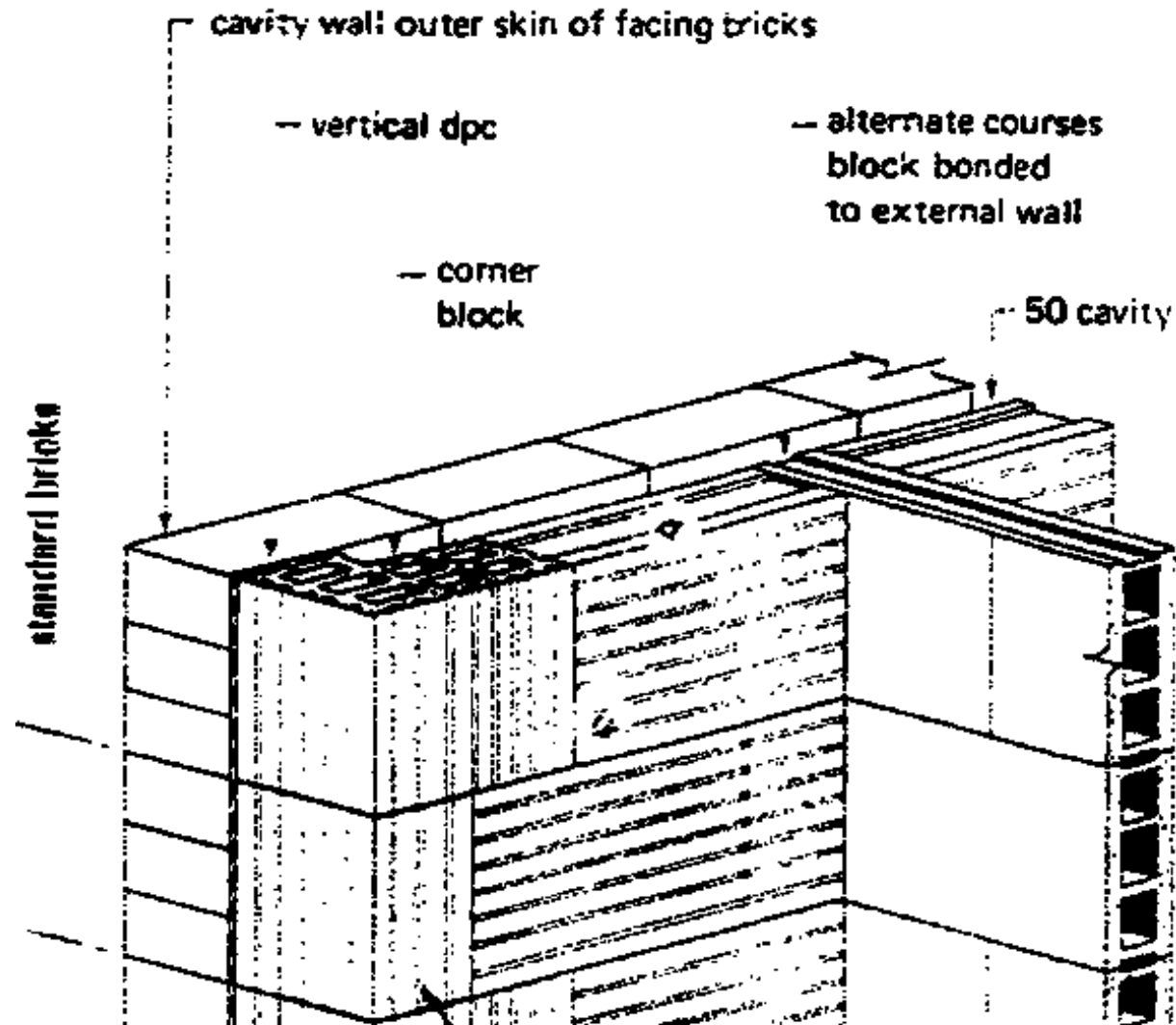

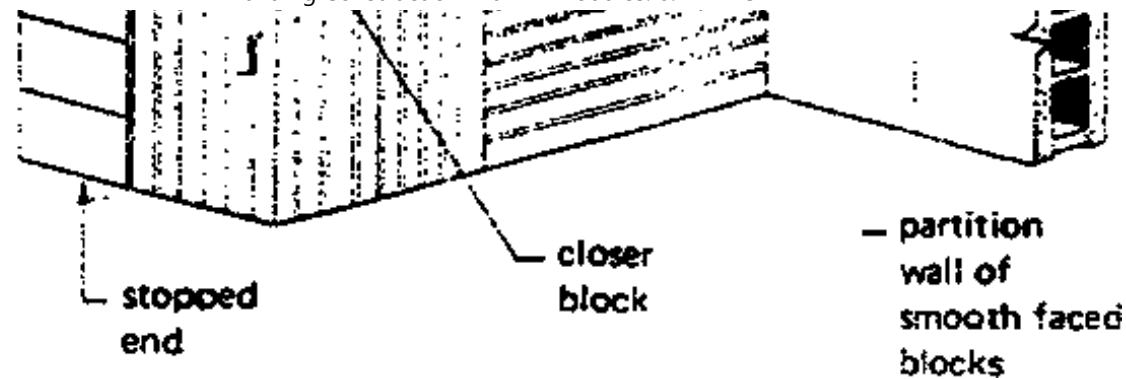

6.6.2 PRECAST CONCRETE BLOCKS

- The manufacture of precast concrete and aerated concrete blocks is covered by B.S.2028: 1364- which gives three types:

Type A: for general use in buildings including the use below B.L. - D.P.C. Suitable aggregates are dense aggregates such as crushed gravel, crushed slag, broken brick.

Type B: for general use in buildings. Lightweight concrete blocks for load bearing walls. Suitable, aggregates include

- sintered pulverized fuel ash,
- foamed slag
- expanded clays and shalls
- furnace clinker
- expanded vermiculite and aerated concrete.

Type C: = similar to Type B but are intended for non load bearing walls.

6.6.3 AERATED CONCRETE BLOCKS

- Aerated concrete for blocks is produced by introducing air or gas into the mix so that when set a uniform cellular block is formed.
- The usual method: A controlled amount of aluminium powder to the mix reacts with the free lime in the cement to give off hydrogen which is quickly replaced by air and so provides an aeration.



Keyed Surface Block

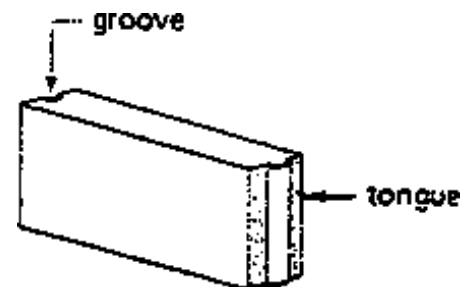

Solid Block

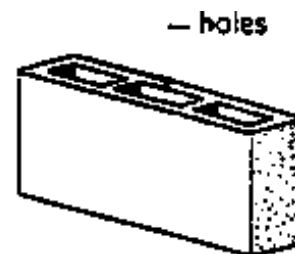

Hollow Block

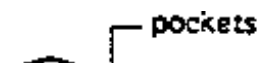

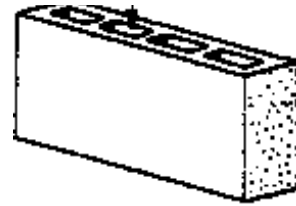

Cellular Block

- Precast concrete "blocks are manufactured to a wide range of standard sizes. The most common face format sizes are:

- 400 x 200 mm and
- 450 x 225 mm

with a thickness of 75/100/140/215 mm. (Typical details: Fig. II.20)

- Concrete blocks are laid in stretcher bond, and are joined to other walls by block bonding or leaving metal ties or strips projecting from suitable bed courses. The mortar again should be weaker than the material of the walling unit. (1:2:9 gauged mix. for work above G.L.)

- Concrete blocks shrink on drying out. They should not be laid until the initial drying shrinkage has taken place. (About 14 days) and should be protected on site to prevent them becoming wet, expanding and causing subsequent shrinkage possibly resulting in cracking of the blocks and any applied finishes (such as plaster).

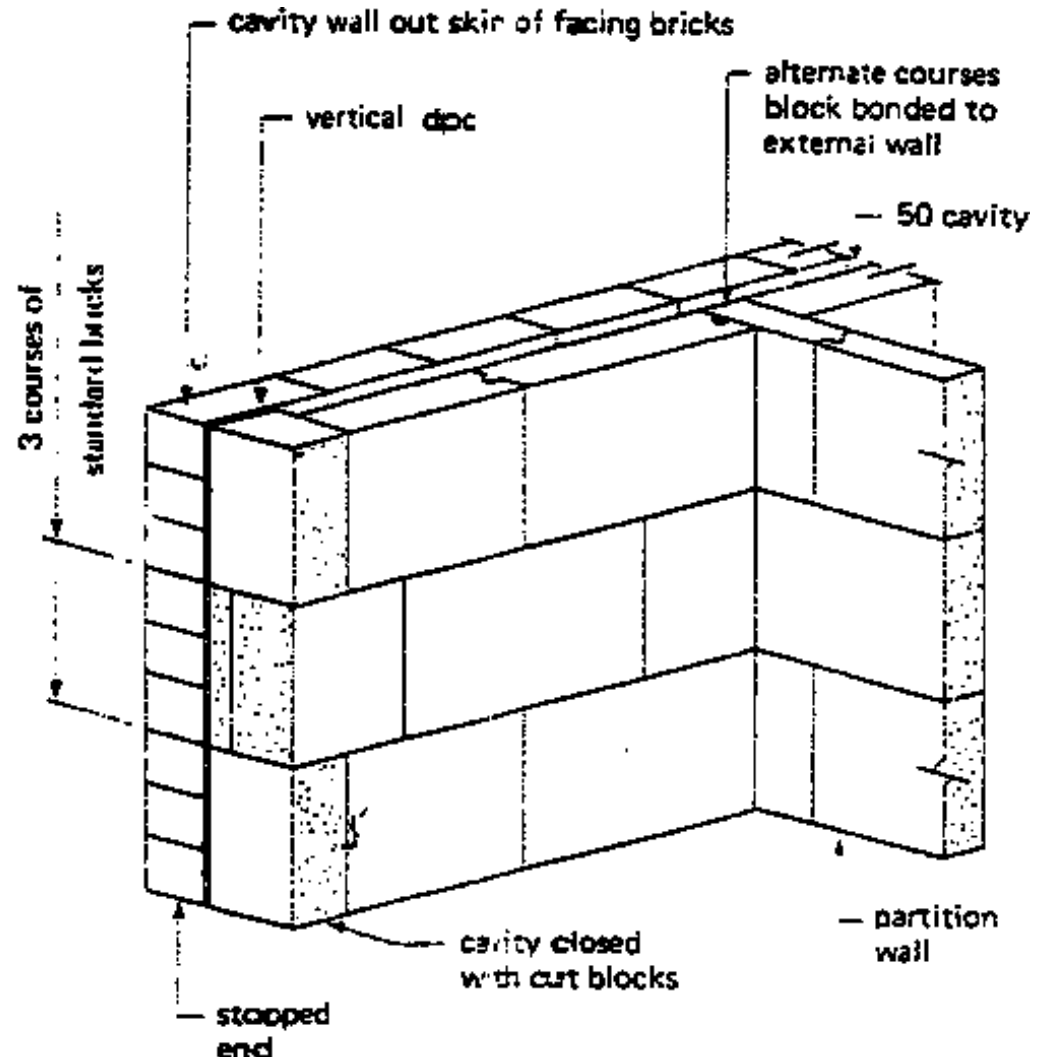

- The main advantages of block- work over brickwork are:

1. Labour saving - easy to cut, larger units.
2. Easier fixings - most take direct fixing of screws and nails.
3. Higher thermal insulation properties.
4. Lower density.
5. Provide a suitable key for plaster and cement rendering.

- The main disadvantages are:

1. Lower strength.
2. Less resistance to rain penetration.
3. Load bearing properties less (one-or two-storey application.)
4. Lower sound insulation properties.

EXAMPLES: CORNERS & TEE-JUNCT's in BLOCKWORK-BONDING



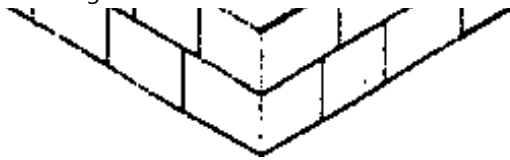

CORNER: 30 in 30 cm wall

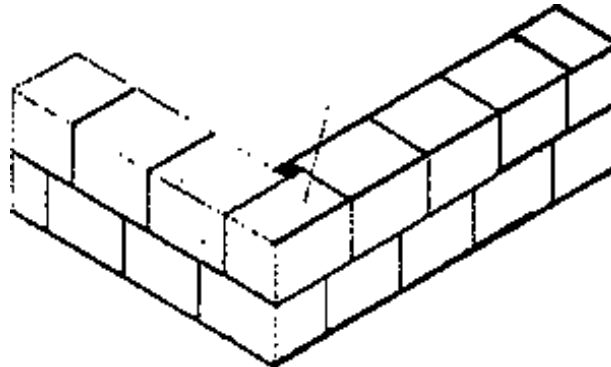

CORNER: 30 in 30 cm wall

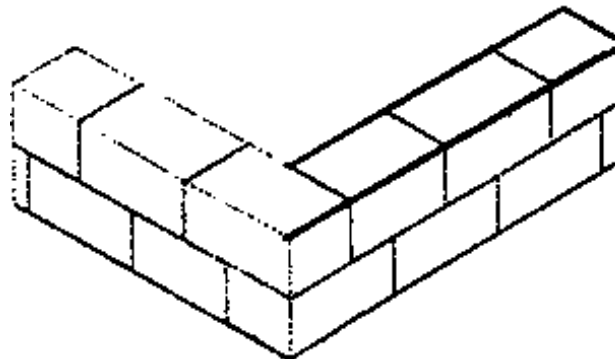

CORNER: 30 in 30 cm wall



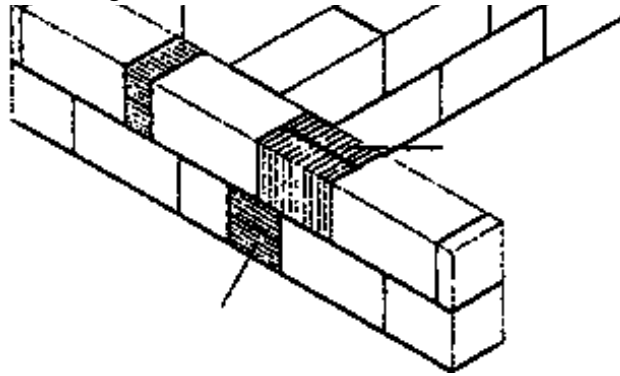

TEE-JUNCTION: 24 in 24 cm wall

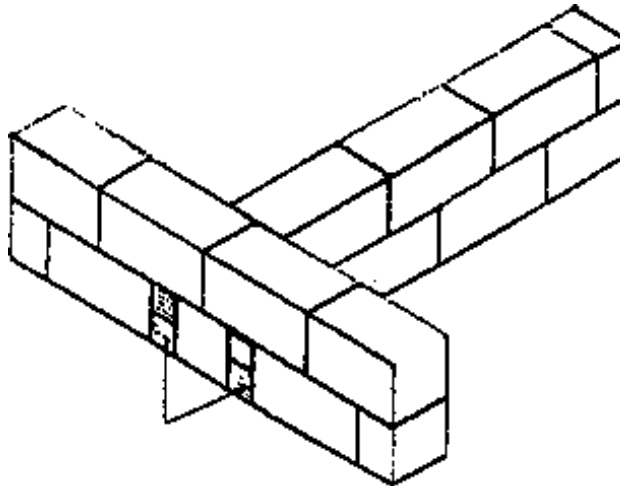

TEE-JUNCTION: 24 in 24 cm wall

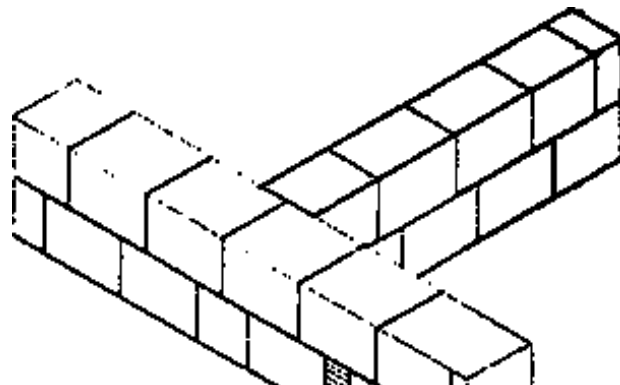



TEE-JUNCTION: 24 in 24 cm wall

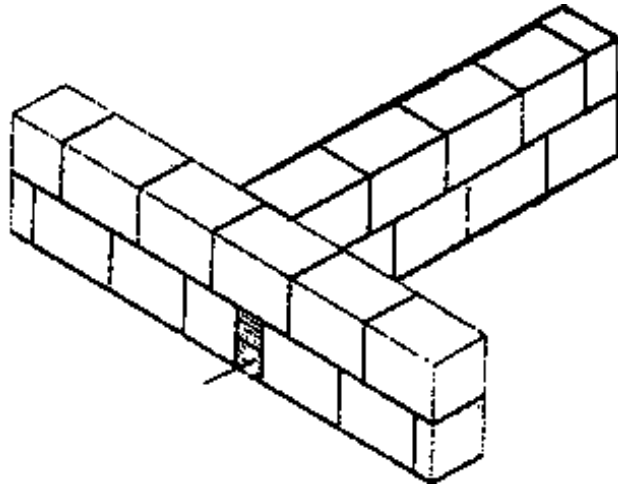

TEE-JUNCTION: 24 in 24 cm wall

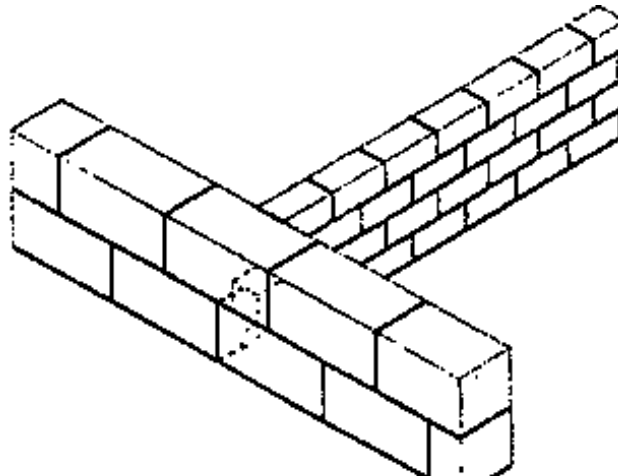

TEE-JUNCTION: 11⁵ in 24 cm wall

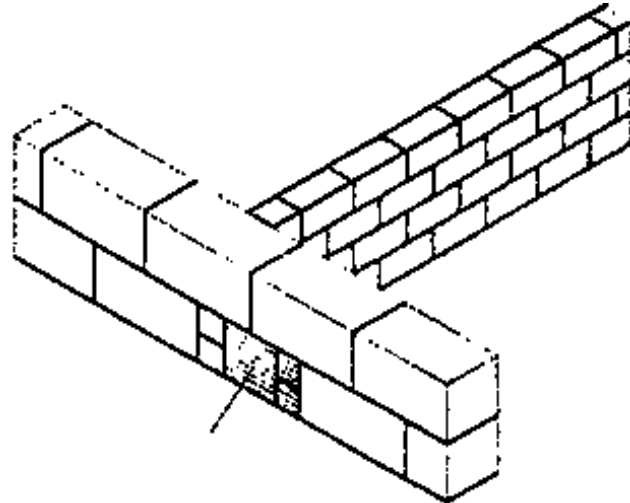

TEE-JUNCTION: 11⁵ in 24 cm wall

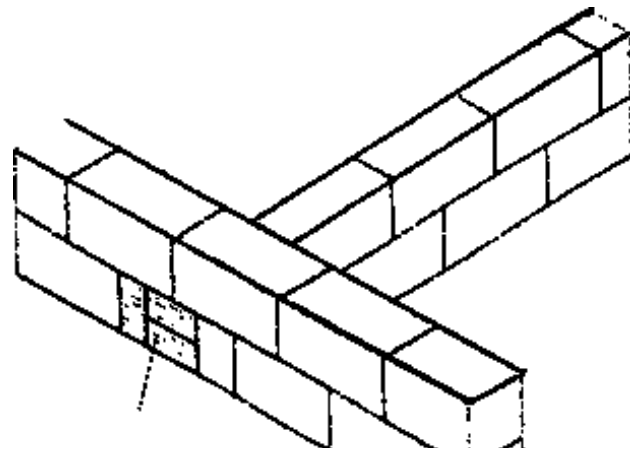

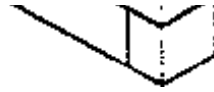

TEE-JUNCTION: 17⁵ in 24 cm wall

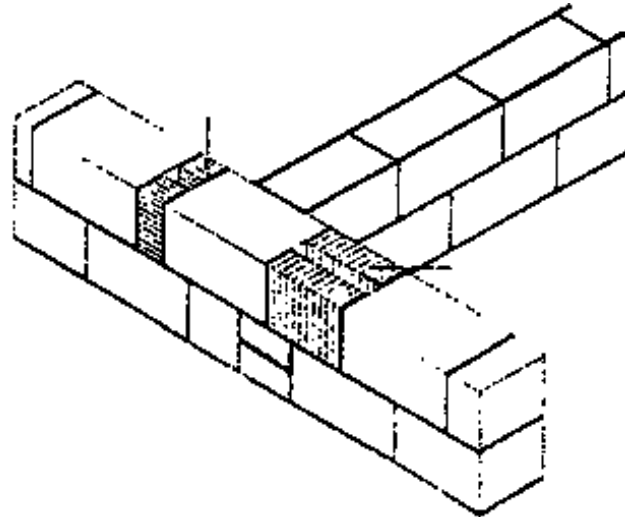

TEE-JUNCTION: 24 in 30 cm wall

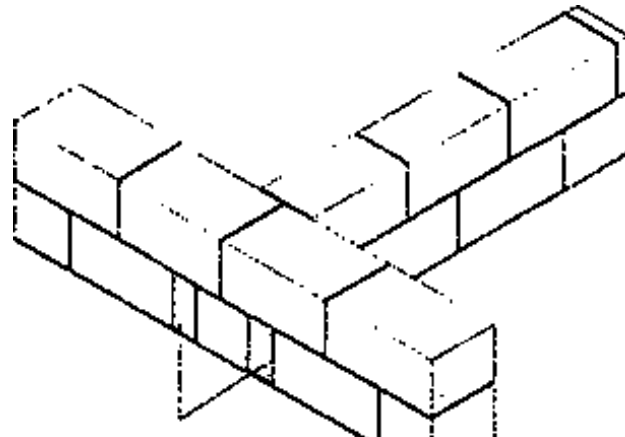



TEE-JUNCTION: 24 in 30 cm wall

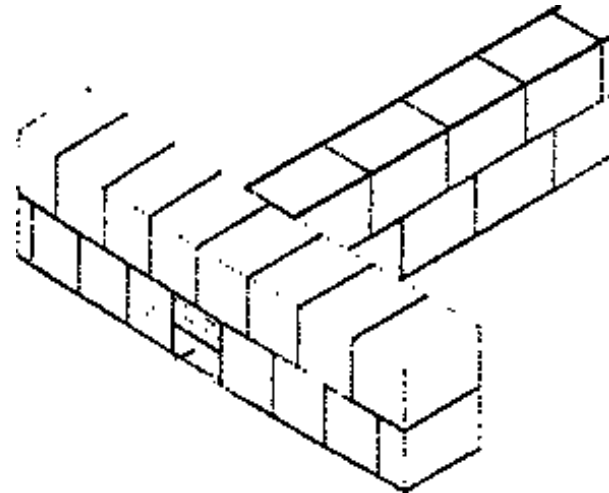

TEE-JUNCTION: 24 in 36⁵ cm wall

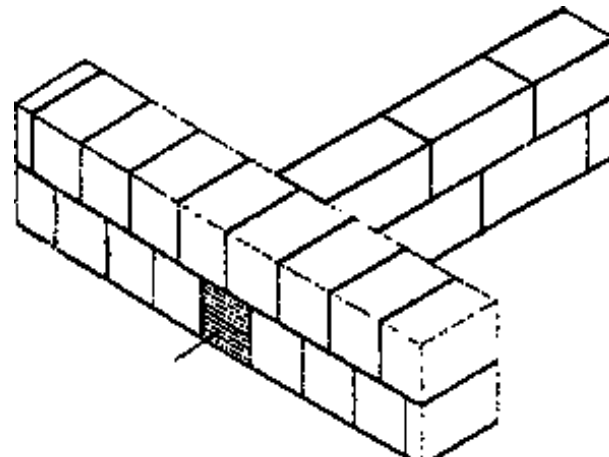

TEE-JUNCTION: 24 in 36⁵ cm wall

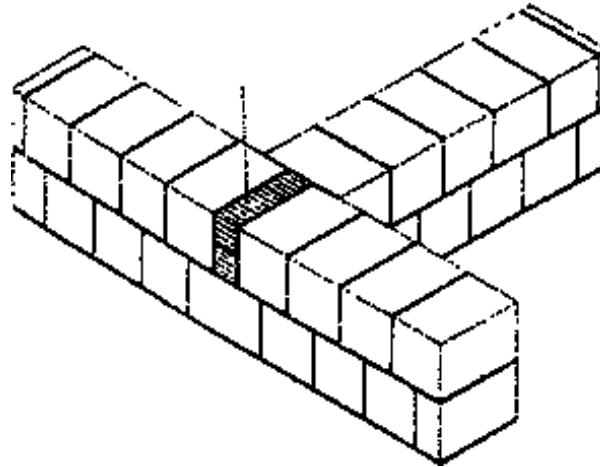

TEE-JUNCTION: 36⁵ in 36⁵ cm wall

6.7 CONCRETE WALLS

6.7.1 GENERAL

- Concrete Walls may be broadly classified as:

- Plain monolithic concrete walls.
- reinforced concrete walls

The later can be subdivided into:

- in-situ cast external walls
- concrete box frame &
- pre-cast panel structures.

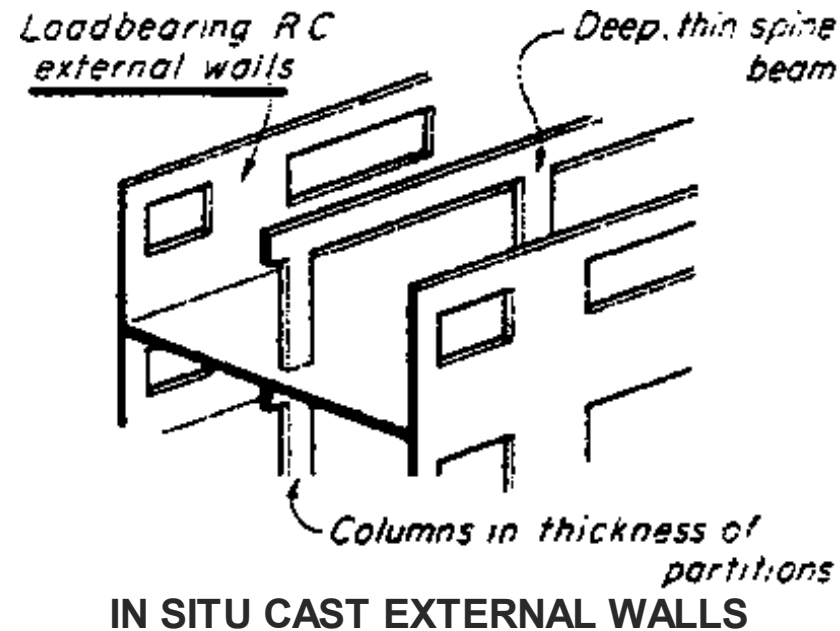

- A well graded and carefully mixed and placed Cement Concrete Wall can be impervious to water:
 - small areas can be quite water proof
 - with larger areas problems of cracking arise due to shrinkage and thermal movements and to possible settlement.

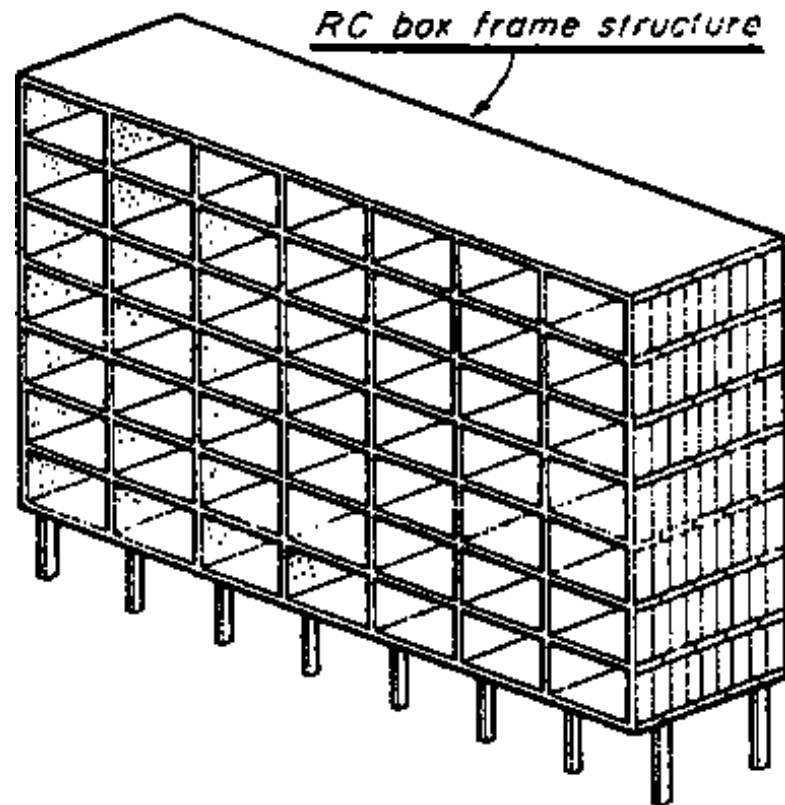

BOX FRAME STRUCT.

- Precautions against cracking are taken by controlling shrinkage and moisture movement by:

- **steel reinforcement**

- by allowing for thermal movement by means of expansion joints and
- by careful detailing and execution of Construction Joints.

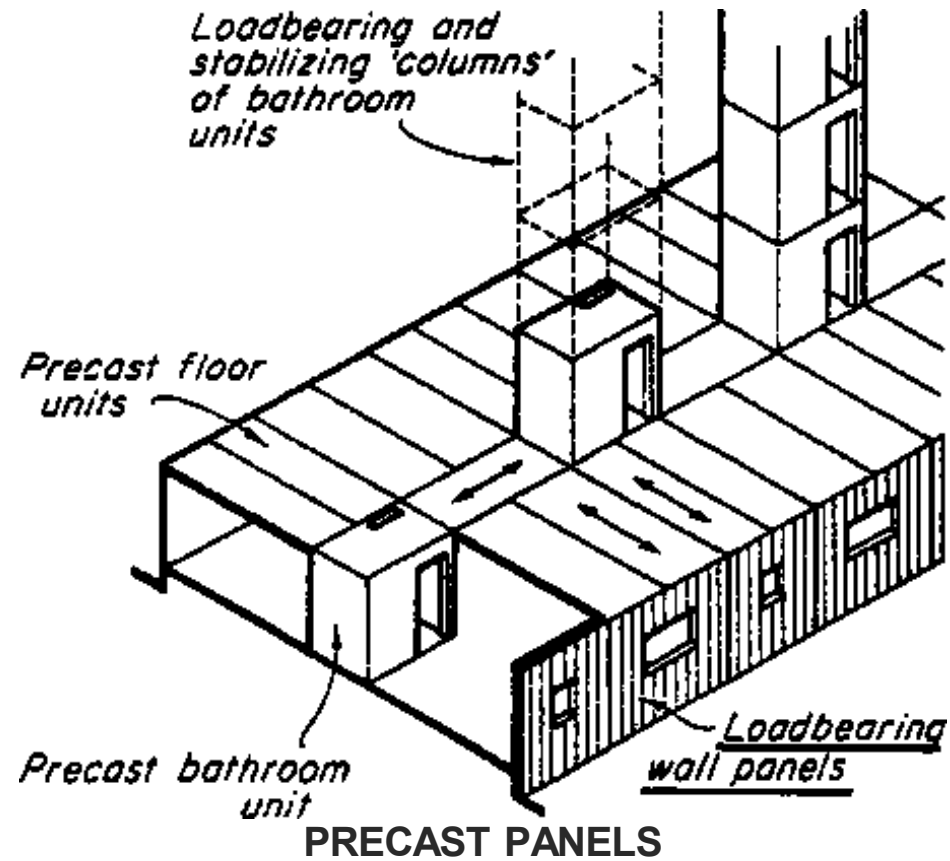

6.7.2 FOREWORK

- **Formwork is required to support the concrete until it is firm.**
- **It has to be strong enough to bear (without sagging, the weight of the concrete as well as the concreting sand and plant used for placing.**
- **The joints of the boards must be tight enough to prevent loss of water and fine material**
- **Easy stripping through proper use of strutting, bolting, nailing and wedging should be possible. In order to resist vibration and movement when the concrete is being placed, extra props may be temporarily inserted under form work. (They can be removed immediately the concrete is in position, and re-erected elsewhere as the work proceeds).**

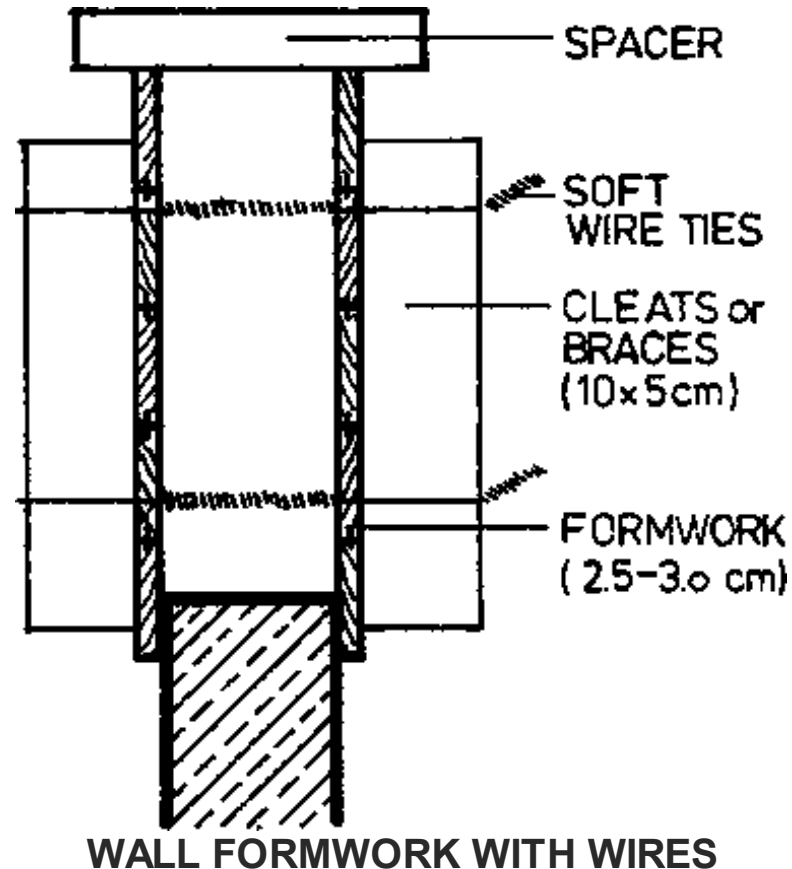

- Adjustable steel props are excellent for this purpose.

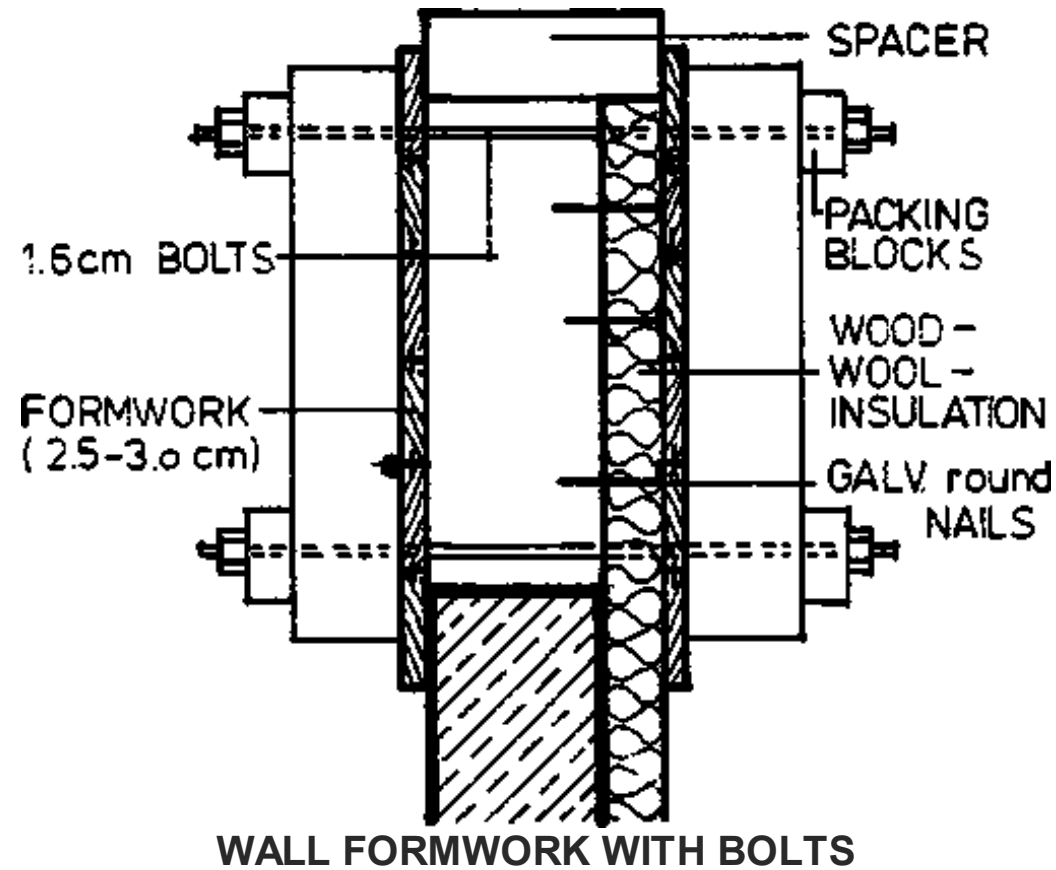

- Formwork is usually of timber, but can be of metal as well.

Retent methods also include

- Potent methods also include

- plastic
- wood fibre
- metal ceiling panels
- precast concrete panels

- Permanent steel tubular scaffolding may also be used as a support for shuttering.
- Metal formwork must be cool when concrete is being placed.
- There are a number of systems of WALL-Formwork available (in wood, steel, concrete, etc.)

Straight foreword methods are shown in the figure.

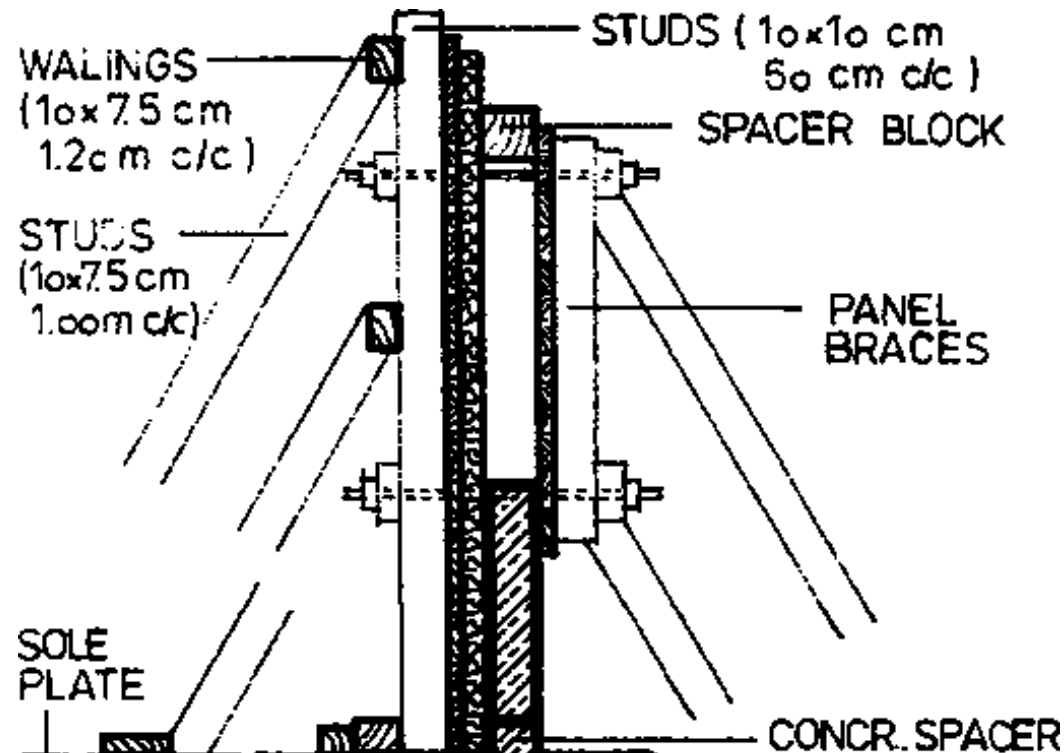

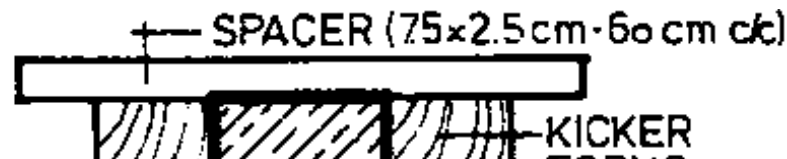
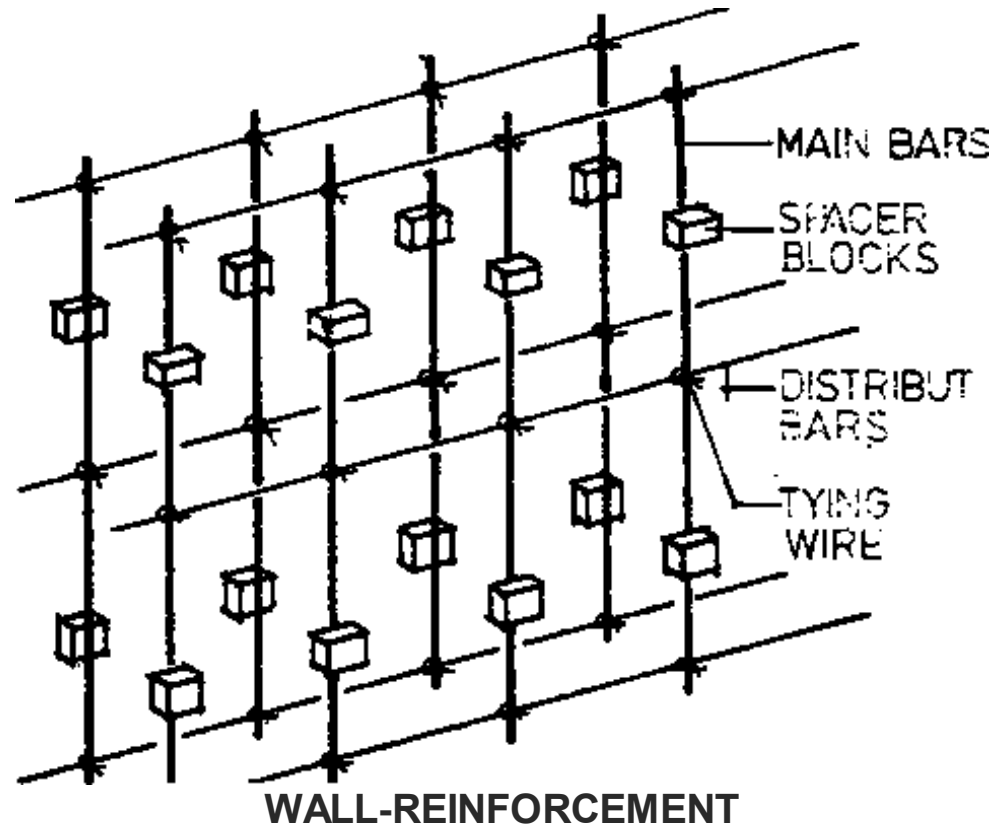

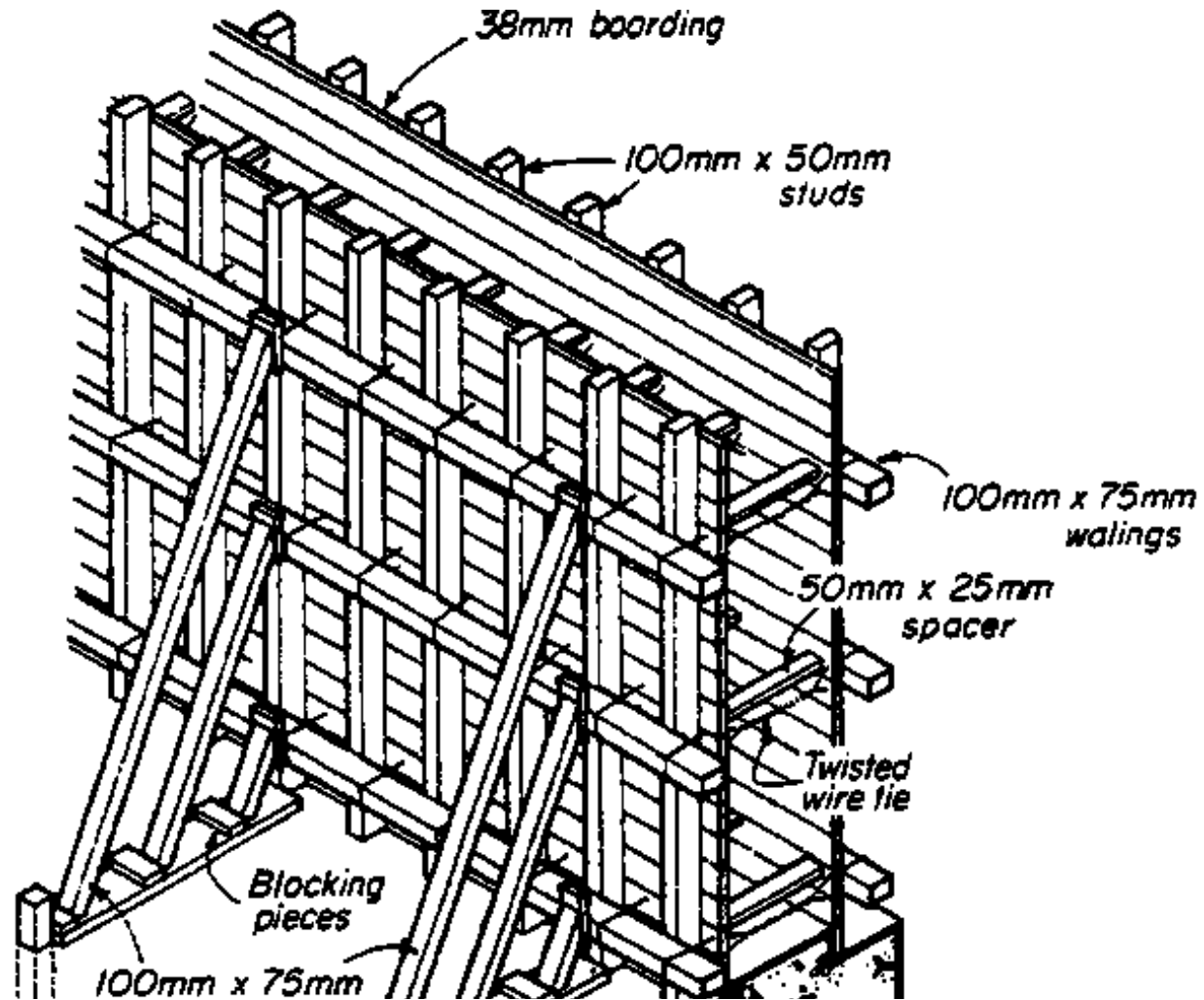
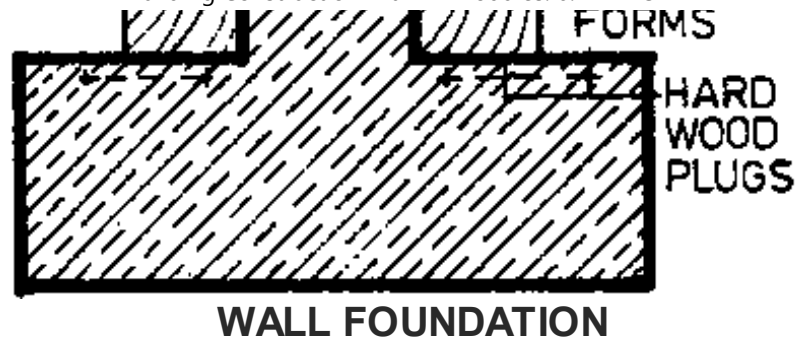

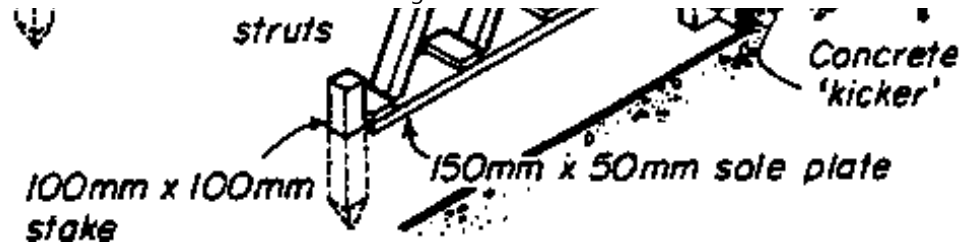

A Wall form

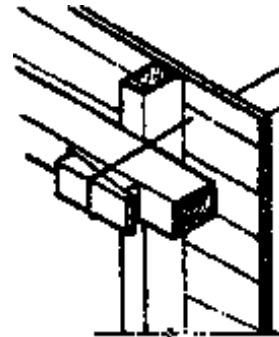

B Wedged wire tie

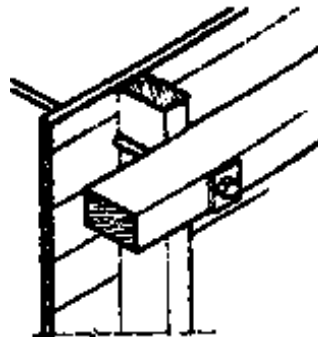

C Bolt tie

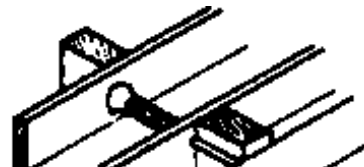

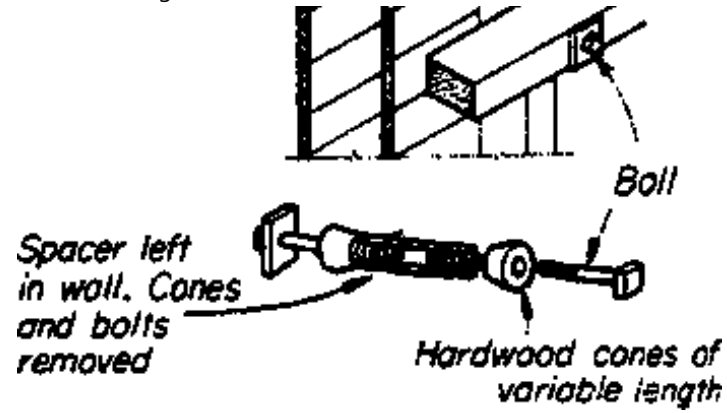

D Steel tie-spacer

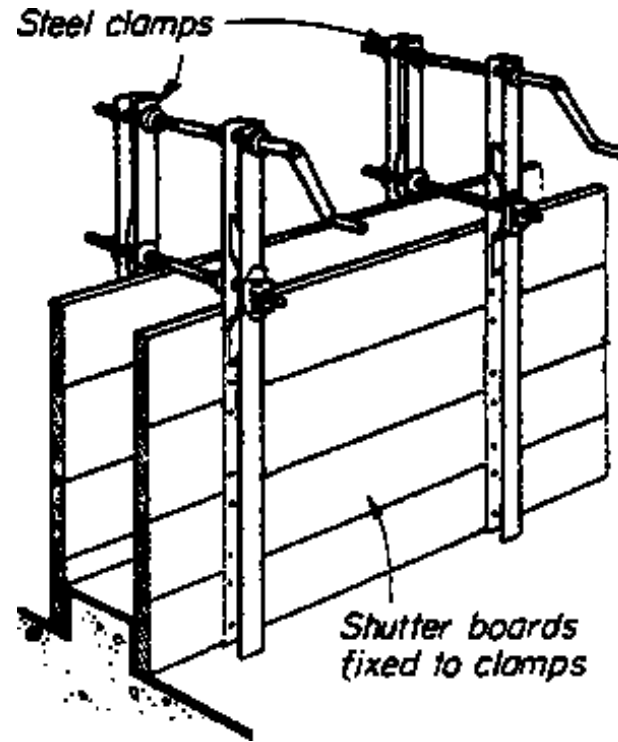

Wall clamps

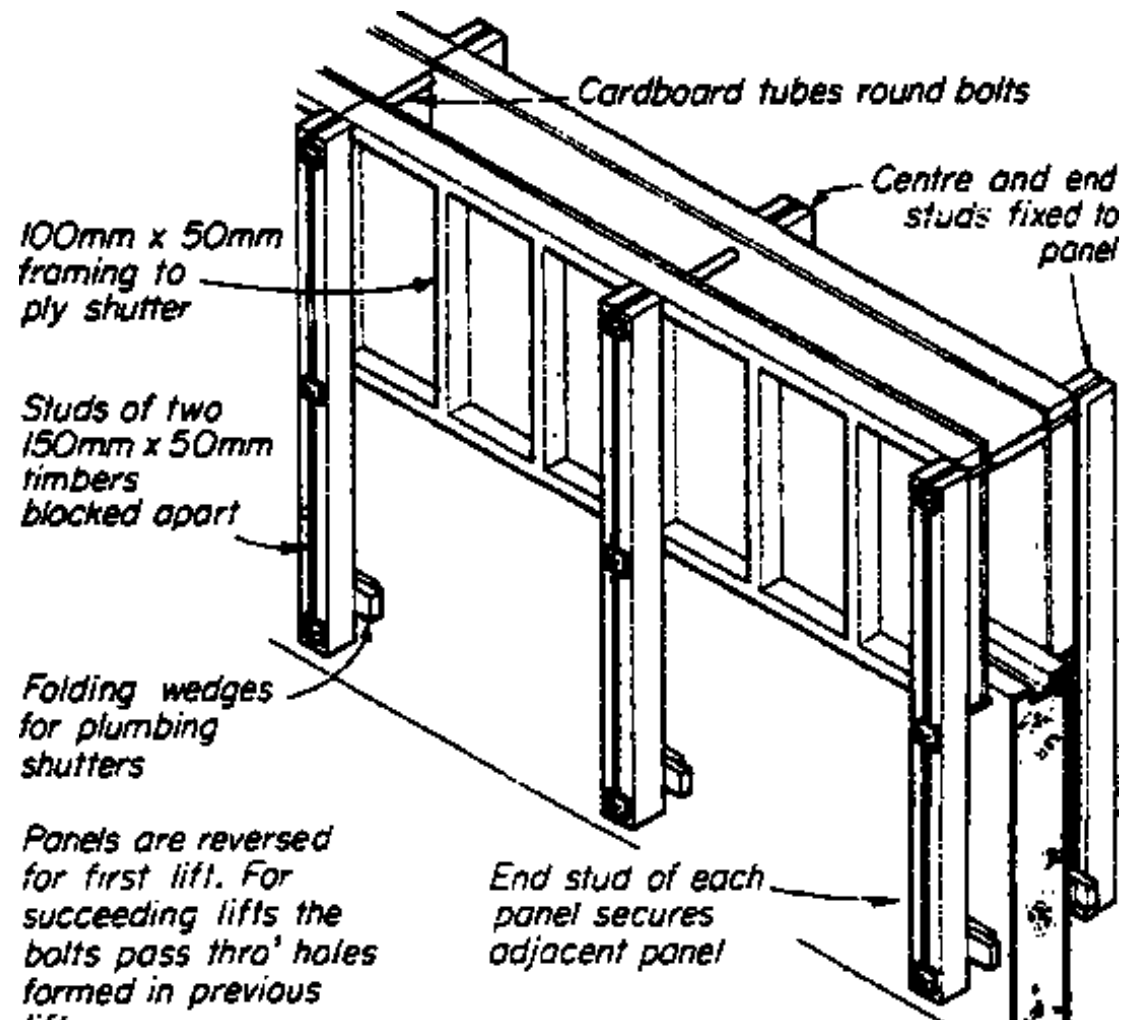



Moving wall form Moving wall form

STEEL

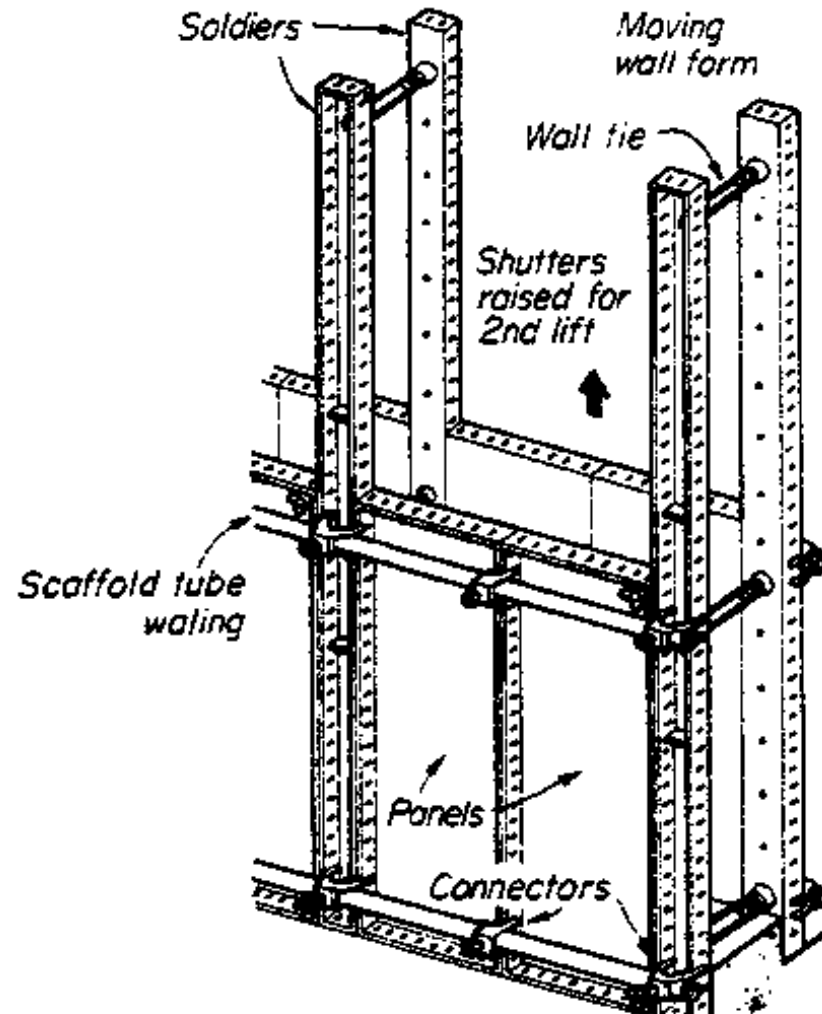



Slip forms or sliding shutters

For the rapid construction of constant section walls it is possible to use a continuously rising form, usually known as a slip form or sliding shutter. By this means work may proceed continuously, the shutter rising from 150 to 300 mm per hour depending upon the rate of hardening of the concrete, since the cast concrete very rapidly becomes self-supporting. The form is about 900 mm or 1.20 m deep, fixed to and held apart by timber or steel frames or yokes, as shown in figure 260 A, B. On top of each yoke is fixed a hydraulic jack, through which passes a high tensile steel jacking rod, about 25 mm in diameter, which is cast into the wall as it rises. The jack contains a ram and a pair of upper and lower jaws which can grip the jacking rod and it works in cycles, each cycle giving a rise of about 25 mm. The jack works against the lower jaws to raise the yoke and the form with it. When the pressure is released, the upper jaws grip the rod and the lower jaws are released and raised under the action of a spring. An alternative to the hydraulic jack is the manually operated screw jack which is also illustrated (C).

A working deck is constructed level with the top of the form, from which is usually suspended a hanging scaffold from which the concrete may be inspected and rubbed down as it leaves the shutters.

CONNECTORS

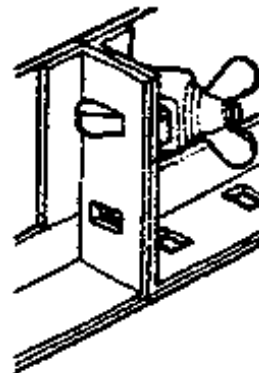



PANEL TO PANEL

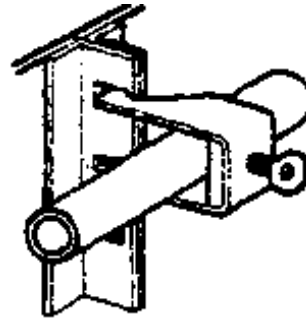

PANEL TO WALING

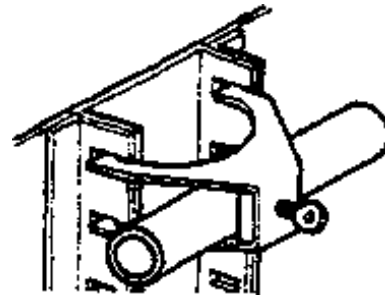

SOLDIER TO WALING

SLIP FORMS

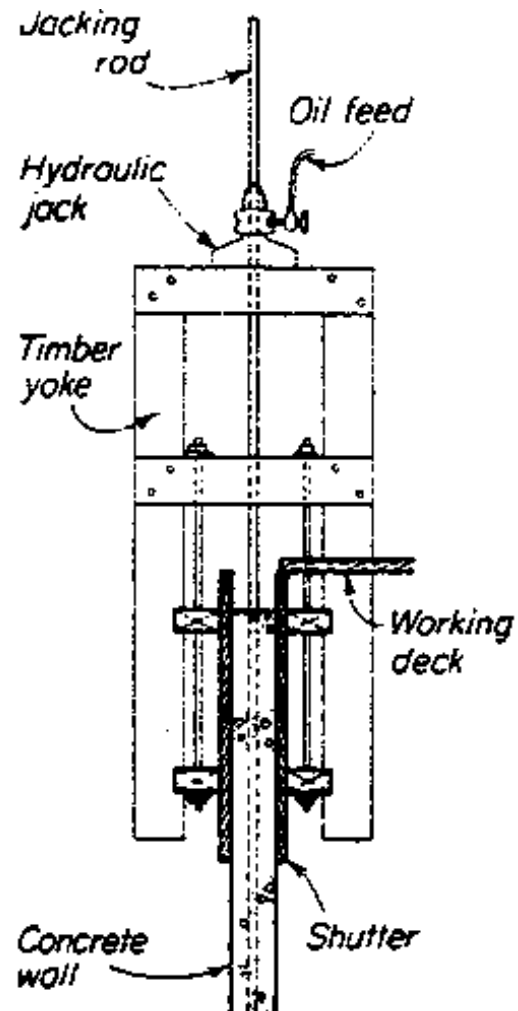

A Timber yoke

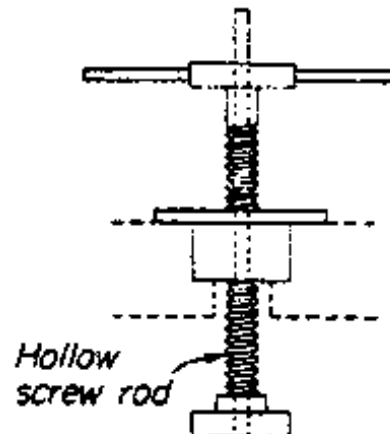
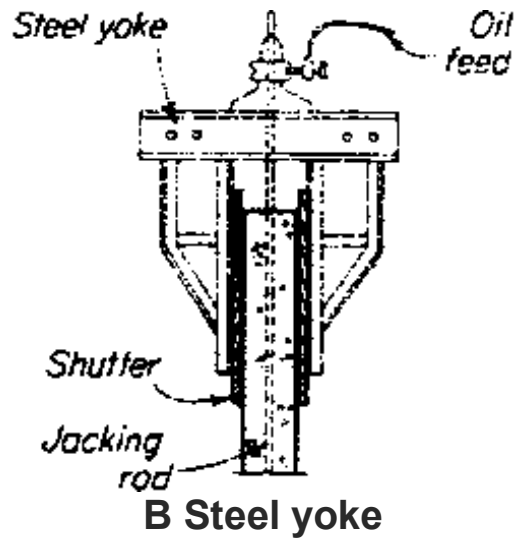



6.7.3 PLAIN MONOLITHIC CONCRETE WALL

- The term 'monolithic' has been taken from the Greek language:

mono = single (
litho = stone

Therefore a 'monolithic wall' is erected without any joints (like brick or blockwalls) having a structure like a rock or a 'single stone'

- The ideal material for such a 'monolithic' construction is concrete, (or reinforced concrete)

- The Plain monolithic concrete wall means a wall of cast in-situ concrete containing no reinforcement - either of normal, nonfines or light weight concrete.

- As with reinforced concrete walls they are most economic when used both to support & to enclose or divide, provided they are at reasonably close spacing. That is to say, up to about 5.5 m apart. They are, therefore, used mainly for housing of all types, both as external and internal loadbearing walls, when low building costs can be attained.

- Dense concrete is generally used for high buildings although no-fines concrete has been used for heights up to ten storeys in this country. In Europe blocks as high as 20 storeys have been constructed with no-fines load-bearing walls more cheaply than with a frame.

- Plain monolithic concrete walls suffer certain defects which, in some respects, makes them less suitable as external walls than other types. With normal dense aggregates the thermal insulation is low and the appearance of the wall surface may be unsatisfactory, requiring some form of finishing or facing. In addition the unreinforced concrete wall, and particularly the no-fines wall, is unable to accommodate itself to unequal settlement as does a reinforced wall by virtue of the reinforcement or a brick or block wall to a certain extent by the setting up of fine cracks in the joints. Thus, as a result, large cracks tend to form in the wall. Nevertheless, where foundations are designed to reduce unequal settlement to a minimum such walls can successfully be used.

- Aggregates used for dense plain concrete are natural aggregates conforming to the requirements of BS 882, air-cooled blast furnace slag and crushed clay brick. Aggregates for light-weight concretes are foamed slag, clinker, pumice and any artificial aggregate suitable for the purpose. No-fines concrete may be composed of heavy or lightweight aggregate.

6.7.3.1 Dense concrete walls

Dense concrete walls are constructed from concrete made with a well-graded aggregate giving a concrete of high density. The London By-laws require, the thickness of any concrete external or party wall to be not less than 150 mm thick and CP 123, 101, 'Dense Concrete Walls', recommends a similar thickness for external walls.

In most buildings the thickness of any type of plain concrete wall must, by reason of other functional requirements, be thicker than the minimum dictated by loadbearing requirements. An example of this is the dense concrete separating wall, which must be 175 mm thick in order to provide an adequate degree of sound insulation between houses and flats.

6.7.3.2 Light-weight aggregate

Light-weight aggregate concrete walls will give better thermal insulation than dense concrete when used for external walls but care must be taken in the choice of aggregate for external use because of the danger of excessive shrinkage and moisture movement occurring with certain types. Clinker has a corrosive action on steel and should not be used if shrinkage reinforcement is to be incorporated.

All types of light-weight aggregate concrete are more permeable than dense concrete and where the wall is exposed to the weather a greater thickness of cover to the steel is required, with possibly the further protection of rendering. Concrete with a wide range of density and compressive strength can be obtained by the selection of appropriate aggregate and mix.

6.7.3.3 No-fines concrete walls

No-fines concrete walls are constructed. With a concrete composed of cement and coarse aggregate alone, the omission of the fine aggregate giving rise to a large number of evenly distributed spaces throughout the concrete. These are of particular value in terms of rain exclusion. No-fines concrete is suitable for external and internal loadbearing walls or for panel wall infilling to structural frames.

The weight of no-fines concrete is about two-thirds that of dense concrete made with a similar aggregate. Aggregates graded from 19 nun down to 9.5 mm are used with mixes of 1 to 8 or 10 for gravel aggregate and 1 to 6 for light-weight aggregates. The aggregate should be round or cubical in shape and no more water should be used than that required to ensure that each particle of aggregate is thoroughly coated with cement grout without the voids being filled. The hydrostatic pressure on form work is only about one-third of that of normal concrete. This is an advantage since horizontal construction joint should be minimized and form work one or two storeys high can be employed without it being excessively heavy. Any normal type of shuttering can be used.

No-fines concrete walls should not be subjected to bending stresses nor to excessive eccentric or concentrated loads. Slender pier and wide openings are therefore unsuited to no-fines construction.

concentrated loads. Slender piers and wide openings are, therefore, unsuited to no-fines construction. Isolated piers should not be less than 450 mm in width or one-third the height of adjacent openings.

The bond strength of no-fines concrete is low but for openings up to about 1.5 m wide the walling itself may be reinforced to act as a lintel provided there is a depth of wall not less than 230 to 300 mm above the opening. As a precaution against corrosion the steel should be galvanized or coated with cement wash and bedded in cement mortar. For wider openings an in situ or precast reinforced lintel of dense concrete is generally necessary. Even when the wall above openings is not required to act as a lintel to carry floor or roof loads, horizontal reinforcement equivalent to a 13 mm steel bar should be placed above and below all openings. In buildings with timber floors the steel above the openings in external walls is usually made continuous.

Because of its weakness in tension, walls of no-fines concrete are sensitive to 'differential settlement. Particular attention must, therefore, be paid to the design of the foundations. For small buildings the lower part of the walls and the strip foundation should be of dense concrete, reinforced if necessary. For high buildings adequate stiffness is usually obtained by the use of rigid reinforced dense concrete cellular foundations.

<i>Cement</i>	<i>Aggregate</i>	<i>Nominal mix</i>	<i>Volume of aggregate per 50 kg of cement</i>		<i>Cube strength* within 28 days after mixing</i>		<i>Maximum permissible stresses</i>
			<i>Fine</i>	<i>coarse</i>	<i>Preliminary test</i>	<i>Works test</i>	
			<i>m³</i>	<i>m³</i>	<i>MN/m²</i>	<i>MN/m²</i>	<i>MN/m²</i>
Portland cement,	Concrete with:						

Portland blast-furnace cement and other cements included in CP 110	(i) Natural aggregates to BS882	1:1:2	0.03	0.07	40	30	7.6
		1:1 1/2:3	0.05	0.10	34	25.5	6.5
	(ii) Air-cooled blast-furnace slag (coarse aggregate) to BS1047	1:2:4	0.07	0.14	28	21	5.3
		1:3:6	0.10	0.20	15	11.5	2.4
		1:4:8	0.14	0.28	12	8.6	1.7
Portland cement,	Concrete with:						
Portland blast-furnace cement and other cements included in CP 110	(i) Foamed blast-furnace slag to BS877	Proportions to be selected to give the required cube strength				14.0	2.6
						11.0	2.1
						8.3	1.6
	(ii) Clinker aggregate to BS 1165					5.5	1.1
						2.8	0.5
	(iii) Such other artificial aggregates as may be suitable having regard to strength durability						

	and freedom from harmful material						
	No-fines concrete with:						
	(i) Natural aggregates to BS 882	Special mixes		0.28		7.0**,*** 3.5	1.3 0.6
	(ii) Air-cooled blast-furnace slag to BS 1047	1:8		0.28		2.8	0.5

NOTES on the table:

Intermediate values for other mixes may be found by interpolation.

* these requirements may be deemed to be satisfied if two-thirds of the value is obtained at 7 days.

** The average cube strength for mix design purposes should be 2.10 MN/m in excess of the cube strength specified

*** The attainment of this strength increases the density of the concrete to an extent where the thermal insulation properties may be impaired.

6.7.3.4 Thickness of plain concrete walls

The procedure in calculating is the same as for masonry walls but using different permissible stresses based on varying types and grades of concrete (table A) and a different set of reduction factors (table 3)

to apply to these stresses for slenderness ratios over fifteen, up to a maximum of twenty-four. An increase in the permissible stresses in a plain concrete wall may be made when the ratio of its storey height to length is less than 1 1/2. This varies linearly from zero at a ratio of 1 1/2 to 2.0% at a ratio of 1/2 or less. The length of the wall in this case is either the overall length or the length between adjacent openings.

The same increases may be made in the permissible stress in respect of eccentric and concentrated loads and lateral forces as for masonry walls.

It should be noted that notwithstanding the thickness established by calculation the London By-laws require the thickness of an external or party wall of concrete to be not less than 150 mm.

Slenderness ratio	15	18	21	24
Reduction factor	1.00	0.90	0.80	0.70
Linear interpolation between values for the reduction factors is permissible				

Plain concrete walls: reduction factor

6.7.3.5 Shrinkage reinforcement

Shrinkage reinforcement may be required in in situ cast concrete walls, other than those of clinker aggregate or no-fines concrete, particularly in external walls, in order to distribute the cracking due to setting shrinkage and thermal movement, and thus minimise the width of the cracks. Where this reinforcement is considered to be necessary, the Code recommends that it should be not less in volume than 0.4 per cent of the volume of the concrete in an external wall. It also makes recommendations in respect of internal walls, the positioning and distribution of the reinforcement and the provision of extra reinforcement round openings where shrinkage effects are greatest.

reinforcement round openings where shrinkage effects are greatest

As the drying shrinkage of no-fines concrete is low, reinforcement for this purpose is not usually necessary except, perhaps, with some lightweight aggregates, because the stresses set up by the slight shrinkage are relieved by the formation of fine cracks round the individual particles of aggregate. Shrinkage reinforcement may also be omitted from dense concrete walls where the mix is lean and of low shrinkage and where end restraints on the walls are small and work can be carried out continuously.

6.7.4 REINFORCED CONCRETE WALLS

6.7.4.1 In-Situ Cast external walls

The reinforced, concrete load-bearing wall used as the enclosing wall to a building is the alternative to its use as a dividing element in the concrete box frame described below. The wall areas over openings act as beams and those areas between openings as columns. These openings may be wide, since with normal sill heights there is ample depth of wall between window head and cill above to act as a deep, thin beam and the wide, narrow window is a characteristic of this form of construction. Alternatively the whole height of the wall may be regarded as a beam pierced by any necessary openings for windows.

Sufficient width of wall must, of course, be left between openings to act as columns taking all the vertical loads. The problems of appearance and thermal insulation are the same as with the plain concrete wall, but the danger of cracking due to possible unequal settlement is reduced because reinforcement is present to resist any tensile stresses set up.

6.7.4.2 Concrete Box Frames

This is a form of cross-wall construction in which the walls are of normal dense concrete and, with the floors form box-like cells as shown in the fig. As in the case of brick or block cross-wall construction, it is suited to those building types in which separating walls occur at regular intervals and are required to

is suited to these building types in which separating walls occur at regular intervals and are required to have a high degree of fire resistance and sound insulation. The most common building type in this category for which it is suitable is the multi-storey flat or maisonette block.

In concrete walls of normal domestic scale, about 2.75m high and 100 mm thick, failure is almost wholly related to the strength of the concrete and very little to the slenderness of the wall. Reinforcement, therefore, may be nominal in amount or may be omitted altogether provided that the concrete is sufficiently strong to resist the stresses set up under load. For multistorey blocks in the region of ten or eleven storeys high the mix would be designed to give a strength of around 15.5 N/mm at 28 days,

although for the two lowest storeys a stronger mix might be necessary as well as the inclusion of reinforcement.

Cracking due to the shrinkage is normally overcome by the inclusion of shrinkage reinforcement. Such cracking generally occurs only if the shrinkage is resisted by some restraint, such as that offered by changes in the plane of a wall or by a previously poured lift of concrete which has been permitted to take up its shrinkage before the next lift is poured on to it. Provided that concreting can proceed without undue delay and that the walls are in simple, straight lengths, shrinkage reinforcement in the walls may safely be omitted.

BOX FRAMES



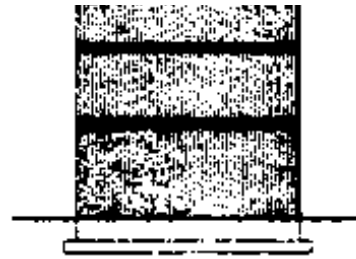

Sections A

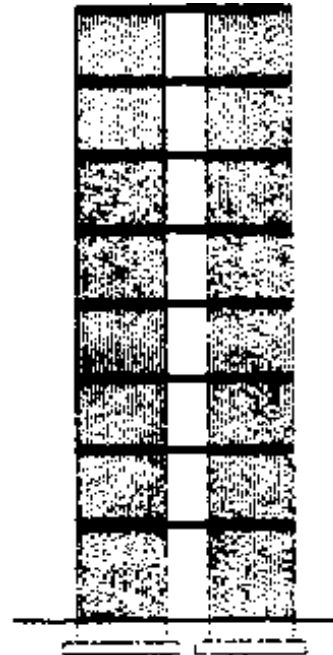

Sections B



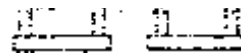

Sections C

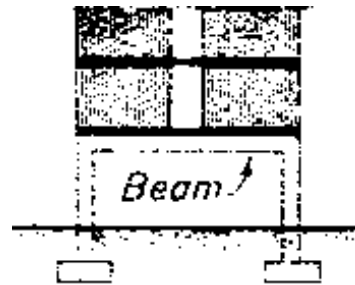

Sections D

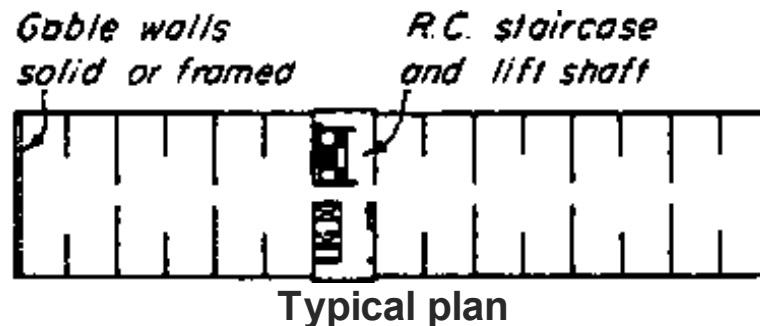

Although the junctions of walls and floors in a box frame are monolithic, if the walls are not reinforced the structure can only provide rigidity in the length of the building to the extent of the precompression set up in the walls by the floor loads and self-weight of the walls, as explained in the case of normal cross-wall construction (see page 132). Additional stability must normally be given by staircase and lift shafts of reinforced concrete, or by the inclusion of longitudinal walls at certain points in the plan. The box-walls themselves provide rigidity in the transverse direction.

In its simplest and most economic form all the box walls run in a straight, unbroken line from back to front of the building and are supported directly by a strip foundation (fig. A). They may, however, be pierced by openings or be in completely separate sections on the same line, or staggered relative to each other provided that each section is in the same position throughout the height of the building (b). If the upper floors are to be supported on columns at ground level the necessity of beams and the

~~the upper floors are to be supported on columns at ground level the necessity of beams and the~~
disposition of the columns will depend upon the arrangement of the walls above. Straight, unbroken box walls can act as deep beams spanning between the supporting columns with any necessary reinforcement placed in the tension and shear zones. If the walls are broken extra columns must be introduced to enable each wall section to act as a beam (C) or, alternatively, a separate beam must be introduced to pick up the sections and transfer the loads to the columns (D).

6.7.4.3 Large precast panel structure

In this form of construction the loadbearing elements are large panels not less than storey-height, used with precast floor and roof units (figure 6.7.4.2 D) Window openings may be cast in the external panels which are usually finished with an exposed aggregate or tooled or profiled surface and incorporate thermal insulation, either sandwiched between two leafs or applied to the internal face, internal panels can be made smooth enough to make plastering unnecessary.

Solid external panels are insulated internally. They are simpler to produce than sandwich panels but usually require a vapour barrier near the inner face. Certain types of these panels are in cavity or cored form.

Internal loadbearing wall panels are solid or cored and between 125 and 225 mm thick with nominal reinforcement. Adequate sound insulation can be achieved with a thickness of 175 mm if plastered on both sides and rather thicker if not.

Floor panels may be of solid or cored construction. The former may be reinforced as two-way spanning slabs and they also provide better air-borne sound insulation. The latter are lighter in weight, but can span in one direction only.

CASTING

- Casting panels

Horizontal casting is used for complicated panels which present some difficulty in casting, such as sandwich-panels for external walls, those with openings in them and those which are to have an integral or applied surface finish. When cast these are preferably removed from the moulds by means of pivoting mould beds or by vacuum pads, in order to avoid damage. The former method avoids the need for re-; reinforcement to resist lifting stresses.

Vertical casting is preferable for wall and floor panels required to have a fair face both sides since this has the advantage of eliminating face trowelling. The moulds can be arranged in batteries with ten or more compartments, the division plates being of thick steel or concrete panels or of ply facing on both sides of a steel frame. The system of using two concrete panels, initially cast horizontally with a very smooth, true face, as the mould faces to reproduce a run of similar units was developed by the Building Research Station. The first panel is cast between the initial pair and has a true face on each side. After curing the three panels are spaced apart to provide the mould for two further panels, the five then being used to produce four more, and so on.

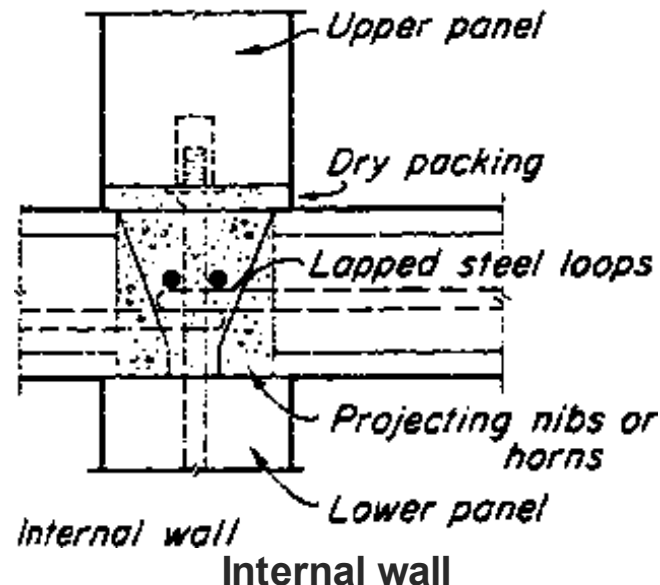

The method is most suitable for residential buildings since the dense concrete panels can provide, as well as the strength for load bearing, the degree of fire resistance and sound insulation required at the separating walls. Cellular, cross-wall and spine-wall plan forms may be used. The advantage of the cellular plan is its inherent stability and the fact that all walls may be loadbearing so that the floor panels may be two-way spanning.

Types of panels

External wall panels are commonly either of solid or of sandwich construction although waffle slabs are also used. The latter, however, have a number of disadvantages.

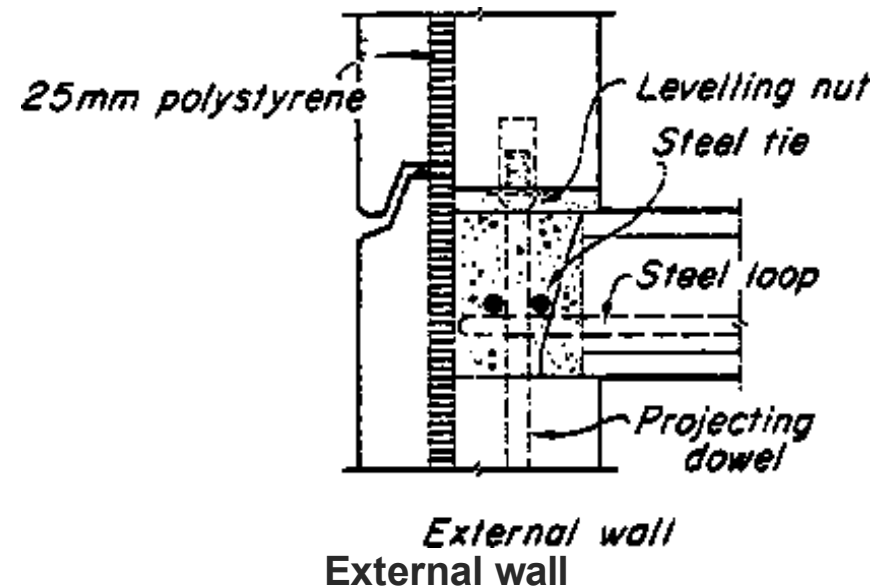

Sandwich panels have a layer of insulation incorporated either symmetrically or asymmetrically in the thickness of the slab (fig. 6.7.4.2.). In the former both internal and external leaves are load-bearing with transverse ties strong enough to ensure that both act together. The restraint thus offered to thermal and moisture movement in the external leaf can cause it to warp. This is overcome by an asymmetrical

positioning of the insulation since the thinner non-loadbearing leaf, usually external, required only to be attached to the loadbearing leaf by lighter forms of ties. These ties, either of hot-dipped galvanized mild steel, or of suitable non-ferrous metal, must have ends formed to ensure a mechanical anchorage between the leaves.

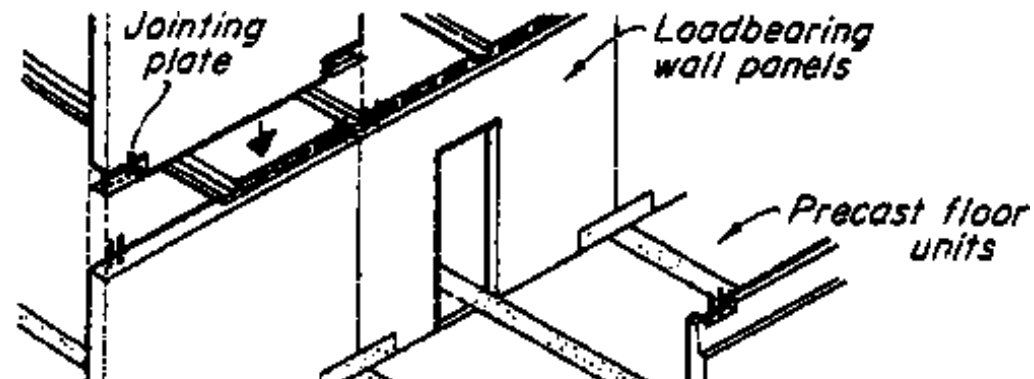
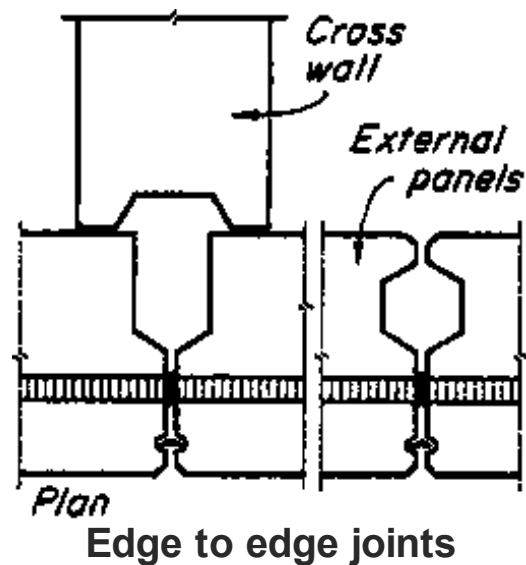

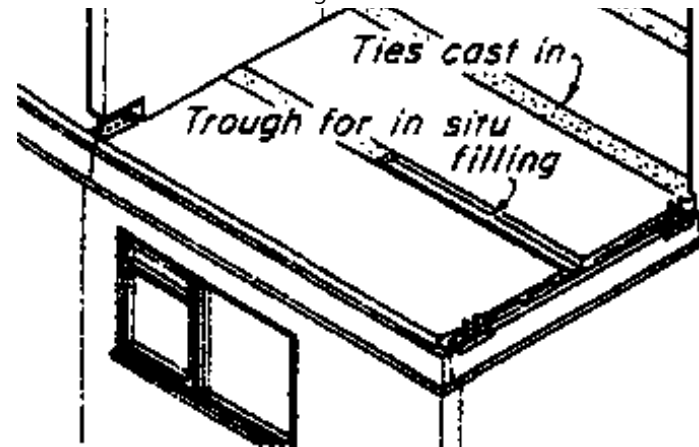

- Structural connections

In situ concrete is commonly used to form the structural joints between panels. The method used to form the horizontal joint between the wall panels is shown in the fig. A, B.

It is preferable to limit the bearing of the floor slabs on the heads of the wall panels by the; provision of projecting nibs or horns at about 150 to 225 mm centres along the edge of the floor panels, which provide the necessary support for the floor slabs. This permits the load from the upper wall panel to be transferred across the whole width of the wall directly to the panel below as shown. A threaded bar or dowel projecting from each end of the lower panel provides, by means of nut and washer, temporary support and a means of levelling the top panel. The joint is filled with in situ concrete and after this has set the gap above it is dry packed with cement mortar. When this in turn has set the nuts are run down to ensure contact between the upper slab and the packing thus off-setting the initial shrinkage of the mortar.

With cross and spine wall plans overall rigidity can be provided by in situ cast lift and stairwells, but this has the disadvantage of mixing precast and in situ work on the site. Fully precast construction uses bathrooms precast as reinforced concrete boxes complete with floor and ceiling and lift and stairwells precast in storey or half-storey heights which, when erected on each other, form structural 'columns' running the full height of the building. A number of these vertical units along the centre of the block form

a structural spine to the remainder of the structure which is fabricated from large precast floor panels and storey height loadbearing wall panels (E).

6.8 OPENINGS IN WALLS

- An opening in an external wall of a o head o Jamb (or reveal) and o sill (or threshold)

6.8.1 HEAD

HEAD: its function is to carry the triangular load of brickwork over the opening and transmit this load to the jambs at the sides. To fulfil this task it must have the capacity to support the load without unacceptable deflection. A variety of materials and methods is available in the form of a LINTEL or BEAM such as:

- **timber:** suitable for light loads and small spans, the timber should be treated with a preservative to prevent attack by beetles or fungus.
- **steel:** for small openings a mild steel flat or angle section can be used to carry the outside leaf of a cavity wall, the inner leaf being supported by a concrete or steel Lintel,
 - for medium spans** - a chanel or joist section is usually suitable,
 - for larger spans** - a universal beam section to design calculations will be needed.

Steel lintels which are exposed to the elements should be either galvanised or painted with several coats of bi-tumious paint to give them protection against corrosion.

- **Concrete:** these can be designed as insitu or precast reinforced beams or lintels and can be used for all spans. Prestressed concrete lintels are available for the small and medium spans.

- **Stone:** these can be natural, artificial or reconstructed stone but are generally used as a facing to a steel or concrete lintel.
- **Brick:** unless reinforced with mild steel bars or mesh, brick lintels are only suitable for small spans up to 1 m, but like stone, bricks are also employed as a facing to a steel or concrete lintel.

6.8.1.1 Lintels

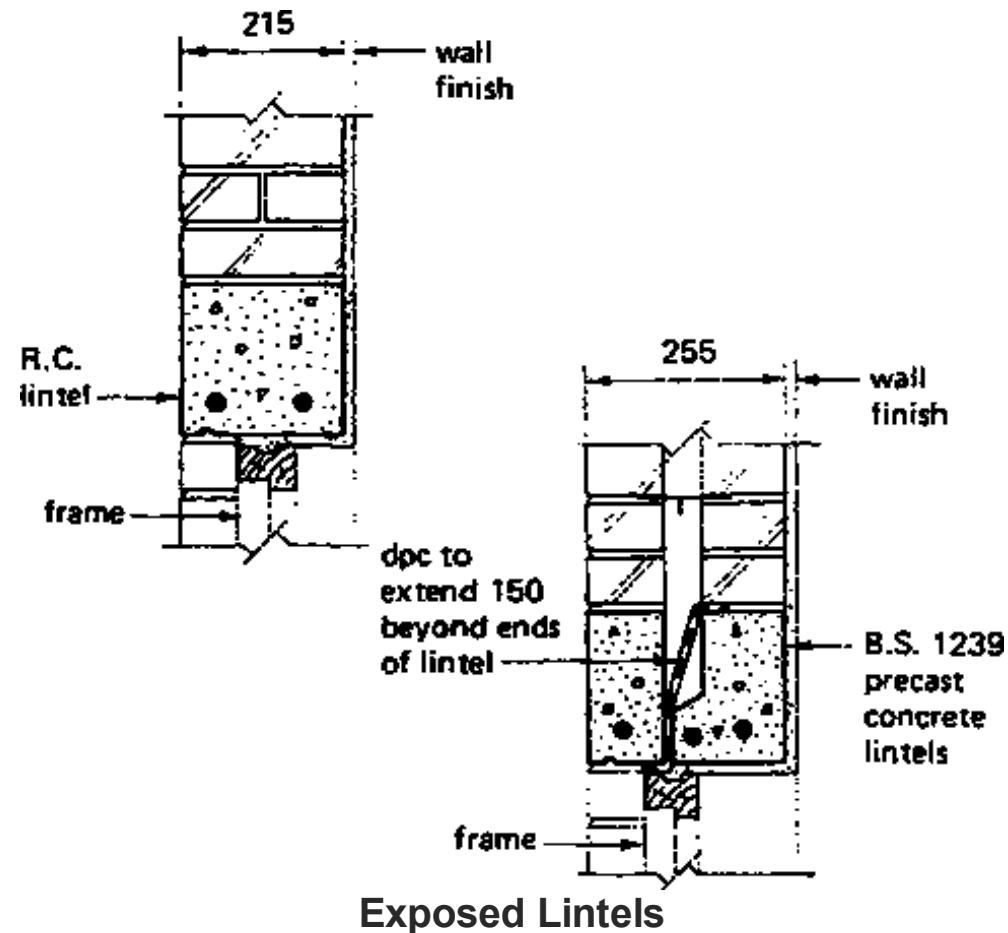

LINTELS: Require a bearing at each end of the opening, the amount will vary with the span but generally it will be:

100mm for the small spans and up to 225 mm for the medium and large spans.

- In cavity walling a D.P.C. will be required where the cavity is bridged by the lintel and this should extend at least 150mm beyond each end of the lintel.
- Open joints are sometimes used to act as weep holes; these are placed at 900mm centres in the in the outer leaf immediately above the D.P.C.

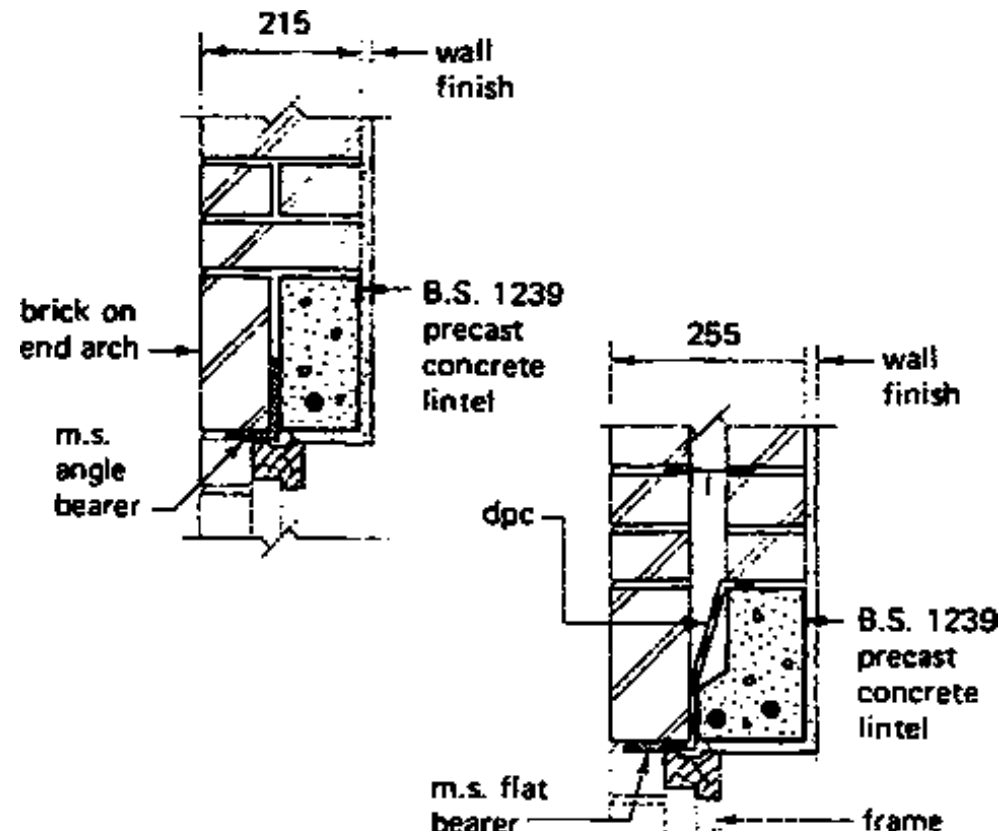

Concealed Lintels

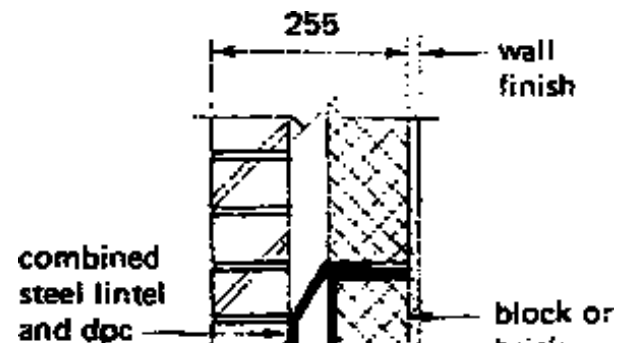
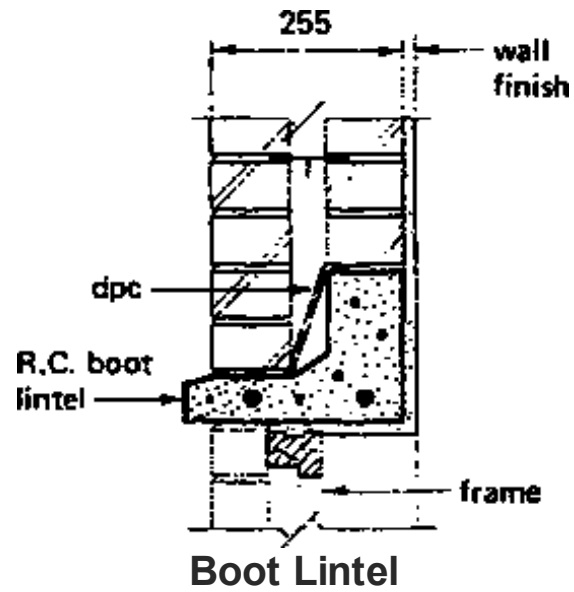



Pressed Steel Lintel

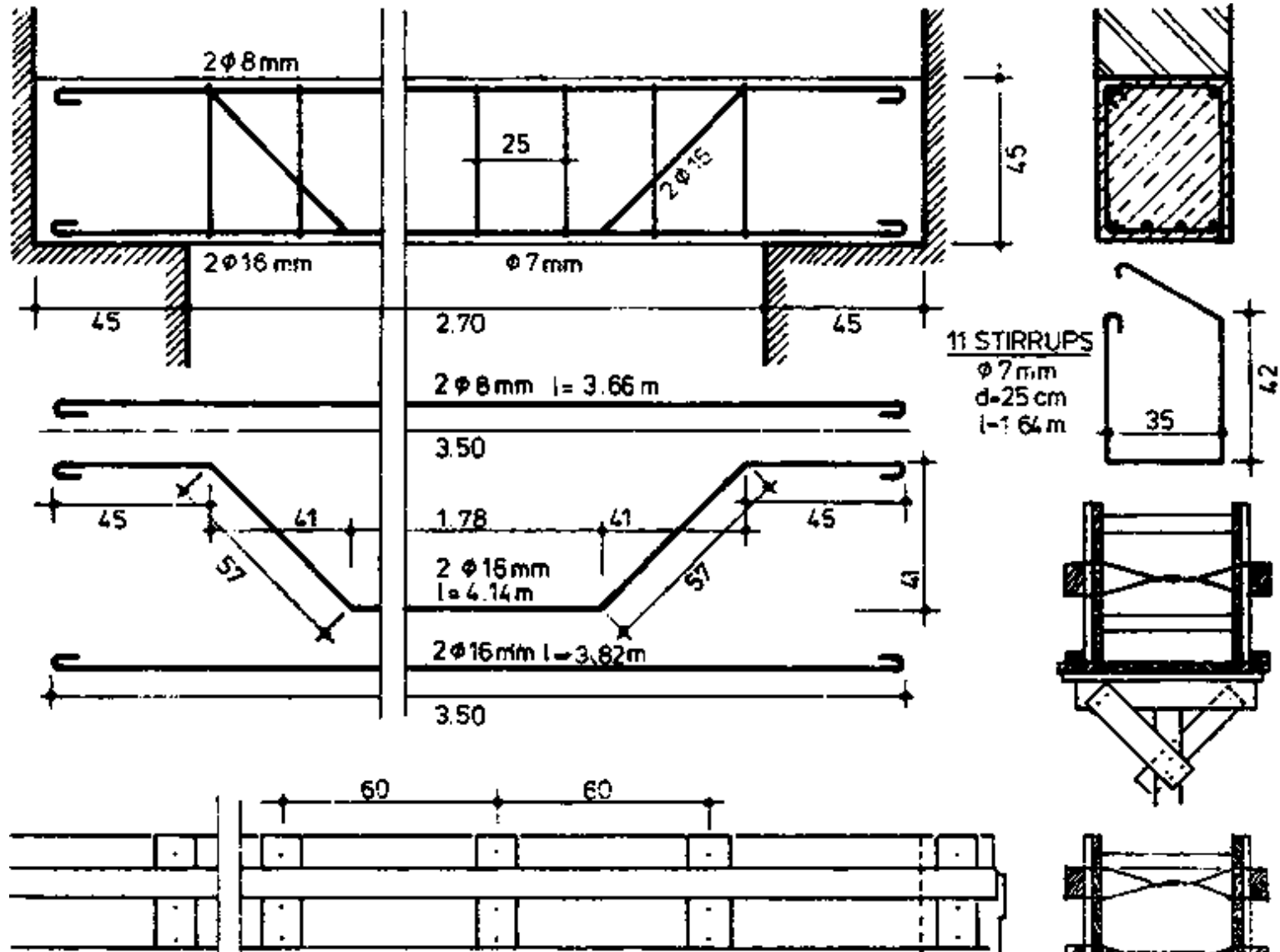

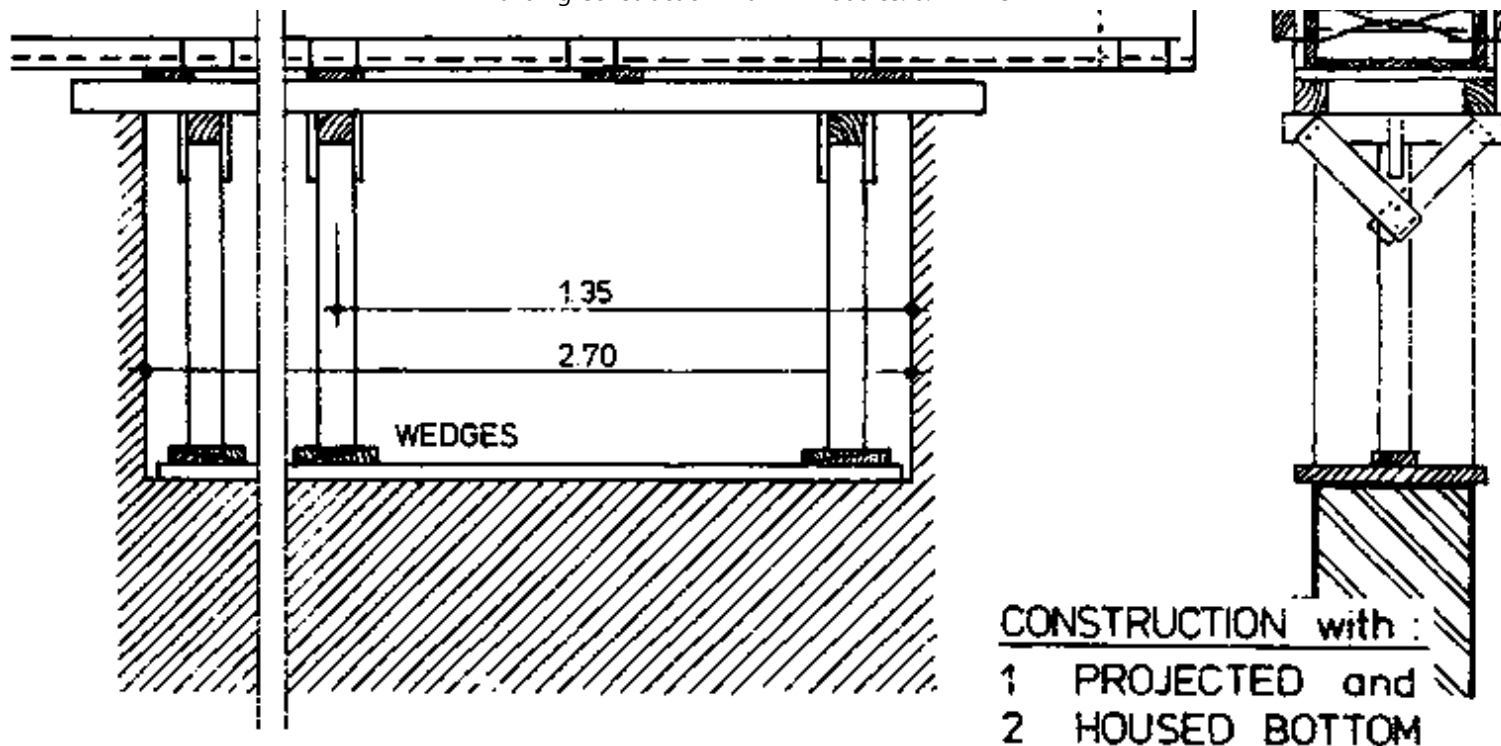

FORMWORK & STEEL REINFORCEMENT BARS for a simple R.C. LINTEL (span: 2.70 m)

6.8.1.2 Arches

ARCHES: These are arrangements of wedged shaped bricks designed to support each other and carry the load over the opening round a curved profile, to abutments on either side.

An exception to this form is the flat or "soldier" arch constructed of bricks laid on end or on edge.

When constructing an arch it must be given temporary support until the brick joints have set and the arch has gained sufficient strength to support it self and carry the load over the opening. These temporary supports are called **CENTRES** and are usually made of timber; their design is governed by the span, load and thickness at the arch to be constructed.

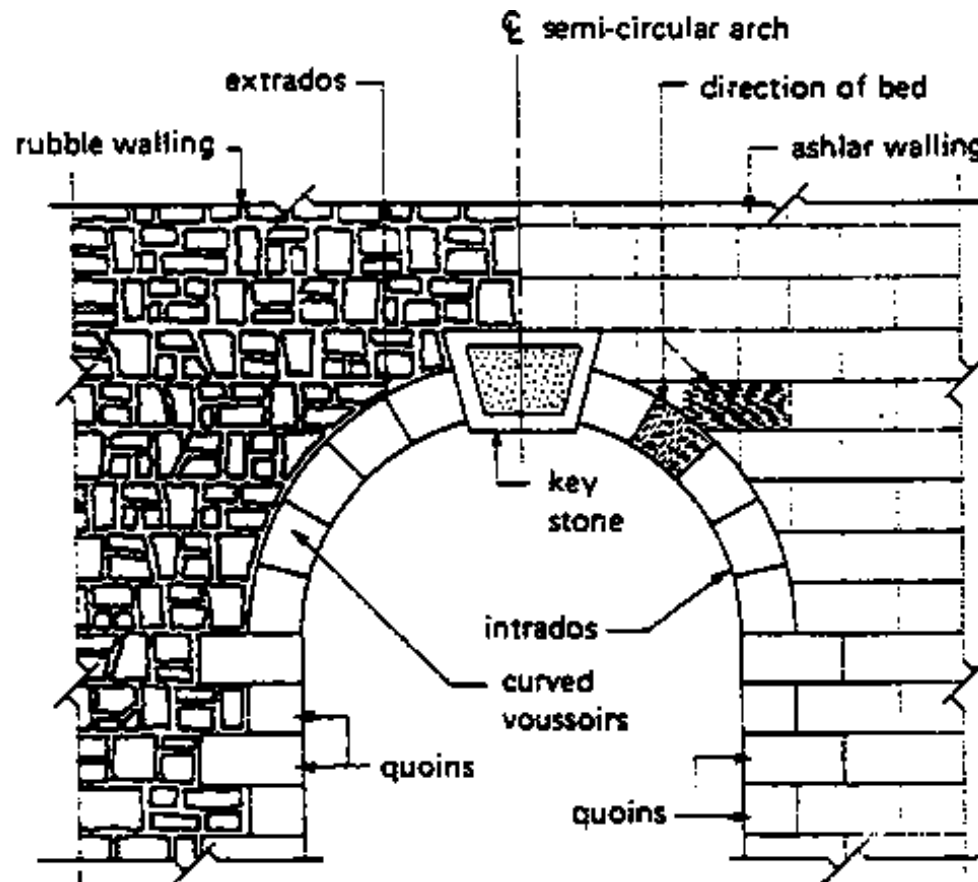

- ARCH Terminology:

- **Voussoirs:** The wedge-shaped bricks or blocks of stone which comprise an arch; the last voussoire to be placed in position is usually the central one and known as the **KEY Brick** or **KEY Stone**.
- **Ring, Rim or Ring Course:** The circular course or courses comprising the arch.
- **Extrados or Back:** The external curve of the arch.
- **Intrados:** The inner curve of the arch.
- **Soffit:** The inner or under surface of the arch.
- **Abutments:** the portions of the wall which supports the arch.
- **Skewbacks:** The inclined or splayed surface of the abutments prepared to receive the arch and from which the arch springs.
- **Springing Points:** The points at the intersection between the skewbacks and the intrados.
- **Springing Line:** The horizontal line joining the two springing points.
- **Springes:** The lowest voussoirs immediately adjacent to the skewbacks.
- **Crown:** The highest point of the extrados.
- **Haunch:** The lower half of the arch between the crown and a skewback.
- **Span:** The horizontal distance between the reveals of the supports.
- **Rise:** The vertical distance between the springing line and the highest point of the intrados.

- **Centre (or striking point) and Radius: (See Fig.)**
- **Depth or Height: The distance between the extrados and intrados.**
- **Thickness: The horizontal distance between and at right angles to the front and back faces; it is sometimes referred to as the width or breadth at the soffit.**
- **Bed joints: The joints between the voussoirs which radiate from the centre.**
- **Spandril: The triangular walling enclosed by the extrados, a vertical line from the top of the skewback, and a horizontal line from the crown.**
- **Impost: The projecting course (or courses) at the upper part of a pier or other abutments to stress the springing line.**

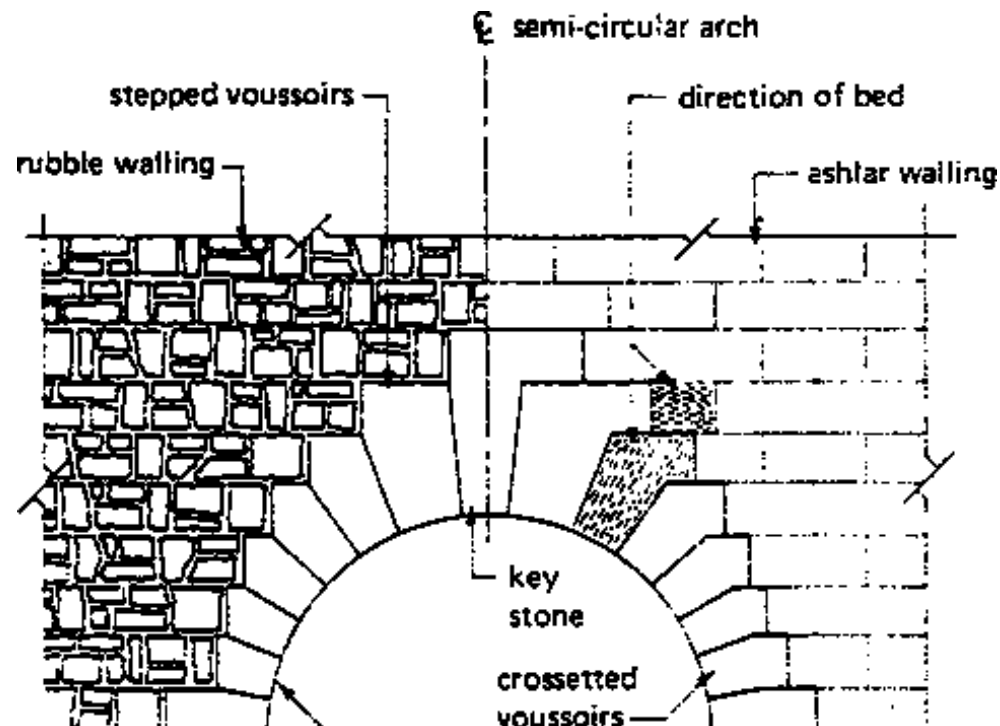

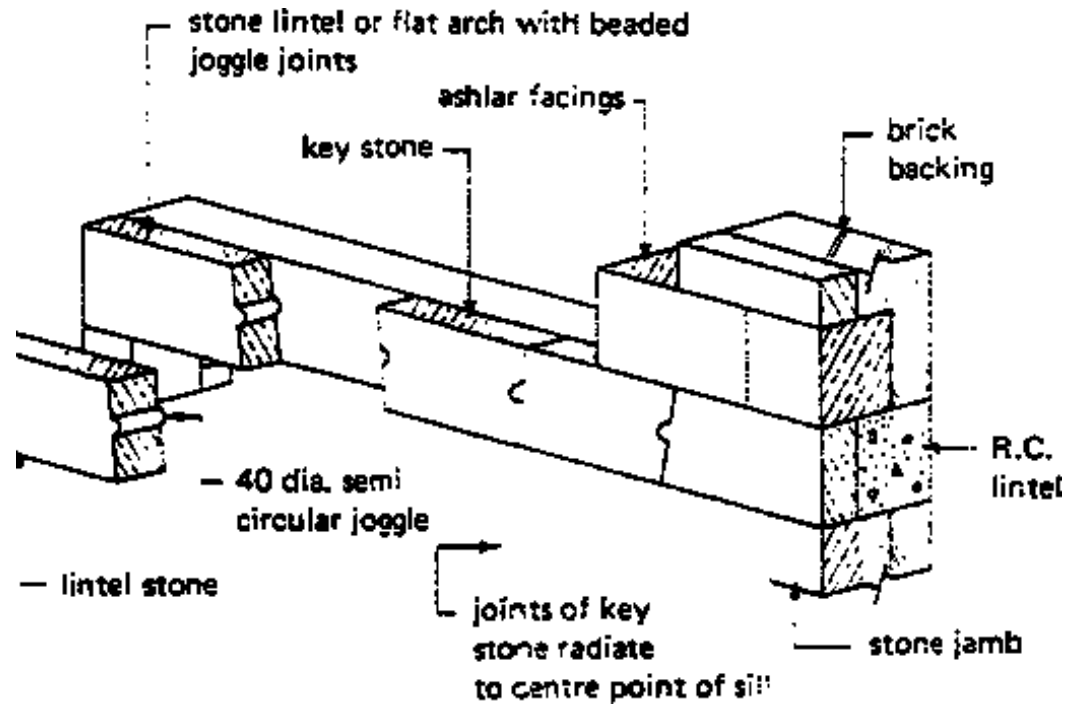
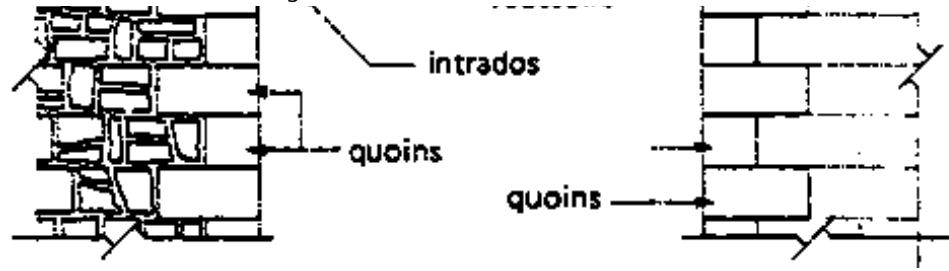

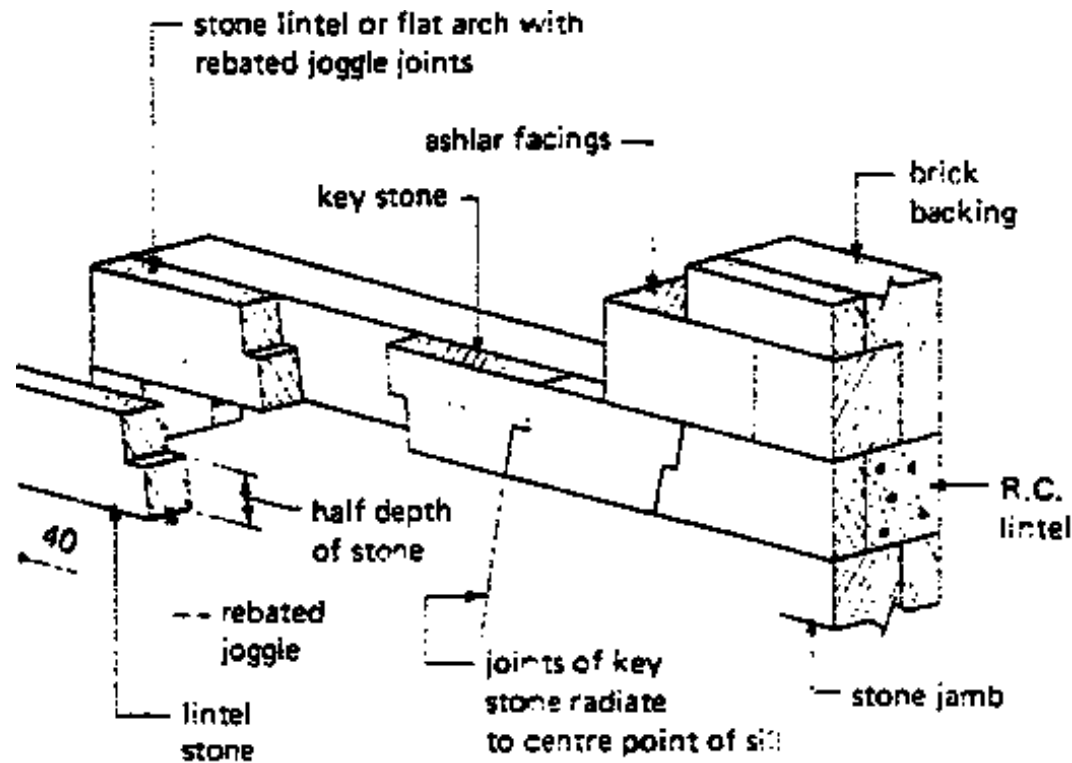

- CLASSIFICATION OF ARCHES;

Arches are classified according to their (a) shape and (b) materials and workmanship employed in their

construction.

(a) The more familiar forms are:

flat (straight or camber) Archs.

- gauged flat arch
- purpose-made flat arch
- axed brick flat arch.

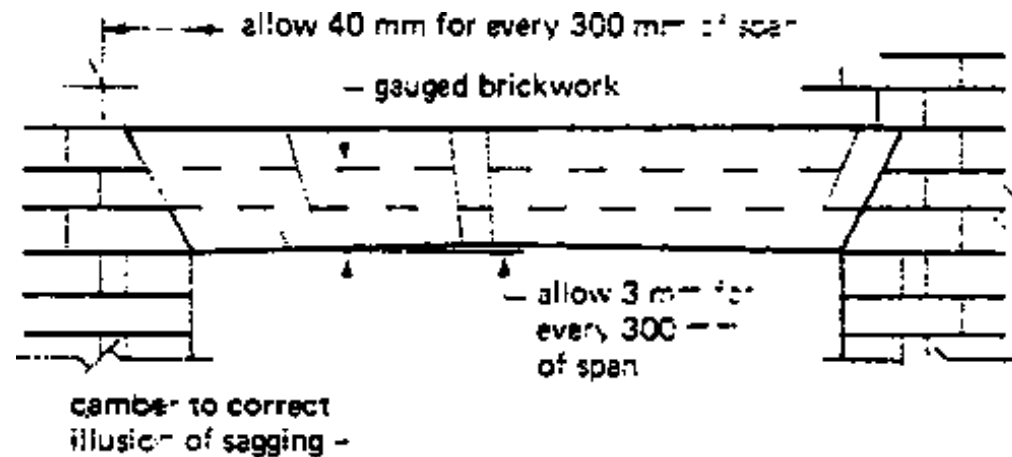

- Segmental Archs:

- gauged segmental Arch
- purpose-made brick segmental Arch
- axed brick segmental Arch
- rough brick segmental Arch.

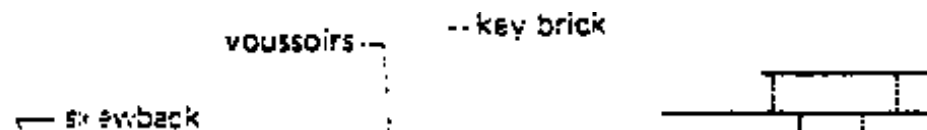

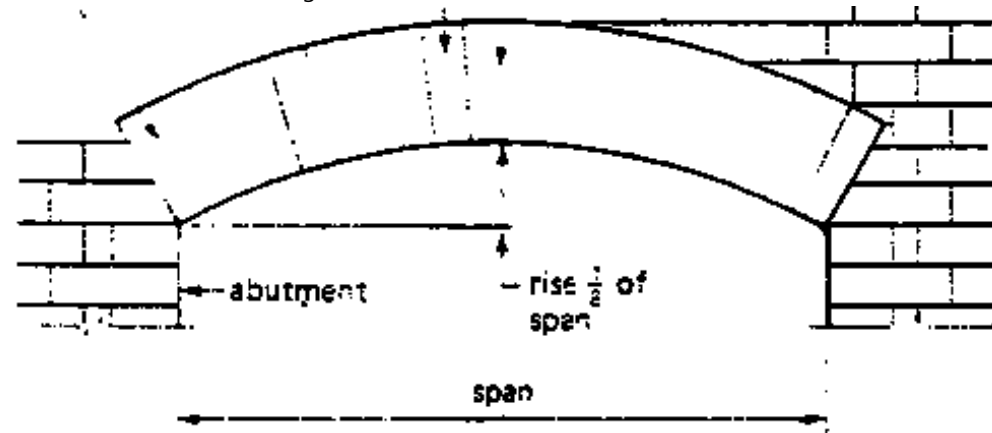

- Semicircular Archs:

- gauged semicircular Arch
- purpose-made brick semicircular Arch
- axed brick semicircular arches
- rough brick semicircular arch.

Others which are not so generally adopted are:

Circular Archs,
Semi elliptical Archs
Elliptical Archs
Pointed Archs.

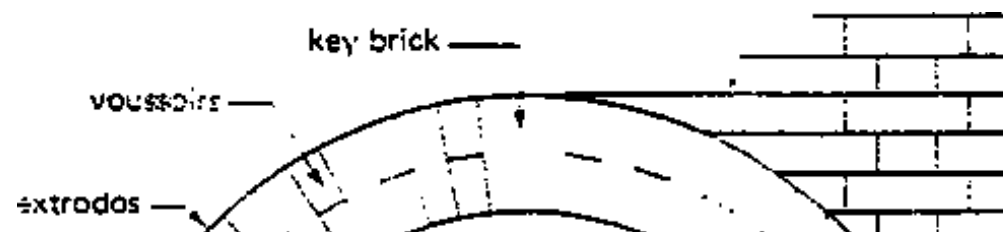

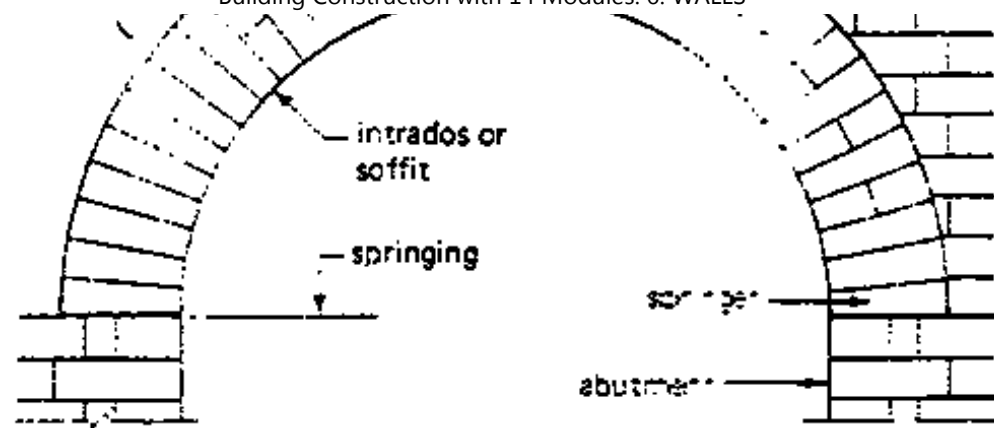

b) The voussoirs may consist of:

- rubber bricks
- purpose-made bricks
- ordinary or standard bricks cut to wedge shape (known as axed bricks)
- Standard uncut bricks.

RUBBER BRICKS (Rubbers, Cutters or Malms): soft bricks; various sizes; can be readily sawn and rubbed to the desired shape; are used in the construction of "gauged arch".

PURPOSE-MADE BRICKS: specially hand-moulded to the required shape; used for good class work of "Purpose-made brick Archs".

ORDINARY BRICKS CUT TO WEDGE SHAPE: are standard bricks, roughly cut to the required wedge shape by using a bolster and dressed off with a scutch, or axe. Used in the construction of "Axed brick Archs".

ORDINARY STANDARD UNCUT BRICKS: When such bricks are used in the construction of arches, the bed joints are not of uniform thickness, but are wedge shaped. They are used for "Rough brick Archs".

Bed joints are not of uniform thickness, but are wedge shaped. They are used for ROUGH BRICK ARCHES.

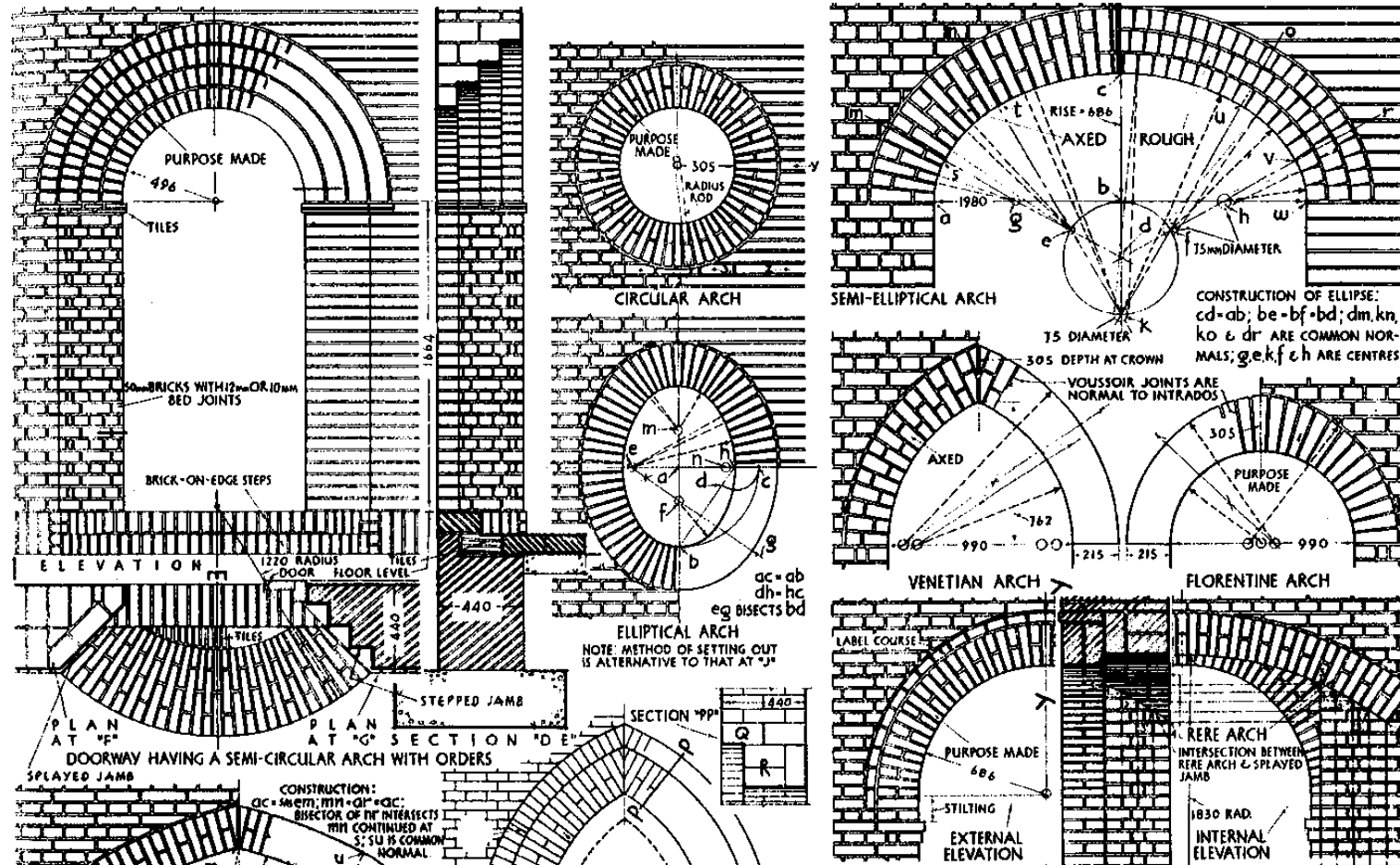

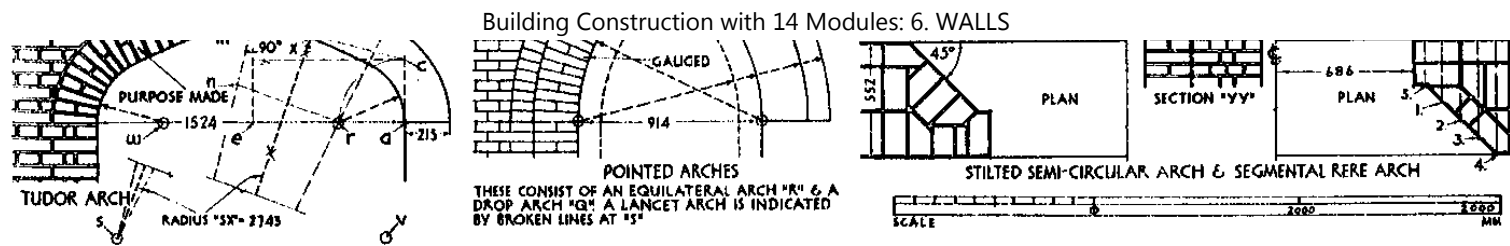

ARCHES

- CENTRES:

Are temporary structures (usually of light timber construction) which are strong enough to support arches of bricks or stone while they are being built and until they are sufficiently set to support themselves and the load over the opening.

A Centre is always less in width than the soffit of an arch to allow for plumbing (that is: alignment and verticality of the face with a level or rule.) The type of Centre to be used will depend upon:

- (1) The weight to be supported
- (2) The span
- (3) The width of the soffit.

Generally soffits not wider than 150mm will require one rib at least 50 mm wide and are usually called turning pieces. Soffits from 150-350mm require two ribs which are framed together using horizontal tie members called laggings.

Soffits over 350mm require three or more sets of ribs. The laggings are used to tie the framed ribs together and to provide a base upon which the arch can be built.

Close laggings are those which are touching each other, forming a complete seating for a gauged arch.

Open laggings, spaced at twice the width of laggings, centre to centre, are used for rough arches.

Open lagging, spaced at three times the width of lagging, centre to centre, are used for rough arches.

If the arch is composed of different materials, i.e. a stone arch with a relieving arch of brickwork, a separate centre for each material should be used.

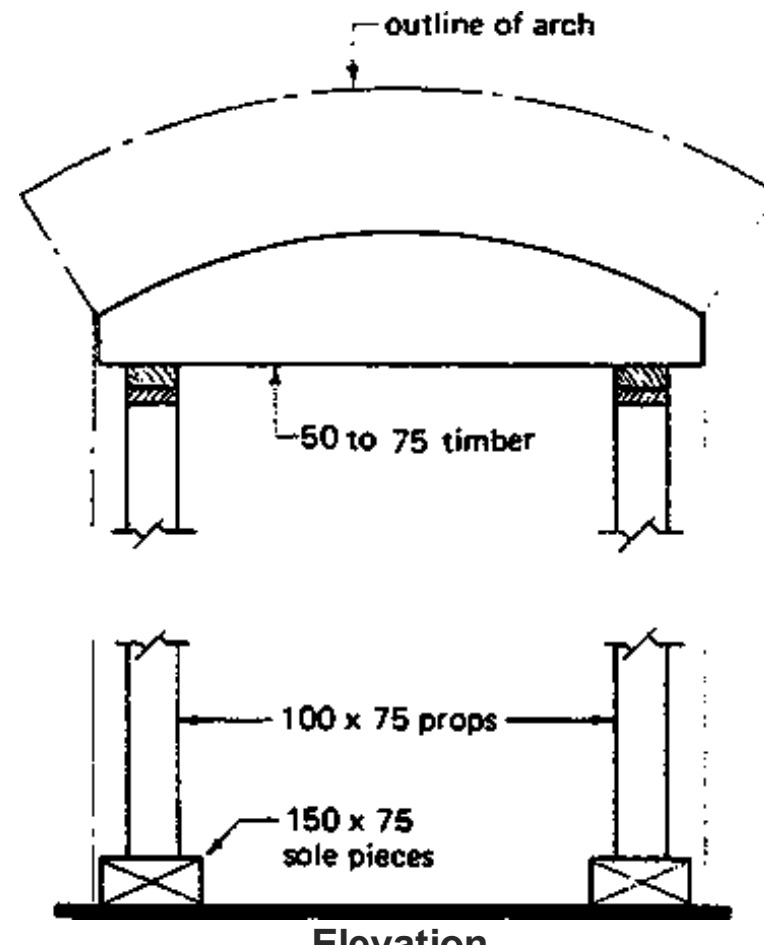

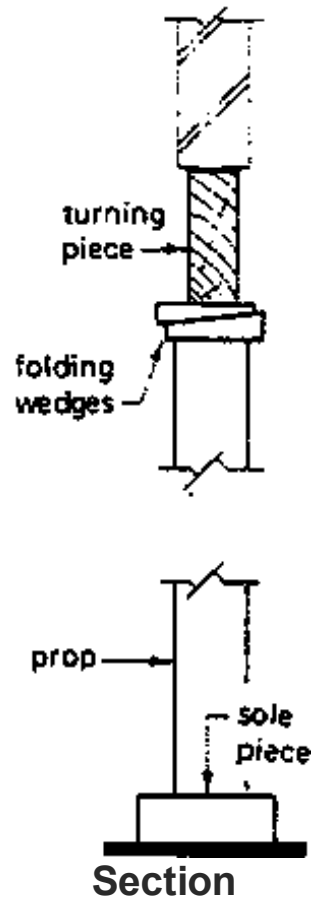

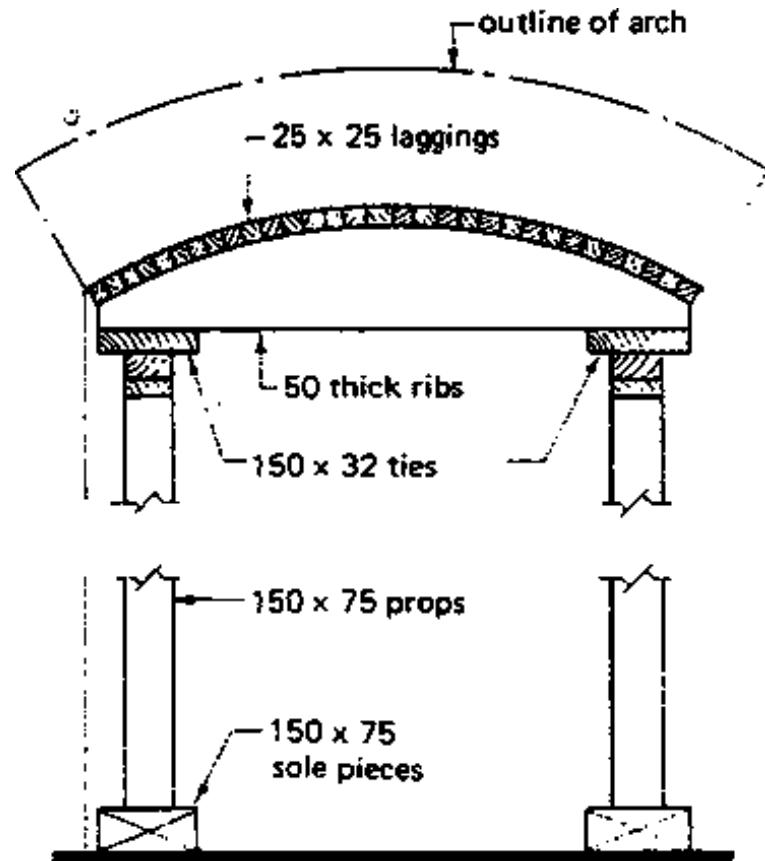

Centres for small span arches - Elevation

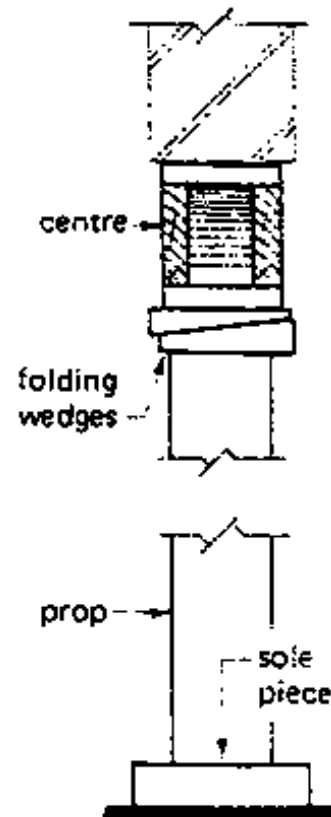

Centres for small span arches - Section

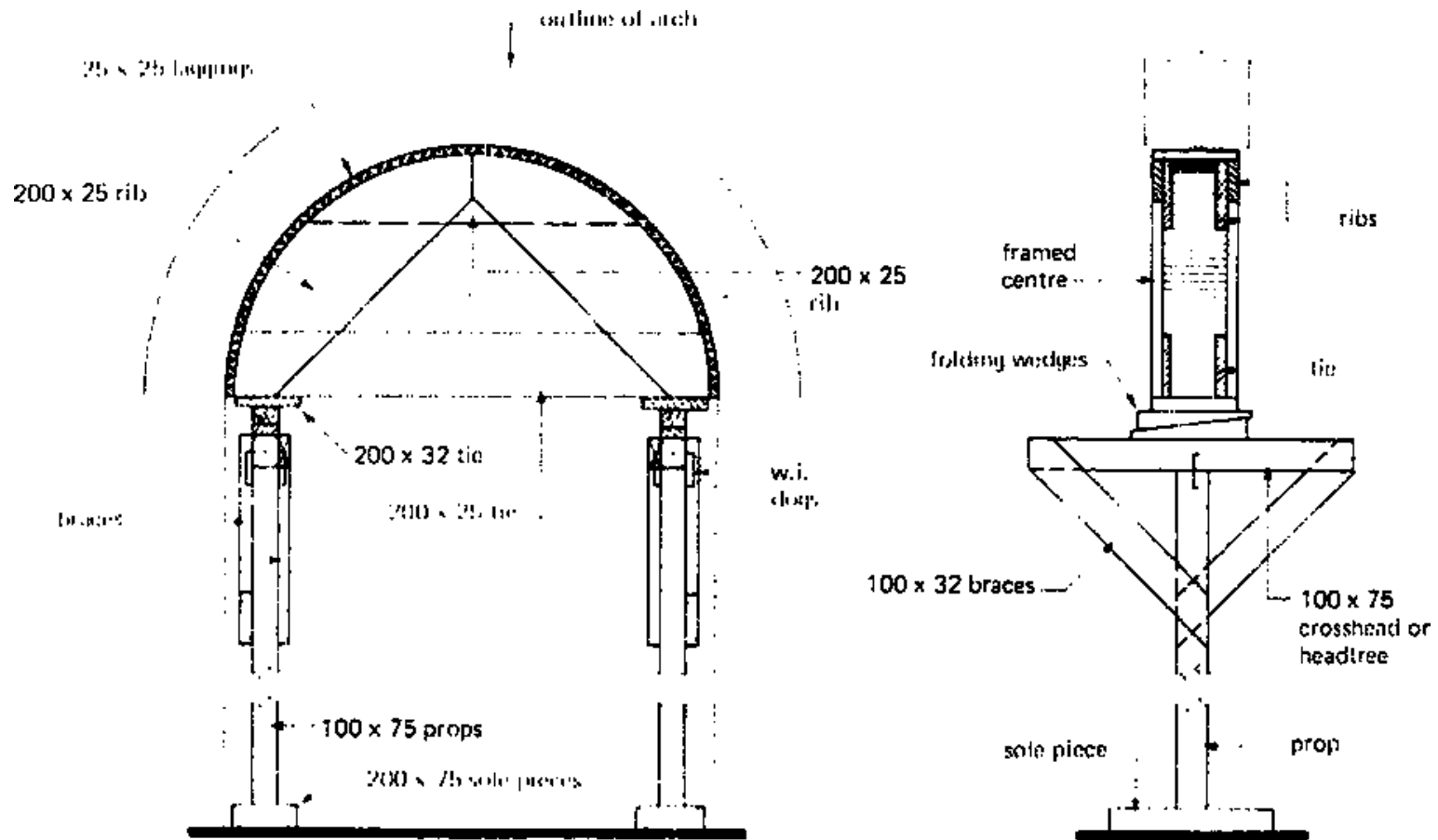

Typical framed centre for spans up to 1500 mm

Typical framed centre for spans up to 4000 mm

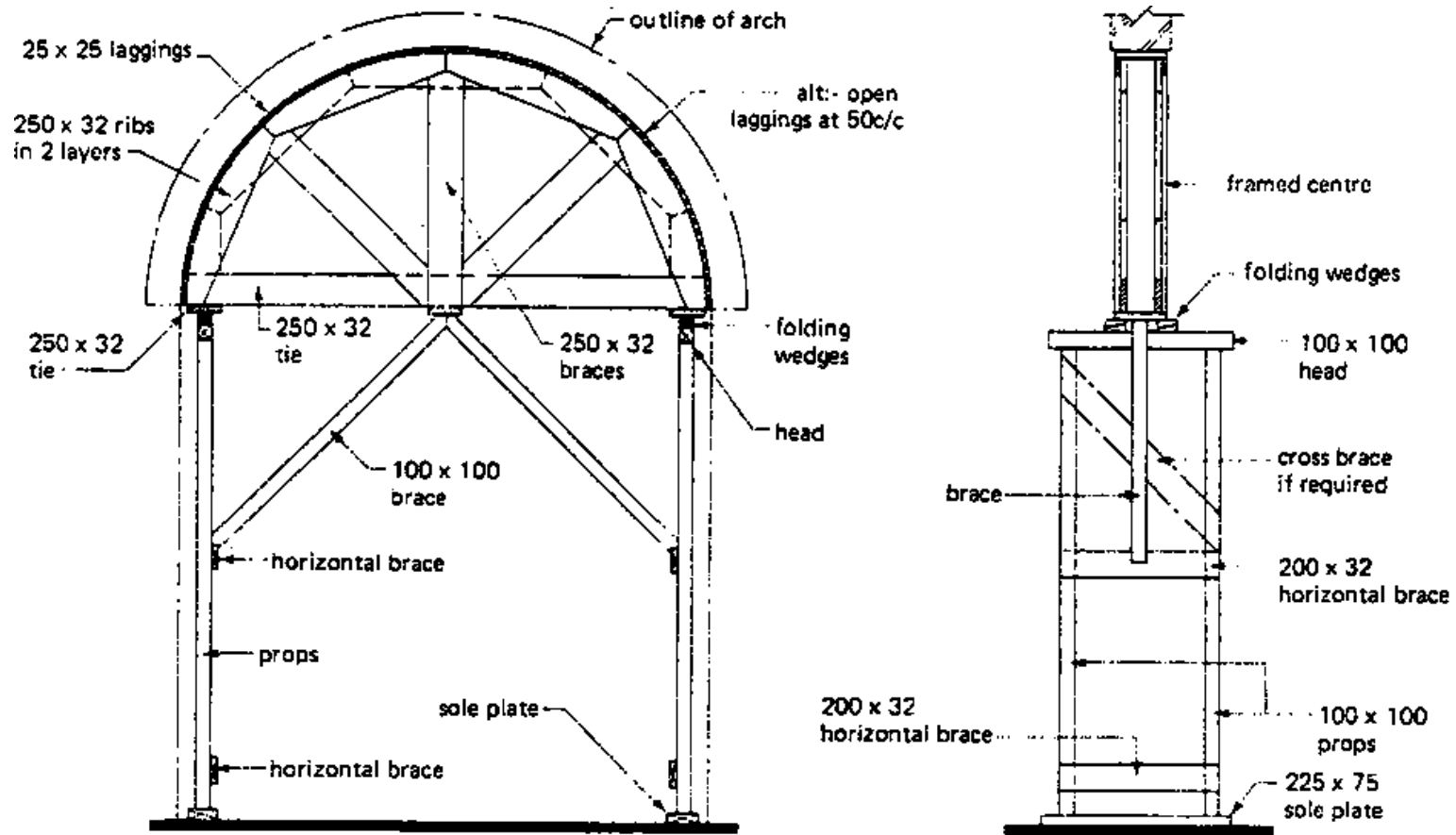

Typical framed centre for spans up to 4000 mm

6.8.2 JAMBS

JAMBS: in solid walls these are bonded to give the required profile and strength.

In cavity walls the cavity can be closed at the opening by using a suitable frame or by turning one of the leaves towards the other forming a butt joint in which is incorporated a vertical D.P.C. (as required by the B.R.)

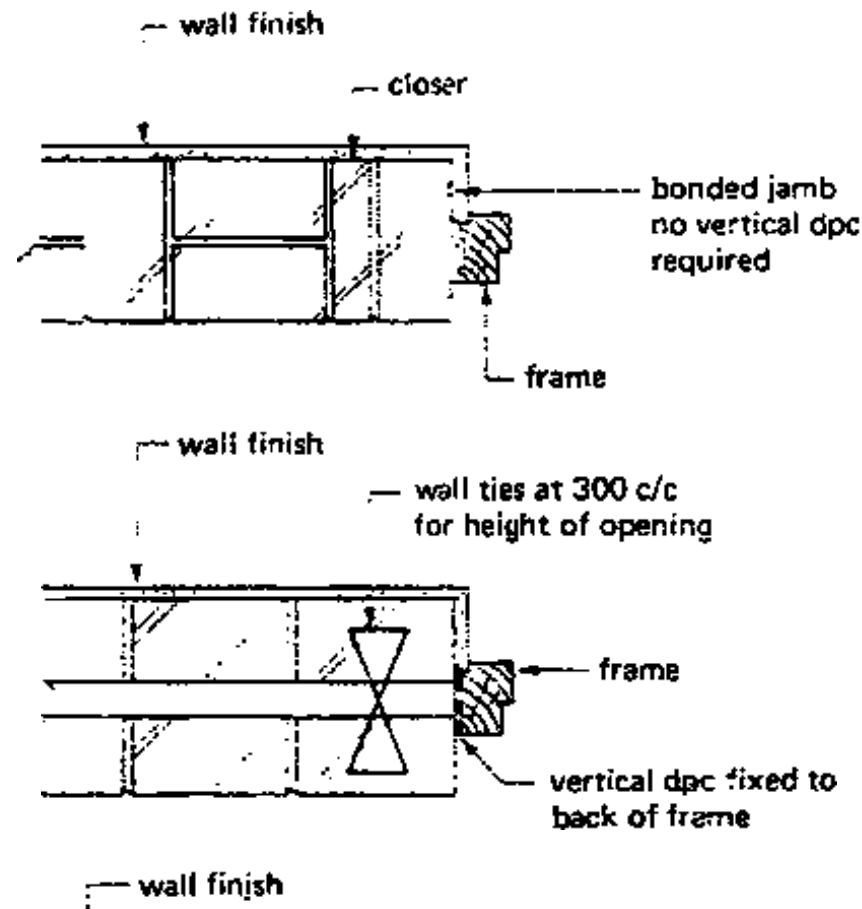

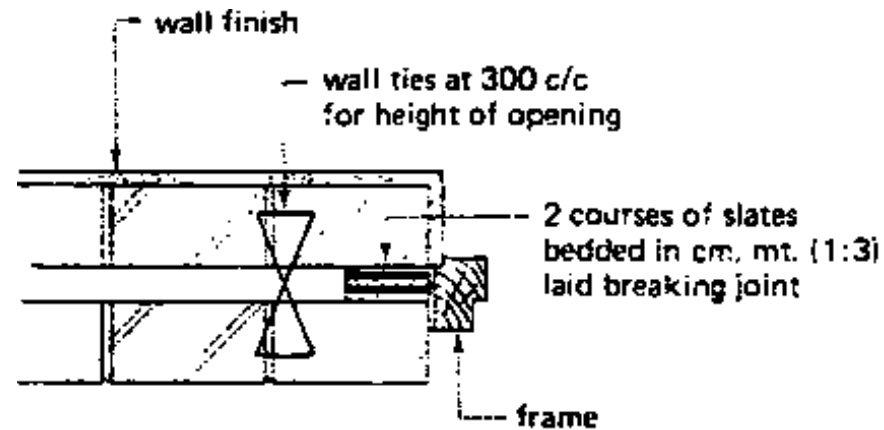
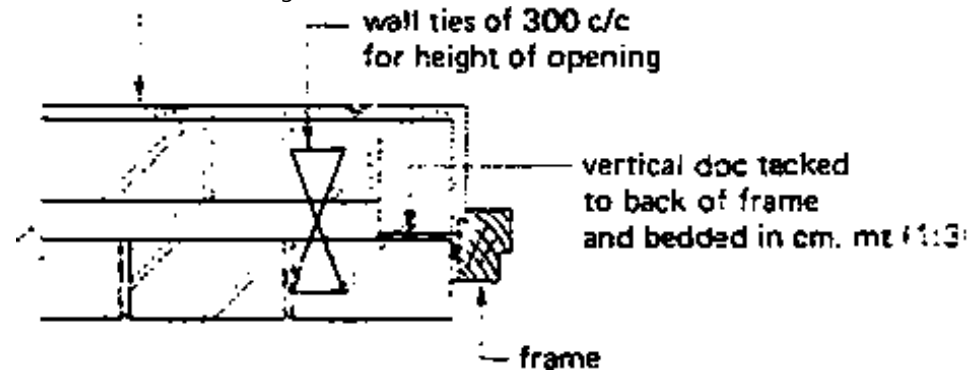

6.8.3 SILLS AND THRESHOLDS

6.8.3.1 Sills

SILLS: Are defined as the **BOTTOM** of a Window Opening.

SILLS: the function of a sill is to shed the rainwater, which has run down the face of the window or door and collected at the base, away from the opening and the face of the wall. o Many methods and materials are available. o Appearance and durability are the main requirements. o Sills (unlike lintels) do not

are available. o Appearance and durability are the main requirements. o Sills (unlike lintels) do not require a bearing at each end.

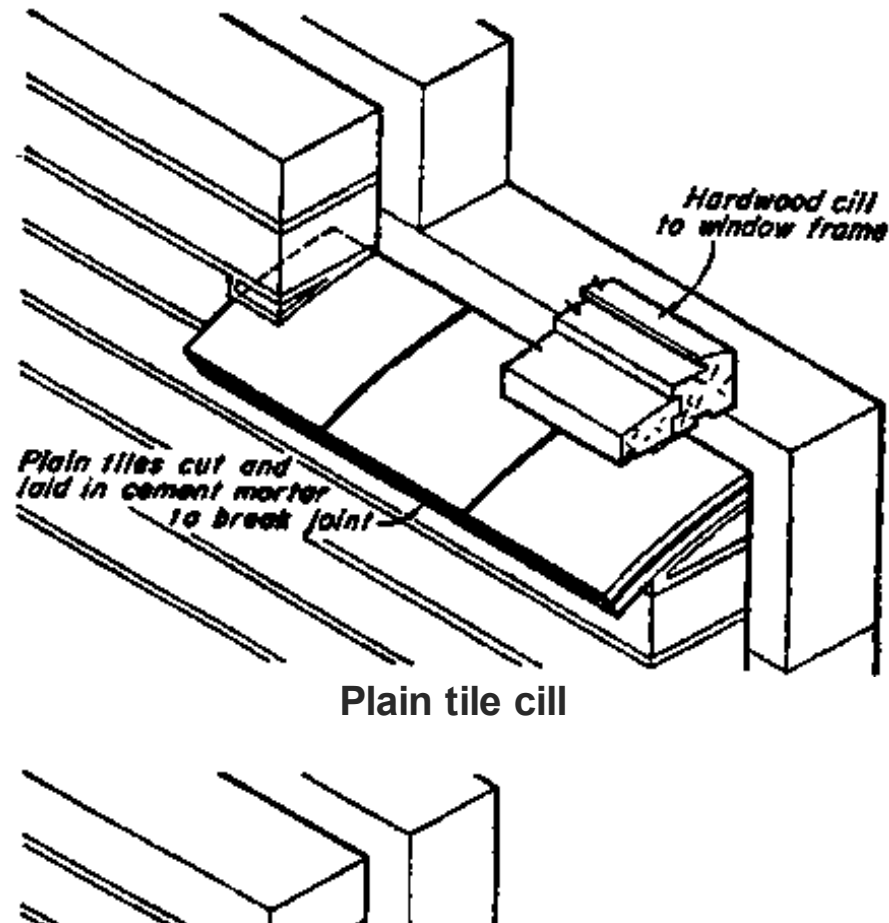

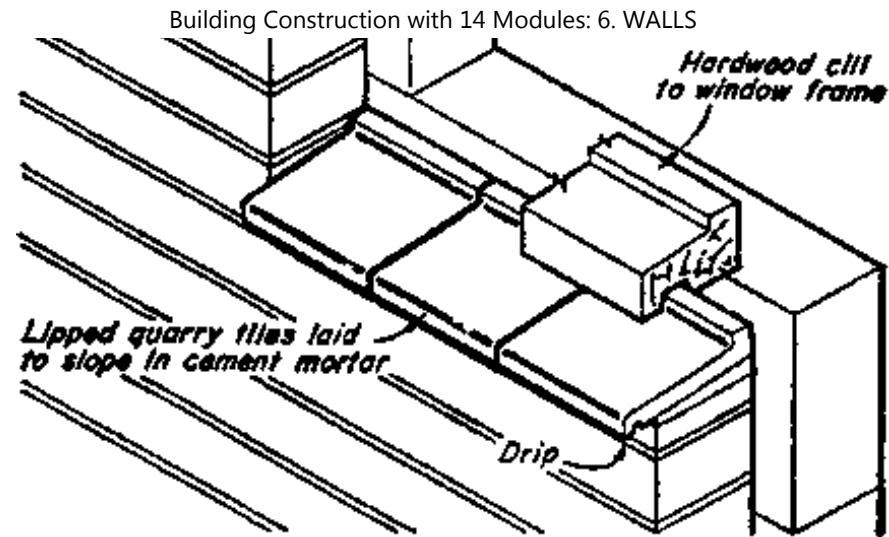

Lipped quarry tile cill

- Usually a window frame is less thick than the wall in which it is built, so that there are horizontal surfaces of brickwork at the foot of the window.
- Most of the area of a window is glass which does not absorb water, and rain runs off it on to the external surface below.
- The **FUNCTION** of the **SILL**, therefore is to protect this part of the wall from the penetration of considerable quantities of water.
- Suitable materials for the construction of sills are:
 - stone
 - concrete
 - brick, slate, stone or quarry tiles laid in cement mortar
 - roofing tiles laid to break joint in cement.
 - metal

- The top surface of the sill is made to slope downwards and outwards: It is weathered in order to discharge rain water falling on it and the sill itself is made to project not less than 25mm to 40mm beyond the wall face in order to direct the discharge of water away from the face of the wall below.

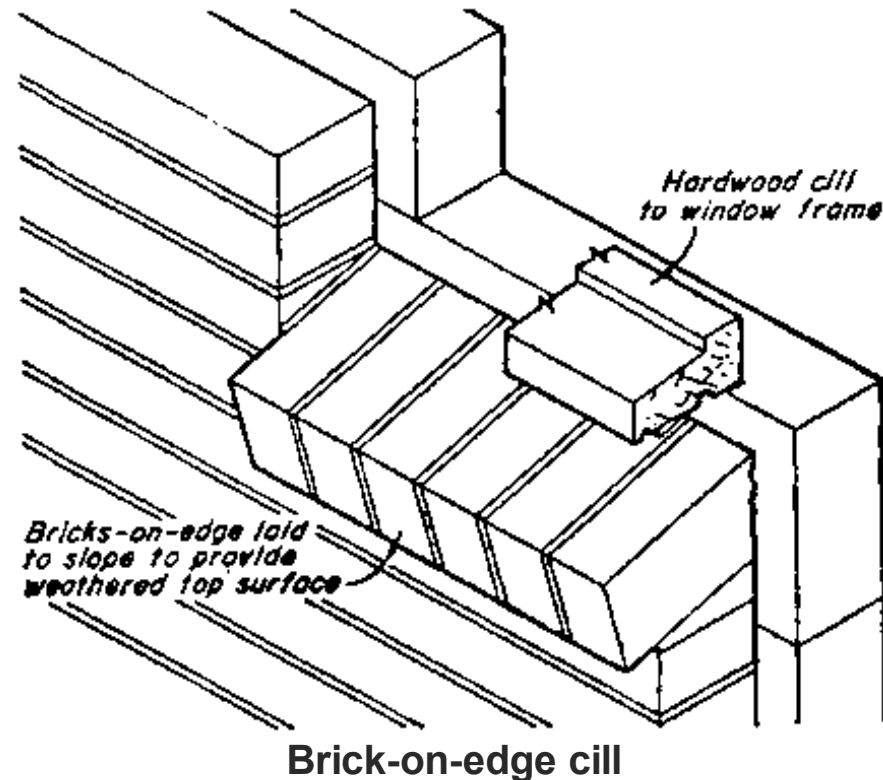

- To prevent backward flow across the underside of this projection through wind or capillary attraction a drip is formed at the bottom front edge of the sill projection (a halfround groove 12mm in diameter is

satisfactory)

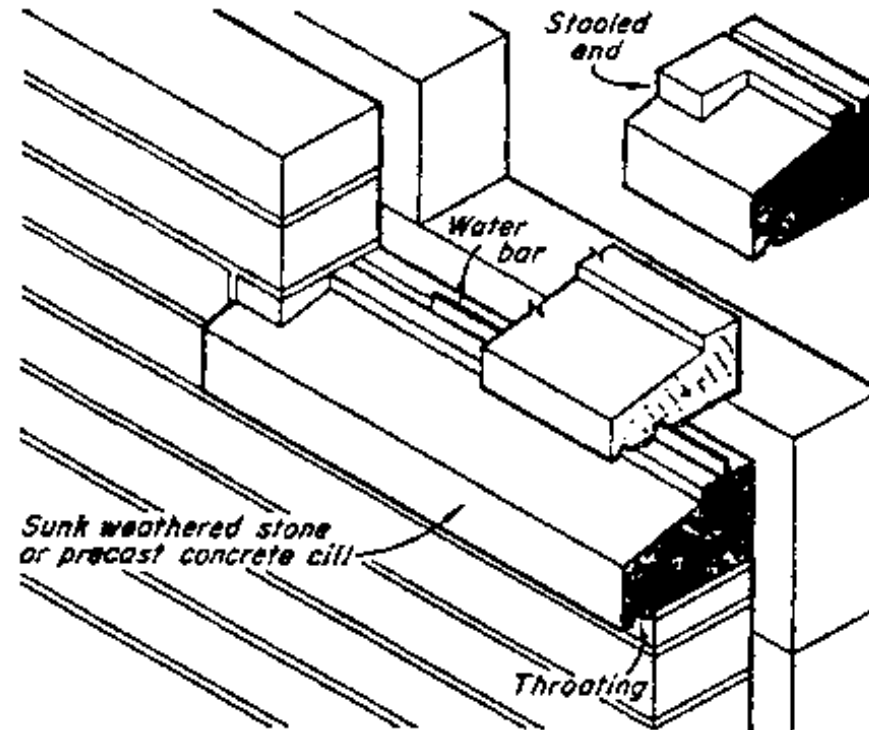

- The joint between sill and window frame is normally sealed with mastic. A feather barrier to water penetration may be incorporated in form of a strip of galvanised steel called a **WATER BAR** (20mm x 32mm to 32mm x 6.4mm) bedded half its depth in cement mortar in a groove formed in stone, concrete

or moulded clay sills the upper projecting half engaging in a similar groove in the under side of the window frame, which is filled with white lead and oil or a mastic before the frame is bedded on the sill.

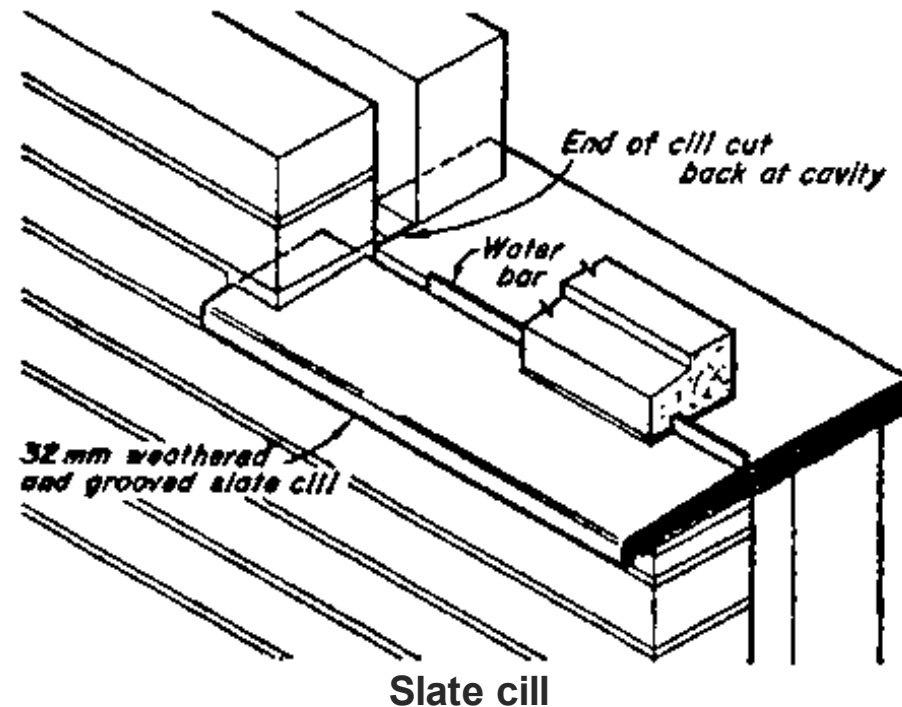

- As an additional means of protecting the joint, the weathered top surface of the sill, may be sunk slightly at the top. This has the effect of raising the joint above the water-retaining surface and serves to break the force of water blown back to the joint.

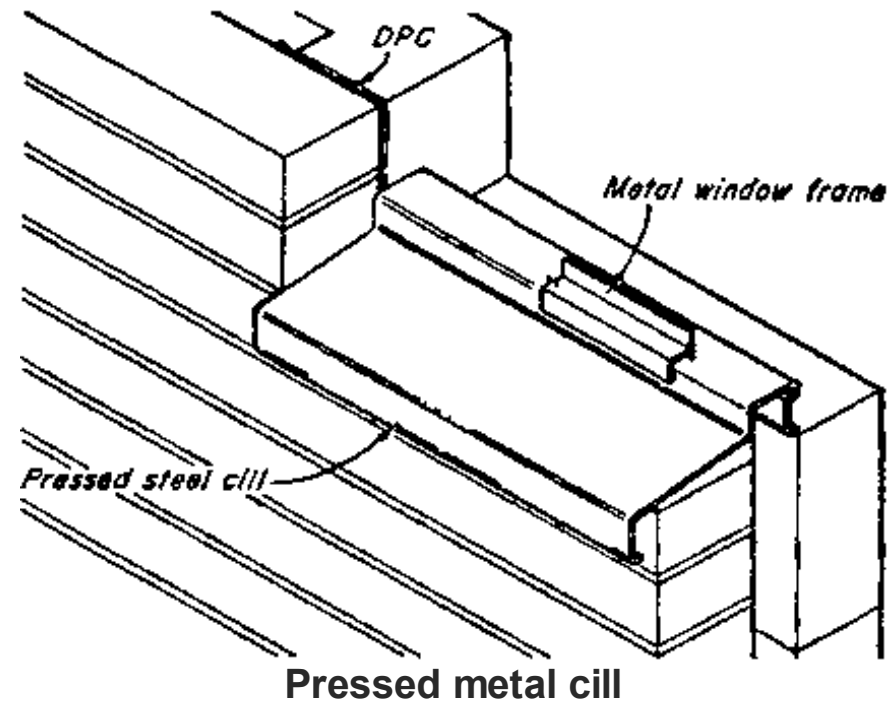

- Lipped quarry tiles may be used, to achieve this and to fulfil the function of a water bar at the same time.

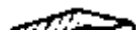

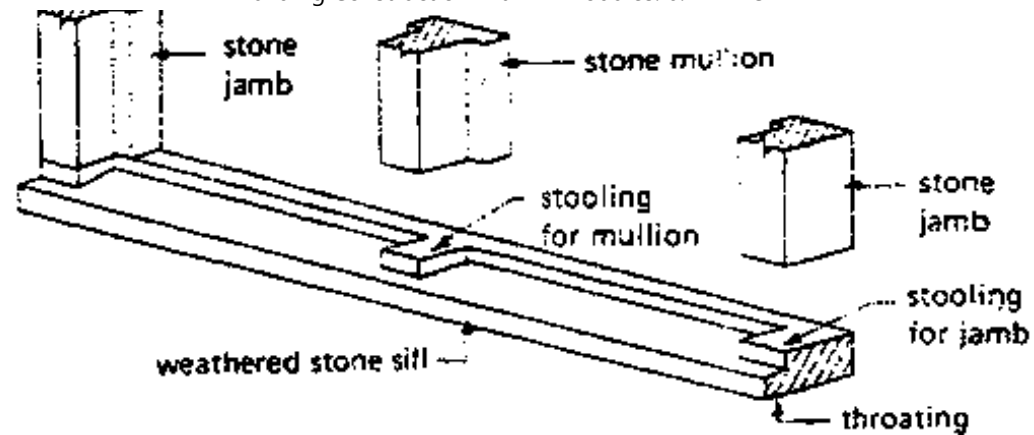

- The weathering to a stone or precast concrete sill may be stopped short of the ends to provide a flat seating for the brick jambs. This is called **STOOL** or **STOOLING**.

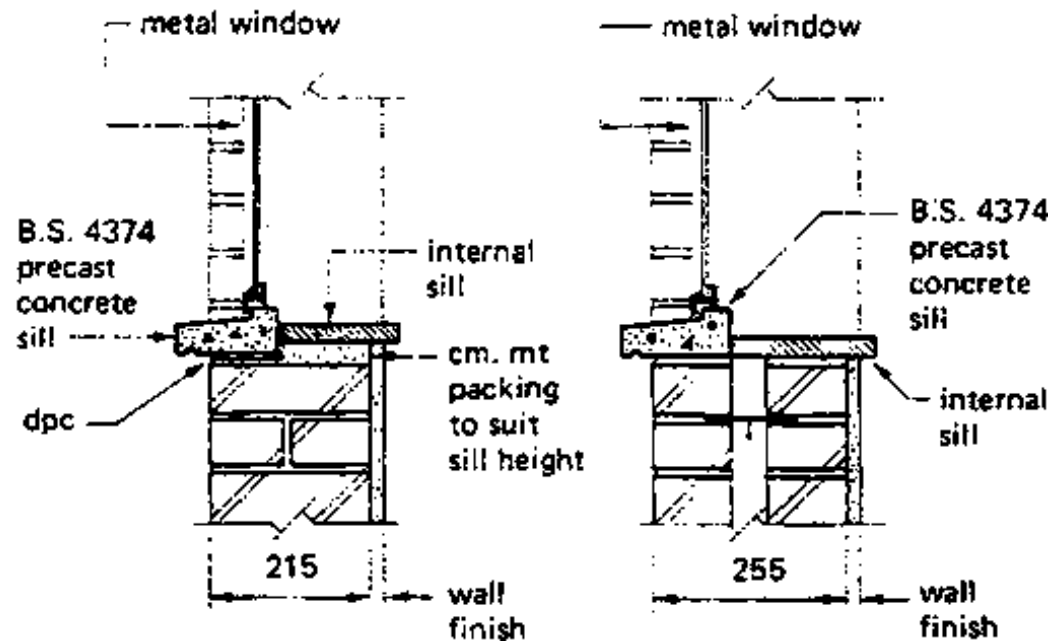

- Natural stone and precast concrete sills are similar in section and are normally not less than 75mm fluck with the depth varying according to the depth of the window reveal.

- Slate (by its nature) can be used in thin sections and slate sills may be safely carried across a cavity to form the internal sill.

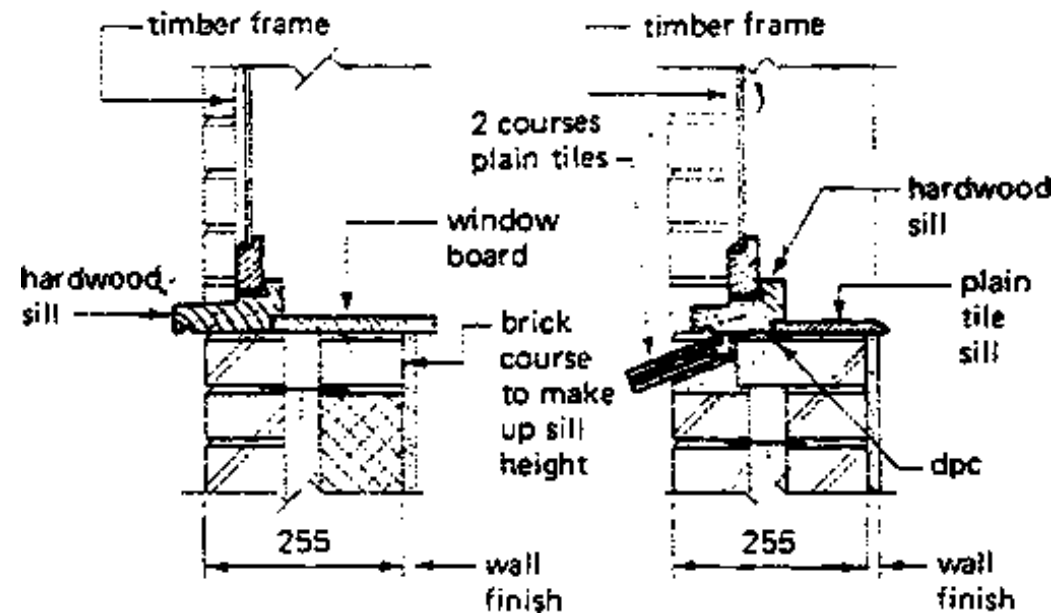

- Metal sills may be of

- cast metal
- hand-formed out of sheet copper or zinc.
- pressed out of sheet steel

- and secured to the wall by MS bracket.

- When the windowframe is set close to the outer face of the wall the main sill (external sill) may be eliminated and its functions be fulfilled by a projecting timer sill to the windowframe.

- There are different ways of finishing the internal sill of windows. The figures show examples of typical internal sill constructions.

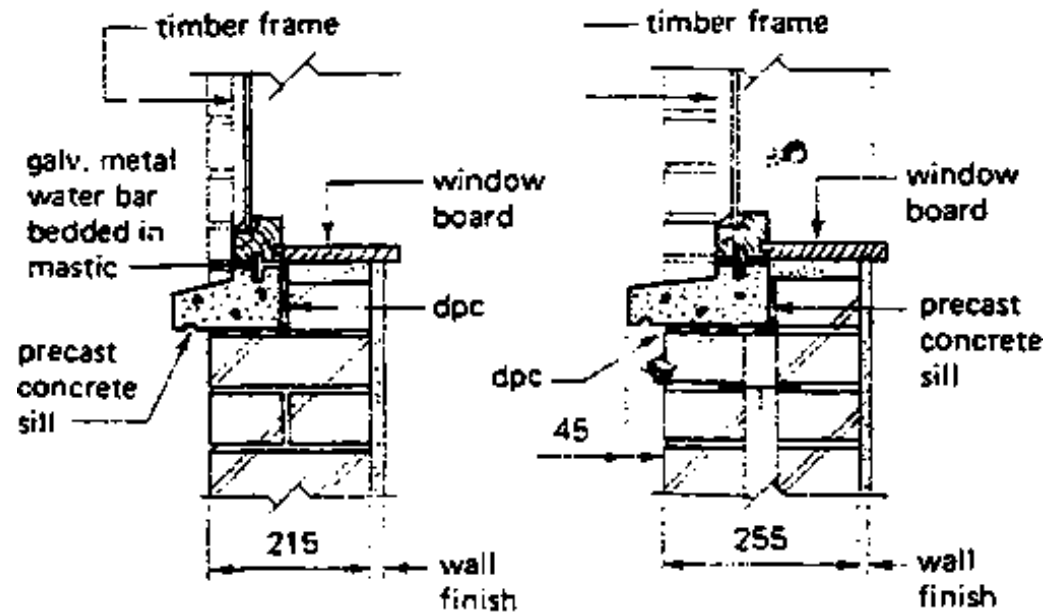

6.8.3.2 Thresholds

Are defined as the Bottom of a Door Opening.

The width of a threshold should be wide enough to accommodate a human foot and be weathered on

- The width of a threshold should be wide enough to accommodate a human foot and be weathered on the top surface.

- Usually external doors open inwards and the incorporation of a water bar in the threshold and a weather-board (or weather mould) on the door is advisable in order to prevent the entry of water under the door.

- A hardwood threshold is some times incorporated as a part of the door frame, especially where the door is set within a prefabricated wall unit including door, window and in filling panel. This is useful when the distance between ground and floor levels is somewhat greater than a reasonable rise for a single step. (See fig.)

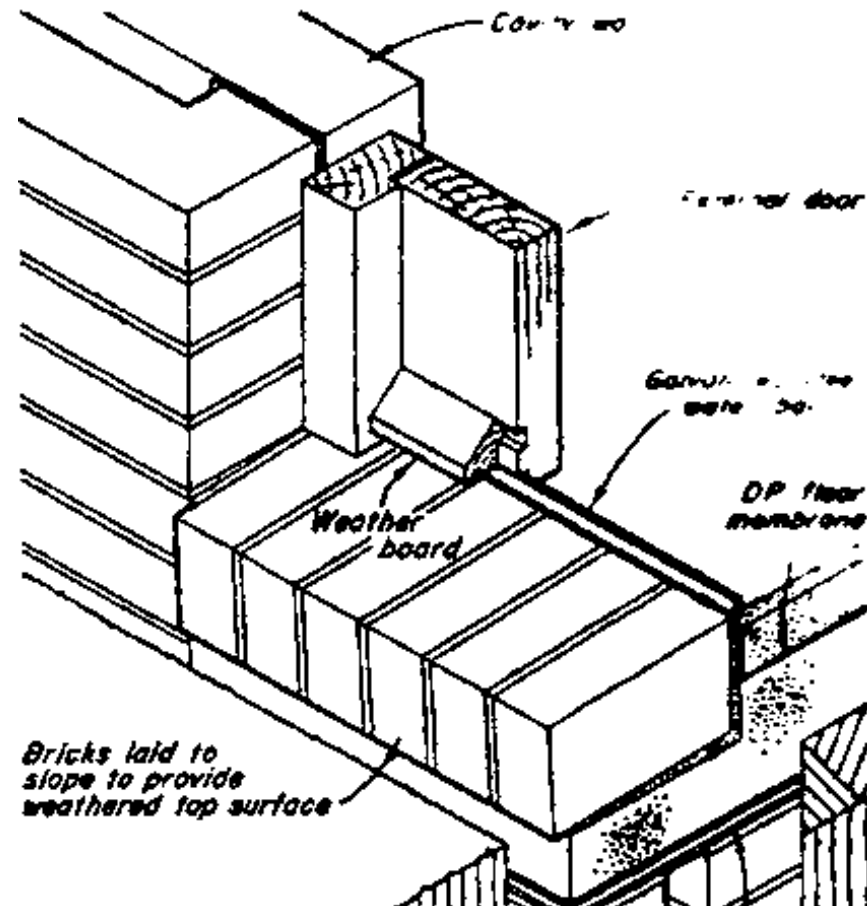



- The provision of a timber threshold results in a drop in level immediately below the weatherboard and if the later is made to project slightly beyond this, water from the door does not fall on to the water retaining surface immediately in front of the water bar.
- People are less likely to trip over a water bar set in a relatively large and visible timber threshold than when it is set in a flush threshold as shown in the fig.

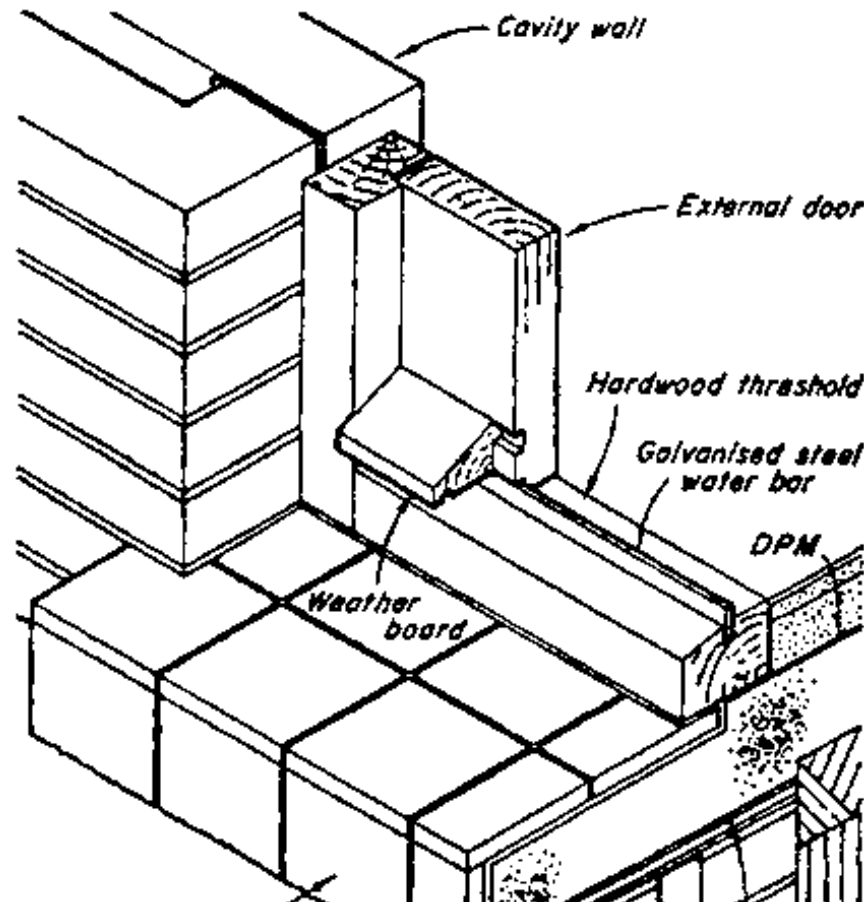



- In case of external doors it is applied to those members with the function of forming a firm and durable base to the doorway and to exclude water.

- Suitable materials are:

- stone
- concrete

- brick
- quarry tile
- timber.

- As the floor level is normally above the ground level outside the door an external threshold usually incorporates a step. This may be formed in various ways, either:

- as an extension of the concrete floor slab or
- as a separate member of some other material shown in detail in the figure.

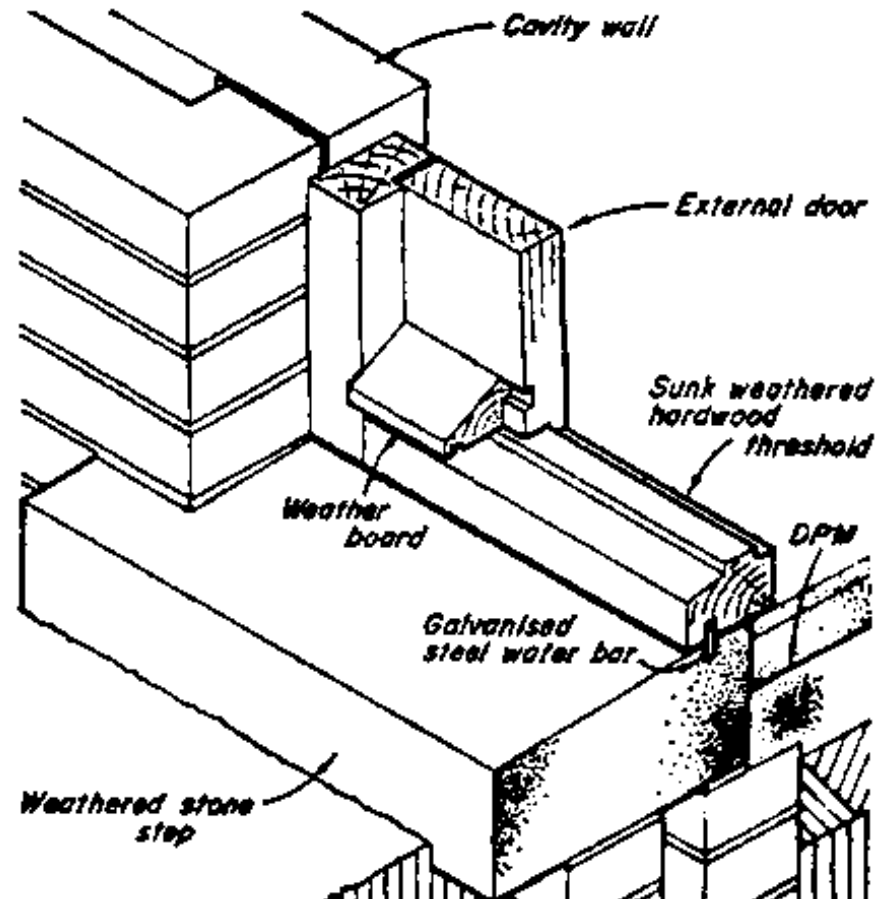



• REPETITION • • exercises • • REPETITION •

Try to answer the following questions and use sketches where ever necessary and possible

1. Function and properties of walls:

1.1 Name the functions of a wall

1.2 List and give brief explanations (by means of sketches) on the functional requirements of walls

2. Behavior of walls under load:

2.1 Explain the following terms:

- a) crushing;
- b) buckling;
- c) settling;
- d) excentric loading
- e) slenderness ratio;
- f) sliding;
- g) frictional resistance
- h) passive soil pressure
- i) overturning by 1. rotation, 2. settlement

3. Write notes on Calculation of wall thickness and summarize briefly the design process

2.2 Write notes on Calculation of wall thickness and summarize briefly the design process.

3. Types of walls

3.1 Divide walls into different types

3.2 Explain the differences between:

- a) partition walls;
- b) party walls
- c) separating walls;

- d) division walls.

3.3 Describe briefly the characteristics of

- a) Retaining walls
- b) masonry walls
- c) monolithic walls
- d) frame walls
- e) membrane walls
- f) cavity walls
- g) cross walls
- h) parapets.

4. Stonework

4.1 Classify Building stones and explain briefly their characteristics.

4.2 Write notes on the use and treatment of Building stones.

4.3 What is the difference between 'Reconstructed' and 'Artificial' stones.

4.4 List and describe the main Defects in stone**4.5 Explain the following terms:**

- a) arris;
- b) ashlar;
- c) bed joint;
- d) bonder
- e) cramp;
- f) dowl;
- g) yoggle;
- h) lacing

- i) natural bat;
- j) quarry seep;
- k) quoin
- l) stool
- m) string course
- n) weathering

4.6 Give the characteristics of RUBBLE WALLING**4.7 Give the characteristics of ASHLAR WALLING****5. Brickwork****5.1 Define a Brick (according to BS 3921, Part 2)****5.2 Give the size of Standard Bricks**

- a) British standard;
- b) German standard

5.3 Explain by means of sketches:

- a) 1/2 bat
- b) 3/4 bat;
- c) bevelled bat (large)
- d) bevelled bat (small);
- e) queen closer (half)
- f) queen closer (quartes)
- g) bevelled closer;
- h) mitred closer;

- i) king closer
- j) double bulluouse
- k) splay - stretcher
- l) splay header;

5.4 Describe briefly how bricks are manufactured.

5.5 What is meant with EFFLORESCENCE?

5.6 According to BS 392, Part 2 there are different types of bricks, such as: - solid/- perforated/- hollow/- cellular bricks. Explain the differences!

5.7 What are calcium silicate bricks? What are concrete bricks?

5.8 Write brief notes on Mortars used in brickwork and give typical mixes.

5.9 Explain how to overcome the penetration of dampness in walls, which are affected

- a) by rain, penetrating the HEAD of the wall,

- b) by rain, beating against external walls,
- c) by ground moisture of the base of the wall.

5.10 Sketch common bonds in brickwork such as

- a) Header Bond;
- b) Header Bond;
- c) English Bond;
- d) cross bond
- e) Flemish Bond; and list other kinds of brickwork bonding.

5.11 Explain the Metric Modular Brickwork and compare British standard and the German system.

6. Blockwork

6.1 What is the difference between Brickwork and Blockwork?

6.2 Characterize different types of blocks such as

- a) clay blocks;
- b) precast concrete blocks;
- c) aerated concrete blocks.

7. Concrete walls

7.1 How are concrete walls broadly classified?

7.2 What can be used as precaution against cracking in concrete walls?

7.2 What can be used as precaution against cracking in concrete walls?

7.3 Write notes on FORMWORK and sketch three different straight forward methods used for concrete walls.

7.4 Explain the following terms.

- a) Plain monolithic concrete walls;
- b) Dense concrete walls;
- c) Light - weight aggregate concrete walls
- d) Non - fines concrete walls
- e) in - situ cast reinf. concrete external walls?
- f) concrete box frames
- g) large precast panel structures.

8. Openings in walls.

8.1 What are the members of an opening in a wall?

8.2 Explain (by using sketches) the function and the way of construction of R.C. Lintels

8.3 List different forms of archs

8.4 What are JAMBS?

8.5 Explain the function of

- a) a sill and
- b) a threshold.

8.6 List suitable materials for the construction of

- a) sills and
- b) thresholds.

d) thresholds**8.7 Sketch and explain different typical sill details, such as:**

- a) plain tile sill
- b) lipped quarry tile sill
- c) Brick - on edge sill
- d) sunk weathered stone or precast concrete sill
- e) weathered precast concrete sill
- f) slate sill
- g) pressed steel sill

8.8 Sketch and explain different typical threshold details, such as:

- a) Brick - on edge threshold
- b) concrete step, faced with quarry tiles
- c) weathered stone step

8.9 Explain (if necessary by sketching) the terms:

- a) internal sill;
- b) stool or stooling,
- c) water - bar:
- d) weather - board;
- e) hardwood threshold.

Please provide your feedback

English | French | Spanish | German