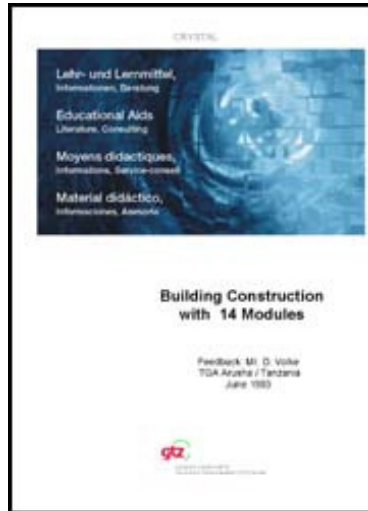

[Home page](#) | [Help](#) | [Clear](#)[English](#) | [French](#) | [Spanish](#) | [German](#)[Search](#) | [Subjects](#) | [Titles A-Z](#) | [Courses](#) | [Illustrations](#) | [Topics](#) | [e-Course builder](#)[Contract TOC](#)[Expand Document](#)[Contract Chapter](#)[Add to e-Course](#)[Preferences](#)

Printable version

Export document
as HTML file [Help](#)

Export document
as PDF file

Building Construction with 14 Modules (TCA; 1983; 618 pages)

1. ARCHITECTURAL DRAWING I

1.1 AIMS AND PURPOSE OF ARCHITECTURAL DRAWINGS

1.1.1 CONTENTS OF ARCHITECTURAL DRAWINGS

1.2 DRAWING EQUIPMENT

1.2.1 PENCILS

1.2.2 DRAWING PENS

1.2.3 COMPASSES

1.2.4 DRAWING BOARDS

1.2.5 T-SQUARES

1.2.6 SET SQUARES

1.2.7 PROTRACTORS

1.2.8 SCALES

1.2.9 FRENCH CURVES

1.2.10 TEMPLATES

1.2.11 DRAWING PINS AND OTHER FIXINGS

1.2.12 MINOR ITEMS OF EQUIPMENT

1.2.13 PRINTING PAPERS

1.2.14 TRACING PAPER, CLOTH AND FILM

 **1.2.15 BACKING SHEETS**

 **1.2.16 DRAWING PAPERS**

 **1.2.17 CARTRIDGE**

 **1.2.18 HANDMADE AND MOULDMADE PAPERS**

 **1.2.19 PLASTIC-COATED CARD**

 **1.3 LETTERING**

 **1.3.1 PRINCIPLE OF LETTERING**

 **1.3.2 FREEHAND LETTERING**

 **1.3.3 TYPES OF LETTERS**

 **1.3.3.1 The Roman Alphabet**

 **1.3.3.2 Sans Serif Letters**

 **1.3.3.3 Inclined Lettering**

 **1.3.3.4 Script Lettering**

 **1.3.3.5 Stencil Lettering**

 **1.3.3.6 Guided Pen Lettering**

 **1.3.3.7 Pressure-Transfer Lettering**

 **1.4 LINEWORK AND DIMENSIONING**

 **1.4.1 TYPES OF LINES**

 **1.4.2 PENCIL DRAWING**





 **1.4.3 INKING - IN**

 **1.4.4 BASIC RULES OF DIMENSIONING**

 **1.4.4.1 Types of Dimensions**

 **1.4.4.2 Placement of Dimensions**

 **1.5 ENLARGEMENT AND REDUCTION OF LINE DRAWINGS** **1.6 GEOMETRICAL CONSTRUCTIONS** **1.6.1 LINES AND ANGLES** **1.6.1.1 To bisect a straight line AB** **1.6.1.2 To divide a straight line AB into a given number of equal parts** **1.6.1.3 To divide a straight line AB into any ratio** **1.6.1.4 To construct an angle of 90°**  **1.6.1.5 To construct an angle of 45°**  **1.6.1.6 To construct an angle of 60°**  **1.6.1.7 To construct an angle of 30°**  **1.6.1.8 To bisect any given angle** **1.6.1.9 To construct an angle SIMILAR to a given angle** **1.6.1.10 To draw a line PARALLEL to a given line** **1.6.2 TRIANGLES** **1.6.2.1 To construct an EQUILATERAL triangle** **1.6.2.2 To construct a triangle with given BASE ANGLES and ALTITUDE** **1.6.2.3 To inscribe a circle in a given triangle ABC** **1.6.2.4 To circumscribe a triangle ABC** **1.6.3 CIRCLES** **1.6.3.1 Basic CIRCLE-Constructions** **1.6.3.2 To draw a tangent to a point A on the circumference of a circle centre O**

-  **1.6.3.3 To draw an internal tangent to two circles of equal diameter**
-  **1.6.3.4 To find the centre of a given circle arc**
-  **1.6.3.5 To join two straight lines at RIGHT ANGLES to each other by an arc of given radius**
-  **1.6.3.6 To draw a curve of given radius joining two circles**
-  **1.6.3.7 To join two straight lines by two arcs of equal radius**

1.6.4 BASIC ARCH CONSTRUCTIONS

2. ARCHITECTURAL DRAWING II

2.1 TYPES OF PROJECTIONS

2.2 ORTHOGRAPHIC PROJECTION

2.2.1 CONSTRUCTION OF ORTHOGRAPHIC PROJECTION

2.2.2 ELEVATIONS

2.2.3 PLANS AND SECTIONS

2.3 PICTORIAL DRAWING

2.3.1 AXONOMETRIC PROJECTION

2.3.2 ISOMETRIC PROJECTION

2.3.3 DIMETRIC PROJECTION

2.3.4 OBLIQUE PROJECTION

2.3.4.1 Length of Receding Lines























2.3.4.2 Construction of Oblique Drawings

2.3.4.3 Rules of Oblique Drawing

2.3.4.4 Scale of the Receding Lines

2.3.4.5 Direction of Receding Lines

 **2.3.4.6 Position of Axes** **2.4 PERSPECTIVE DRAWING** **2.4.1 PERSPECTIVE TERMS** **2.4.2 PHENOMENA OF PERSPECTIVE DRAWING** **2.4.3 SYSTEMS OF PERSPECTIVE DRAWINGS** **2.4.4 METHODS OF PERSPECTIVE DRAWINGS** **2.4.5 TWO-POINT PERSPECTIVE** **2.4.6 ONE-POINT PERSPECTIVE** **2.5 SHADES AND SHADOWS** **2.5.1 THE USE OF SHADOWS** **2.5.2 SHADES AND SHADOWS** **2.5.3 THE CONVENTIONAL DIRECTION OF LIGHT** **2.5.4 THE 45° DIRECTION** **2.5.5 THE TRUE DIRECTION OF LIGHT** **2.5.6 SHADOWS OF SOLIDS** **2.5.7 PLANES OF SHADOW** **2.5.8 PRINCIPLES OF SHADOW-CASTING** **2.6 DRAWING PRACTICE** **2.6.1 DRAWING SHEETS** **2.6.1.1 Sizes and Folds** **2.6.1.2 Layout and Identification** **2.6.2 LEVELS** **2.6.3 REFERENCING**

-  **2.6.4 ABBREVIATIONS**
-  **2.6.5 REPRESENTATION OF MATERIALS**
-  **2.6.6 GRAPHICAL SYMBOLS AND REPRESENTATION**
-  **2.6.7 HATCHING RULES**
-  **2.7 APPLICATION FOR BUILDING PERMIT**
 -  **2.7.1 PROCEDURE OF APPLYING FOR PERMISSION TO ERECT A BUILDING**
 -  **2.7.2 FORMULARS**
-  **4. CONTRACT PLANNING AND SITE ORGANISATION**
 -  **4.1 CONTRACT PLANNING**
 -  **4.1.1 BAR CHART**
 -  **4.1.2 NETWORK ANALYSIS**
 -  **4.1.3 THE OVERALL PROGRAMME**
 -  **4.1.3.1 Break down of job**
 -  **4.1.3.2 Quantities of work and time content**
 -  **4.1.3.3 Plant and Labour outputs**
 -  **4.1.3.4 Sequence and timing of operations**
 -  **4.1.3.5 The programme chart**
 -  **4.1.4 PLANNING CONSIDERATIONS**
 -  **4.1.4.1 Site conditions and access**
 -  **4.1.4.2 Nature of job**
 -  **4.1.4.3 Plant**
 -  **4.1.4.4 Scaffolding**

 **4.2 SITE ORGANIZATION** **4.2.1 PRELIMINARY WORK** **4.2.2 SITE PLANNING** **4.2.2.1 Period planning** **4.2.2.2 Weekly planning** **4.2.2.3 Progress control** **4.2.3 SITE LAYOUT** **5. FOUNDATIONS** **5.1 SOIL INVESTIGATIONS** **5.1.1 SITE EXPLORATION** **5.1.1.1 Trial holes** **5.1.1.2 Bore holes** **5.1.1.3 Sampling** **5.1.1.4 Tests** **5.1.1.5 Load or bearing test** **5.1.2 SOILS AND SOIL CHARACTERISTICS** **5.1.2.1 Rocks and soils** **5.1.2.2 Stresses and pressures** **5.2 EXCAVATIONS AND TIMBERING** **5.3 TYPES OF FOUNDATIONS** **5.3.1 CLASSIFICATION** **5.3.2 CHOICE OF FOUNDATION** **5.3.3 SPREAD FOUNDATIONS**

 **5.3.3.1 Strip foundations**

 **5.3.3.2 Deep strip foundations**

 **5.3.3.3 Stepped foundations**

 **5.3.3.4 Pad foundations**

 **5.3.3.5 Raft foundations**

 **5.3.4 PILE FOUNDATIONS**

 **5.3.4.1 Short bored pile foundations**

 **5.3.5 PIER FOUNDATIONS**

 **6. WALLS**

 **6.1 FUNCTION AND PROPERTIES OF WALLS**

 **6.2 THE BEHAVIOR OF THE WALL UNDER LOAD**

 **6.2.1 CALCULATION OF WALL THICKNESS**

 **6.3 TYPES OF WALLS**

 **6.4 STONEMWORK**

 **6.4.1 BUILDING STONES**

 **6.4.2 STONEMWORK THERMINOLOGY**

 **6.4.3 STONEMWORK CLASSIFICATION**

 **6.4.4 RUBBLE WALLING**

 **6.4.5 ASHLAR WALLING**

























 **6.4.5.1 Rules for ashlar work**























 **6.5 BRICK WORK**























 **6.5.1 BRICKWORK TERMINOLOGY**

 **6.5.2 MANUFACTURE OF CLAY BRICKS**

 **6.5.2.1 Pressed Bricks** **6.5.2.2 Wire cut bricks** **6.5.2.3 Efflorescence** **6.5.3 BRICK CLASSIFICATION** **6.5.4 CALCIUM SILICATE BRICKS** **6.5.5 CONCRETE BRICKS** **6.5.6 MORTARS FOR BRICKWORK** **6.5.7 DAMPNES PENETRATION** **6.5.8 BRICKWORK BONDING** **6.5.8.1 Common bonds** **6.5.9 METRIC MODULAR BRICKWORK** **6.5.10 JUNCTIONS** **6.5.11 QUOINS OR EXTERNAL ANGLES** **6.5.12 PIERS** **6.5.12.1 Detached piers:** **6.5.12.2 Attached Piers (or Pilasters)** **6.5.12.3 Buttresses** **6.6 BLOCKWORK** **6.6.1 CLAY BLOCKS** **6.6.2 PRECAST CONCRETE BLOCKS** **6.6.3 AERATED CONCRETE BLOCKS** **6.7 CONCRETE WALLS** **6.7.1 GENERAL**

-  **6.7.1 GENERAL**
-  **6.7.2 FOREWORK**
-  **6.7.3 PLAIN MONOLITHIC CONCRETE WALL**
 -  **6.7.3.1 Dense concrete walls**
 -  **6.7.3.2 Light-weight aggregate**
 -  **6.7.3.3 No-fines concrete walls**
 -  **6.7.3.4 Thickness of plain concrete walls**
 -  **6.7.3.5 Shrinkage reinforcement**
-  **6.7.4 REINFORCED CONCRETE WALLS**
 -  **6.7.4.1 In-Situ Cast external walls**
 -  **6.7.4.2 Concrete Box Frames**
 -  **6.7.4.3 Large precast panel structure**
-  **6.8 OPENINGS IN WALLS**
 -  **6.8.1 HEAD**
 -  **6.8.1.1 Lintels**
 -  **6.8.1.2 Arches**
 -  **6.8.2 JAMBS**
 -  **6.8.3 SILLS AND THRESHOLDS**
 -  **6.8.3.1 Sills**
 -  **6.8.3.2 Thresholds**
-  **7. FLOORS**
 -  **7.1 GENERAL**
 -  **7.2 SOLID GROUND FLOORS**
 - 

-  **7.2.1 SITE CONCRETE**
-  **7.2.2 HARDCORE**
-  **7.2.3 WATERPROOF MEMBRANE**
-  **7.3 SUSPENDED TIMBER GROUND FLOOR**
 -  **7.3.1 BUILDING REGULATIONS**
 -  **7.3.2 LAY OUT**
-  **7.4 UPPER FLOORS**
 -  **7.4.1 TYPES OF UPPER FLOORS**
 -  **7.4.2 STRUCTURE OF UPPER FLOORS**
 -  **7.4.3 SUSPENDED TIMBER UPPER FLOORS**
 -  **7.4.3.1 Floor Joists**
 -  **7.4.3.2 End Support of Floor Joists**
 -  **7.4.3.3 Trimming**
 -  **7.4.4 REINFORCED CONCRETE UPPER FLOORS**
 -  **7.4.4.1 Monolithic Reinforced Concrete Upper Floors**
 -  **7.4.4.2 Precast Concrete Upper Floors**
 -  **7.4.4.3 Hollow Block and Waffle Floors**
-  **7.5 FLOOR FINISHES**
 -  **7.5.1 JOINTLESS FLOOR FINISHES**
 -  **7.5.1.1 The most common of these is the Cement/Sand Screed**
 -  **7.5.1.2 Granolithic Concrete Finishes**
 -  **7.5.1.3 Terazzo**
 -  **7.5.2 SLAB FLOORS FINISEHES**

-  **7.5.3 SHEET FLOOR FINISHES**
-  **7.5.4 WOOD FLOOR FINISHES**
-  **8. OPEN FIREPLACES, CHIMNEYS AND FLUES**
 -  **8.1 FUNCTION OF FIREPLACES AND FLUES**
 -  **8.2 PRINCIPLES OF FIREPLACE DESIGN**
 -  **8.2.1 TRADITIONAL OPEN FIREPLACE**
 -  **8.2.2 IMPROVED SOLID FUEL APPLIANCES**
 -  **8.3 PRINCIPLES OF FLUE DESIGN**
 -  **8.4 CONSTRUCTION OF FLUE DESIGN**
 -  **8.4.1 NON-CONVECTOR OPEN FIRES**
 -  **8.4.2 CONVECTOR OPEN FIRES**
 -  **8.5 CONSTRUCTION OF CHIMNEYS**
-  **9. ROOFS**
 -  **9.1 FUNCTIONAL REQUIREMENTS**
 -  **9.1.1 STRENGTH AND STABILITY**
 -  **9.1.2 WEATHER RESISTANCE**
 -  **9.1.3 THERMAL INSULATION**
 -  **9.1.4 FIRE RESISTANCE**
 -  **9.1.5 SOUND INSULATION**
 -  **9.2 TYPES OF ROOF STRUCTURES**
 -  **9.2.1 FLAT AND PITCHED ROOFS**
 -  **9.2.2 STRUCTURE OF THE ROOF**
 -  **9.2.3 LONG AND SHORT SPAN ROOFS**

 **9.2 LONG AND SHORT OF A ROOF** **9.3 FLAT ROOFS** **9.3.1 PHYSICAL AND STRUCTURAL PROBLEMS** **9.3.2 STRUCTURE OF A FLAT ROOF** **9.3.3 THERMAL INSULATION MATERIAL** **9.3.4 SINGLE AND DOUBLE FLAT ROOF CONSTRUCTION** **9.3.5 PARAPET WALLS** **9.4 PITCHED ROOFS** **9.4.1 SHAPES OF PITCHED ROOFS IN TIMBER** **9.4.2 TERMS** **9.4.3 TYPES OF PITCHED ROOFS IN TIMBER (STRUCTURES)** **9.4.3.1 Mono-(single) pitched Roof** **9.4.3.2 Lean - to Roof** **9.4.3.3 Couple Roof** **9.4.3.4 Close couple Hoof** **9.4.3.5 Collar Roof** **9.4.3.6 Double or Purlin Roof** **9.4.3.7 Tripple or Trussed Roofs** **9.4.3.8 Trussed Rafters** **9.4.3.9 Hipped Roofs** **9.4.4 VALLEY** **9.4.5 EAVES TREATMENT** **9.4.6 OPENINGS IN TIMBER ROOFS** **9.5 ROOF COVERINGS**

9.5 ROOF COVERINGS **9.5.1 FUNCTION OF ROOF COVERINGS** **9.5.2 TYPES OF ROOF COVERINGS** **9.5.3 SUBSTRUCTURES** **9.5.4 CHOICE OF ROOF COVERINGS** **9.5.5 MATERIALS AND COVERING METHODS** **10. FRAMED STRUCTURES** **10.1 STRUCTURAL CONCEPT** **10.2 FUNCTIONAL REQUIREMENTS** **10.3 STRUCTURAL MATERIALS** **10.4 LAYOUT OF FRAMES** **10.5 BUILDING FRAMES** **10.5.1 FUNCTIONS OF BUILDING FRAME MEMBERS** **10.5.2 REINFORCED CONCRETE FRAMES** **10.5.2.1 Reinforced Concrete Beams** **10.5.2.2 Reinforced Concrete Columns** **10.5.2.3 Reinforced Concrete Slabs** **10.5.3 PRECAST CONCRETE FRAMES** **10.5.3.1 Methods of Connections** **10.5.4 STRUCTURAL STEELWORK FRAMES** **10.5.4.1 Structural Steel Frames** **10.5.4.2 Castellated Universal Sections** **10.5.4.3 Connections**



10.5.4.4 Structural Steel Connections



10.5.4.5 Frame Erection



10.5.4.6 Fire Protection of Steelwork



10.5.5 TIMBER FRAMES



10.5.5.1 Columns and Beams



10.5.5.2 Connections



10.5.5.3 Building frames in timber



10.5.5.4 Prefabrication



10.6 PORTAL FRAMES



10.6.1 THEORY



10.6.2 CONCRETE PORTAL FRAMES



10.6.3 STEEL PORTAL FRAMES



10.6.4 TIMBER PORTAL FRAMES



11. PROTECTION OF BUILDINGS



11.1 EXCLUSION OF WATER



11.1.1 PRECIPITATION



11.1.1.1 Roof Drainage



11.1.1.2 Flooding



11.1.1.3 Drought



11.1.2 DAMP RISING AND MOISTURE MIGRATION



























11.1.3 CONDENSATION



11.2 THERMAL INSULATION



11.2.1 DEFINITION

-  **11.2.1 DEFINITION**
-  **11.2.2 INSULATING MATERIALS**
-  **11.3 SOUND INSULATION**
 -  **11.3.1 DEFINITION**
 -  **11.3.2 SOUND INSULATION**
 -  **11.3.3 EXTERNAL NOISE**
-  **11.4 FIRE PROTECTION**
 -  **11.4.1 STRUCTURAL FIRE PROTECTION**
 -  **11.4.1.1 Fire Load**
 -  **11.4.1.2 Fire Resistance of Material**
 -  **11.4.1.3 Appropriate Types of Construction**
-  **12. FINISHING & FINISHES**
 -  **12.1 EXTERNAL WALL FINISHES**
 -  **12.1.1 EXTERNAL RENDERING**
 -  **12.1.2 CONCRETE FINISHES**
 -  **12.1.3 CLADDING**
 -  **12.1.3.1 CLADDINGS FIXED TO A STRUCTURAL BACKING**
 -  **12.1.3.2 CLADDINGS TO FRAMED STRUCTURES**
 -  **12.1.4 EXTERNAL PAINTS AND FINISHES**
 -  **12.2 INTERNAL WALL FINISHES**
 -  **12.2.1 PLASTERING**
 -  **12.2.2 OTHER INTERNAL WALL FINISHES**
 -  **12.2.3 PAINTING**
 -  **12.3 CEILING FINISHES**

 **12.3 CEILING FINISHES** **13. STAIRS** **13.1 INTRODUCTION** **13.2 DEFINITION OF TERMS** **13.3 TYPES OF STAIRS** **13.4 DESIGN OF STAIRS** **13.4.1 RISE - TREAD - PROPORTION** **13.4.2 SLOPE OR PITCH** **13.4.3 LANDINGS** **13.4.4 WIDTH** **13.4.5 WALKING LINE** **13.5 CONSTRUCTION OF STAIRS** **13.5.1 BRICK STAIRS** **13.5.2 STONE STAIRS** **13.5.3 CONCRETE STAIRS** **13.5.3.1 In Situ Cast R.C. Stairs** **13.5.3.2 Precast Concrete Stairs** **13.5.4 TIMBER STAIRS** **13.5.5 METAL STAIRS** **13.6 MISCELLANEOUS** **13.6.1 BALUSTRADES/HANDRAILS** **13.6.2 'SAMBA' STAIR, LADDERS, DISAPPEAR STAIRS, RAMPS** **13.6.3 ESCALATORS** **14 DOORS & WINDOWS**

 **14. DOORS & WINDOWS** **14.1 DOORS** **14.1.1 EXTERNAL DOORS** **14.1.2 INTERNAL DOORS** **14.1.3 PURPOSE MADE DOORS** **14.1.4 METHODS OF CONSTRUCTION** **14.1.4.1 Door terminology** **14.1.4.2 Panelled and glazed wood doors** **14.1.4.3 Flush doors** **14.1.4.4 Fire-check flush doors** **14.1.4.5 Matchboarded doors** **14.1.5 FRAMES AND LININGS** **14.1.5.1 Timber Door Frames** **14.1.5.2 Metal door frames** **14.1.5.3 Door linings** **14.1.6 SPECIAL DOORS** **14.2 WINDOWS, GLASS & GLAZING** **14.2.1 PRIMARY FUNCTIONS OF WINDOWS** **14.2.2 BUILDING REGULATIONS** **14.2.3 TRADITIONAL CASEMENT WINDOWS** **14.2.4 STANDARD WOOD CASEMENT WINDOWS** **14.2.5 STEEL CASEMENT WINDOWS** **14.2.6 BAY WINDOWS**



14.2.7 SLIDING SASH WINDOWS

 **14.2.7.1 Vertical sliding windows (also called double hung sash windows)**

 **14.2.7.2 Horizontal sliding windows**

 **14.2.8 PIVOT WINDOWS**

 **14.2.9 LOUVRES**

 **14.2.10 GLASS AND GLAZING**

 **14.2.10.1 Glass**

 **14.2.10.2 Glazing**

 **14.2.11 MOSQUITO SCREENING (FLY SCREENS)**

 **14.2.12 SUN-BREAKERS**

 **14.3 IRON MONGERY**

 **14.3.1 HINGES**

 **14.3.2 LOCKS AND LATCHES**

 **14.3.3 MISCELLANEOUS**

7. FLOORS

REFERENCES:

1. E.L. Fullerton

"Building Construction in Warm Climates"

Vol. 1

2. R. Barry

"The Construction of Buildings"

Vol. 1

3. Jack Stroud Foster

MITCHELL'S BUILDING CONSTRUCTION

"Structure and Fabric"

Part 1

4. N.S. Whyte and Vincent Powell-Smith

"The Building Regulations"

5th Edition

5. BRE Digest

"Building Construction"

6. E. Neufert

"Architect's Data"

7.1 GENERAL

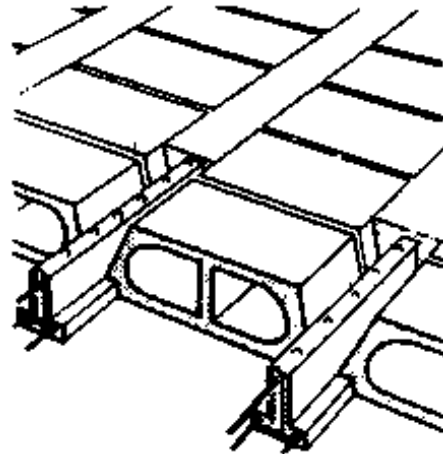

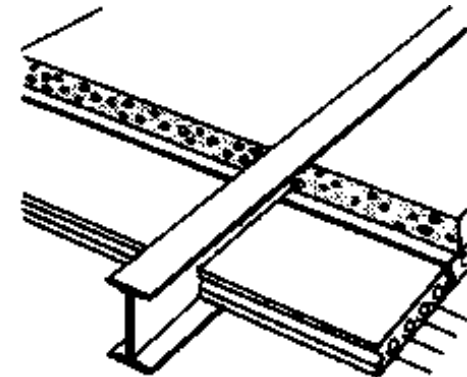
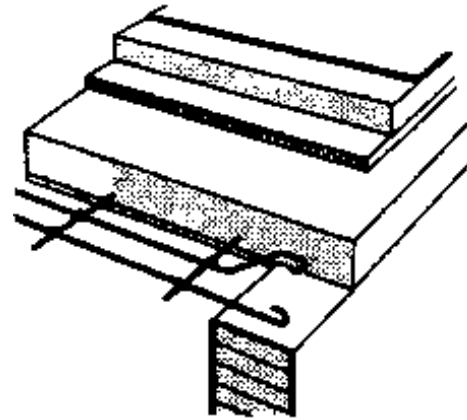
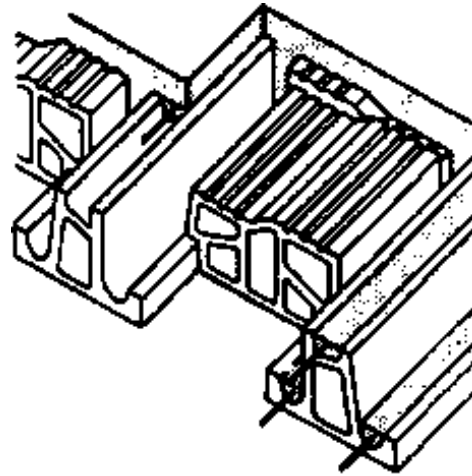

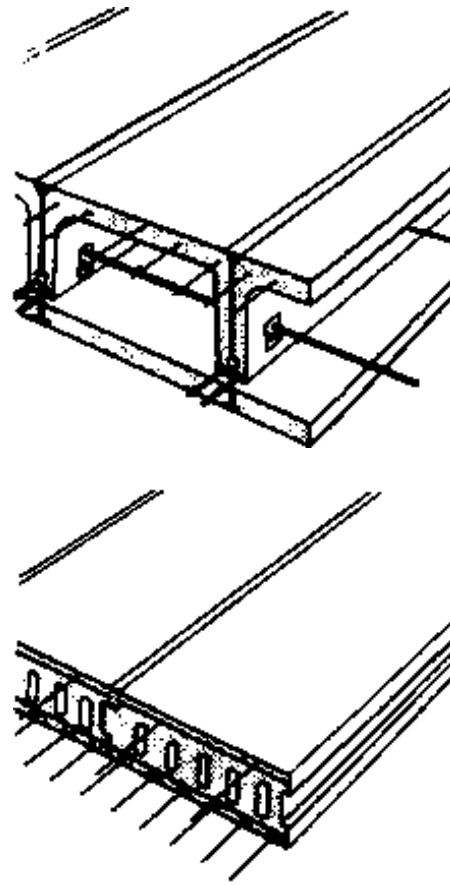

- Traditionally the **GROUND-FLOOR** of most small "buildings were formed directly of the ground, the soil being rammed until it was firm and sometimes on it where laid flag-stones or bricks to form a hard surface.

This was unsatisfactory, because the moisture which was continuously withdrawn from the soil below the building made the floor **DAMP**, uncomfortable and unhealthy. Therefore other types of floors have been developed in order to make buildings more comfortable and healthy.

- The **CONSTRUCTION** of a floor - especially in warm climates - will depend largely on its purpose and the material available. The **chief factors** affecting its design are

- **strength**
- **comfort**
- **coolness (or thermal insulation)**
- **sound insulation**
- **flexibility (especially in earthquake areas)**

- **LOCAL BYLAWS** demand a certain capability of carrying load according to its destination; e.g.:

- a **domestic floor** may be required to carry only **14,6 MN/m² (146 kg/m²)**
- an **industrial floor** may be required to carry **48,8 MN/m² (488 kg/m²)**

7.2 SOLID GROUND FLOORS

- **Concrete Ground Floors** are most widely used today and are usually solid.
- On poor, or uneven ground, or where heavy loads are to be carried, they may be **REINFORCED**.
- The floor should be laid on **HARDCORE** of broken stones, concrete, rock, laterite, lumps or burned bricks - if obtainable.
- Where these items are in short supply, **25 cm of compact FOUNDATION SOIL** will serve.

Not TOP SOIL, because:

- 1. to prevent plants, shrubs and trees from attempting to grow under the concrete.**
- 2. it readily contains moisture and would cause the concrete over it to be damp.**

7.2.1 SITE CONCRETE

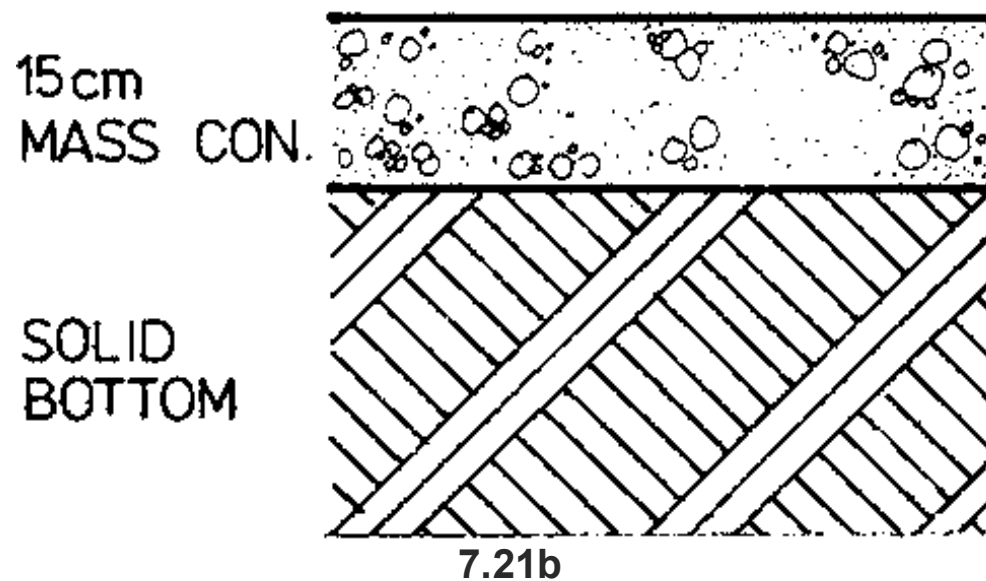
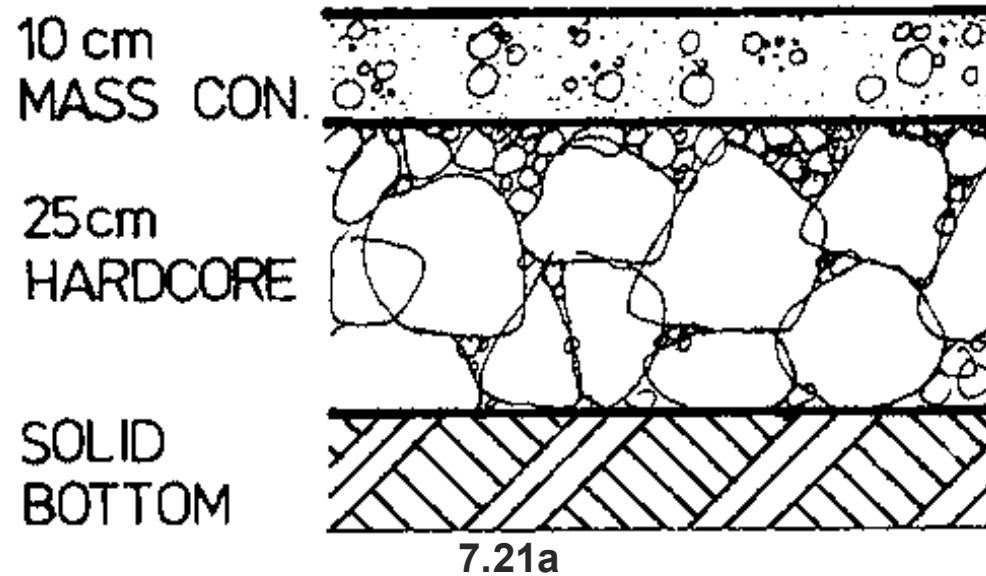

- A continuous layer of CONCRETE at least 10cm thick to be spread over the site of all buildings within the external walls on a bed of HARDCORE at least 15cm thick,

OR

- A continuous layer of CONCRETE at least 15 cm thick can be used without HARD-CORE underneath.
- The MIXTURE of concrete generally used is 1 (cement) : 3(sand) : 6(aggregate)
- The building regulations do not allow this site concrete to be laid directly on the turf or to soil of the site. All vegetable and top soil has to be removed first for reasons, which are already mentioned above.

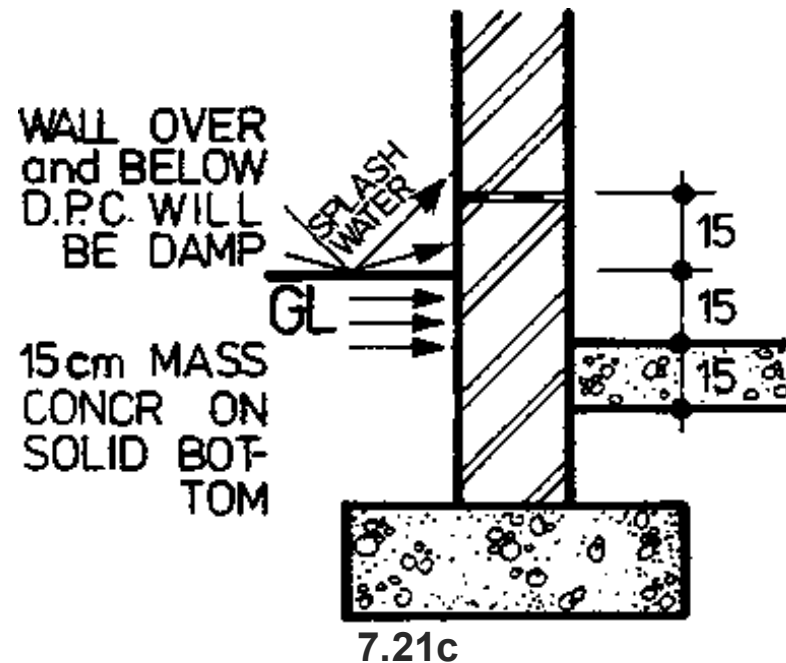

- The depth of vegetable or top soil varies and on some sites it may be necessary to remove 30 cm or more.

If the 15 cm site concrete were then laid, the top surface of the concrete would be 15 cm below the site outside GROUND LEVEL. It will be remembered that DPC in all walls should be 30 cm above the ground, so that there would be 45 cm of the external walls below the DPC and 30 cm above the floor, making the building very liable to damp. One possibility would be to make the site concrete 45 cm thick to bring its

top surface up to the correct level, but this would be an unnecessarily expensive method.

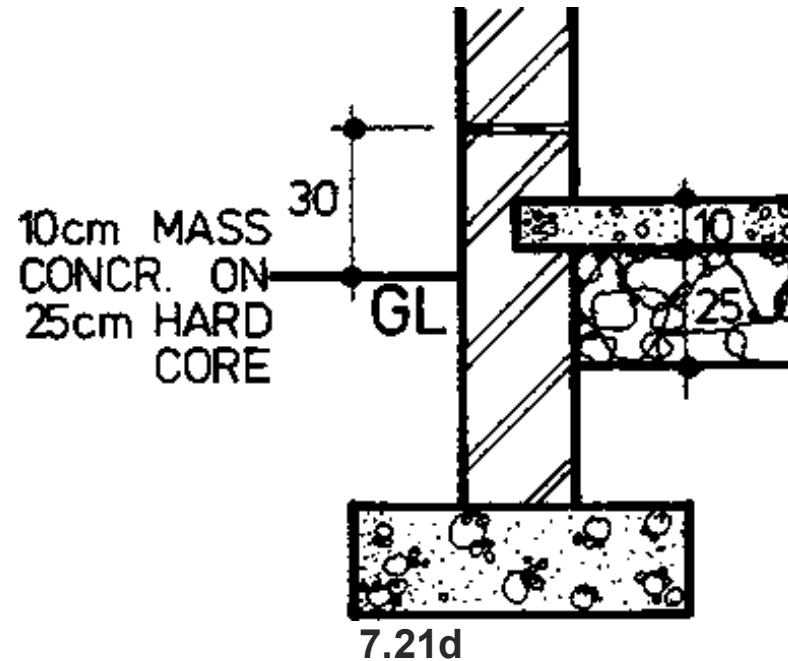

Instead - **HARDCORE** is spread to raise the level of the concrete. (The soil excavated from foundation trenches should not be taken for backfilling or raising the level of the concrete. The excavated soil will have been broken up in digging and would need quite thorough ramming to make certain it did not sink. Further, this soil would tend to retain moisture and make the site concrete damp.

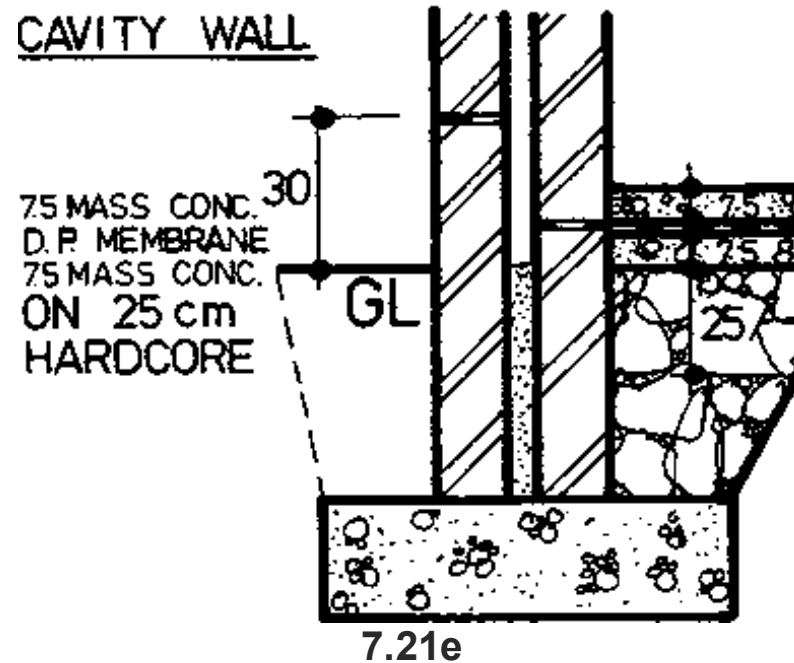

7.2.2 HARDCORE

- consists of irregular shaped lumps of

- broken bricks
- stone or concrete
- laterite lumps e.t.c.

which are hard and do not readily absorb water.

- HARDCORE is spread over the site within the external walls of buildings to such thickness as required to raise the finished surface of the site concrete.

- **HARDCORE** should be spread until it is roughly level and rammed until it forms a compact bed for the over- site concrete.
- The **HARDCORE-BED** is usually between 15 cm and 30 cm thick.
- The material used has to be reasonable clean to make it difficult for water to rise by capillary action.
- Before the concrete is laid one has to **BLIND** the top surface of the concrete - to prevent the wet concrete running down between the hardcore.

For **BLINDING** (or sealing) the hardcore a thin layer of very dry coarse concrete can be spread over, or a thin layer of

coarse clinker or ash
or aggregate

can be used.

The **BLINDING LATER** (or coat) will be about 5 cm thick.

On it the site concrete is spread and finished with a true level top surface.

7.2.3 WATERPROOF MEMBRANE

- The waterproof membrane, sandwiched in the concrete prevents damp rising to the floor surface. Fig. 7.21e shows the arrangement.
- The membrane is formed by laying

1. a 7,5 cm thickness of site concrete and allowing it to thoroughly dry out.

2. a thin coat of tar or bitumen is poured and spread on the concrete.

3. a second layer of concrete on to of the hardened tar or bitumen.

7.3 SUSPENDED TIMBER GROUND FLOOR

- Consists of:

TIMBER BOARDS (or other suitable sheet material) fixed to JOISTS spanning over SLEEPER WALLS.

- A timber floor is used occasionally only because it has properties which a solid groundfloor lacks: Some flexibility and it will easily accept nail fixings.

- It is a more expensive form of construction than a solid ground floor and can only be justified on sloping sites which would need a great deal of filling to make up the ground to the required floor level.

- Suspended timber floors are susceptible to DRY ROT and DRAUGHTS the problem of DRY ROT, which is a fungus that attacks damp timber, can be overcome by adequate ventilation under the floor and the correct positioning of D.P.C. to keep the underfloor area and the timber dry.

THROUGH VENTILATION is essential to keep the moisture content below 20 % of its oven-dry-weight (which would allow fungal growth to take place.

• The usual method is to allow a free flow of air under the floor covering by providing in the external walls, AIR-BRICKS, sited near the corners and at approximately 2 m centres around the perimeter of the building.

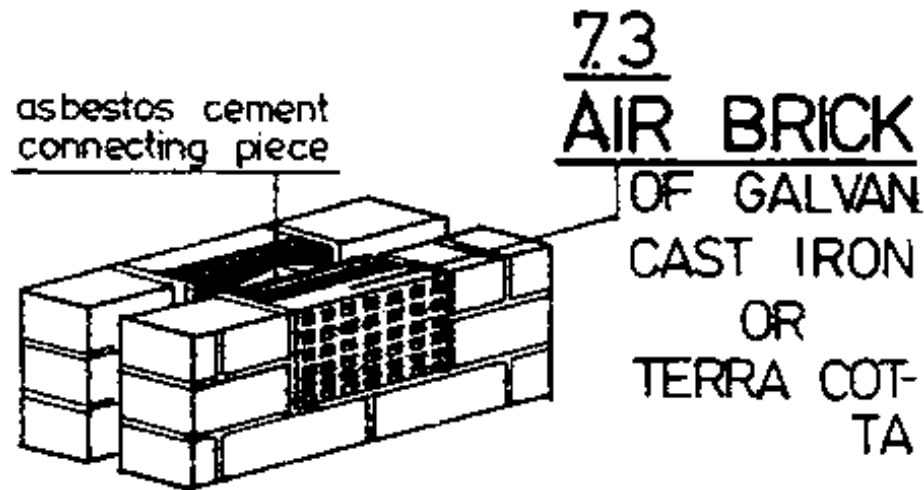

- If a suspended timber floor is used in conjunction with a solid ground floor in an adjoining room, PIPES are used under the solid floor to convey air to and from the external walls.

7.3.1 BUILDING REGULATIONS

- Fig. 7.31 shows the minimum dimensions required under B.R.C 4 but in practice a greater space between the timber is usual.
- HONEYCOMB sleeper walls are usually built two or three courses high to allow good through ventilation.
- SLEEPER WALLS spaced a 2 m centres will give an economic joist size.
- The width of joists is usually taken as 50 mm (This will give sufficient width for the nails securing the covering).
- The depth can be obtained by reference to Table 1, Schedule 6, B.R. or by design calculations.

The usual joist depth for domestic work is 125 mm.

TABLE 1, SCHEDULE 6, B.R.

SEE PAGE CET 2031/1 - 74 13

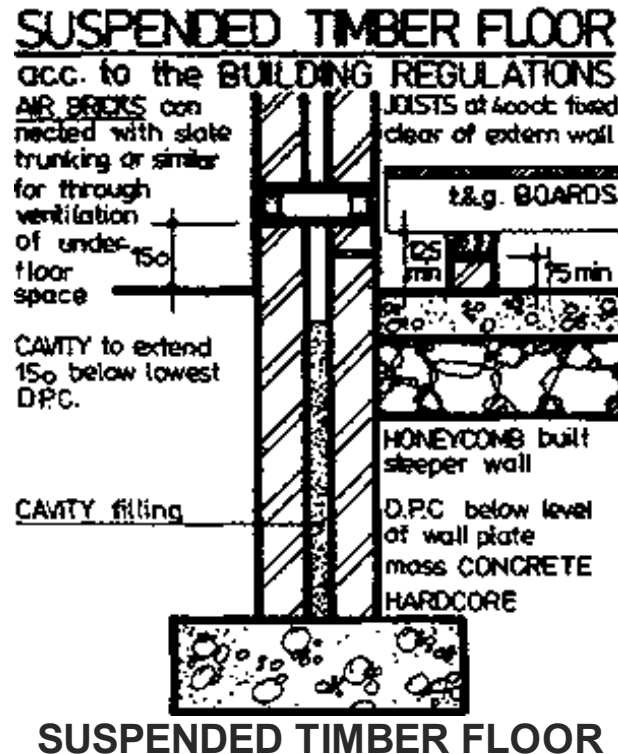

7.3.2 LAY OUT

The most economic lay-out is to span the joists across the shortest distance of the room.

- This means the joists could be either parallel or at right - angles to a FIRE - PLACE.

The fireplace must be constructed of **NON-COMBUSTIBLE** materials and comply with B.R. L3 and L4.

- The figures 7.32 a + b show typical examples.

- Constructing ground floors and upper floors, problems of another kind have to be considered. The main differences are:

1 Ground floor

- The floor rests directly on the ground
- Good insulation against moisture is required.

2 Upper floor

- The floor is supported only at its edges
- Good insulation against noise is required.

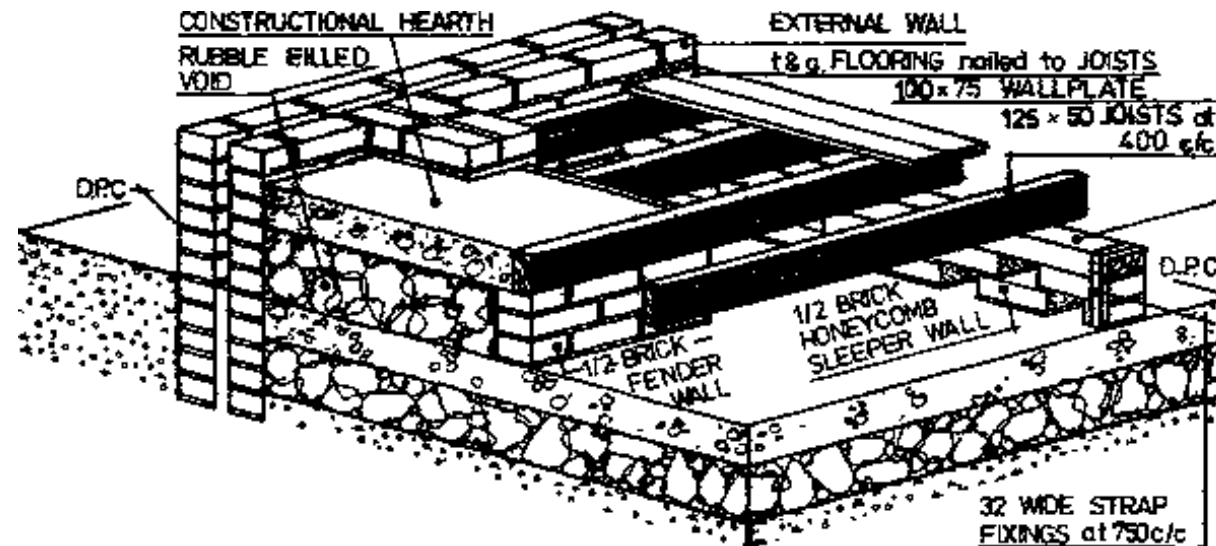

732a JOISTS PARALLEL TO FIREPLACE

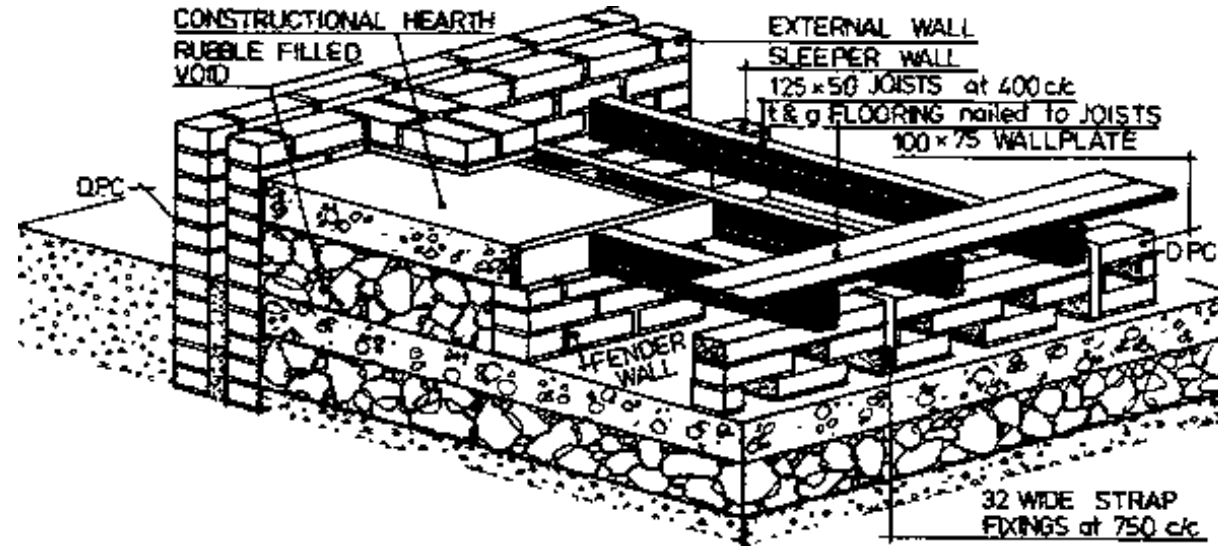

732b JOISTS AT RIGHT ANGLES TO FIREPLACE

7.4 UPPER FLOORS

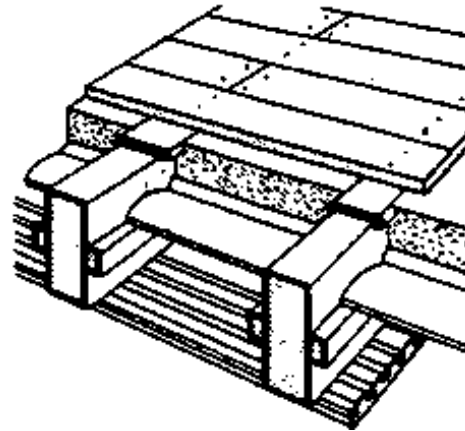

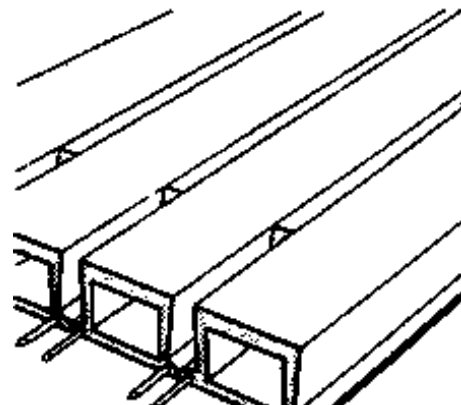
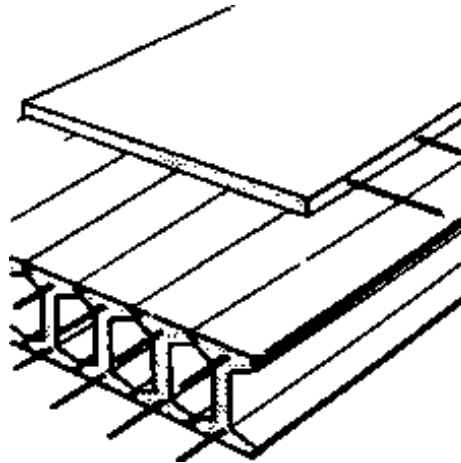
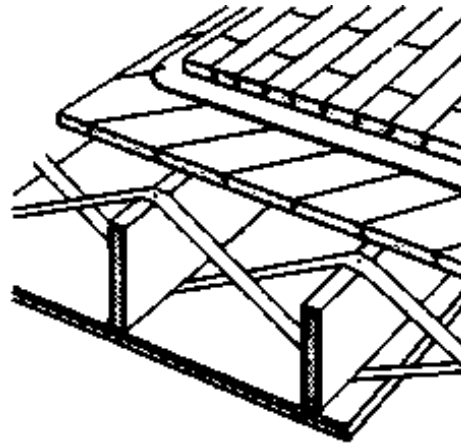

7.4.1 TYPES OF UPPER FLOORS

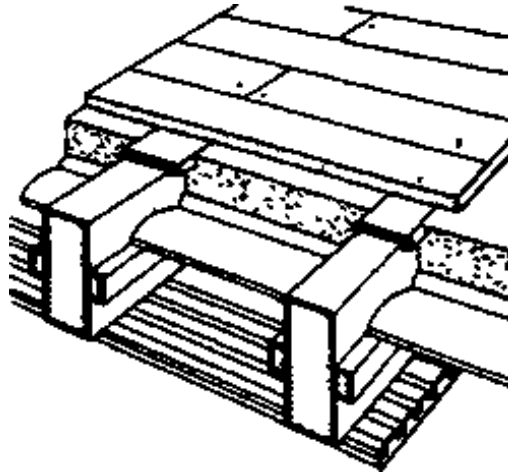

Timber joist floor with tree segments and infill ~200-250 kg/m²

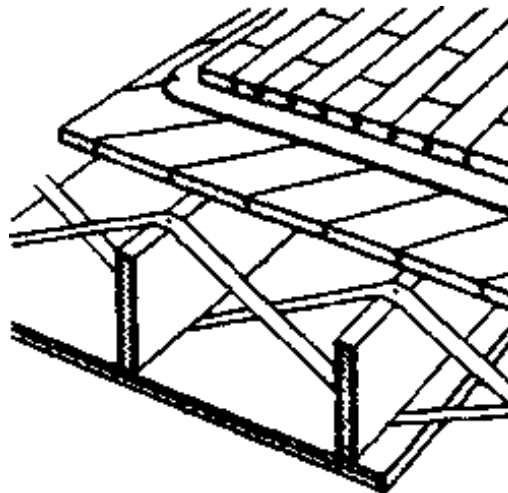

USA plank floor with hoop iron bracing, weight without infill 65-90 kg/m²

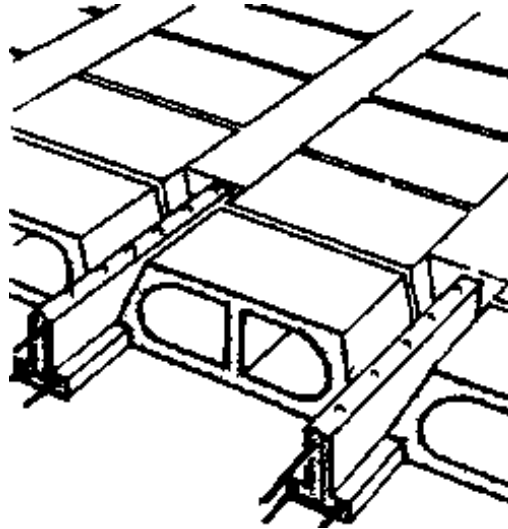

r.c. beam floor with non-structural infilling blocks

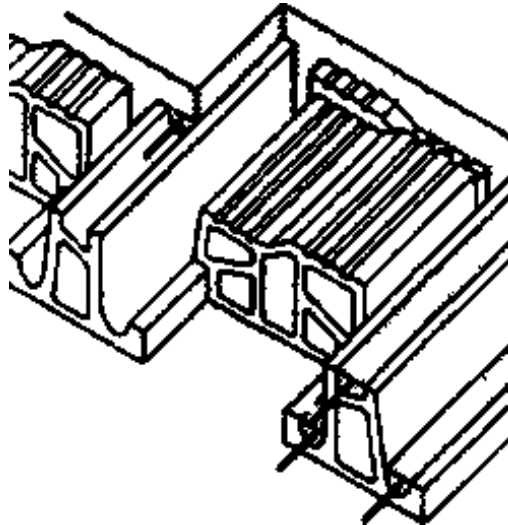

Part assembly floor with hollow beams and reinforced cover slabs

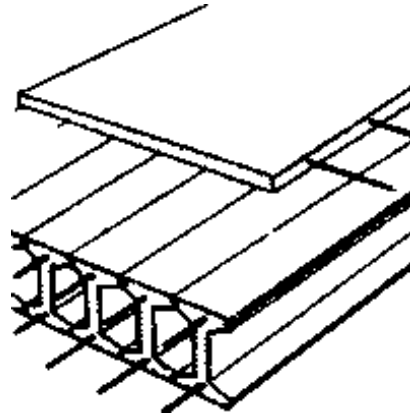

Complete assembly r.c. I-beam floor, precast.

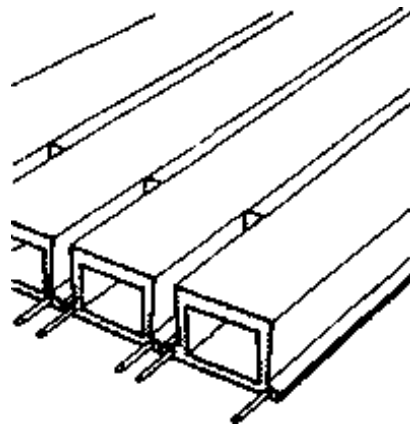

Complete assembly r.c. hollow beam floor, precast

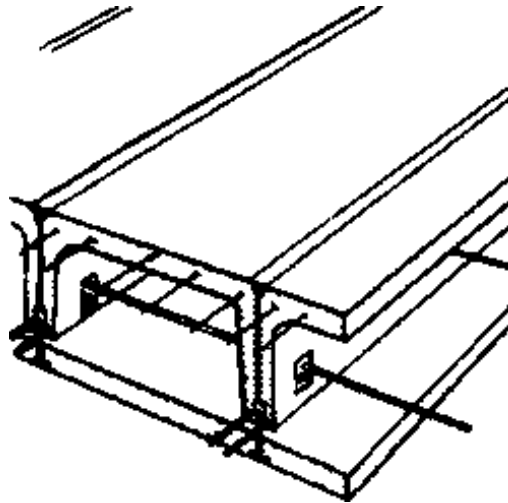

U-shaped r.c. beams close butting and bolted give lateral bracing

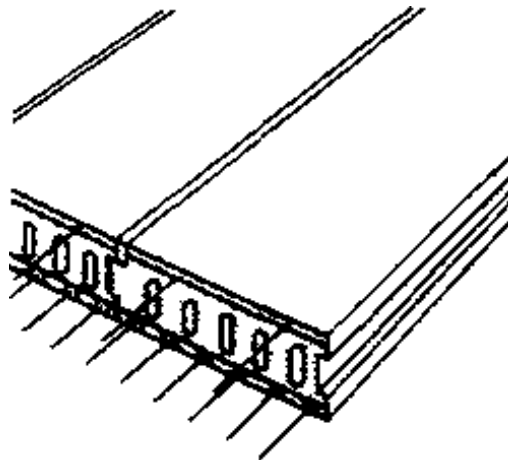

Pre-stressed hollow concrete plank floor: 20-30 mm concrete bottom layer with pre-stressed twist steel reinforcement, light weight concrete core and 10 mm concrete cover

- One can divide types of upper floors into different categories

- **according to the statical system;**

- beam floors
- slab- beam floors
- slab - floors

- according to the kind of construction:

- constructed on site
- partly prefabricated
- prefabricated.

- according to the material used for construction

- timber floors
- concrete or reinforced concrete floors
- floors made out of masonry or brickwork (arches/domes)
- floors made out of steel

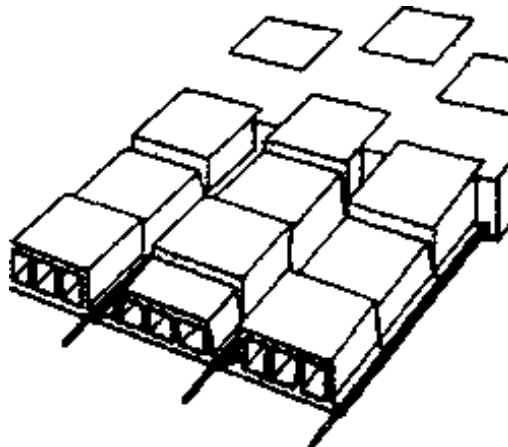

Steel end hollow blocks with extended bottom flange. Ribs and cross jointing of in situ concrete

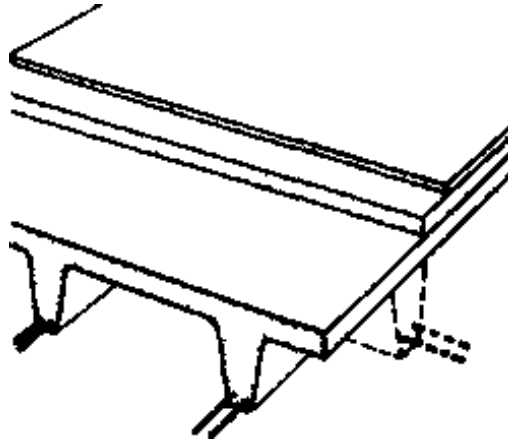

r.c ribbed floor, cast in situ. Ribs c/c ≤ 700 mm, rib width ≥ 50 mm, thickness of slab =1/10 beam spacing, bearing of beams ≥ 150 mm.

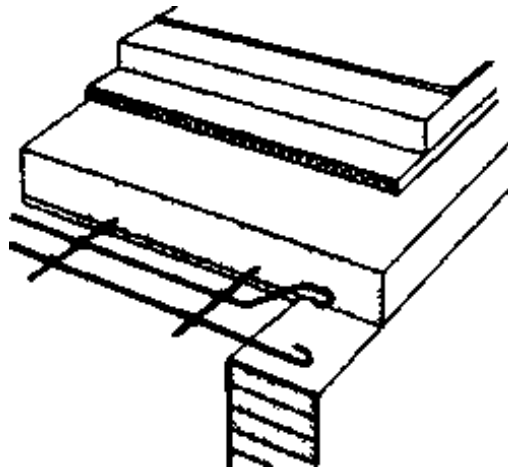

r.c. slab cast in situ, 1 or 2-way reinforcement. ≥ 70 mm thick, economical ≤ 150 mm. With 2-way reinforcement proportion of width to length $\leq 1:1.5$

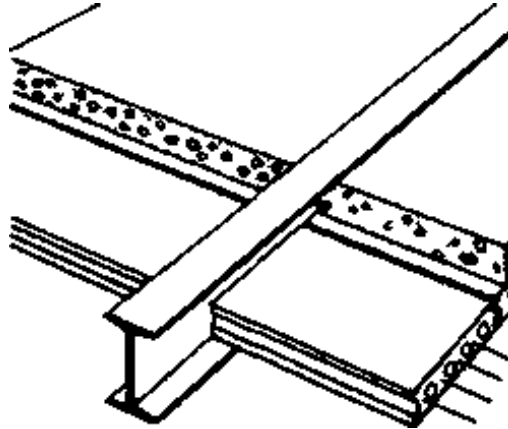

R.S.J. floors with infilling; lightweight or breeze concrete slabs reinforced (900-1 300 mm l, 350 mm w, 85 mm thick), topped with light-weight concrete

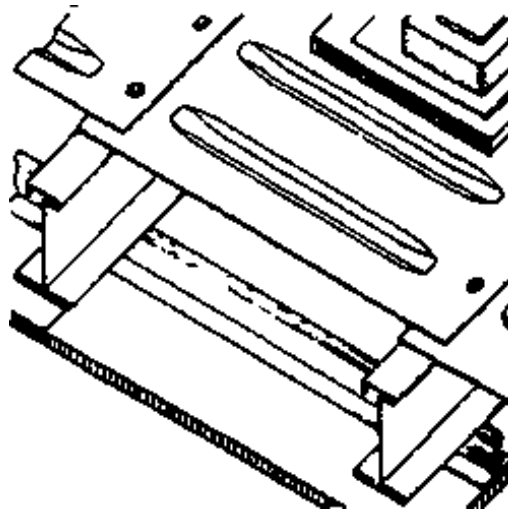

Sheet metal floor for office and industrial buildings. Poor impact noise insulation

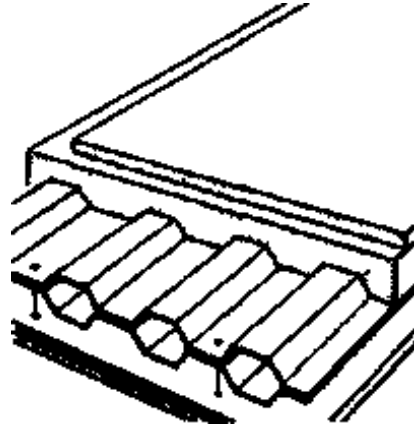

Sheet metal floor in office buildings; good ducting for services; ceiling suspended on hangers and concrete topping give good sound insulation

7.4.2 STRUCTURE OF UPPER FLOORS

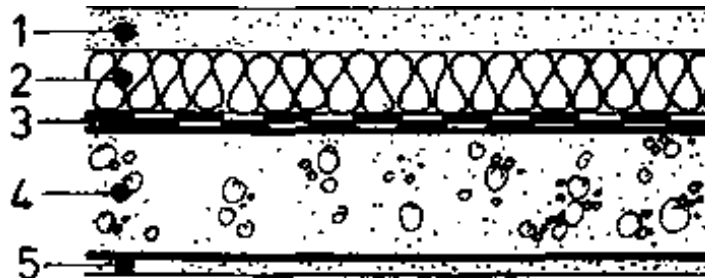

- 1 FLOOR FINISH
 - 2 INSULATION : thermal or sound
 - 3 BARRIERE LAYER
 - 4 LOAD BEARING MEMBER
 - 5 CEILING
- structure of an UPPER - FLOOR

7.4.3 SUSPENDED TIMBER UPPER FLOORS

- Timber, being a combustible material, is restricted by Part E of the Building Regulations to **SMALL DOMESTIC BUILDINGS** as a structural flooring material.
- The construction of suspended timber upper floors is cheap in relation to other structural flooring methods and materials and does not involve **WATER** for construction.
- Structural soft wood is readily available, easily worked, has a good strength to weight ratio and is therefore suitable for domestic buildings.

7.4.3.1 Floor Joists

- The load bearing members of a timber floor are the FLOOR JOISTS.
- Terminology
 - **Common Joist:** a Joist spanning from support to support.
 - **Trimming Joist:** span as far as common joist, but it is usually 25 mm thicker and supports at **TRIMMER JOIST**.
 - **Trimmer Joist:** a joist at right-angles to the main span supporting the **TRIMMED JOISTS** and is usually 25 mm thicker than a common joist.
 - **Trimmed Joist:** a joist cut short to form an opening and is supported by a trimmer joist, it spans in the same direction as common joists and is of the same section size.

- Spacing of the Joists

Spacing of the Joists

- The spacing of the joists is usually from 37,5 cm to 450 cm, measured from the centre of one joist to the next.
 - To economise in the use of timber the floor joist of upper floors usually span (are laid across) the least width of rooms from external wall to internal partitions.
 - The maximum economical span for timber joists is between 3.60m and 4 m. For greater spans (than about 4,5 m) it is usually economic to reduce the span of the joist by the use of steel beam or timber binders, which is known as DOUBLE FLOOR CONSTRUCTION
- Strutting between joists: Timber shrinks when it is seasoned and timber - such as floor joists - which is not cut on the radius of the circle of log does not shrink uniformly. The shrinkage will tend to make the floor joists twist, or wind, and to prevent cracking of a plaster ceiling which this twisting would cause, timber strutting is used.

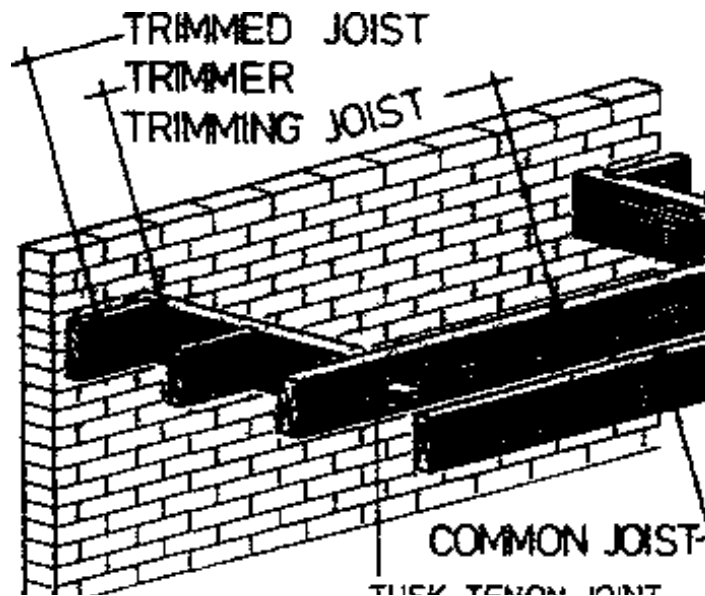

7.431 SPACING OF JOISTS

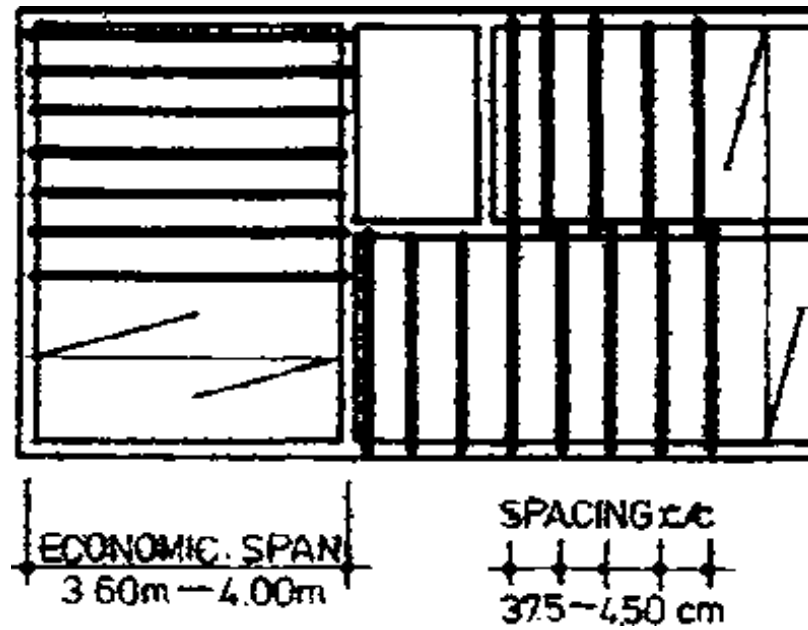

7.431a DOUBLE FLOOR DETAILS

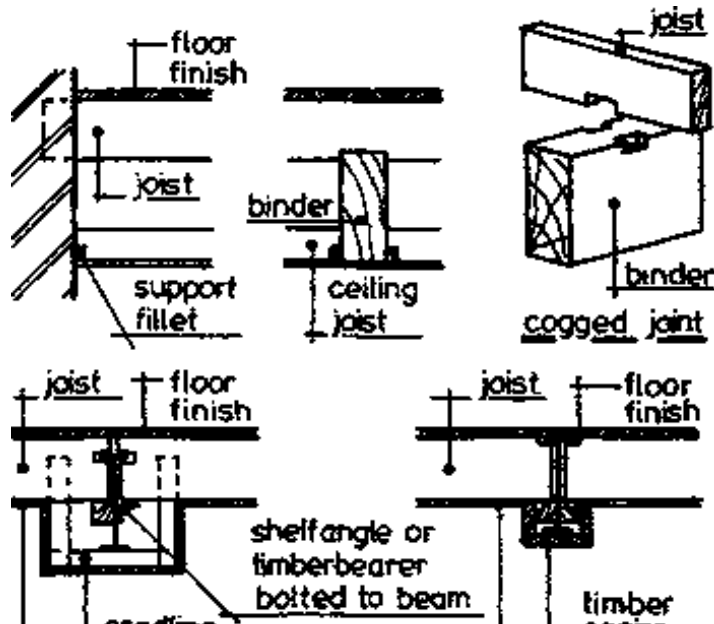
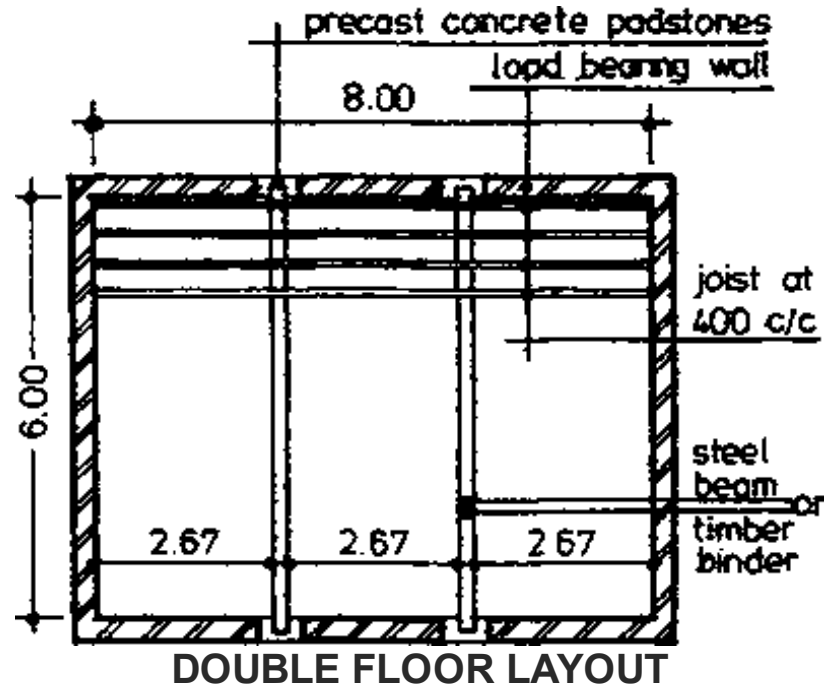



DETAILS USING TIMBER BINDER OR STEEL BEAM

The commonly used type is

- **HERRINGBONE STRUTTING**

This consists of short lengths of 4 x 4 cm soft-wood timber nailed between the joists.

- **Alternatively a system of solid strutting is sometimes used. This consists of short lengths of timber of the same sections as the joists which are nailed between the joists - either in line or staggered**

It is not as effective as the herringbone system, because the solid lengths have to be cut, very accurately to fit to the sides of the joists; they do not firmly strut between the joists.

- **As with herringbone strutting the end joists are blocked and wedged up to the surrounding walls.**

- **Usually:**

one set of struts is used for joists spanning up to 3,60m and

two sets of struts are used for joists spanning more than 3.60 m.

A single set of struts is fixed across the floor at mid span.

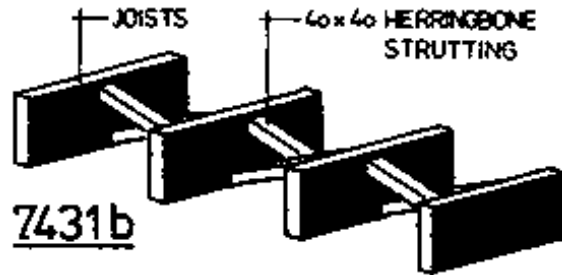

7431b

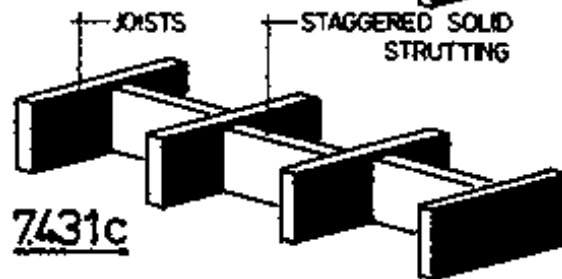

7431c

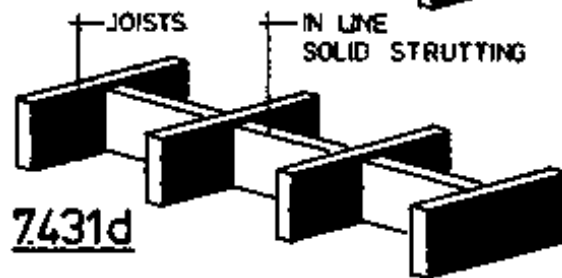

7431d

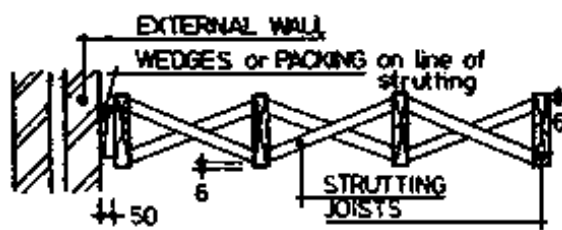

7431e

STRUTTING ARRANGEM.'S

- Joist Sizing

There are three ways of selecting suitable joists for supporting a domestic type floor:

There are three ways of selecting suitable joists for supporting a domestic type floor.

1. Rule of Thumb:

$$\frac{\text{span in mm}}{24} + 50 \text{ mm} = \text{depth in mm}$$

2. Calculation:

$$\text{BM} = \frac{fbd^2}{6}$$

where:

BM = bending moment

f = max fibre stress

b = breadth (assumed to be 50 mm)

d = depth in mm

3. Building Regulations, Table 1, Schedule 6.

**TABLE 1
FLOOR JOISTS
GS, MGS, M50, M75 or No. 2 Grade Timber**

Size of joist (in mm)	Dead load (in kg/m ²) supported by joist, excluding the mass of the joist		
	Not more than 25	More than 25 but not more than 50	More than 50 but not more than 125

Spacing of joists (in mm)									
	400	450	600	400	450	600	400	450	600
Maximum span of joist (in m)									
38 × 75	1.05	0.95	0.72	0.99	0.90	0.69	0.87	0.79	0.62
38 × 100	1.77	1.60	1.23	1.63	1.48	1.16	1.36	1.24	1.00
38 × 125	2.53	2.35	1.84	2.33	2.12	1.69	1.88	1.73	1.40
38 × 150	3.02	2.85	2.48	2.83	2.67	2.26	2.41	2.23	1.83
38 × 175	3.51	3.32	2.89	3.29	3.11	2.71	2.82	2.66	2.27
38 × 200	4.00	3.78	3.30	3.75	3.55	3.09	3.21	3.03	2.64
38 × 225	4.49	4.24	3.70	4.21	3.98	3.47	3.61	3.41	2.96
44 × 75	1.20	1.08	0.83	1.13	1.02	0.79	0.98	0.89	0.70
44 × 100	2.01	1.82	1.41	1.83	1.67	1.31	1.51	1.39	1.12
44 × 125	2.71	2.56	2.09	2.54	2.38	1.90	2.08	1.92	1.56
44 × 150	3.24	3.06	2.67	3.04	2.87	2.50	2.60	2.45	2.03
44 × 175	3.77	3.56	3.10	3.53	3.34	2.91	3.02	2.86	2.48
44 × 200	4.29	4.06	3.54	4.02	3.80	3.31	3.45	3.26	2.83
44 × 225	4.81	4.55	3.97	4.51	4.27	3.72	3.87	3.66	3.18
50 × 75	1.35	1.22	0.93	1.26	1.14	0.89	1.08	0.99	0.78

50 × 100	2.22	2.03	1.58	203	1.85	1.46	1.66	1 53	1.23
50 × 125	2.84	2.72	2.33	2.70	2.55	2.10	2.27	209	1.71
50 × 150	3.40	3.26	2.84	323	3.05	2.66	2.76	261	2.21
50 × 175	3 95	3.78	3.30	3.75	3.55	309	3.22	304	2.64
50 × 200	4.51	431	3.76	4.27	4. 04	3.52	3.67	3.46	3 01
50 × 225	506	4.83	4.22	4.79	4.53	3.95	4.11	3.89	339
63 × 150	3.66	3.52	3.17	3.50	3 38	2.97	3 09	2.92	2.54
63 × 175	4.25	4.10	3.68	407	3 93	3.45	3.59	3.40	2.96
63 × 200	4.84	4.67	4.20	4.64	448	3.93	409	3.87	3.37
63 × 225	5.43	5.24	4.70	5.21	502	4.41	4.59	4.34	3.78
75 × 200	5.10	4.93	4 51	490	4.72	4.27	4.43	4.20	3.67
75 × 225	5.72	5.52	5.06	5.49	5 30	4.79	4.97	4.71	4.11

7.4.3.2 End Support of Floor Joists

The end of timber floor joists must in some way either be built

- into or
- supported against load bearing partitions and external walls.

- The most commonly used method of giving support to the ends of timber floor joists is to build them into walls and partitions.

- There was a common practice to build the joist ends some 10 cm into walls and partitions and to pack up under each joist with small peaces of slate or tile so that the top of the joists are level, if the underside of the joist does not comply with a brick course.

- Disadvantage: displacing of tiles - out of level.

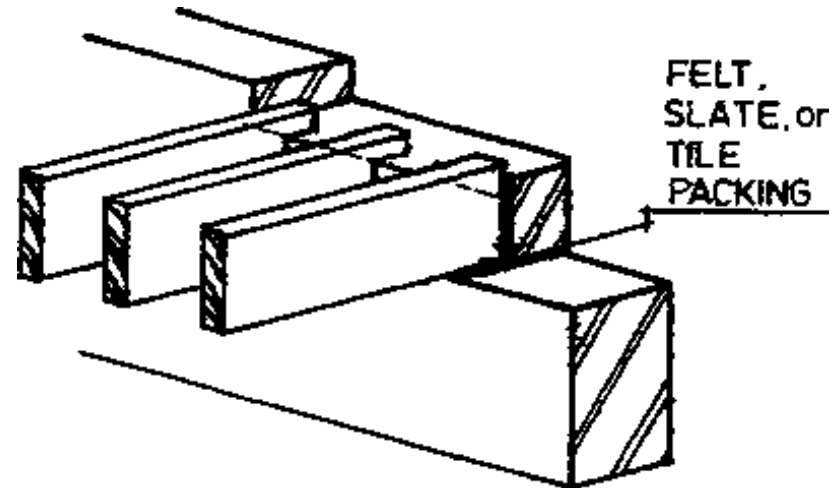

7.432 a BUILT INTO

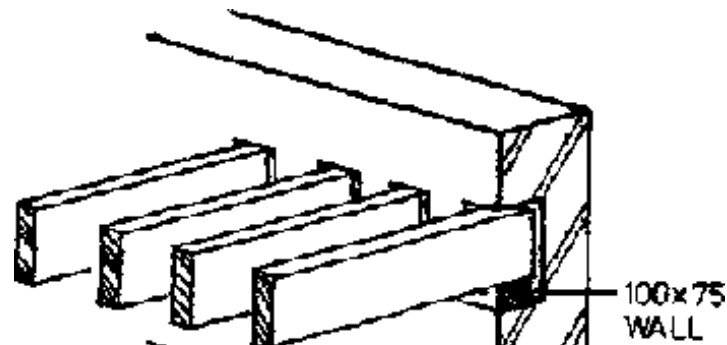



7.432 b BUILT INTO

BUILT INTO

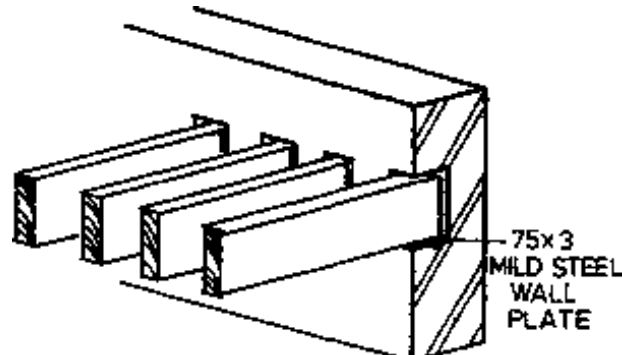

7.432 c BUILT INTO

- A better solution is to build a wallplate (100 × 75 mm) into the wall as shown in Fig. 7.432 B
- Another possibility is the use of a mild steel wall-plate(75 × 3 mm) as demonstrated in fig. 7.432 C.

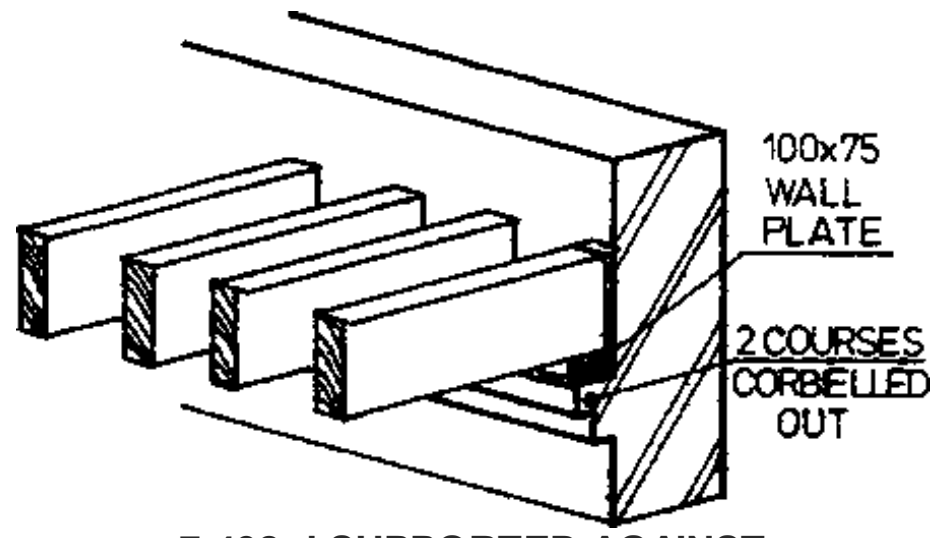

SUPPORTED AGAINST

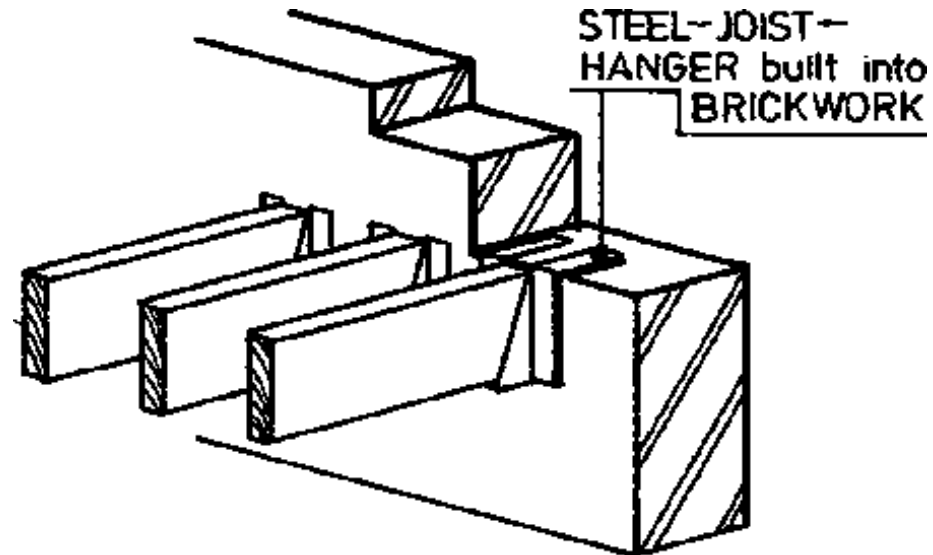

7.432 e SUPPORTED AGAINST

- If the ends of timber floor joists are built into a solid external wall, 1 brick thick, there is only 1/2 brick between the ends and the rain falling on the outside of the wall.

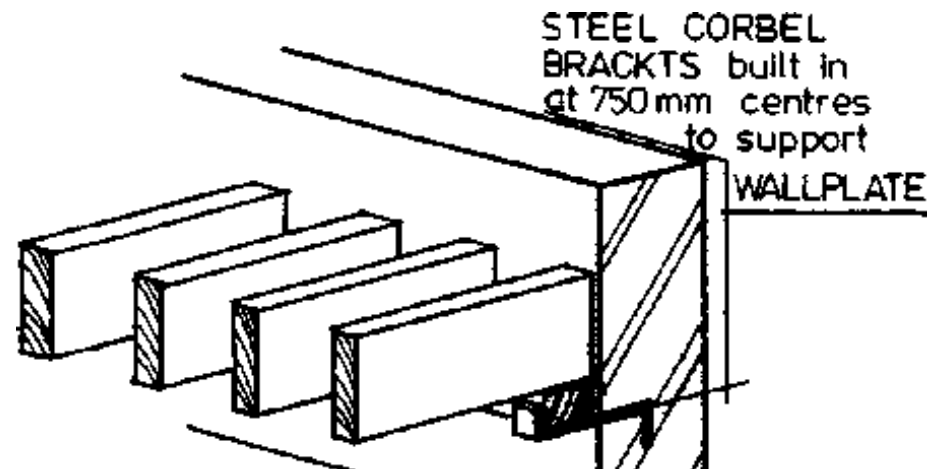



7.432 f SUPPORTED AGAINST

Therefore: Joists will at time become saturated and then: the dry rot fungus may attac.

This danger can be reduced by painting the ends of the joists with oily preservative.

If the external wall is of cavaty construction, the joist-ends must not run into or across the cavaty (moisture!!).

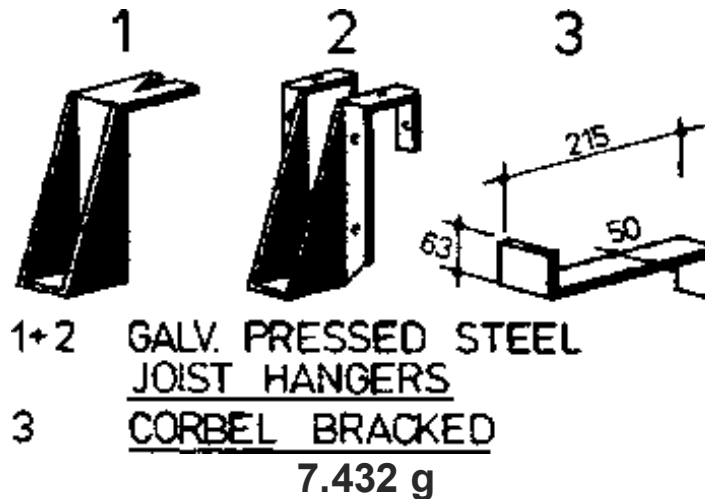

7.4.3.3 Trimming

- This is a term used to describe the framing of joists around an opening or projection. Various joints can be used to connect the members together, all of which can be substituted by JOIST HANGERS.

- Typical trimming joints and arrangements are shown in Fig. 7.433

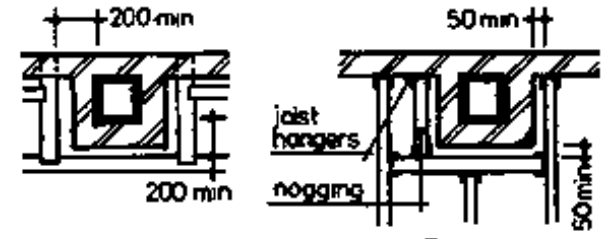
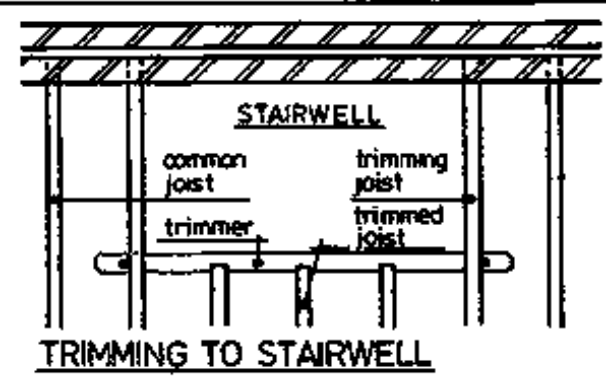
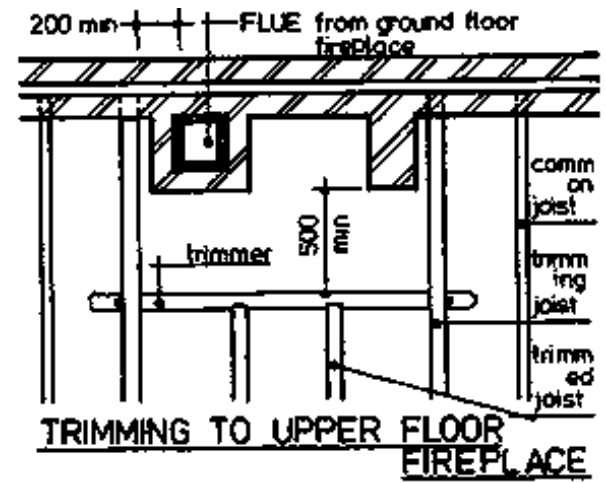

7.433 TRIMMING ARRANGE-M

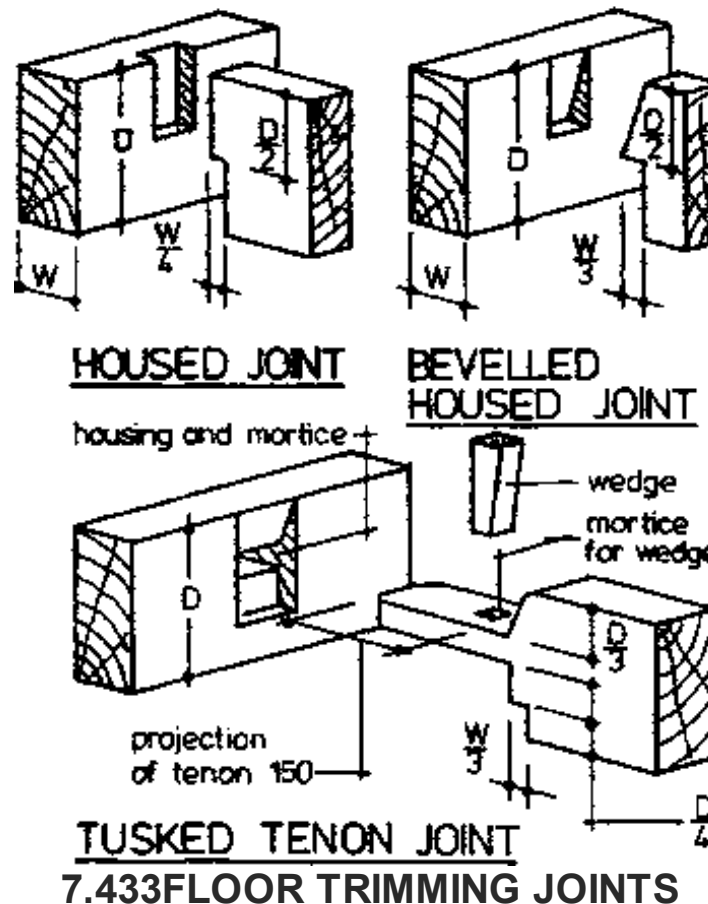

7.4.4 REINFORCED CONCRETE UPPER FLOORS

- Reinforced concrete floors have a better resistance to damage by fire and can safely support greater superimposed loads than timber floors.

Therefore they are used for most offices, larger blocks of flats, factories and public buildings.

- There are many different types of reinforced concrete floors. Some of the most common r.c. upper floors are demonstrated in the following

7.4.4.1 Monolithic Reinforced Concrete Upper Floors

A monolithic r.c. floor is poured 'in situ' on formwork, consisting of concrete and reinforcement steel bars. After drying out it becomes a new "monolithic" building material: REINFORCED CONCRETE which is capable to resist both compression and tension forces.

- R.C. upper floors are in most cases between 10 cm und 30 cm thick

- Usually mild steel is used for reinforcement (either bars or mats) Reinforcement and concrete mix have to be in accordance with the statical calculations.

- Disadvantages of Monolithic R.C. Upper Floors:

- Need Forwork
- Time taken for the concrete to cure before formwork can be released
- very little is contributed by a large portion of concrete to the strength of the floor.

- Fig. 7.441 shows an typical example of a monolithic r.c. upper floor.

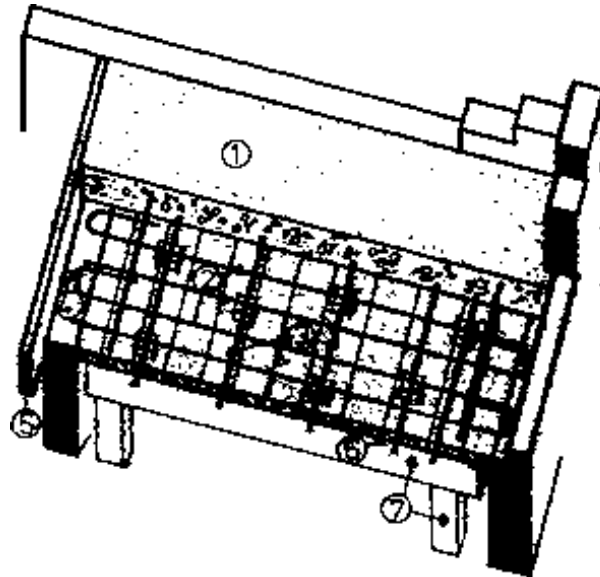

- 1 CONCRETE CAST IN SITU
- 2 MAIN REINFORCEMENT BARS (150 c/c)
- 3 DISTRIBUTION BARS (450 c/c)
- 4 ENDS OF BARS BENT UP
- 5 TIMBER FORMWORK
- 6 TIMBER CENTERING
- 7 TIMBER SUPPORT FOR CENTERING

MONOLITHIC R.C. UPPER FLOOR

7.4.4.2 Precast Concrete Upper Floors

- Floors composed of reinforced precast concrete units have been developed over the years to overcome some (or all) the disadvantages of monolithic reinforced concrete slab.

To realise the full economy of any one particular precast flooring system the design of the floors should be within the **SPAN, WIDTH, LOADING** and **LAYOUT LIMITATIONS** of the units under consideration.

The system available now is called **PRECAST HOLLOW FLOORS - COMPOSITE FLOORS**

- The systems available can be considered either PRECAST HOLLOW FLOORS or COMPOSITE FLOORS.

• Precast hollow floors

Units are available in a variety of sections such as boxplanks or beams, tee sections, I-beam sections and channel sections.

- The economies which can be reasonable expected over the 'in situ' floor are:

1.50 % reduction in the volume of concrete

2.25 % reduction in the weight of reinforcement

3.10 % reduction in the size of foundations.

- The units are cast in precision moulds, around inflatable formers or framed plastic cores.

- The units are laid side by side with the edge joints being grouted together.

- No structural topping is required, but the upper surface of the units are usually screeded to provide the correct surface for the applied finishes.

- Means of mechanical lifting is required to offload and position the units.

Hollow units are normally the cheapest form of precast concrete suspended floors for simple straight spans with beam or wall supports to maximum a span of 20 m.

- They are not suitable for heavy point loads.

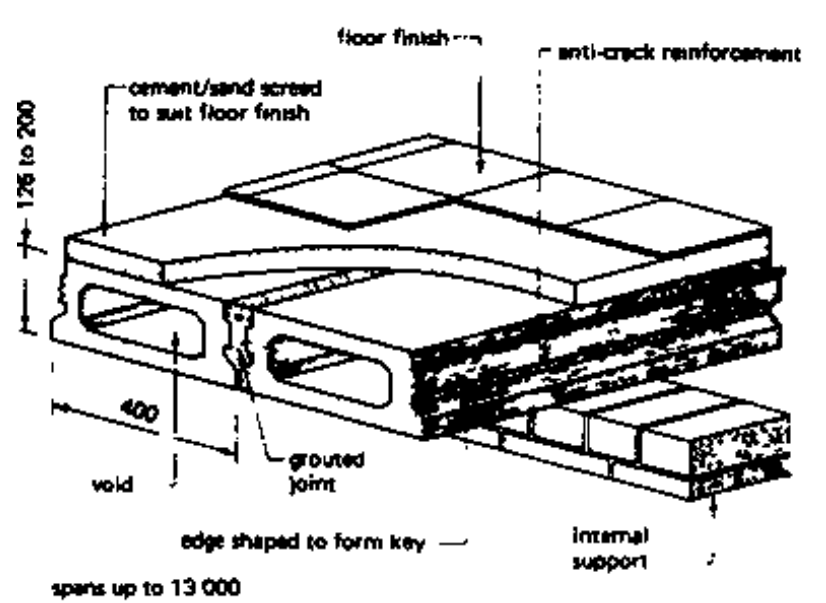

Typical hollow floor unit details

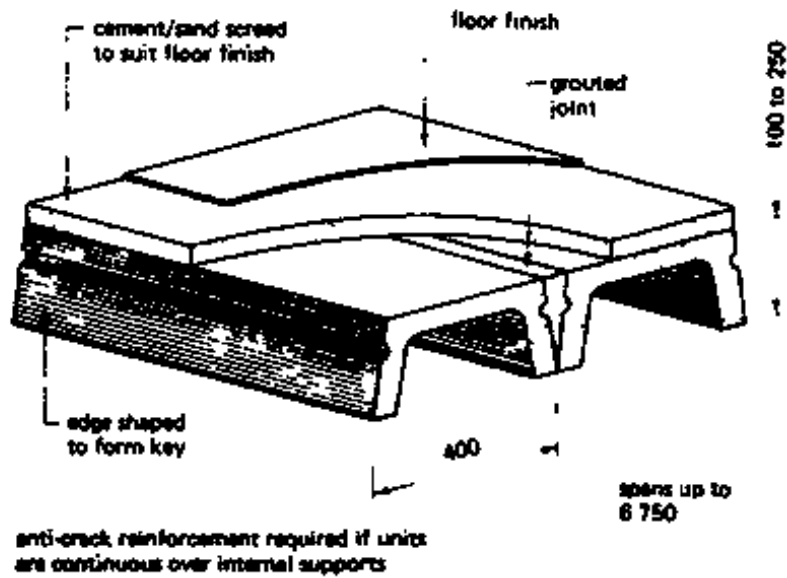

Typical channel section floor unit details
Precast concrete hollow floors

- Composite floors.

Are a combination of PRECAST UNITS and IN SITU CONCRETE.

- The precast units (usually prestressed or reinforced with high yield steel bars) are used to provide the strength of the floor and at the same time act as a permanent formwork to the in situ topping which provides the compressive strength required.

It is essential that an adequate bond is achieved between the two components (in most cases this is provided by the upper surface texture of the precast units).

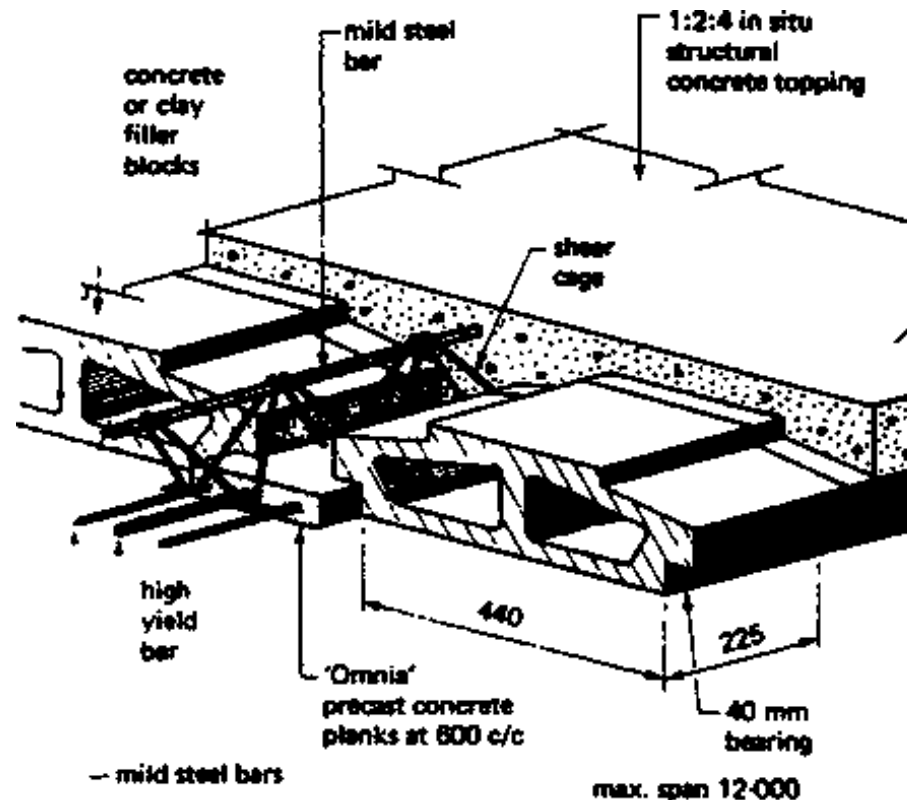

Typical composite floor using P.C.C. planks

- Generally there are two forms of composite floors:

1. Thin pressed planks with a side key and covered with an in situ topping
2. Reinforced or prestressed narrow beams which are placed at 600 mm centres and are bridged by concrete filler blocks.

The whole combination being covered with in situ topping. Most of the beams used in this method have shear reinforcing cage projecting from the precast beam section.

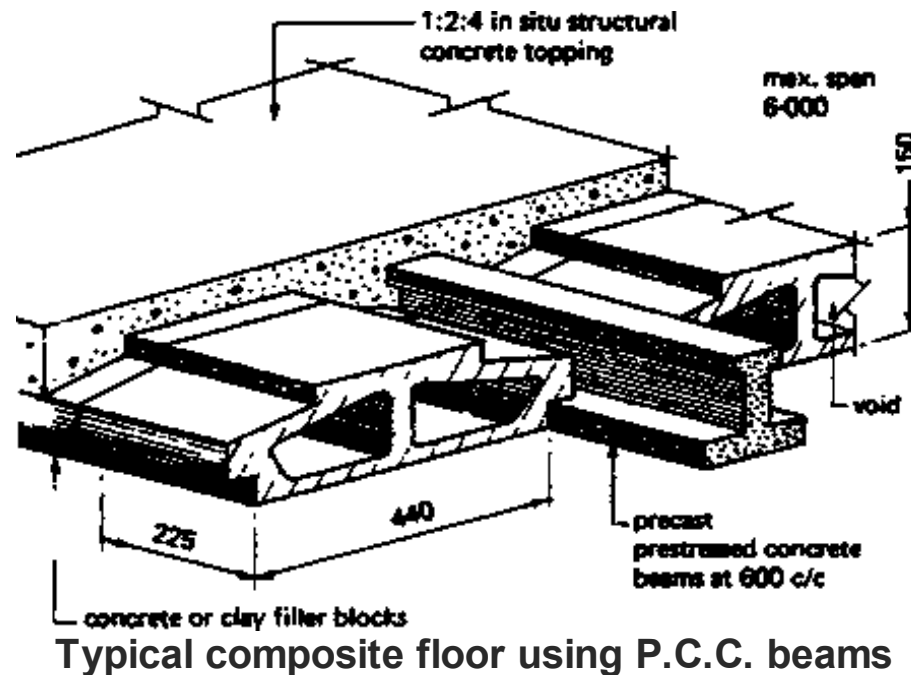

- In both forms temporary support should be given to the precast units by props at 1,80 m to 2,40 m centre until the in situ topping has cured.

Composite floors

7.4.4.3 Hollow Block and Waffle Floors

- Precast concrete suspended floors are generally considered to be for light to medium loadings spanning in one direction.

HOLLOW BLOCK (or hollow pot) and WAFFLE (or honeycomb) FLOORS can be used as an alternative to the single spanning precast floor since they can be designed to carry heavier loadings.

They are in fact **RIBBED FLOORS** consisting of closely spaced narrow and shallow beams giving an overall reduction in depth of the conventional reinforced concrete monolithic beam and slab floor.

• HOLLOW BLOCK FLOORS

- These are formed by laying over conventional floor soffit formwork a series of hollow light weight clay blocks (or pots) in parallel rows with a space between these rows to form the ribs.
- The blocks act as permanent formwork giving a flat soffit suitable for plaster application and impact to the floor good thermal insulation and fire resistance.
- The ribs formed between the blocks can be reinforced to suit the loading conditions of the floor.
- The main advantages are: its light weight its relatively low cost.

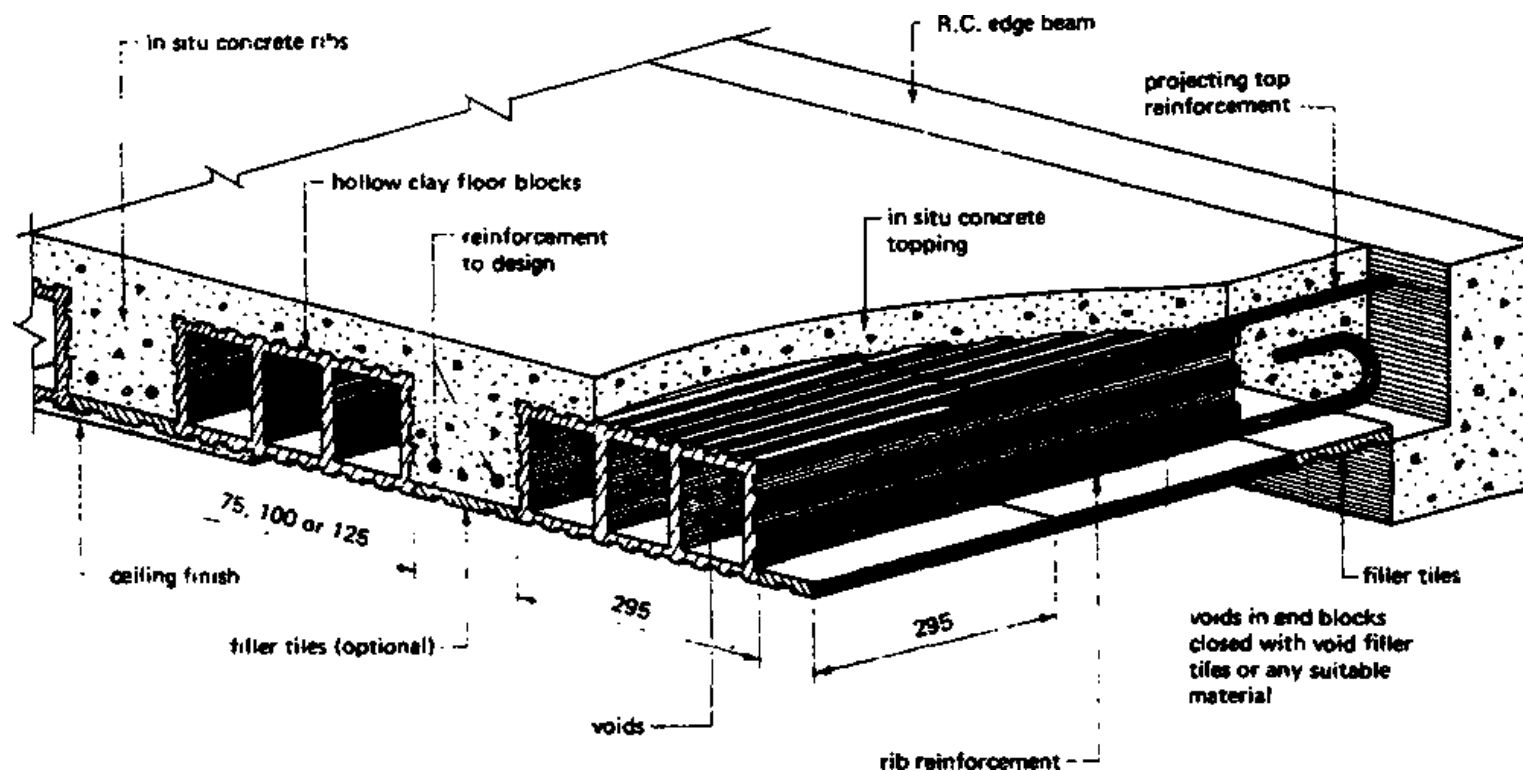

WAFFLE or HONEYCOMB floors

• WAFFLE FLOORS

- These are mainly used as an alternative to an in situ flat slab or a beam and slab suspended floor, since it requires less concrete, less reinforcement and can be used to reduce the number of beams and columns required.

- The honeycomb pattern on the underside can add to the visual aspect of the ceiling by casting attractive shadow pattern.

- The floor is cast over light weight moulds or pans made of glass fibre, poly-propylen or steel forming a **TWO DIRECTIONAL FLOOR**.
- The reinforcement in the ribs is laid in two directions to resist both consitudinal and transverse bending moments in the slab.
- It is advisable to allow for a floor screed to be applied to the in situ topping at a later stage in the contract prior to the fixing of the applied finish.

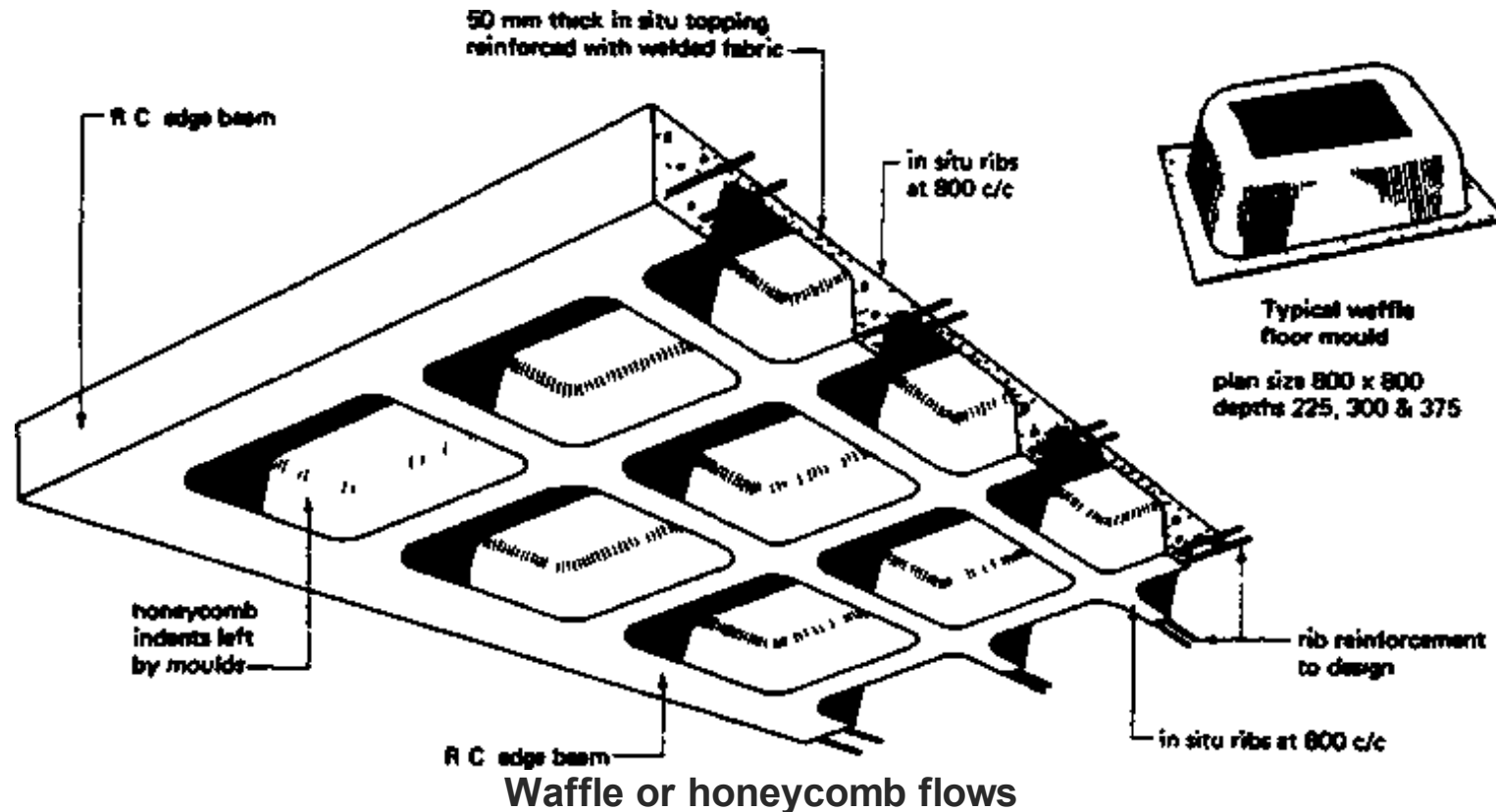

7.5 FLOOR FINISHES

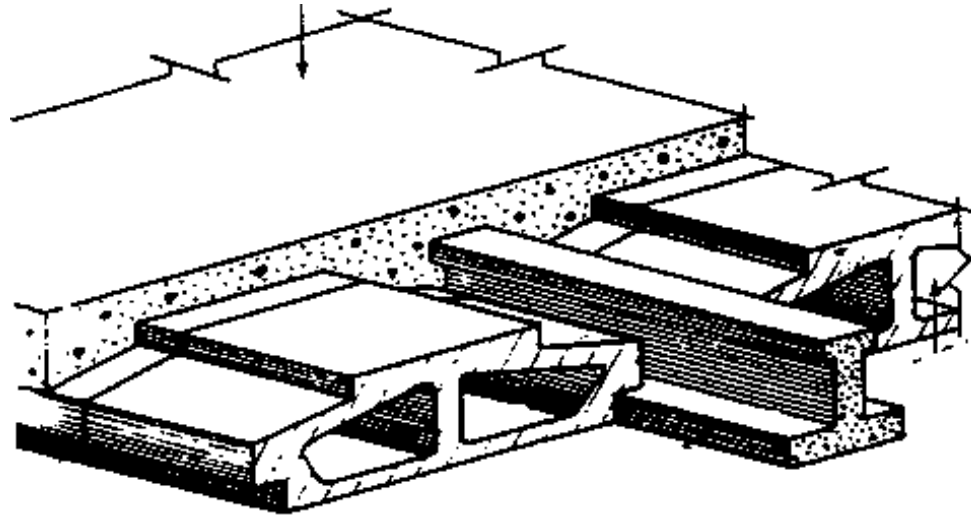

- Floor finishes may be classified into four categories:

1. Jointless floor finishes
2. slab floor finishes
3. sheet floor finishes
4. wood floor finishes

- The choice will depend on many factors; e.g. cost, durability, colour, hardness, slipperness, resistance to oils, acids, heat, sunlight, abrasion, noise and ease of maintenance.

7.5.1 JOINTLESS FLOOR FINISHES

7.5.1.1 The most common of these is the Cement/Sand Screed

It will give a suitable finish especially for bare feet and sandals.

- There are different ways of construction:

7.511 a Monolithic Construction

The screed is laid on the in situ concrete base within 3 hours (before it has set). In that case, a complete BONDING is obtained

- **screed and base shrink together**
- **Thickness of the screed: only 12 mm necessary, on application thicker than 25mm has to be avoided, in order to restrict shrinkage forces from the SCREED.**
- **it will be the best solution to eliminate cracking and curling but...**
- **a proper planning (at the design stage) and complete PROTECTION of the area where screed has been applied is necessary.**



7.511a MONOLITHIC CONSTRUCTION

7.511b Seperate Construction

Once the concrete has set, monolithic construction can no longer be used.

- The strength of the bond between screed and base will depend on the way the base has been prepared.

To achieve a maximum bonding, the base has to be

- hacked (by mechanical means)
- cleaned
- damped (to reduce suction) and
- grouted (or a bonding agent can be used)

- Minimum thickness: 40 mm.



7.511b SEPERATE CONSTRUCTION

7.511c Unbonded Construction

If it is not possible to achieve a bond between base and screed (i.e. in case of an screed application on top of a damp-proof-membrane) the screed layer has to be applied thicker

- Minimum thickness 50 mm.

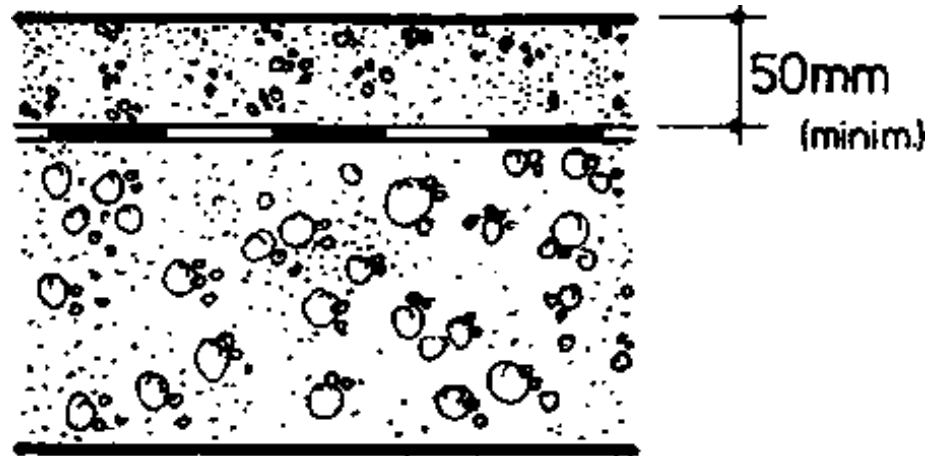

7.511c UNBONDED CONSTRUCTION

7.511 d Floating Construction

Is a screed to be laid on compressible layers of thermal or sound insulation, the material should be applied to a

- minimum thickness 65 mm.

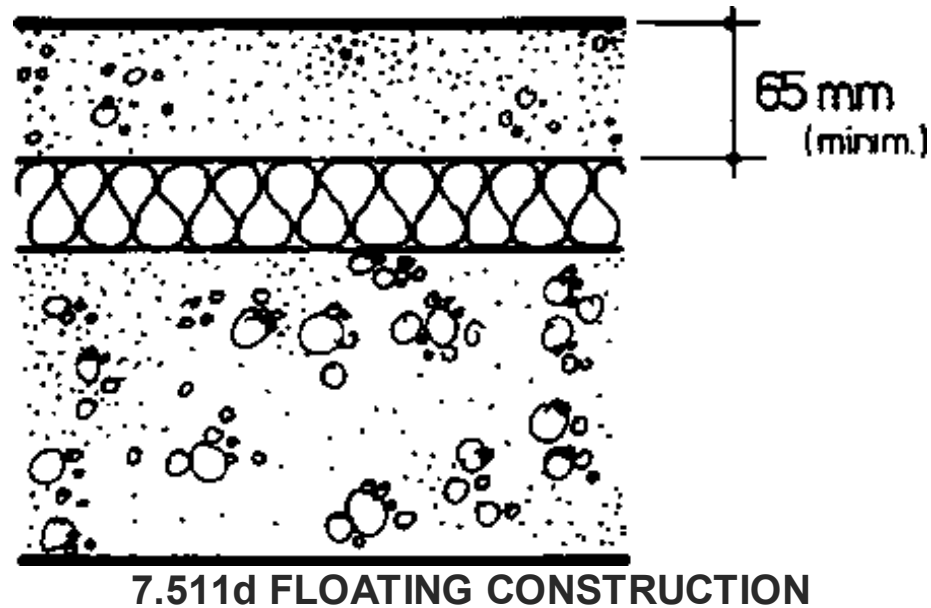

FLOOR SCREEDS

7.511 e Division into bays

In order to avoid cracking and to reduce curling screed should be laid in alternate bays.

- The bay sizes should not be more than 15 m².
- The ratio between the sides of the bays may be approximately 1:1 1/2. - long, narrow bays to be avoided,
- Expansion joints are required only where similar joints are provided in the main structure.

7.511 f Mix designs

- **For screeds up to 40 mm, mixtures of 1: 3 up to 4 1/2 cement/sand are used. (mixes less rich in cement will cause LOWER SHRINKAGE)**
- **For thicker screeds: FINE CONCRETE of 1: 1 1/2: 3 (cement fine aggregate: coarse aggregate) may be applied. The maximum size for coarse aggregate is 10 mm.**

7.5.1.2 Granolithic Concrete Finishes

is used where a more durable surface is needed and suitable granite chip-pings are available.

- **It is laid about 30 mm thick in the same way as cement sand (1 part cement: 3 parts granolithic) and trowelled smooth.**
- **It is used for paved areas, yards, factories, warehouses, and balconies.**
- **It should be kept damp and protected from hot sun for at least 24 hours after laying and cured for 3 days afterwards.**
- **Where a non-slip surface is needed, CARBORUNDUM may be spread into the granolithic finish while it is still green.**
- **Surface hardeners are often applied to granolithic and cement and sand floors. One type of hardener consists of 1 volume of sodium silicate to 4 volumes of water sprayed on after the concrete has set.**
- **Two applications are usual.**

- **For heavy industrial floors, especial steel or plastic grids may be inserted which divide up the floor into TILES.**
- **Synthetic plastics may also be used in place of granite chippings and give a pleasing finish.**

7.5.1.3 Terazzo

consists of 2 parts marble (chippings of various colours and 1 part (white) Portland cement; laid about 12 mm thick on a screed of cement/sand ()

- **Strips of brass or plastic are bedded into the screed and left standing to divide the terrazzo into bays (2-2m²)**
- **The floor is ground smooth with a carborundum machine, or by hand, after it has hardened.**
- **Plastic pellets are also used in place of marble chippings. Synthetic resins and plastics are available in paste form and can be laid 6 mm thick on screeded floors. They have the advantage of being non-slippery when wet.**
- **It is important that both mixingbays and materials be kept clean and free from soil, otherwise the floor finish will show stains.**

7.5.2 SLAB FLOORS FINISEHES

- **natural stone slabs and slates**
- **quarry and vitreous tiles**

The vitreous types are of better quality than quarry and are produced in brighter colours and patterns. The surface can be smooth or ribbed.

Tiles should be soaked and bedded on to a damp screed and tamped into position with a short straight - edge. The joints are grouted and the floor cleaned off. It should NOT be used for several days.

- Concrete tiles make a durable floor and are produced in many colours. Even **TERAZZO TILES** are widely used.
- PVC and vinyl-asbestos tiles are light and obtainable in plenty of different colours. The screed is coated with a primer and tiles stuck with adhesive.

Care must be taken not to lay on too thick a coating of adhesive, because this may ooze through the joints in hot climates and look unsightly. As they are grease- and oil -proof, thermoplastic tiles are used in factories, hotels, kitchens and garages.

- Marble mosaic floors can be laid in many patterns: Pieces of marble of varying colours, about 25 mm square, are pushed into a soft screed of mortar to create the pattern.

This is very highly skilled work. The mosaics can be also sticked to sheets of stiff paper on which the pattern has been drawn. The sheets are cut up, numbered and pressed - **TILES DOWNWARDS** - into the soft screed.

When set, the paper is soaked off and the joints are filled with grout.

7.5.3 SHEET FLOOR FINISHES

- Linoleum
- Cork and

- **Rubber are satisfactory coverings.**
- **Plastic floor coverings are now also widely used. PVC flooring takes several forms: it can be supplied in rolls of about 20 m length and a width between 900 and 1800 mm wide. It is stuck down with a proprietary adhesive.**

7.5.4 WOOD FLOOR FINISHES

- **Boarded floor finishes, tongued and grooved flooring boards, 2,5 mm thick and 5 cm to 15 cm wide are nailed on wood bearers.**
- **Wood-blocks (common measurements are 23 × 7,6 × 2,5cm) are laid in numerous patterns and are stuck on to a dry screeded floor with pitch, mastic.**
- **Wood-mosaic consists of strips of hardwood (120 × 2,5 × 10.0 cm) arranged in 12 cm squares to form a basket-weave pattern. They are laid similar to wood-blocks, and finished with a sanding machine.**
- **Wood pavement is a very durable wood floor finish. The cross-cut end of small wood blocks (6 × 6 × 6 cm, 8 × 8 × 6, 8 × 25 × 6 cm) are exposed to the floor surface and laid in soft asphalt or stuck on to a dry, screeded floor with pitcemastic. For decoration even round sections of wood blocks (up to a diameter of a about 30 cm) are used, the joints are grouted and the surface sanded and polished.**

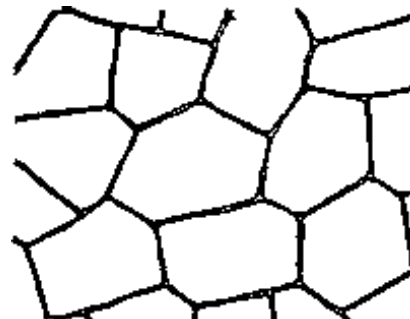

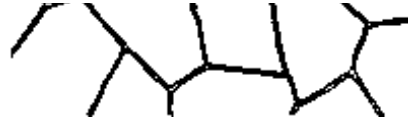

NATURAL STONE SLABEs - irregular

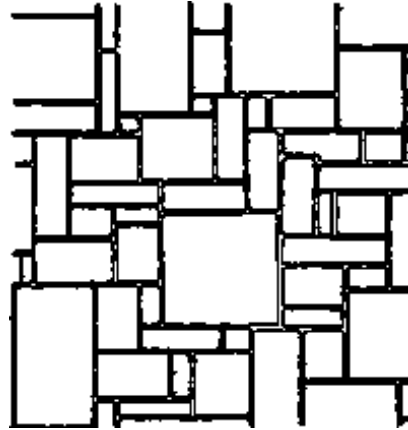

NATURAL STONE SLABEs - roman bond

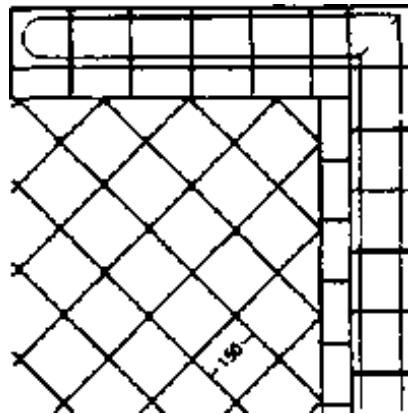

ARTIFICIAL STONE SLABEs with gutter and frieze

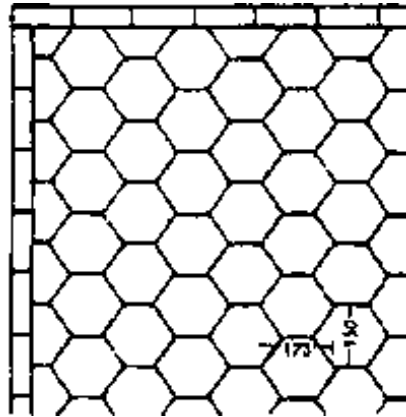

QUARRY or VITREOUS TILES hexagonal; with frieze

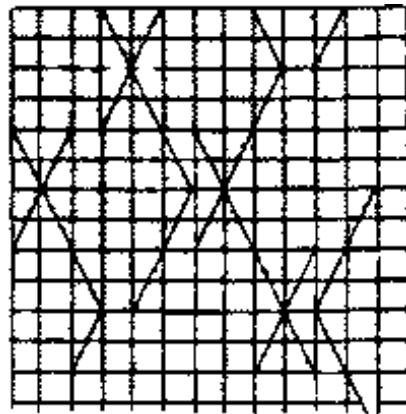

PVC, FLOORFLEX, LINOLEUM TILES

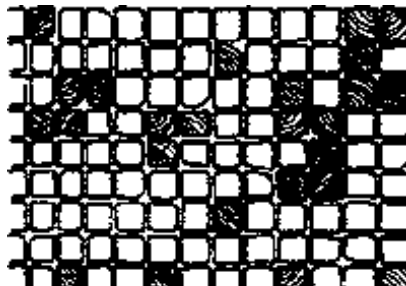



WOOD-PAVEMENT

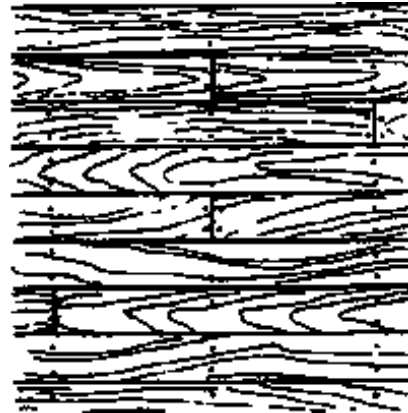

BOARDED FLOOR FINISH - tongued & grooved

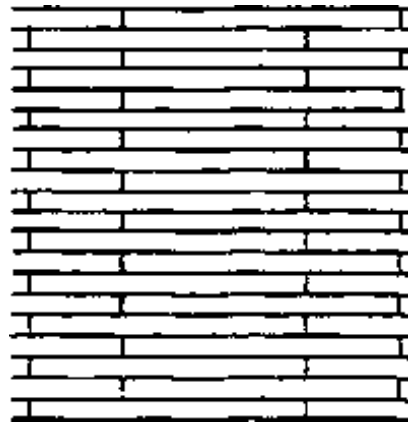

WOOD-BLOCKS

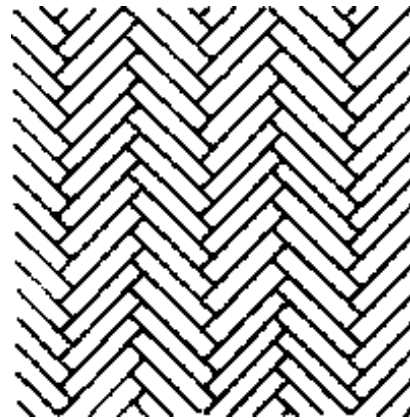

WOOD-MOSAIC

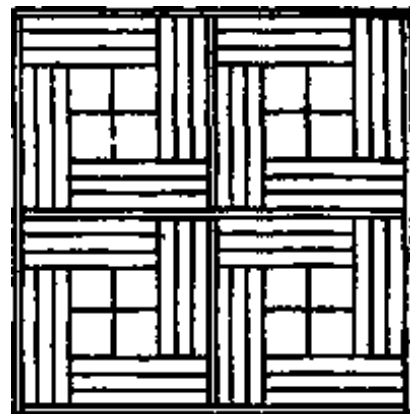

WOOD-MOSAIC

REPETITION • exercises • • REPETITION

Try to answer the following questions and practice sketching where ever necessary and possible.

1) Local Bylaws

Local Bylaws demand a certain capability of carrying load according to its destination.

- a) Which minimum load a domestic floor is required to carry?
- b) Which minimum load an industrial floor is required to carry?

2) Solid Ground Floors

Give explanations (if necessary by sketching) on solid ground floors, particularly on

- a) **Site Concrete:** - thickness of concr. layers
- mixtures
- b) **Hardcore:** - material, which can be used
- thickness of hardcore bed
- blinding
- c) **Waterproof Membran/DPC**

3) Suspended Timber Ground Floors

- a) **What are the construction members of susp. timber ground floors?**
- b) **How to protect susp. timber floors against droughts and dry rot?**
- c) **Draw a sketch of an air brick**
- d) **Show in a sketch the minimum dimensions required under B.R.C.4.**

e) Draw the layouts of suspended timber floors with

- joists, parallel to a fireplace
- joists, at right angles to a fireplace

f) Discuss advantages and disadvantages of suspended timber ground floors.**4) Upper Floors****a) What are the main differences between Ground Floors and Upper Floors?****b) Sketch and explain the structure of an Upper Floor****c) List different types of Upper Floors****d) Explain the term (if necessary by sketching):**

- Common Joist
- Trimming Joist
- Trimmer
- Trimmed Joist

e) Give explanations on "The Spacing of Joists":

- Commonly used distances between joists
- Maximum economical span
- Use of "Double Floor Construction".

f) Sketch different "Strutting Arrangements", such as:

- Herringbone strutting
- Solid strutting: in line
- Solid strutting: staggered

g) Explain three different ways of defining the Size of Floor Joists

h) Sketch and explain different methods of End Support of Floor Joists, such as:

**Built into or
Supported against loadbearing walls**

i) List different sorts of Floor Trimming Joints

j) Write notes on "Monolithic Reinforced Concrete Upper Floors" and describe:

- Thickness
- Reinforcement
- Formwork
- Advantages and Disadvantages if necessary by sketching

k) List and explain different types of "Precast Concrete Upper Floors"

l) Describe (if necessary by sketching) "Hollowblock and Waffle Floors"

6) Floor Finishes:

a) Explain the following terms:

- Jointless Floor Finish
- Cement/Sand Screed
- Monolithic Construction
- Seperate Construction
- Unbonded Construction
- Floating Construction
- Granolithic Floor Finishes
- Terrazzo

Use sketches!

b) Give mix - designes

c) Explain different types of "Slab Floor Finishes"

d) List different types of "Sheet Floor Finishes"

e) Write notes on different types of "Wood Floor Finishes"

Please provide your feedback

English | French | Spanish | German