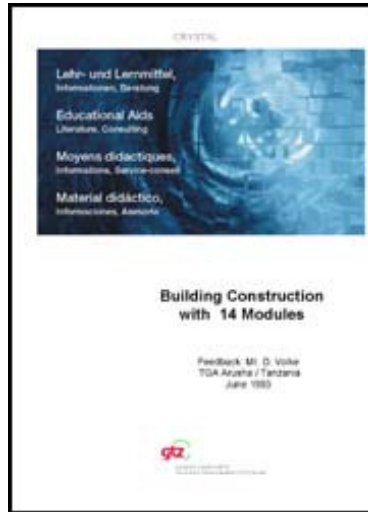

[Home page](#) | [Help](#) | [Clear](#)[English](#) | [French](#) | [Spanish](#) | [German](#)[Search](#) | [Subjects](#) | [Titles A-Z](#) | [Courses](#) | [Illustrations](#) | [Topics](#) | [e-Course builder](#)[Contract TOC](#)[Expand Document](#)[Contract Chapter](#)[Add to e-Course](#)[Preferences](#)

Printable version

Export document
as HTML file [Help](#)

Export document
as PDF file

Building Construction with 14 Modules (TCA; 1983; 618 pages)

1. ARCHITECTURAL DRAWING I

1.1 AIMS AND PURPOSE OF ARCHITECTURAL DRAWINGS

1.1.1 CONTENTS OF ARCHITECTURAL DRAWINGS

1.2 DRAWING EQUIPMENT

1.2.1 PENCILS

1.2.2 DRAWING PENS

1.2.3 COMPASSES

1.2.4 DRAWING BOARDS

1.2.5 T-SQUARES

1.2.6 SET SQUARES

1.2.7 PROTRACTORS

1.2.8 SCALES

1.2.9 FRENCH CURVES

1.2.10 TEMPLATES

1.2.11 DRAWING PINS AND OTHER FIXINGS

1.2.12 MINOR ITEMS OF EQUIPMENT

1.2.13 PRINTING PAPERS

1.2.14 TRACING PAPER, CLOTH AND FILM

 **1.2.15 BACKING SHEETS**

 **1.2.16 DRAWING PAPERS**

 **1.2.17 CARTRIDGE**

 **1.2.18 HANDMADE AND MOULDMADE PAPERS**

 **1.2.19 PLASTIC-COATED CARD**

 **1.3 LETTERING**

 **1.3.1 PRINCIPLE OF LETTERING**

 **1.3.2 FREEHAND LETTERING**

 **1.3.3 TYPES OF LETTERS**

 **1.3.3.1 The Roman Alphabet**

 **1.3.3.2 Sans Serif Letters**

 **1.3.3.3 Inclined Lettering**

 **1.3.3.4 Script Lettering**

 **1.3.3.5 Stencil Lettering**

 **1.3.3.6 Guided Pen Lettering**

 **1.3.3.7 Pressure-Transfer Lettering**

 **1.4 LINEWORK AND DIMENSIONING**

 **1.4.1 TYPES OF LINES**

 **1.4.2 PENCIL DRAWING**

 **1.4.3 INKING - IN**

 **1.4.4 BASIC RULES OF DIMENSIONING**

 **1.4.4.1 Types of Dimensions**

 **1.4.4.2 Placement of Dimensions**

 **1.5 ENLARGEMENT AND REDUCTION OF LINE DRAWINGS** **1.6 GEOMETRICAL CONSTRUCTIONS** **1.6.1 LINES AND ANGLES** **1.6.1.1 To bisect a straight line AB** **1.6.1.2 To divide a straight line AB into a given number of equal parts** **1.6.1.3 To divide a straight line AB into any ratio** **1.6.1.4 To construct an angle of 90°**  **1.6.1.5 To construct an angle of 45°**  **1.6.1.6 To construct an angle of 60°**  **1.6.1.7 To construct an angle of 30°**  **1.6.1.8 To bisect any given angle** **1.6.1.9 To construct an angle SIMILAR to a given angle** **1.6.1.10 To draw a line PARALLEL to a given line** **1.6.2 TRIANGLES** **1.6.2.1 To construct an EQUILATERAL triangle** **1.6.2.2 To construct a triangle with given BASE ANGLES and ALTITUDE** **1.6.2.3 To inscribe a circle in a given triangle ABC** **1.6.2.4 To circumscribe a triangle ABC** **1.6.3 CIRCLES** **1.6.3.1 Basic CIRCLE-Constructions** **1.6.3.2 To draw a tangent to a point A on the circumference of a circle centre O**

 **1.6.3.3 To draw an internal tangent to two circles of equal diameter**

 **1.6.3.4 To find the centre of a given circle arc**

 **1.6.3.5 To join two straight lines at RIGHT ANGLES to each other by an arc of given radius**

 **1.6.3.6 To draw a curve of given radius joining two circles**

 **1.6.3.7 To join two straight lines by two arcs of equal radius**

 **1.6.4 BASIC ARCH CONSTRUCTIONS**

 **2. ARCHITECTURAL DRAWING II**

 **2.1 TYPES OF PROJECTIONS**

 **2.2 ORTHOGRAPHIC PROJECTION**

 **2.2.1 CONSTRUCTION OF ORTHOGRAPHIC PROJECTION**

 **2.2.2 ELEVATIONS**

 **2.2.3 PLANS AND SECTIONS**

 **2.3 PICTORIAL DRAWING**

 **2.3.1 AXONOMETRIC PROJECTION**

 **2.3.2 ISOMETRIC PROJECTION**

 **2.3.3 DIMETRIC PROJECTION**

 **2.3.4 OBLIQUE PROJECTION**

 **2.3.4.1 Length of Receding Lines**























 **2.3.4.2 Construction of Oblique Drawings**

 **2.3.4.3 Rules of Oblique Drawing**























 **2.3.4.4 Scale of the Receding Lines**























 **2.3.4.5 Direction of Receding Lines**

 **2.3.4.6 Position of Axes** **2.4 PERSPECTIVE DRAWING** **2.4.1 PERSPECTIVE TERMS** **2.4.2 PHENOMENA OF PERSPECTIVE DRAWING** **2.4.3 SYSTEMS OF PERSPECTIVE DRAWINGS** **2.4.4 METHODS OF PERSPECTIVE DRAWINGS** **2.4.5 TWO-POINT PERSPECTIVE** **2.4.6 ONE-POINT PERSPECTIVE** **2.5 SHADES AND SHADOWS** **2.5.1 THE USE OF SHADOWS** **2.5.2 SHADES AND SHADOWS** **2.5.3 THE CONVENTIONAL DIRECTION OF LIGHT** **2.5.4 THE 45° DIRECTION** **2.5.5 THE TRUE DIRECTION OF LIGHT** **2.5.6 SHADOWS OF SOLIDS** **2.5.7 PLANES OF SHADOW** **2.5.8 PRINCIPLES OF SHADOW-CASTING** **2.6 DRAWING PRACTICE** **2.6.1 DRAWING SHEETS** **2.6.1.1 Sizes and Folds** **2.6.1.2 Layout and Identification** **2.6.2 LEVELS** **2.6.3 REFERENCING**

-  **2.6.4 ABBREVIATIONS**
-  **2.6.5 REPRESENTATION OF MATERIALS**
-  **2.6.6 GRAPHICAL SYMBOLS AND REPRESENTATION**
-  **2.6.7 HATCHING RULES**
-  **2.7 APPLICATION FOR BUILDING PERMIT**
 -  **2.7.1 PROCEDURE OF APPLYING FOR PERMISSION TO ERECT A BUILDING**
 -  **2.7.2 FORMULARS**
-  **4. CONTRACT PLANNING AND SITE ORGANISATION**
 -  **4.1 CONTRACT PLANNING**
 -  **4.1.1 BAR CHART**
 -  **4.1.2 NETWORK ANALYSIS**
 -  **4.1.3 THE OVERALL PROGRAMME**
 -  **4.1.3.1 Break down of job**
 -  **4.1.3.2 Quantities of work and time content**
 -  **4.1.3.3 Plant and Labour outputs**
 -  **4.1.3.4 Sequence and timing of operations**
 -  **4.1.3.5 The programme chart**
 -  **4.1.4 PLANNING CONSIDERATIONS**
 -  **4.1.4.1 Site conditions and access**
 -  **4.1.4.2 Nature of job**
 -  **4.1.4.3 Plant**
 -  **4.1.4.4 Scaffolding**

 **4.2 SITE ORGANIZATION** **4.2.1 PRELIMINARY WORK** **4.2.2 SITE PLANNING** **4.2.2.1 Period planning** **4.2.2.2 Weekly planning** **4.2.2.3 Progress control** **4.2.3 SITE LAYOUT** **5. FOUNDATIONS** **5.1 SOIL INVESTIGATIONS** **5.1.1 SITE EXPLORATION** **5.1.1.1 Trial holes** **5.1.1.2 Bore holes** **5.1.1.3 Sampling** **5.1.1.4 Tests** **5.1.1.5 Load or bearing test** **5.1.2 SOILS AND SOIL CHARACTERISTICS** **5.1.2.1 Rocks and soils** **5.1.2.2 Stresses and pressures** **5.2 EXCAVATIONS AND TIMBERING** **5.3 TYPES OF FOUNDATIONS** **5.3.1 CLASSIFICATION** **5.3.2 CHOICE OF FOUNDATION** **5.3.3 SPREAD FOUNDATIONS**

-  **5.3.3.1 Strip foundations**
-  **5.3.3.2 Deep strip foundations**
-  **5.3.3.3 Stepped foundations**
-  **5.3.3.4 Pad foundations**
-  **5.3.3.5 Raft foundations**
-  **5.3.4 PILE FOUNDATIONS**
 -  **5.3.4.1 Short bored pile foundations**
-  **5.3.5 PIER FOUNDATIONS**
-  **6. WALLS**
 -  **6.1 FUNCTION AND PROPERTIES OF WALLS**
 -  **6.2 THE BEHAVIOR OF THE WALL UNDER LOAD**
 -  **6.2.1 CALCULATION OF WALL THICKNESS**
 -  **6.3 TYPES OF WALLS**
 -  **6.4 STONEMWORK**
 -  **6.4.1 BUILDING STONES**
 -  **6.4.2 STONEMWORK THERMINOLOGY**
 -  **6.4.3 STONEMWORK CLASSIFICATION**
 -  **6.4.4 RUBBLE WALLING**
 -  **6.4.5 ASHLAR WALLING**
 -  **6.4.5.1 Rules for ashlar work**
 -  **6.5 BRICK WORK**
 -  **6.5.1 BRICKWORK TERMINOLOGY**
 -  **6.5.2 MANUFACTURE OF CLAY BRICKS**

-  **6.5.2.1 Pressed Bricks**
-  **6.5.2.2 Wire cut bricks**
-  **6.5.2.3 Efflorescence**
-  **6.5.3 BRICK CLASSIFICATION**
-  **6.5.4 CALCIUM SILICATE BRICKS**
-  **6.5.5 CONCRETE BRICKS**
-  **6.5.6 MORTARS FOR BRICKWORK**
-  **6.5.7 DAMPNES PENETRATION**
-  **6.5.8 BRICKWORK BONDING**
 -  **6.5.8.1 Common bonds**
-  **6.5.9 METRIC MODULAR BRICKWORK**
-  **6.5.10 JUNCTIONS**
-  **6.5.11 QUOINS OR EXTERNAL ANGLES**
-  **6.5.12 PIERS**
 -  **6.5.12.1 Detached piers:**
 -  **6.5.12.2 Attached Piers (or Pilasters)**
 -  **6.5.12.3 Buttresses**
-  **6.6 BLOCKWORK**
 -  **6.6.1 CLAY BLOCKS**
 -  **6.6.2 PRECAST CONCRETE BLOCKS**
 -  **6.6.3 AERATED CONCRETE BLOCKS**
-  **6.7 CONCRETE WALLS**
 -  **6.7.1 GENERAL**



6.7.2 FOREWORK

6.7.3 PLAIN MONOLITHIC CONCRETE WALL

6.7.3.1 Dense concrete walls

6.7.3.2 Light-weight aggregate

6.7.3.3 No-fines concrete walls

6.7.3.4 Thickness of plain concrete walls

6.7.3.5 Shrinkage reinforcement

6.7.4 REINFORCED CONCRETE WALLS

6.7.4.1 In-Situ Cast external walls

6.7.4.2 Concrete Box Frames

6.7.4.3 Large precast panel structure

6.8 OPENINGS IN WALLS

6.8.1 HEAD

6.8.1.1 Lintels

6.8.1.2 Arches

6.8.2 JAMBS

6.8.3 SILLS AND THRESHOLDS

6.8.3.1 Sills























6.8.3.2 Thresholds























7. FLOORS

7.1 GENERAL























7.2 SOLID GROUND FLOORS



-  **7.2.1 SITE CONCRETE**
-  **7.2.2 HARDCORE**
-  **7.2.3 WATERPROOF MEMBRANE**
-  **7.3 SUSPENDED TIMBER GROUND FLOOR**
 -  **7.3.1 BUILDING REGULATIONS**
 -  **7.3.2 LAY OUT**
-  **7.4 UPPER FLOORS**
 -  **7.4.1 TYPES OF UPPER FLOORS**
 -  **7.4.2 STRUCTURE OF UPPER FLOORS**
 -  **7.4.3 SUSPENDED TIMBER UPPER FLOORS**
 -  **7.4.3.1 Floor Joists**
 -  **7.4.3.2 End Support of Floor Joists**
 -  **7.4.3.3 Trimming**
 -  **7.4.4 REINFORCED CONCRETE UPPER FLOORS**
 -  **7.4.4.1 Monolithic Reinforced Concrete Upper Floors**
 -  **7.4.4.2 Precast Concrete Upper Floors**
 -  **7.4.4.3 Hollow Block and Waffle Floors**
-  **7.5 FLOOR FINISHES**
 -  **7.5.1 JOINTLESS FLOOR FINISHES**
 -  **7.5.1.1 The most common of these is the Cement/Sand Screed**
 -  **7.5.1.2 Granolithic Concrete Finishes**
 -  **7.5.1.3 Terazzo**
 -  **7.5.2 SLAB FLOORS FINISEHES**

-  **7.5.3 SHEET FLOOR FINISHES**
-  **7.5.4 WOOD FLOOR FINISHES**
-  **8. OPEN FIREPLACES, CHIMNEYS AND FLUES**
 -  **8.1 FUNCTION OF FIREPLACES AND FLUES**
 -  **8.2 PRINCIPLES OF FIREPLACE DESIGN**
 -  **8.2.1 TRADITIONAL OPEN FIREPLACE**
 -  **8.2.2 IMPROVED SOLID FUEL APPLIANCES**
 -  **8.3 PRINCIPLES OF FLUE DESIGN**
 -  **8.4 CONSTRUCTION OF FLUE DESIGN**
 -  **8.4.1 NON-CONVECTOR OPEN FIRES**
 -  **8.4.2 CONVECTOR OPEN FIRES**
 -  **8.5 CONSTRUCTION OF CHIMNEYS**
-  **9. ROOFS**
 -  **9.1 FUNCTIONAL REQUIREMENTS**
 -  **9.1.1 STRENGTH AND STABILITY**
 -  **9.1.2 WEATHER RESISTANCE**
 -  **9.1.3 THERMAL INSULATION**
 -  **9.1.4 FIRE RESISTANCE**
 -  **9.1.5 SOUND INSULATION**
 -  **9.2 TYPES OF ROOF STRUCTURES**
 -  **9.2.1 FLAT AND PITCHED ROOFS**
 -  **9.2.2 STRUCTURE OF THE ROOF**
 -  **9.2.3 LONG AND SHORT SPAN ROOFS**

 **9.2 LONG AND SHORT OF A ROOF** **9.3 FLAT ROOFS** **9.3.1 PHYSICAL AND STRUCTURAL PROBLEMS** **9.3.2 STRUCTURE OF A FLAT ROOF** **9.3.3 THERMAL INSULATION MATERIAL** **9.3.4 SINGLE AND DOUBLE FLAT ROOF CONSTRUCTION** **9.3.5 PARAPET WALLS** **9.4 PITCHED ROOFS** **9.4.1 SHAPES OF PITCHED ROOFS IN TIMBER** **9.4.2 TERMS** **9.4.3 TYPES OF PITCHED ROOFS IN TIMBER (STRUCTURES)** **9.4.3.1 Mono-(single) pitched Roof** **9.4.3.2 Lean - to Roof** **9.4.3.3 Couple Roof** **9.4.3.4 Close couple Hoof** **9.4.3.5 Collar Roof** **9.4.3.6 Double or Purlin Roof** **9.4.3.7 Tripple or Trussed Roofs** **9.4.3.8 Trussed Rafters** **9.4.3.9 Hipped Roofs** **9.4.4 VALLEY** **9.4.5 EAVES TREATMENT** **9.4.6 OPENINGS IN TIMBER ROOFS** **9.5 ROOF COVERINGS**

- **9.5 ROOF COVERINGS**
 -  **9.5.1 FUNCTION OF ROOF COVERINGS**
 -  **9.5.2 TYPES OF ROOF COVERINGS**
 -  **9.5.3 SUBSTRUCTURES**
 -  **9.5.4 CHOICE OF ROOF COVERINGS**
 -  **9.5.5 MATERIALS AND COVERING METHODS**
-  **10. FRAMED STRUCTURES**
 -  **10.1 STRUCTURAL CONCEPT**
 -  **10.2 FUNCTIONAL REQUIREMENTS**
 -  **10.3 STRUCTURAL MATERIALS**
 -  **10.4 LAYOUT OF FRAMES**
 -  **10.5 BUILDING FRAMES**
 -  **10.5.1 FUNCTIONS OF BUILDING FRAME MEMBERS**
 -  **10.5.2 REINFORCED CONCRETE FRAMES**
 -  **10.5.2.1 Reinforced Concrete Beams**
 -  **10.5.2.2 Reinforced Concrete Columns**
 -  **10.5.2.3 Reinforced Concrete Slabs**
 -  **10.5.3 PRECAST CONCRETE FRAMES**
 -  **10.5.3.1 Methods of Connections**
 -  **10.5.4 STRUCTURAL STEELWORK FRAMES**
 -  **10.5.4.1 Structural Steel Frames**
 -  **10.5.4.2 Castellated Universal Sections**
 -  **10.5.4.3 Connections**
 - 



10.5.4.4 Structural Steel Connections



10.5.4.5 Frame Erection



10.5.4.6 Fire Protection of Steelwork



10.5.5 TIMBER FRAMES



10.5.5.1 Columns and Beams



10.5.5.2 Connections



10.5.5.3 Building frames in timber



10.5.5.4 Prefabrication



10.6 PORTAL FRAMES



10.6.1 THEORY



10.6.2 CONCRETE PORTAL FRAMES



10.6.3 STEEL PORTAL FRAMES



10.6.4 TIMBER PORTAL FRAMES



11. PROTECTION OF BUILDINGS



11.1 EXCLUSION OF WATER



11.1.1 PRECIPITATION



11.1.1.1 Roof Drainage



11.1.1.2 Flooding



11.1.1.3 Drought



11.1.2 DAMP RISING AND MOISTURE MIGRATION



























11.1.3 CONDENSATION



11.2 THERMAL INSULATION



11.2.1 DEFINITION

-  **11.2.1 DEFINITION**
-  **11.2.2 INSULATING MATERIALS**
-  **11.3 SOUND INSULATION**
 -  **11.3.1 DEFINITION**
 -  **11.3.2 SOUND INSULATION**
 -  **11.3.3 EXTERNAL NOISE**
-  **11.4 FIRE PROTECTION**
 -  **11.4.1 STRUCTURAL FIRE PROTECTION**
 -  **11.4.1.1 Fire Load**
 -  **11.4.1.2 Fire Resistance of Material**
 -  **11.4.1.3 Appropriate Types of Construction**
-  **12. FINISHING & FINISHES**
 -  **12.1 EXTERNAL WALL FINISHES**
 -  **12.1.1 EXTERNAL RENDERING**
 -  **12.1.2 CONCRETE FINISHES**
 -  **12.1.3 CLADDING**
 -  **12.1.3.1 CLADDINGS FIXED TO A STRUCTURAL BACKING**
 -  **12.1.3.2 CLADDINGS TO FRAMED STRUCTURES**
 -  **12.1.4 EXTERNAL PAINTS AND FINISHES**
 -  **12.2 INTERNAL WALL FINISHES**
 -  **12.2.1 PLASTERING**
 -  **12.2.2 OTHER INTERNAL WALL FINISHES**
 -  **12.2.3 PAINTING**
 -  **12.3 CEILING FINISHES**

 **12.5 CEILING FINISHES** **13. STAIRS** **13.1 INTRODUCTION** **13.2 DEFINITION OF TERMS** **13.3 TYPES OF STAIRS** **13.4 DESIGN OF STAIRS** **13.4.1 RISE - TREAD - PROPORTION** **13.4.2 SLOPE OR PITCH** **13.4.3 LANDINGS** **13.4.4 WIDTH** **13.4.5 WALKING LINE** **13.5 CONSTRUCTION OF STAIRS** **13.5.1 BRICK STAIRS** **13.5.2 STONE STAIRS** **13.5.3 CONCRETE STAIRS** **13.5.3.1 In Situ Cast R.C. Stairs** **13.5.3.2 Precast Concrete Stairs** **13.5.4 TIMBER STAIRS** **13.5.5 METAL STAIRS** **13.6 MISCELLANEOUS** **13.6.1 BALUSTRADES/HANDRAILS** **13.6.2 'SAMBA' STAIR, LADDERS, DISAPPEAR STAIRS, RAMPS** **13.6.3 ESCALATORS** **14 DOORS & WINDOWS**

 **14. DOORS & WINDOWS** **14.1 DOORS** **14.1.1 EXTERNAL DOORS** **14.1.2 INTERNAL DOORS** **14.1.3 PURPOSE MADE DOORS** **14.1.4 METHODS OF CONSTRUCTION** **14.1.4.1 Door terminology** **14.1.4.2 Panelled and glazed wood doors** **14.1.4.3 Flush doors** **14.1.4.4 Fire-check flush doors** **14.1.4.5 Matchboarded doors** **14.1.5 FRAMES AND LININGS** **14.1.5.1 Timber Door Frames** **14.1.5.2 Metal door frames** **14.1.5.3 Door linings** **14.1.6 SPECIAL DOORS** **14.2 WINDOWS, GLASS & GLAZING** **14.2.1 PRIMARY FUNCTIONS OF WINDOWS** **14.2.2 BUILDING REGULATIONS** **14.2.3 TRADITIONAL CASEMENT WINDOWS** **14.2.4 STANDARD WOOD CASEMENT WINDOWS** **14.2.5 STEEL CASEMENT WINDOWS** **14.2.6 BAY WINDOWS**



14.2.7 SLIDING SASH WINDOWS

 14.2.7.1 Vertical sliding windows (also called double hung sash windows)

 14.2.7.2 Horizontal sliding windows

 14.2.8 PIVOT WINDOWS

 14.2.9 LOUVRES

 14.2.10 GLASS AND GLAZING

 14.2.10.1 Glass

 14.2.10.2 Glazing

 14.2.11 MOSQUITO SCREENING (FLY SCREENS)

 14.2.12 SUN-BREAKERS

 14.3 IRON MONGERY

 14.3.1 HINGES

 14.3.2 LOCKS AND LATCHES

 14.3.3 MISCELLANEOUS

10. FRAMED STRUCTURES

REFERENCES:

1. R. Chudley
'Construction Technology'
Vol. 2 and 3

2. Jack Stroud Foster

Mitchell's Building Construction

'Structure and Fabric'

Part 1 and 2

10.1 STRUCTURAL CONCEPT

- A framed structure (or skeleton structure) consists essentially of a skeleton or frame work which supports all the loads and resists all the forces acting on the building and through which all loads are transferred to the soil on which the building rests.

- The elements of such framework are pairs of uprights, supporting some form of spanning members.

These are spaced apart and tied together by longitudinal members to form the volume of the building.

They are classified as:

- BUILDING FRAMES of columns and horizontal beams for single and multi-storey buildings.
- SHED FRAMES, of columns and roof trusses for single-storey buildings, and.
- PORTAL or RIGID FRAMES, of columns and horizontal or pitched beams for single-storey buildings.

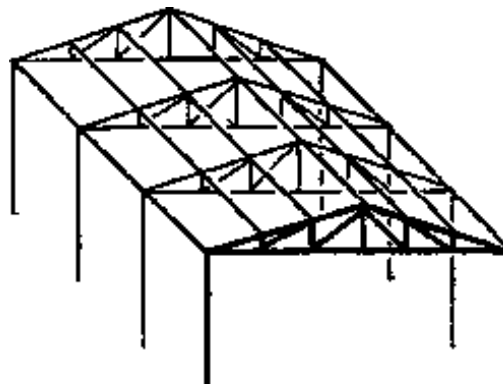

SHED FRAME

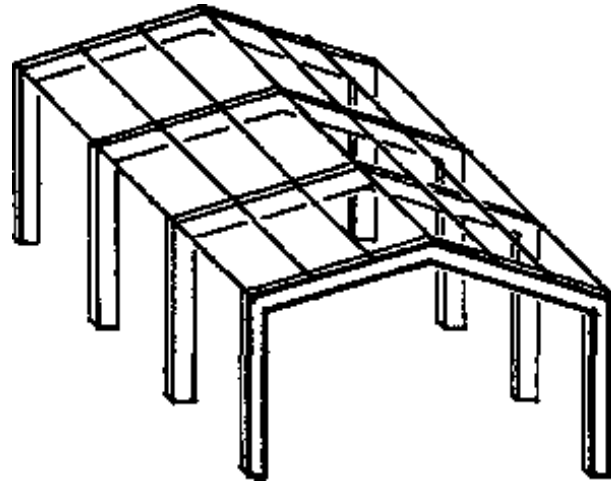

PORTAL FRAME

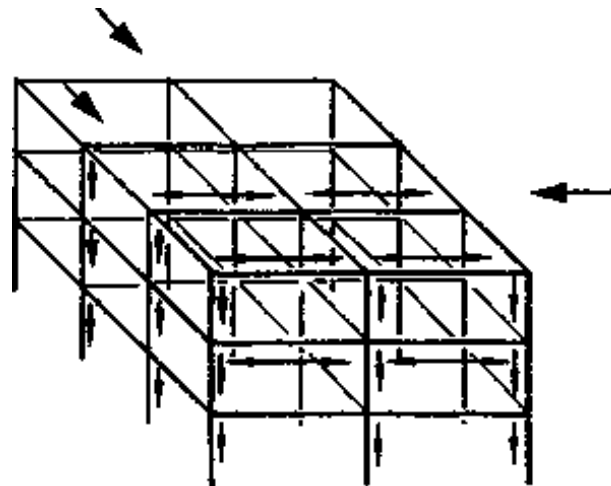

BUILDING FRAME

- In these frames the vertical supports are in compression. **SUSPENDED** (or **SUSPENSION**) **STRUCTURES** have been developed in which the floors are suspended from the top of the building by vertical supports which are therefore in tension.

Other forms of skeleton structures are the frameworks of interconnected members, known as GRID STRUCTURES.

- **By its nature the skeleton frame cannot enclose the space within it. Therefore other enclosing-elements must be associated with it.**
- **The significance of this clear distinction between the supporting element and the enclosing element is that the enclosing element can be made relatively light and is not fixed in its position relative to the skeleton frame or may fit into the panels of the frame.**

The advantages of framed structures are:

- 1) Saving in floor space (particularly when internal structural supports must be provided)**
- 2) Flexibility in plan and building operations because of the absence of load bearing walls at any level.**
- 3) Reduction of dead weight.**

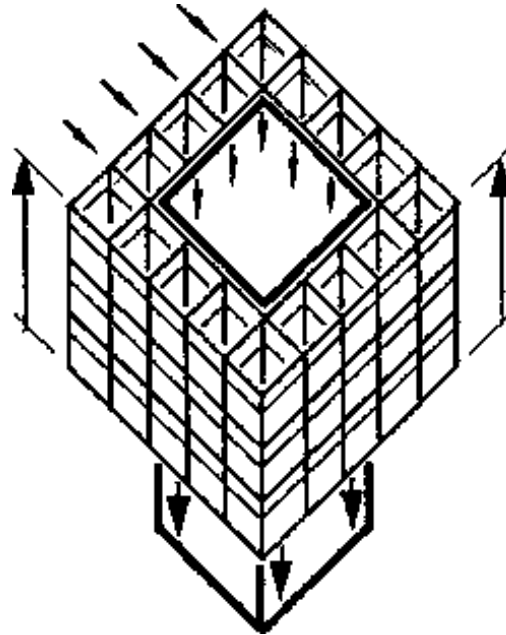

SUSPENSION STRUCTURE

These advantages do not necessarily make a framed structure economically advantageous in every circumstances, i.e. in the case of individual small-scale buildings where the plan area is divided into rooms by walls and partitions.

In general it can be said that framed structures become logical and economical:

1. When the span of roof or floor becomes great enough to necessitate double construction involving beams or trusses applying heavy concentrated loads at certain points on the supporting structure.
2. In the case of industrialised system building, the framed structure can be economic even for small-scale building types. (Due to large-scale production and to the reduction in erection time and of labour on site which should accompany the use of prefabricated components.)

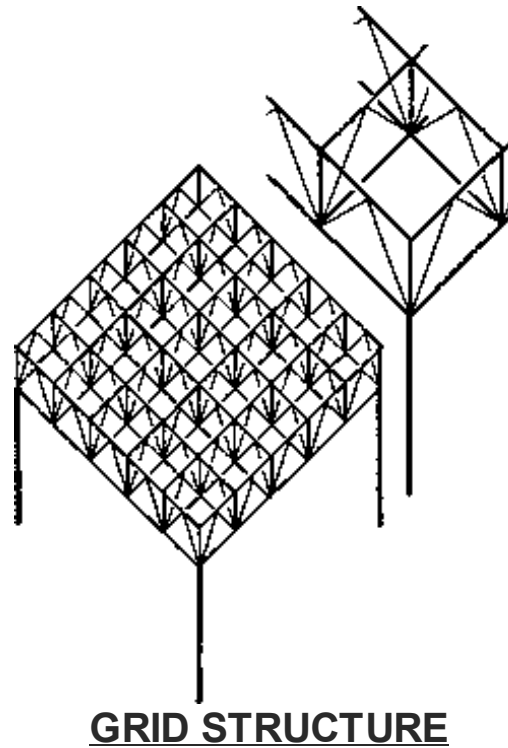

10.2 FUNCTIONAL REQUIREMENTS

Strength and stability: Are ensured by the use of appropriate materials in suitable forms applied with regarding to the manner in which a structure and its parts behave under load.

- Building frames may be classified according to the stiffness or rigidity of the joints between the members, especially between columns and beams.

A NON-RIGID (or pin-jointed) frame is one, in which the nature of the joints is such that the beams are assumed to be simply supported and the joints non-rigid.

Riaidity in the framed structure as a whole is ensured by the inclusion of some stiffing elements in the

structure often in the form of triangulating members.

Steel and timber frames are commonly joined together in this manner and sometimes precast concrete frames.

A SEMI-RIGID frame is one in which some (or all) joints are such that some rigidity is obtained. A technique usually limited to steel frames and which effects some saving in materials. In

A FULLY - RIGID frame, all joints rigid. This results in considerable economics in material in the frame.

Depending upon the nature of the structure the joints alone may provide the stiffness necessary to prevent the frame as a whole from deforming under lateral wind pressure, although additional stiffening elements are often required. This type of building frame can be constructed in steel and concrete.

Fire - resistance: An adequate degree of fire-resistance in the frame is essential in order that its structural integrity may be maintained in the event of fire, either for the full period of a total burn-out or for a period at least long enough to permit any occupants of the building to escape.

- Concrete is highly fire resistant but steel in many circumstance requires the provision of fire-protection, of which a number of forms exist such as en -sure by concrete or by asbestos board. Timber, although a combustible material (which will easily burn in the form of thin boards) burns less readily when in thicknesses greater than about 15 cm. Its combustibility may also be reduced by the application of fire retardants.

10.3 STRUCTURAL MATERIALS

- Materials which are commonly used far framed structures are:

- **Steel**
- **Concrete (reinforced or prestressed)**
- **Timber**
- **Aluminium alloys.**

- Material for framed structures - particularly when these are TALL OR WIDE IN SPAN need to be:

- **Strong**
- **Stiff.**
- **Light in weight.**

The stronger the material the smaller the amount which will be required to resist a given force.

The stiffer the material the less will the structure and its members deform under load.

The relationship of the depth of a spanning member or structure to its span is expressed as the DEPTH/SPAN RATIO, and is useful as a basis of comparison of the effects of using material and forms of structure of different degrees of stiffness. A small depth/span ratio indicates the achievement of adequate stiffness with minimum depth of spanning member.

The lighter the material (provided the strength is adequate) the lower the self-weight of the structure. The self or dead weight of a structure, as well as the load which the structure is to carry, contributes to the stresses set up within it. Low dead weight is an important economic factor (especially in structures carrying light loads)

The smaller the self (or dead) weight of a structure relative to the load to be carried, the more economic the structure.

This relationship is expressed as the DEAD/LIVE LOAD RATIO.

The relationship of the weight of a material to its strength provides an indication of its efficiency in terms of the weight required to fulfil the structural function. This is expressed as the STRENGTH/WEIGHT RATIO, a high value indicating high strength with low self weight resulting in a minimum weight of material to fulfil a particular structural purpose.

STEEL

STEEL is a material strong in both: compression and tension, and it is stiff.

A steel structure is therefore relatively economic in material because a small amount can carry a relatively large load and because it is stiff, the structure and its members will not easily deform under load. It has a high strength/weight ratio. These characteristics make it suitable for both: low-rise and high-rise building frames and roof structures of all spans.

TIMBER

TIMBER varies its bending strength from about 1/28 to 1/23 that of mild steel (according to the species and to the presence or absence of knots and faults in the timber). Compared with other materials its stiffness is low but in relation to its own weight, which is quite light, it is relatively very stiff. Thus in structural applications compensation for its lack of stiffness can be made without excessive increase in weight of structure.

It has a relatively high strength/weight ratio, and is suitable for lightly or moderately loaded low-rise building frames and for shed and rigid frames (particularly where the span and weight of these are large).

CONCRETE

CONCRETE varies in strength according to mix.

The compressive strength of normal structural concrete is about 1/16 that of steel, but its tensile strength is only about 1/10 of its compressive strength. Its stiffness is low compared with steel and its strength/weight ratio is low. To overcome this weakness, structural members are REINFORCED in their tension zones with steel bars or PRESTRESSED in the same zones (usually by means of steel wires or cables).

In reinforced concrete is suitable for SHORT-SPAN low-and high-rise building frames. In prestressed concrete may also be applied to shed frames using precast roof trusses.

ALUMINIUM

ALUMINIUM varies in strength according to the particular alloy, from about 3/4 that of mild steel to strengths somewhat greater than that of steel. Although stiffer than either concrete or timber, aluminium alloys are only about 1/3 as stiff as steel but they are only about 1/3 its weight. These characteristics make them suitable for roof structures (which carry only light imposed loads); particularly those of long span, and less so for normal building frames. The high cost of aluminium usually precludes its structural use for other than very wide span roof structures.

10.4 LAYOUT OF FRAMES

- As a general rule: Space columns as closely as the nature of the building will permit.

This resulting in short span beams or trusses will be cheaper than one with widely spaced columns. With smaller spans the beams reduce in size and cost and - similarly - the columns, because of the reduced loads they carry.

- The SPACING of the frames is influenced largely by the economic span of the floor or roofing system which they support and this will vary with the imposed floor or roof loading and the type of floor or roofing system.

In the case of building frames and rigid frames it can be shown, that as the frame beams increase in span (or frame columns increase in height) there comes a point at which it may be more economic to increase the spacing between the frames, rather than to maintain them at the most economic span of particular floor or roofing system.

In the case of shed frames, a close spacing of the frames usually gives the cheapest structure.

The layout of a skeleton structure should be based on a regular structural grid because:

- loads on the structure are transmitted evenly to the foundations (minimising relative settlement and standardising the sizes of foundation slabs).**
- It results in regularity in beam depths and column sizes and in the position of columns and beams relative to walls. This avoids the use of 'waste' material to bring beams and columns to similar dimensions either because they are exposed to view or, in the case of reinforced concrete, to standardise formwork. It also standardises the size of dividing and enclosing walls or panels.**
- In reinforced concrete work the regular slab and beam spans minimise the variations in rod sizes.**
- It permits greater re-use of formwork, both in precast and in situ concrete construction.**

10.5 BUILDING FRAMES

- Building frames are basically a series of rectangular frames, placed at right angles to one another so that the loads are transmitted from member to member until they are transferred through the foundations to the subsoil.

- Building frames can be economically constructed of

- **Concrete**
- **Steel or a combination of the two and.**
- **Timber.**

10.5.1 FUNCTIONS OF BUILDING FRAME MEMBERS

Main beams:

Span between columns and transfer the live and imposed loads placed upon them to the columns.

Secondary beams: Span between and transfer their loadings to the main beams. Primary function is to reduce the spans of the floors or roof being supported by the frame.

Tie beams:

Internal beams spanning between columns at right angles to the direction of the main beams and have the same function as a main beam.

Edge beams:

As tie beam but spanning between external columns.

Columns:

Vertical members which carry the loads transferred by the beams to the foundations.

Foundation:

The base(s), to which the columns are connected and serve to transfer the loadings to a suitable load-bearing subsoil.

Floors:

May or may not be an integral part of the frame; they provide the platform on which equipment can be placed and on which people can circulate. Besides transmitting these live loads to the supporting beams they may also be required to provide a specific fire resistance, together with a degree of sound and thermal insulation.

Roof:

Similar to floors but its main function is to provide a weather-resistant covering to the upper most floor.

Walls:

The envelope of the structure which provides the resistance to the elements, entry of daylight, natural ventilation, fire resistance, thermal insulation and sound insulation.

10.5.2 REINFORCED CONCRETE FRAMES

Reinforced concrete, because of its particular characteristics, can be formed into walls as well as into beams and columns to form a skeleton frame and the designer's freedom to cast concrete in almost any shape is only limited by the cost of the formwork or shuttering into which the concrete must be poured. This forms a large proportion of the total cost of a reinforced concrete structure as can be seen from the following approximate percentage breakdown:

- Concrete 40%

Materials 28%

Labour	12%
- Shuttering incl. erection and stripping	32%
Materials	12%
Labour	20%
- Reinforcement	28%
Materials	10%
Labour	18%

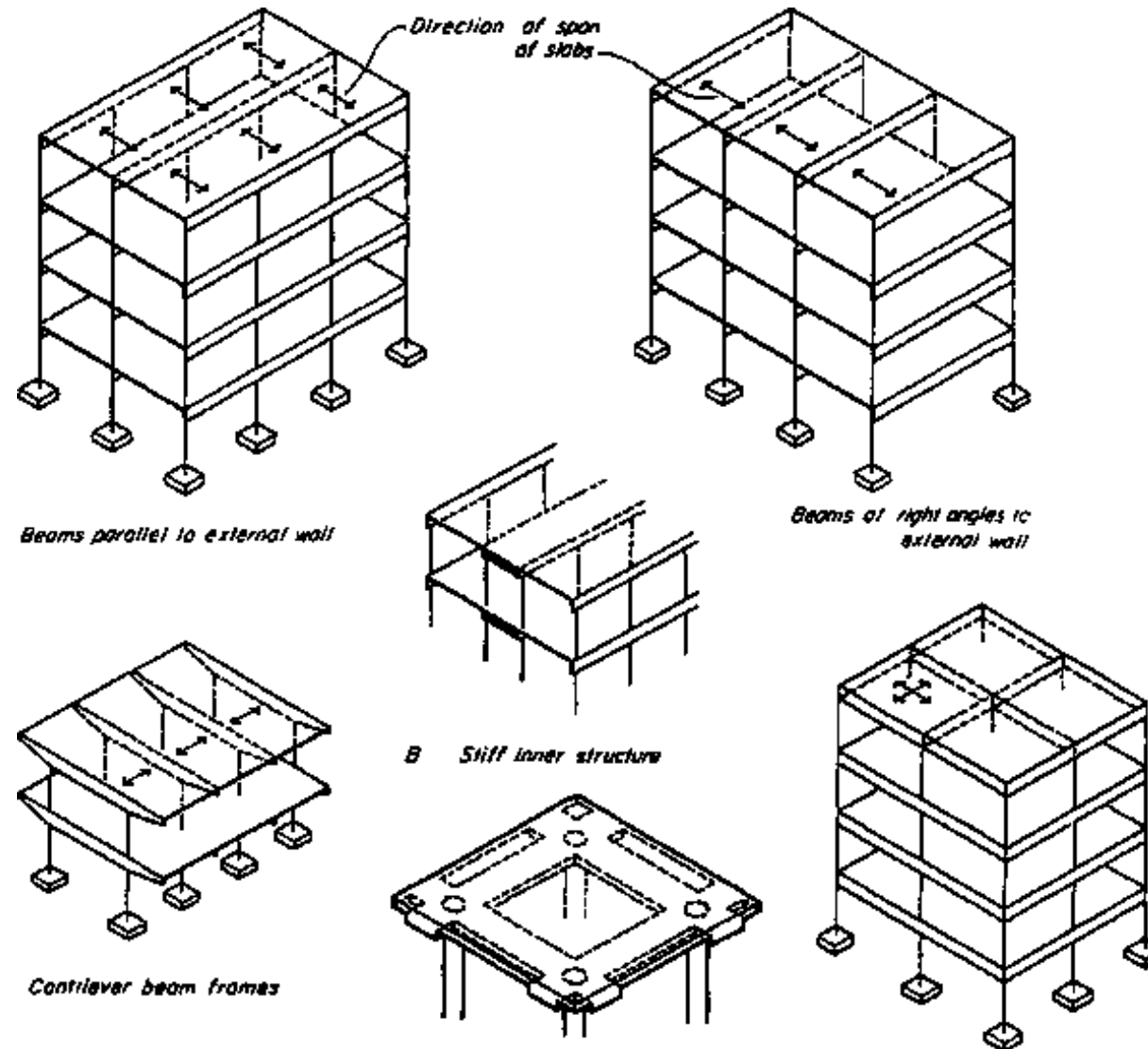

10.5.2.1 Reinforced Concrete Beams

Beams can vary in their complexity of design and reinforcement from the very simple beam formed over

an isolated opening to the more common form encountered in frames where the beams transfer their loadings to the columns.

When tension is induced into beam the fibres will lengthen until the ultimate tensile strength is reached, when cracking and subsequent failure will occur. With a uniformly distributed load the position and value of tensile stress can easily be calculated, but the problem becomes more complex when heavy point loads are encountered.

The concrete design of a r.c. beam will ensure, that it has sufficient strength to resist both the compression and tensile forces encountered in the outer fibres, but it can still fail in the 'web' connecting the compression and tension areas. This form of failure is called SHEAR failure and is in fact diagonal tension.

Concrete has a limited amount of resistance to shear failure and if this is exceeded reinforcement must be added to provide extra resistance.

Shear occurs at or near the supports as a diagonal failure line at an angle of approximately 45° to the horizontal and sloping downwards towards the support (A useful fact to remember is that zero shear occurs at the point of maximum bending.).

Reinforcement to resist shearing force may be either stirrups or inclined bars, or both. The total shearing resistance is the sum of the shearing resistances of the inclined bars and the stirrups, calculated separately if both are provided.

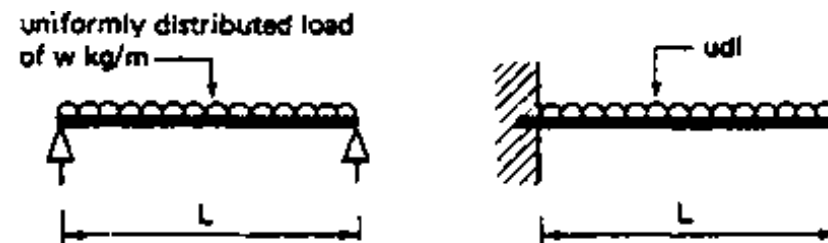

Simply supported beam

Cantilever beam

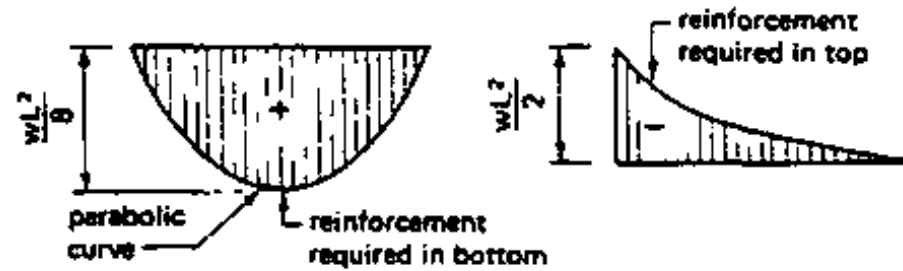

Bending moment diagrams



Shear force diagrams

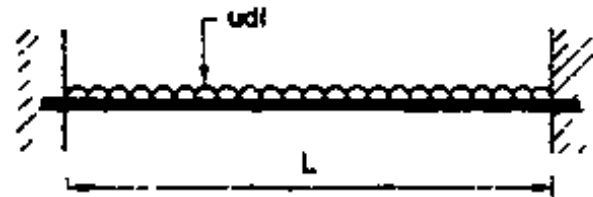

Beam with fixed ends

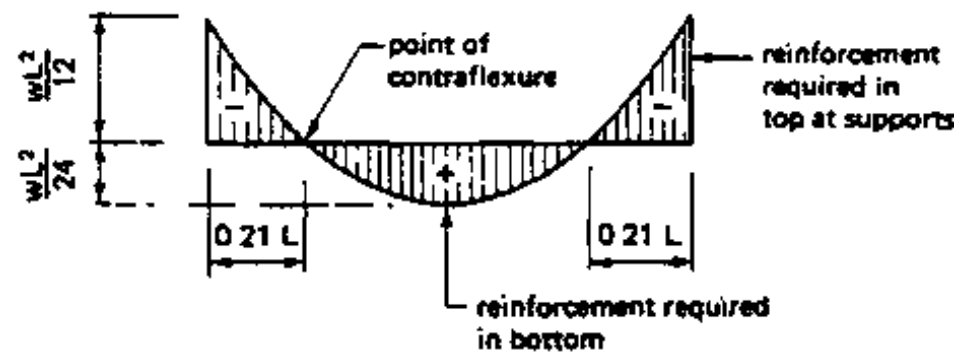

Bending moment diagram



Shear force diagram

Bending moment and shear force diagrams

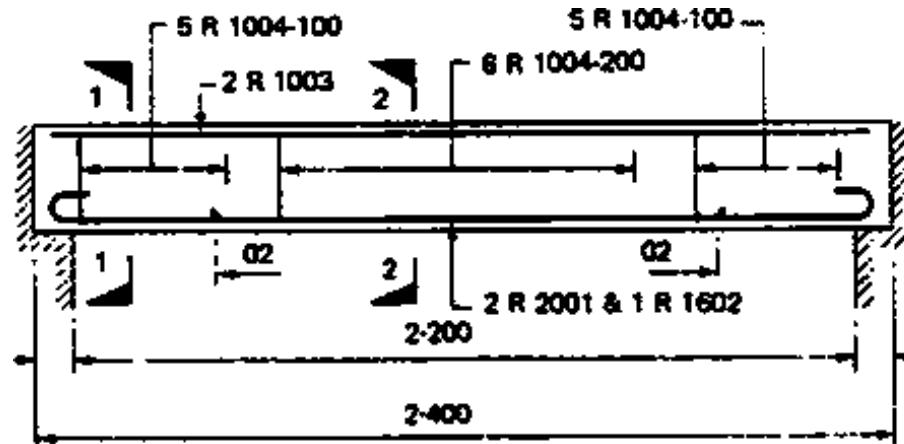

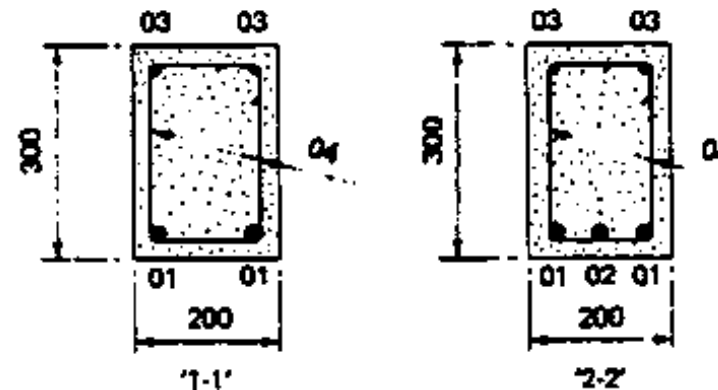

Elevation—beam 1-3 No. thus



Inclined or bent up bars should be at 45° to the horizontal and positioned to cut the anticipated shear failure plane at right angles. These may be separate bars or alternatively main bars from the bottom of the beam which are no longer required to resist tension which can be bent up and carried over or onto the support to provide the shear resistance. Stirrups or binders are provided in beams, even where not required for shear resistance, to minimise shrinkage cracking and to form a cage for easy handling. The nominal spacing for stirrups must be such that the spacing dimension used is not greater than the lever arm of the section, which is the depth of the beam from the centre of the compression area to the centre

width of the section, which is the depth of the beam from the centre of the compression area to the centre of the tension area or 0.75 times the effective depth of the beam, which is measured from the top of the beam to the centre of the tension reinforcement. If stirrups are spaced at a greater distance than the lever arm it would be possible for a shearing plane to occur between consecutive stirrups, but if the centres of the stirrups are reduced locally about the position at which shear is likely to occur several stirrups may cut the shear plane and therefore the total area of steel crossing the shear plane is increased to offer the tensile resistance to the shearing force.

Member	Bar mark	Type & size	No. of mbrs	No. in each	Total No.	Length of each bar†	Shape. All dimensions* are in accordance with BS 4466
Beam 1	1	R20	3	2	6	2660	
	2	R18	3	1	3	1400	straight
	3	R10	3	2	6	2300	straight
	4	R10	3	16	48	1000	

† specified to nearest 25 mm * specified to nearest 5 mm

Typical R.C. beam details and schedule

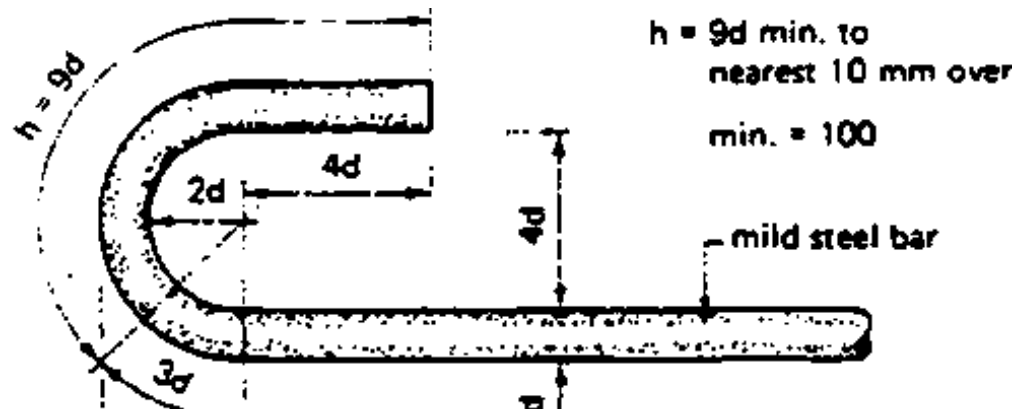



Standard hooks and bends

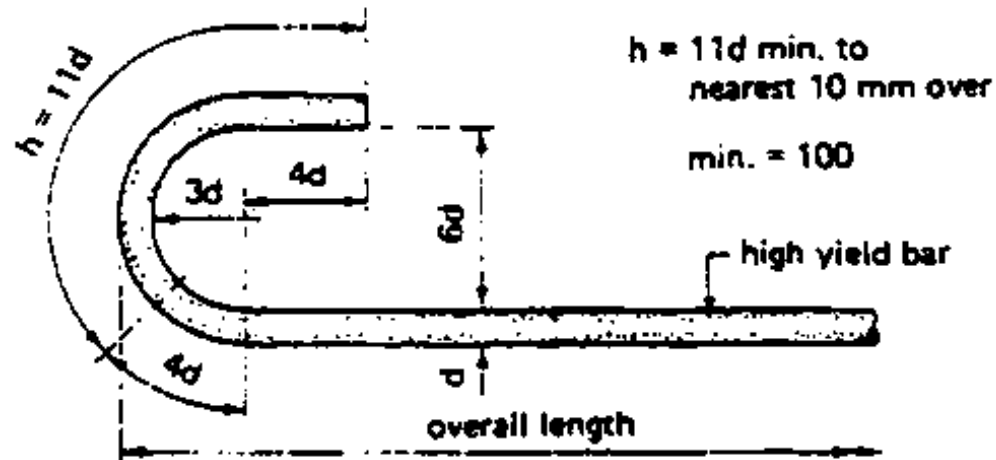
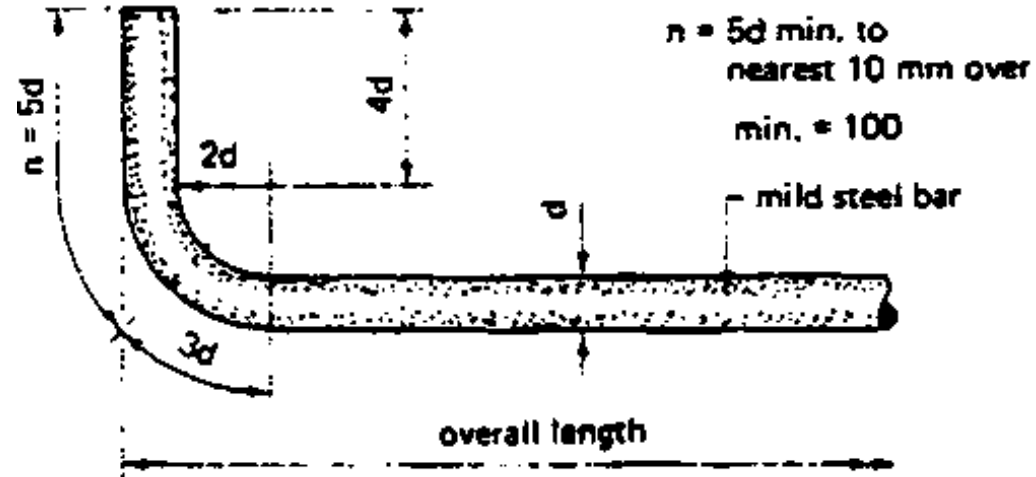

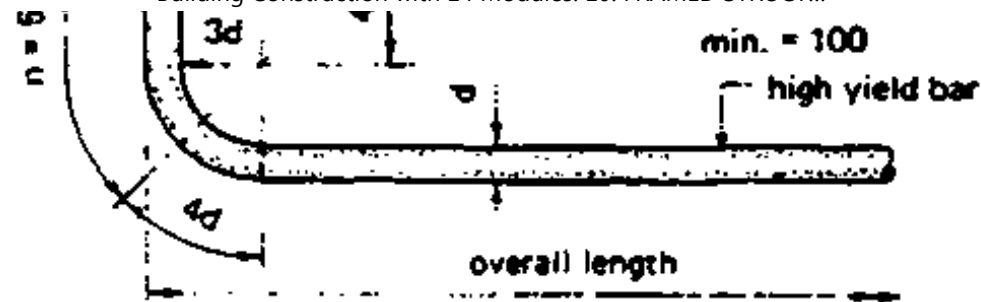

Standard hooks and bends

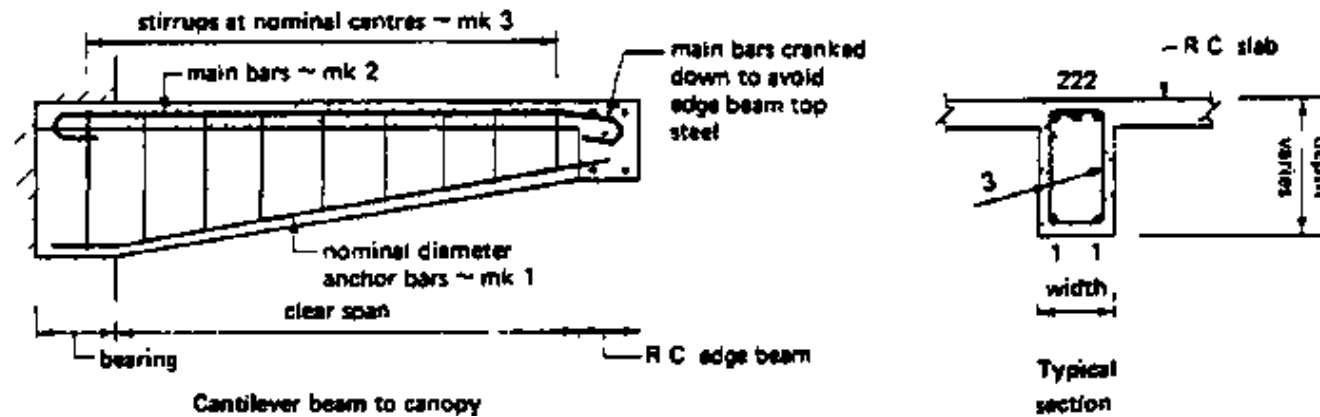
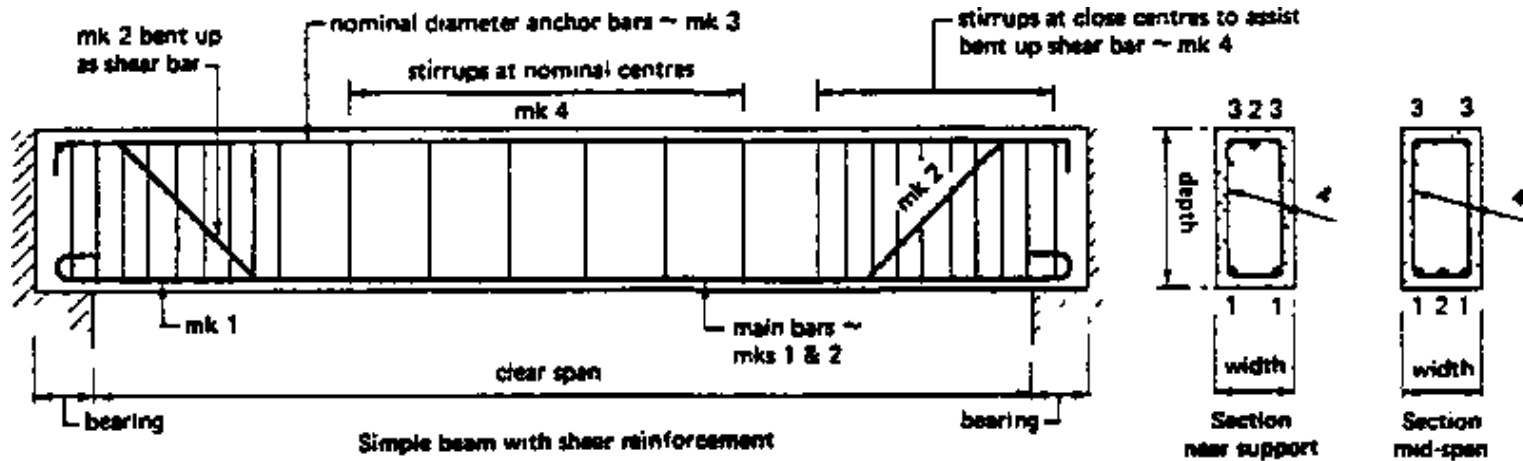

Simple reinforced concrete beams

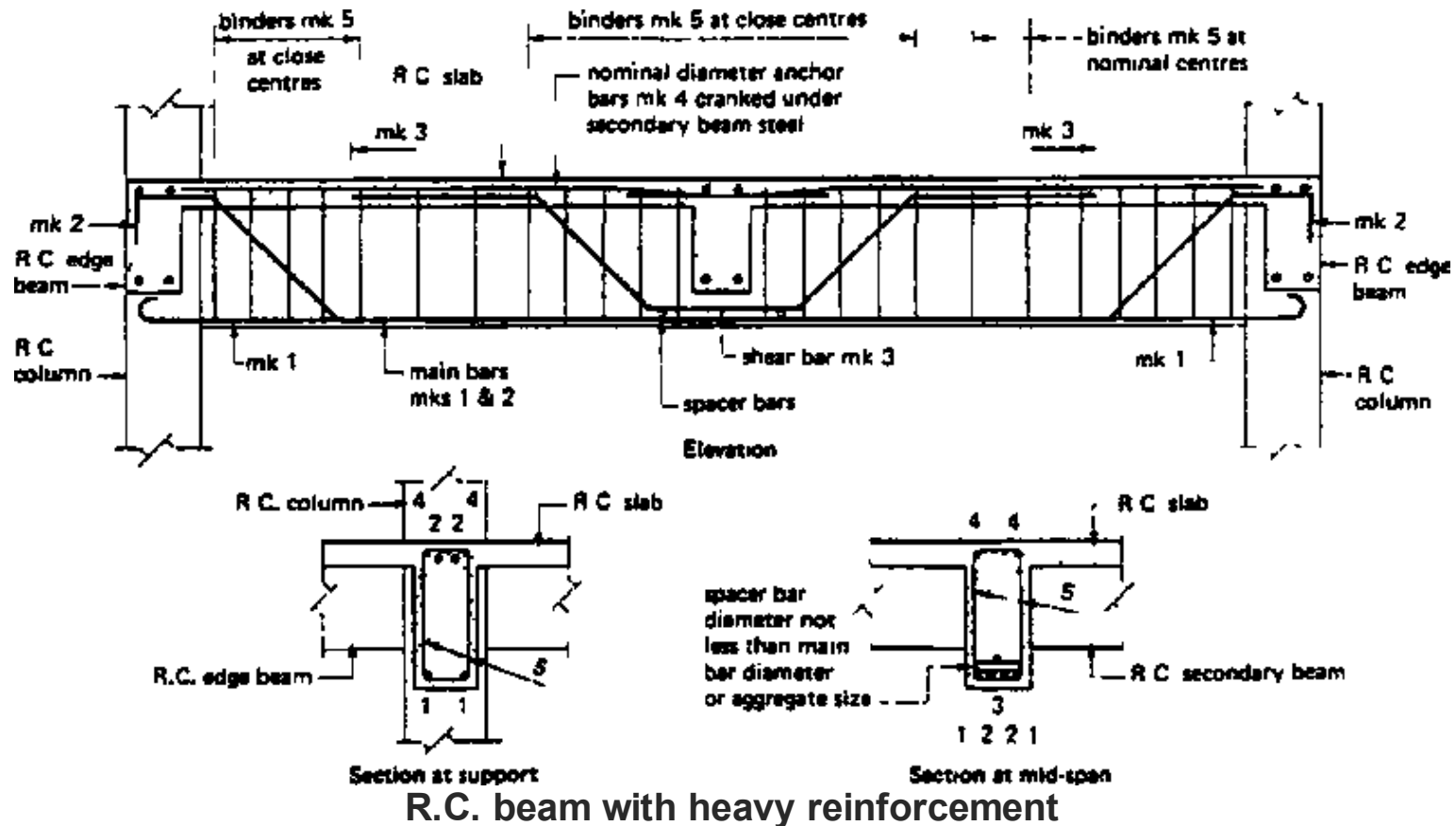

10.5.2.2 Reinforced Concrete Columns

A column is a vertical member carrying the beam and floor loadings to the foundation and is a compression member. Since concrete is strong in compression it may be concluded that provided the compressive strength of the concrete is not exceeded no reinforcement will be required. For this condition to be true the following conditions must exist:

1. Loading must be axial.

2. Column must be short, which can be defined as a column where the ratio of its effective height to its thickness does not exceed 12.
3. Cross section of the column must be large.

These conditions rarely occur in framed buildings, consequently bending is induced and the need for reinforcement to provide tensile strength is apparent. Bending in columns may be induced by one or more of the following conditions:

1. Load coupled with the slenderness of the column; a column is considered to be slender if the ratio of effective height to thickness exceeds 12.
2. Reaction to beams upon the columns, as the beam deflects it tends to pull the column towards itself thus inducing tension in the far face.
3. The reaction of the frame to wind loadings both positive and negative.

The minimum number of main bars in a column should not be less than four for rectangular columns and six for circular columns with a total cross section area of not less than 1% of the cross sectional area of the column and a minimum diameter of 12mm. To prevent the slender main bars from buckling and hence causing spalling of the concrete, links or binders are used as a restraint.

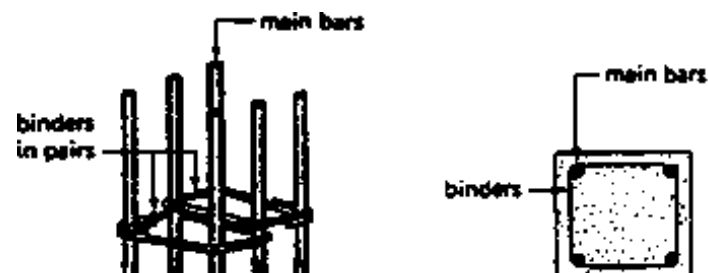

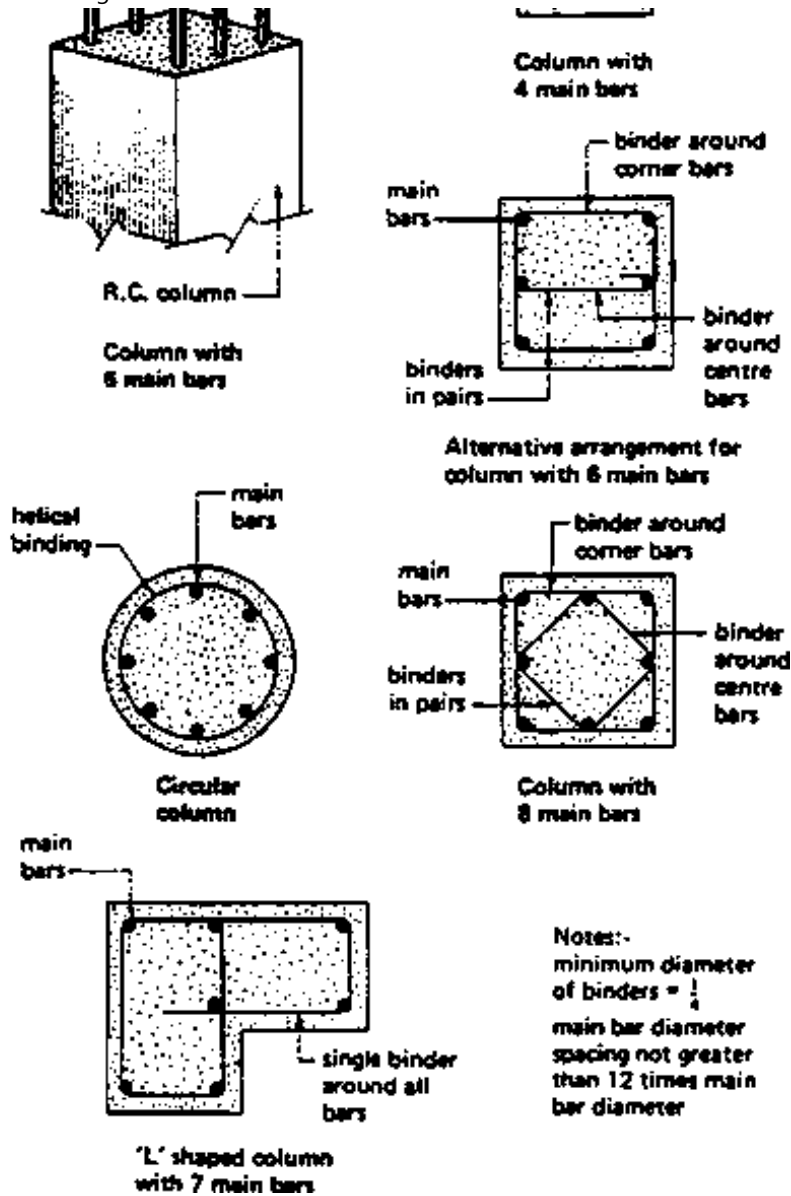

Notes:-
 minimum diameter of binders = $\frac{1}{4}$
 main bar diameter
 spacing not greater than 12 times main bar diameter

R.C. column binding arrangements

Notes:- minimum diameter of binders = $\frac{1}{4}$ main bar diameter spacing not greater than 12 times main bar diameter

These should be at least one quarter of the largest main bar diameter and at a pitch or spacing not

These should be at least one-quarter of the largest main bar diameter and at a pitch or spacing not greater than twelve times the main bar diameter. All bars in compression should be tied by a link passing around the bar in such a way that it tends to move the bar towards the centre of the column.

Where the junction between beams and columns occur there could be a clash of steel since bars from the beam may well be in the same plane as bars in the columns. To avoid this situation one group of bars must be bent or cranked into another plane; it is generally considered that the best practical solution is to crank the column bars to avoid the beam steel.

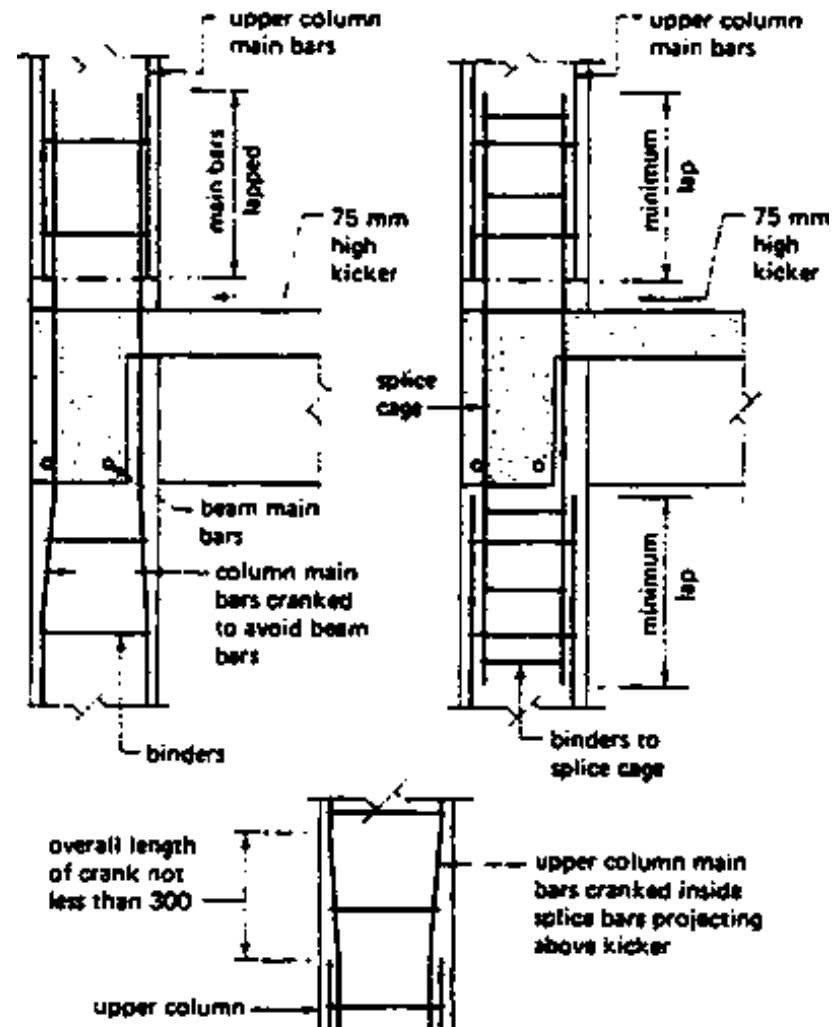

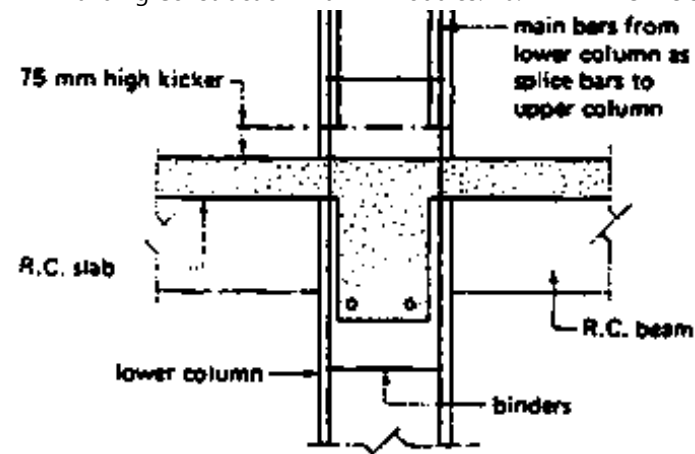

R.C. column and beam junctions

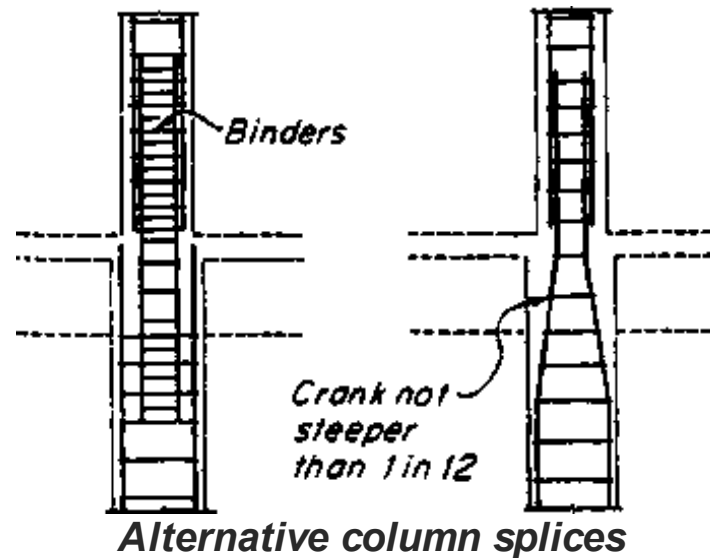

Alternative column splices

10.5.2.3 Reinforced Concrete Slabs

A reinforced concrete slab will behave in exactly the same manner as a reinforced concrete beam and it is therefore designed in the same manner. The designer will analyse the loadings, bending moments, shear forces and reinforcement requirements on a slab strip 1.000 m wide. In practice the reinforcement

will be fabricated to form a continuous mat. For light loadings a mat of welded fabric could be used.

There are three basic forms of reinforced concrete slabs, namely:

- 1. Flat slab floors or roofs.**
- 2. Beam and slab floors or roofs.**
- 3. Ribbed floors or roofs - see 7. FLOORS.**

1) Flat slabs

These are basically slabs contained between two plain surfaces and can be either simple or complex. The design of the complex form is based upon the slab acting as a plate in which the slab is divided into middle and column strips; the reinforcement being concentrated in the latter strips.

Simple flat slabs can be thick and heavy but have the advantage of giving clear ceiling heights since there are no internal beams.

They are generally economic up to spans of approximately 9.000 m and can be designed to span one way, that is across the shortest span, or to span in two directions. These simple slabs are generally designed to be simply supported, that is, there is no theoretical restraint at the edges and therefore tension is not induced and reinforcement is not required. However, it is common practice to provide some top reinforcement at the supports as anti-crack steel should there, in practice, be a small degree of restraint. Generally this steel is 50 % of the main steel requirement and extends into the slab for 0.2 m of the span. An economic method is to crank up 50% of the main steel or every alternate bar over the support since the bending moment would have reduced to such a degree at this point it is no longer required in the bottom of the slab. If there is an edge beam the top steel can also be provided by extending the beam binders into the slab.

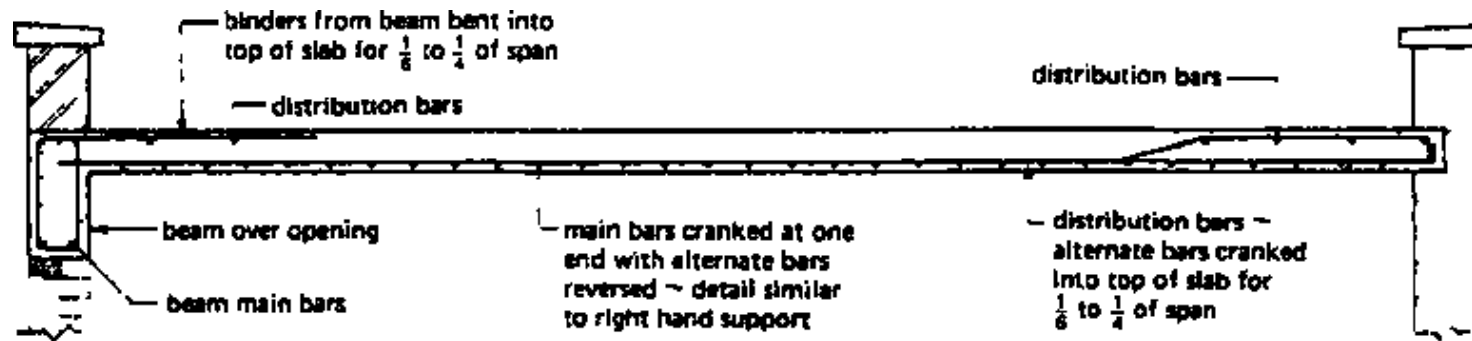

Typical R.C. flat slab

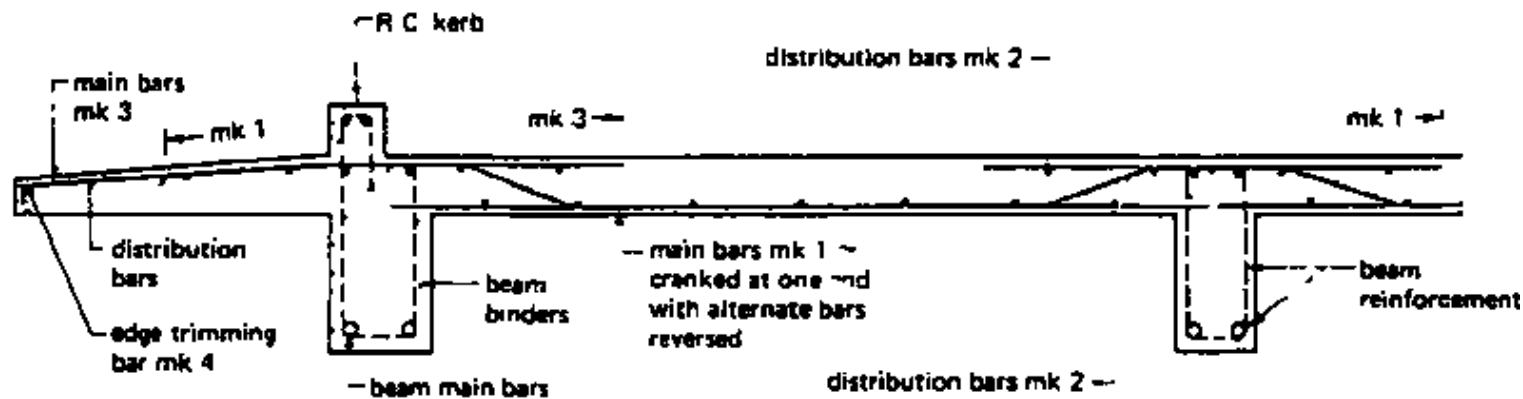
Typical R C beam and slab with cantilever
Typical R.C. slab details

2) Seam and slab

By adopting this method of design large spans are possible and the reinforcement is generally uncomplicated. A negative moment will occur over the internal supports necessitating top reinforcement; as with the flat slabs, this can be provided by cranked bars. Each bar is in fact cranked but alternate bars are reversed thus simplifying bending and identification of the bars. Alternatively a separate mat of reinforcement supported on chairs can be used over the supports.

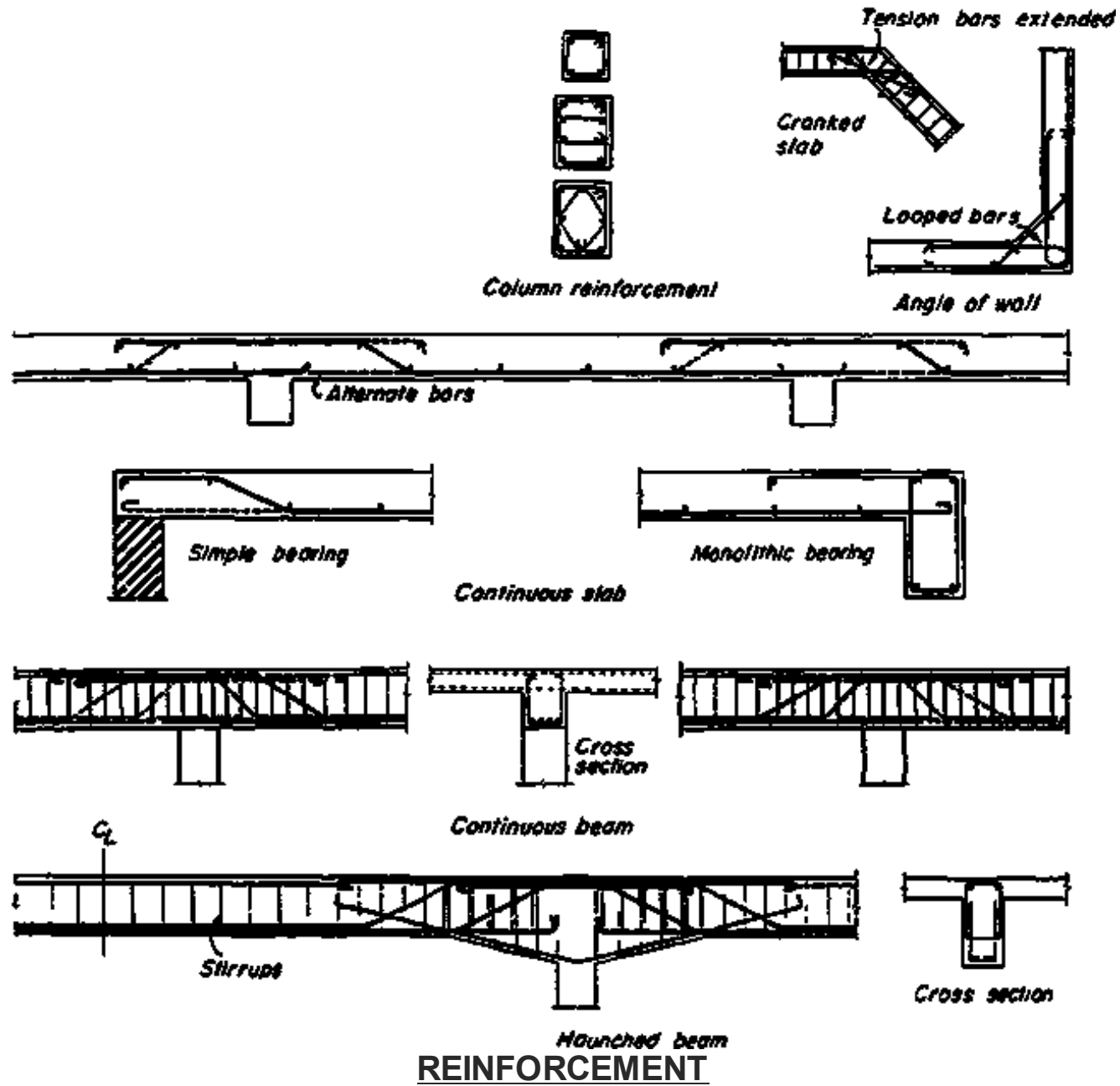

10.5.3 PRECAST CONCRETE FRAMES

The overall concept of a precast concrete frame is the same as any other framing material. Single or multi-storey frames can be produced on the skeleton or box frame principle. Single and two-storey buildings can also be produced as portal frames, a method generally reserved for advanced level study. Most precast concrete frames are produced as part of a 'system' building and therefore it is only possible to generalise in an overall study of this method of framing.

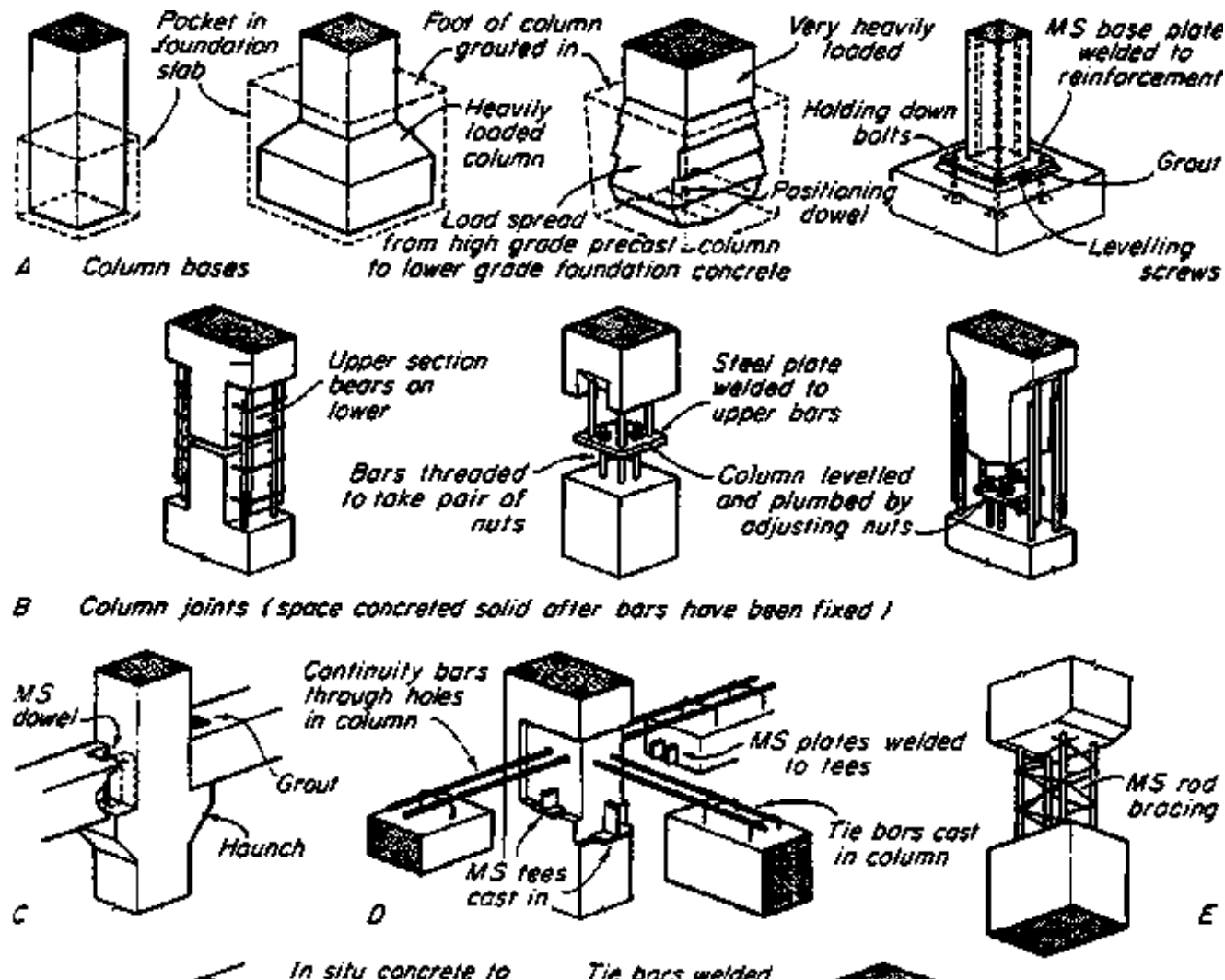

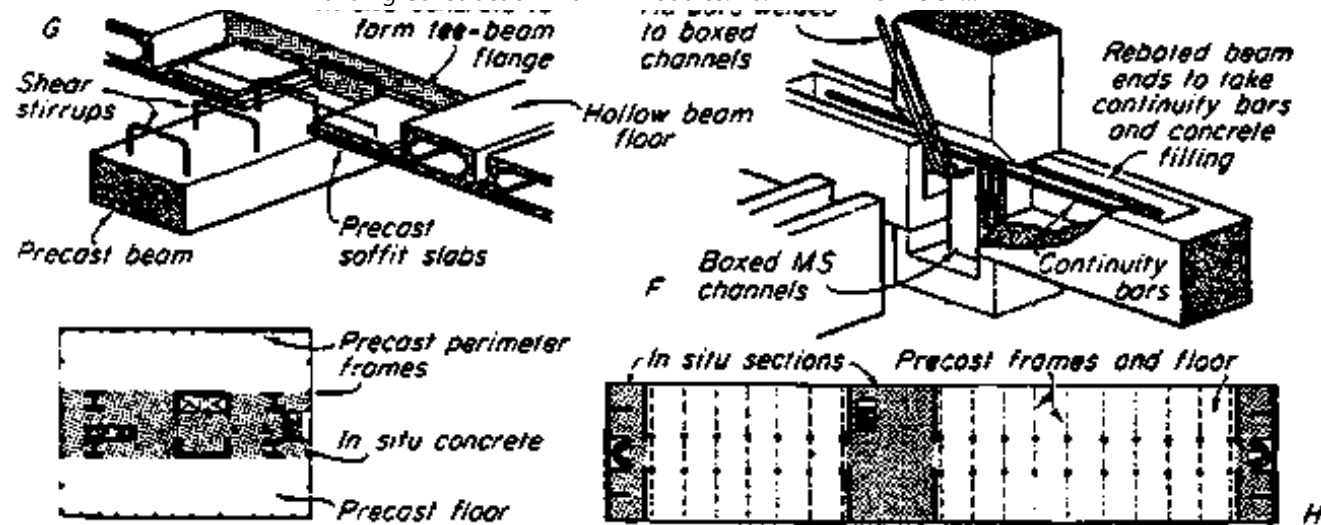

Advantages

1. Mixing, placing and curing of the concrete carried out under factory-controlled conditions which results in uniform and accurate units.

The casting, being an 'off site' activity, will release site space which would have been needed for the storage of cement and aggregates, mixing position, timber store and fabrication area for formwork and the storage, bending and fabrication of the reinforcement.

2. Repetitive standard units reduce costs: it must be appreciated that the moulds used in precast concrete factories are precision made, resulting in high capital costs. These costs must be apportioned over the number of units to be cast.

3. Frames can be assembled on site in cold weather which helps with the planning, programming and progressing of the building operations. This is important to the contractor since delays can result in the monetary penalty clauses, for late completion of the contract, being invoked.

4. In general the frames can be assembled by semi-skilled labour. With the high turnover rate of labour within the building industry, operatives can be recruited and quickly trained to carry out these activities.

within the building industry operatives can be recruited and quickly trained to carry out these activities.

Disadvantages

- 1. System building is less flexible in its design concept than purpose-made structures. It must be noted that there is a wide variety of choice of systems available to the designer, so that most design briefs can be fulfilled without too much modification to the original concept.**
- 2. Mechanical lifting plant will be needed to position the units; this can add to the overall contracting costs since generally larger plant is required for precast concrete structures than for in situ concrete structures.**
- 3. Programming may be restricted by controls on delivery and unloading times laid down by the police. Restrictions on deliveries is a point which must be established at the tender period so that the tender programme can be formulated with a degree of accuracy and any overtime payments can be included in the unit rates for pricing.**
- 4. Structural connections between contractual problems. The major points to present both design and contractual problems. The major points to be considered are protection against weather, fire and corrosion, appearance and the method of construction. The latter should be issued as an instruction to site, setting out in detail the sequence, temporary supports required and full details of the joint.**

10.5.3.1 Methods of Connections

Foundation connections

Precast columns are connected to their foundations by one of two methods, depending mainly upon the magnitude of the load. For light and medium loads the foot of the column can be placed in a pocket left in the foundation. The column can be plumbed and positioned by fixing a collar around its perimeter and

temporarily supporting the column from this collar by using raking adjustable props. Wedges can be used to give added rigidity whilst the column is being grouted into the pocket. The alternative method is to cast or weld on a base plate to the foot of the column and use holding down bolts to secure the column to its foundation in the same manner as described in detail for structural steelwork.

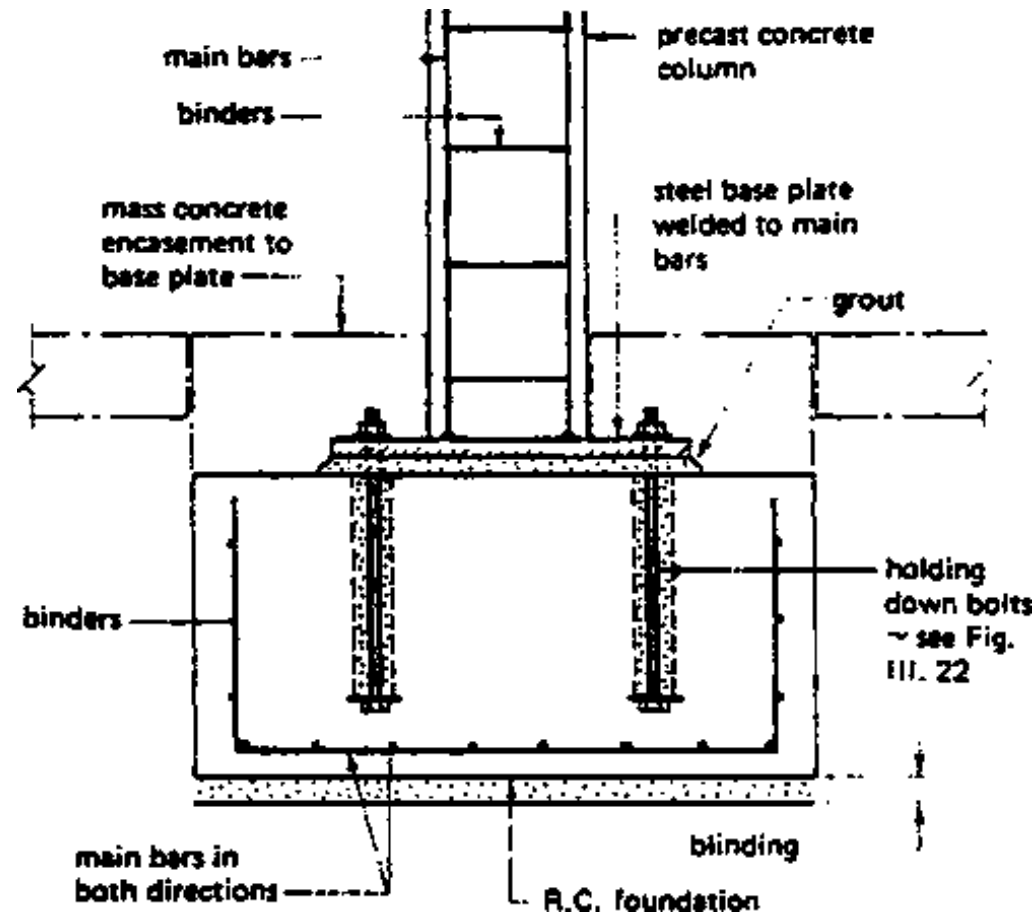

Column connections

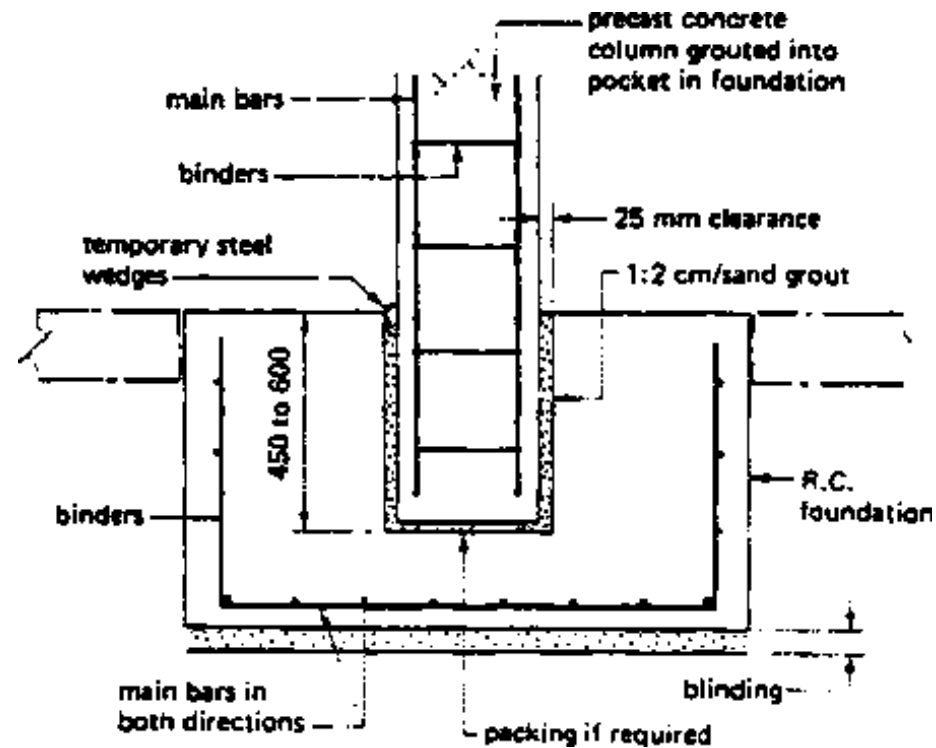

P.C.C. column to foundation connections

The main principle involved in making column connections is to ensure continuity and this can be achieved by a variety of methods. In simple connections a direct bearing and grouted dowel joint can be used, the dowel being positioned in the upper or lower column. Where continuity of reinforcement is required the reinforcement from both upper and lower columns left exposed and either lapped or welded together before completing the connection with in situ concrete. A more complex method is to use a stud and plate connection where one set of threaded bars are connected through a steel plate welded to a set of bars projecting from the lower column; again the connection is completed with in situ concrete. Column connections should be made at floor levels but above the beam connections, a common dimension being 600 mm above structural floor level. The columns can be of single or multi-storey height, the latter having provisions for beam connections at the intermediate floor levels.

Beam connections

As with columns, the main emphasis is on continuity within the joint. Three basic methods are used:

- 1. A projecting concrete haunch is cast on to the column with a locating dowel or stud bolt to fix the beam.**
- 2. A projecting metal corbel is fixed to the column and the beam is bolted to the corbel.**
- 3. Column and beam reinforcement, generally in the form of hooks, are left exposed. The two members are hooked together and covered with in situ concrete to complete the joint.**

With most beam to column connections lateral restraint is provided by leaving projecting reinforcement from the beam sides to bond with the floor slab or precast concrete floor units.

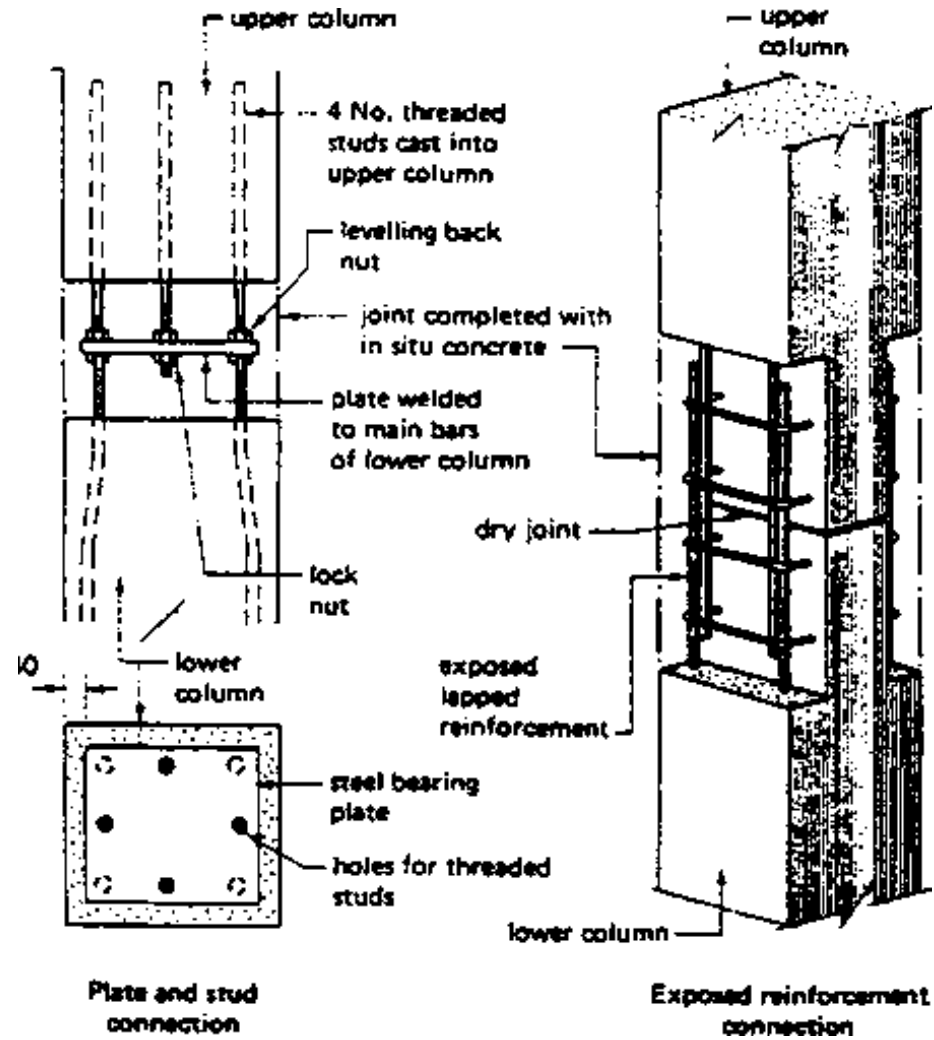

Precast concrete column connections

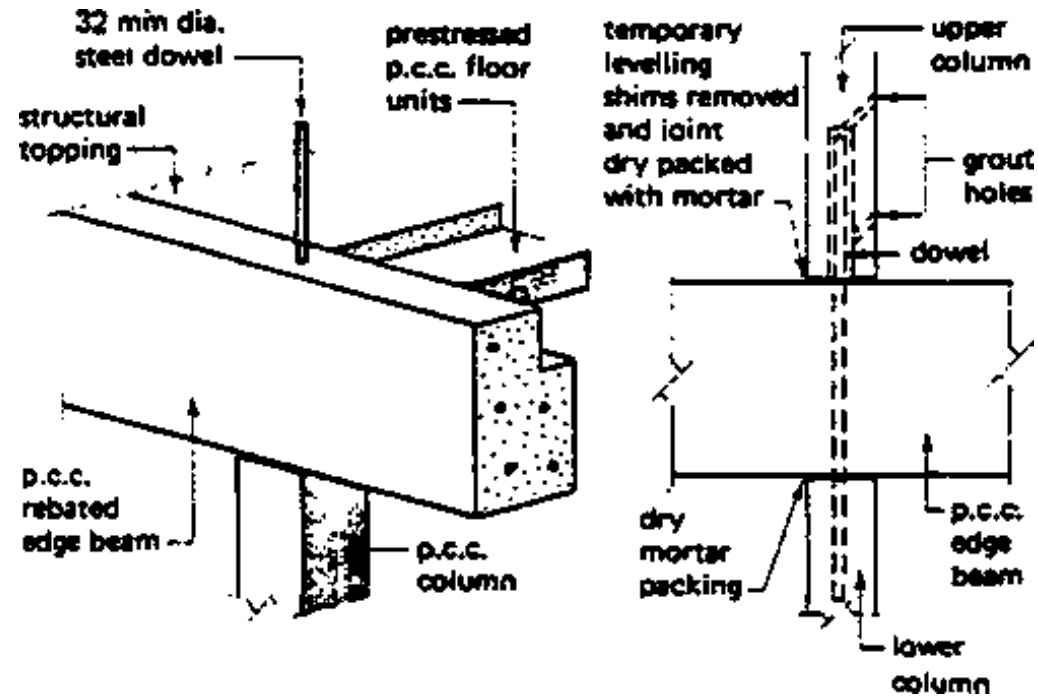

DOWEL correction

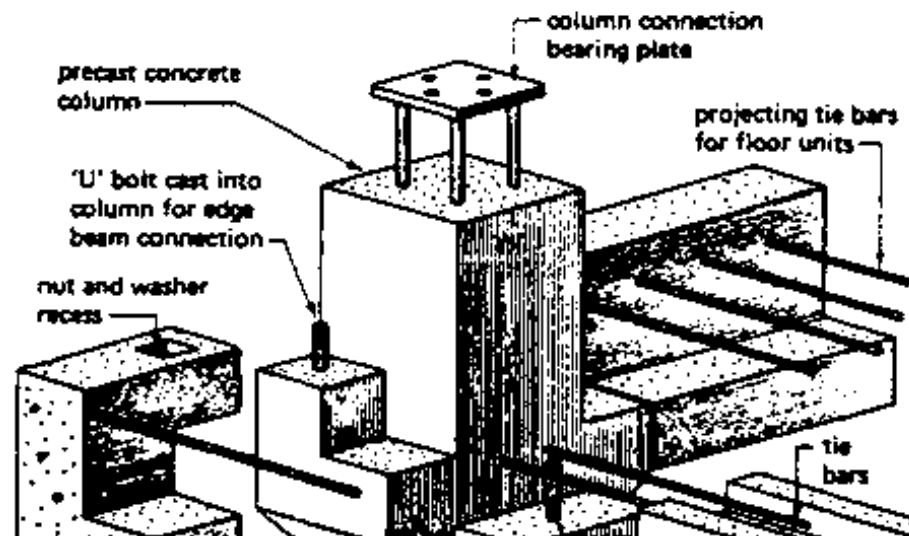

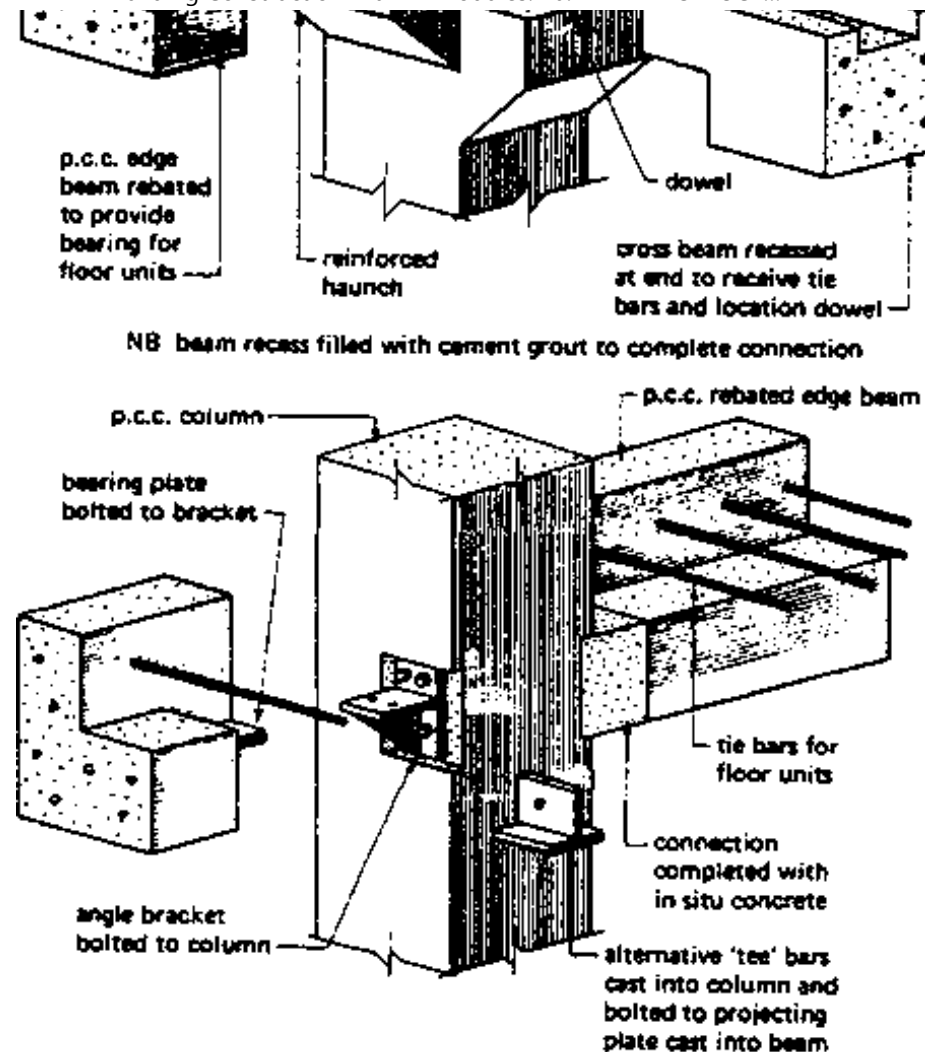

Typical precast concrete beam connections

10.5.4 STRUCTURAL STEELWORK FRAMES

Structural steel as a means of constructing a framed building has been used since the beginning of the twentieth century. Structural steel as well as reinforced 'insitu' and precast concrete are used and this means a comparison must be made before any particular framing medium is chosen. The main factors to be considered in making this choice are:

be considered in making this choice etc.

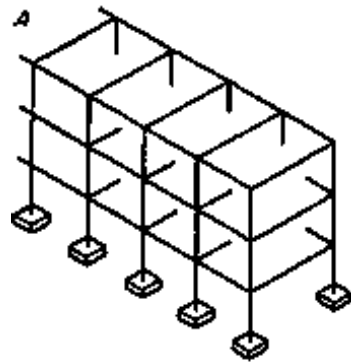

Simple 'cage' frame

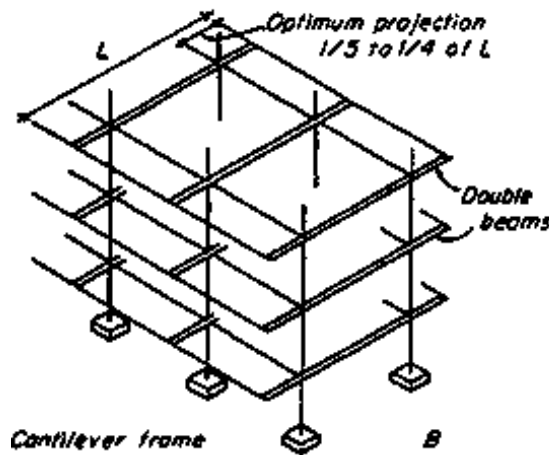

Cantilever frame

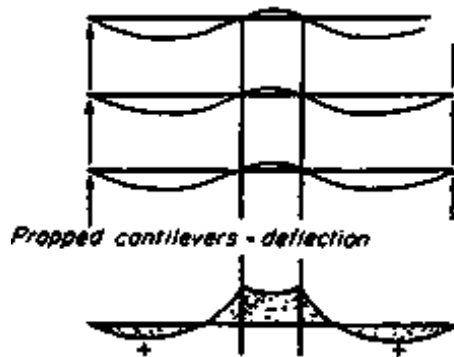

Propped cantilevers - deflection

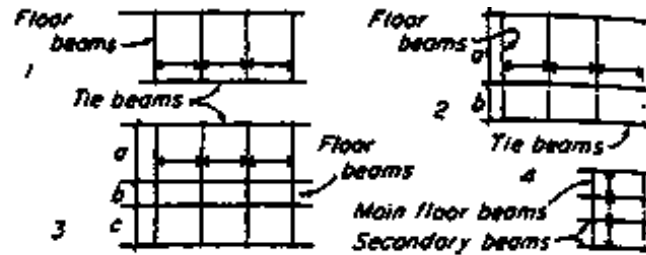

Layout	Member	SPANS	
		Practicable range (m)	Economic range (m)
1	Floor beams	3.65 to 15.25	4.25 to 6.00
	Slab	2.40 to 7.30	3.00 to 4.25
2	Floor beams	3.00 to 15.25 for economy 'a' should not be more than 1 1/5 x 'b'	4.25 to 5.50
	Slab	As for 1 above	
3	Floor beams	a: 3 to 15.25; 4.25 to 5.50 b: 1.8 to 15.25; 2.40 to 3.00 for economy 'b' should be from 1/8 to 2/3 of (a+c)	
	Slab	As for 1 above	
4	If spacing of floor beams is greater than 5.50m secondary beams may be used to keep slab span within the economic limits		

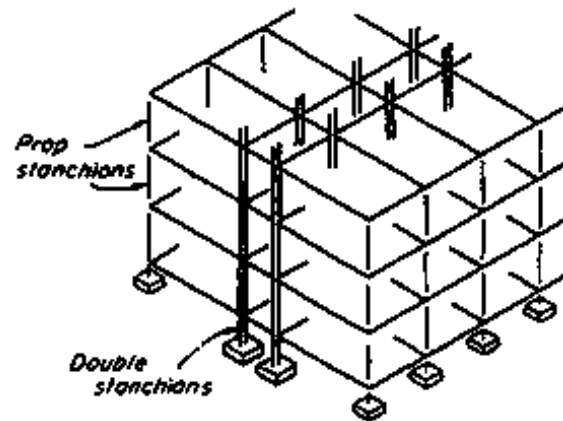

Site costs:

The use of a steel or precast concrete frame will enable the maximum amount of prefabrication off site, during which time the general contractor can be constructing the foundations in preparation for the erection of the frame. To obtain the maximum utilisation of a site the structure needs to be designed so that the maximum amount of floor area is achieved. Generally prefabricated section sizes are smaller than comparable in situ concrete members, due mainly to the greater control over manufacture obtainable under factory conditions and thus these will occupy less floor area.

Maintenance costs:

These can be considered in the short or long term but it is fair to say that in most framed buildings the costs are generally negligible if the design and workmanship is sound. Steelwork, because of its corrosive properties, will need some form of protective treatment but since most steel structures have to be given a degree of fire resistance the fire protective method may well perform the dual function.

Construction costs:

The main factors are design considerations, availability of labour, availability of materials and site conditions. Concrete is a flexible material which allows the designer to be more creative than working within the rigid confines of standard steel sections. However, as the complexity of shape and size increases so does the cost of formwork and for the erection of a steel structure skilled labour is required, whereas activities involved with precast concrete structures can be carried out by the more readily available semi-skilled labour working under the direction of a competent person. The availability of materials fluctuates and only a study of current market trends can give an accurate answer to this problem. Site conditions regarding storage space, fabrication areas and manoeuvrability around and over the site can well influence the framing method chosen.

10 5 4 1 Structural Steel Frames

The design, fabrication, supply and erection of a structural steel frame is normally placed in the hands of a specialist sub-contractor. The main contractor's task is to provide the foundation bases in the correct positions and to the correct levels with the necessary holding down fixing bolts. The designer will calculate the loadings, stresses and reactions in the same manner as for reinforced concrete and then select a standard steel member whose section properties meet the design requirements. Standard steel sections are given in BS 4, Part 1 and in the Handbook on Structural Steelwork published jointly by the British Constructional Steelwork Association Ltd. and the Constructional Steel Research and Development Organisation, which gives the following section types:

Universal beams: These are a range of sections supplied with tapered or parallel flanges and are designated by their serial size x mass in kilograms per metre run. To facilitate the rolling operation of universal beam sections the inner profile is a constant dimension for any given serial size. The serial size is therefore only an approximate width and breadth and is given in millimetres.

Joists: A range of small size beams which have tapered flanges and are useful for lintels and small frames around openings. In the case of joists the serial size is the overall nominal dimension.

Universal columns: These members are rolled with parallel flanges and are designated in the same manner as universal beams. It is possible to design a column section to act as a beam and conversely a beam section to act as a column.

Channels: Rolled with tapered flanges and designated by their nominal overall dimension x mass per metre run and can be used for trimming and bracing members or as a substitute for joist sections.

Angles: Light framing and bracing sections with parallel flanges. The flange or leg lengths can be equal or unequal and the sections are designated by the nominal overall leg lengths x nominal thickness of the flange.

T-bars: Used for the same purposes as angles and are available as rolled sections with a short or long stalk or alternatively they can be cut from a standard universal beam or column section. Designation is given by the nominal overall breadth and depth × mass per metre run.

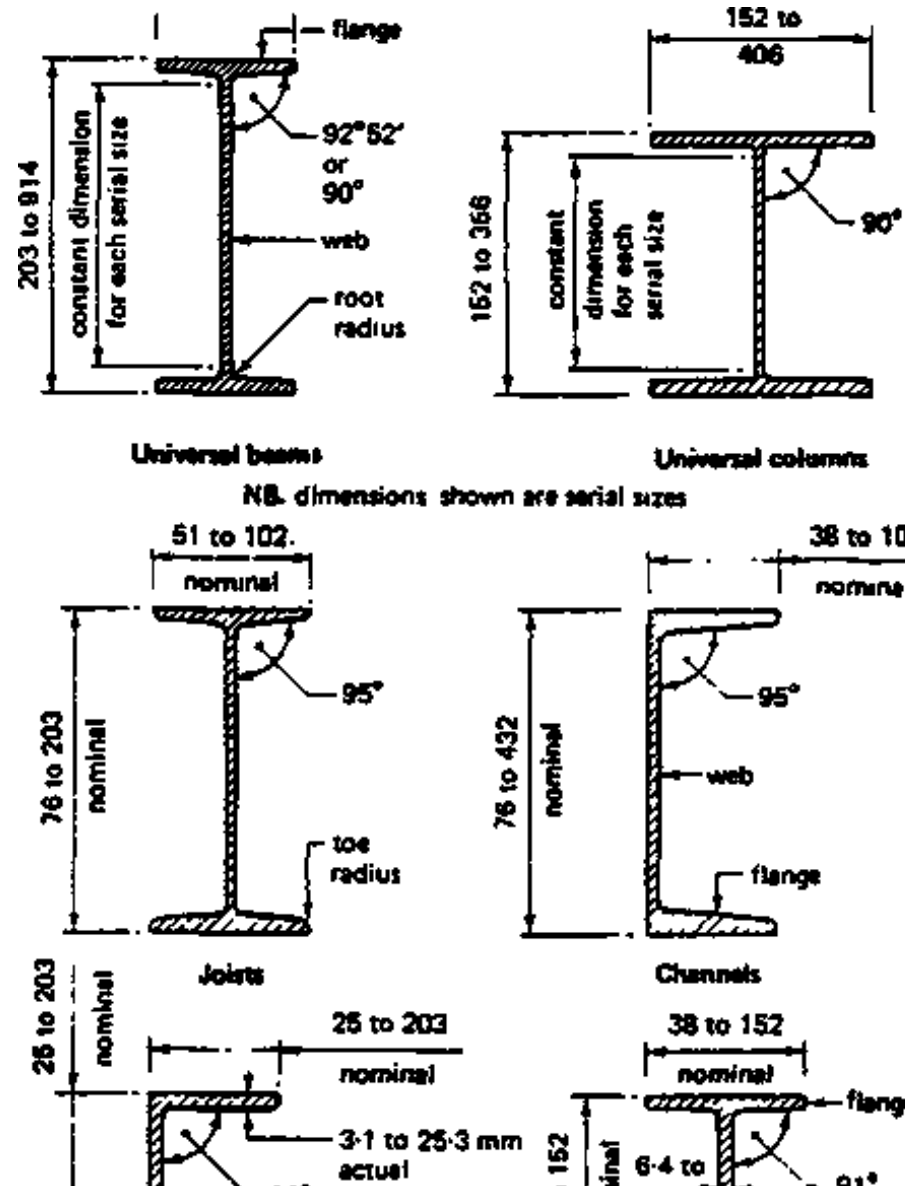

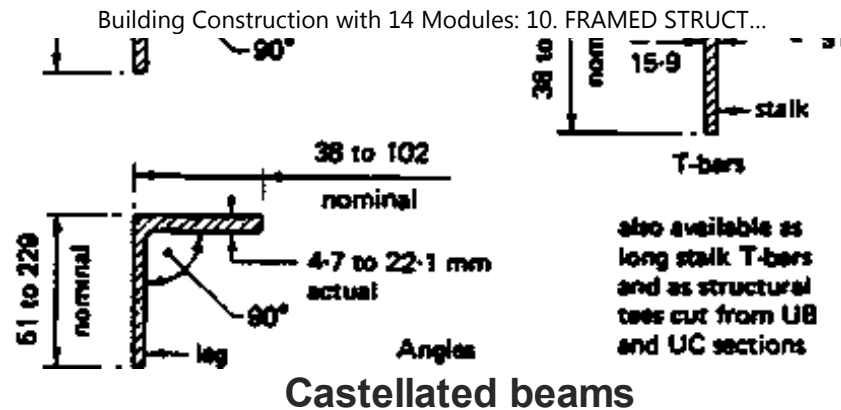

10.5.4.2 Castellated Universal Sections

These are formed by flame cutting a standard universal beam or column section along a castellated line; the two halves so produced are welded together to form an open web beam. The resultant section is one and a half times the depth of the section from which it was cut. This increase in depth gives greater resistance to deflection without adding extra weight but will reduce the clear headroom under the beams unless the overall height of the building is increased. Castellated sections are economical when used to support lightly loaded floor or roof slabs and the voids in the web can be used for housing services. With this form of beam the shear stresses at the supports can be greater than the resistance provided by the web; in these cases one or two voids are filled in by welding into the voids metal blanks.

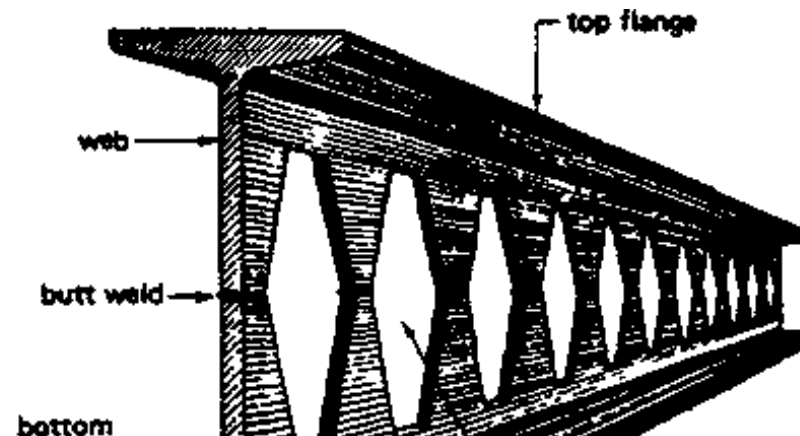

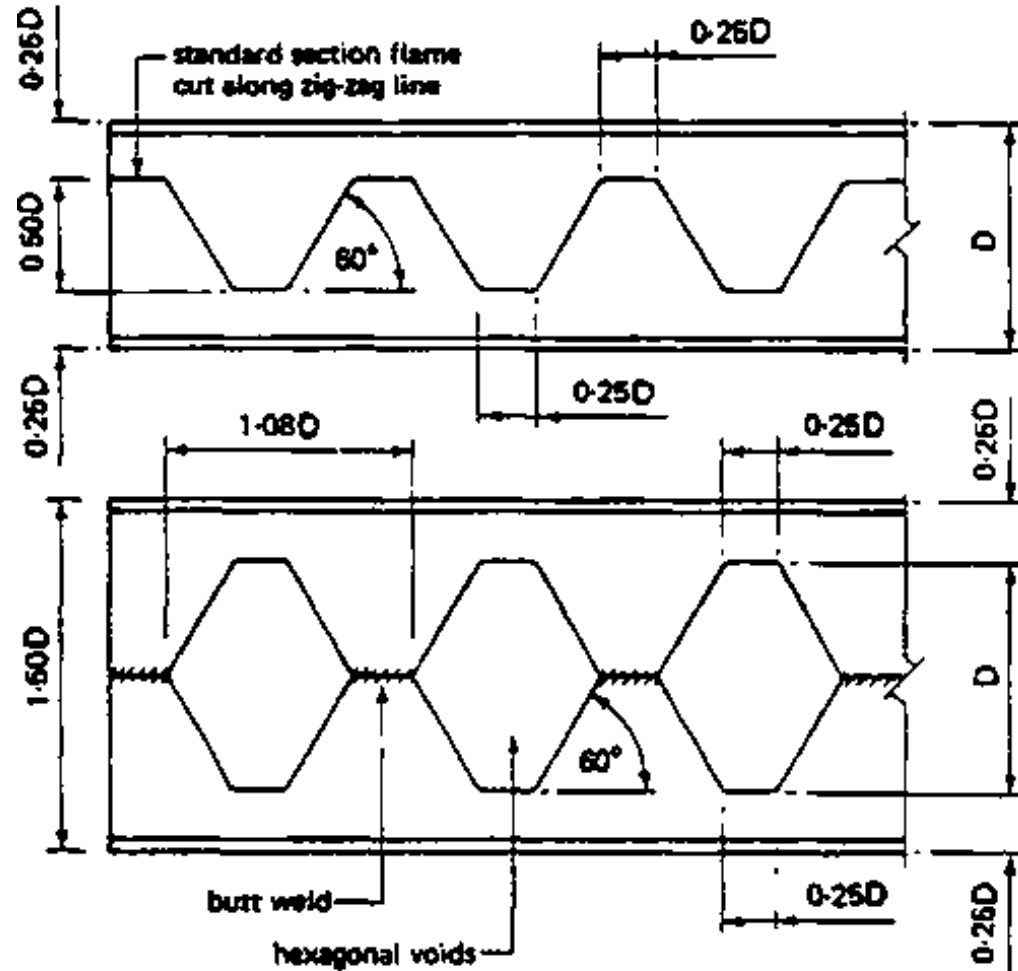

NB castellated joists, universal columns and
zed sections also available

Castellated beams

10.5.4.3 Connections

Connections in structural steelwork are classified as either shop connections or site connections and can be made by using bolts, rivets or by welding.

Bolts

Black bolts: The cheapest form of bolt available, the black bolt can be either hot or cold forged, the thread being machined onto the shank. The allowable shear stresses for this type of bolt are low and therefore they should only be used for end connections of secondary beams or in conjunction with a seating cleat which has been designed and fixed to resist all the shear forces involved. The clearance in the hole for this form of bolt is usually specified as 1.6 mm over the diameter of the bolt. The term black bolts does not necessarily indicate the colour but is the term used to indicate the comparatively wide tolerances to which these products are usually made. BS 4 190 gives recommendations for black bolts and nuts for a diameter range of 5 to 68 mm inclusive.

Bright bolts: These have a machined shank and are therefore of greater dimensional accuracy fitting into a hole with a small clearance allowance. The stresses allowed are similar to those permitted for rivets. Bright bolts are sometimes called turned and fitted bolts. **High strength friction bolts:** Manufactured from high tensile steels and are used in conjunction with high tensile steel nuts and tempered washers. These bolts have generally replaced rivets and black bolts for both shop and site connections since fewer bolts are needed and hence the connection size is reduced. The object of this form of bolt is to tighten it to a predetermined shank tension in order that the clamping force thus provided will transfer the loads in the connecting members by friction between the parts and not by shear in or bearing on the bolts. Generally a torque controlled spanner or pneumatic impact wrench is used for tightening; other variations to ensure the correct torque are visual indicators such as a series of Dips under the head or washer which are flattened when the correct amount of shank tension has been reached. Nominal standard diameters available are from 12 to 36 mm with lengths ranging from 40 to 500mm, as recommended in BS 4395.

The holes to receive bolts should always be drilled in a position known as the back mark of the section.

The back mark is the position on the flange where the removal of material to form a bolt or rivet hole will have the least effect upon the section properties. Actual dimensions and recommended bolt diameters are given in the Handbook on Structural Steelwork.

Rivets:

Made from mild steel to the recommendations of BS 4620 rivets have been generally superseded by bolted and welded connections for structural steel frames. Rivets are available as either cold or hot forged with a variety of head shapes ranging from an almost semi-circular or snap head to a countersunk head for use when the projection of a snap, universal or flat head would create an obstruction. Small diameter rivets can be cold driven but the usual practice is to drive rivets whilst they are hot. Rivets, like bolts, should be positioned on the back mark of the section; typical spacings are 2 1/2 diameters centre to centre and 1 3/4 diameters from the end or edge to the centre line of the first rivet.

Welding:

Primarily considered as a shop connection since the cost together with the need for inspection, which can be difficult on site, Generally makes this method uneconomic for site connections. The basic methods of welding are oxy-acetylene and electric arc. A blowpipe is used for oxy-acetylene which allows the heat from the burning gas mixture to raise the temperature of the surfaces to be joined. A metal filler rod is held in the flame and the molten metal from the filler rod fuses the surfaces together. In the alternative method an electric arc is struck between a metal rod connected to a suitable low voltage electrical supply and the surface to be joined which must be earthed or resting on an earthed surface. The heat of the arc causes the electrode or metal rod to melt and the molten metal can be deposited in layers to fuse the pieces to be joined together.

With electrical arc welding the temperature rise is confined to the local area being welded whereas oxy-acetylene causes a rise in metal temperature over a general area.

Welds are classified as either fillet or butt welds. Fillet welds are used to the edges and ends of members and forms a triangular fillet of welding material. Butt welds are used on chamfered end to end connections.

10.5.4.4 Structural Steel Connections

Base connections:

Are of one or two forms, the slab or bloom base and the gusset base. In both methods a steel base plate is required to spread the load of the column on to the foundation. The end of the column and the upper surface of the base plate should be machined to give a good interface contact when using a bloom base. The base plate and column can be connected together by using cleats or by fillet welding.

The gusset base is composed of a number of members which reduce the thickness of the base plate and can be used to transmit a high bending moment to the foundations. A machined interface between column and base plate will enable all the components to work in conjunction with one another, but if this method is not adopted the connections must transmit all the load to the base plate. The base is joined to the foundation by holding down bolts which must be designed to resist the uplift and tendency of the column to overturn. The bolt diameter, bolt length and size of plate washer are therefore important. To allow for fixing tolerances the bolts are initially housed in a void or pocket which is filled with grout at the same time as the base is grouted on to the foundation. To level and plumb the columns steel wedges are inserted between the underside of the base plate and the top of the foundation.

Beam to column connections:

These can be designed as simple connections where the whole of the load is transmitted to the column

through a seating cleat. This is an expensive method requiring heavy sections to overcome deflection problems. The usual method employed is the semi-rigid connection where the load is transmitted from the beam to the column by means of top cleats and/or web cleats; V OR ease of assembly an erection cleat on the underside is also included in the connection detail. A fully rigid connection detail, which gives the greatest economy on section sizes, is made by welding the beam to the column. The uppermost beam connection to the column can be made by the methods described above or alternatively a bearing connection can be used, which consists of a cap plate fixed to the top of the column to which the beams can be fixed either continuously over the cap plate or with a butt joint.

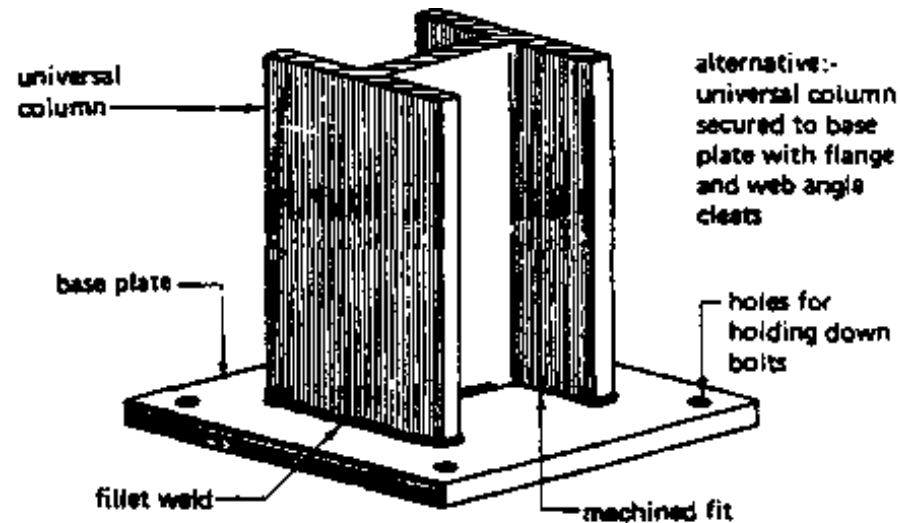

Slab or bloom base

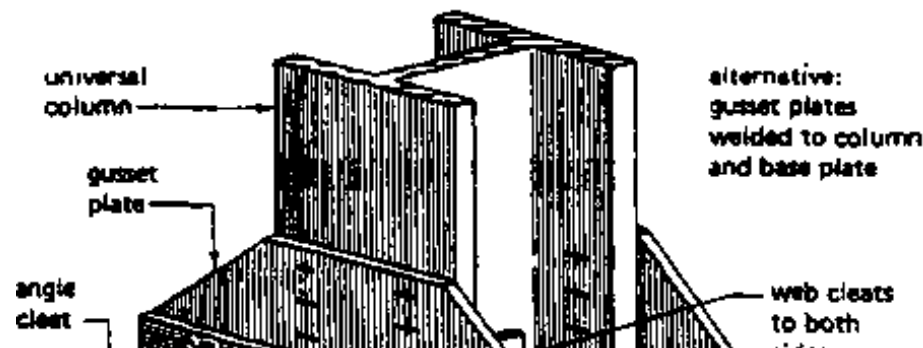

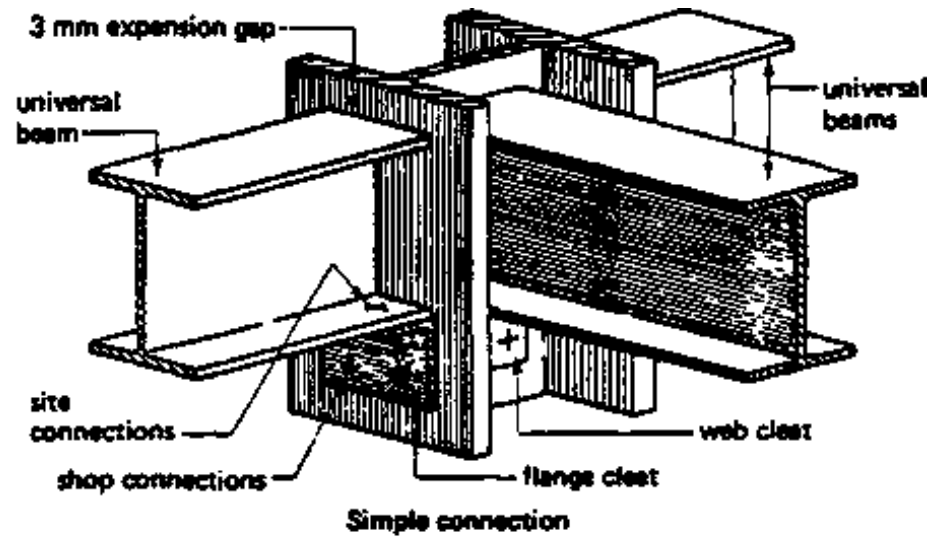
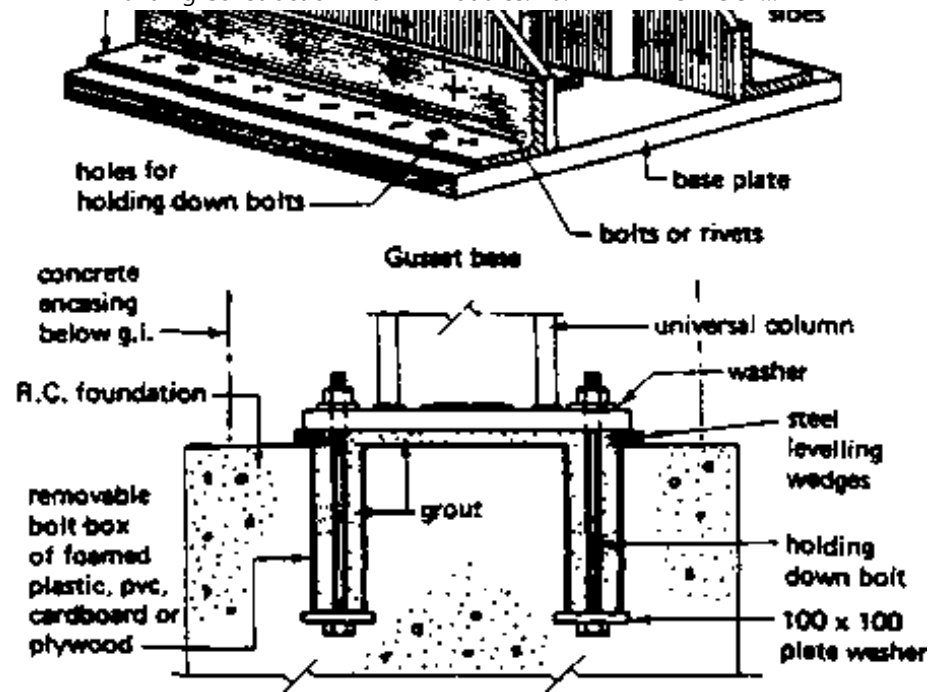

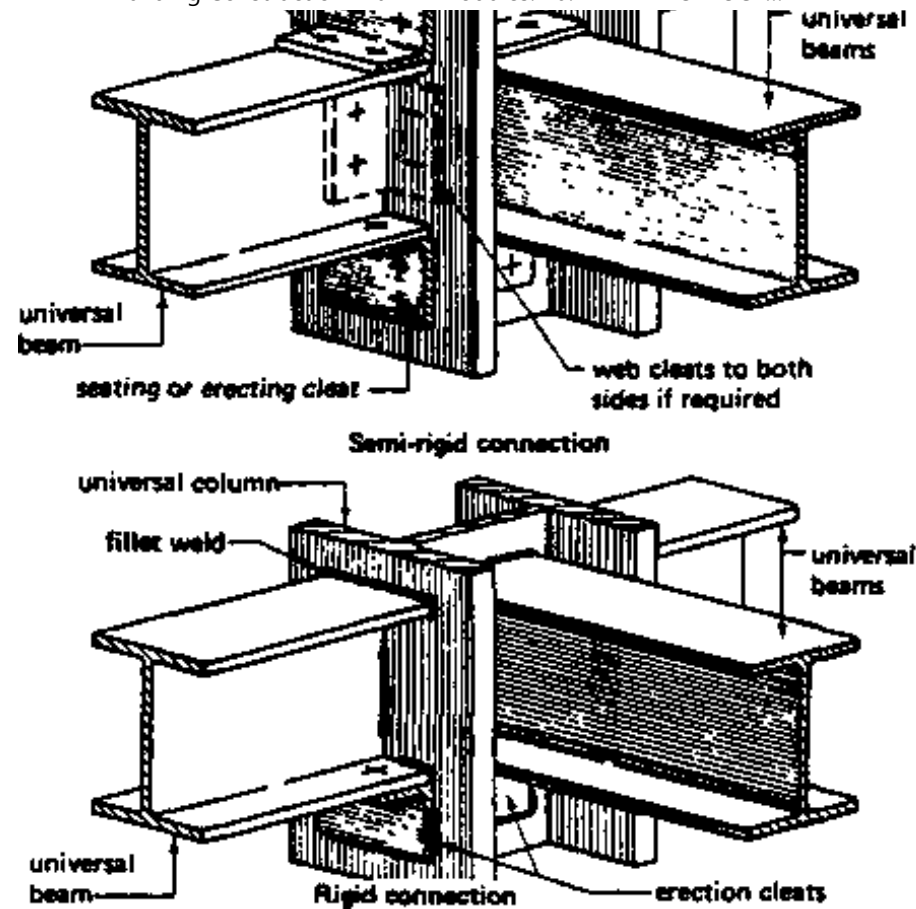

Column splices: These are made at floor levels but above the beam connections. The method used will depend upon the relative column sections.

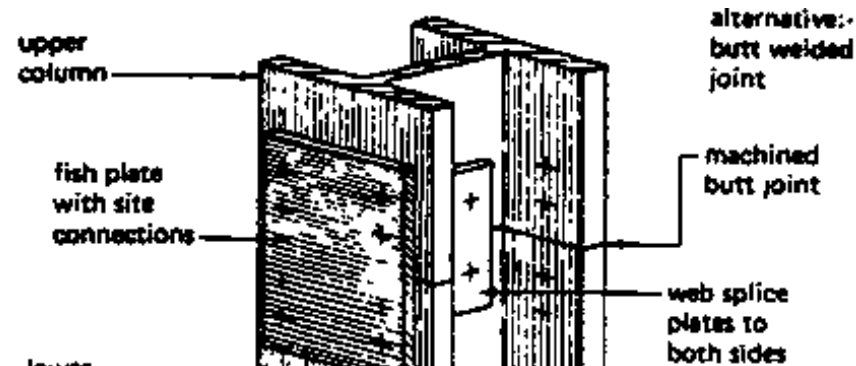



Columns with equal sections

NB for columns of same serial size but of different sections splice is made using 4 No. fish plates fixed on the inside of flanges

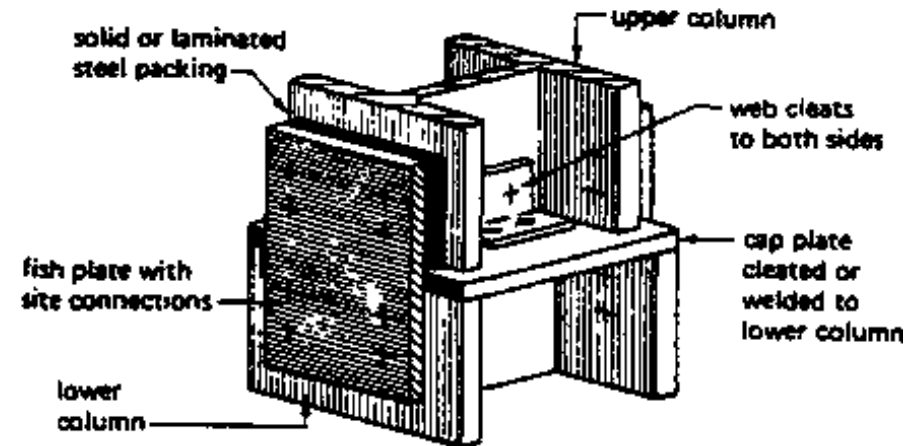

Alternative methods for columns of unequal sec

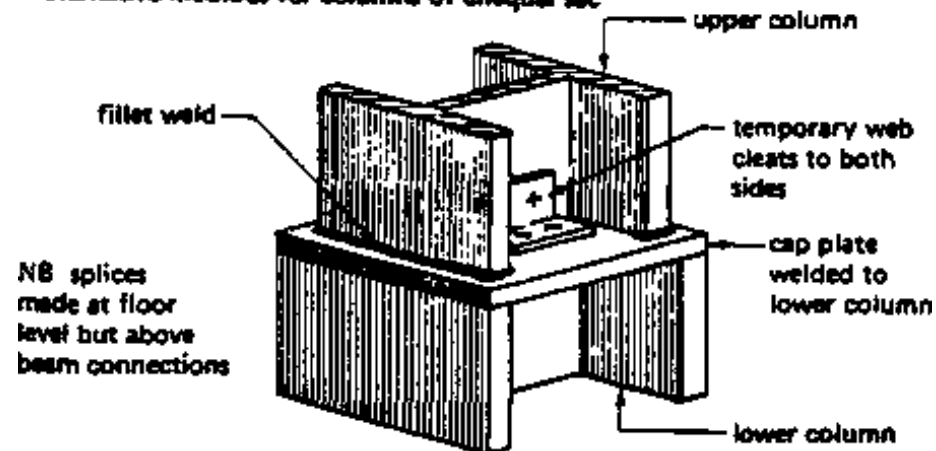

NB splices made at floor level but above beam connections

Beam to beam connections: The method used will depend upon the relative depths of the beams concerned. Deep beams receiving small secondary beams can have a shelf angle connection whereas other depths will need to be connected by web cleats.

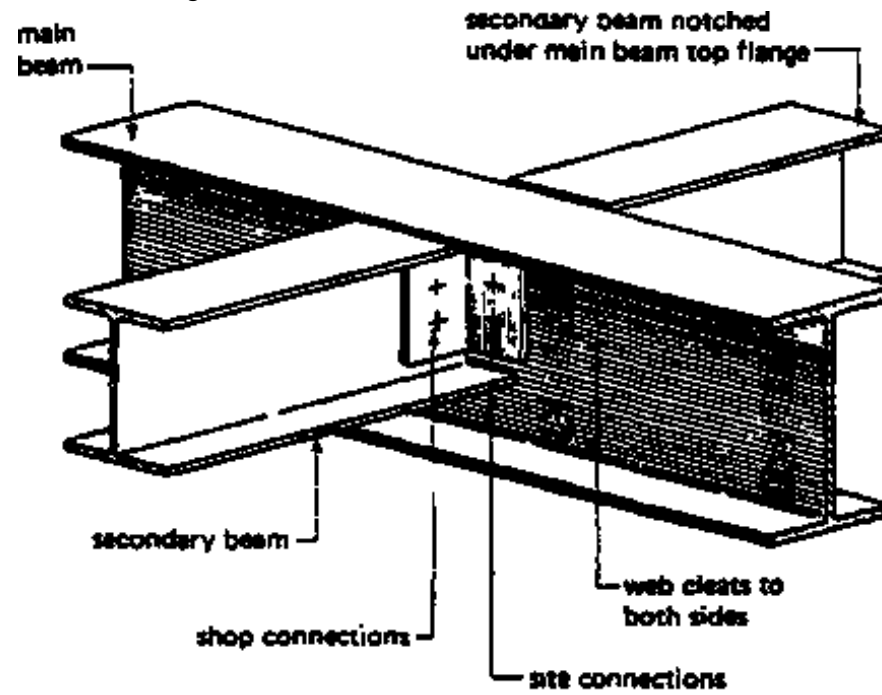

Beam to beam connections

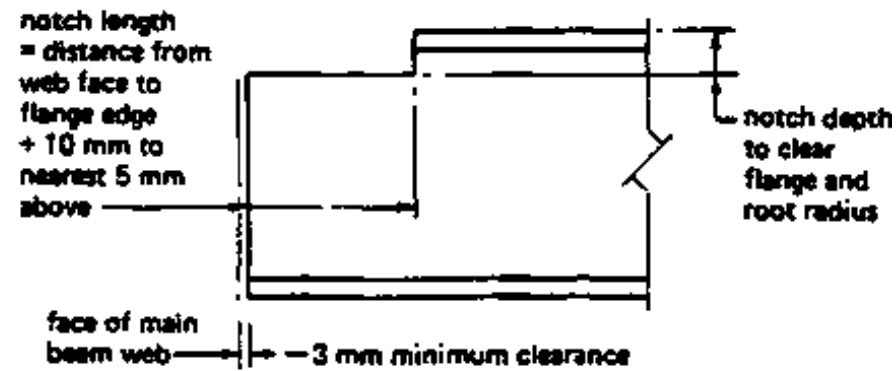

Notch detail

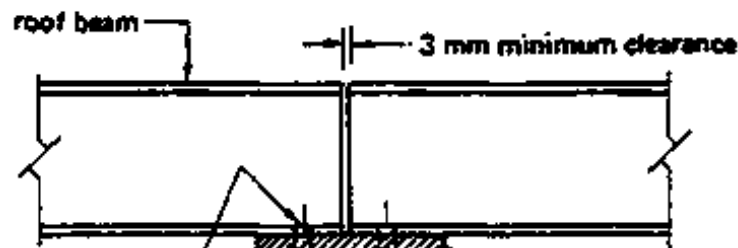

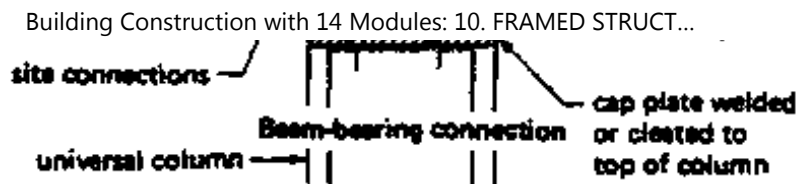

10.5.4.5 Frame Erection

This operation will not normally be commenced until all the bases have been cast and checked since the structural steelwork contractor will need a clear site for manoeuvring the steel members into position. The usual procedure is to erect two storeys of steelwork before final plumbing and levelling takes place.

The grouting of the base plates and holding down bolts is usually left until the whole structure has been finally levelled and plumbed. The grout is a neat cement or cement/sand mixture depending on the cap to be filled:

- 12 to 25 mm gap - stiff mix of neat cement;
- 25 to 50 mm gap - fluid mix of 1:2 cement/sand and tamped;
- over 50 mm gap - stiff mix of 1:2 cement/sand and rammed.

With large base plates a grouting hole is sometimes included but with smaller plates three sides of the base plate are sealed with puddle clay, bricks or formwork and the grout introduced through the open edge on the fourth side. To protect the base from corrosion it should be encased with concrete up to the underside of the floor level giving a minimum concrete cover of 75mm to all the steel components.

10.5.4.6 Fire Protection of Steelwork

Part E of building regulations together with Schedule 8 gives the minimum fire resistance periods and methods of protection for steel structures according to the purpose group of the building and the function of the member. The traditional method is to encase the steel section with concrete, which

requires formwork and adds to the loading of the structure. Many 'dry' techniques are available but not all are suitable for exposed conditions.

10.5.5 TIMBER FRAMES

Skeleton frames constructed in timber may be fabricated from solid timber sections, built-up sections or glued and laminated sections.

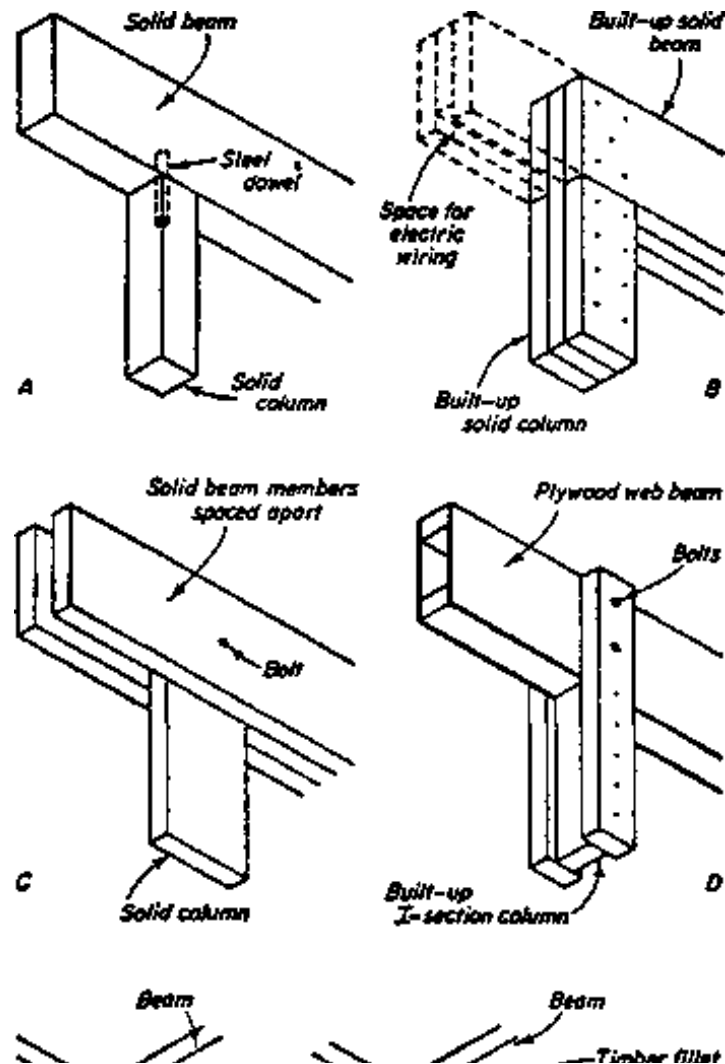

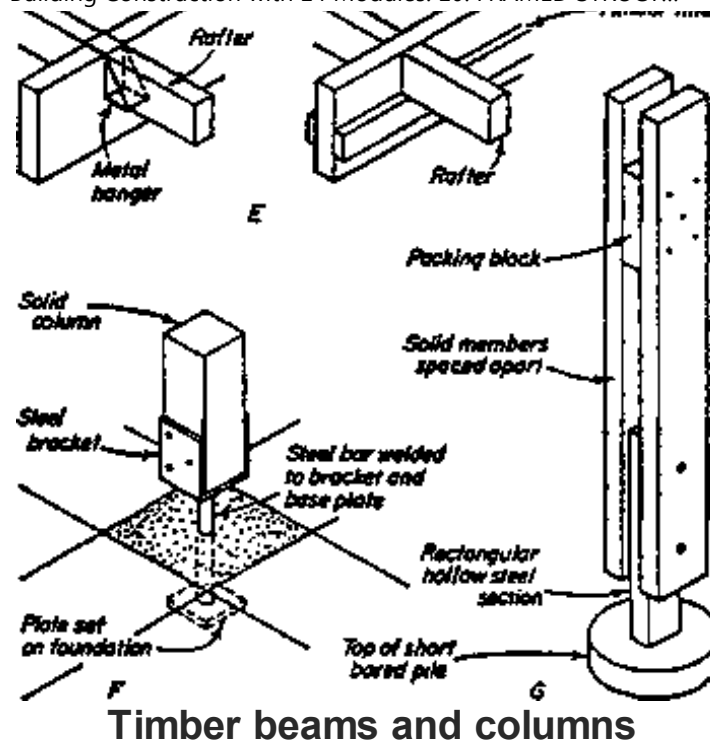

10.5.5.1 Columns and Beams

Solid square or rectangular sections are generally the most economical in cost, but where members beyond the available sizes and lengths of solid timber are required it is necessary to form them by combining a number of smaller sections of timber. This may be accomplished by nailing or bolting together several pieces to form built-up solid sections. Apart from obtaining the required sizes for large members there are advantages in building up solid sections from smaller pieces since these are easier to obtain and to season properly without checking and they may be built-up in ways that minimise warping and permit rigid connections between columns and beams.

In the case of built-up column sections involving butt joints in the length it is essential that the abutting faces be carefully machined and the joints staggered. Built-up box and I-sections used as columns are stiffer than a solid section for an equal timber content and are particularly suitable for tall columns.

stiffer than a solid section for a given timber content and are particularly suitable for tall columns. Another method of increasing the stiffness of lightly loaded columns is to provide the bearing area in two parallel members spaced apart by packing blocks at intervals and connected by nails, bolts or glue. Built-up solid beams are normally built up of vertical pieces nailed or bolted together, nailing being satisfactory for beams up to about 250mm in depth, although these may require the use of bolts at the ends if shear stresses are high. Where the imposed loading is light beams may be built up with solid flanges and plywood webs nailed or glued, or glued and nailed, together. Such web beams, compared with solid beams, are very stiff relative to the amount of timber in them, especially those with two webs forming a box section and result in low dead/live load ratios. The thin webs necessitate stiffeners at intervals along the length of the beam. Increased shear resistance near the supports may be obtained by closer spacing of the stiffeners at the ends of the beam. The fire resistance of web beams such as these is very much lower than that of solid or glued and laminated timber beams by reason of the thinness of the parts. If exposed to the weather the surface veneer of the plywood webs of this type of beam tends to check. Glued and laminated sections, commonly called glulam sections, consist of timber laminations glued together to form square or rectangular sections and, for large span beams, I-sections. They are more expensive than solid or built-up sections but permit the use of higher permissible stresses in their design and are, therefore, suitable where loads are great or spans are large.

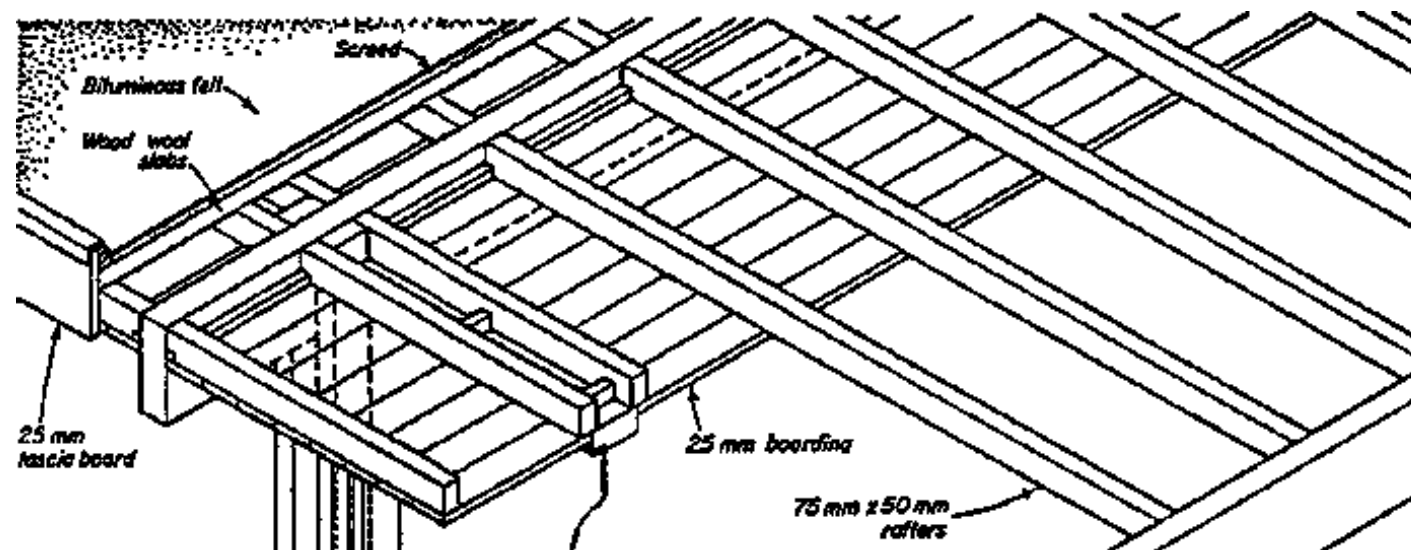

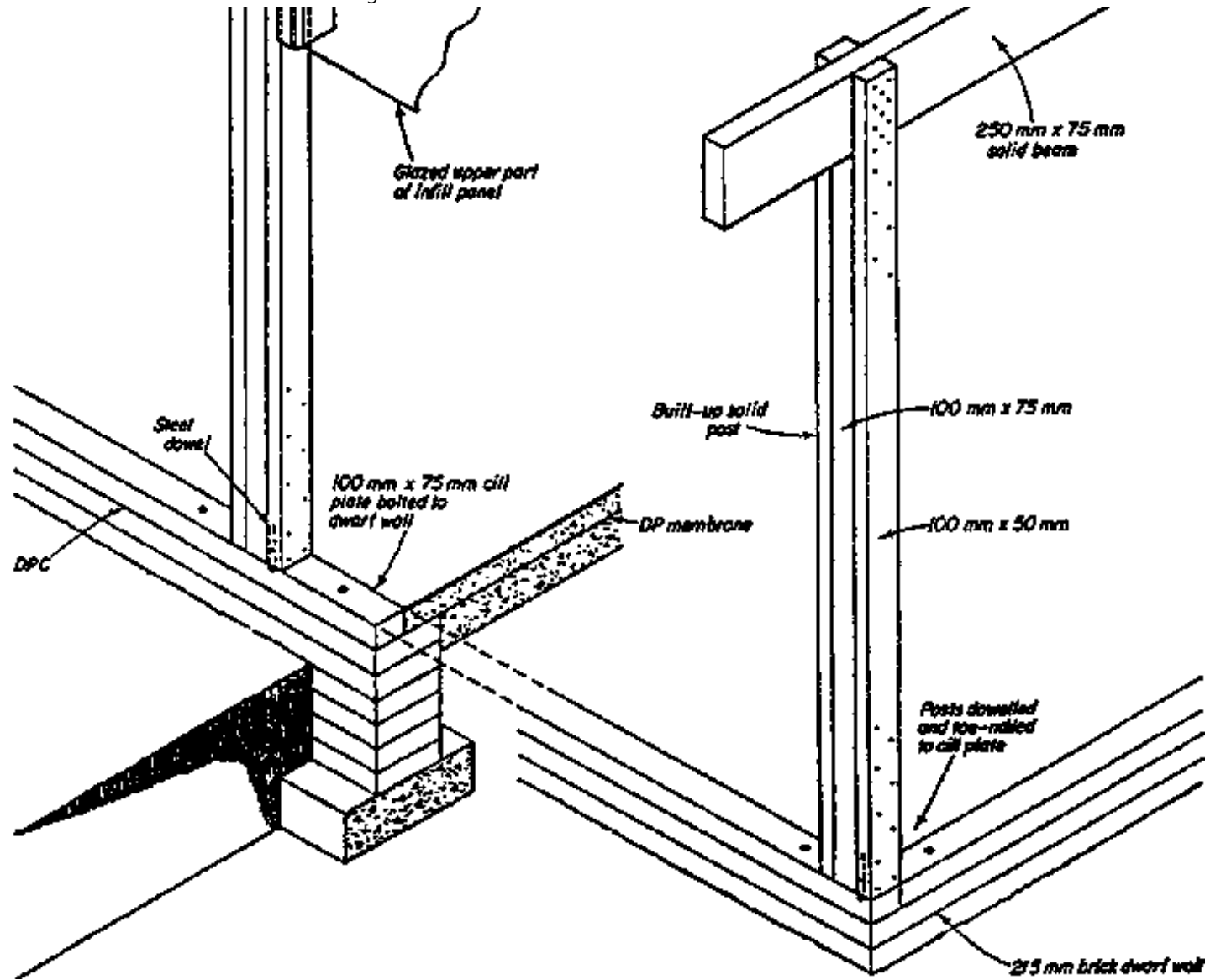

Timber frame with built-up solid posts and solid beams



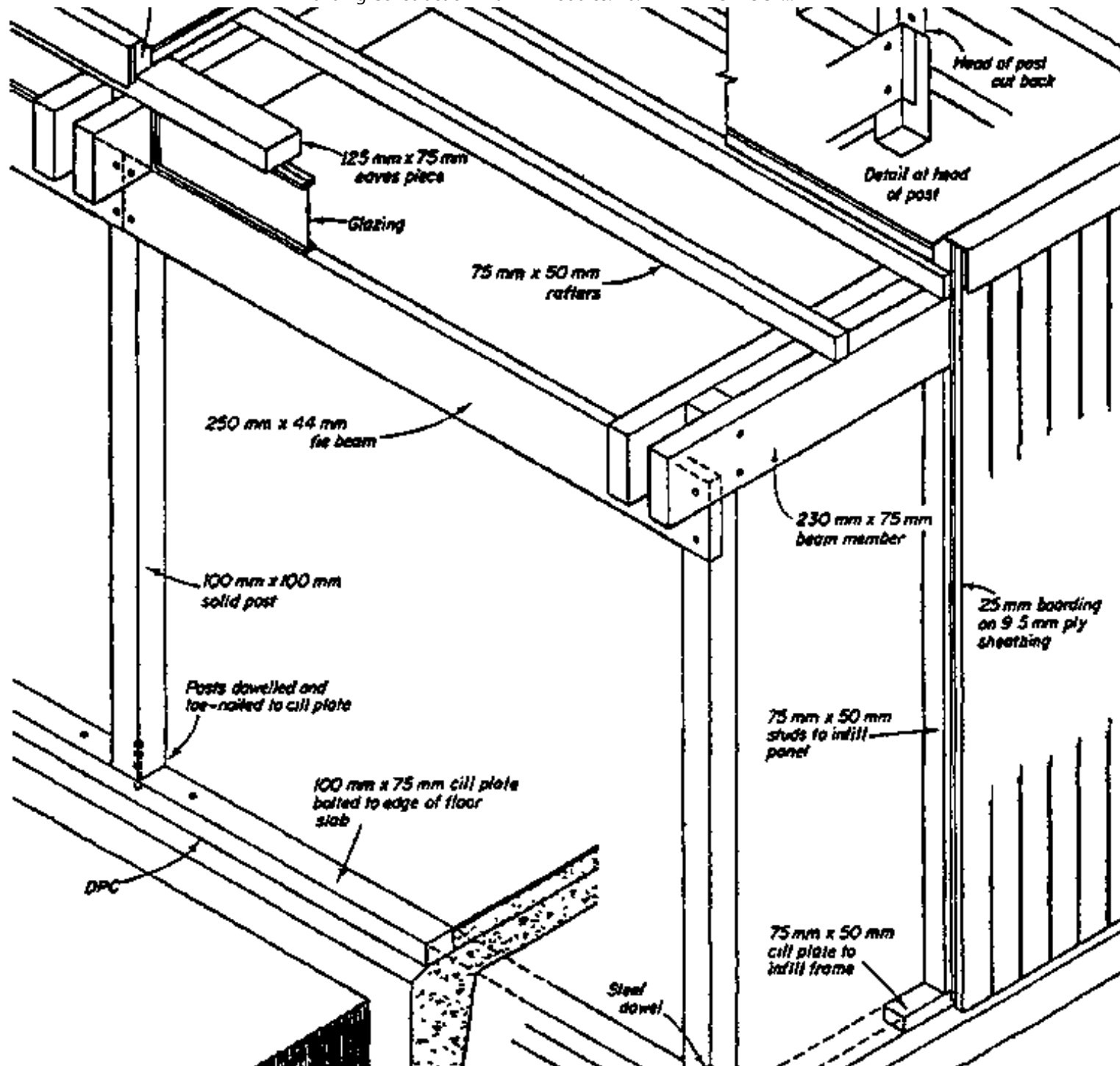

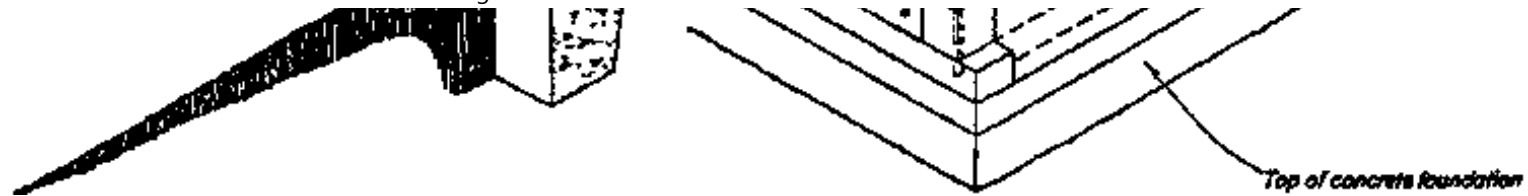

Timber frame with solid posts and spaced solid beams

10.5.5.2 Connections

Connections between beams and columns are made with nails, bolts, dowels and cleats according to the type of members.

Those between solid and glulam beams and columns are made by metal dowels with or without side fixing plates, the latter providing a stiffer connection, or simply by side-nailing the beam to the column. Built-up members are connected by nails, bolts or bolts and timber connectors. Built-up solid sections or spaced solid members permit rigid connections to be made by passing one member, or part of it, through the other.

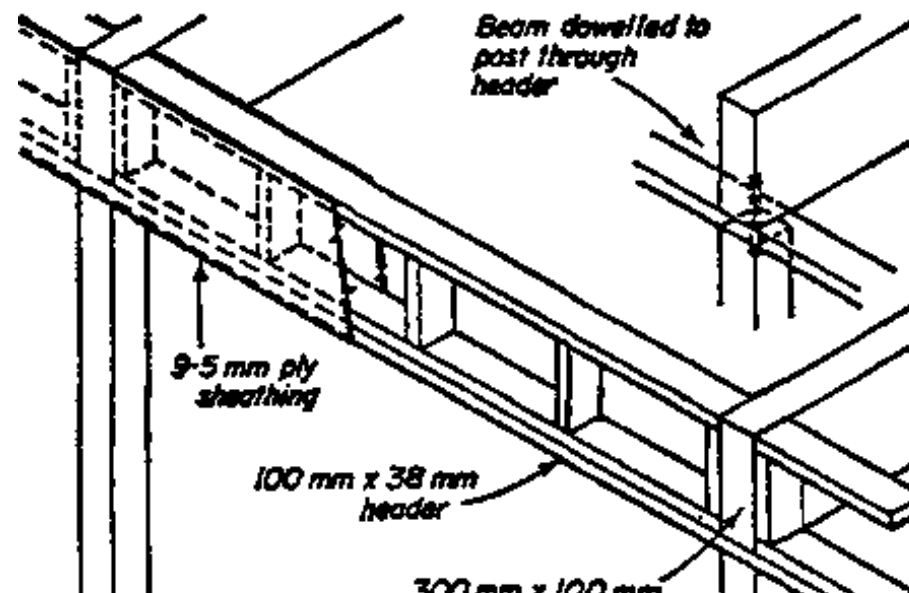

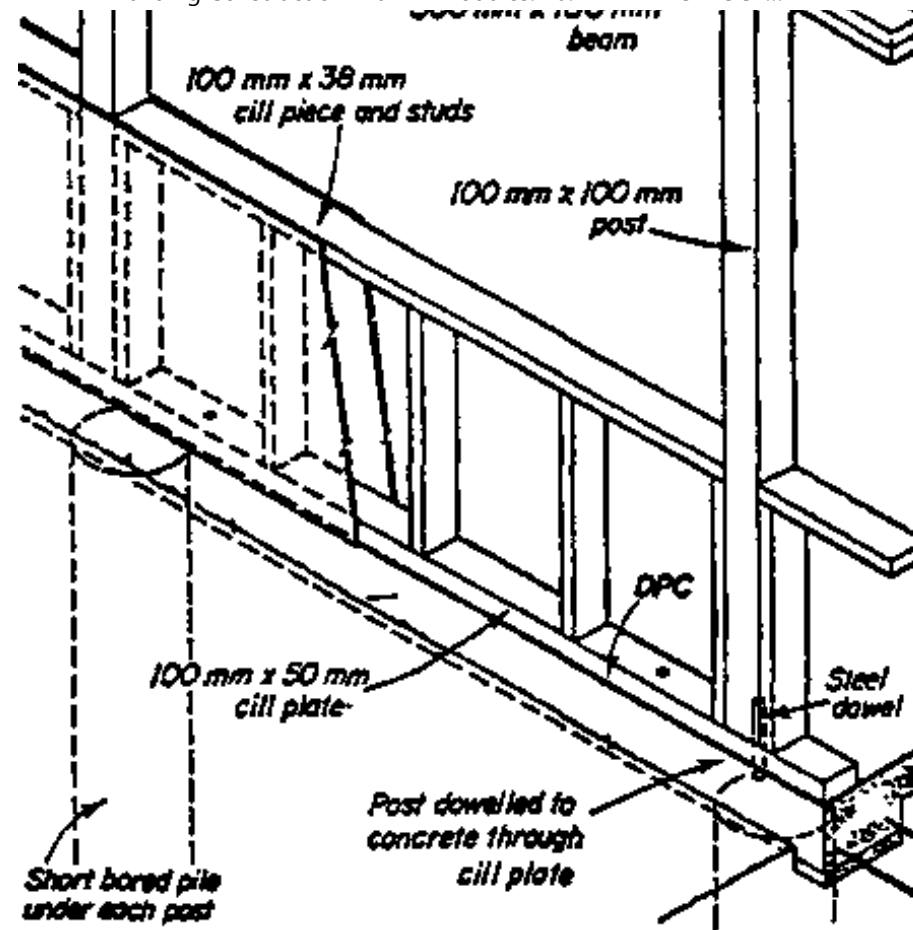

Timber frame with solid posts and beams

Spaced beams permit the use of smaller sections than would be required for a single solid member. The solid built-up beam, however, has the advantage that one piece restrains the warping of the others. Beam to beam connections are made by means of metal hangers or by metal cleats bolted or screwed to the beams, Rafters and joists may be supported by hangers or timber fillets.

Column base connections are made in various ways depending on the relation of the column to the remainder of the building fabric. Free standing external columns normally are raised of the ground to isolate them from ground moisture. This may be done by means of a concrete stool or block with a damp-proof layer between the timber and concrete. the column being fixed in position by a steel dowel

~~slump proof layer between the timber and concrete, the column being fixed in position by a steel dowel.~~
or by straps and bolts. Alternatives to this which isolate the timber from the ground and also fix the column in position are shown in the figure. These three methods also hold the post against wind uplift,

the effect of which can be considerable when the roof is flat and the structure is light. External perimeter columns normally bear on a continuous timber cill plate which is bolted to the concrete floor slab or perimeter dwarf wall and which also carries the infilling wall panels. If the loading on the column and the nature of the soil necessitates it a small pier and foundation slab or a short bored pile must be constructed under the column position. Internal columns usually bear directly on the floor slab, thickened to form a base if necessary, and are secured in position by a metal dowel.

10.5.5.3 Building frames in timber

Most small-scale timber framed structures take the form of post and beam construction in which resistance to racking distortion of the frame under working load is provided by the infill panels. A proportion of solid or near-solid wall panels is, therefore, necessary to ensure stability and can normally be provided. The choice of connection and form of junction between the members of the frame in most cases thus depends largely on the degree of rigidity required for erection purposes before the panels are fixed.

The figure shows post and beam frames constructed with built-up solid posts and single solid beams, the latter passing between the outer column pieces, to which they are secured by nailing, and bearing on the centre piece. The foot of each post bears on the timber cill plate bolted to the dwarf wall as for frame wall construction. Bearings for the rafters are provided by fillets nailed to the beam sides. The roof extends beyond the wall panels the heads of which are secured to noggings between two closely spaced rafters.

The frames are constructed with solid posts and spaced solid beams. The latter bear on shoulders formed at the head of the posts and are secured by two bolts to produce a rigid connection. In this

example some lateral rigidity results from the provision of a deep tie beam immediately below the bearings of the main beams, this also being set into the face of the posts and bolted to them. This tie, together with the substantial member fixed to the paired beams above the glazing and some solid panels under some windows in the wall panels, would provide lateral rigidity to the structure.

Since a dowelled connection does not produce a rigid post to beam junction rigidity must be provided by wall panels parallel to the beams. The header running over the tops of the posts provides some rigidity to the frames during erection and ultimate structural rigidity is provided by the top and bottom solid panels forming an opening for glazing. In this example the foundations are short bored piles placed under each post.

The figure shows a double height house frame with the single floor raised above ground level.

The posts are solid and the main bearing beams and lateral tie beams are formed as spaced beams with pairs of deep but relatively thin solid members. The depth of the junction between posts and beams and the use of three bolts at each connection produces stiff joints and rigidity in both directions. Packing blocks at the ends and centre of all beams provides the necessary stiffening against lateral buckling of the thin members. Further stiffening of the frame would be provided by enclosing one of the ground level bays on all four sides with solid panels.

The floor and roof consist of boarded timber joists and rafters made up into prefabricated panels bearing on top of the beams. Prefabricated wall panels are secured to the edges of roof and floor.

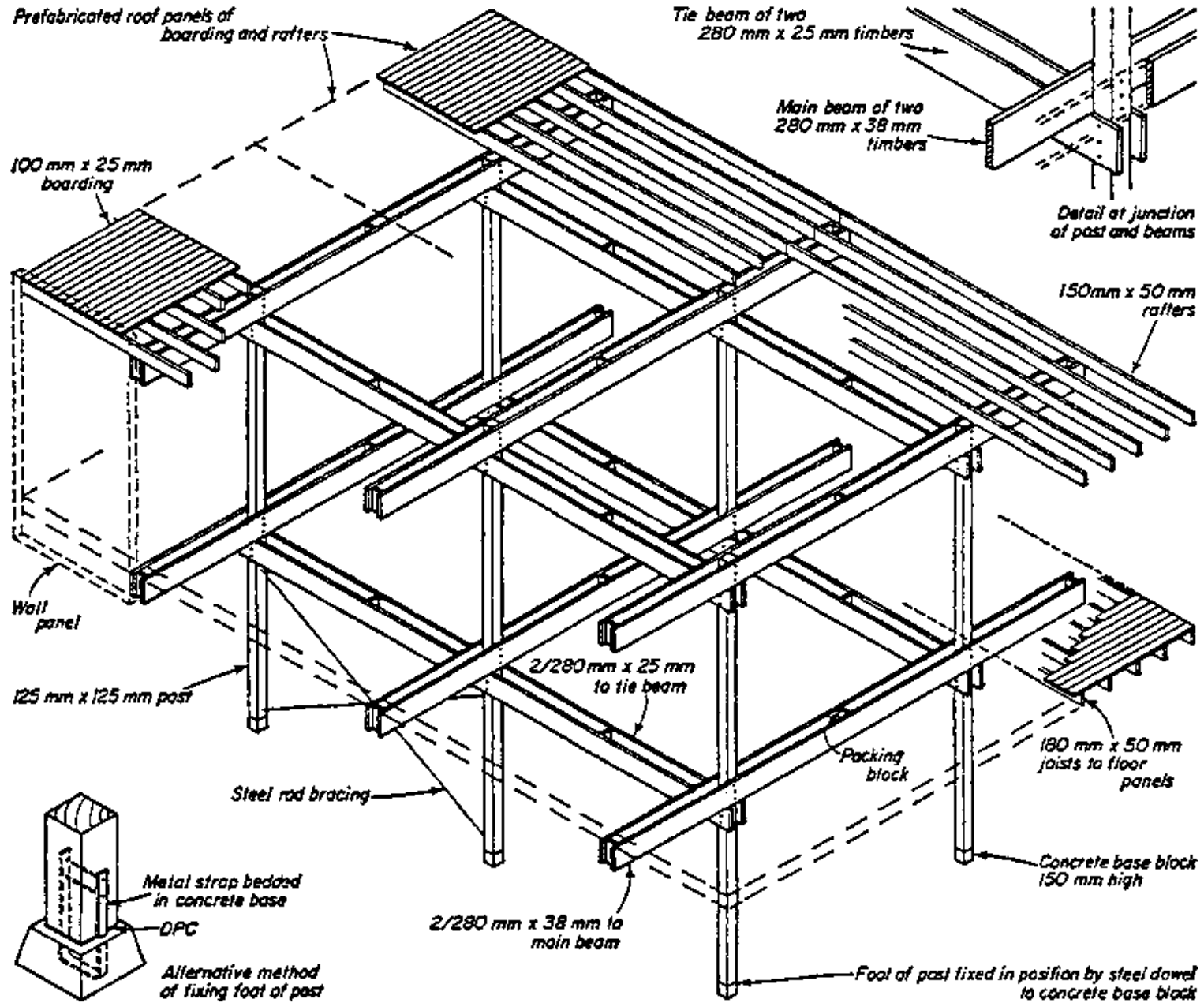

Two-storey timber frame

10.5.5.4 Prefabrication

The design of the last structure and its panel components permits full prefabrication of the parts and assembly by nut-and - bolt is simple and rapid. It is, however, a 'one-off' building. In any form of system building for a large market provision must be made for the variety of situations produced by varying spans and loading of beams and by single or two-storey buildings, by designing ranges of components with a minimum of variations in construction and dimensions which may be applied to a maximum number of building situations. The figure shows solutions to some aspects of the problem which have been worked out in practice. (A, B, and C) illustrate column types in the same system, all of standard width. (A) is for the light loads and consists of two relatively thin but identical members of sufficient cross-sectional area to take the maximum design load for which they are intended, blocked apart to prevent them buckling. (B) is a built-up solid version with increased bearing area to take greater loads, the outer members and the overall dimensions being the same as in (A). (C) is an extension of (B) to provide further bearing area by the addition of a solid piece glued to (B), to receive which the rebate in the latter is formed. Thus by this means provision is made for a range of loading conditions by a minimum number of component parts with a standard width dimension.

Variations in span and loading of beams may be met by increased depth and by change of form while maintaining a standard width. Normal timber sizes set a limit to the depth of solid timber beams but deeper beams may be formed as plywood box beams as in (E) where imposed loads are light or by laminating thin boards in glulam construction as in (D).

The three-piece built-up solid column shown in (E) permits a splice connection to be formed for two story construction, by a simple variation of standard storey-height column components.

The recess to accommodate the beam at the head of a standard column, formed by the omission of the centre piece at that point, is extended by the use of longer outer members. This receives the splice formed at the foot of the upper column by the use of shorter outer members. In this example the end of

the ply box-beam is formed as a deep tenon which is accommodated by the column recess and bears on top of the centre piece. The connection is secured by bolts which pass through the edge members of the infill panels to hold them in position.

In single-storey framed systems the seating and fixing of beams may be accomplished by making the column shorter than the adjacent infill panels and using the latter to fix the beam in position as in (G) which requires the fixing of the panels prior to setting the beam in position. In (F) the built-up column has two thinner outer pieces which carry up the full height and serve to hold the beam in position by nailing until the infill panels are offered up and bolted in position.

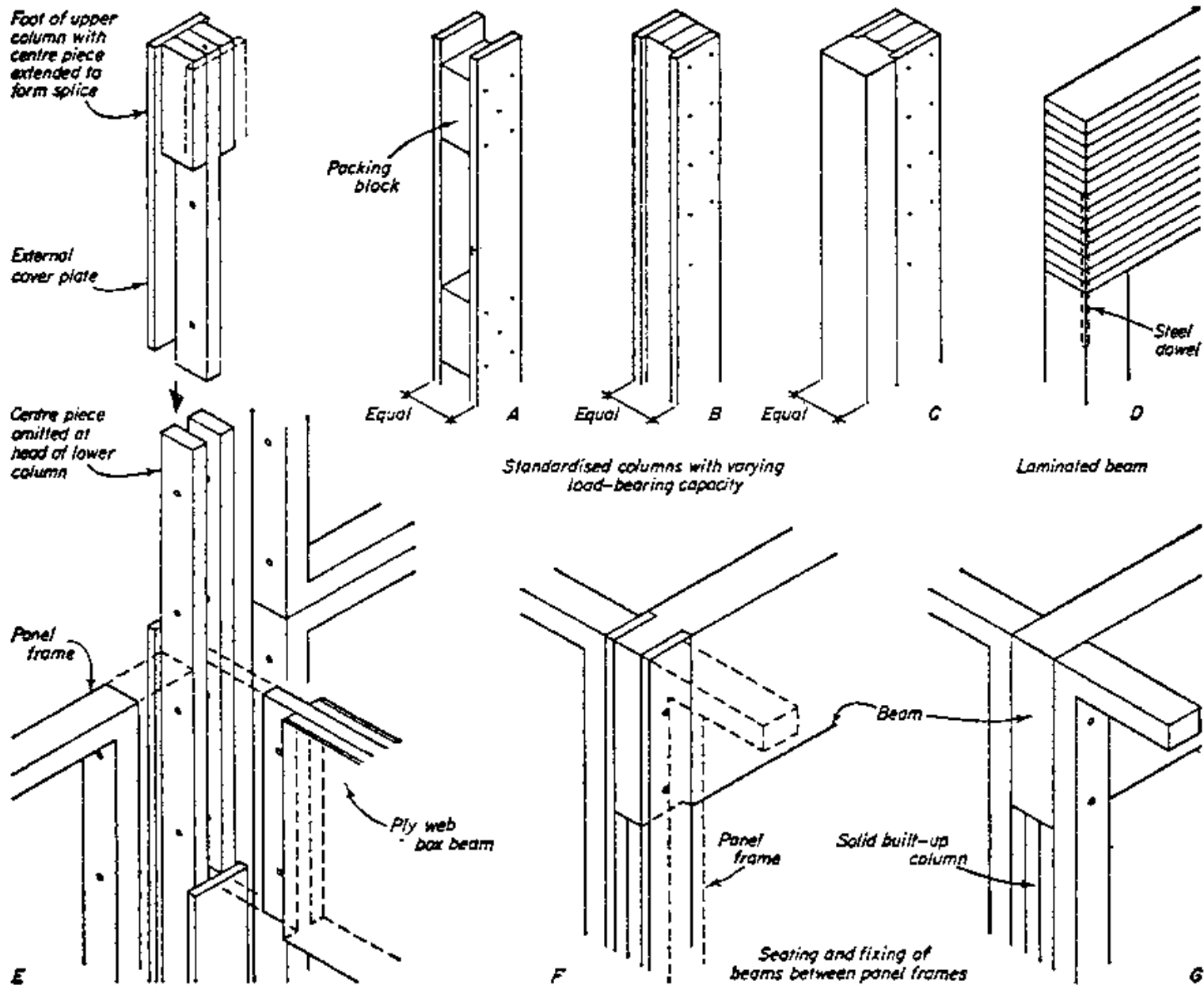

10.6 PORTAL FRAMES

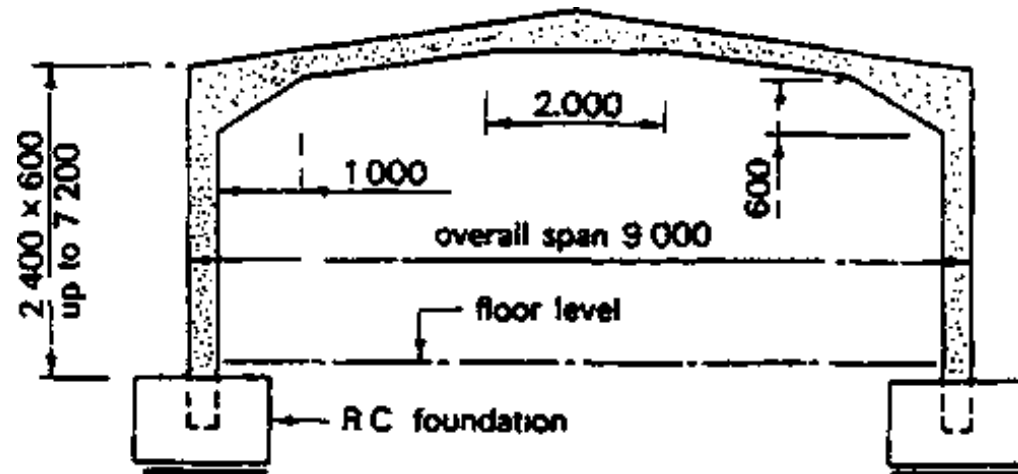

Typical frame outline

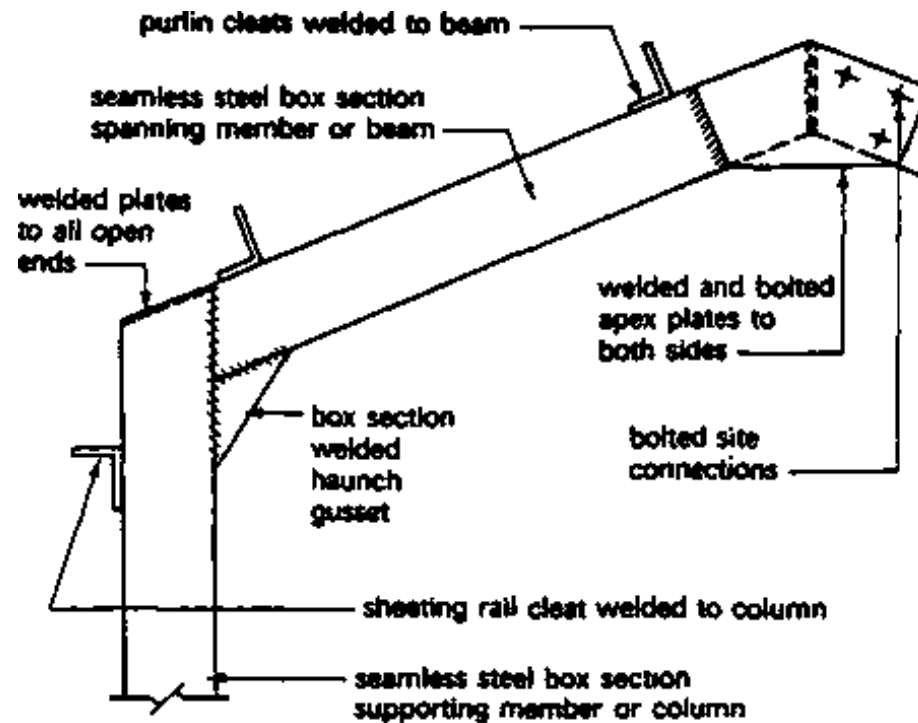

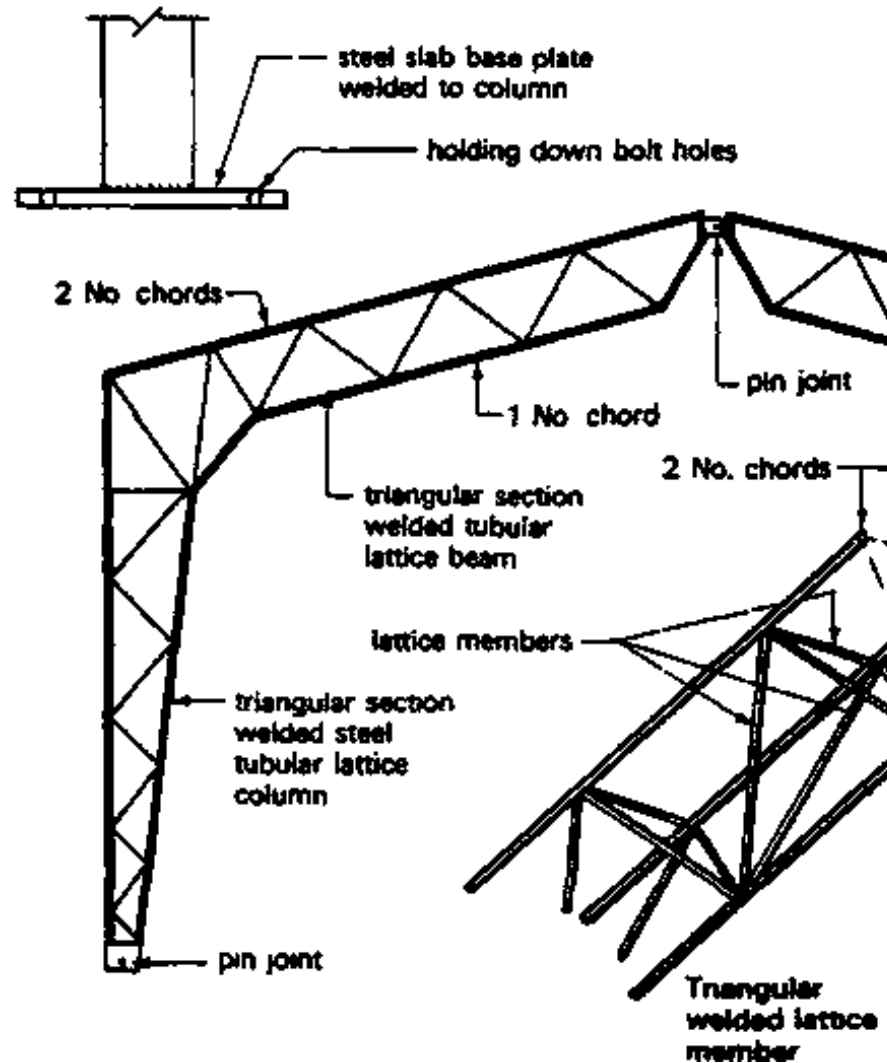

Typical steel portal frames

10.6.1 THEORY

- A portal frame may be defined as a continuous or rigid frame.
- The basic characteristic is that of a rigid or restrained joint between the supporting member (column)

and the spanning member (beam).

- The object of this continuity is to reduce the bending moment in the spanning member by allowing the frame to act as one structural entity, thus distributing the stresses throughout the frame.

- In a conventional simply supported beam (over a large span) an excessive bending moment occurs at mid-span.

This necessitates a deep heavy beam or a beam shaped to give a large cross section at mid-span.

Alternatively a deep cross member of lattice struts, and ties could be used. The main advantage of a simply supported frame lies in the fact that the column loading is axial and therefore no bending is induced into the supporting members

This may ease design problems (since it would be statically determinate), but does not necessarily produce an economic structure.

Furthermore the use of a portal frame eliminates the need for a lattice of struts and ties within the roof space, giving a greater usable volume to the structure and generally a more pleasing internal appearance.

- In a RIGID FRAME the transfer of stresses from the beam to the column will require special care in the design of the joint between the members.

Similarly the horizontal thrust and/or the rotational movement at the foundation connection needs careful consideration. Methods to overcome excessive forces at the foundation are:

1. Reliance on the PASSIVE PRESSURE of the soil surrounding the foundation.

2. Inclined foundations so that the curve of pressure is normal to the upper surface thus tending

to induce only compressive forces.

3. A tie bar or beam between opposite foundations.

4. Introducing a hinge or pin joint where the column connects to the foundation.

Portal frames - comparison of bending moments

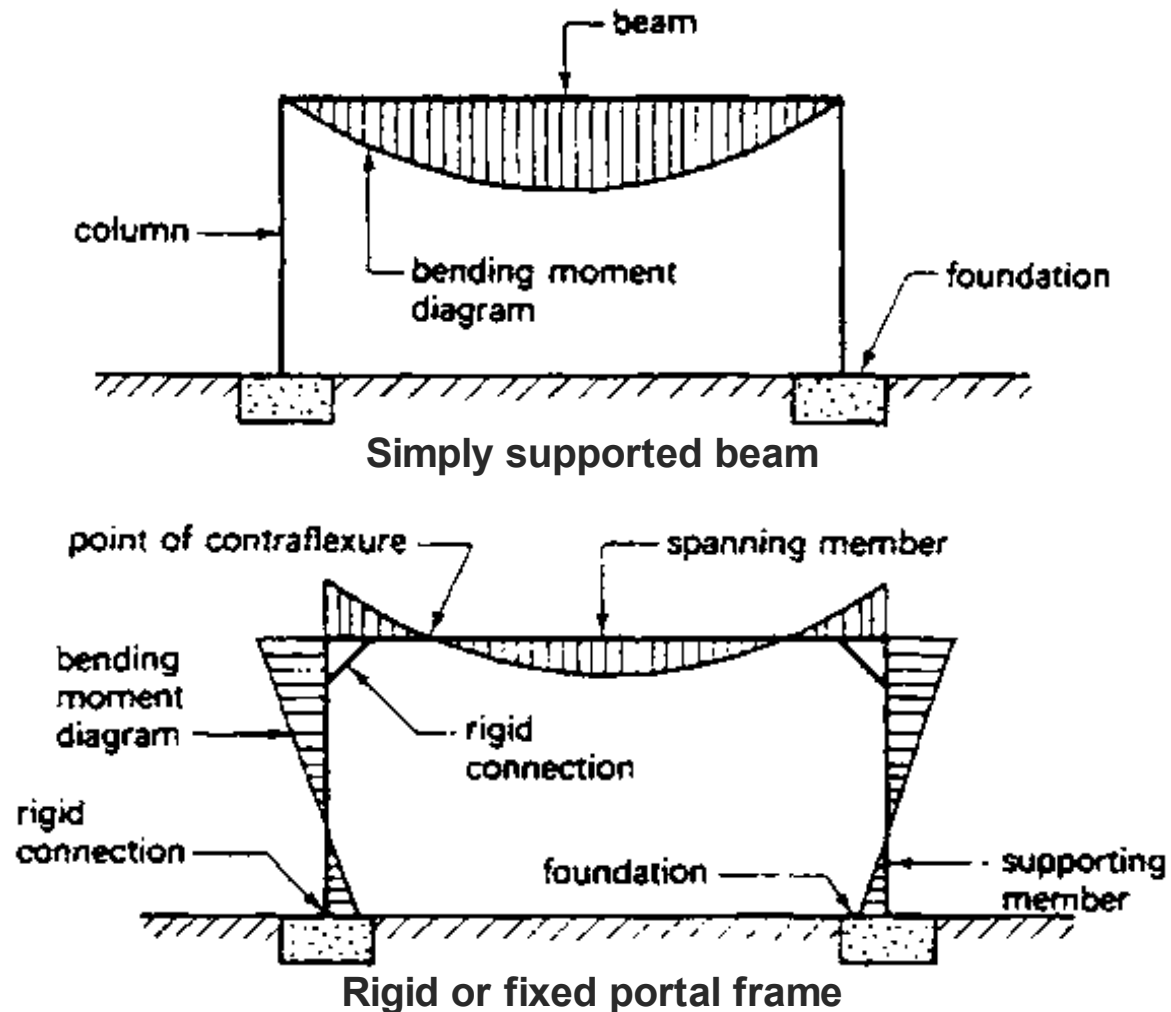

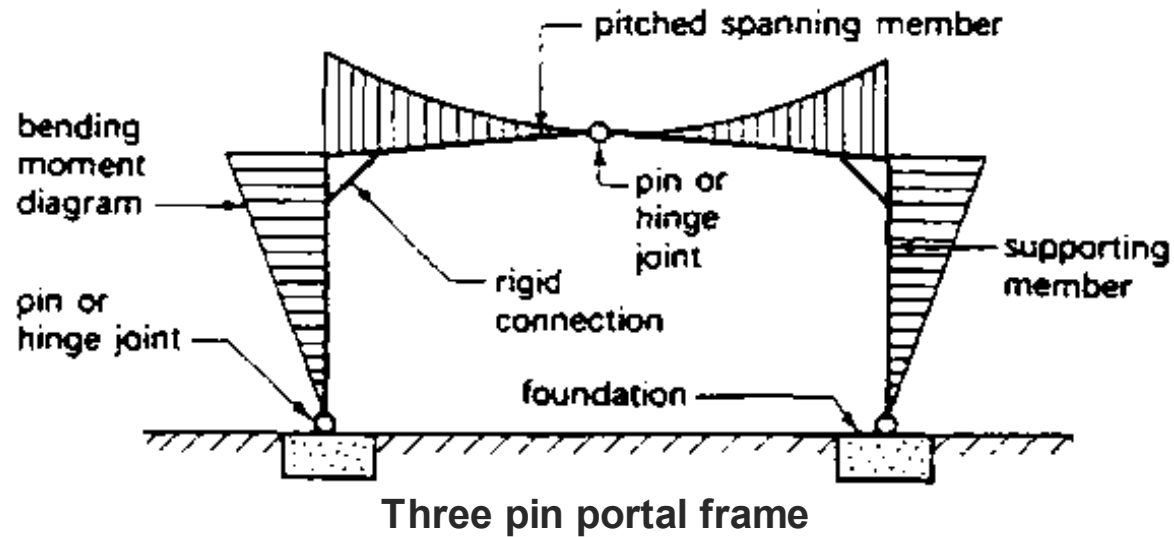
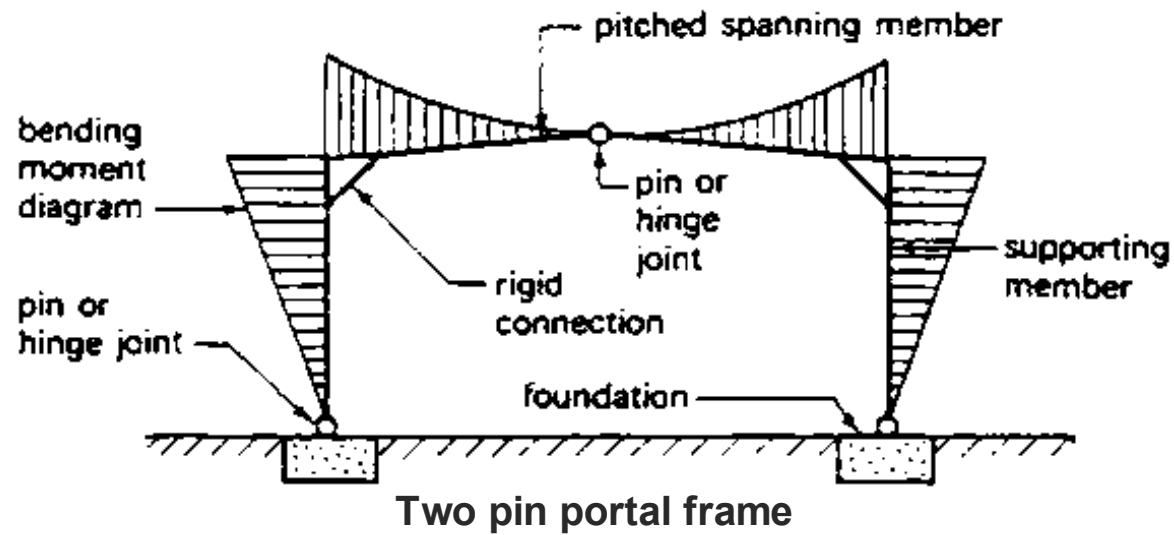

- HINGES

Portal frames are usually connected directly to their foundation bases, forming rigid or unrestrained joints.

The rotational movement caused by wind pressures, tending to move the frames and horizontal thrusts of the frame loadings are generally resisted by the size of the base and the passive earth pressures. When the frames start to exceed 4 m in height and 15 m in span the introduction of a hinged or pin joint at the base connection should be considered.

A hinge is a device which will allow free rotation to take place at the point of fixity but at the same time will transmit both load and shear from one member to another.

They are sometimes called: pin joints, unrestrained joints, non-rigid joints.

Since no bending moment is transmitted through a hinged joint the design is simplified by the structural connection becoming statically determinate.

(In practice it is not always necessary to provide a true PIVOT where a hinge is included but to provide just enough movement to ensure the rigidity at the connection is low enough to overcome the tendency of rotational movement.)

Hinges can be introduced into a portal frame design at the base connections and at the centre or apex of the spanning member, giving three basic forms of portal frames:

1. Fixed or rigid portal frames-all connections between frame members are rigid.

- The bending moment will be of lower magnitude and more evenly distributed than other forms.

- Used for small to medium size frames where the moments transferred to the foundations will be excessive.

2. Two pin portal frame - hinges are used at the base connection to eliminate the tendency of the base to rotate.

- The bending moments resisted by the supporting members will be greater than those in the rigid portal frame.
- Main use is where high base moments and weak ground conditions are encountered.

3. Three-pin portal frames - this form has hinged joints at the base connections and at the centre of the spanning member.

- The effect of the third hinge is to reduce the bending moment in the spanning member but to increase deflection.
- To overcome this latter disadvantage a deeper beam must be used or alternatively the spanning member must be given a pitch to raise the apex wall above the eaves level.

Two other advantages of the three-pin portal frame are that the design is simplified since the frame is statically determinate and on site they are easier to erect, particularly when preformed in sections.

Most portal frames are made under factory controlled conditions - off site - which gives good dimensional and quality control but can create transportation problems.

To lessen this problem and that of site erection splices may be used. These can be positioned at the points of contraflexure, junction between spanning and supporting members and at the crown or apex of the beam.

Portal frames can take the form of the usual roof profiles for single or multi-span buildings

Portal frames can take the form of the usual roof profiles for single or multi-span buildings.

The frames are generally connected over the spanning members with purlines designed to carry lightweight roof coverings or deckings.

The walls can be of similar material fixed to sheeting rails attached to the supporting members or alternatively clad with brick or infill panels.

10.6.2 CONCRETE PORTAL FRAMES

Concrete portal frames are invariably manufactured from high quality precast concrete suitably reinforced.

In the main the use of precast concrete portal frames is confined to low pitch (4° to 22 1/2°) single span frames but two storey and multi-span frames are available, giving a wide range of designs from only a few standard components.

The frames are generally designed to carry a lightweight (34 kg/m² maximum) roof sheeting or decking fixed to precast concrete purlins.

Typical single span pcc frame

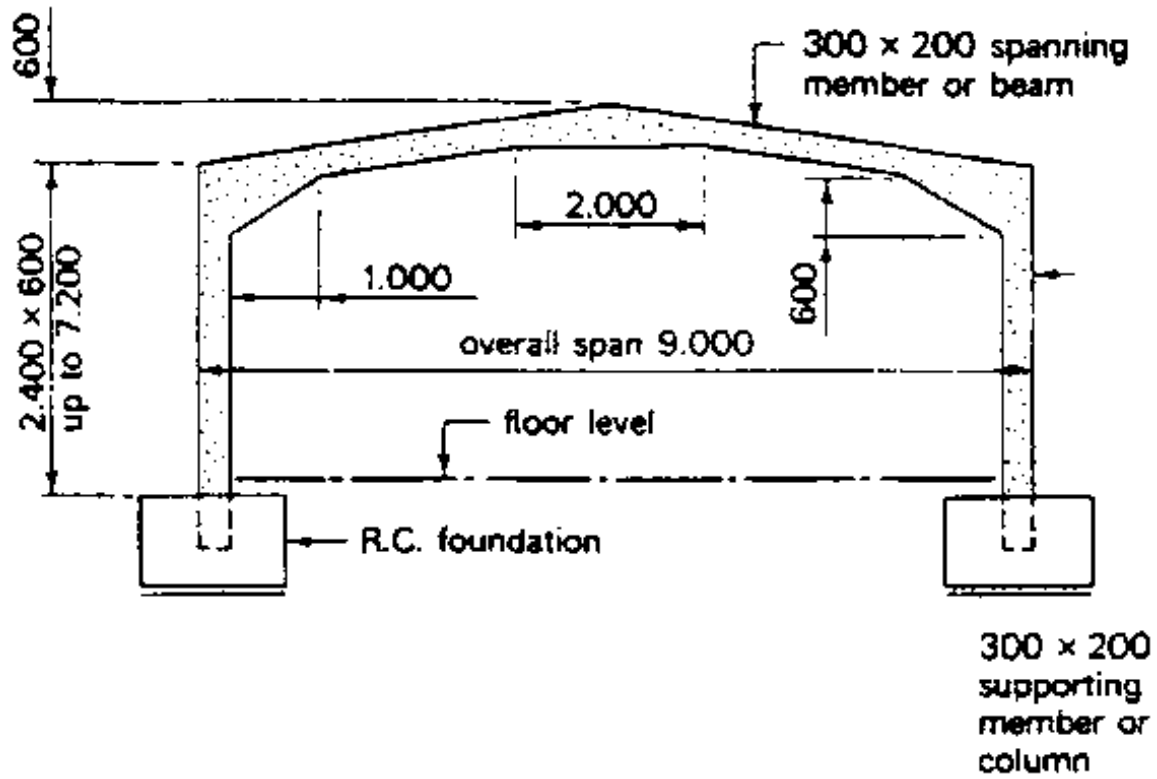

Typical frame outline

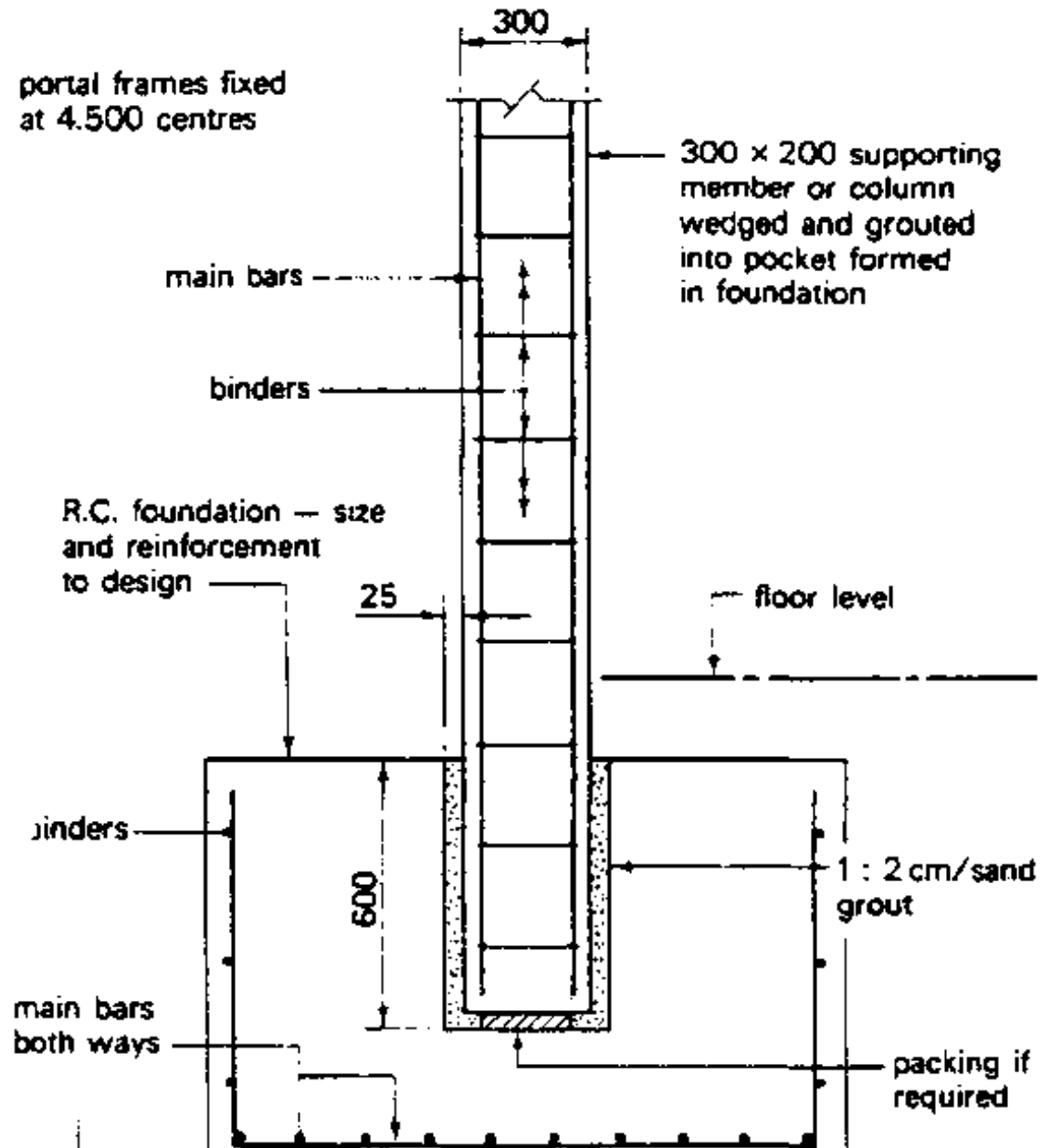

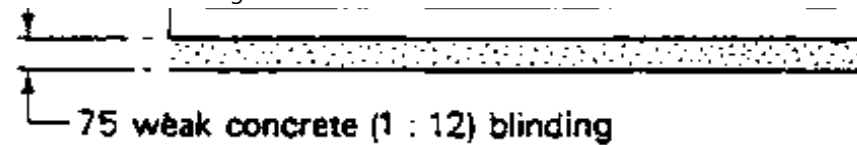

Typical column to foundation connection

Wall finishes can be varied and intermixed since they are non-load bearing and therefore have to provide only the degree of resistance required for fire, thermal and sound insulation, act as a barrier to the elements and resist positive and negative wind pressures. Sheet claddings are fixed in the traditional manner, using hook bolts and purlins, sheet wall claddings are fixed in a similar manner to sheeting rails of precast concrete or steel spanning between or over the supporting members. Brick or block wall panels either of solid or cavity construction can be built off a ground beams constructed between the foundation bases or alternatively they can be built off the ground floor slab. It must be remembered that all such claddings must comply with any relevant Building Regulations. Foundations and fixings. The foundations for a precast concrete portal frame usually consist of a reinforced concrete isolated base or pad designed to suit loading and ground bearing conditions. The frame can be connected to the foundations by a variety of methods:

1. **Pocket connection** - the foot of the supporting member is located and housed in a void or pocket formed in the base so that there is an all round clearance of 25 mm to allow for plumbing and final adjustment before the column is grouted into the foundation base.
2. **Base plate connection** - a steel base plate is welded to the main reinforcement of the supporting member, or alternatively it could be cast into the column using fixing lugs welded to the- back of the base plate. Holding down bolts are cast into the foundation base; the erection and fixing procedure follows that described for structural steelwork.
3. **Pin joint or hinge connection** - a special base or bearing plate is bolted to the foundation and the mechanical connection is made when the frames are erected.

The choice of connection method depends largely upon the degree of fixity required and the method

The choice of connection method depends largely upon the degree of fixity required and the method adopted by the manufacturer for his particular system.

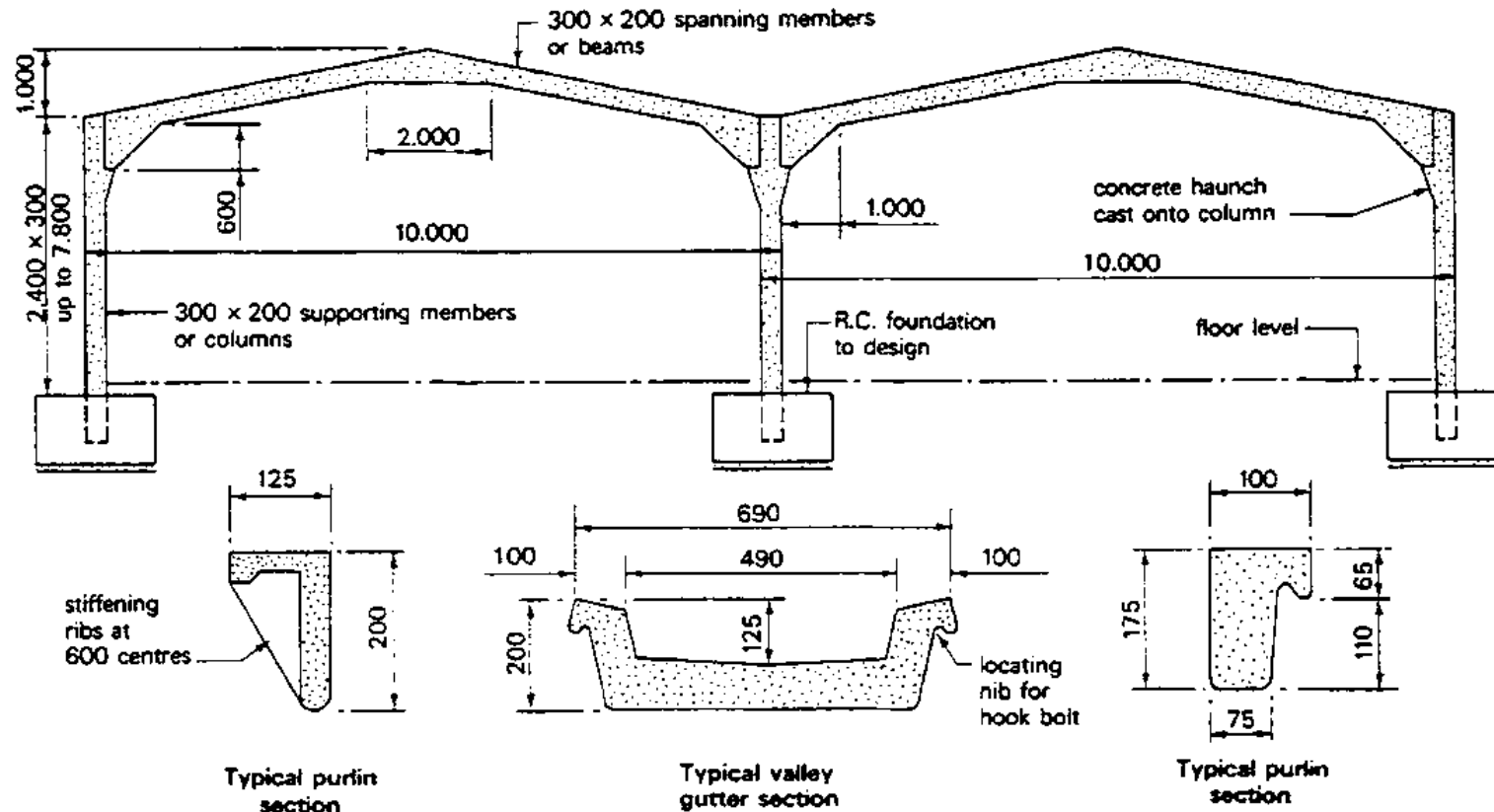

Fig III.3 Typical multi-span precast concrete portal frame

Advantages

The main advantages of using precast concrete portal frames can be enumerated thus:

1. Factory production will result in accurate and predictable components since the criteria for design, quality and workmanship recommended in CP 110 can be more accurately controlled under factory conditions than casting components in situ.

2. Most manufacturers produce a standard range of interchangeable components which, within the limitations of their systems, gives a well-balanced and flexible design range covering most roof profiles, single span frames, multi-span frames and lean-to roof attachments. By adopting this limited range of members the producers of precast portal frames can offer their products at competitive rates soupled with reasonable delivery periods.
3. Maintenance of precast concrete frames is not usually required unless the building owner chooses to paint or clad the frames.
4. Precast concrete products have their own built-in natural resistance to fire and therefore no fire-resistant treatment is required. By varying the cover of concrete over the reinforcement most frames up to 24.000 m span are given a 1-hour fire resistance and frames exceeding this span are rated at 2-hour firs resistance.
5. The wind resistance of precast concrete portal frames to both positive and negative pressures, is such that wind bracing is not usually required.

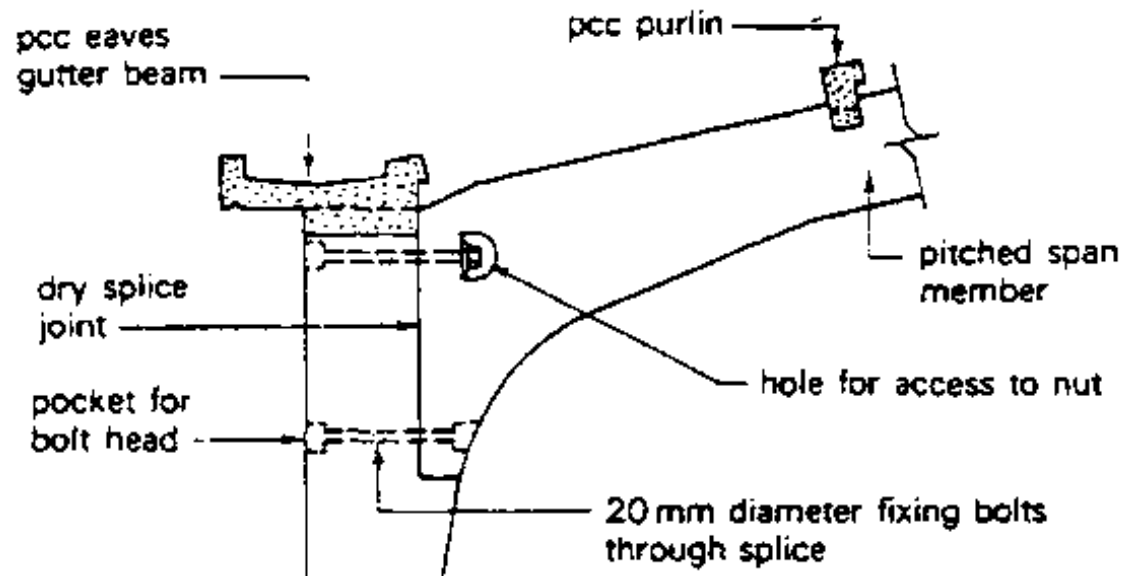

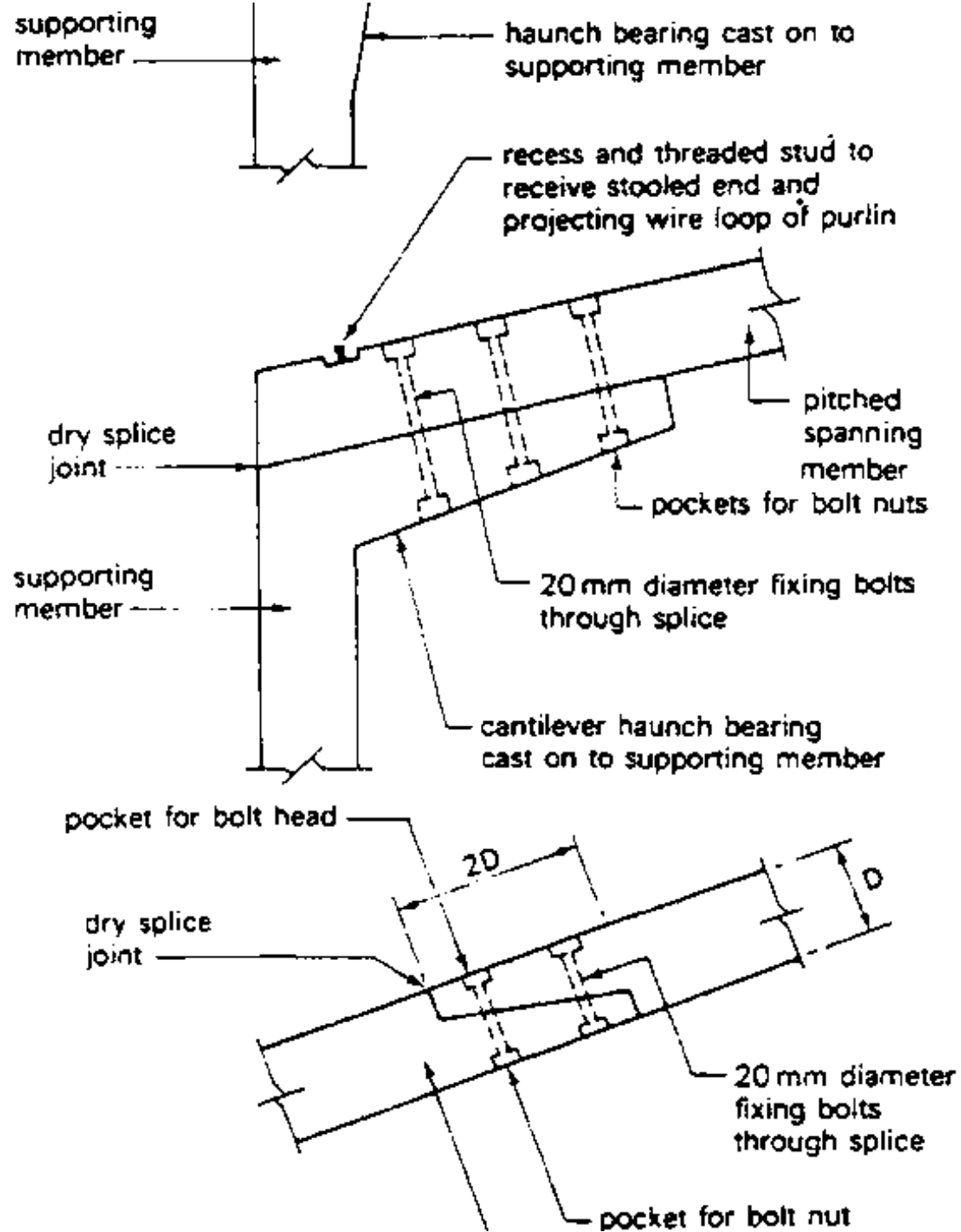

pitched spanning member
Typical splice details for pcc portal frames

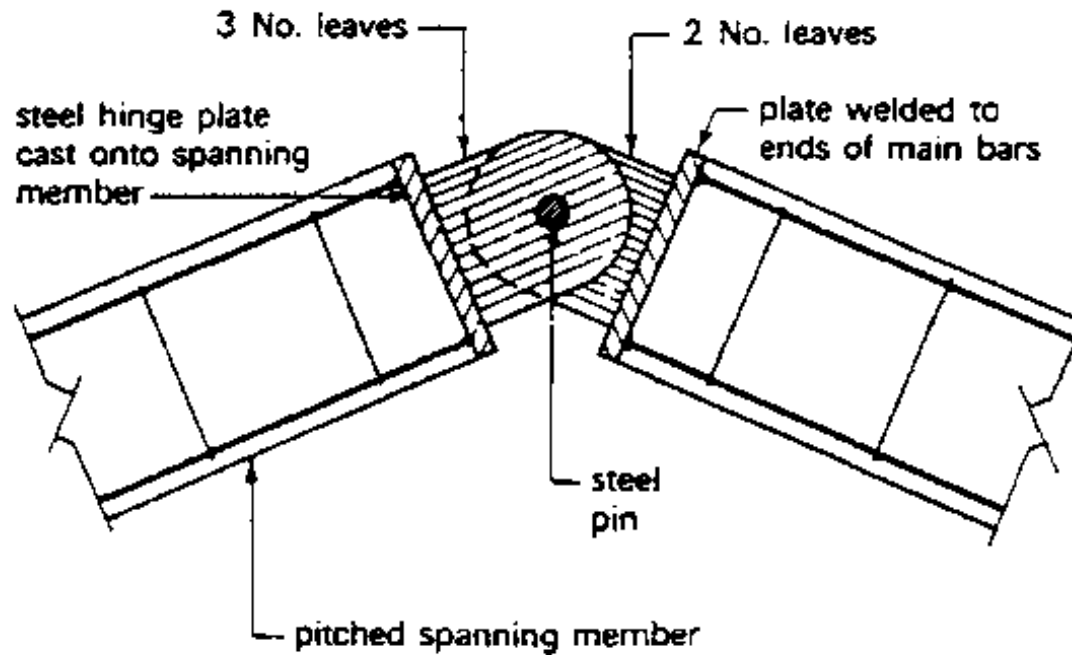
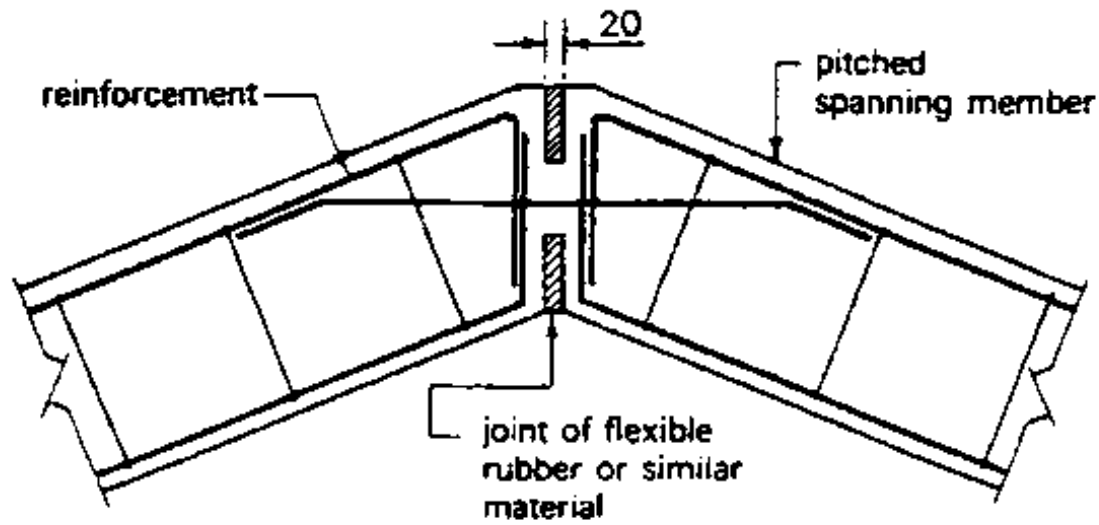

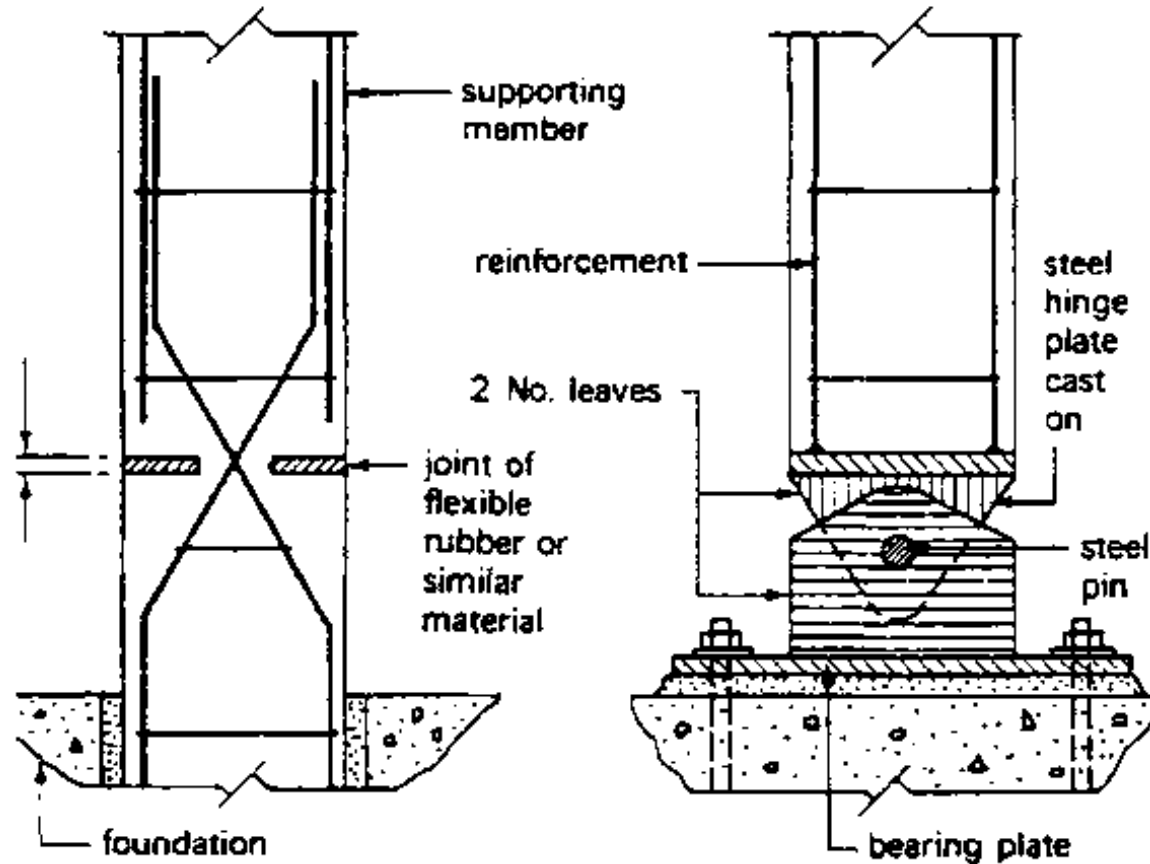

Typical hinge details for pcc portal frames

6. Where members of the frame are joined or spliced together the connections are generally mechanical (nut and bolt) and therefore the erection and jointing can be carried out by quickly trained semiskilled labour.
7. The clean lines of precast concrete portal frames are considered to be aesthetically pleasing.
8. In most cases the foundation design, setting out and construction can be carried out by the portal frame sub-contracting firm.

10.3.3 STEEL PORTAL FRAMES

Steel portal frames can be fabricated from standard universal beam, column and box sections. Alternatively a lattice construction of flats, angles or tubulars can be used. Most forms of roof profiles can be designed and constructed giving a competitive range when majority of systems employ welding techniques for the fabrication of alternative system uses special knee joint, apex joint and base joint column sections supplied by the main contractor or by the manufacturer producing the jointing pieces.

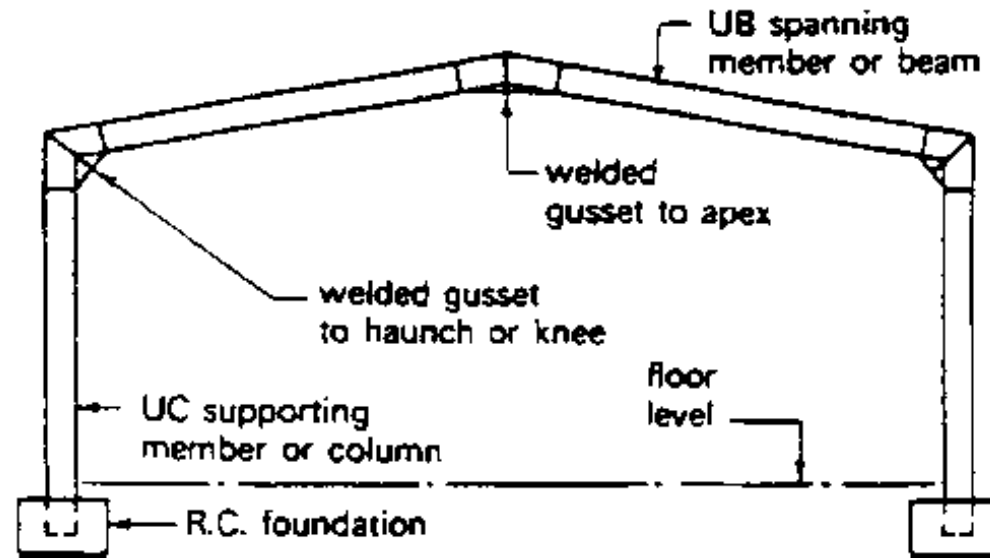

Typical steel portal frame profile

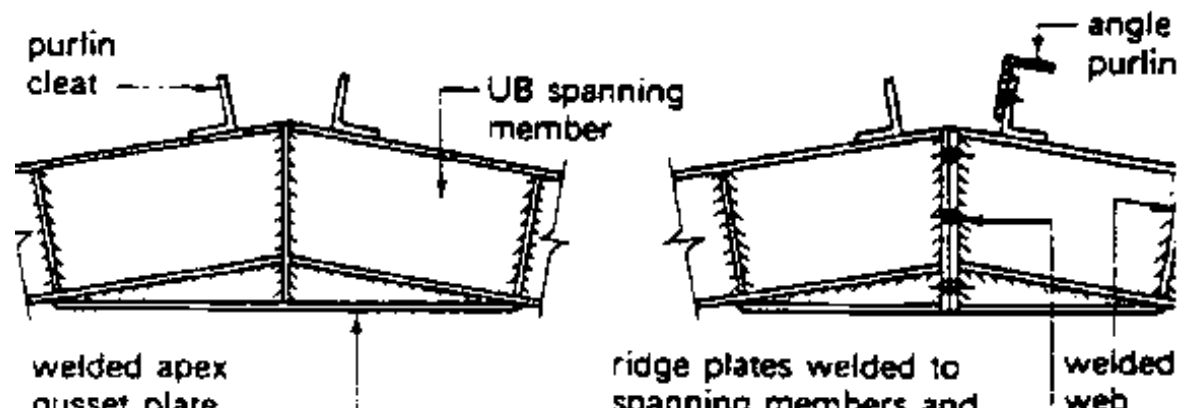

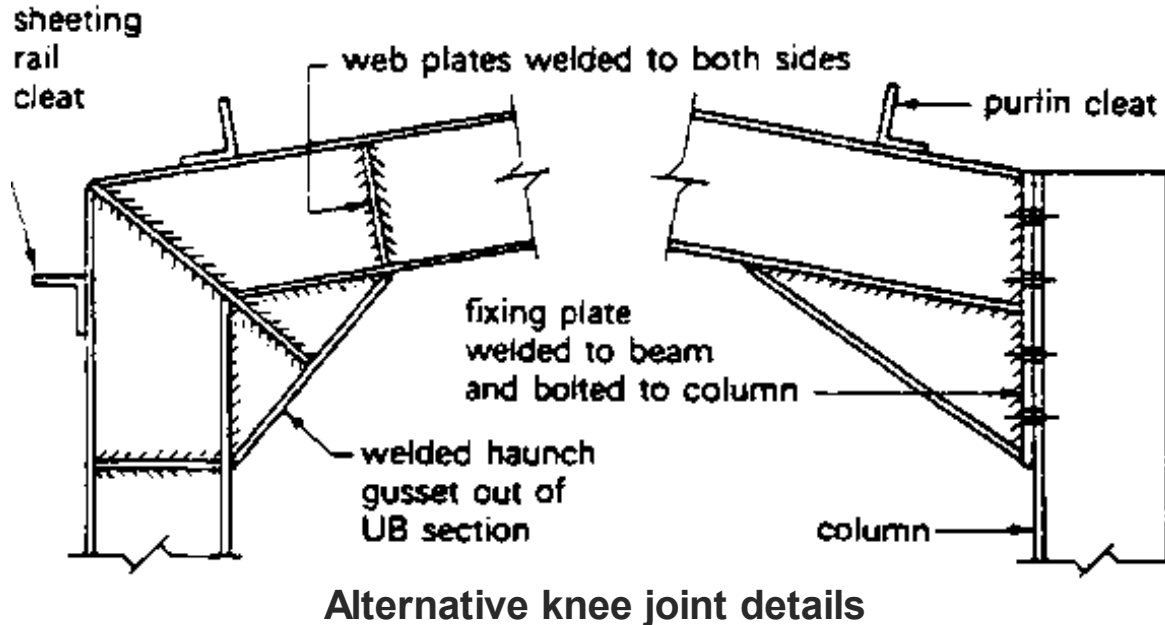
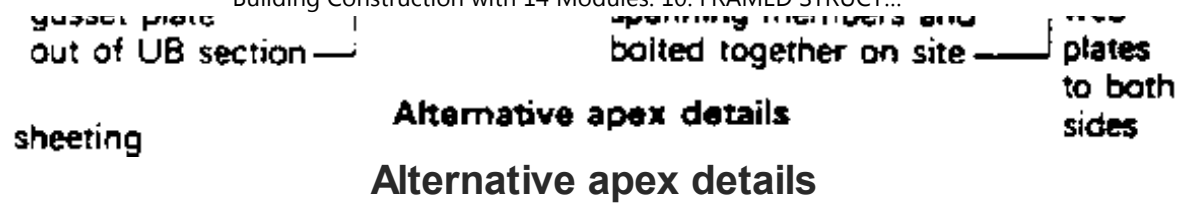

The frames are designed to carry lightweight roof coverings of the same loading conditions as those given previously for precast concrete portal frames. Similarly wall claddings can be of the same manner.

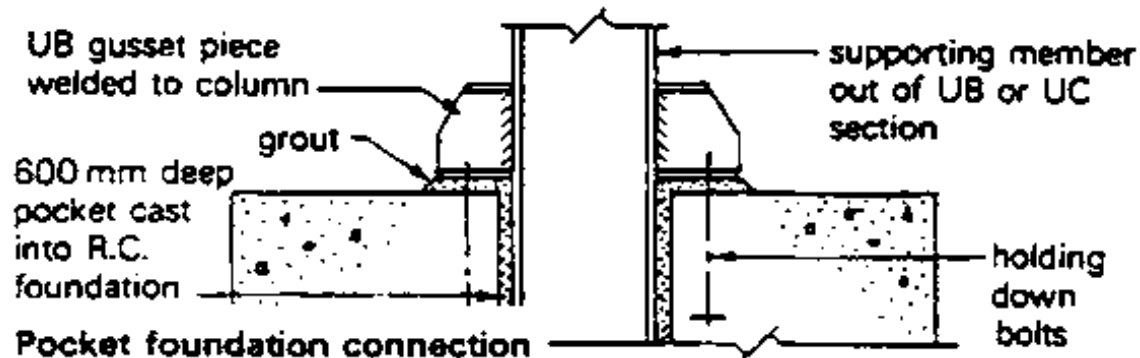

Foundations and fixings The foundation is usually a reinforced concrete isolated base or pad foundation

Foundations and fixings. The foundation is usually a reinforced concrete isolated base or pad foundation designed to suit loading and ground bearing conditions. The connection of the frame to the foundation can be by one of three basic methods:

1. Pocket connection -

The foot of the supporting member is inserted and grouted into a pocket formed in the concrete foundation as described for precast concrete portal frames. To facilitate levelling some designs have gussets welded to the flanges of the columns.

2. Base plate connection -

traditional structural steelwork column to foundation connection using a slab or a gusset base fixed to a reinforced concrete foundation with cast in holding down bolts.

3. Pin or hinge connection -

special bearing plates designed to accommodate true pin or rocker devices are fixed by holding down bolts to the concrete foundation to give the required low degree of rigidity at the connection.

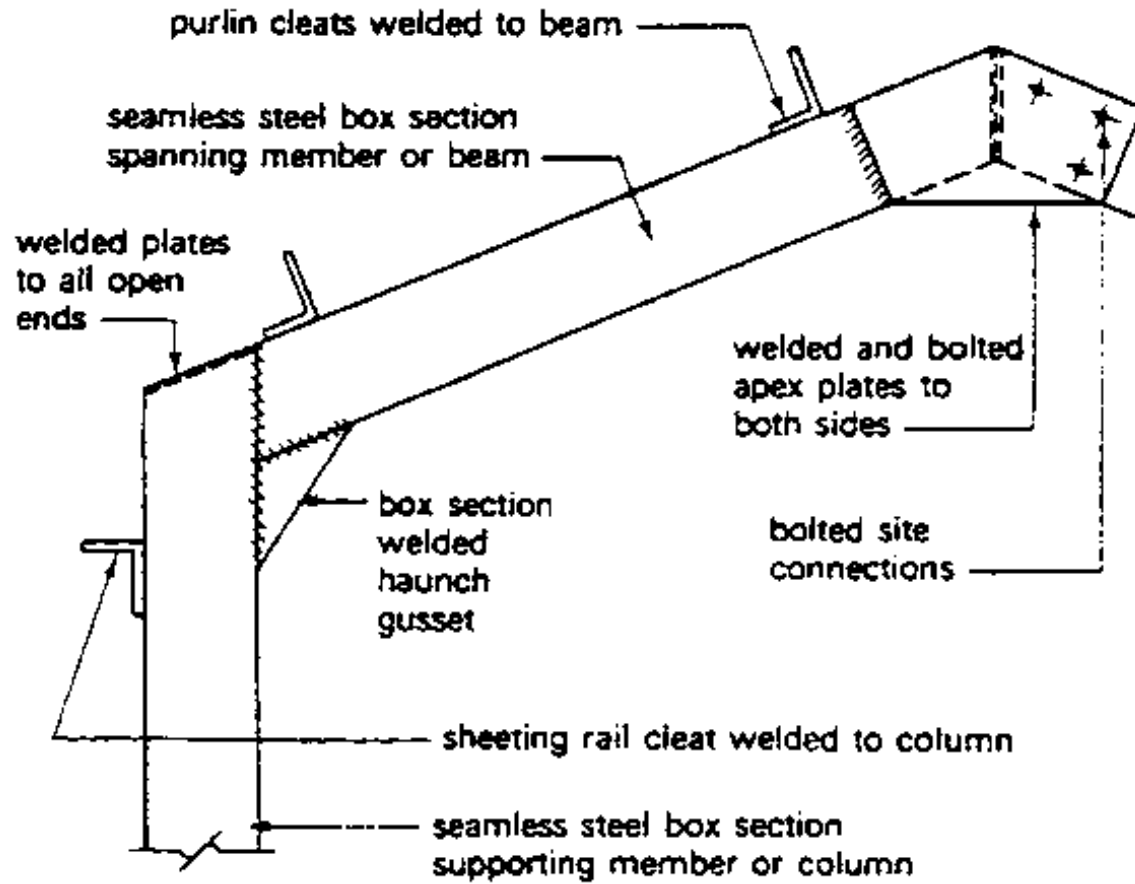

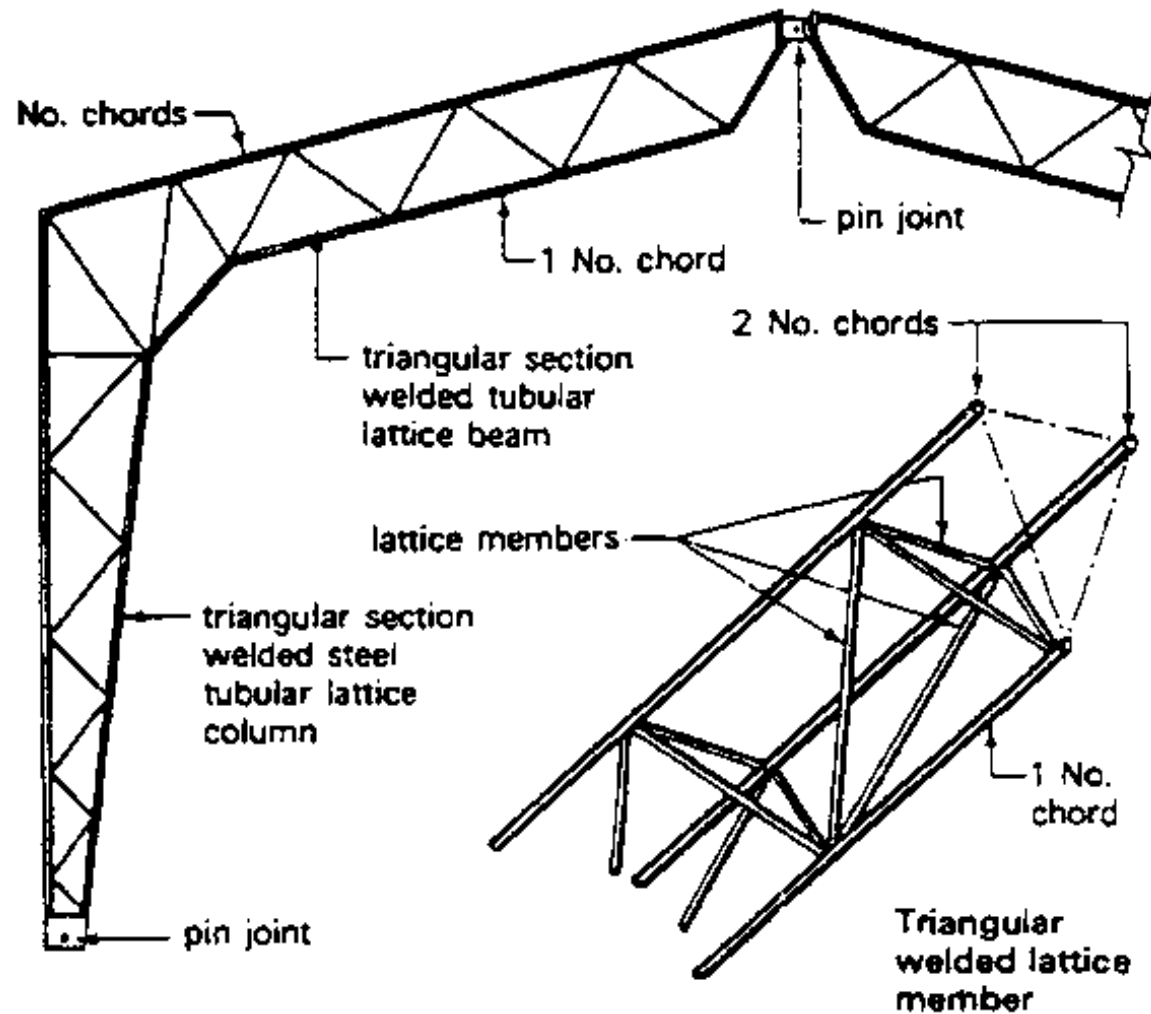

Typical steel portal frames

Advantages

The main advantages of factory controlled production are: a standard range of manufacturer's systems.

a frame of good wind resistance and the ease of site assembly using quickly trained semi-skilled labour attributed to precast concrete portal frames can be equally applied to steel portal frames. A further advantage of steel is that generally the overall dead load of a steel portal frame is less than a

comparable precast concrete portal frame. However, steel has the disadvantage of being a corrosive material which will require a long life protection of a patent coating or regular protective maintenance generally by the application of coats of paint. Steel has a lower fire resistance than precast concrete but if the frame is for a single storey building structural fire protection may not be required under the Building Regulations (see Building Regulation E5(4)).

Steel portal frames-splices and hinges

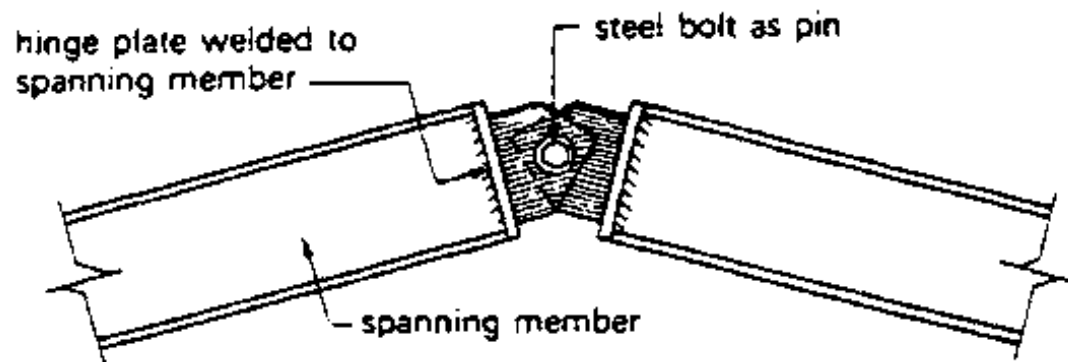

Typical apex hinge joint

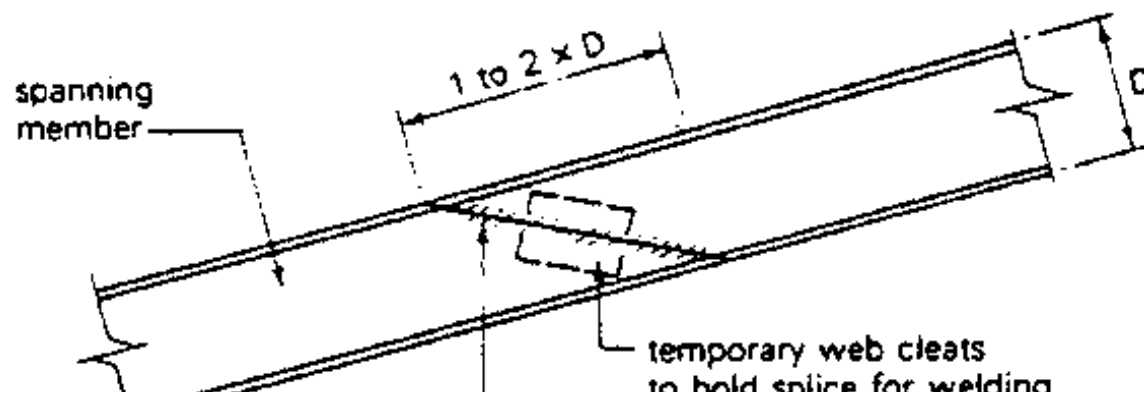

to hold splice for welding

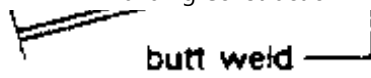

butt weld

Welded splice joint

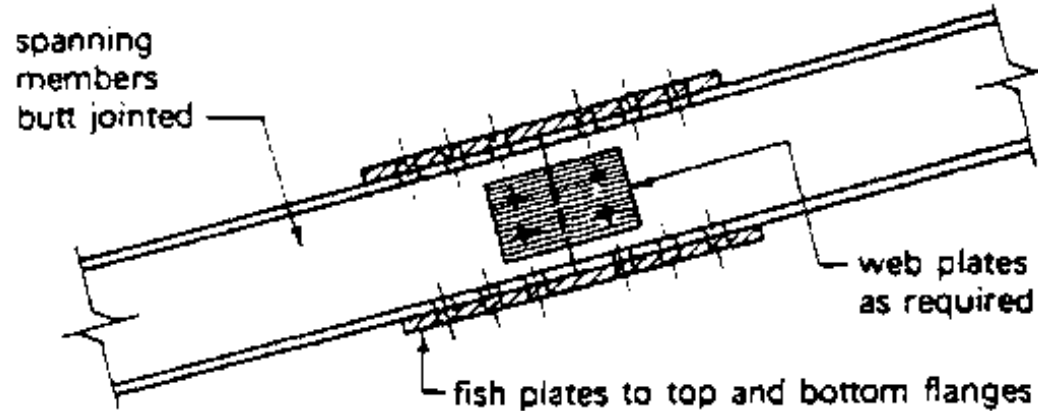

Bolted splice joint

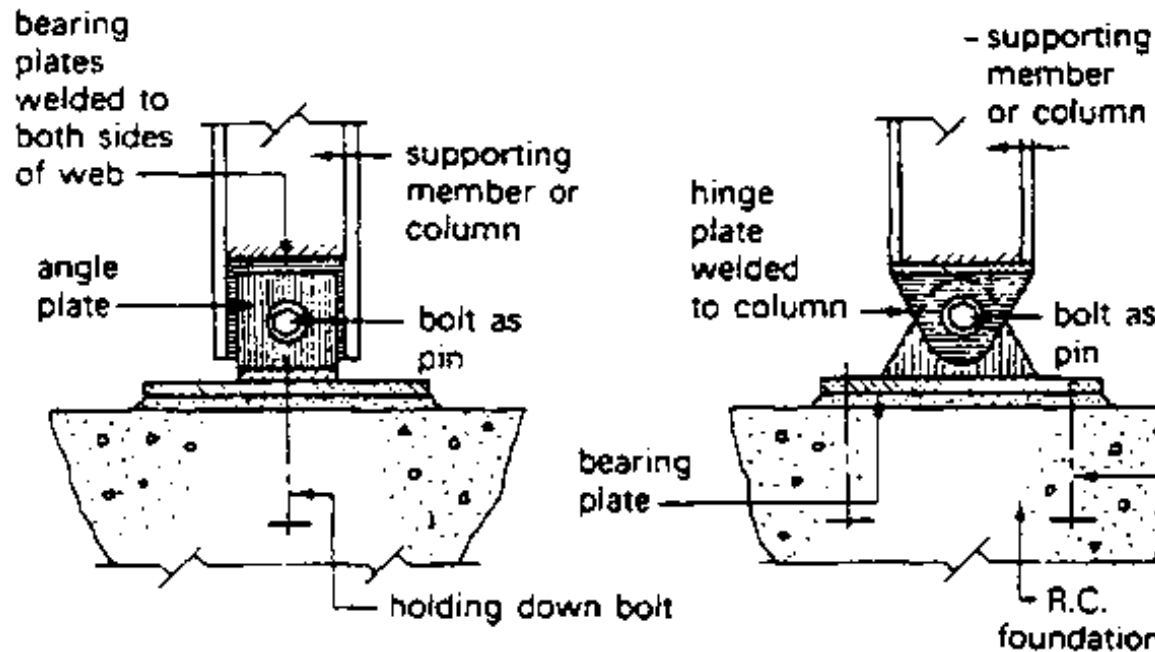

Typical base hinges

10.6.4 TIMBER PORTAL FRAMES

Timber portal frames can be manufactured by several methods which produce a light, strong frame of pleasing appearance which renders them suitable for buildings such as churches, halls and gymnasiums where clear space and appearance are important.

The common methods used are glued laminated portal frames, plywood faced portal frames and timber portal frames using solid members connected together with plywood gussets.

Glued laminated portal frames.

The main objective of forming a laminated member consisting of glued layers of thin section timber members is to obtain an overall increase in strength of the complete component over that which could be expected from a similar sized solid section of a particular species of timber. This type of portal frame is usually manufactured by a specialist firm since the jigs required would be too costly for small outputs.

The selection of suitable quality softwoods of the right moisture content is also important for a successful design. In common with other timber portal frames, these can be fully rigid, 2 pin or 3 pin structures.

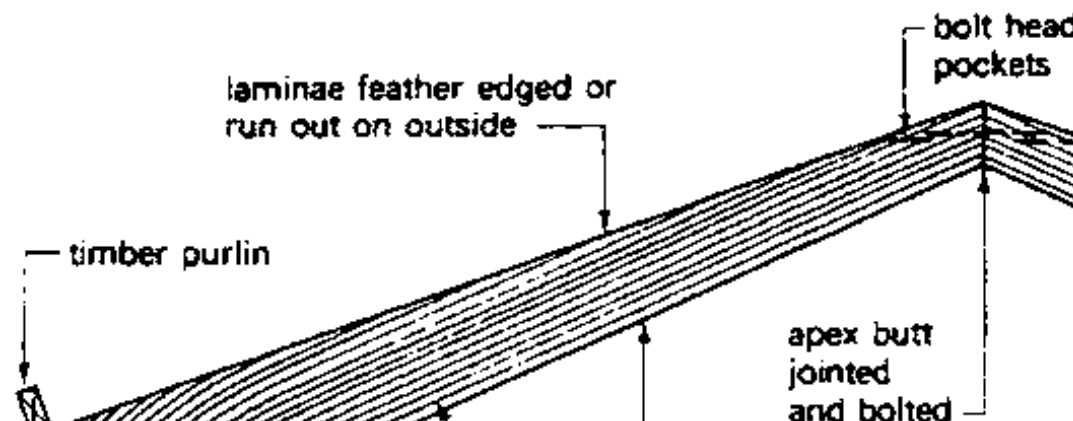

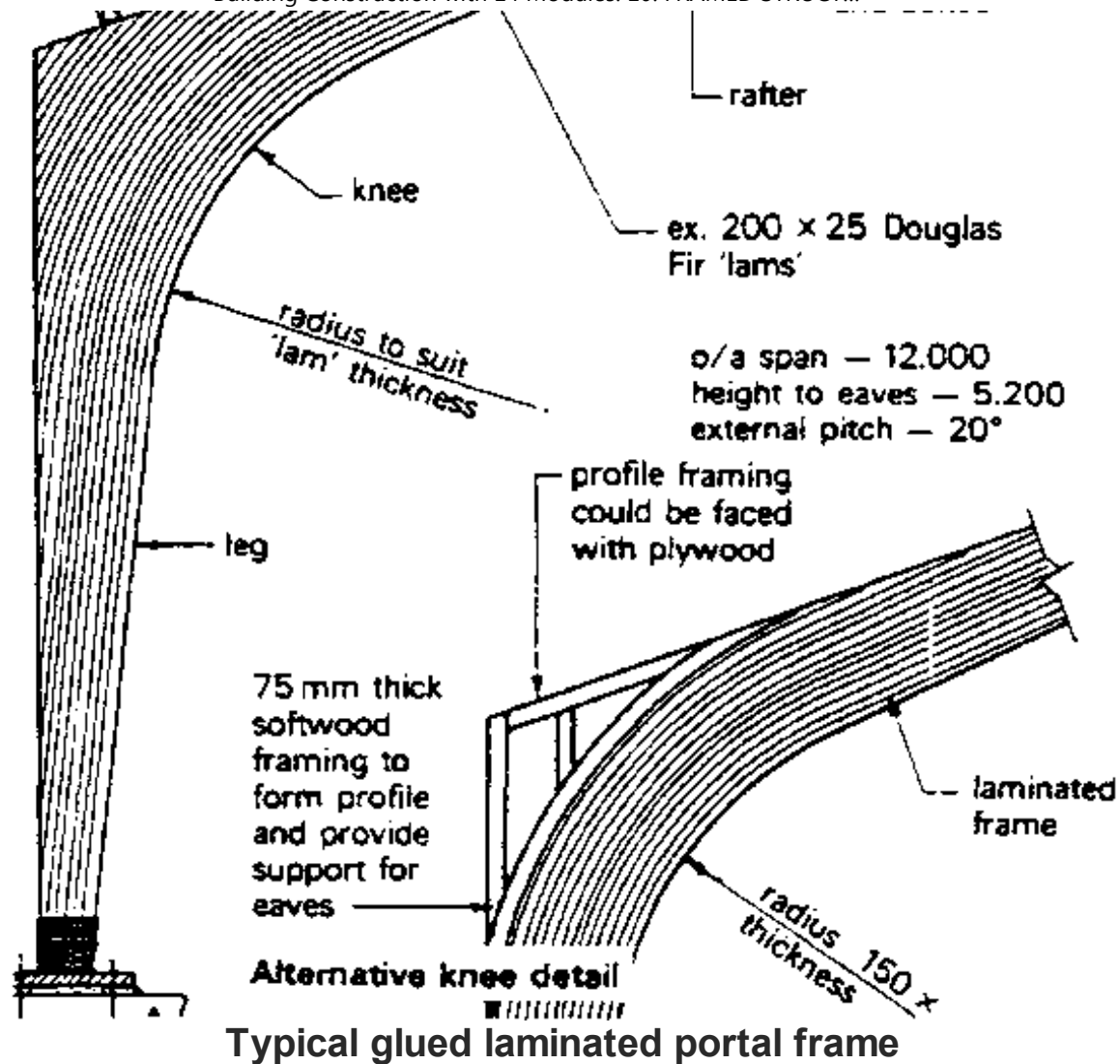

Site work is simple, consisting of connecting the foot of the supporting member to the metal shoe fixing or to a pivot housing bolted to the concrete foundation and connecting the joint at the apex or crown with a bolt fixing or a hinge device. Most glued laminated timber portal frames are fabricated in two halves which eases transportation problems and gives maximum usage of the assembly jigs. The frames can be linked together at roof level with timber purlins and clad with a light-weight sheeting or decking; alternatively, they may be finished with traditional roof coverings. Any form of walling can be used in

conjunction with these frames provided such walling forms com. ply with any of the applicable Building Regulations.

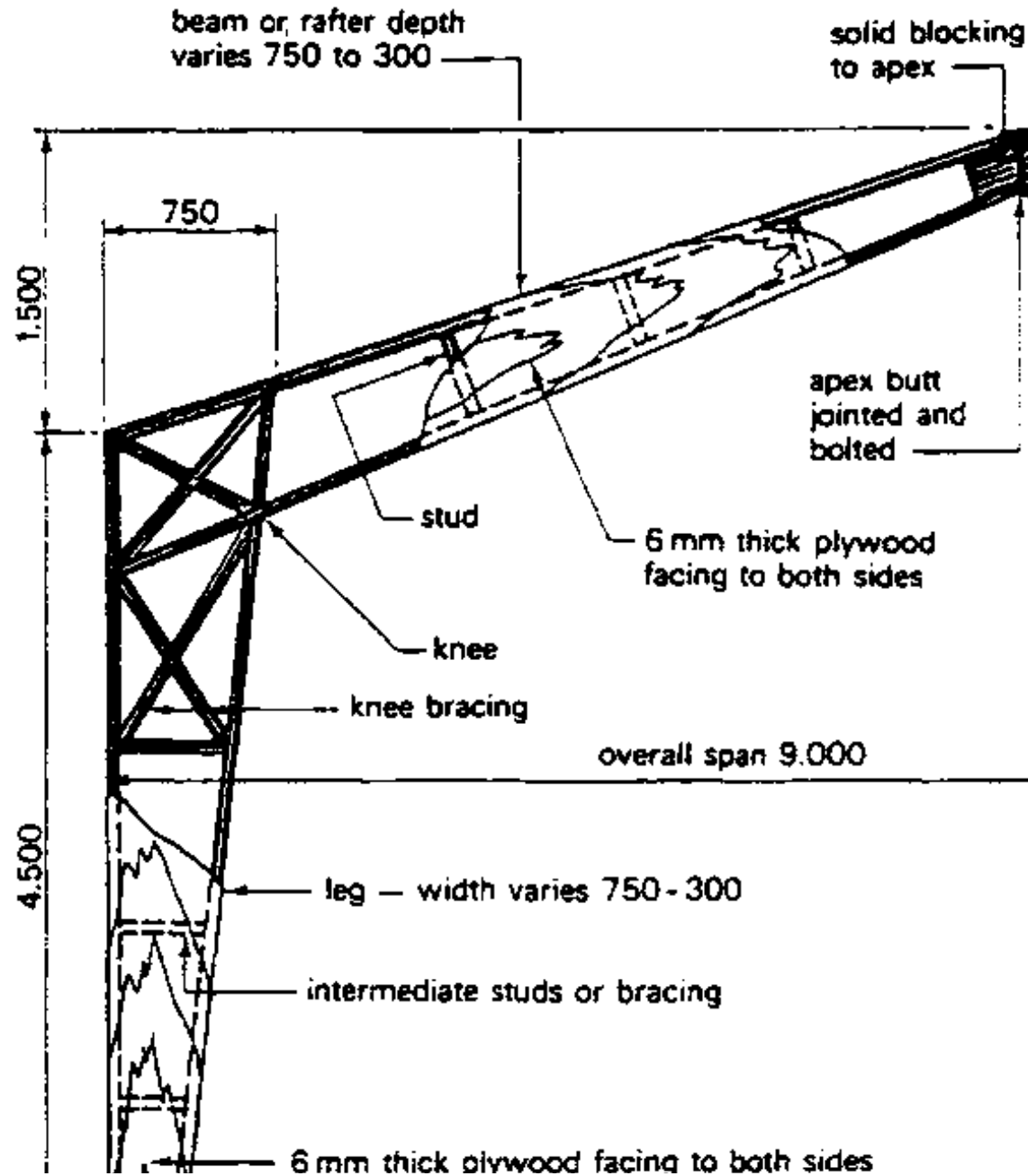

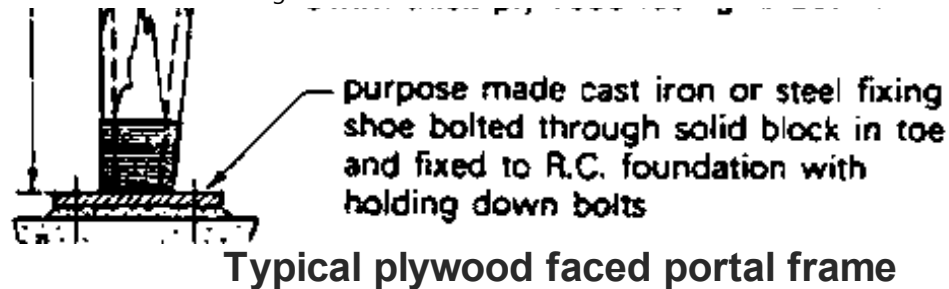

Plywood faced portal frames.

These frames are suitable for small halls, churches and schools with spans in the region of 9.000 m. The portal frames are in essence boxed beams consisting of a skeleton core of softwood members faced on both sides with plywood which takes the bending stresses. The hollow form of the construction enables electrical and other small services to be accommodated within the frame members. Design concepts, fixing and finishes are as given above for glued laminated portal frames.

Solid timber and plywood gussets.

These frames were developed to provide a simple and economic timber portal frame for clear span buildings using ordinary tools and basic skills. The general concept of this form of frame varies from the two types of timber portal frames previously described in that no glueing is used, the frames are spaced close together (600, 900 and 1200 mm centres) and are clad with a plywood sheath so that the finished structure acts as a shell giving a lightweight building which is very rigid and strong. The frames can be supplied in two halves and assembled by fixing the plywood apex gussets on site before erection or alternatively they can be supplied as a complete frame ready for site erection. The foundations for this form of timber portal frame consists of, a ground beam or alternatively the frames can be fixed to the edge of a raft slab. A timber spreader or sole plate is used along the entire length of the building to receive and distribute the thrust loads of the frames.

Connection to this spreader plate is made by using standard galvanised steel joists hangers or by using galvanised steel angle cleats. Standard timber windows and doors can be inserted into the side walls by

trimming in the conventional way and infilling where necessary with studs, noggins and rafters.

The advantages of all timber portal frame types can be enumerated as follows:

1. Constructed from readily available materials at an economic cost.
2. Light in weight.
3. Easy to transport and erect.
4. Can be trimmed and easily adjusted on site.
5. Protection against fungi and/ or insect attack can be by impregnation, or surface application.
6. Pleasing appearance either as a natural timber finish or painted.

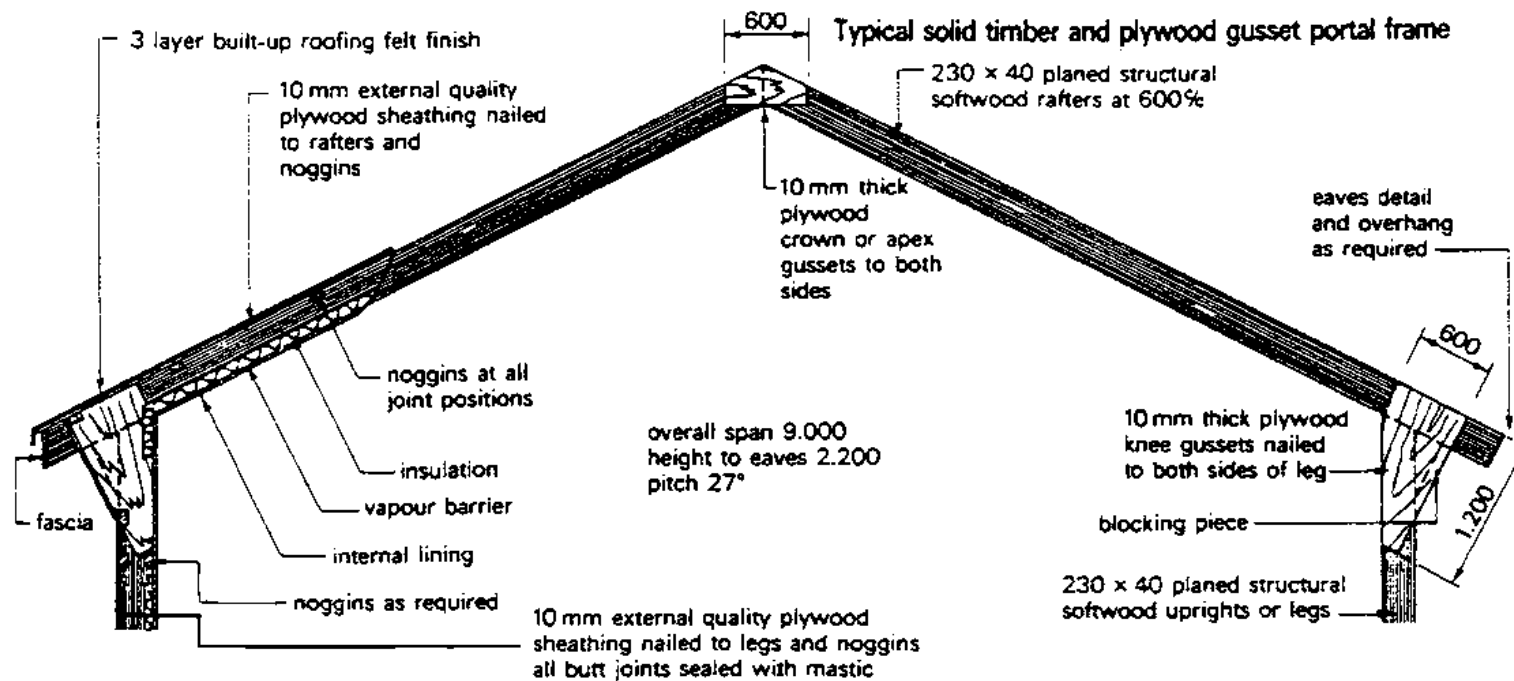

Typical solid timber and plywood gusset portal frame

Repetition exercises

Try to answer the following questions and practice sketching where ever necessary and possible -

1) Structural Concept

- a) Explain the term **FRAMED STRUCTURE**, and name the elements of a frame work!
- b) Classify different types of **FRAMED STRUCTURES!** (use sketches for illustration!)
- c) When is it logical and economical to use **FRAMED STRUCTURES?**

2) Functional Requirements

- a) Explain the difference between
 - Non-rigid frames
 - Semi-rigid frames and
 - Fully-rigid frames

3) Structural Materials

- a) List materials which are commonly used for framed structures!
- b) Explain the following terms:
 - Depth/span ratio
 - Dead/live load ratio
 - Strength/weight ratio

4) Layout of frames

- a) Write notes on **SPACING** of frames!

a) WRITE NOTES ON SPACING OF FRAMES!

b) Why should the layout of a SKELETON STRUCTURE be based on a regular STRUCTURAL GRID?

5) Building Frames

a) What are BUILDING FRAMES?

b) List different frame members and give brief explanations on each!

c) Write notes on reinforced concrete frames and explain their members:

- reinforced concrete beams. reinforced concrete columns
- reinforced concrete slabs (use sketches for illustration!)

d) Write notes on PRECAST CONCRETE FRAMES and their methods of connections! (use sketches for illustration!)

e) Compare structural steel, reinforced 'in situ' and precast concrete as a material in frame construction!

f) Write notes on STRUCTURAL STEEL FRAMES! (use sketches for illustration!)

g) What are CASTELLATED UNIVERSAL SECTIONS and why are they used?

h) Explain the terms SHOP CONNECTIONS and SITE CONNECTIONS and how they can be made by using bolts, rivets or by welding!

i) Write notes on structural steel connections!

k) Describe the erection of structural steel frames!

l) What do you know about FIRE PROTECTION of STEELWORK?

m) Write notes on TIMBER FRAMES, explaining their members COLUMNS and SEAMS, and their method of CONNECTIONS! (use sketches for illustration!)

n) Explain, by using sketches, the ways of construction of BUILDING FRAMES in TIMBER.

o) What do you know about the PREFABRICATION of timber frames?

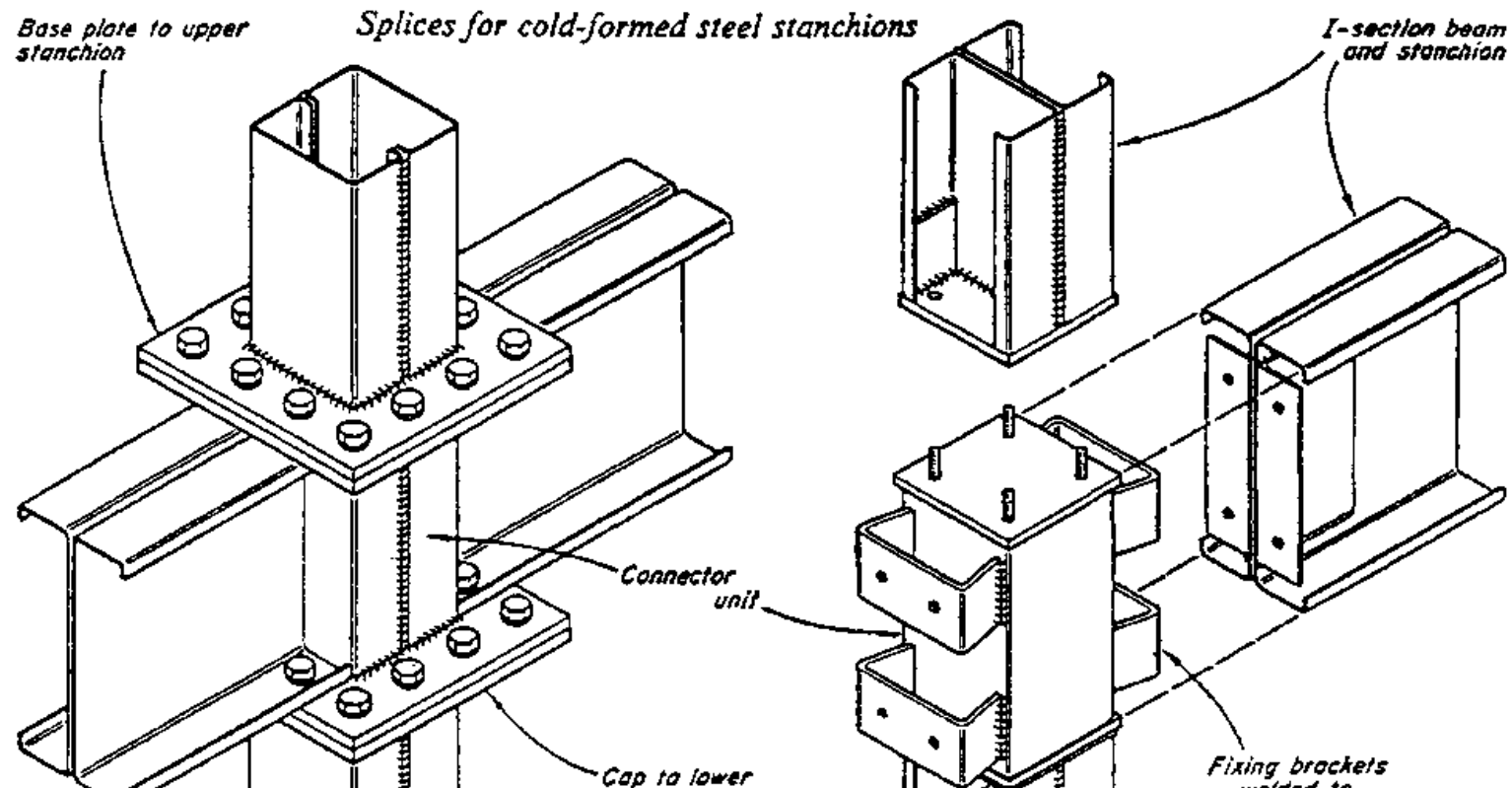



6) Portal frames

a) Characterize PORTAL FRAMES

b) What are the methods to overcome excessive forces at the foundation?

c) What are HINGES?

d) Explain the three basic forms of portal frames and show - by using sketches - the position of their hinges.

e) Write notes on CONCRETE PORTAL FRAMES, and their FOUNDATION and FIXINGS! (use sketches for illustration!)

f) What are the ADVANTAGES of concrete portal frames?

g) Write notes on STEEL PORTAL FRAMES, and their FOUNDATIONS and FIXINGS! (use sketches for illustration!)

h) What are the ADVANTAGES of steel portal frames?

i) Write notes on TIMBER PORTAL FRAMES and explain the differences between:

- GLUED LAMINATED PORTAL FRAMES
 - PLYWOOD FACED PORTAL FRAMES and
 - SOLID TIMBER and PLYWOOD GUSSETS.
- (use sketches for illustration!)

k) What are the **ADVANTAGES** of all timber portal frame types?

Please provide your feedback

English | French | Spanish | German