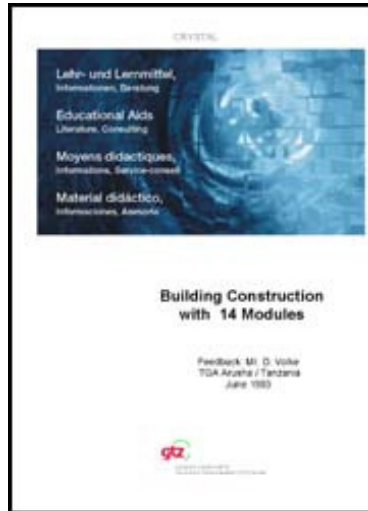

[Home page](#) | [Help](#) | [Clear](#)[English](#) | [French](#) | [Spanish](#) | [German](#)[Search](#) | [Subjects](#) | [Titles A-Z](#) | [Courses](#) | [Illustrations](#) | [Topics](#) | [e-Course builder](#)[Contract TOC](#)[Expand Document](#)[Contract Chapter](#)[Add to e-Course](#)[Preferences](#)

Printable version

Export document  
as HTML file [Help](#)

Export document  
as PDF file

## **Building Construction with 14 Modules (TCA; 1983; 618 pages)**

### **1. ARCHITECTURAL DRAWING I**

#### **1.1 AIMS AND PURPOSE OF ARCHITECTURAL DRAWINGS**

##### **1.1.1 CONTENTS OF ARCHITECTURAL DRAWINGS**

#### **1.2 DRAWING EQUIPMENT**

##### **1.2.1 PENCILS**

##### **1.2.2 DRAWING PENS**

##### **1.2.3 COMPASSES**

##### **1.2.4 DRAWING BOARDS**

##### **1.2.5 T-SQUARES**

##### **1.2.6 SET SQUARES**

##### **1.2.7 PROTRACTORS**

##### **1.2.8 SCALES**

##### **1.2.9 FRENCH CURVES**

##### **1.2.10 TEMPLATES**

##### **1.2.11 DRAWING PINS AND OTHER FIXINGS**

##### **1.2.12 MINOR ITEMS OF EQUIPMENT**

##### **1.2.13 PRINTING PAPERS**

##### **1.2.14 TRACING PAPER, CLOTH AND FILM**

 **1.2.15 BACKING SHEETS**

 **1.2.16 DRAWING PAPERS**

 **1.2.17 CARTRIDGE**

 **1.2.18 HANDMADE AND MOULDMADE PAPERS**

 **1.2.19 PLASTIC-COATED CARD**

 **1.3 LETTERING**

 **1.3.1 PRINCIPLE OF LETTERING**

 **1.3.2 FREEHAND LETTERING**

 **1.3.3 TYPES OF LETTERS**

 **1.3.3.1 The Roman Alphabet**

 **1.3.3.2 Sans Serif Letters**

 **1.3.3.3 Inclined Lettering**

 **1.3.3.4 Script Lettering**

 **1.3.3.5 Stencil Lettering**

 **1.3.3.6 Guided Pen Lettering**

 **1.3.3.7 Pressure-Transfer Lettering**

 **1.4 LINEWORK AND DIMENSIONING**

 **1.4.1 TYPES OF LINES**

 **1.4.2 PENCIL DRAWING**



 **1.4.3 INKING - IN**

 **1.4.4 BASIC RULES OF DIMENSIONING**

 **1.4.4.1 Types of Dimensions**

 **1.4.4.2 Placement of Dimensions**

 **1.5 ENLARGEMENT AND REDUCTION OF LINE DRAWINGS** **1.6 GEOMETRICAL CONSTRUCTIONS** **1.6.1 LINES AND ANGLES** **1.6.1.1 To bisect a straight line AB** **1.6.1.2 To divide a straight line AB into a given number of equal parts** **1.6.1.3 To divide a straight line AB into any ratio** **1.6.1.4 To construct an angle of  $90^\circ$**  **1.6.1.5 To construct an angle of  $45^\circ$**  **1.6.1.6 To construct an angle of  $60^\circ$**  **1.6.1.7 To construct an angle of  $30^\circ$**  **1.6.1.8 To bisect any given angle** **1.6.1.9 To construct an angle SIMILAR to a given angle** **1.6.1.10 To draw a line PARALLEL to a given line** **1.6.2 TRIANGLES** **1.6.2.1 To construct an EQUILATERAL triangle** **1.6.2.2 To construct a triangle with given BASE ANGLES and ALTITUDE** **1.6.2.3 To inscribe a circle in a given triangle ABC** **1.6.2.4 To circumscribe a triangle ABC** **1.6.3 CIRCLES** **1.6.3.1 Basic CIRCLE-Constructions** **1.6.3.2 To draw a tangent to a point A on the circumference of a circle centre O**

-  **1.6.3.3 To draw an internal tangent to two circles of equal diameter**
-  **1.6.3.4 To find the centre of a given circle arc**
-  **1.6.3.5 To join two straight lines at RIGHT ANGLES to each other by an arc of given radius**

-  **1.6.3.6 To draw a curve of given radius joining two circles**

-  **1.6.3.7 To join two straight lines by two arcs of equal radius**

-  **1.6.4 BASIC ARCH CONSTRUCTIONS**

-  **2. ARCHITECTURAL DRAWING II**

-  **2.1 TYPES OF PROJECTIONS**

-  **2.2 ORTHOGRAPHIC PROJECTION**

-  **2.2.1 CONSTRUCTION OF ORTHOGRAPHIC PROJECTION**

-  **2.2.2 ELEVATIONS**

-  **2.2.3 PLANS AND SECTIONS**

-  **2.3 PICTORIAL DRAWING**

-  **2.3.1 AXONOMETRIC PROJECTION**

-  **2.3.2 ISOMETRIC PROJECTION**

-  **2.3.3 DIMETRIC PROJECTION**

-  **2.3.4 OBLIQUE PROJECTION**

-  **2.3.4.1 Length of Receding Lines**























-  **2.3.4.2 Construction of Oblique Drawings**

-  **2.3.4.3 Rules of Oblique Drawing**























-  **2.3.4.4 Scale of the Receding Lines**

-  **2.3.4.5 Direction of Receding Lines**

 **2.3.4.6 Position of Axes** **2.4 PERSPECTIVE DRAWING** **2.4.1 PERSPECTIVE TERMS** **2.4.2 PHENOMENA OF PERSPECTIVE DRAWING** **2.4.3 SYSTEMS OF PERSPECTIVE DRAWINGS** **2.4.4 METHODS OF PERSPECTIVE DRAWINGS** **2.4.5 TWO-POINT PERSPECTIVE** **2.4.6 ONE-POINT PERSPECTIVE** **2.5 SHADES AND SHADOWS** **2.5.1 THE USE OF SHADOWS** **2.5.2 SHADES AND SHADOWS** **2.5.3 THE CONVENTIONAL DIRECTION OF LIGHT** **2.5.4 THE 45° DIRECTION** **2.5.5 THE TRUE DIRECTION OF LIGHT** **2.5.6 SHADOWS OF SOLIDS** **2.5.7 PLANES OF SHADOW** **2.5.8 PRINCIPLES OF SHADOW-CASTING** **2.6 DRAWING PRACTICE** **2.6.1 DRAWING SHEETS** **2.6.1.1 Sizes and Folds** **2.6.1.2 Layout and Identification** **2.6.2 LEVELS** **2.6.3 REFERENCING**

























-  **2.6.4 ABBREVIATIONS**
-  **2.6.5 REPRESENTATION OF MATERIALS**
-  **2.6.6 GRAPHICAL SYMBOLS AND REPRESENTATION**
-  **2.6.7 HATCHING RULES**
-  **2.7 APPLICATION FOR BUILDING PERMIT**
  -  **2.7.1 PROCEDURE OF APPLYING FOR PERMISSION TO ERECT A BUILDING**
  -  **2.7.2 FORMULARS**
-  **4. CONTRACT PLANNING AND SITE ORGANISATION**
  -  **4.1 CONTRACT PLANNING**
    -  **4.1.1 BAR CHART**
    -  **4.1.2 NETWORK ANALYSIS**
    -  **4.1.3 THE OVERALL PROGRAMME**
      -  **4.1.3.1 Break down of job**
      -  **4.1.3.2 Quantities of work and time content**
      -  **4.1.3.3 Plant and Labour outputs**
      -  **4.1.3.4 Sequence and timing of operations**
      -  **4.1.3.5 The programme chart**
    -  **4.1.4 PLANNING CONSIDERATIONS**
      -  **4.1.4.1 Site conditions and access**
      -  **4.1.4.2 Nature of job**
      -  **4.1.4.3 Plant**
      -  **4.1.4.4 Scaffolding**























 **4.2 SITE ORGANIZATION** **4.2.1 PRELIMINARY WORK** **4.2.2 SITE PLANNING** **4.2.2.1 Period planning** **4.2.2.2 Weekly planning** **4.2.2.3 Progress control** **4.2.3 SITE LAYOUT** **5. FOUNDATIONS** **5.1 SOIL INVESTIGATIONS** **5.1.1 SITE EXPLORATION** **5.1.1.1 Trial holes** **5.1.1.2 Bore holes** **5.1.1.3 Sampling** **5.1.1.4 Tests** **5.1.1.5 Load or bearing test** **5.1.2 SOILS AND SOIL CHARACTERISTICS** **5.1.2.1 Rocks and soils** **5.1.2.2 Stresses and pressures** **5.2 EXCAVATIONS AND TIMBERING** **5.3 TYPES OF FOUNDATIONS** **5.3.1 CLASSIFICATION** **5.3.2 CHOICE OF FOUNDATION** **5.3.3 SPREAD FOUNDATIONS**























-  **5.3.3.1 Strip foundations**
-  **5.3.3.2 Deep strip foundations**
-  **5.3.3.3 Stepped foundations**
-  **5.3.3.4 Pad foundations**
-  **5.3.3.5 Raft foundations**
-  **5.3.4 PILE FOUNDATIONS**
  -  **5.3.4.1 Short bored pile foundations**
-  **5.3.5 PIER FOUNDATIONS**
-  **6. WALLS**
  -  **6.1 FUNCTION AND PROPERTIES OF WALLS**
  -  **6.2 THE BEHAVIOR OF THE WALL UNDER LOAD**
    -  **6.2.1 CALCULATION OF WALL THICKNESS**
  -  **6.3 TYPES OF WALLS**
  -  **6.4 STONEMWORK**
    -  **6.4.1 BUILDING STONES**
    -  **6.4.2 STONEMWORK THERMINOLOGY**
    -  **6.4.3 STONEMWORK CLASSIFICATION**
    -  **6.4.4 RUBBLE WALLING**
    -  **6.4.5 ASHLAR WALLING**
      -  **6.4.5.1 Rules for ashlar work**
  -  **6.5 BRICK WORK**
    -  **6.5.1 BRICKWORK TERMINOLOGY**
    -  **6.5.2 MANUFACTURE OF CLAY BRICKS**



 **6.5.2.1 Pressed Bricks** **6.5.2.2 Wire cut bricks** **6.5.2.3 Efflorescence** **6.5.3 BRICK CLASSIFICATION** **6.5.4 CALCIUM SILICATE BRICKS** **6.5.5 CONCRETE BRICKS** **6.5.6 MORTARS FOR BRICKWORK** **6.5.7 DAMPNES PENETRATION** **6.5.8 BRICKWORK BONDING** **6.5.8.1 Common bonds** **6.5.9 METRIC MODULAR BRICKWORK** **6.5.10 JUNCTIONS** **6.5.11 QUOINS OR EXTERNAL ANGLES** **6.5.12 PIERS** **6.5.12.1 Detached piers:** **6.5.12.2 Attached Piers (or Pilasters)** **6.5.12.3 Buttresses** **6.6 BLOCKWORK** **6.6.1 CLAY BLOCKS** **6.6.2 PRECAST CONCRETE BLOCKS** **6.6.3 AERATED CONCRETE BLOCKS** **6.7 CONCRETE WALLS** **6.7.1 GENERAL**

-  **6.7.1 GENERAL**
-  **6.7.2 FOREWORK**
-  **6.7.3 PLAIN MONOLITHIC CONCRETE WALL**
  -  **6.7.3.1 Dense concrete walls**
  -  **6.7.3.2 Light-weight aggregate**
  -  **6.7.3.3 No-fines concrete walls**
  -  **6.7.3.4 Thickness of plain concrete walls**
  -  **6.7.3.5 Shrinkage reinforcement**
-  **6.7.4 REINFORCED CONCRETE WALLS**
  -  **6.7.4.1 In-Situ Cast external walls**
  -  **6.7.4.2 Concrete Box Frames**
  -  **6.7.4.3 Large precast panel structure**
-  **6.8 OPENINGS IN WALLS**
  -  **6.8.1 HEAD**
    -  **6.8.1.1 Lintels**
    -  **6.8.1.2 Arches**
  -  **6.8.2 JAMBS**
  -  **6.8.3 SILLS AND THRESHOLDS**
    -  **6.8.3.1 Sills**
    -  **6.8.3.2 Thresholds**
-  **7. FLOORS**
  -  **7.1 GENERAL**
  -  **7.2 SOLID GROUND FLOORS**
    - 

-  **7.2.1 SITE CONCRETE**
-  **7.2.2 HARDCORE**
-  **7.2.3 WATERPROOF MEMBRANE**
-  **7.3 SUSPENDED TIMBER GROUND FLOOR**
  -  **7.3.1 BUILDING REGULATIONS**
  -  **7.3.2 LAY OUT**
-  **7.4 UPPER FLOORS**
  -  **7.4.1 TYPES OF UPPER FLOORS**
  -  **7.4.2 STRUCTURE OF UPPER FLOORS**
  -  **7.4.3 SUSPENDED TIMBER UPPER FLOORS**
    -  **7.4.3.1 Floor Joists**
    -  **7.4.3.2 End Support of Floor Joists**
    -  **7.4.3.3 Trimming**
  -  **7.4.4 REINFORCED CONCRETE UPPER FLOORS**
    -  **7.4.4.1 Monolithic Reinforced Concrete Upper Floors**
    -  **7.4.4.2 Precast Concrete Upper Floors**
    -  **7.4.4.3 Hollow Block and Waffle Floors**
-  **7.5 FLOOR FINISHES**
  -  **7.5.1 JOINTLESS FLOOR FINISHES**
    -  **7.5.1.1 The most common of these is the Cement/Sand Screed**
    -  **7.5.1.2 Granolithic Concrete Finishes**
    -  **7.5.1.3 Terazzo**
  -  **7.5.2 SLAB FLOORS FINISEHES**

-  **7.5.3 SHEET FLOOR FINISHES**
-  **7.5.4 WOOD FLOOR FINISHES**
-  **8. OPEN FIREPLACES, CHIMNEYS AND FLUES**
  -  **8.1 FUNCTION OF FIREPLACES AND FLUES**
  -  **8.2 PRINCIPLES OF FIREPLACE DESIGN**
    -  **8.2.1 TRADITIONAL OPEN FIREPLACE**
    -  **8.2.2 IMPROVED SOLID FUEL APPLIANCES**
  -  **8.3 PRINCIPLES OF FLUE DESIGN**
  -  **8.4 CONSTRUCTION OF FLUE DESIGN**
    -  **8.4.1 NON-CONVECTOR OPEN FIRES**
    -  **8.4.2 CONVECTOR OPEN FIRES**
  -  **8.5 CONSTRUCTION OF CHIMNEYS**
-  **9. ROOFS**
  -  **9.1 FUNCTIONAL REQUIREMENTS**
    -  **9.1.1 STRENGTH AND STABILITY**
    -  **9.1.2 WEATHER RESISTANCE**
    -  **9.1.3 THERMAL INSULATION**
    -  **9.1.4 FIRE RESISTANCE**
    -  **9.1.5 SOUND INSULATION**
  -  **9.2 TYPES OF ROOF STRUCTURES**
    -  **9.2.1 FLAT AND PITCHED ROOFS**
    -  **9.2.2 STRUCTURE OF THE ROOF**
    -  **9.2.3 LONG AND SHORT SPAN ROOFS**

 **9.2 LONG AND SHORT STAIRS** **9.3 FLAT ROOFS** **9.3.1 PHYSICAL AND STRUCTURAL PROBLEMS** **9.3.2 STRUCTURE OF A FLAT ROOF** **9.3.3 THERMAL INSULATION MATERIAL** **9.3.4 SINGLE AND DOUBLE FLAT ROOF CONSTRUCTION** **9.3.5 PARAPET WALLS** **9.4 PITCHED ROOFS** **9.4.1 SHAPES OF PITCHED ROOFS IN TIMBER** **9.4.2 TERMS** **9.4.3 TYPES OF PITCHED ROOFS IN TIMBER (STRUCTURES)** **9.4.3.1 Mono-(single) pitched Roof** **9.4.3.2 Lean - to Roof** **9.4.3.3 Couple Roof** **9.4.3.4 Close couple Hoof** **9.4.3.5 Collar Roof** **9.4.3.6 Double or Purlin Roof** **9.4.3.7 Tripple or Trussed Roofs** **9.4.3.8 Trussed Rafters** **9.4.3.9 Hipped Roofs** **9.4.4 VALLEY** **9.4.5 EAVES TREATMENT** **9.4.6 OPENINGS IN TIMBER ROOFS** **9.5 ROOF COVERINGS**

**9.5 ROOF COVERINGS** **9.5.1 FUNCTION OF ROOF COVERINGS** **9.5.2 TYPES OF ROOF COVERINGS** **9.5.3 SUBSTRUCTURES** **9.5.4 CHOICE OF ROOF COVERINGS** **9.5.5 MATERIALS AND COVERING METHODS** **10. FRAMED STRUCTURES** **10.1 STRUCTURAL CONCEPT** **10.2 FUNCTIONAL REQUIREMENTS** **10.3 STRUCTURAL MATERIALS** **10.4 LAYOUT OF FRAMES** **10.5 BUILDING FRAMES** **10.5.1 FUNCTIONS OF BUILDING FRAME MEMBERS** **10.5.2 REINFORCED CONCRETE FRAMES** **10.5.2.1 Reinforced Concrete Beams** **10.5.2.2 Reinforced Concrete Columns** **10.5.2.3 Reinforced Concrete Slabs** **10.5.3 PRECAST CONCRETE FRAMES** **10.5.3.1 Methods of Connections** **10.5.4 STRUCTURAL STEELWORK FRAMES** **10.5.4.1 Structural Steel Frames** **10.5.4.2 Castellated Universal Sections** **10.5.4.3 Connections**



#### **10.5.4.4 Structural Steel Connections**



#### **10.5.4.5 Frame Erection**



#### **10.5.4.6 Fire Protection of Steelwork**



### **10.5.5 TIMBER FRAMES**



#### **10.5.5.1 Columns and Beams**



#### **10.5.5.2 Connections**



#### **10.5.5.3 Building frames in timber**



#### **10.5.5.4 Prefabrication**



### **10.6 PORTAL FRAMES**



#### **10.6.1 THEORY**



#### **10.6.2 CONCRETE PORTAL FRAMES**



#### **10.6.3 STEEL PORTAL FRAMES**



#### **10.6.4 TIMBER PORTAL FRAMES**



## **11. PROTECTION OF BUILDINGS**



### **11.1 EXCLUSION OF WATER**



#### **11.1.1 PRECIPITATION**



##### **11.1.1.1 Roof Drainage**



##### **11.1.1.2 Flooding**



##### **11.1.1.3 Drought**



#### **11.1.2 DAMP RISING AND MOISTURE MIGRATION**



























#### **11.1.3 CONDENSATION**



### **11.2 THERMAL INSULATION**



#### **11.2.1 DEFINITION**

-  **11.2.1 DEFINITION**
-  **11.2.2 INSULATING MATERIALS**
-  **11.3 SOUND INSULATION**
  -  **11.3.1 DEFINITION**
  -  **11.3.2 SOUND INSULATION**
  -  **11.3.3 EXTERNAL NOISE**
-  **11.4 FIRE PROTECTION**
  -  **11.4.1 STRUCTURAL FIRE PROTECTION**
    -  **11.4.1.1 Fire Load**
    -  **11.4.1.2 Fire Resistance of Material**
    -  **11.4.1.3 Appropriate Types of Construction**
-  **12. FINISHING & FINISHES**
  -  **12.1 EXTERNAL WALL FINISHES**
    -  **12.1.1 EXTERNAL RENDERING**
    -  **12.1.2 CONCRETE FINISHES**
    -  **12.1.3 CLADDING**
      -  **12.1.3.1 CLADDINGS FIXED TO A STRUCTURAL BACKING**
      -  **12.1.3.2 CLADDINGS TO FRAMED STRUCTURES**
    -  **12.1.4 EXTERNAL PAINTS AND FINISHES**
  -  **12.2 INTERNAL WALL FINISHES**
    -  **12.2.1 PLASTERING**
    -  **12.2.2 OTHER INTERNAL WALL FINISHES**
    -  **12.2.3 PAINTING**
  -  **12.3 CEILING FINISHES**



 **12.3 CEILING FINISHES** **13. STAIRS** **13.1 INTRODUCTION** **13.2 DEFINITION OF TERMS** **13.3 TYPES OF STAIRS** **13.4 DESIGN OF STAIRS** **13.4.1 RISE - TREAD - PROPORTION** **13.4.2 SLOPE OR PITCH** **13.4.3 LANDINGS** **13.4.4 WIDTH** **13.4.5 WALKING LINE** **13.5 CONSTRUCTION OF STAIRS** **13.5.1 BRICK STAIRS** **13.5.2 STONE STAIRS** **13.5.3 CONCRETE STAIRS** **13.5.3.1 In Situ Cast R.C. Stairs** **13.5.3.2 Precast Concrete Stairs** **13.5.4 TIMBER STAIRS** **13.5.5 METAL STAIRS** **13.6 MISCELLANEOUS** **13.6.1 BALUSTRADES/HANDRAILS** **13.6.2 'SAMBA' STAIR, LADDERS, DISAPPEAR STAIRS, RAMPS** **13.6.3 ESCALATORS** **14 DOORS & WINDOWS**

 **14. DOORS & WINDOWS** **14.1 DOORS** **14.1.1 EXTERNAL DOORS** **14.1.2 INTERNAL DOORS** **14.1.3 PURPOSE MADE DOORS** **14.1.4 METHODS OF CONSTRUCTION** **14.1.4.1 Door terminology** **14.1.4.2 Panelled and glazed wood doors** **14.1.4.3 Flush doors** **14.1.4.4 Fire-check flush doors** **14.1.4.5 Matchboarded doors** **14.1.5 FRAMES AND LININGS** **14.1.5.1 Timber Door Frames** **14.1.5.2 Metal door frames** **14.1.5.3 Door linings** **14.1.6 SPECIAL DOORS** **14.2 WINDOWS, GLASS & GLAZING** **14.2.1 PRIMARY FUNCTIONS OF WINDOWS** **14.2.2 BUILDING REGULATIONS** **14.2.3 TRADITIONAL CASEMENT WINDOWS** **14.2.4 STANDARD WOOD CASEMENT WINDOWS** **14.2.5 STEEL CASEMENT WINDOWS** **14.2.6 BAY WINDOWS**



## 14.2.7 SLIDING SASH WINDOWS

 14.2.7.1 Vertical sliding windows (also called double hung sash windows)

 14.2.7.2 Horizontal sliding windows

 14.2.8 PIVOT WINDOWS

 14.2.9 LOUVRES

 14.2.10 GLASS AND GLAZING

 14.2.10.1 Glass

 14.2.10.2 Glazing

 14.2.11 MOSQUITO SCREENING (FLY SCREENS)

 14.2.12 SUN-BREAKERS

 14.3 IRON MONGERY

 14.3.1 HINGES

 14.3.2 LOCKS AND LATCHES

 14.3.3 MISCELLANEOUS

## 13. STAIRS

### REFERENCES:

1. Jack Stroud Foster, MITCHELL'S BUILDING CONSTRUCTION 'Structure and Fabric', Part 1, 2
2. R. Chudley, 'Construction technology', Vol. 2,3
3. Mc. Kay, 'Building Construction 'Metric', Vol. 1,3

4. R.L. Fullerton, 'Building' Construction in Warm Climates', Vol. 2,3
5. R. Barry, 'The Construction of Buildings'
6. Brian Bonghton, 'Reinforced Concrete Detailer's Manual'
7. E. Neuffert, 'Architect's Data'

### 13.1 INTRODUCTION

- A STAIR is a number of at least 3 STEPS leading from one level to another, in order to provide means of movement between different levels in and attached to buildings and for pedestrian walkways.

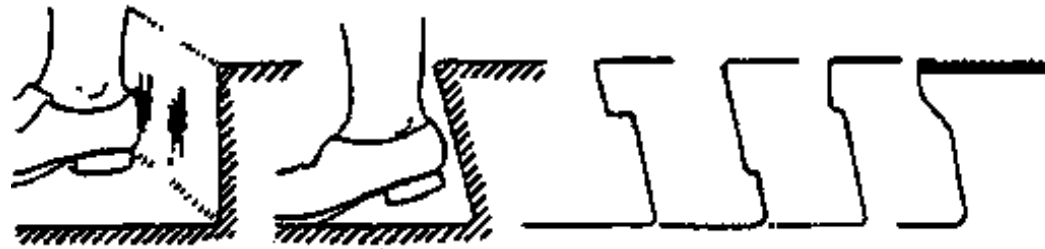

- To make STAIRS usable without danger, they have to be designed and constructed carefully:
- The type of STAIRS has to be chosen
  - All measurements have to be calculated
  - - if necessary - the tapering of the steps has to be designed etc.

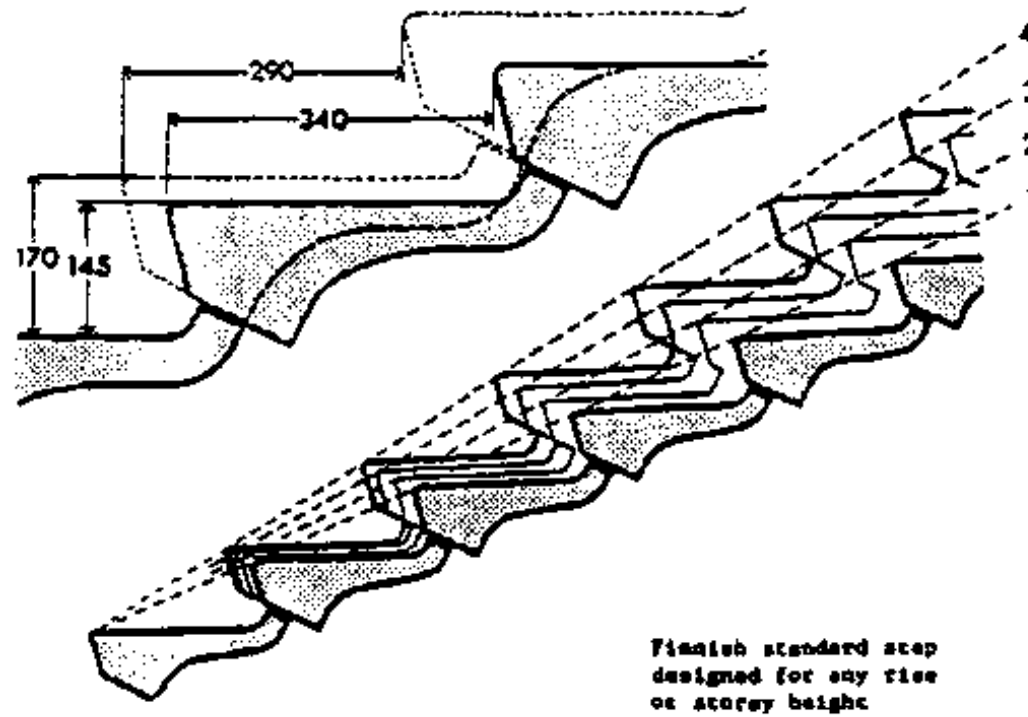

For each 1 mm increase in height of step the tread is reduced by 2 mm as follows:

h	145	146	147	148	149	150	151	152	153	154	155	156	157
b	340	338	336	334	332	330	328	326	324	322	320	318	316
h	158	159	160	161	162	163	164	165	166	167	168	169	170
b	314	312	310	308	306	304	302	300	298	296	294	292	290

- For the construction of STAIRS different suitable materials can be used, such as

- Stone (both natural and artificial)
- Concrete
- Timber

- **Steel**

- Often you may find different materials combined at the same STAIR (i.e. Steel and Timber or reinforced concrete and Steel)
- The BALLUSTRADE is a part of the STAIR, which is installed for the purpose of SAFETY of the STAIR. Beside that, ballustrades may help to beautify the stair case.

## 13.2 DEFINITION OF TERMS

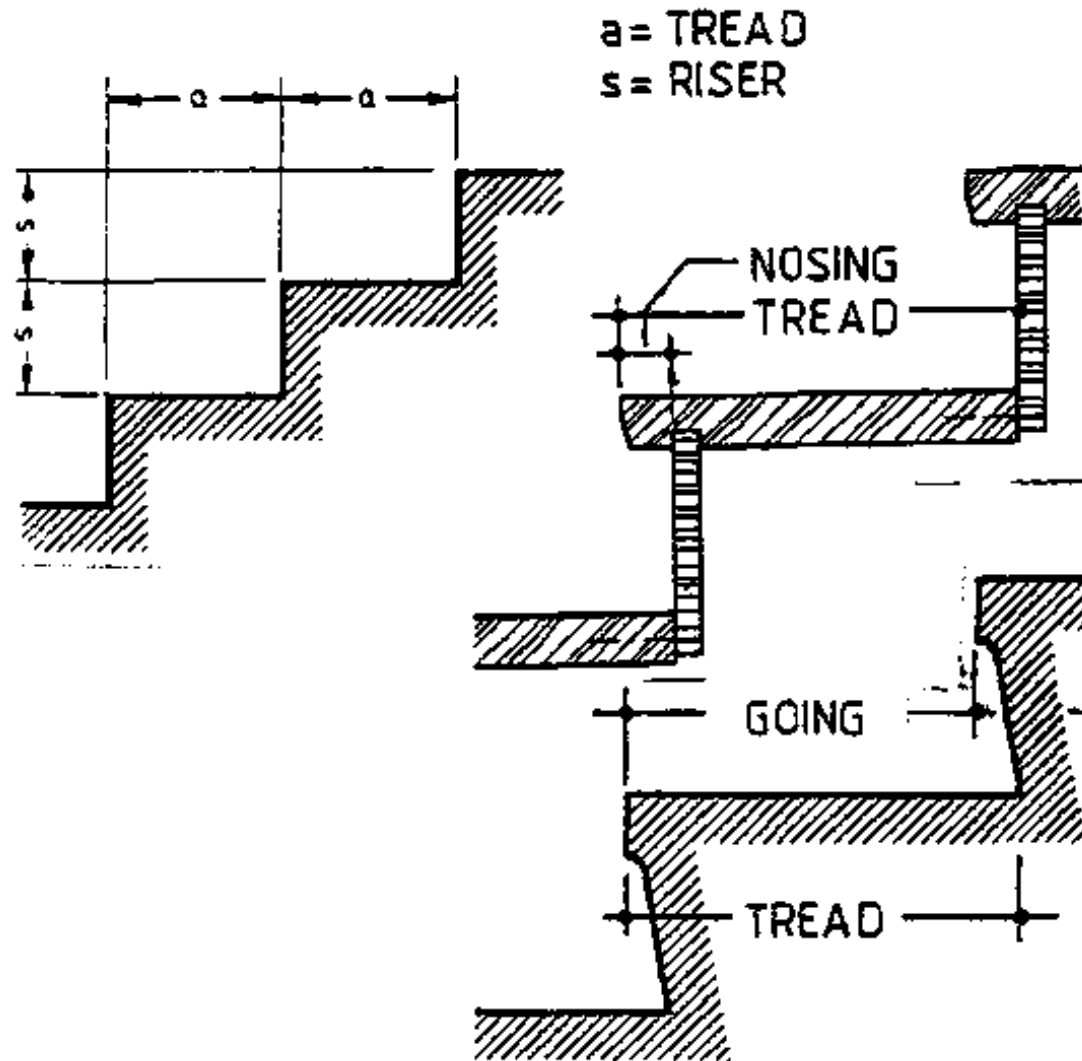

- **STEP:** is a short horizontal surface for the foot to ease ascent from one level to another.

It consists of an horizontal element called **TREAD** and a vertical element called **RISER**.

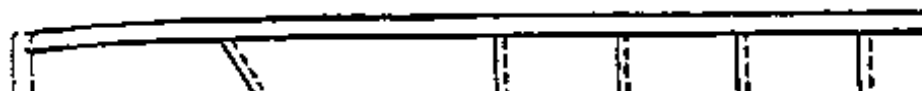

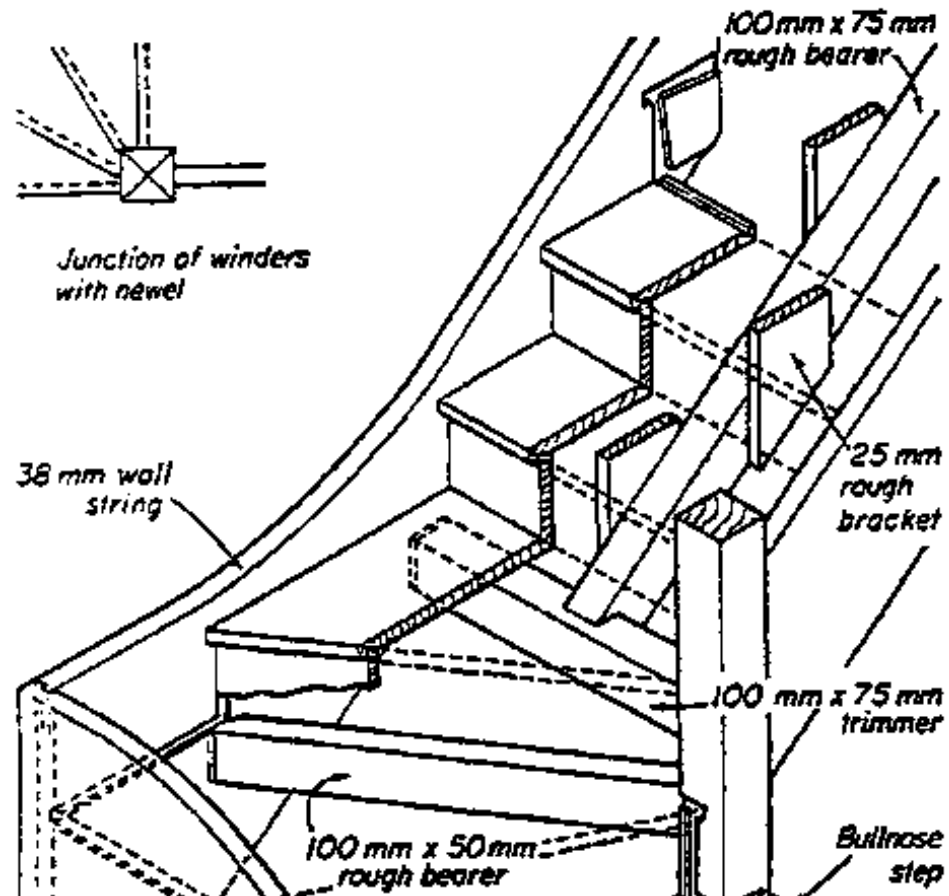
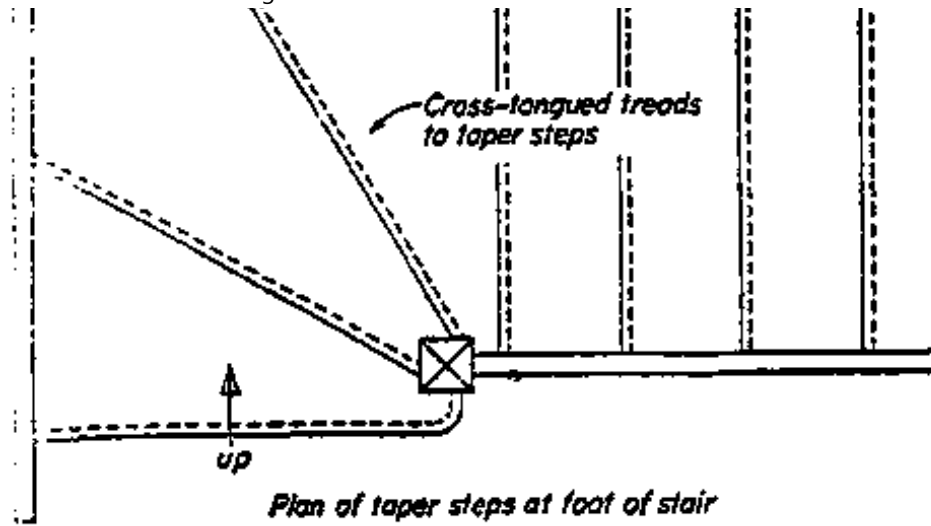



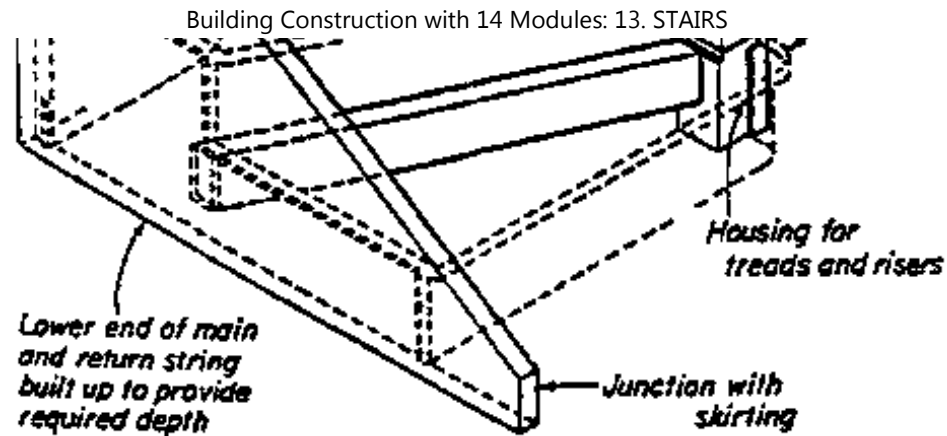

The external junction of the tread and riser, or the front edge of the tread (if projects beyond the face of the riser) is called NOSING. Special names are given to steps according to their shape on plan:

- **FLIERS** are normal parallel steps, uniform in width and rectangular on plan.
- **TAPERED STEPS** are steps of which the nosing is not parallel to that of the step above it. There are two forms of tapered steps:

a) **WINDERS** - are tapered steps the back and the front edge of which radiate from the centre on a newel post.

b) **DANCING STEPS (or BALANCED STEPS)** - are tapered steps the edges of which do not radiate from a common centre. They are built in a way that their narrow end is little narrower than the parallel tread of the straight part of the STAIRS. They are therefore more comfortable to walk on, than a WINDER, in which the nosing radiate from a common centre.

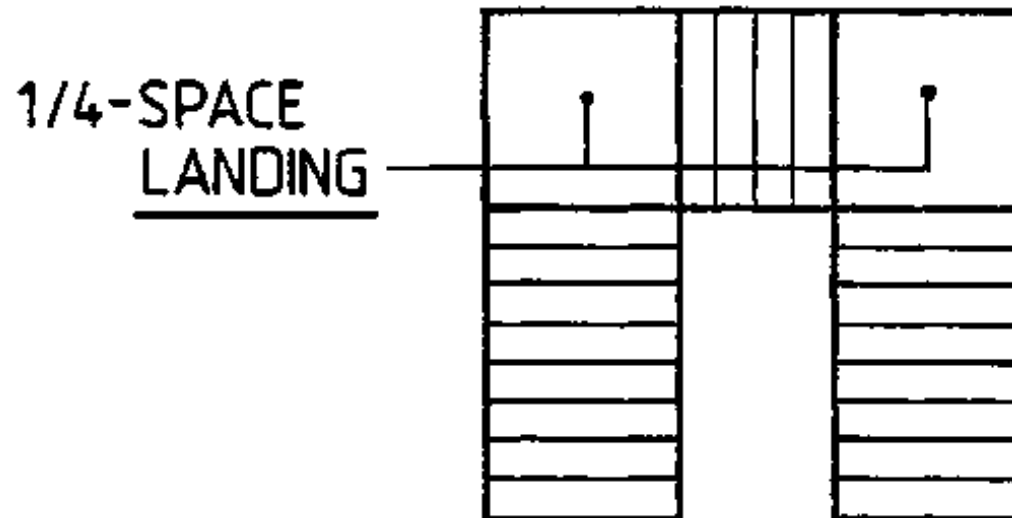
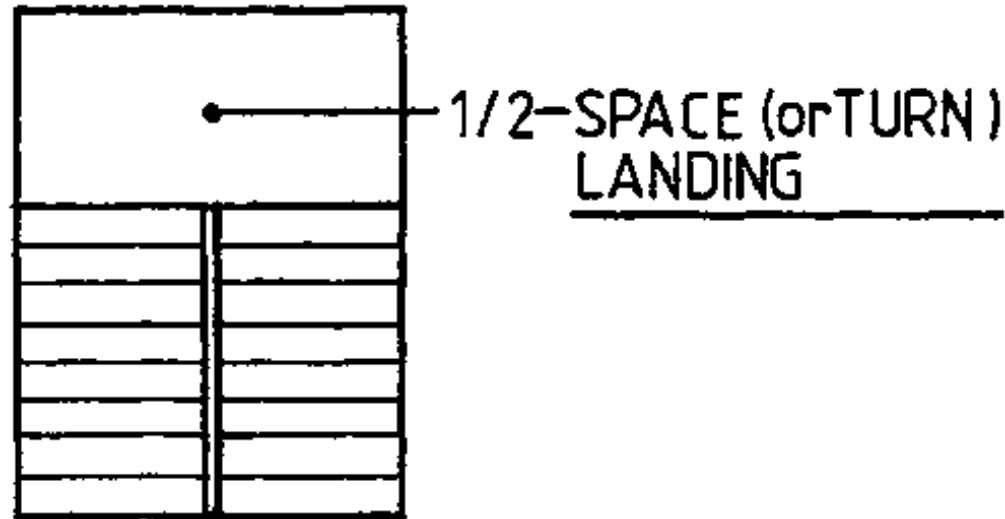

- **FLIGHT:** A series of steps between FLOORS and LANDINGS.
- **LANDING:** A platform between two flights. A landing serves as a rest between flights and also as a means to turn a STAIR.

- A **HALF-SPACE-LANDING** extends across the width of two flights and on it a complete half turn is made.
- A **QUARTER-SPACE-LANDING** is one on which a quarter turn only is made from the end of one flight to the beginning of the next.

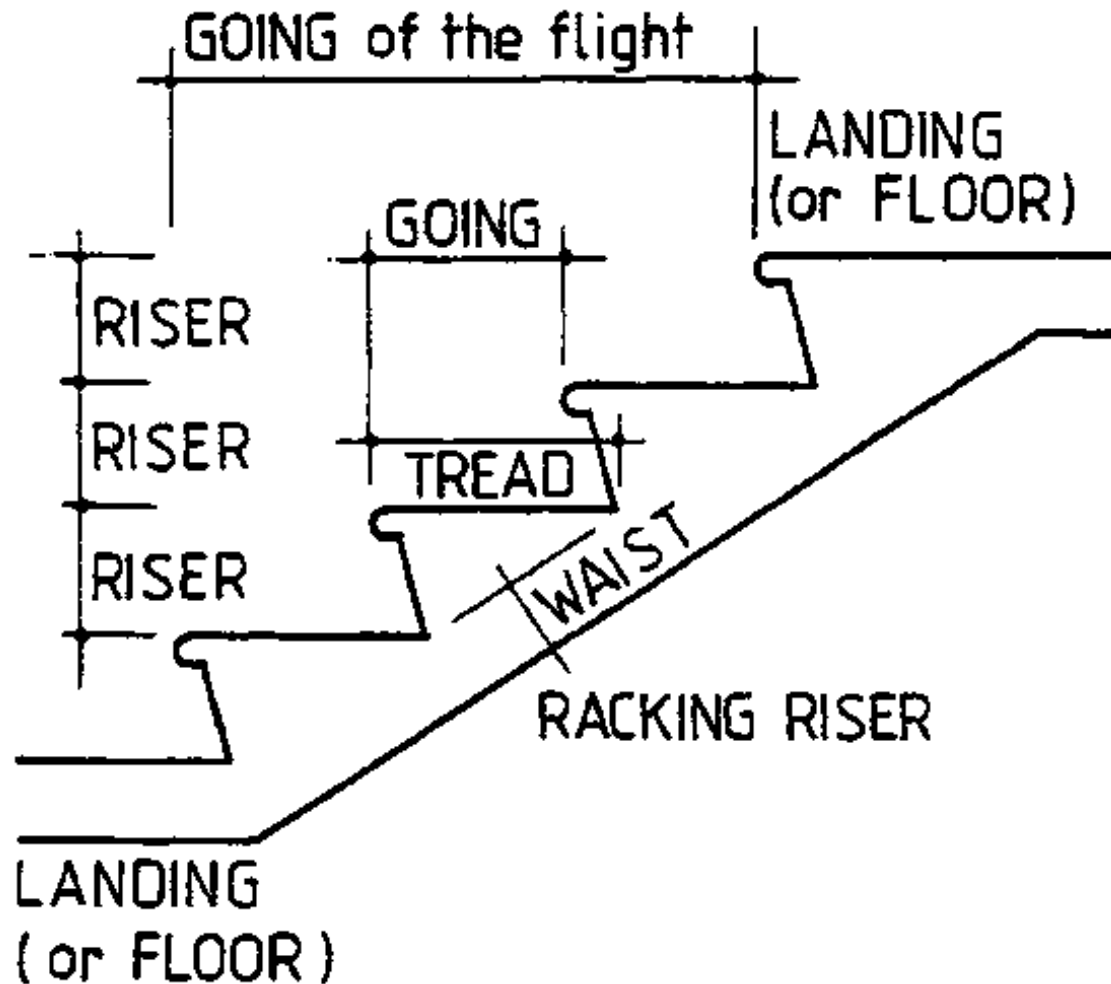

- **RISE of a STEP** is the vertical distance between the upper surface of 2 consecutive treads and the **RISE of a FLIGHT** is the total height between the floors or landings it connects

OF A FLIGHT IS THE TOTAL HEIGHT BETWEEN THE FLOORS OR LANDINGS IT CONNECTS.

- **RACKING RISER:** A riser which is not vertical and overhangs the tread below, to give more foothold. The tread is bigger than its going.
- **GOING (or RUN)** of a step is the horizontal distance between the nosings or risers of 2 consecutive steps, and of a flight, the horizontal distance between the top and bottom nosings.
- **LINE OF NOSINGS:** Is an imaginary inclined line touching the nosings of a flight.
- **PITCH or slope:** The angle made between the line of nosings and the line of the floor or landing.
- **WALKING LINE:** The average position taking up by a person ascending or descending the stair and generally taken to be 450 mm from the centre of the handrail.



If stairs are narrow or curved,  
distance of walk line from outer  
nosing is 350-400 mm (14-16 in)



If stairs are wide and straight,  
distance of walk line from  
handrail is 550 mm (22 in)

### WALKING LINE

- **HEADROOM:** The vertical distance between the line of nosings and any obstruction over the stair, usually the soffit of an upper flight or the lower edge of a floor or landing.

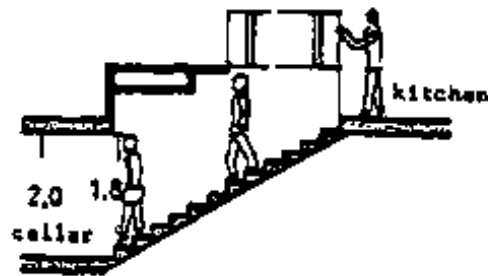
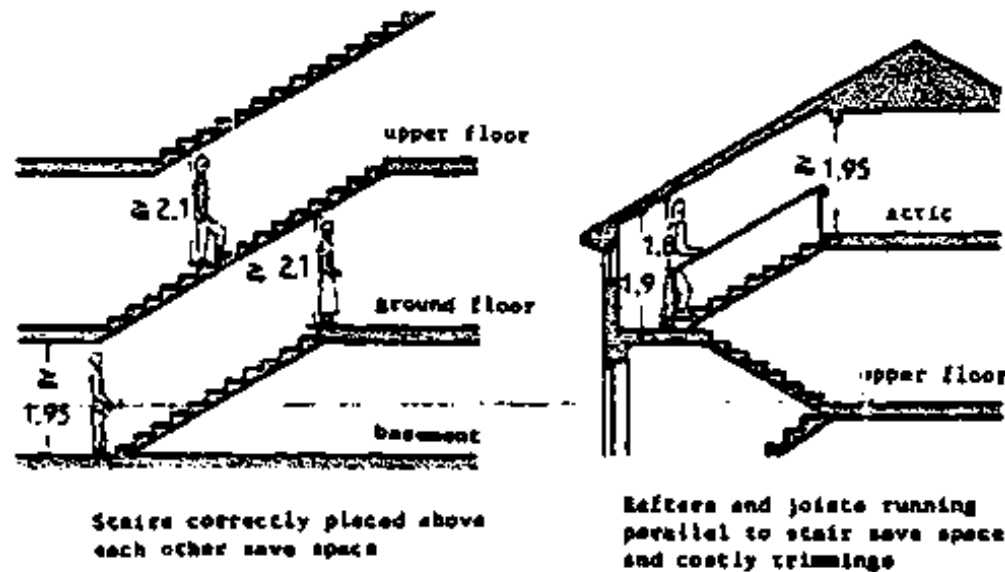

Avoid trap doors and necks to cellars, but combination shown is good and safe

## HEADROOM

- **BALLUSTRADE**: Provides protection on the open side or sides of a stair; it may be either solid or open. An open balustrade consists of vertical bars called **BALUSTERS** supporting and **HANDRAIL**.

- **STRING** or **STRINGER**: An inclined member which, if fixed to a wall, may act simply as a housing for the treads as in a timber stairs. If it is not fixed to a wall it then acts as an inclined beam supporting the

steps as in a timber stairs. If it is not fixed to a wall, it then acts as an inclined beam supporting the steps.

- **STAIRCASE:** This term is applied to a stair together with the part of the building, which encloses it, although it is also commonly used in reference only to the complete assembly of flights, landings and balustrades in a single stair.

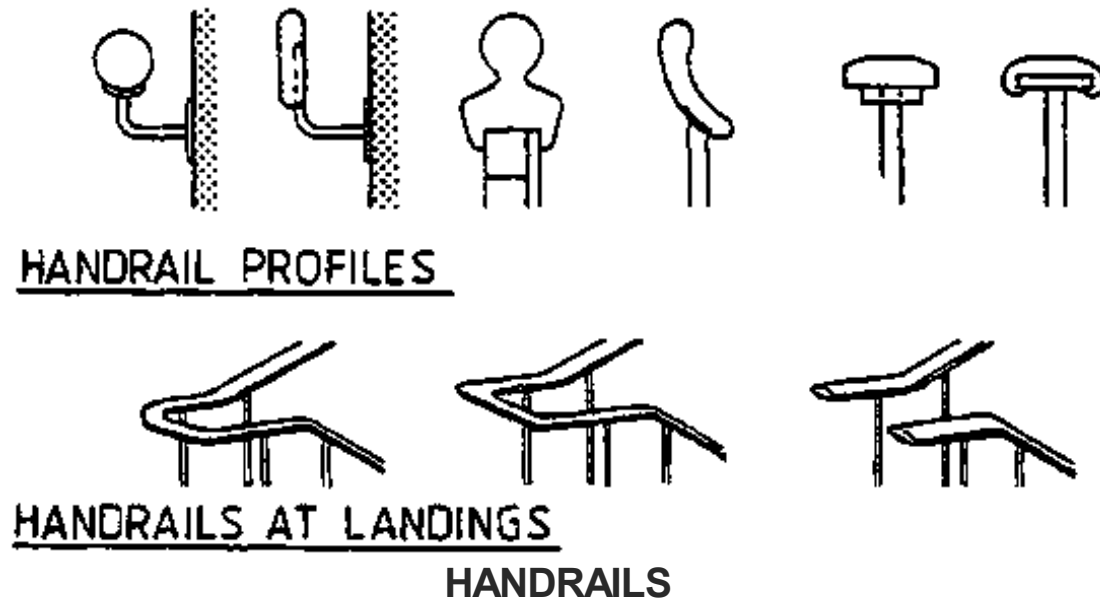

### 13.3 TYPES OF STAIRS

- The form of a stair depends on the size of the STAIRCASE. Also practical or aesthetical reasons might be taken in to consideration for the choice, of the stair.

- Stairs are classified according

to:

**the number of flights.**

the number of flights,

the plan form,

the kind of landings,

and whether they are

**RIGHT - HAND or**

**LEFT - HAND - STAIRS.**

• **According to the number of flights, stairs may be classified as:**

**a one-flight stairs**

**b two-flight stairs**

**c multi-flight stairs**

**a: one-flight stairs lead without landing from one floor-level to the other**

**b: two-flight-stairs consist of two flights and a landing in between.**

**c in case tie difference in level between two floors increases, more than two flights with landings in between might become necessary.**



**one-flight stairs**



two-flight-stairs

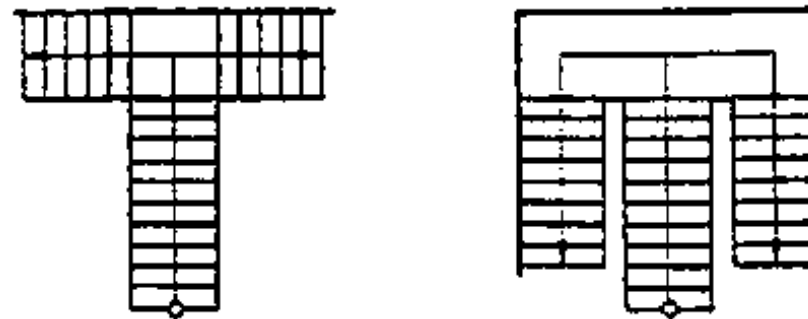
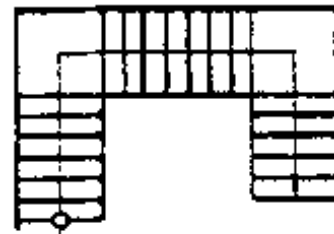

multi-flight stairs

In multi-story, buildings, two-or multi-flight stairs are common, in order to make ascent and descent more comfortable.

• According to the plan form stairs can be classified as:



**stairs with straight flights**  
**stairs with bent or circular (winding) flights**  
**stairs with straight and winding flights.**



straight flight

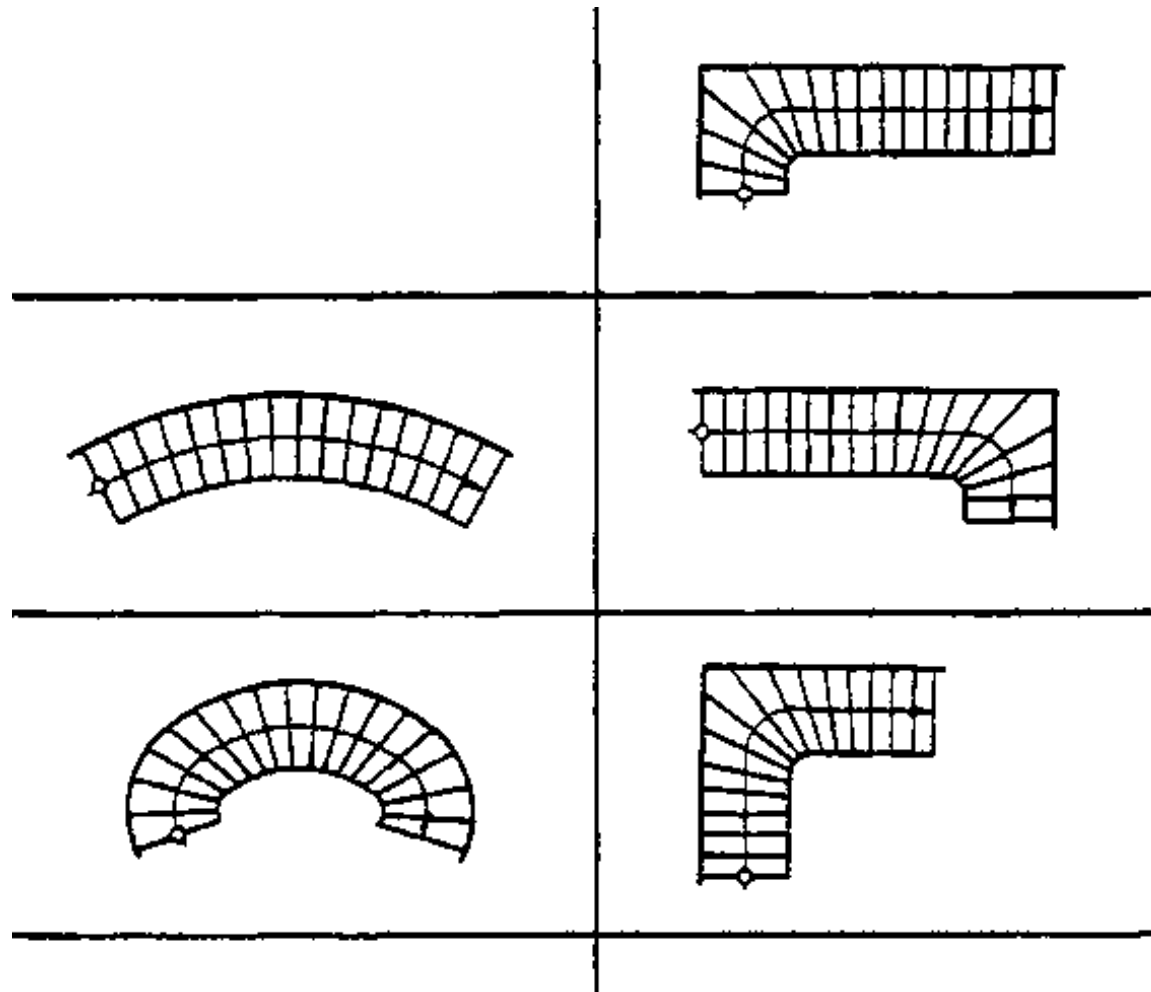

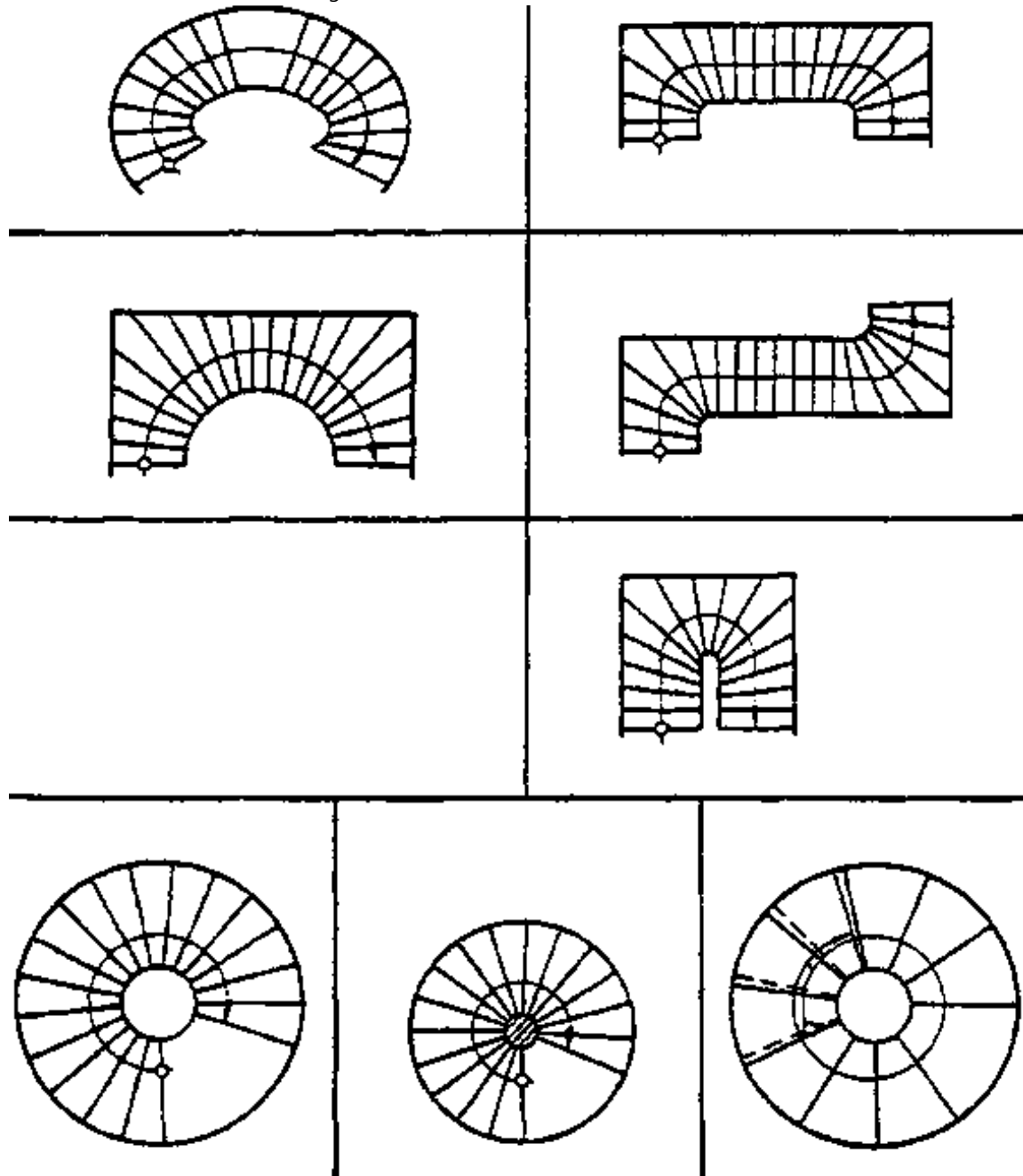

bent or winded, straight &. winded flights

• According to the kind of landing stairs can be classified as:

According to the kind of landing stairs can be classified as:

stairs with a half-space-landing and  
stairs with a quarter-space-landing (ref.13.2)

- The term RIGHT-Hand or LEFT-Hand-Stair

depends on the open side of the stair:

Ascending the stair, if you have to hold the handrail with your right hand, it is called a **RIGHT HAND STAIR**.

In case of a **LEFT HAND STAIR** you will find the hand rail on your left hand side. Tapered or spiral Stairs are called **RIGHT-HAND-STAIRS** if the walking direction turns to the right (clockwise) from the straight. Left-hand-stairs turn to the left.

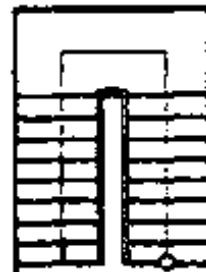

**LEFT HAND STAIR**

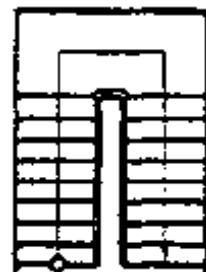

**RIGHT HAND STAIR**

### 13.4 DESIGN OF STAIRS

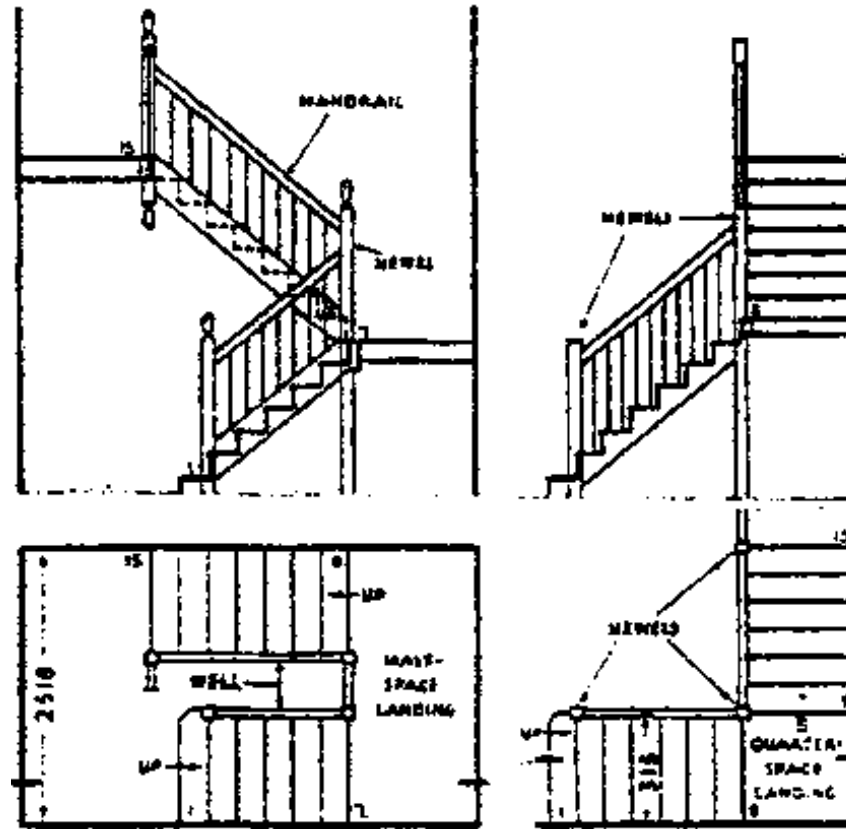

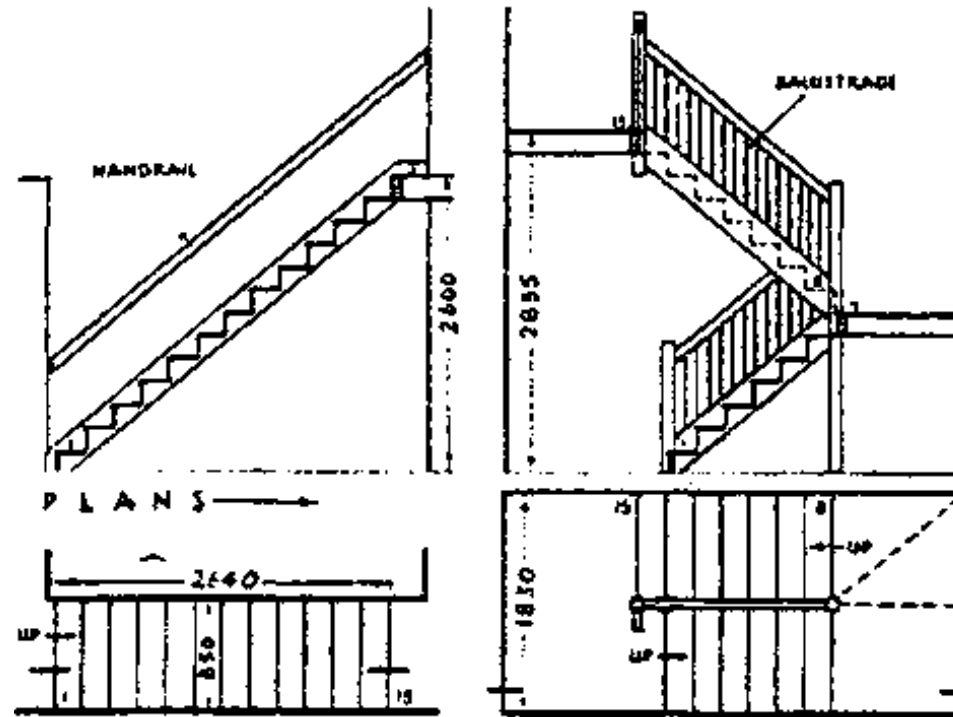

- Apart from economic factors, a number of other related to **COMFORT** and **SAFETY** in use must be considered in the design of a **STAIR**. These are concerned with ease of ascent and decent and with protection and support at the sides.
- The dimensions of a **STAIR** will depend on the **VOLUME** of **TRAFFIC** it must carry and also on the **NATURE** of **FURNITURE** and **EQUIPMENT**, which is likely to be carried on it.
- The **WIDTH** of the flights and landings are important, particularly at the turns. The **DIMENSIONS** of the **TREADS** and **RISERS** should be proportioned to give easy ascent and decent.
- **STAIRS** to be placed correctly within the building.
- **MEANS (...)**

- **Unobstructed egress facilities from big buildings to be provided by. ESCAPE ROUTES (I.e. stairs, corridors, balconies and exits)**

**These should be protected by FIRE-RESISTING ENCLOSURES with fire-resisting doors to prevent smoke and fire spread.**

- **Tall residential blocks may be planned round a single fire-resistant staircase with access by a common cross ventilated lobby.**
- **Office-shop-, factory- and public buildings have special regulations; number, width and position of stairways are related to area and height of these buildings, number of users, and fire risk caused by various activities carried out in them.**

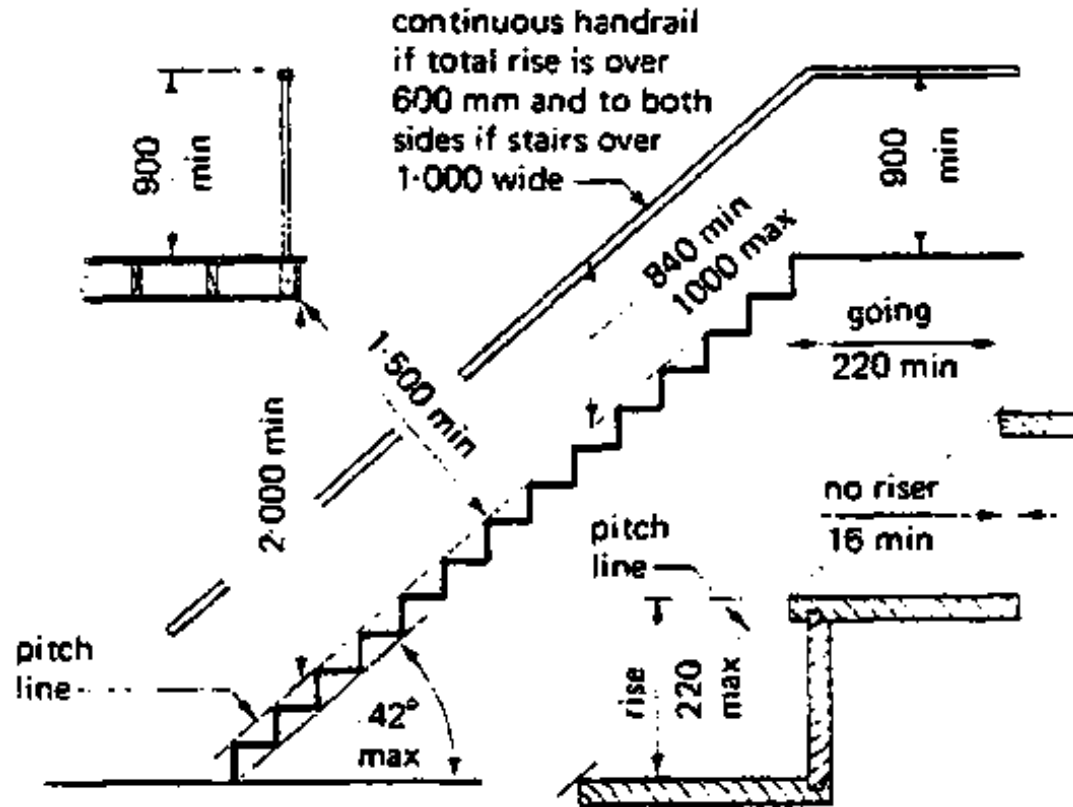

sum of going + twice rise = 550 min. to 700 max.  
in any flight all risers of equal height and all  
goings of equal width

### Private Stairways

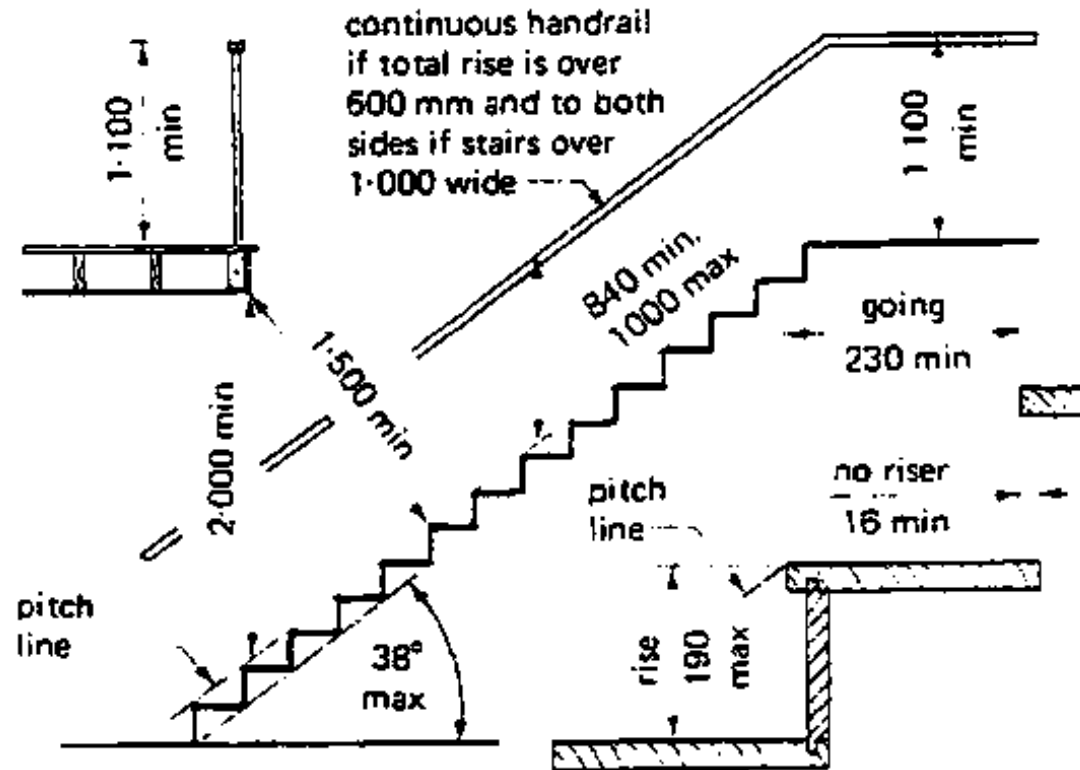

sum of going + twice rise = 550 min. to 700 max.  
maximum number of risers in any flight = 16  
in any flight all risers of equal height and all  
goings of equal width.

### Common Stairways

#### 13.4.1 RISE - TREAD - PROPORTION

- Comfort in use of a stair depends largely upon the relative dimensions of the rise and going of the steps.

Rules for determining the proportion are based to some extent upon the assumptions that about twice



**as much effort is required to ascend than to walk horizontally.**

- The average pace of a person walking horizontally measures up to 70 cm. Ascending, the pace will be reduced to 61- up to 65 cm.
- Important for a comfortable and safe use of a stair is the rise.
- Ascending a stair, one has to step over one tread and two rises.
- All the above mentioned facts result in certain rules which are the base for a good rise-tread proportion.

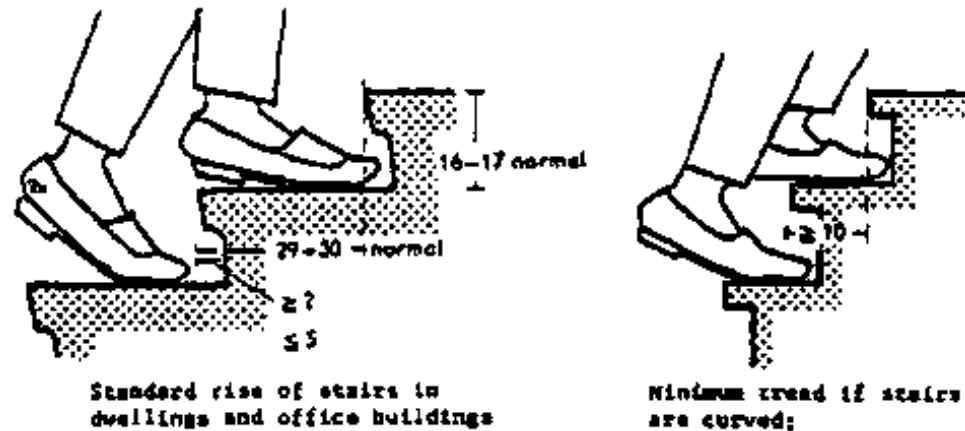

Common rises for different types of stairs	
stair	rise
garden-and open air stairs	12 to 16 cm
stairs in Public Buildings	16 to 18 cm
stairs in flats and dwellings	17 to 19 cm

stair of minor importance

up to 21 cm

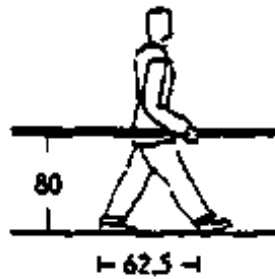

Standard pace of an adult on a horizontal plane

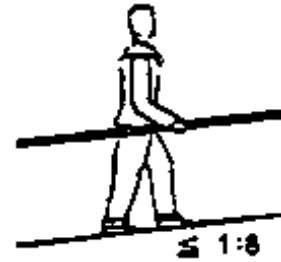

On a ramp the pace is reduced proportionately. Desirable slope 1:10-1:8

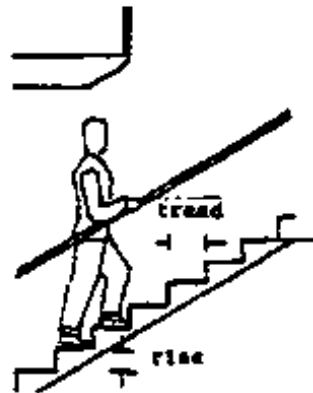

Optimum rise is 20+10 = 625 mm (approx. 23 in; U.K. Bldg Regs 1965)

height of handrail above edge of step  
= 875 mm (33 in)  
(U.K. Bldg Regs: 2 ft 9 in above pitch lines)



Ladder stairs with handrails up to 210 x 150 mm (8.4 x 6 in), without handrails up to 250 x 100 mm (10 x 4 in)

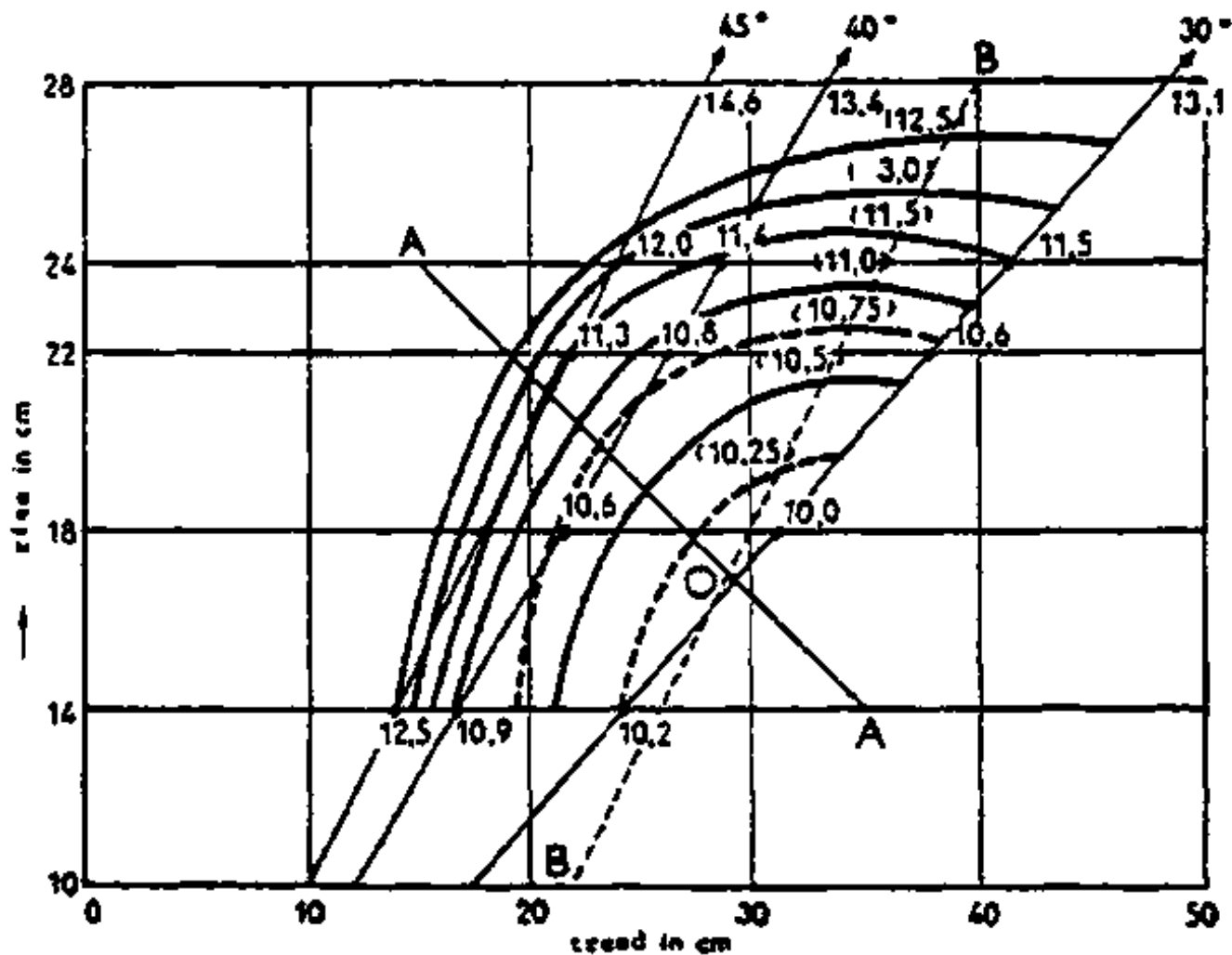

Relationship between energy required and form of stair (after Dr W.Doll & Dr G.Lehmann)

Figures at the left show the rises, those underneath the treads (both in cm). The figures in the curves show energy in calories per mkg climb-effort. The figures above indicate some pitch angles of stairways. The curves connect all points of equal energy consumption. Therefore all stairs with rise-tread proportions on one of these curves are of equal energy consumption.

Line A + A equals the formula  $2r + 1b = 620 \text{ mm (27 in)}$

Line 1 - 3 equals the formula .....  $b = 120 \text{ mm (4.8 in)}$

## RISE-TREAD-PROPORTION

### RULES:

#### I PACE - RULE:

2 Rises (a) + 1 tread(b) = 61 cm to 65 cm (average 63 cm)

-  $2a + b = 63 \text{ cm}$

$b = 63 \text{ cm} - 2a$

#### Example:

The rise-tread-proportion for a stair in a flat has to be calculated:

- rise a - (ref.Table) = 17-19 cm

- difference of floor levels - h - = 2,75 m

- Number of rises - h - = always an integer number.

$$n = \frac{h}{\text{averagea}} = \frac{2,75}{18} = 18,33 \text{ cm}$$

Tread - b- to be expressed in round cm numbers:

#### I Pace-Rule:

**b- 63 cm - 2.18,33 = 26,34 cm**

**chosen:  $b = 26$  cm**

**proportion:  $15 \times 18,33/26$**

### **II Safety-Rule:**

**$b = 46$  cm -  $18,33 = 27,67$  cm**

**chosen:  $b = 28$  cm**

**proportion  $15 \times 18,33/28$**

### **III Comfort-Rule:**

**$b = 12$  cm +  $13,33 = 30,33$  cm**

**chosen:  $b = 30$  cm**

**proportion  $15 \times 18,33/30$**

## **II SAFETY - RULE:**

**(For stairs with steep or small pitches)**

**1 rise (a) + 1 tread(b) = 46 cm**

**-  $a + b = 46$  cm**

**$b = 46$  cm - a**

## **III COMFORT - RULE:**

**(relatively wide treads with normal rises of 16-19 cm)**

**Tread (b) - rise (a) = 12 cm**

**- b-a = 12 cm**

**b = 12 cm + a**

**Decision:**

**either: medium proportion 15 × 13,33/23**

**or: according to the space available in the staircase.**

**- The number of rises is defined as - n- (15 in our case). Upwards the stair begins with a rise followed by a tread. The last rise is followed by the next floor level. There is therefore no tread:**

**No. of treads = No. of rises - 1**

**= n - 1**

**(= 15 - 1 = 14)**

**According to the PLAIT the LENGTH of the stair - 1 - is equal to the sum of the treads:**

**L = b = (n-1)×b**

**The length - 1 - for the example:**

**I L = (15-1)×26 = 3,64 m**

**II L = (15-1)×28 = 3,92 m**

$$\text{III } L = (15-l) \times 30 = 4,20 \text{ m}$$

### 13.4.2 SLOPE OR PITCH

Slope or Pitch of a stair should not exceed 45° nor be less than 25°. For stairs in regular use a maximum of 35° should be taken. The slope is given for the walking line.

$$\text{Pitch} = \frac{\text{rise}}{\text{thread}} = \frac{a}{b}$$

**Example for the proportion**

**18,33/28 cm:**

$$\frac{a}{b} = \frac{18,33\text{cm}}{28\text{cm}}$$

**(A) - Pitch as proportion**

**a: b = 1: x**

$$x = \frac{1 \times b}{a}$$

$$a: b = 1: \frac{b}{a}$$

**Example for proportion 18,33/23 cm**

$$a : b = 1 : \frac{b}{a}$$

$$a : b = 1 : \frac{28\text{cm}}{18,33\text{cm}}$$

$$\mathbf{a : b = 1 : 1,53}$$

**(B) - Angle of the Pitch:**

$$\text{tang } X = \frac{a}{b}$$

**Example for proportion 18,33/23 cm**

$$\text{tang } X = \frac{18,33\text{cm}}{28\text{cm}}$$

$$\mathbf{\text{tang } X = 0,6546}$$

$$\mathbf{X = 33,21^\circ}$$

### **13.4.3 LANDINGS**



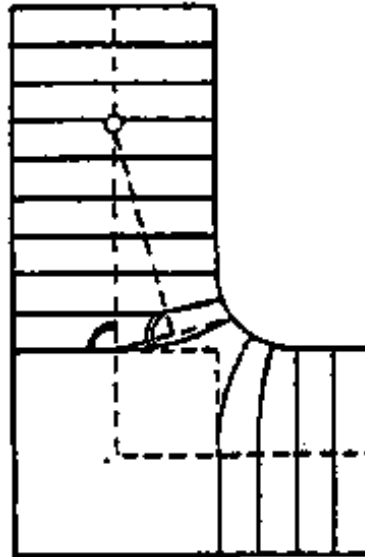

Curved steps at landing on a narrow stair save landing space

- **LANDINGS** (already defined) ref. to 13.2

(a) **Straight landings to be provided at least after 18 rises (as a REST)**

**Length of the landing:**

in accordance with the pace  $L = N \times 63 \text{ cm} + 2 \frac{b}{2}$

(No. of paces)

(b) **Landings for turning the direction (half-space or quarter space)**

**Length of the landing:**

$$L = 1,1 \times \text{width (minimum 1m)}$$

The important factor is the space required for the transportation of large pieces of goods.

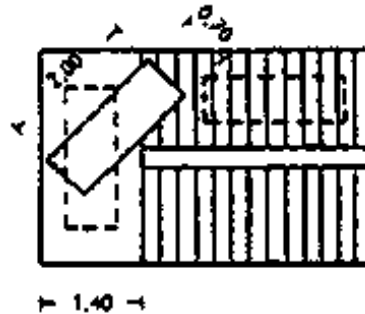

Minimum space required  
to move furniture

#### 13.4.4 WIDTH

The usable width of a stair has to be measured at the narrowest place of the staircase.

For main stairs the width depends on the use of the stair. (whereby the type of building the number of persons passing each other or the number of people staying in the building are of importance.)

A Common usable width of STAIRS according to the type of building:

TYPE of BUILDING	WIDTH
1-,2-,3-, family flats/ dwelling houses	0.80- 1.00 m

<b>bigger flats</b>	<b>1.10- 1.30 m</b>
<b>public buildings</b>	<b>1.30- 1.90 m</b>

### B Usable width of STAIRS according to the number of persons passing each other

No. of PERSONS	WIDTH
<b>2 PERSONS</b>	<b>1.10- 1.30 m</b>
<b>3 PERSONS</b>	<b>1.80- 1.90 m</b>

For STAIRS of minor importance (i.e. emergency stairs, stairs in buildings with a lift, etc). the measurements may be reduced, but they have to be in accordance with the rules of the local authorities.



width of stairs allowed

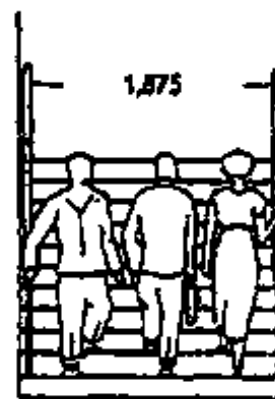

width of stairs allowed

two people to pass



three people to meet and pass

### **13.4.5 WALKING LINE**

**(DEFINITION REF. 13.2)**

The representation of the walking line begins with a circle on the nosing of the lowest step and ends with an arrow on the nosing of the next floor level.

The walking line leads always upwards.

In case of all strength and round flights up to a width of 0.95 m the walking line is always in the centre.

In case of a width exceeding 0.95 m the walking line is taken to be generally 4-5 cm from the centre of the handrail.

On the walking line, the calculated measurements for the treads to be indicated.

## **13.5 CONSTRUCTION OF STAIRS**

### **13.5.1 BRICK STAIRS**

Bricks are used for simple external steps and stairs and occasionally for internal use. The steps must be formed of good hard, square bricks and are bedded in cement mortar on concrete.

If the steps are not built on a natural slope of ground, the deep hardcore filling must be carefully and well consolidated to avoid settlement.

The bonding of the bricks will depend on the dimension of tread and riser and the bricks will normally be laid on edge to expose the face sides and the ends.

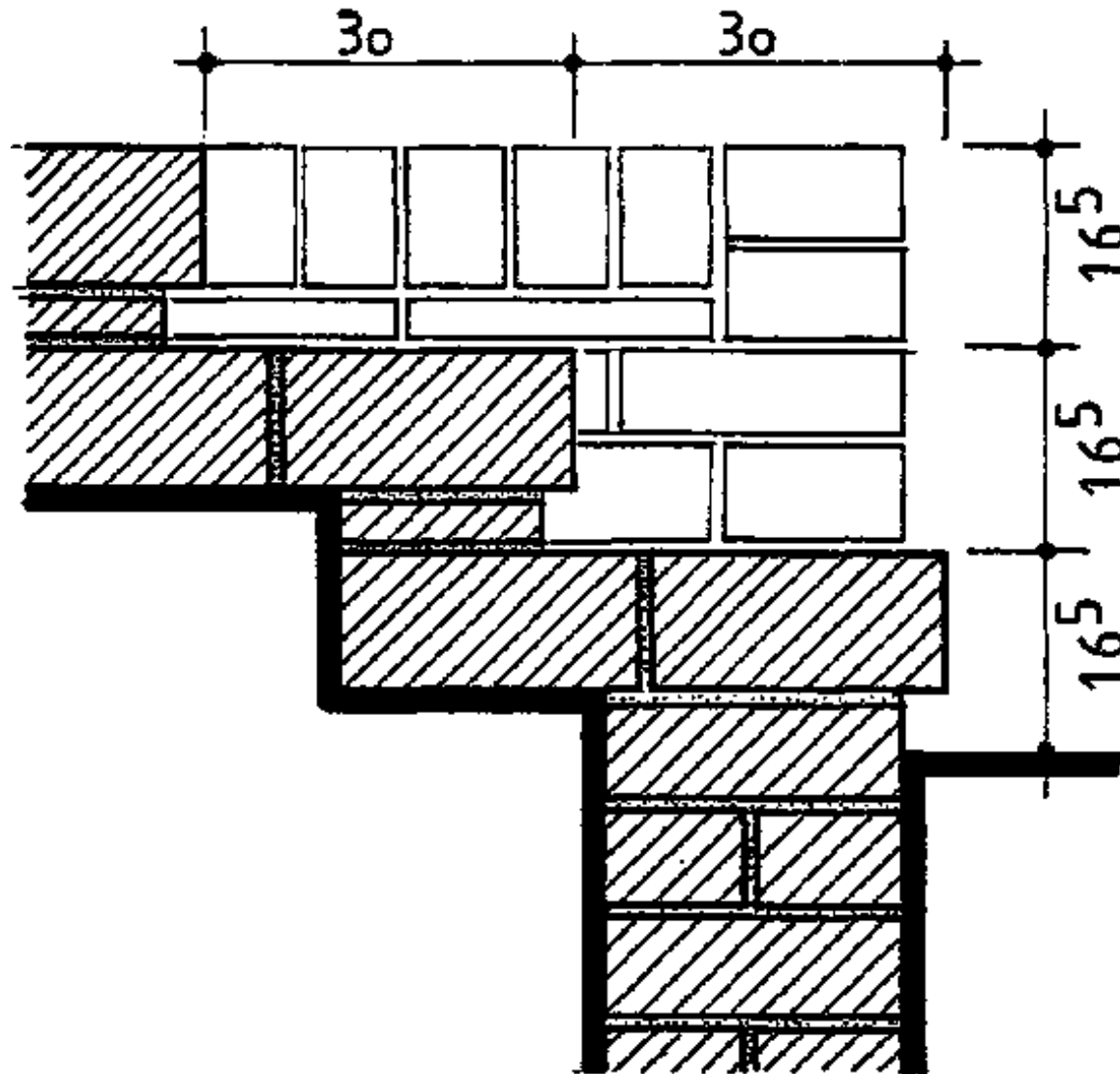

### 13.5.2 STONE STAIRS

are used as external and internal stairs.

**In case of external stairs the material has to resist the elements therefore GRANIT, BASALD and hard SANDSTONE are suitable materials.**

**Stone stairs may be in the form steps simply supported on end walls or as cantilever flights and landings or in the form of a circular newel or turret stair.**

**Simply supported or cantilevered steps can be either rectangular blocks giving a stepped soffit or spandrel steps, splayed on the underside to give a smooth soffit.**

**Cantilever stone steps should not usually exceed 1.50m to 1.80m in projection, the safe max. depends upon the type of stone used.**

**If landings are large, these are made up of a number of slabs with joggeled joints.**

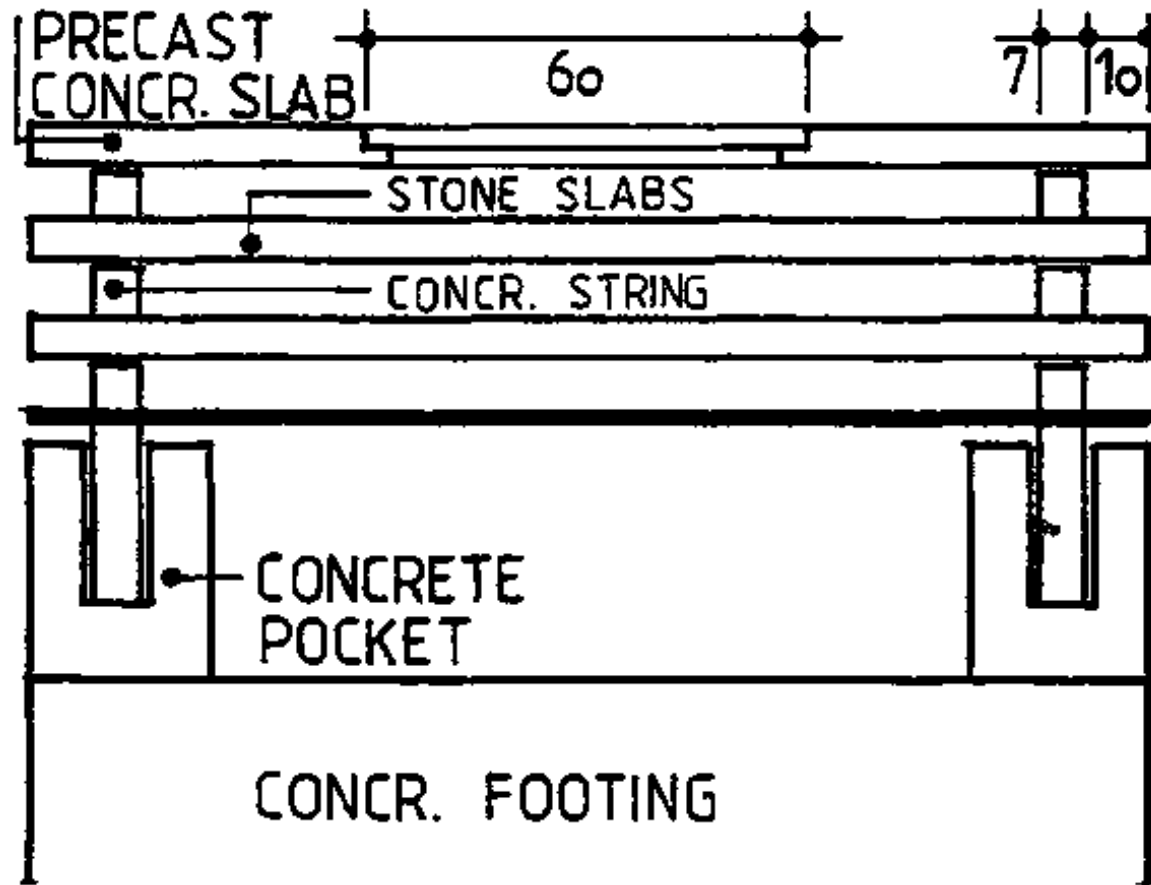

The newel stair is similar to the spiral newel stair in precast concrete, but because of the transverse weakness of stone the steps are not to cantilever out from, the central newel (where the stone is thinnest); the outer ends are built into the enclosing wall, so that each is a step simply supported on the wall and the newel.

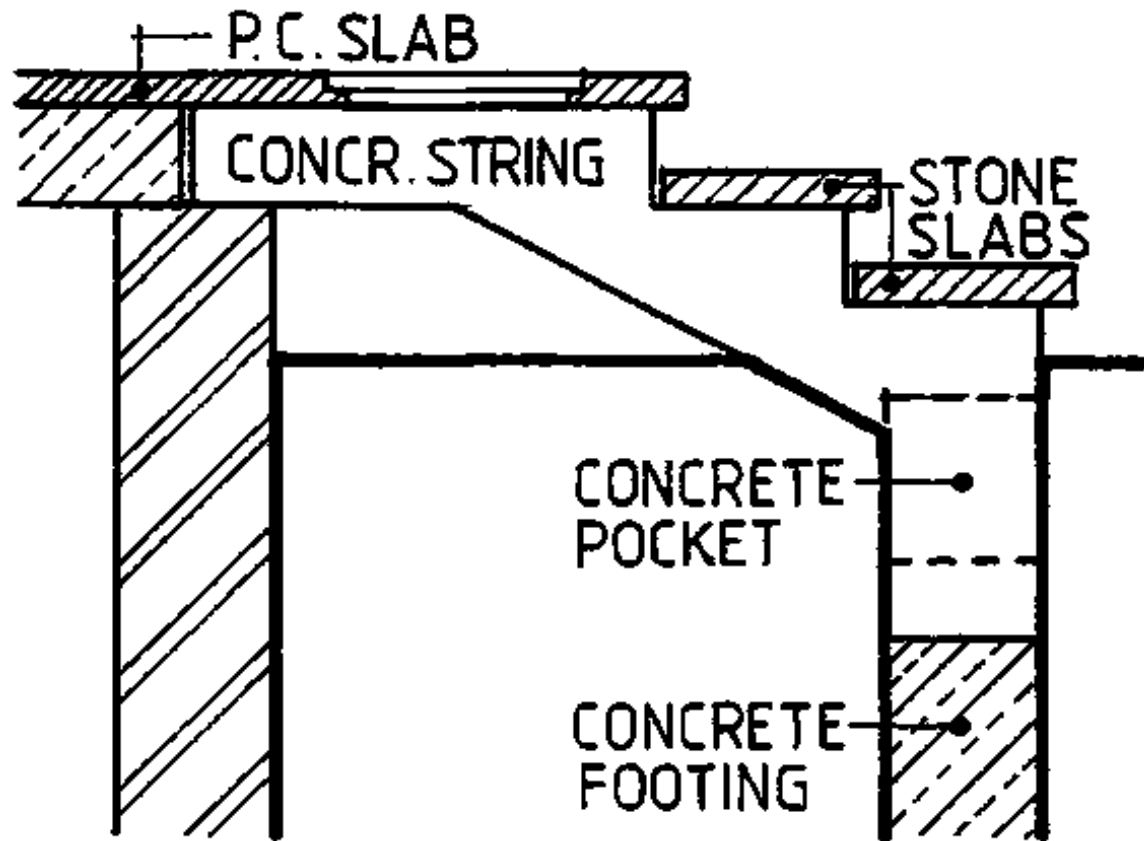

### 13.5.3 CONCRETE STAIRS

Concrete stairs are widely used in all types of buildings

- They have a high degree of fire resistance,
- are strong; and
- make possible a wide variety of forms.



They may be cast in-situ or be precast as whole flights of in separate parts.

### 13.5.3.1 In Situ Cast R.C. Stairs

- The concrete specification is usually

- concrete mix 1:2:4
- min. cover of concrete over reinforcement: 15 mm (or bar diameter whichever is greater)
- waist thickness usually between 10 and 25 cm depending on stair type.
- mild steel or yield steel bars can be used as reinforcement.

The bars being lapped to starter bars at the ground floor and taken into the landing or floor support slab.

Number, Diameter and Spacing of the main and distribution reinforcement must always been calculated for each stairway.

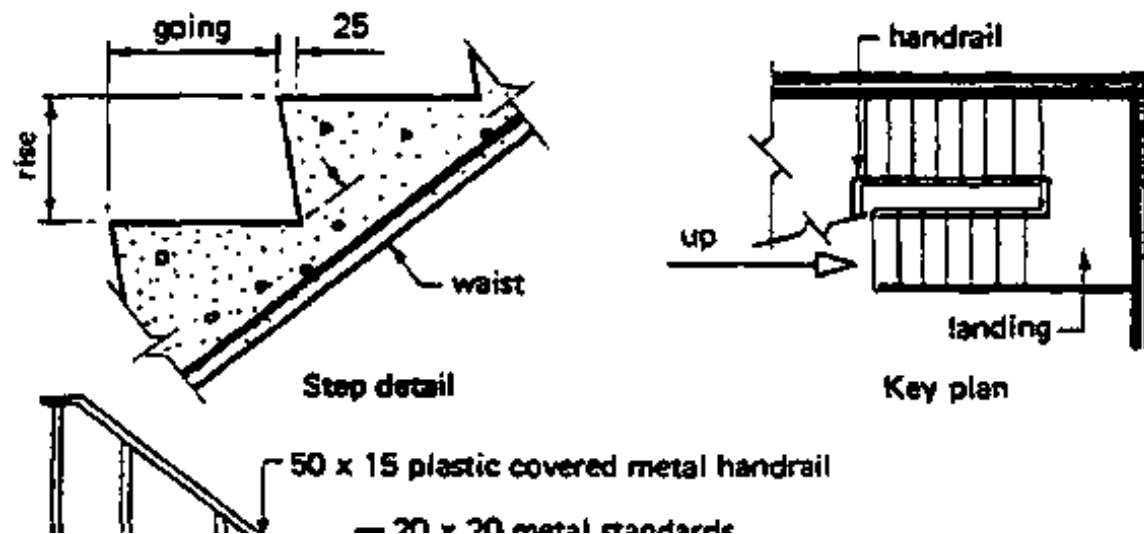

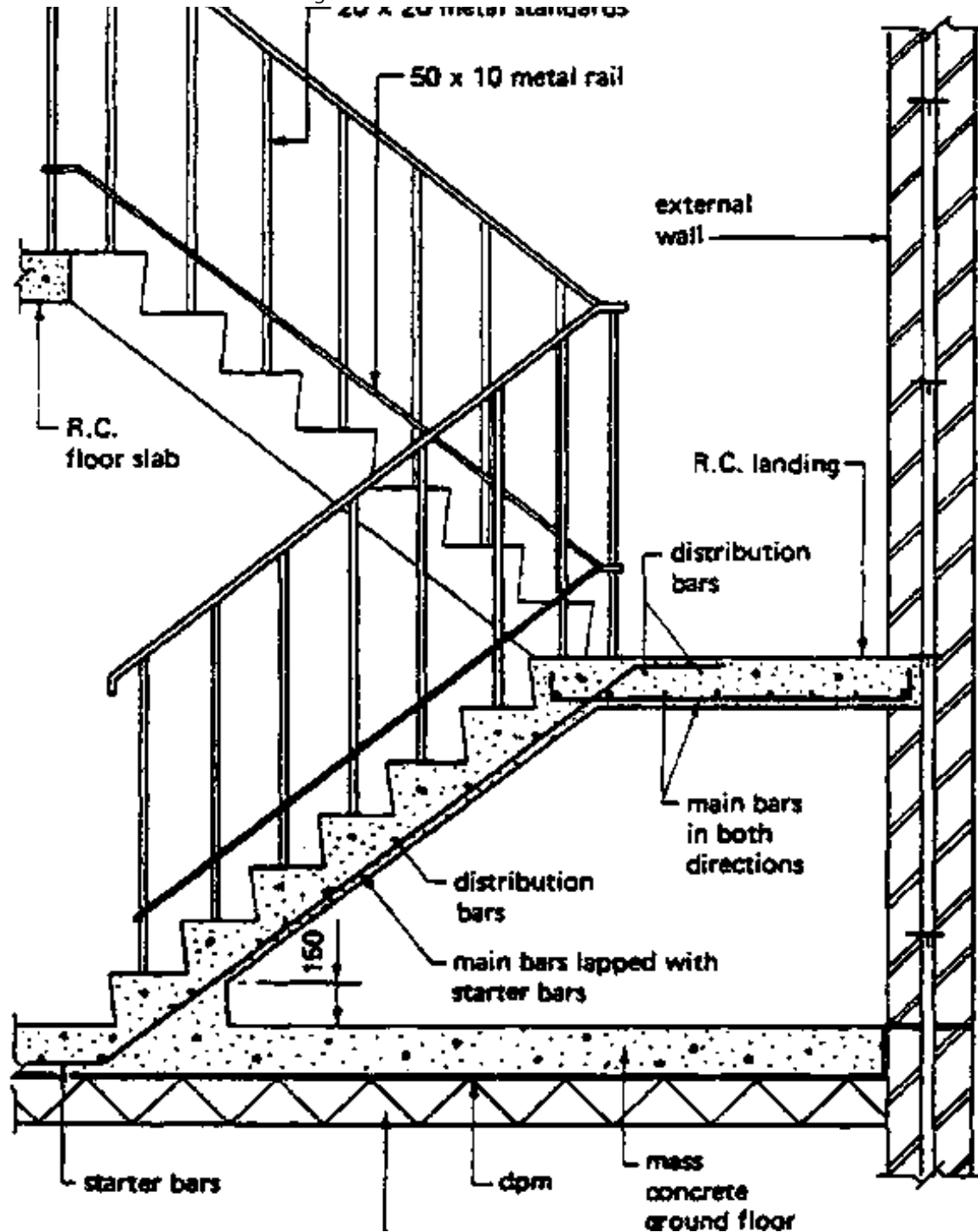

compacted  
hardcore

### Simple R.C. in situ stairs

- A wide variety of finishes can be applied to the tread surface of the stairs.
- The soffits can be left as struck from the formwork and decorated or finished with a coat of spray plaster or a coat of finishing plaster
- The basic formwork requirements are the same as for form-work to a framed structure.
  - The stair profile is built of an adequately supported soffit of sheet material by using a cut string.
  - Riser boards are used to form the leading face of the steps (these should have a splayed bottom edge to enable complete trowelling of the tread surfaces and to ensure that air is not trapped under the bottom edge of the riser board thus causing voids.
  - If the stair abuts a vertical surface, two methods can be considered to provide the abutment support for the riser boards.
    - a) a reversed cut string or
    - b) a wall board with hangers.
  - Wide stairs can have a reverse cut string as a central support to the riserboards to keep the thickness of these within an acceptable load limit.

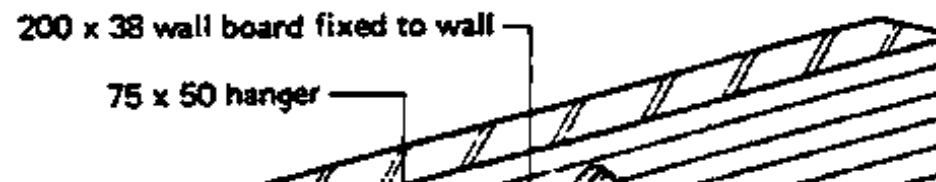

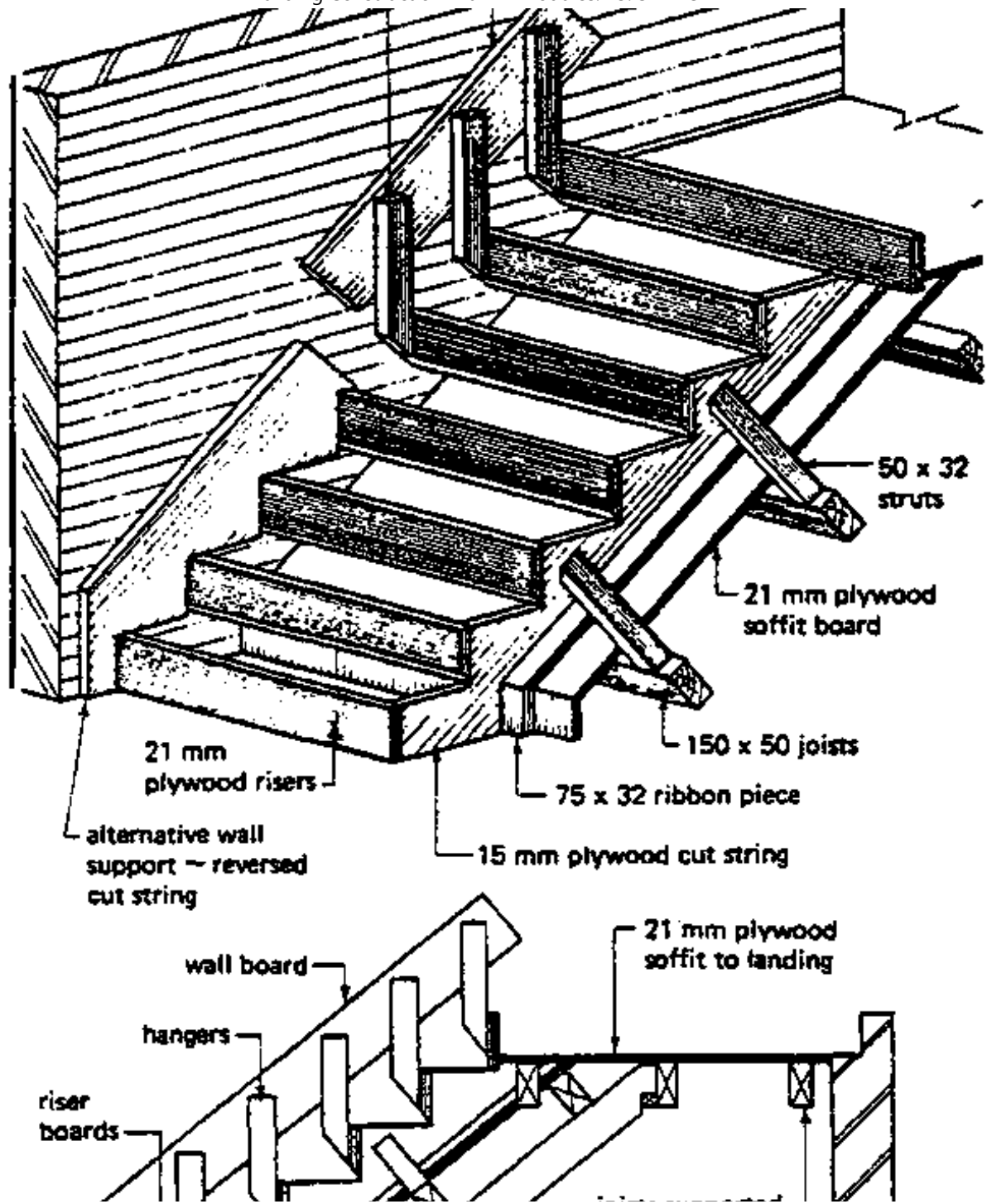

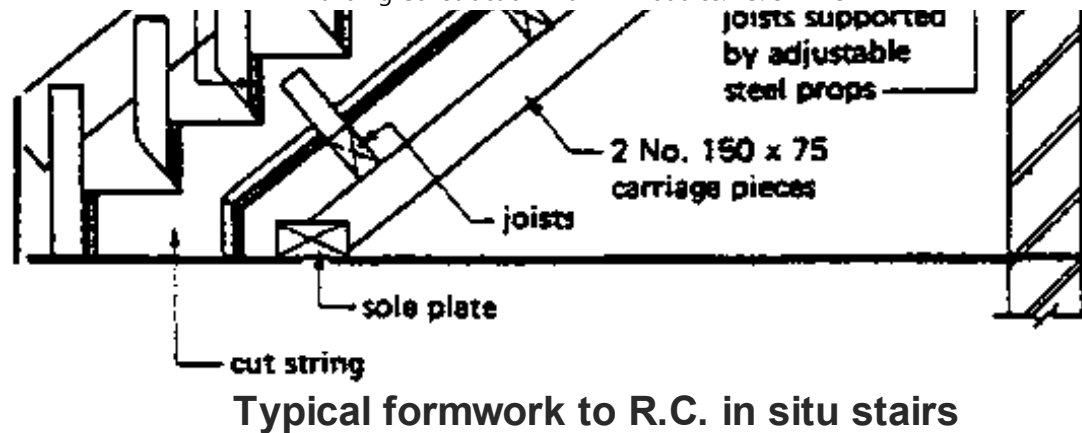

## Single flight stairs

### - Long and cross spans

- The structural behaviour of a stair flight is very similar to that of a simply supported slab, - its effective thickness being its waist. -

- When considering single flights between floors, it should be realised that it is uneconomic to span the flight between landings, since an extra distance of about 1 m at either end of the flight would result in a long span of up to 6 m.

- If downstand beams are provided at the edges of the landings, the effective span may be reduced to 4 m for the same flight which would result in a bending moment reduction of over 50.

- The arrangement of reinforcement is shown in figure

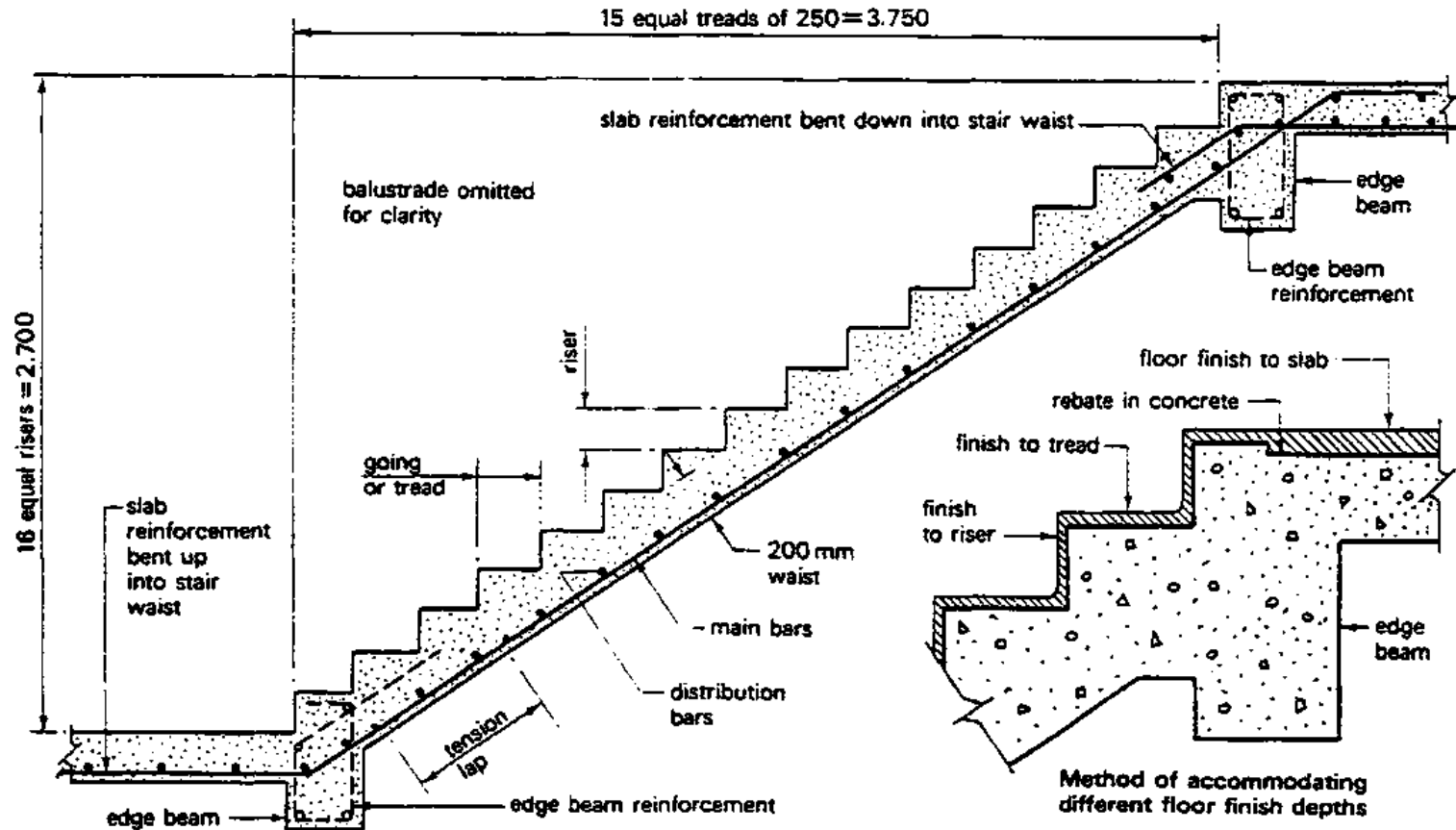

**Straight flight concrete stairs**

### Half flights with, landings

(inclined slab concr. stair)

- Where half landings are incorporated it is normal for stairs to span on to the landings with the landings spanning cross ways.

- The arrangement of reinf. bars are shown in the figure.

It should be noticed again, that the tension lap is required at the top and bottom of each flight, this is to overcome the tension inducted by the tendency of the external angles of the junctions between stair flights and landings to open out.

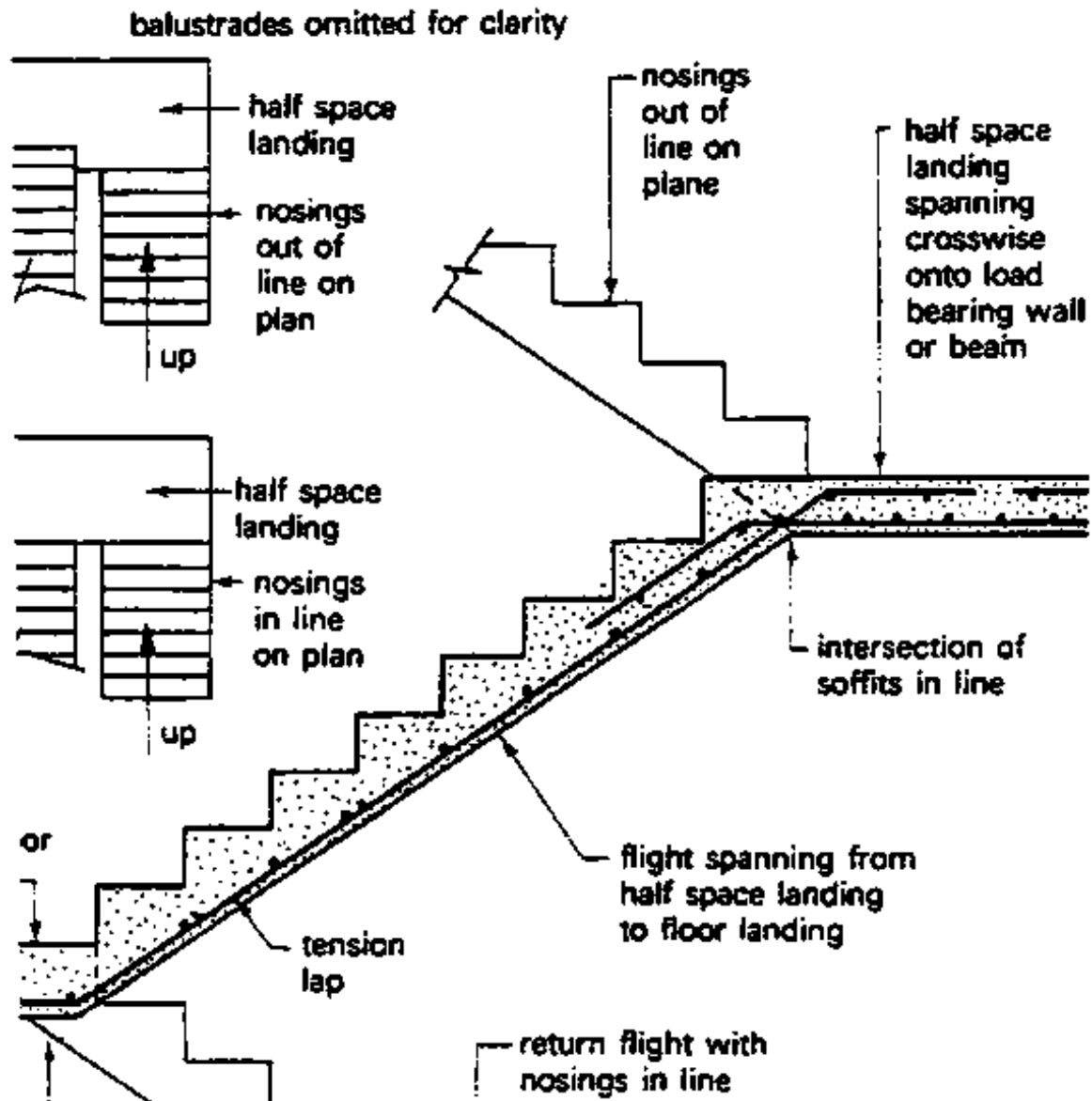

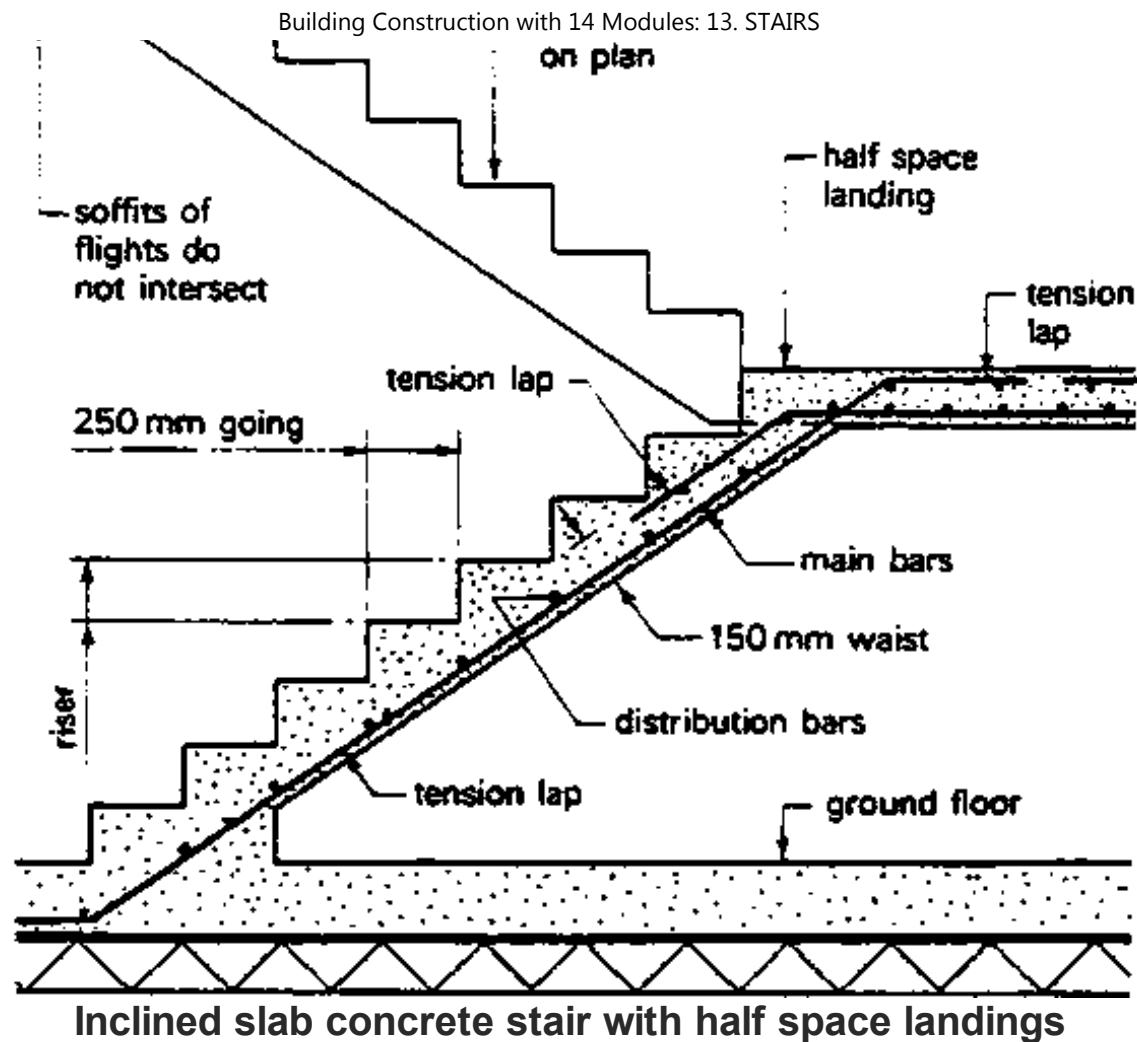

### String beam stairs

- are an alternative design for the stairs described above. A string or edge beam is used to span from landing to landing to resist the bending moment with the steps spanning crosswise between them;

- this usually results in a thinner waist dimension and an overall saving in the concr. volume required. But this saving in material is usually offset by the extra formwork costs.



- The string beams can be either upstand or downstand in format and to both sides if the stairs are free standing.

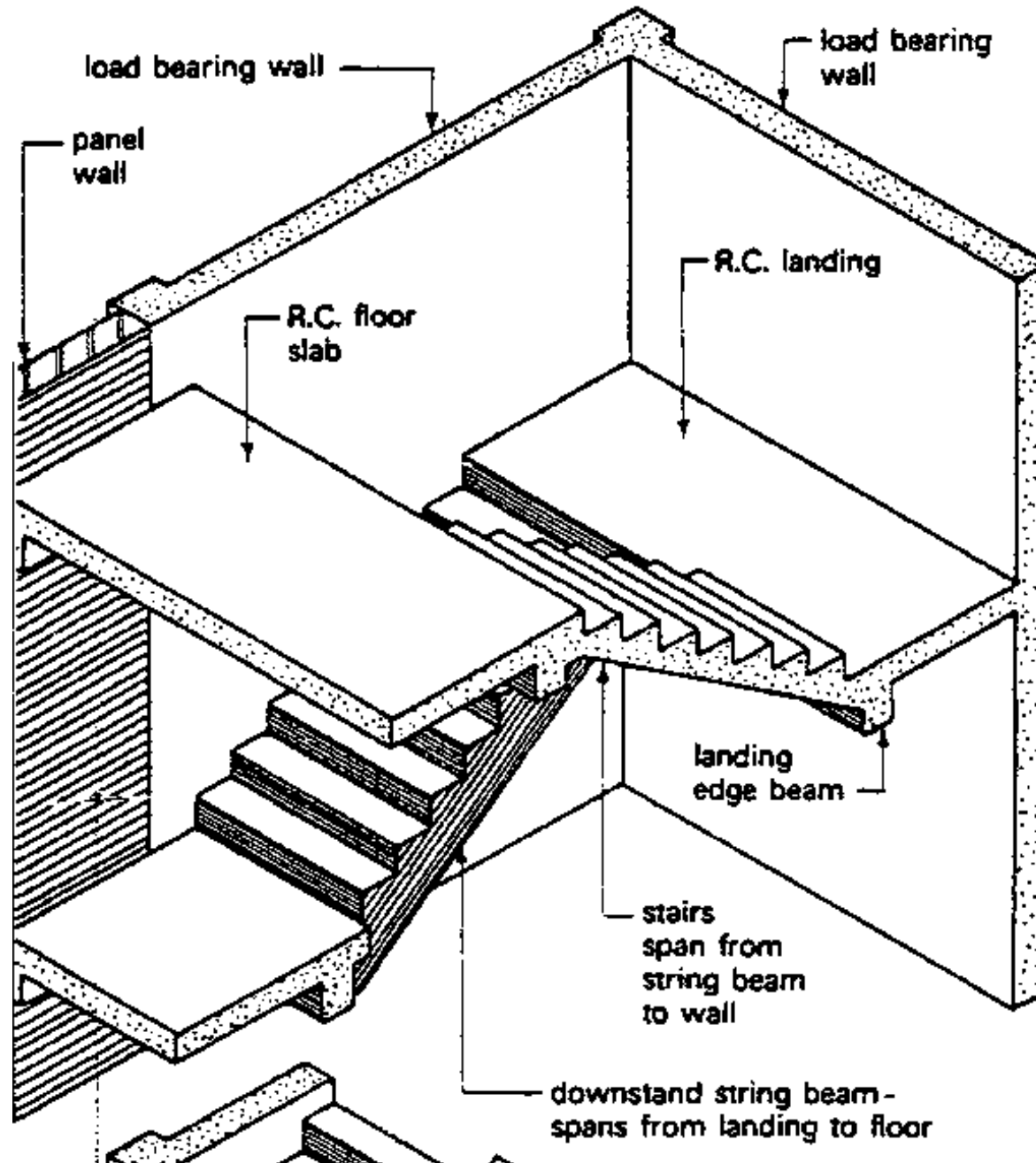

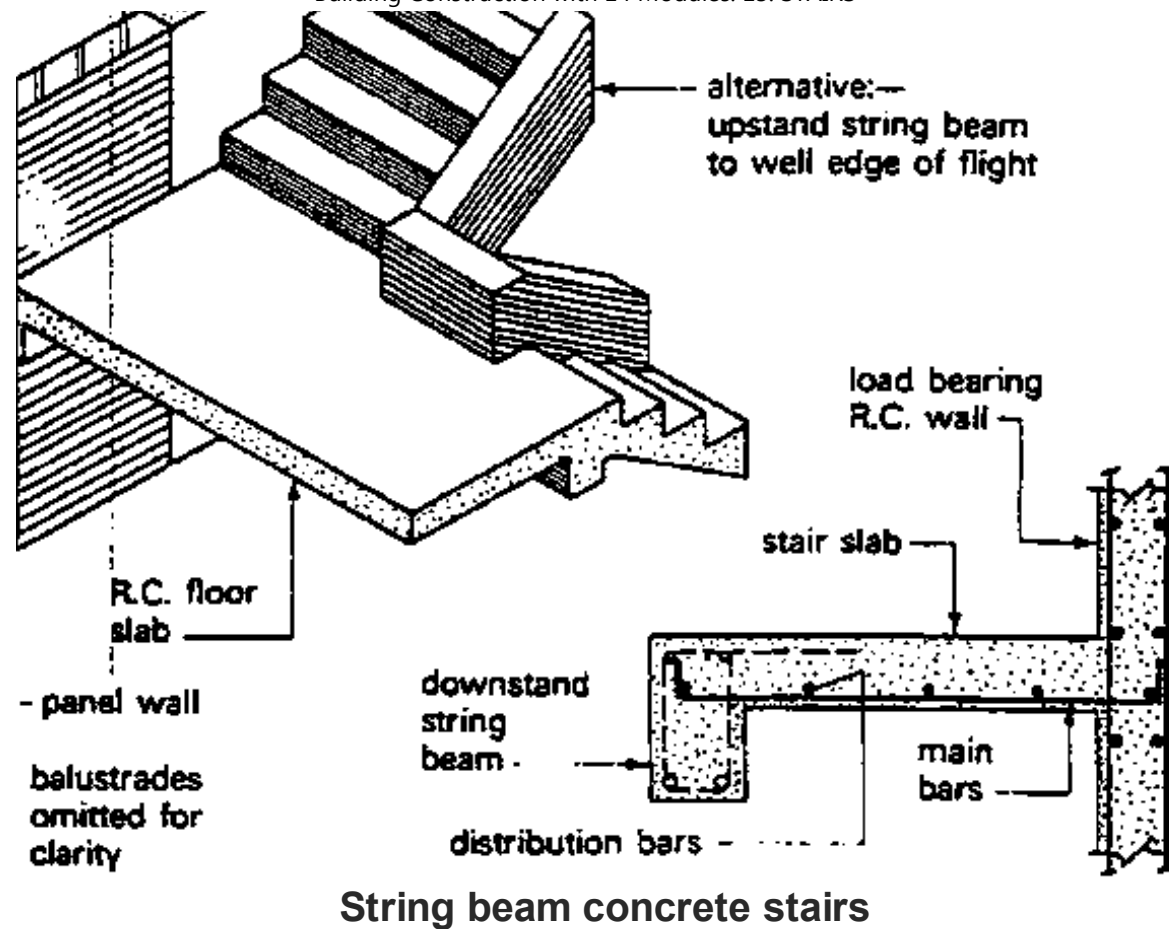

### Cranked slab stairs

- are very often used as a special feature, since the half space landing has no visible support being designed as a cantilever slab.

- Bending, buckling and torsions stresses are induced with this form of design.

Creating the need for reinforcement to both, faces of the landing and slab or waist of the flights.

- The amount of reinforcement required can sometimes create site problems with regard to placing and compacting the concrete.

Typical details of a cranked slab stair (which is also known as a continuous stair, scissor stair or jack knife stair) are shown in the figure.

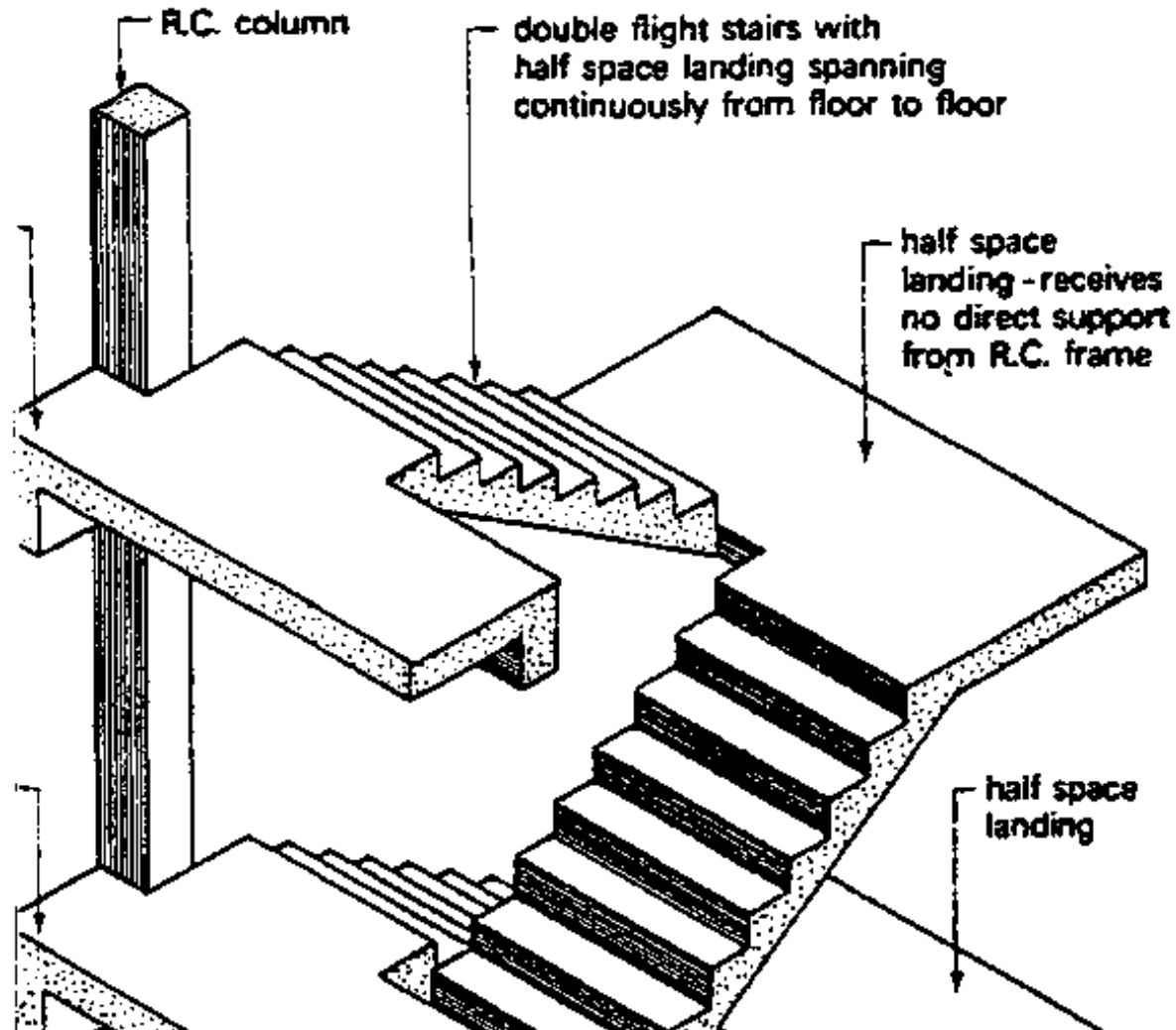

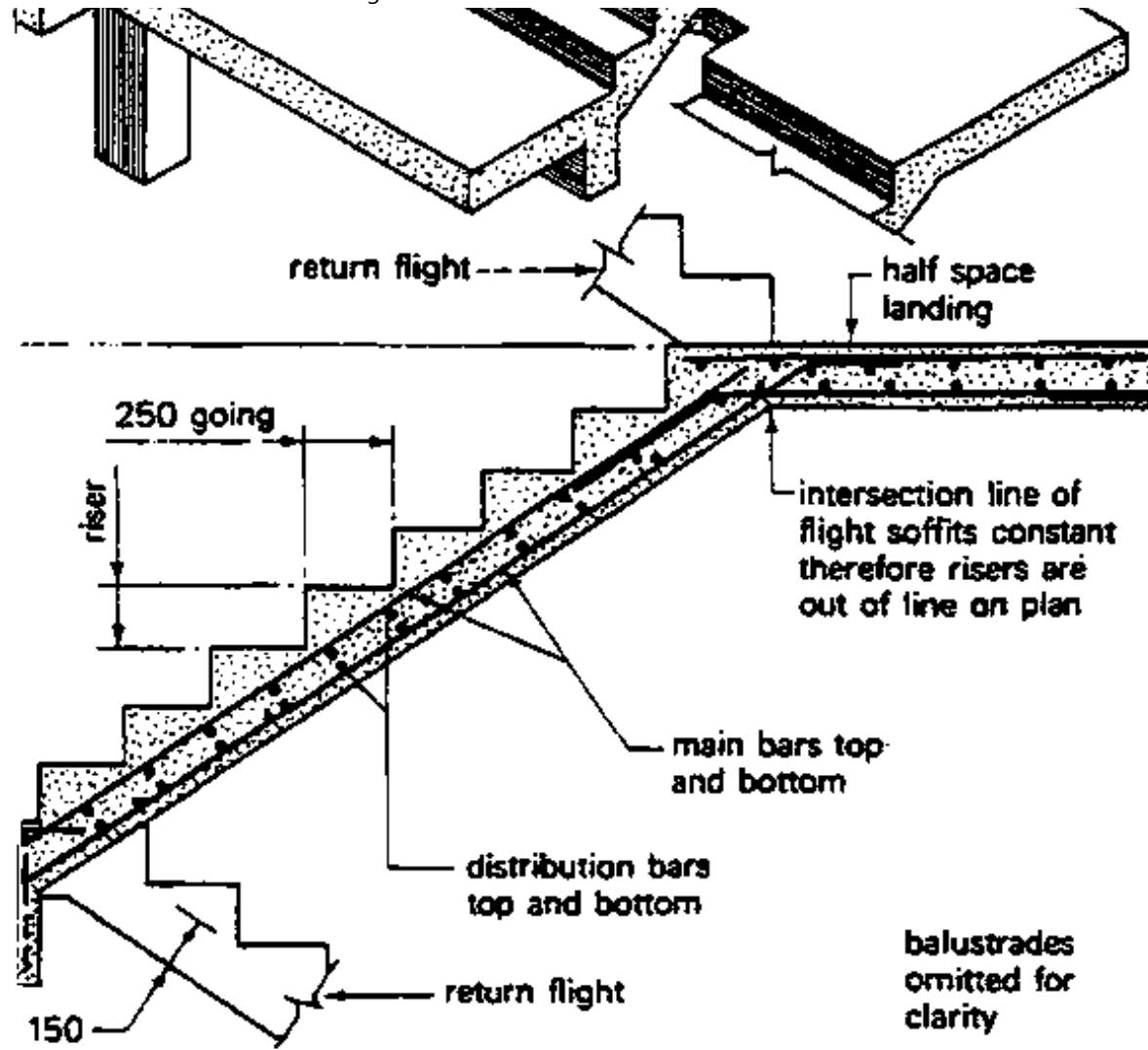

Cranked or continuous slab concrete stairs

### Cantilever stairs:

(sometimes called spine wall stairs) consist of a central vertical wall from which the flights and half space landings are cantilevered.

- The wall provides a degree of fire resistance between the flights and are therefore mainly used for escape stairs.

Since both flights and landings are cantilevers the reinforcement is placed in the top of the flight slab and in the upper surface of the landing to counteract the induced negative bending moments. The plan arrangement can be single straight flight or - as is usual - two equal flights with an intermediate half space landing between consecutive stair flights.

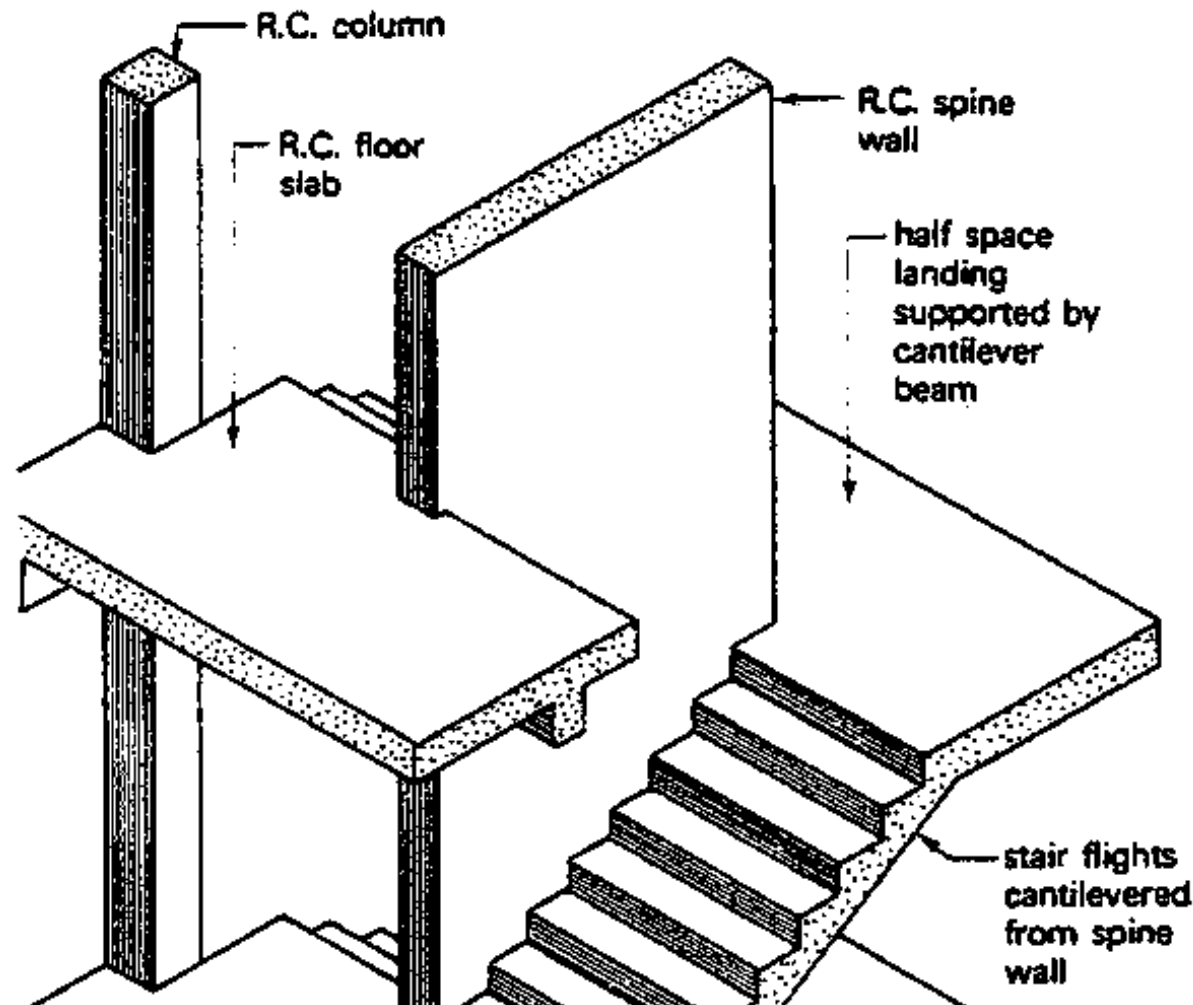

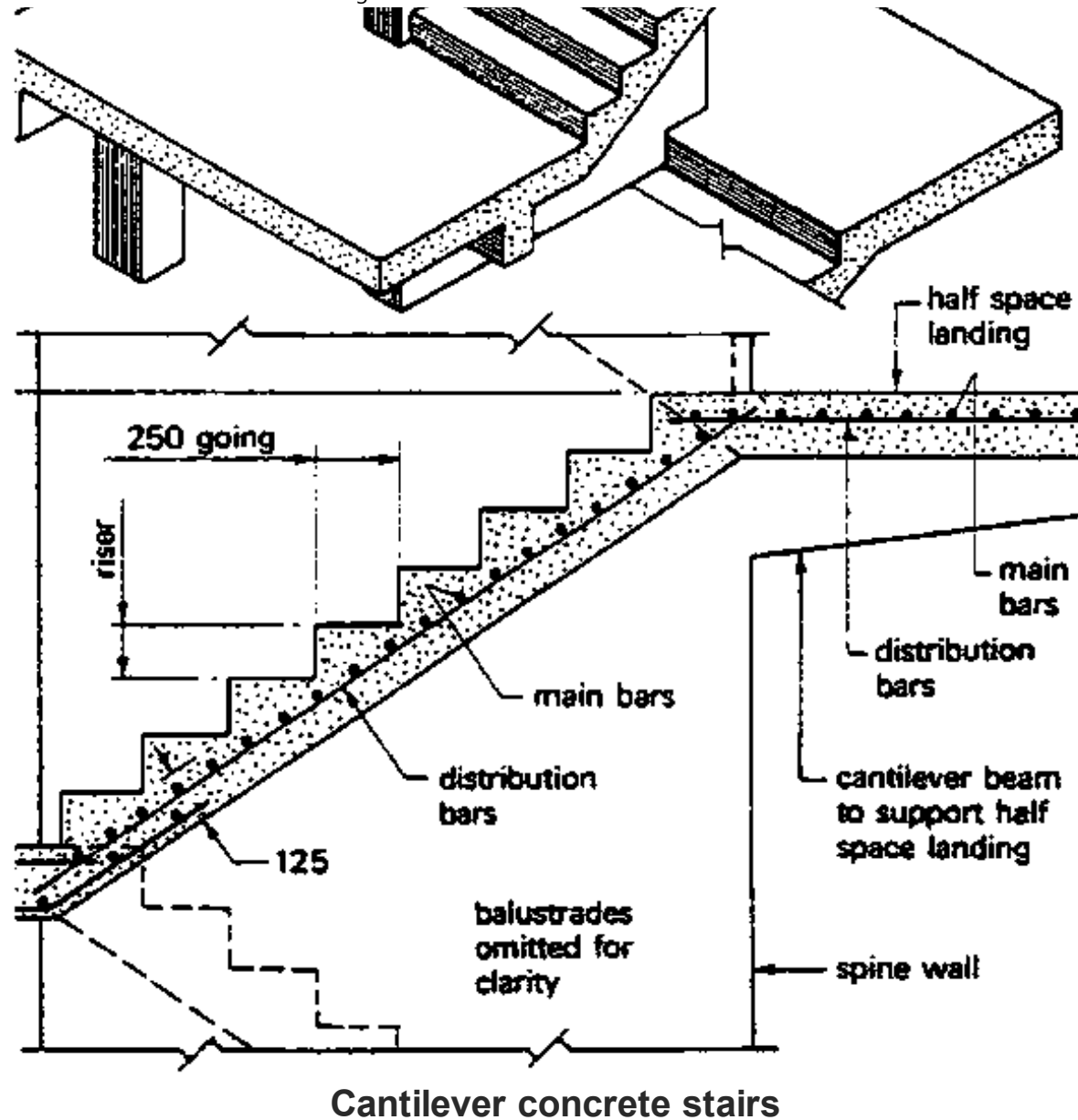

## Spiral stairs

are used mainly as accommodation stairs in the foyers of prestige buildings such as theatres and banks.

**They can be expensive to construct, being normally at least seven times the cost of conventional stairs.**

- **The plan is generally based on a circle although it is possible to design an open spiral stair with an elliptical core.**

**The stair can be forced around a central large diameter circular column in a similar manner to that described for cantilvered stairs or - as it is an usual design with a circular open stair well.**

- **Torsion, Tension and compressive stresses are induced in this form of stair which will require reinforcement to both faces of the slab in the form of radial main bars, bent to the curve of the slab with distribution bars across the width of the flight.**

**Formwork for spiral stairs consists of a central vertical core or barrel to form the open stair well to which the soffit and riser boards are set out and fixed, the whole arrangement being propped and strutted as required from the floor level in a conventional manner.**

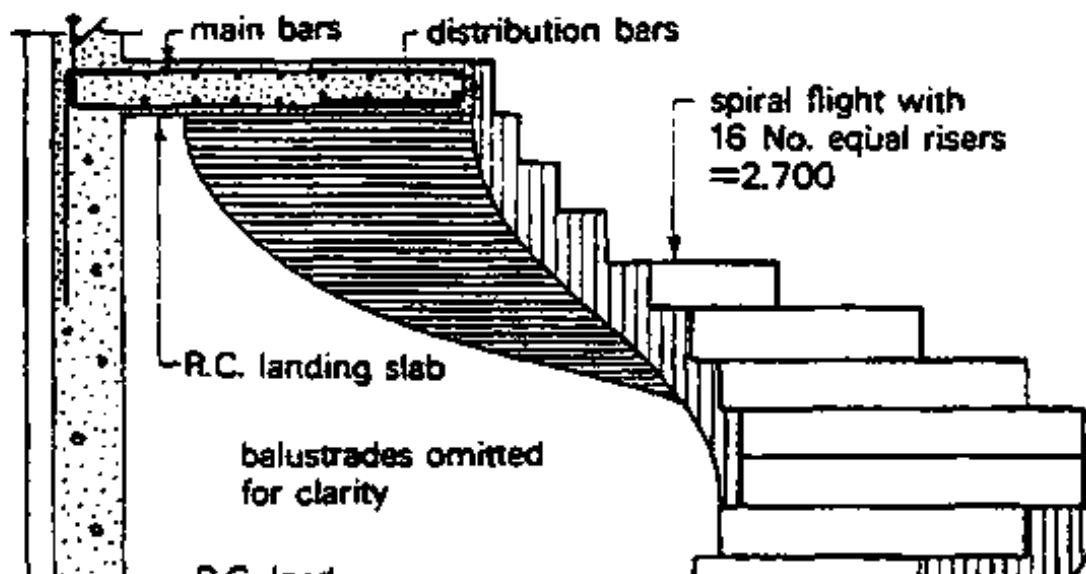

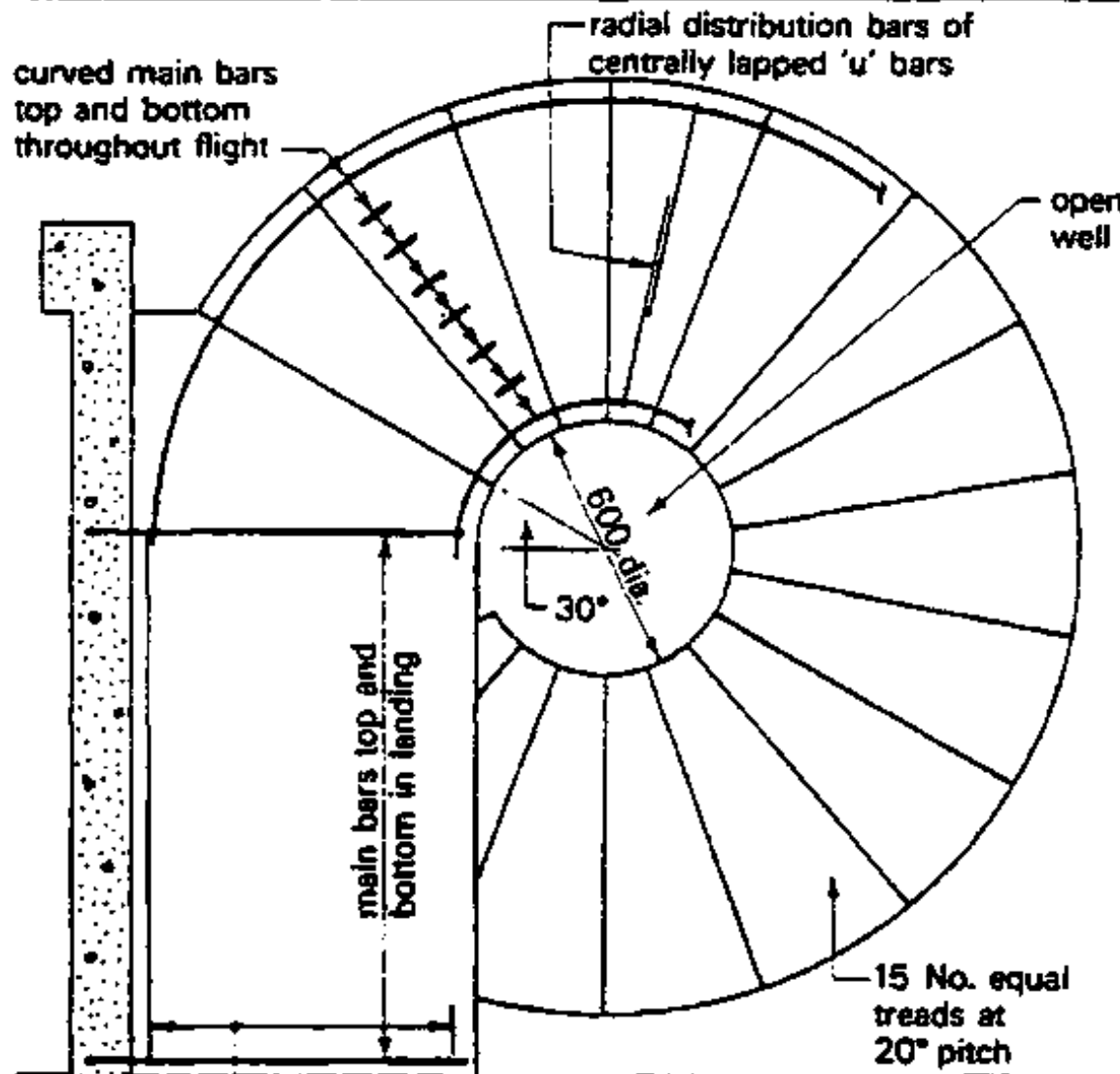
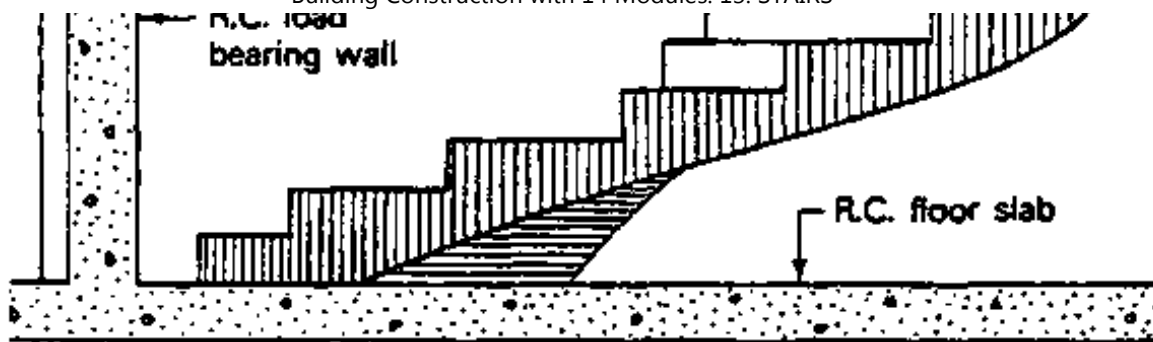



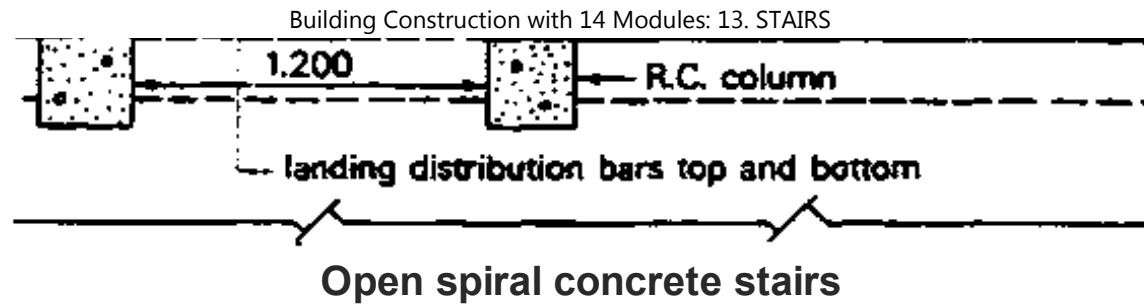

### 13.5.3.2 Precast Concrete Stairs

- Most of the concrete stair arrangements previously described can be produced as which can have the following advantages:

- better quality control of the finished product
- saving in site space, since formwork storage and fabrication space is no longer necessary
- stairway enclosing shaft can be utilised as a space for lifting materials during the major construction period
- saving in time
- can usually be positioned and fixed by semi-skilled labour.

- Like all precast components the stairs must be

- repetitive and
- in sufficient quantity

**to Justify their use and to be an economic proposition.**

- **Simple precast concr. stairs spanning between landings can have a simple bearing or, by leaving projecting reinforcement to be grouted into preformed slots in the landings, they can be given a degree of structural continuity.**
- **Precast concrete stairs, constructed from a series of precast steps are either**
  - **built into or**
  - **cantilevered from**

**a structural wall.**

- **The use of precaste concr. steps to form a stair way is limited to situations such as**
  - **short flights between changes in level**
  - **external stairs to basements etc.**

**They rely on the load bearing wall for support and if conti-levered on the downward load of the wall to provide the necessary reaction.**

- **The support wall has to provide the necessary load and strength and at the same time it has to be bonded or cut around the stooled and of the steps.**
- **The steps are usually fabricated in factories. They consist of a concrete core covered with a facing material (artificial stone).**

**To reduce the weight, the steps are often produced as hollow steps.**

It is advisable to protect the edges of the steps.

- Straight flight precast concrete stairs with a simple bearing require only Bottom Reinforcement to the slab and Extra Reinforcement to strengthen the bearing rebate or nib.

The bearing location is a rebate cast in the in-situ floor slab or landing, leaving a tolerance gap of 8 to 12 mm which is filled with a compressible material to form a flexible joint.

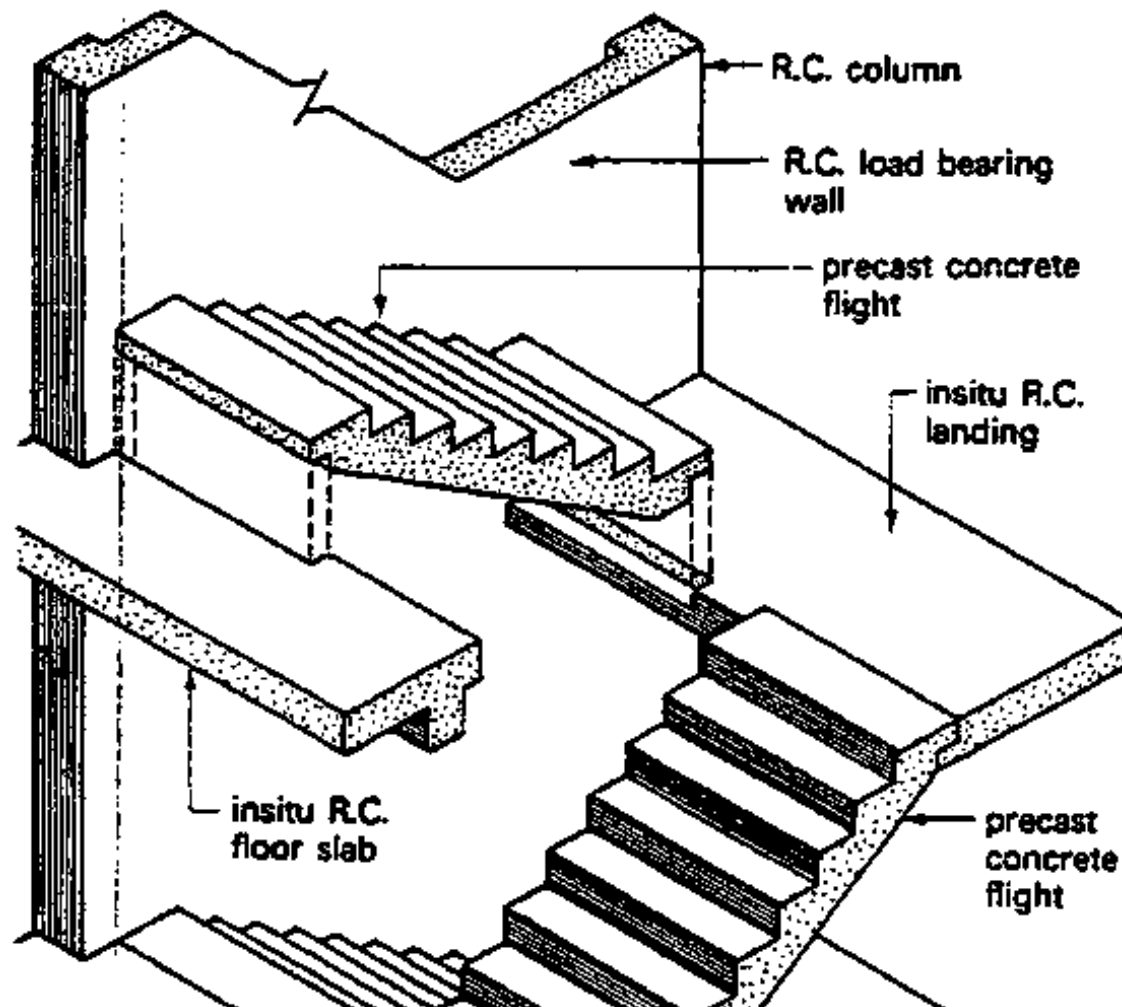

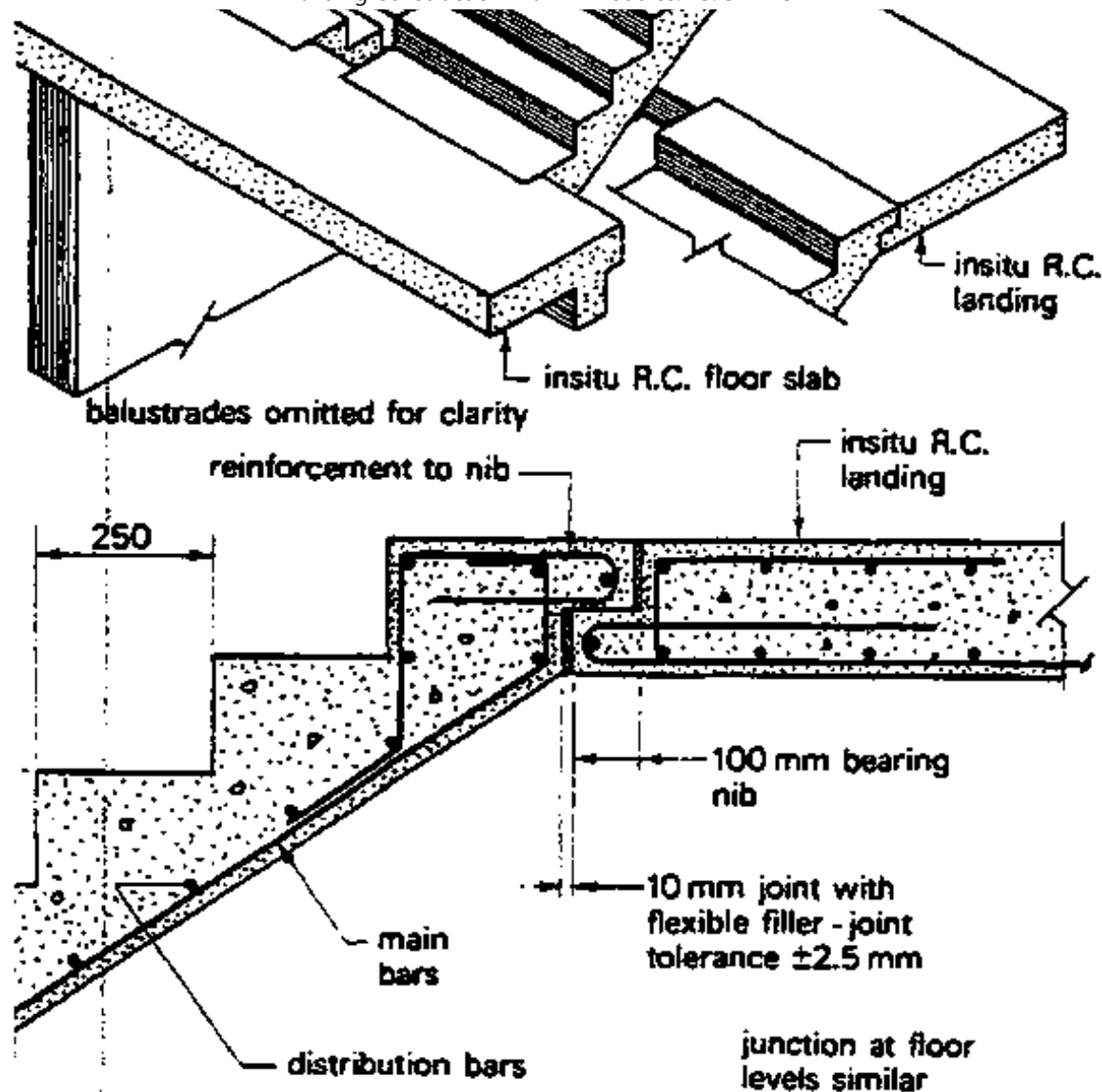

Precast concrete straight flight stairs

### - Cranked slab precast concrete stairs

are usually formed as an OPEN WELL stair. The bearing for the precast landings to the in situ floor or to the structural frame is usually in the form of a simple bearing. The infill can be of in-situ concrete with

structural continuity (provided by leaving reinforcement projecting from the inside edge of the landings)

**N.B.** when p.c.c. stair flights are hoisted into position, different stresses may be inducted from those which will be encountered in the fixed position.

To overcome this problem the designer can either reinforce the units for both conditions OR - as is more usual - provide definite lifting points in the form of projecting lugs or by utilising any holes cast in so receive the balustrade.

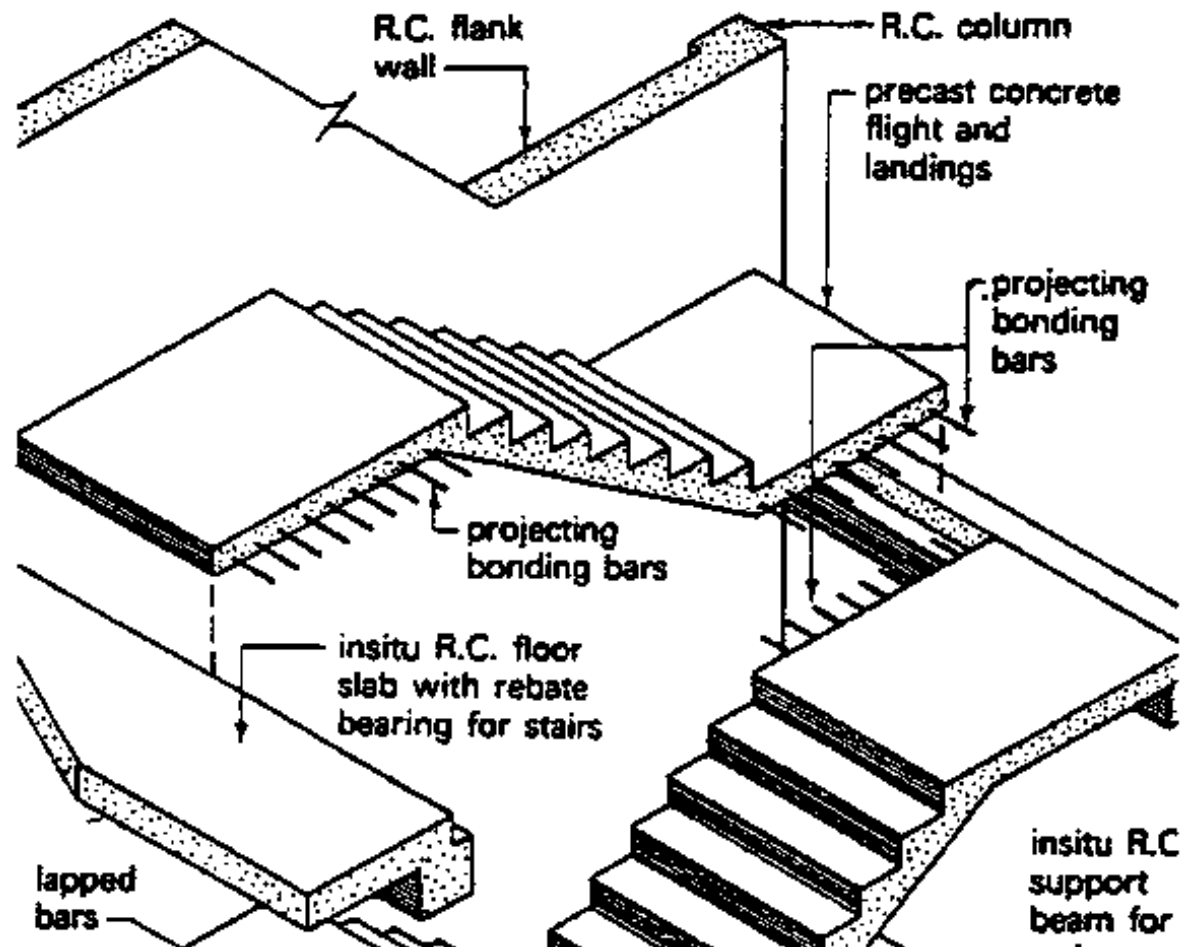

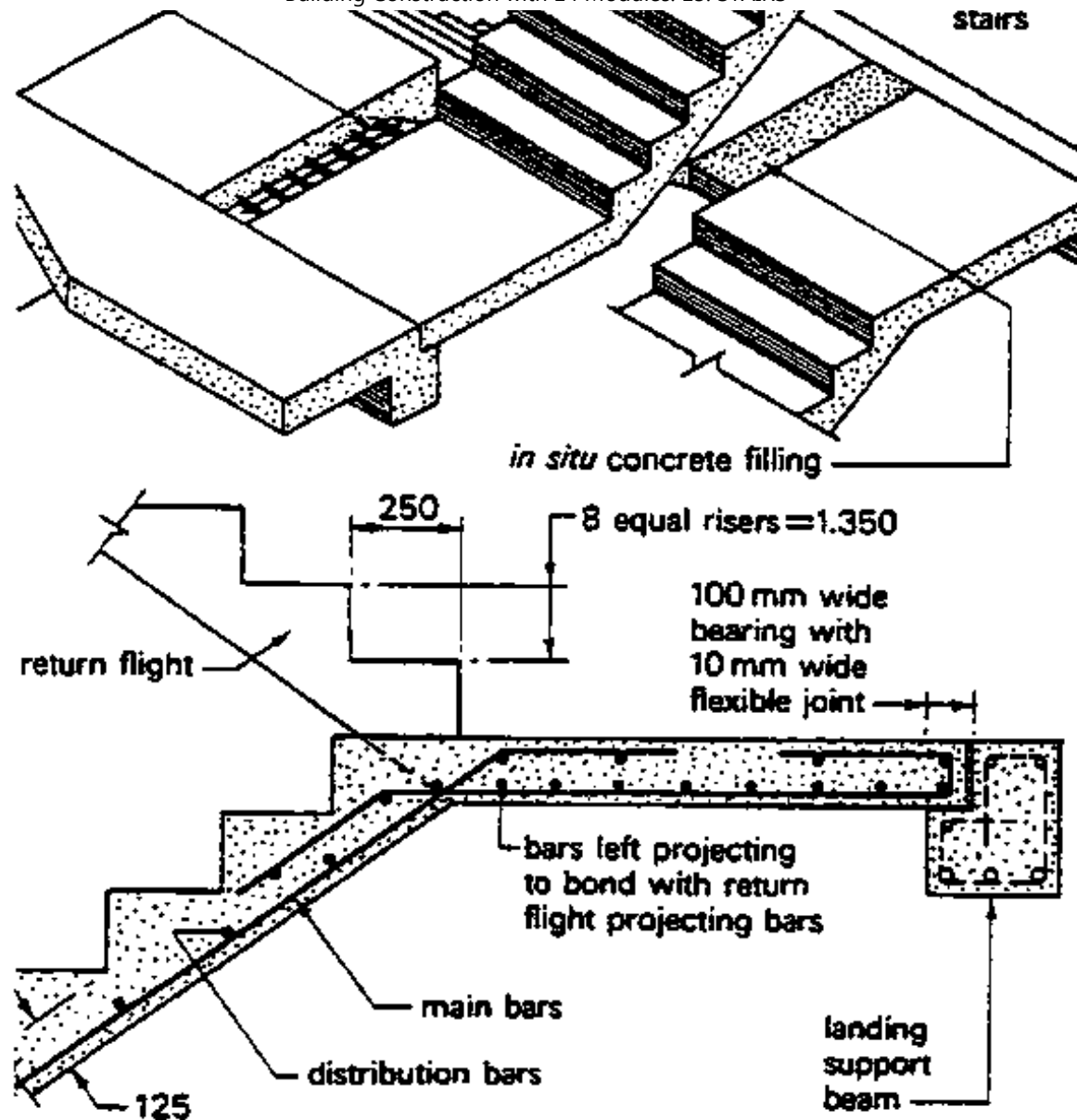

Precast concrete cranked slab stairs

**- Precast open riser stairs**

can be both:

**economic and attractive - consisting of a central spine beam in the form of a cut string supporting double cantilever treads of timber or precast concrete. The foot of the lowest spine beam is located and grouted into a preformed pocket cast in the floor whereas the support at landing and floor levels is a simple bearing located in a housing cast into the slab edge (ref. Fig.)**

**Provisions for fixings of steps to the beam are given in the figure.**

- **Reinforcement to the treads is simply a meshwork of straight bars.**
- **Spine beam reinforcement to be similar to that of a normal beam.**
- **the anchor bolts to be placed sideways rather than length-ways to avoid possible rocking.**
- **the finishes are applied after the fixing slots have been grouted up so that no fixings show through.**
- **balusters are bolted directly to the treads and holes can be left to provided for these in casting.**

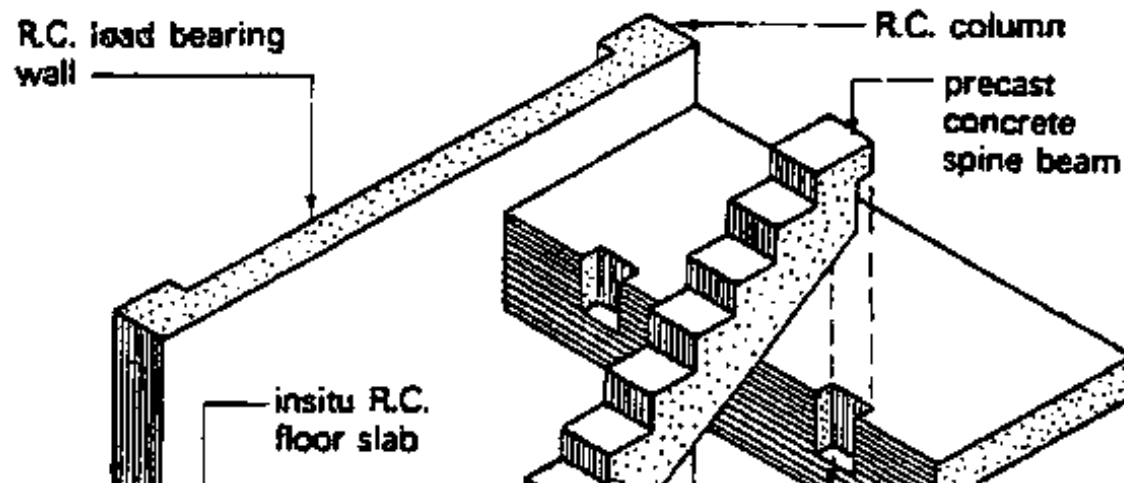

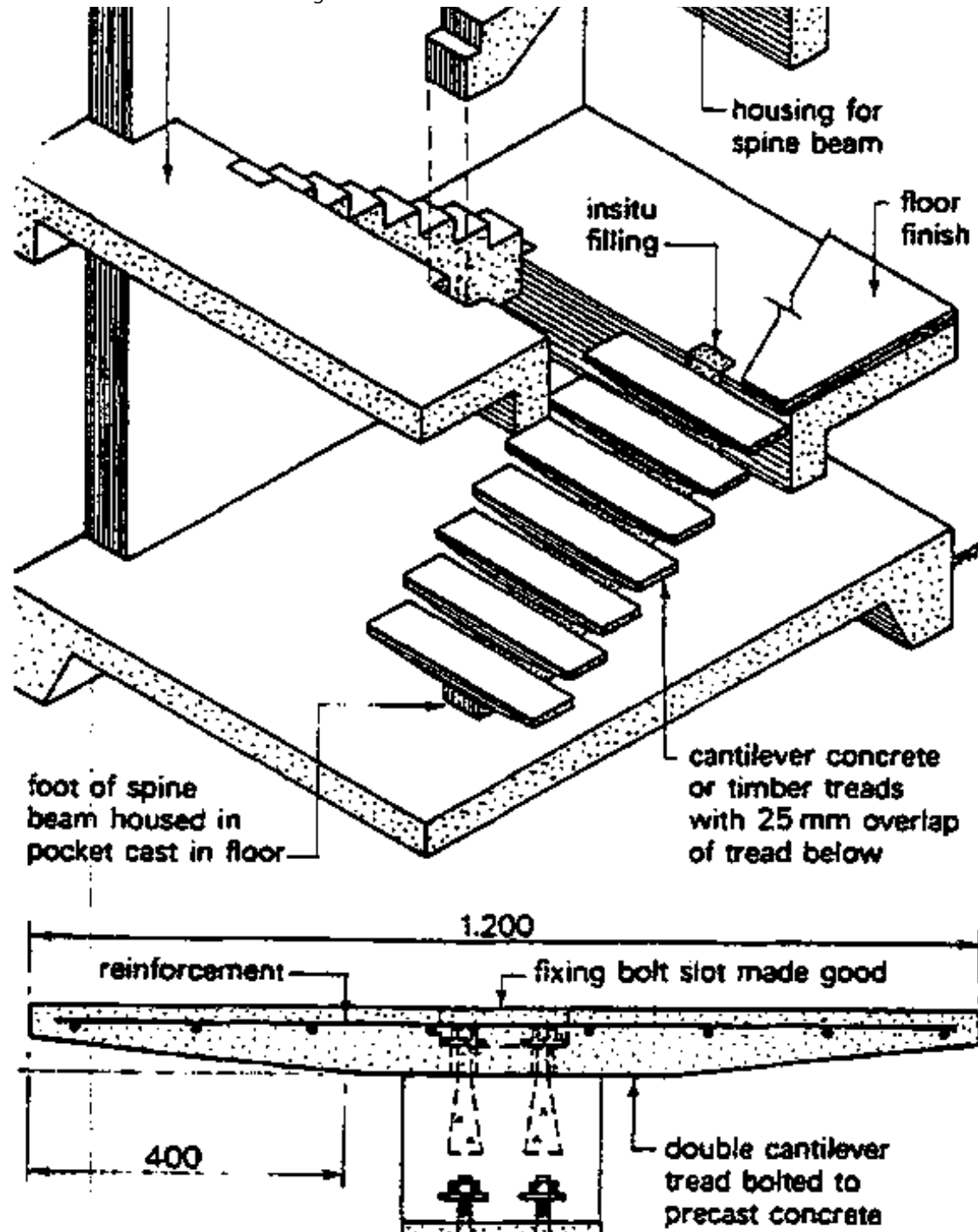



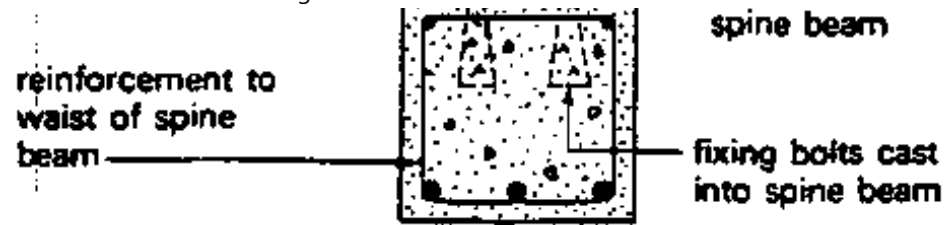

Precast concrete open riser stairs

## - Spiral Stairs

in precast concrete work are based upon the stone stairs found in many historic buildings.

- They are usually open riser stairs with a r.c. core or (alternatively) a concrete -filled steel tube core.
- Holes are formed at the extreme ends of the treads, to receive the handrail supports in such a manner that the standard passes through a tread and is fixed to the underside of the tread immediately below. A hollow spacer or distance piece is usually incorporated between the two consecutive treads.

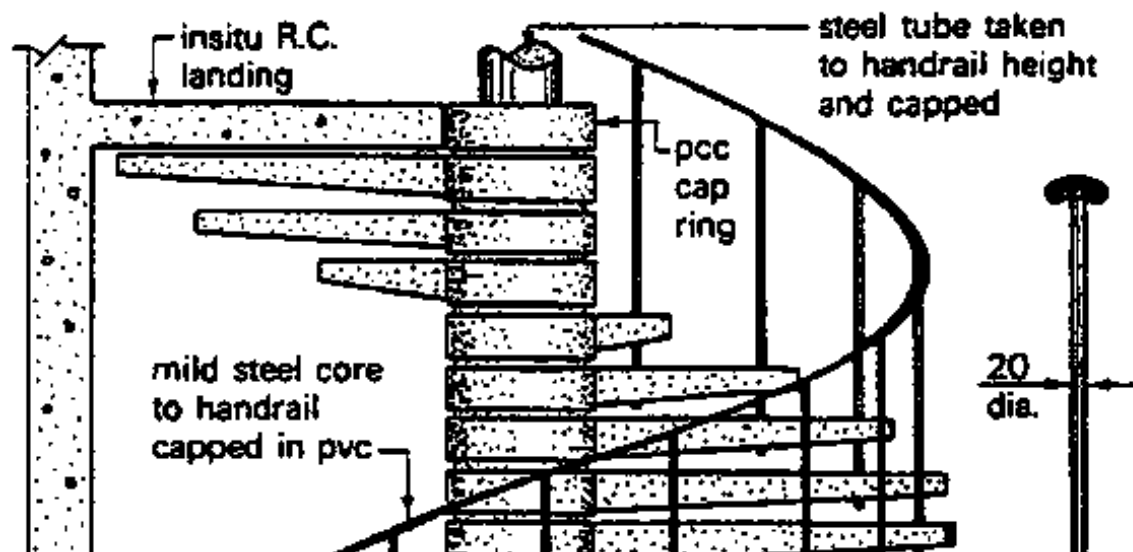

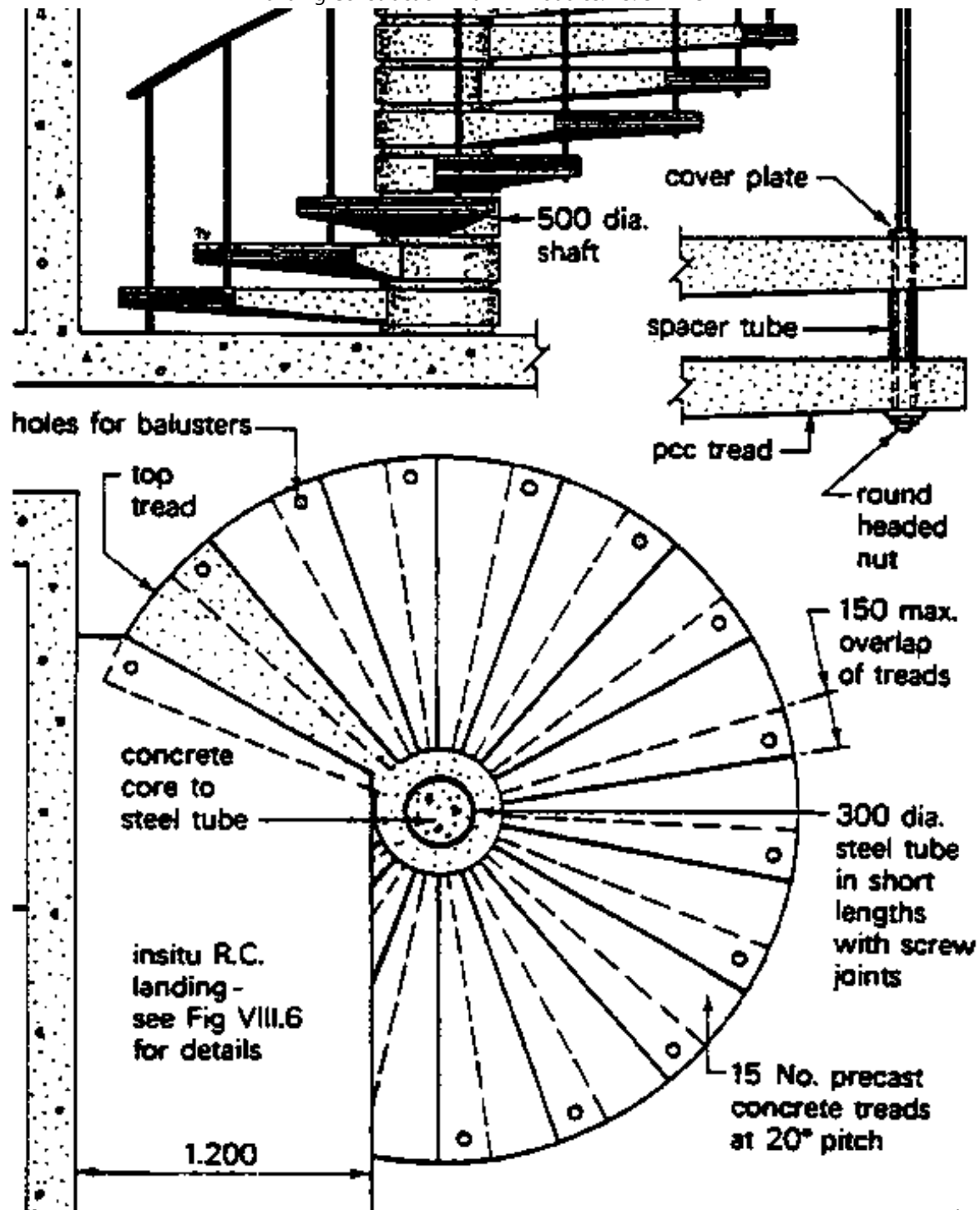

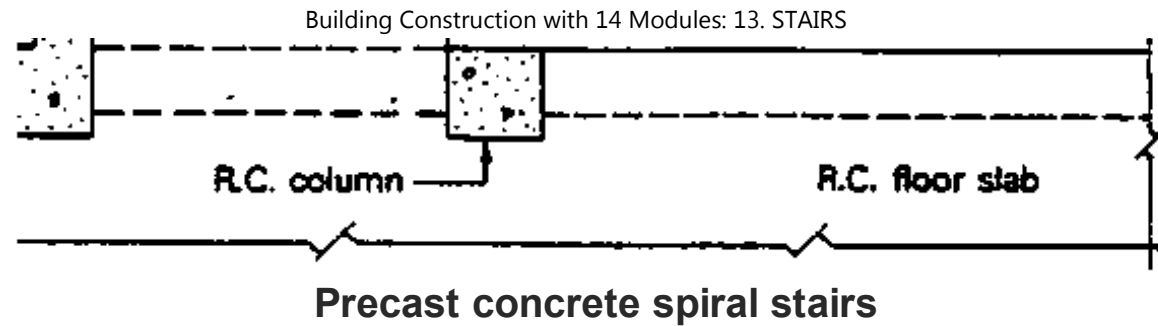

### 13.5.4 TIMBER STAIRS

- timber stairs are commonly used in domestic buildings with either

- closed or
- open rises.

- Due to the position of their supports four basic types of timber stairs may be produced:

#### I. Closed string stairs

The treads are tightly housed into the strings which are tied together with long steel tie bars under the first, last and every fourth tread. The nuts and washers can be housed into the strings and covered with timber inserts.

**Closed string open tread stairs**

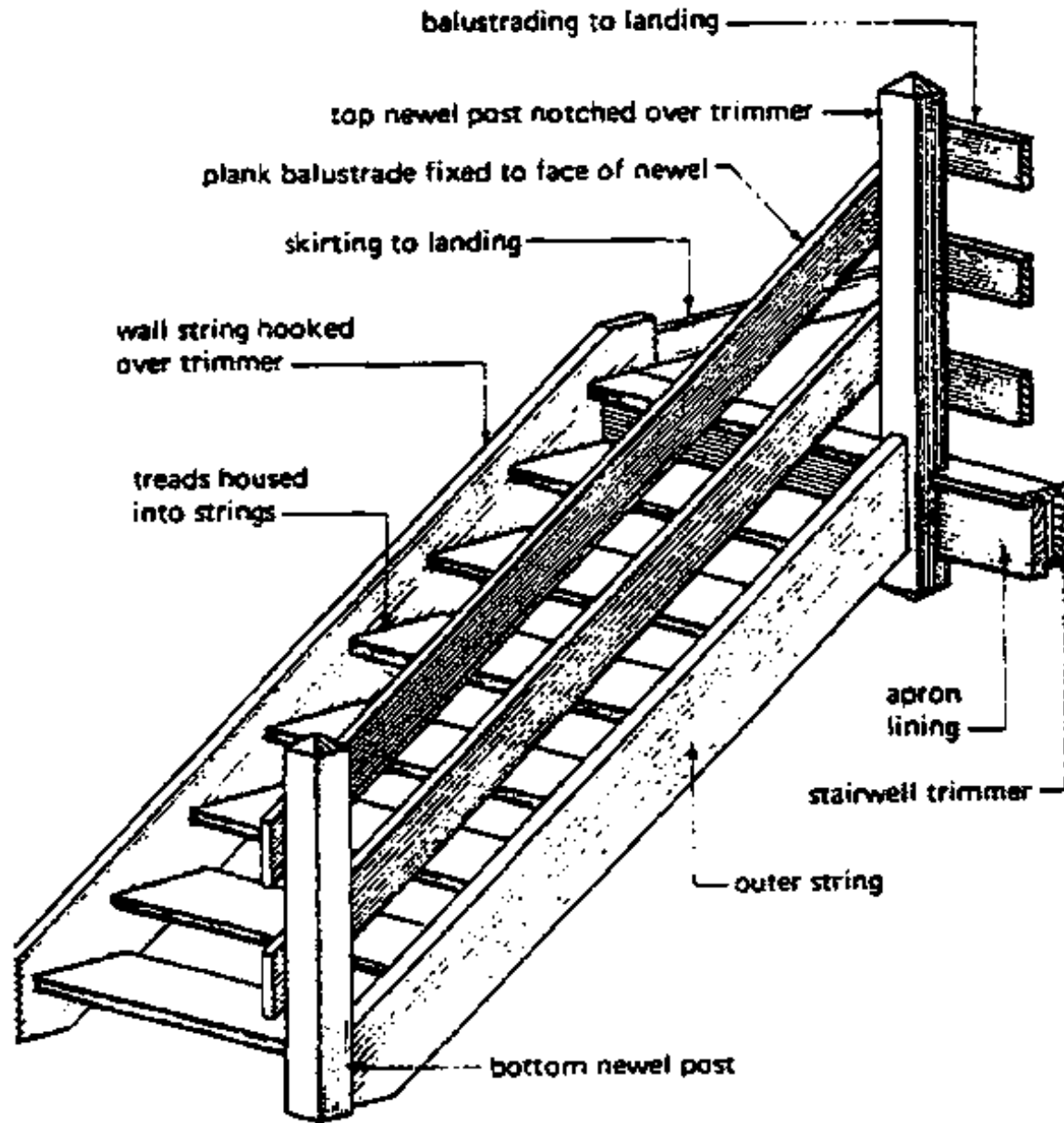

Typical arrangement

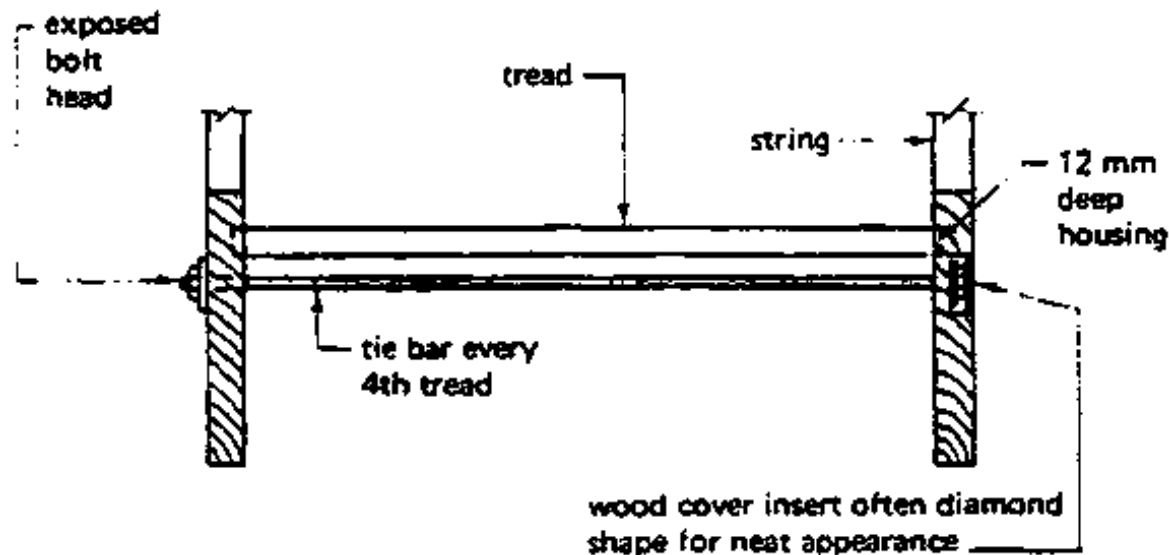

Alternative tie bar arrangements

## II Cut strings or Carriages

These are used to support cantilever treads and can be worked from the solid or of laminated construction. The upper end of the carriage can be housed into the stairwell trimming-member with possible additional support from metal brackets. The foot of the carriage is housed in a purpose male metal shoe or fixed with metal angle brackets.



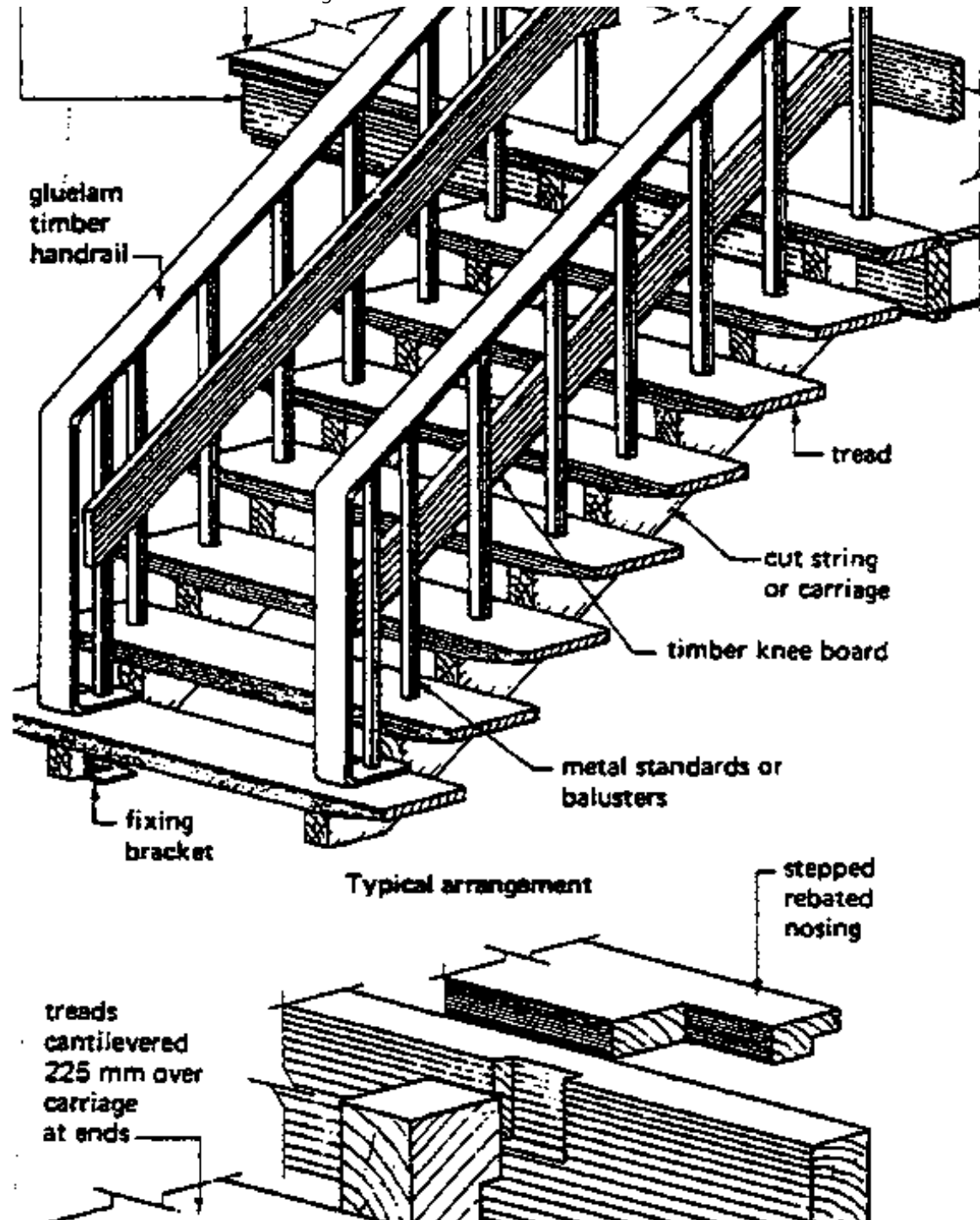

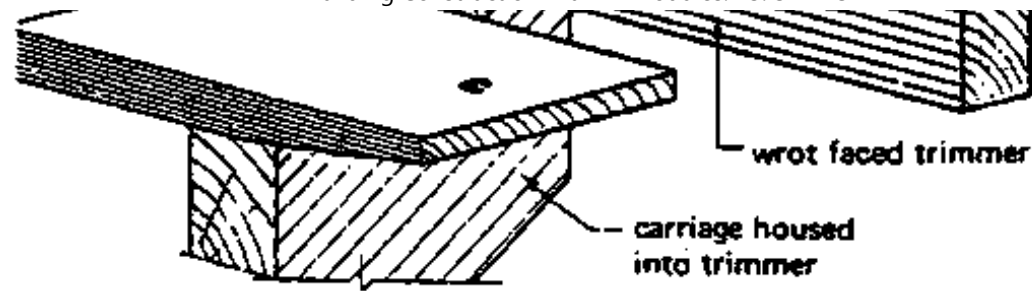

III Mono-carriage (or spine beam) employs a single central carriage with double cantilever treads. The carriage is of laminated construction and very often of a tapered section to reduce the apparent bulky appearance. The foot of the carriage is secured with a purpose made metal shoe in conjunction with timber connectors.

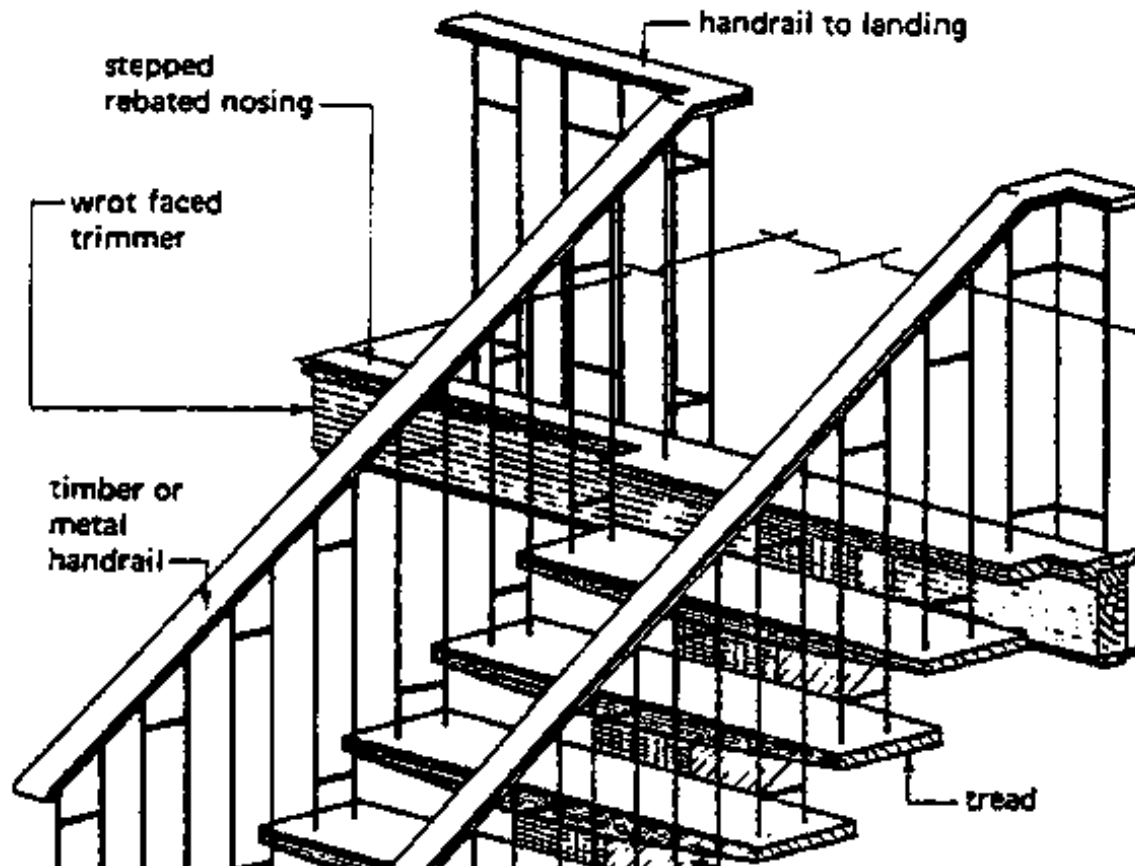

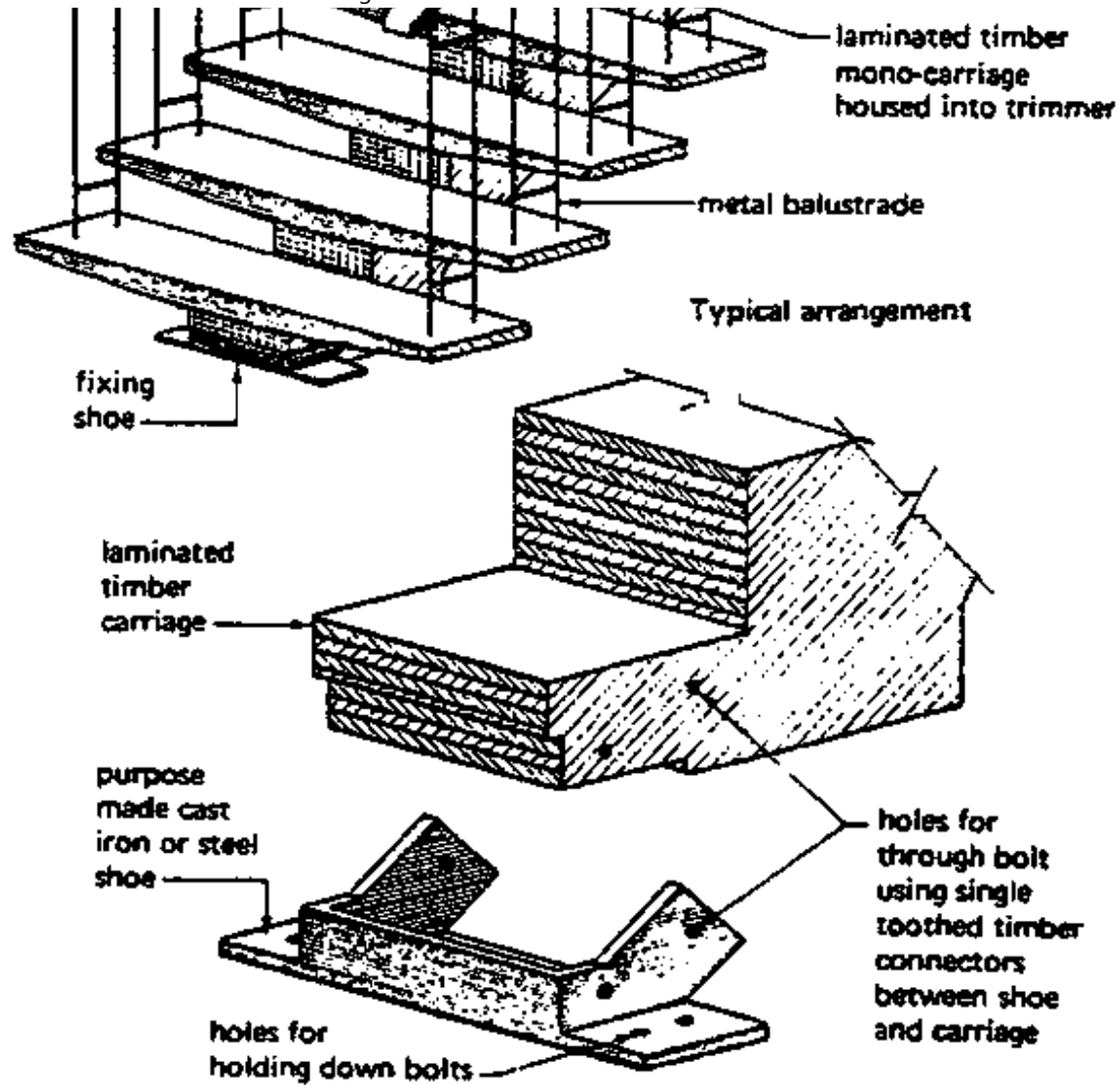

IV Hanging stairs consist of treads which are kept in position by tension bars



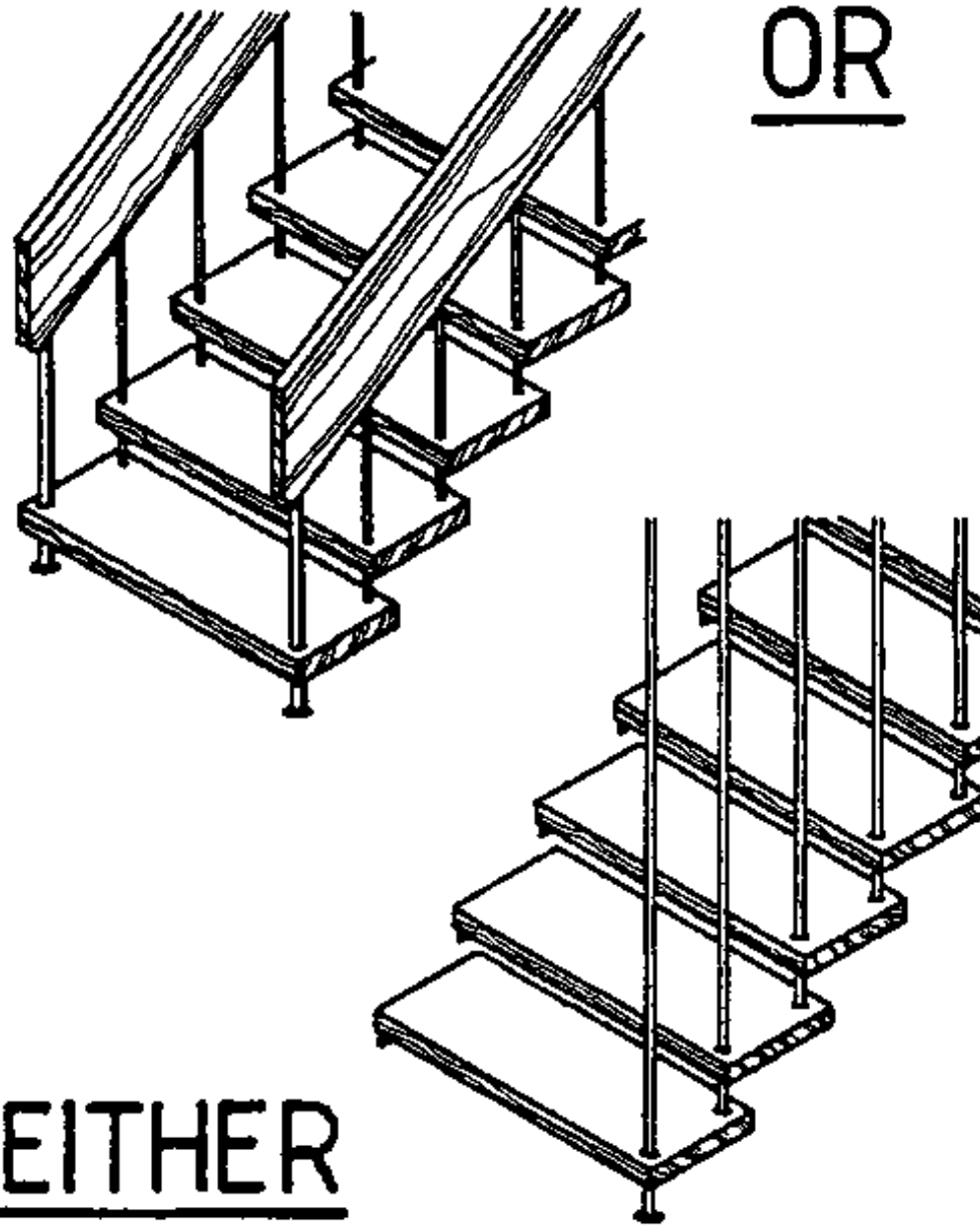

- There are two methods of hanging the treads:

Either tubular metal balusters, fixed at the ceiling, or a solid hardwood handrail are used as means of support for the treads.

- Out of the number of different types of staircases, only the construction of newel and ladder type stairs suitable for domestic buildings will be considered

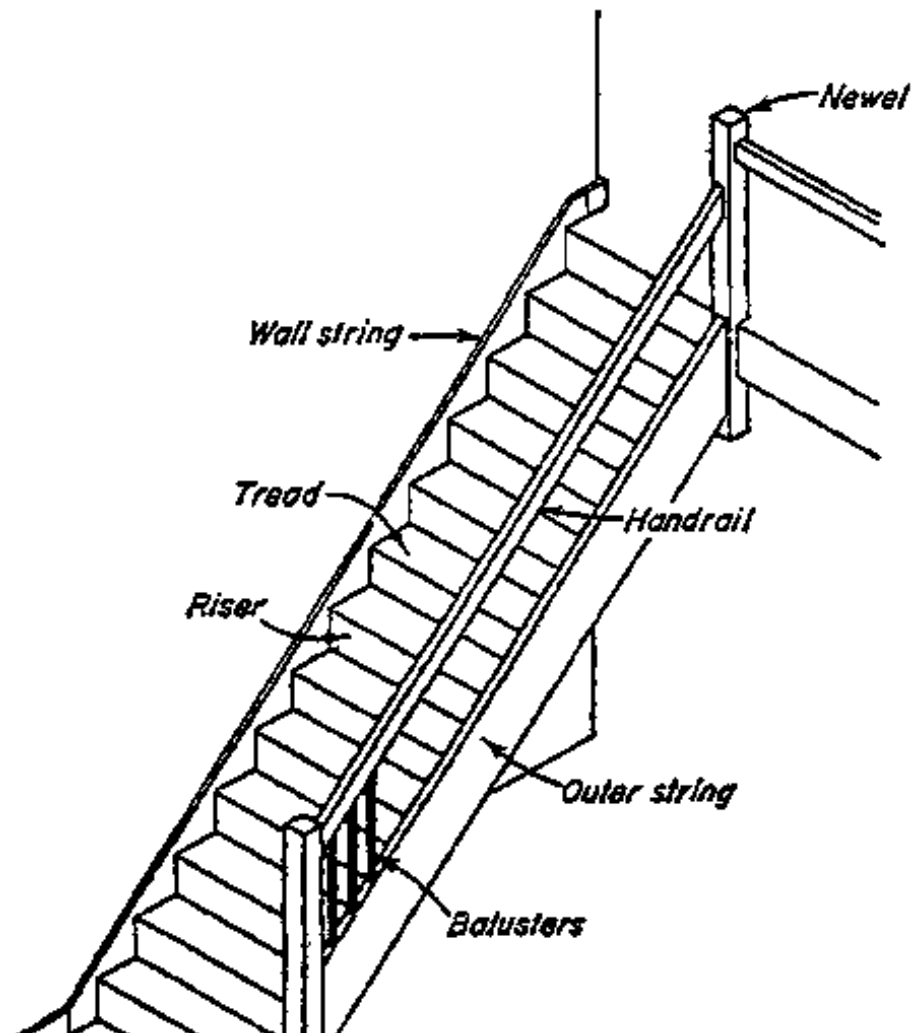



## CLOSED-RISER STAIRS WITH CLOSE STRINGS

### Straight flight stairs

may be constructed between walls which give it continuous support or it may be open on one or both sides.

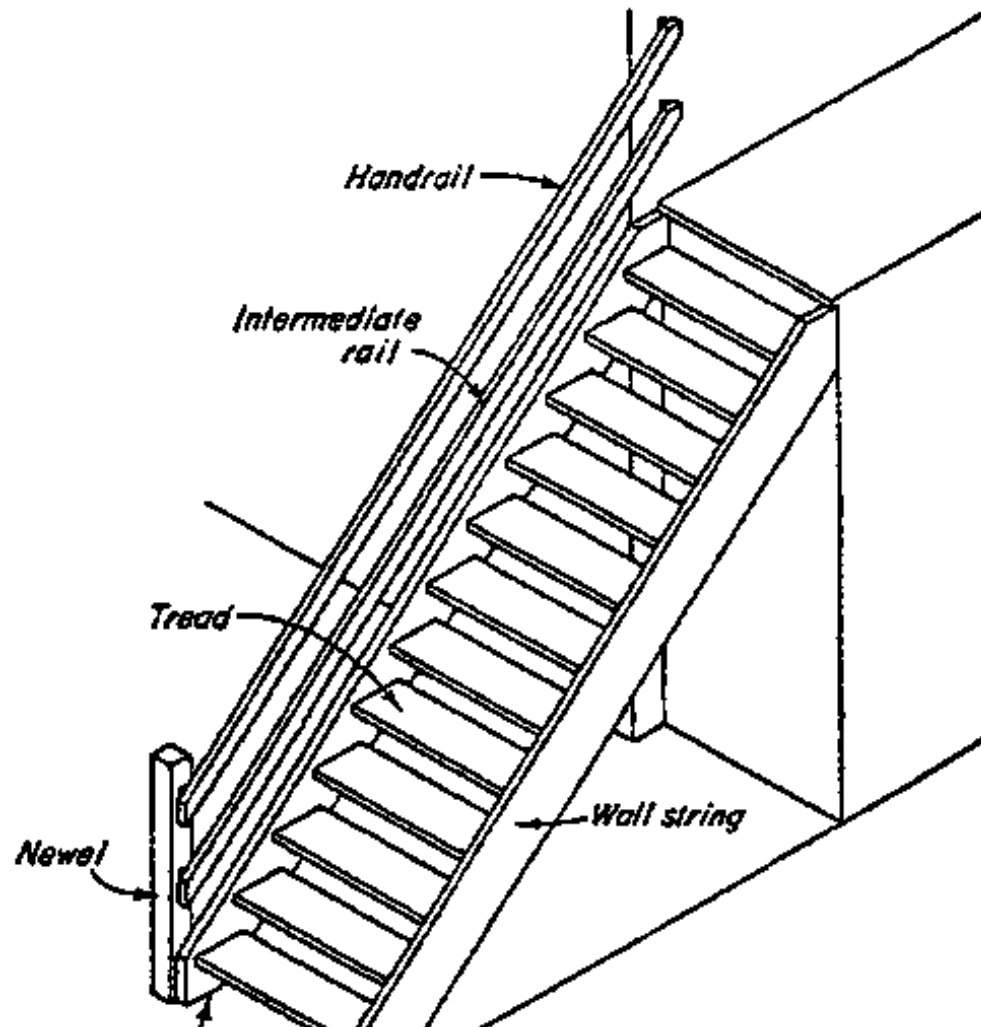



- The sizes of members are not usually calculated, they are determined out of experience.
- Treads: 32 mm thick (27 mm plained)
- Risers 25 mm thick (21 mm plained)
- Method of fixing

The top edge of the riser may be simply butted against the underside of the tread, but the Joints should then be covered by a snail mould fixed to the tread. (to conceal any gap formed by shrinkage)

- Projection of nosing: not more than 25 mm. The nosing profile may be square, slightly splayed with rounded top edge or halfround.
- an alternative 13 mm plywood may be used for the risers (ref. fig.)
- The ends of the treads and risers are housed into grooves or housings - about 12 mm deep - formed in the strings. The housings are wider than thickness of tread and riser. They are tapered so that hardwood wedges, after covering with glue, may be driven behind the treads and risers forcing them tight against the outer faces of the housings.

Triangular blocks of wood are glued at the junctions of the treads with the risers and strings to give increased rigidity to the whole staircase.

- **Wall string:** about 38 mm thick securely plugged to the wall

- Wall string, about 50 mm thick securely plugged to the wall.

- Outer string 45-50 mm thick

It must be thicker than the wallstring as it acts as an inclined beam. (Whereas the former serves as a plate, supported by the wall).

- For stairs wider than 90 cm it is desirable to introduce intermediate support in the form of

100 × 75 mm or

100 × 50 mm rough bearers or carriages under the steps.

- The outer string is framed in to 100 × 100 mm newels at top and bottom of the flight. The strength of newel stairs depends largely on the rigidity of the joint between the string and newelpost. The normal method of joints the two is shown in the figure. This consists of a draw-pinned joint consisting of two obtique haunch tenons on the end of the string fitted into mortices formed by the newel. The whole is secured by a slightly tapering hardwood dowel at each tenon. The newel post - like the strings - is housed to take the treads and risers and is (in addition) notched to fit over the landing trimmer to which it is nailed or - preferably - bolted. The junction with the lower newel is similar, but the joint is reversed as shown.

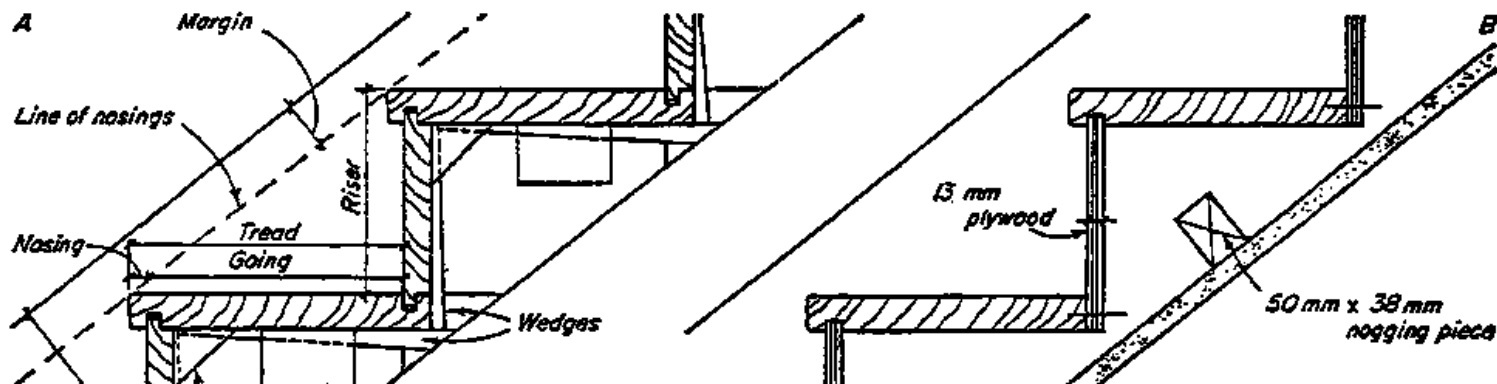

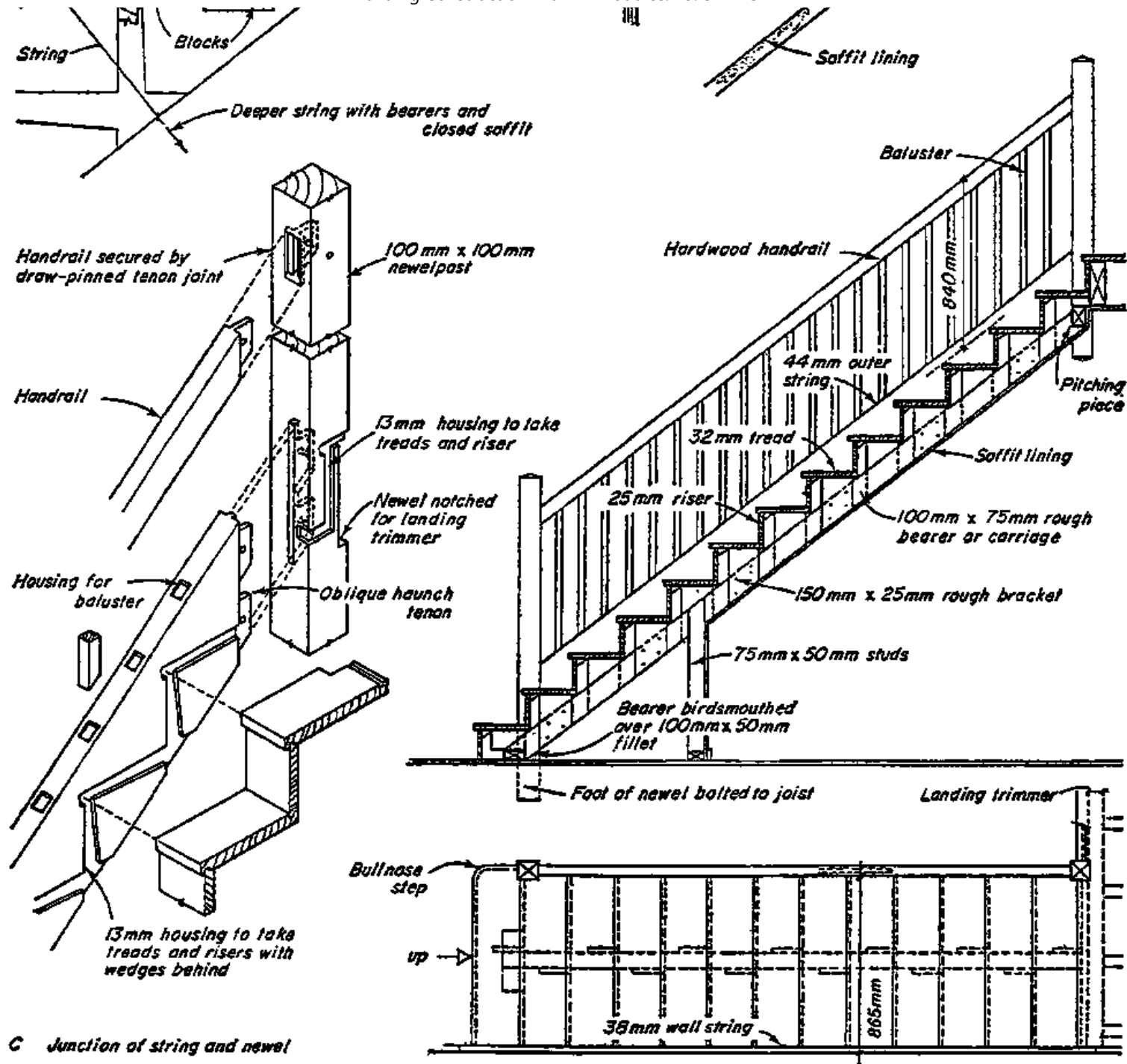

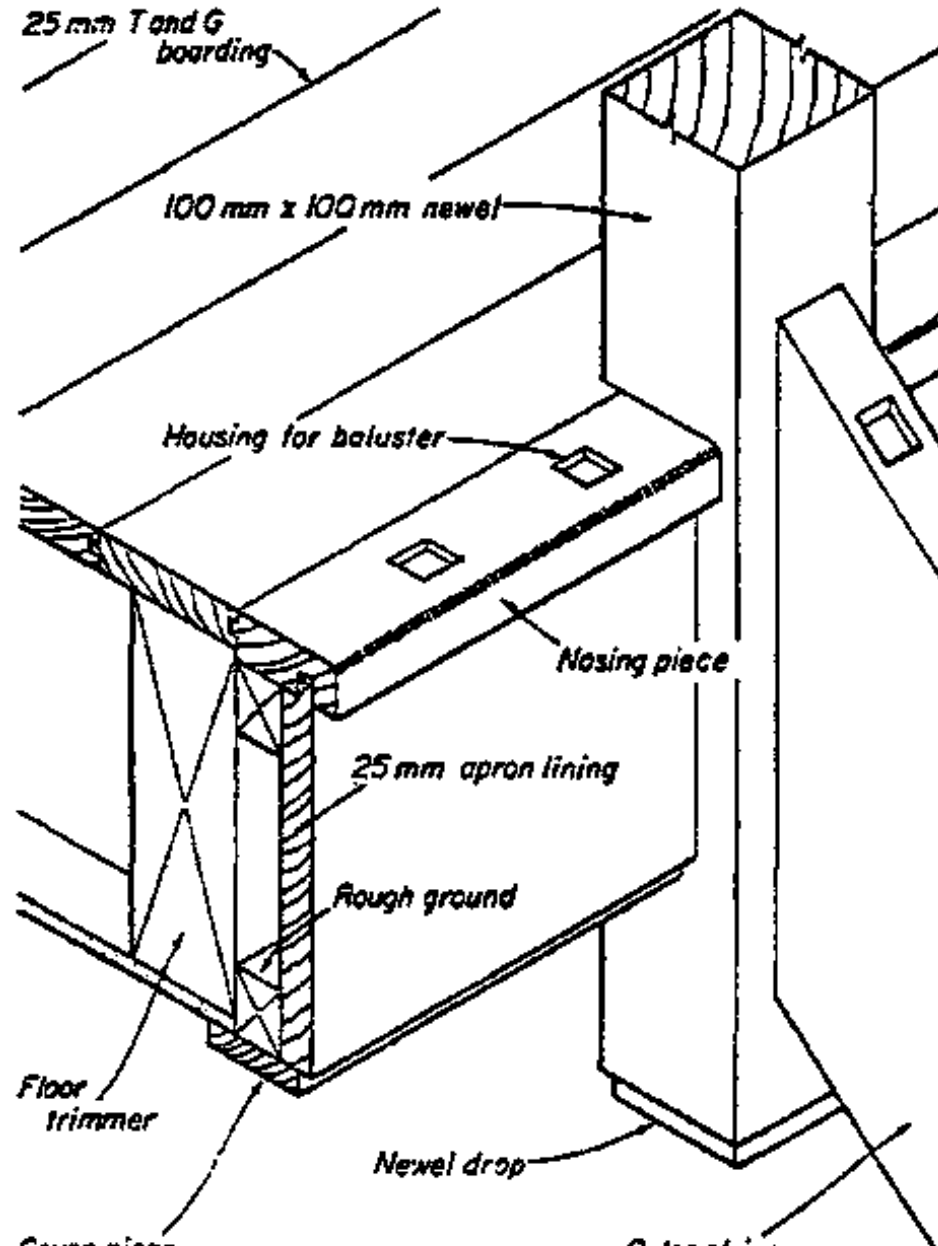

## Apron lining to landing

For architectural reasons the newel at the bottom of a stair case is usually set back one (or sometimes two) risers.

- The entry to the stair is less abrupt and may be made slightly from the side as mounting commences.

A specially shared end to the bottom step (or steps) must be formed as shown in the examples illustrated.

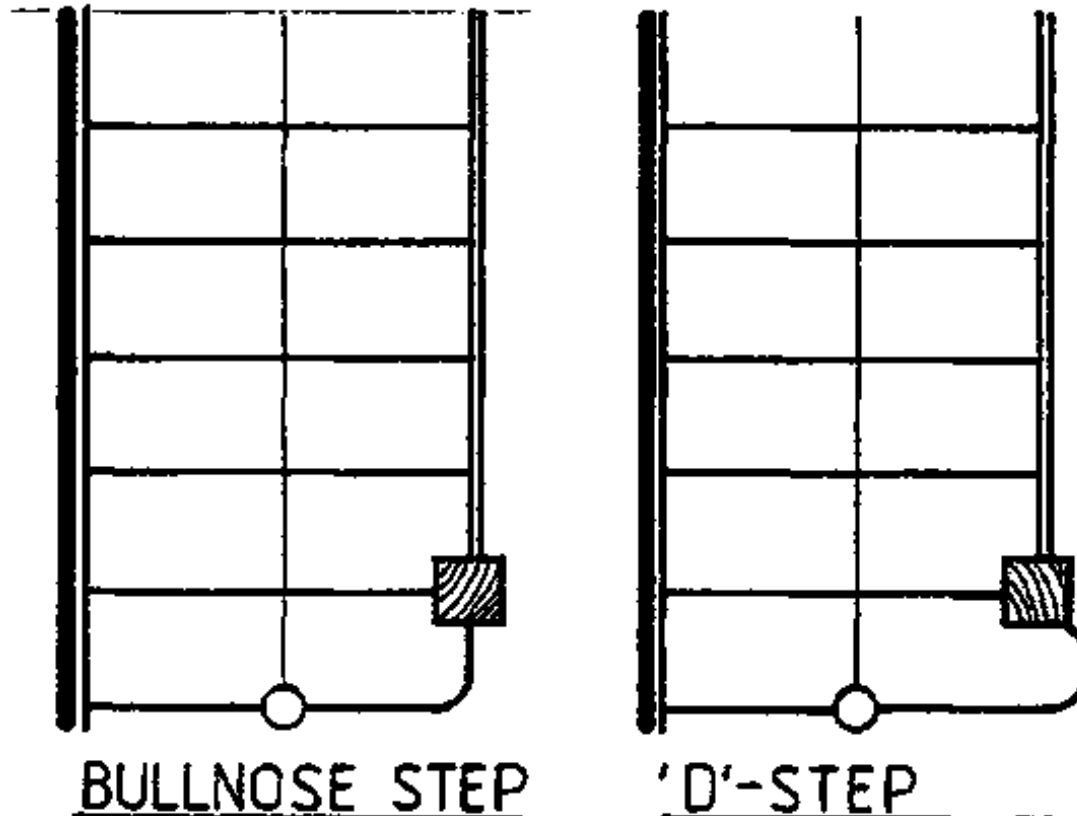



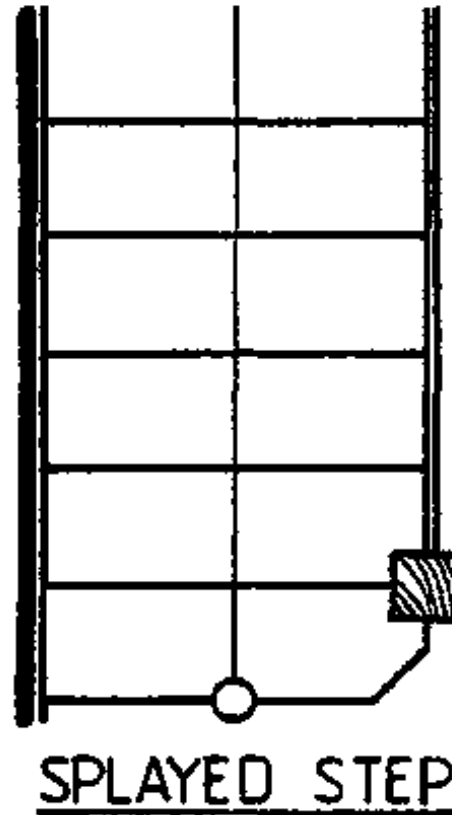

The foot of the lower newel should be taken through the floor and bolted to a convenient joist, to give a fire and secure connection. The upper newel extends a short way below the string. This is termed a newel drop.

- Ends of handrails should be housed slightly into the newels and fixed by draw-pinned tenon joints.
- The trimmer to the upper floor landing is faced with an APRON LINING, tongued and grooved at the top to a nosing piece (preferably the same thickness as the stair treads, into which any landing balusters are housed and the floor boards tongued and grooved.

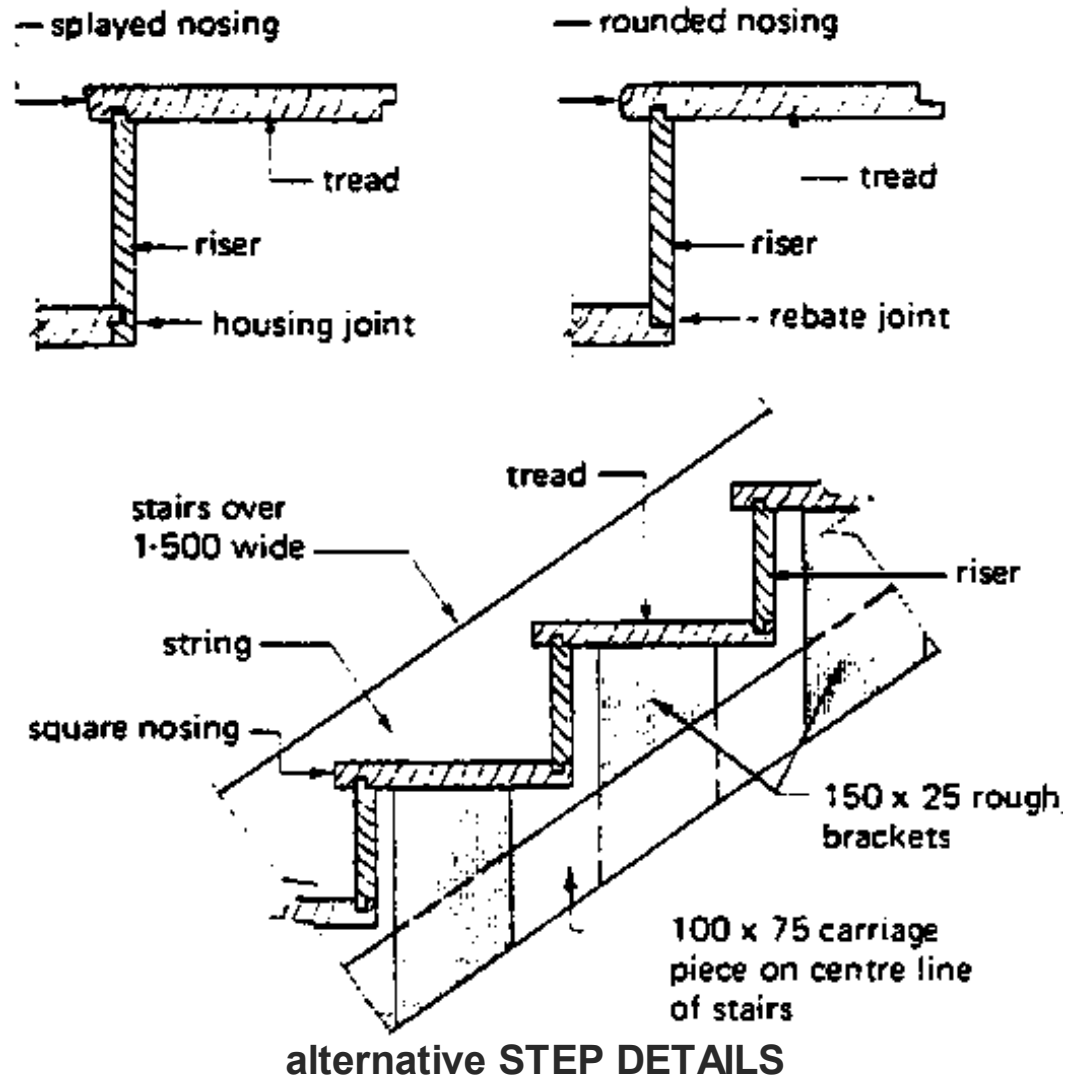

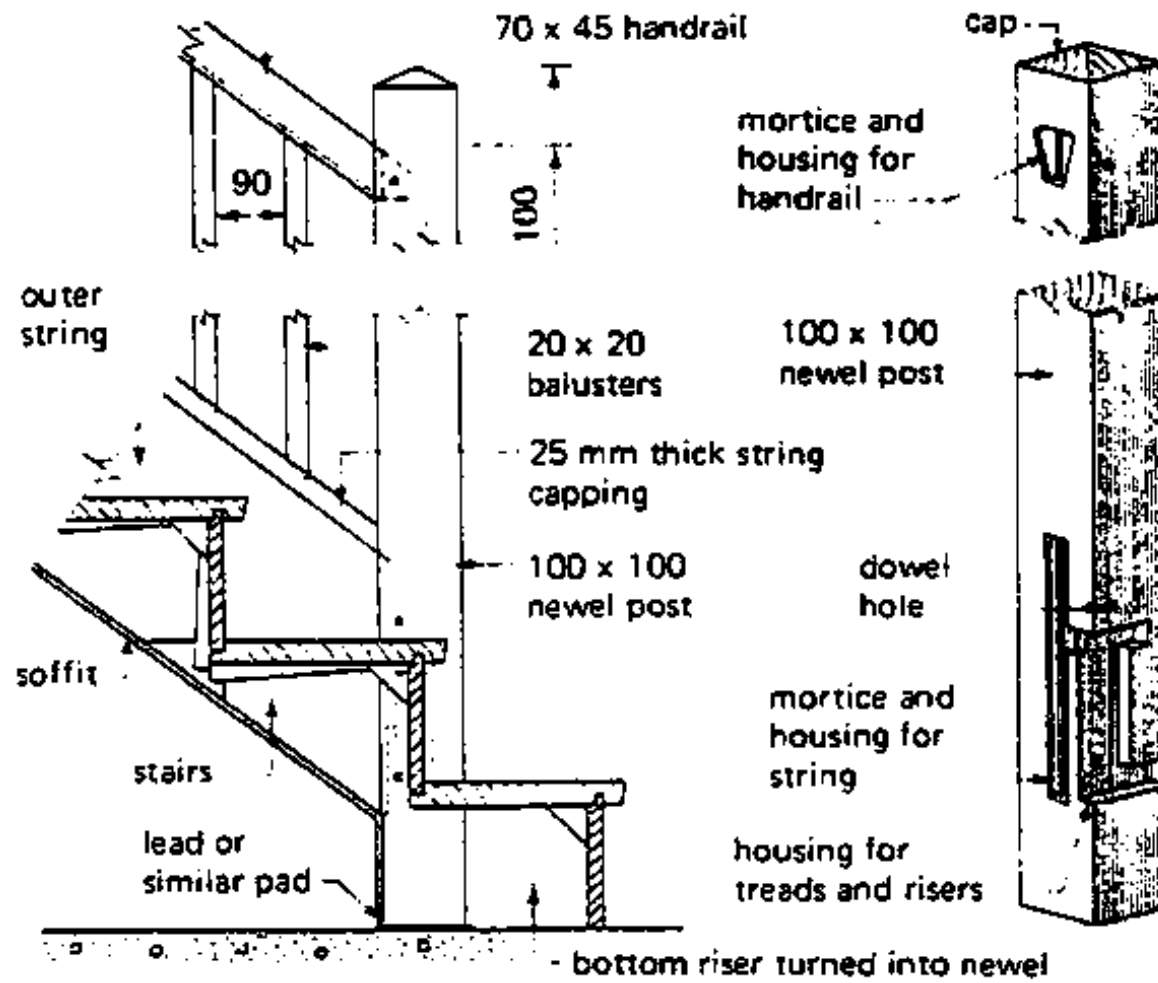

**detail at: BOTTOM NEWEL**

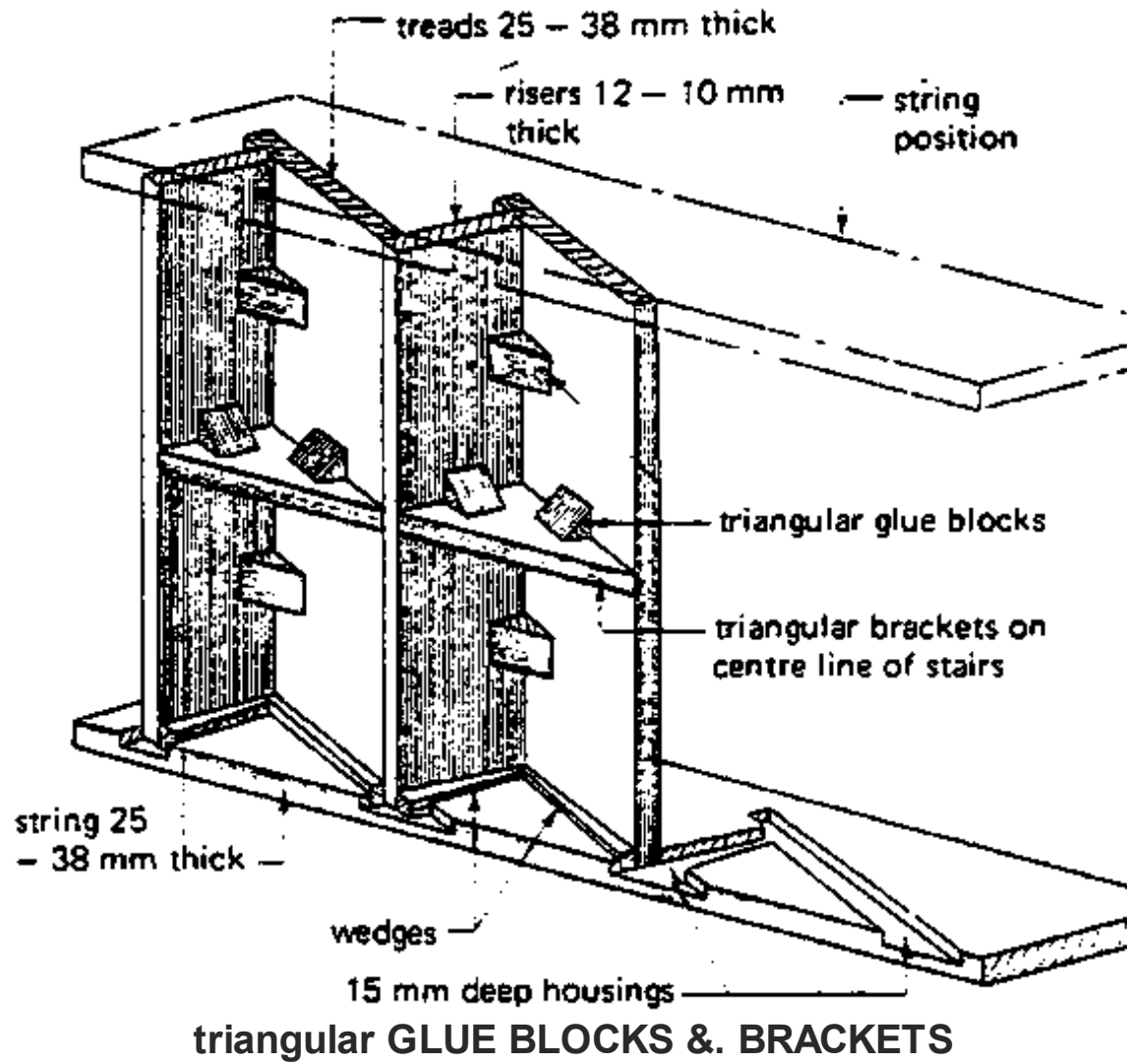

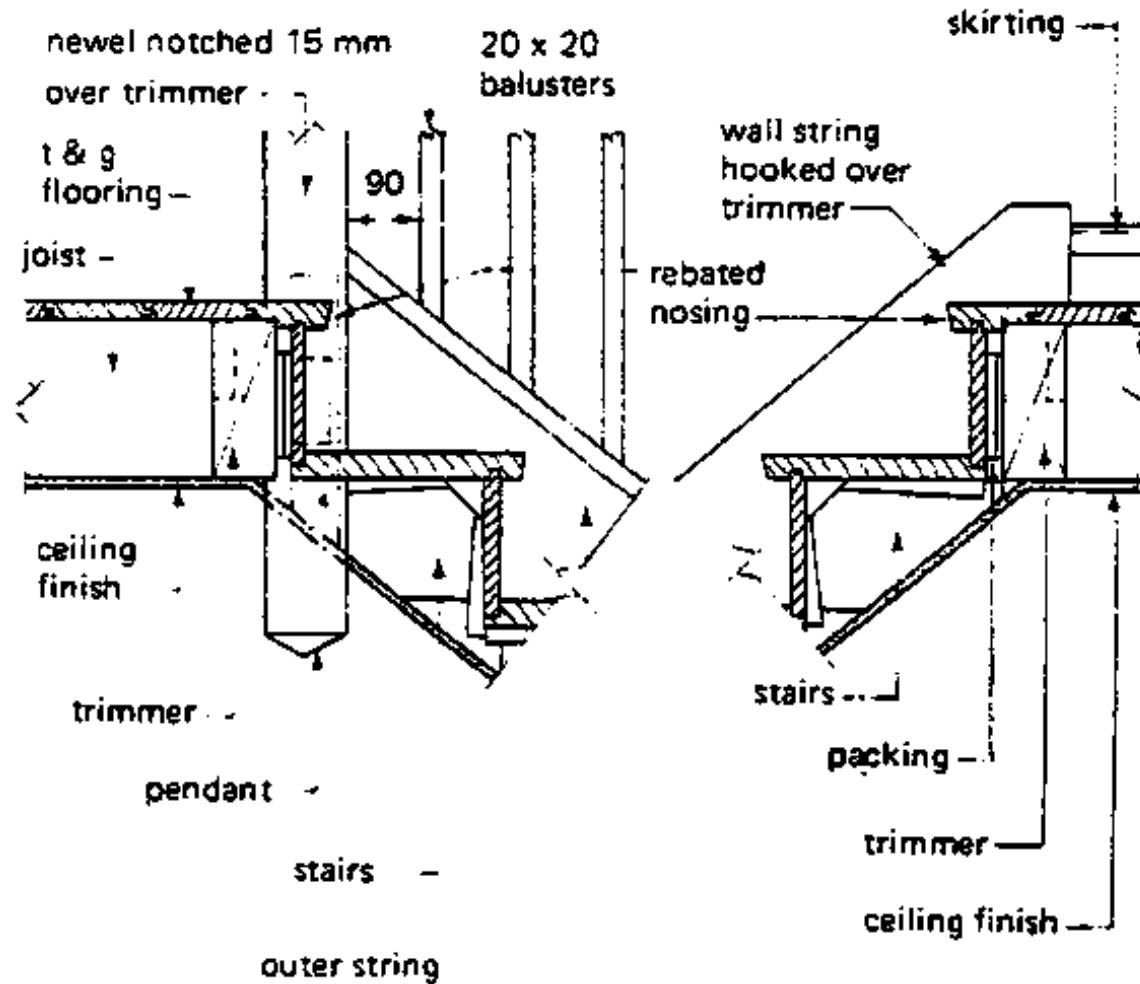

details at: LANDING

Open-riser or ladder stairs

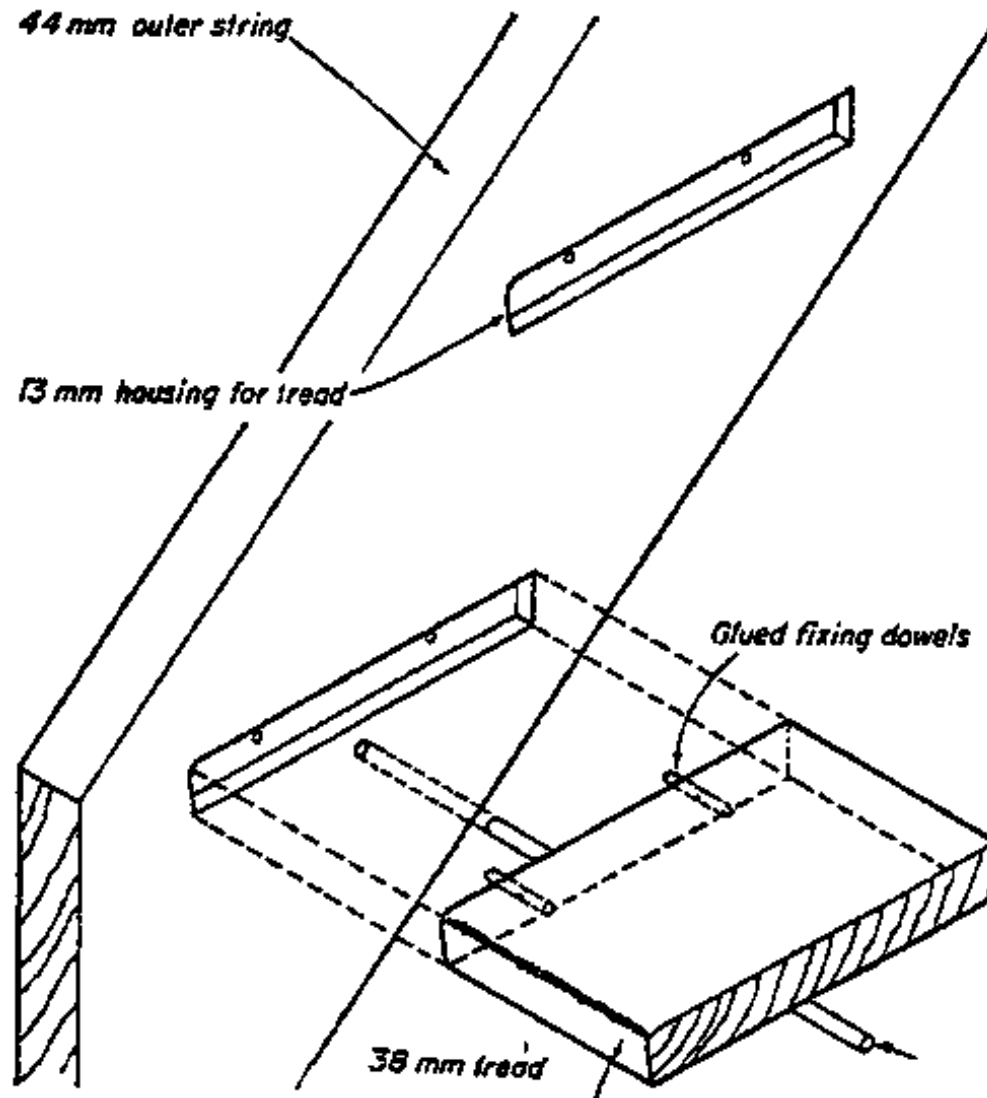

may be constructed with close or cut strings.

- When close strings the connection between the ends of the treads and the strings is not as good as in a closed-riser stair, since there are no wedges or side blocks connecting the two.

**Therefore:** The strings should be tied together by 10 mm or 12 mm  $\varnothing$  metal rods with sun and pelleted ends placed under every 4th tread.

- Screw fixing: is not very strong as the screws enter the end grain of the tread.
- Glued dowels are better than screws.
- Cut strings are tied together by the treads which rest upon the string and are screwed to it.

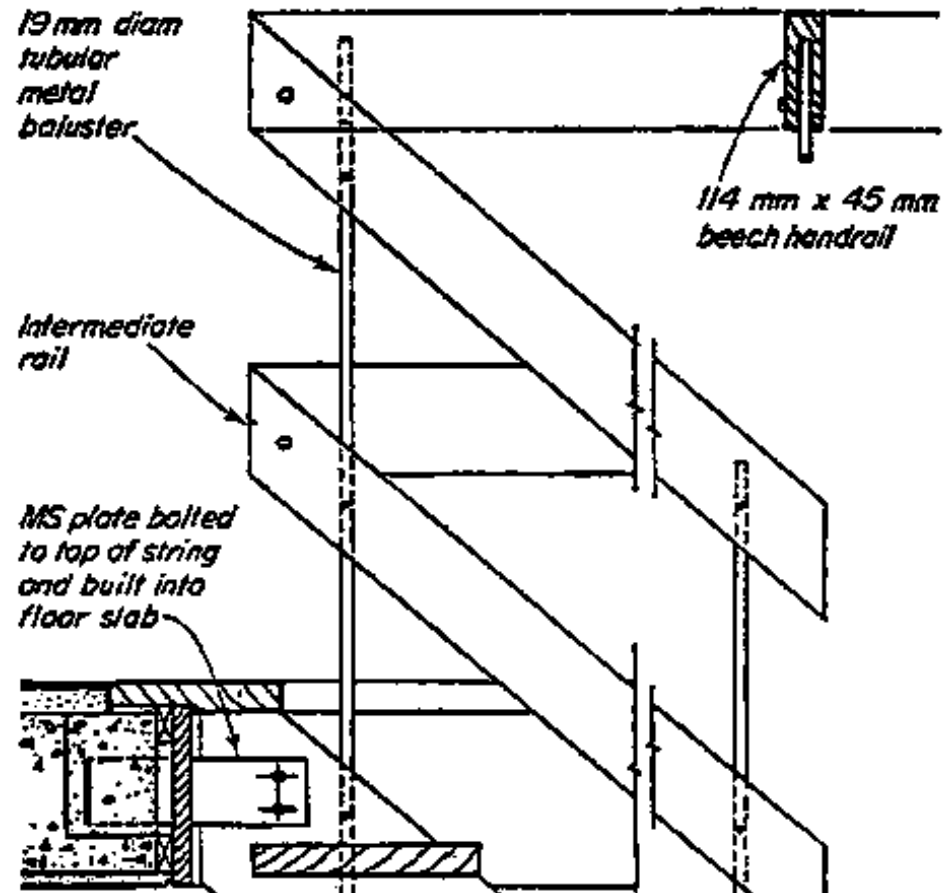

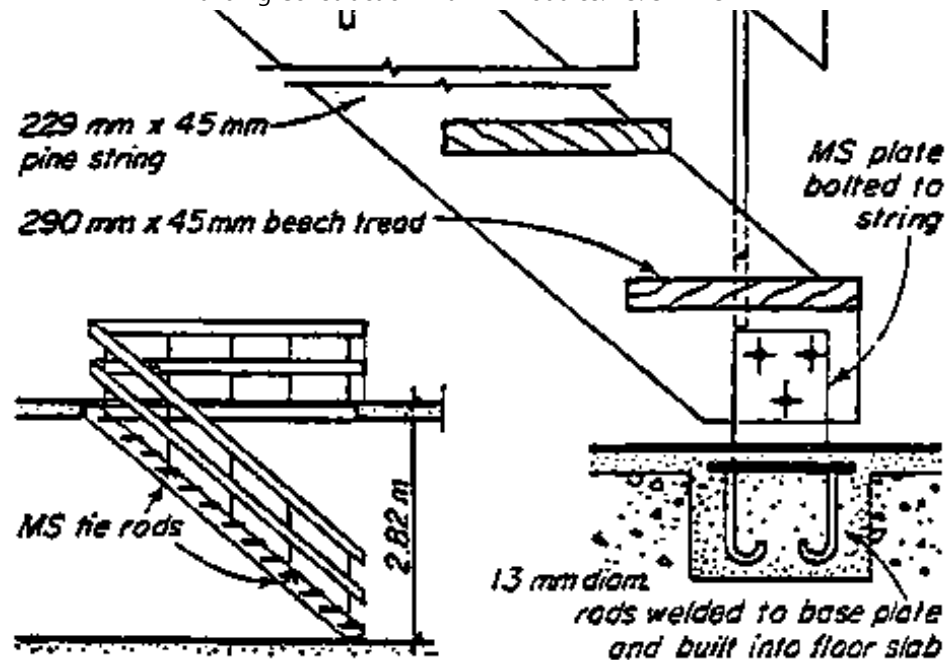

- With open-riser stairs no support is given to the tread by a riser. So the treads should be at least 38 to 44 mm thick. The treads are generally of hardwood.

- In case no newels are seen in the stair, this necessitates a direct fixing of the strings to the floors (for example: M.S. plates to which the strings are bolted are cast in the concrete floors).
- Alternative methods of securing the top of an open-riser stair are by fixing the strings directly to the wall face or by fixing to the upper floor by means of a head piece do-welled to the tops of the strings.

## DOG-LEG STAIR





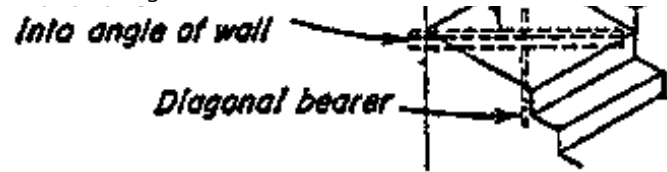

- The use of a single newel at the landing into which both outer strings are framed produces an elevation (the V-junction of strings) which gives rise to the name of the stair.
- Constructional details of the flights are identical with those already described for the straight flight stair -except at certain points at the half - space landing and its newel.

The latter is usually continued down to the lower floor for the sake of rigidity and fixed at the foot to the floor joist.

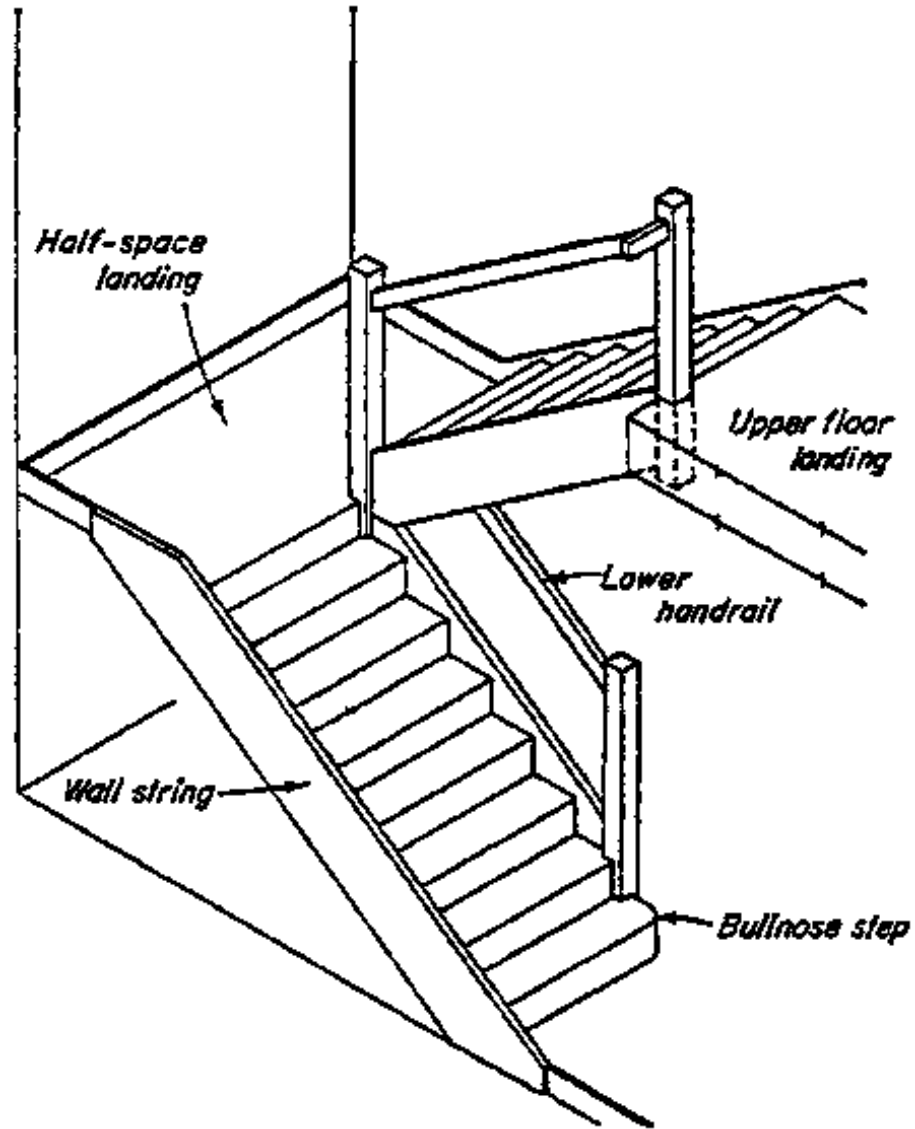

**Dog-leg stair**

The strings bult against each other on an horizontal line, about 50 mm wide, outside the face of the newel.

The half-space landing, is formed of 100 mm × 50 mm joists supported by the trimmer at one end and by the stair case wall at the other.

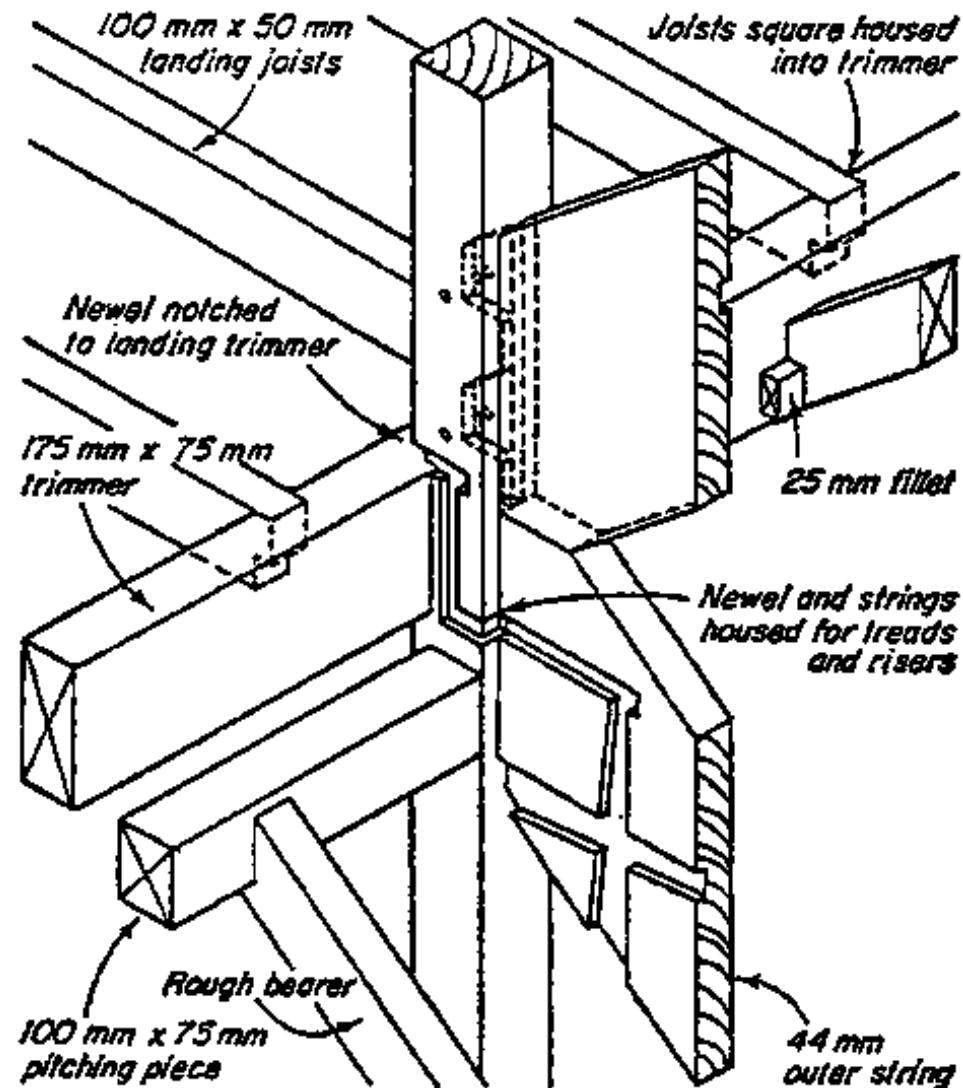

## OPEN WELL STAIR

gives a better appearance than a dog-leg-stair and a continuous handrail up to the landing newel.

All relevant details are similar to those described for the previous stairs.

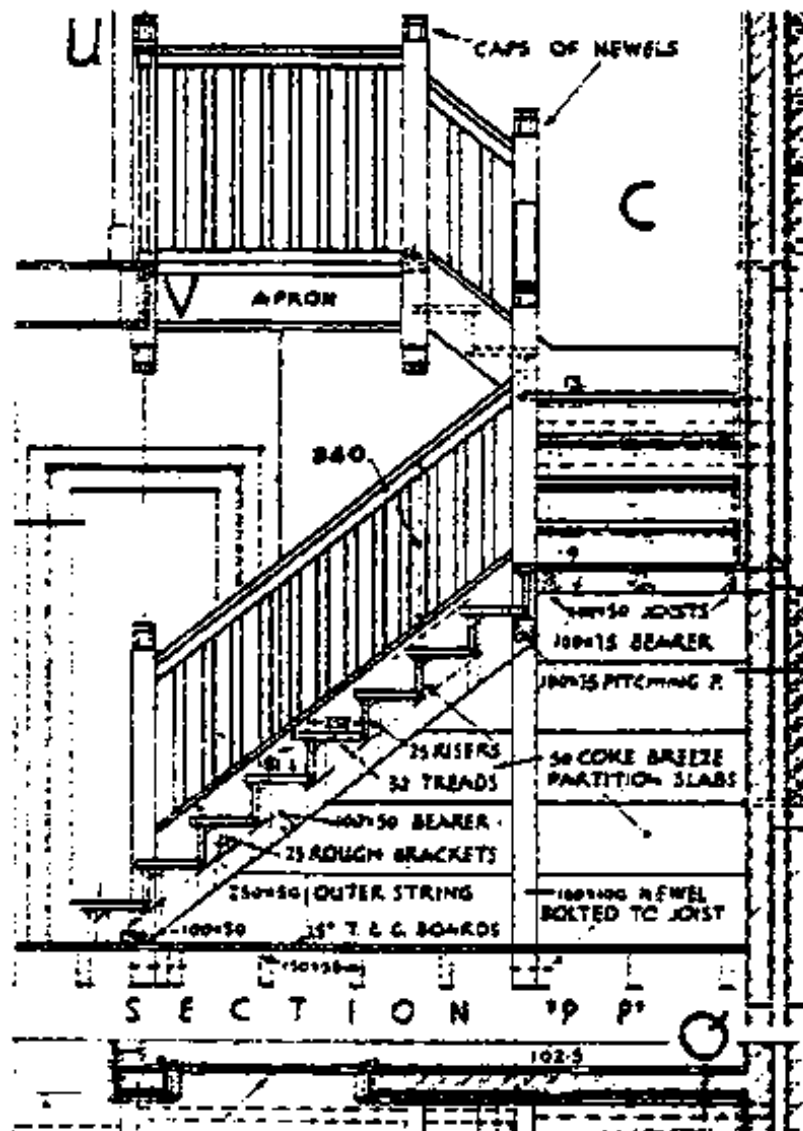

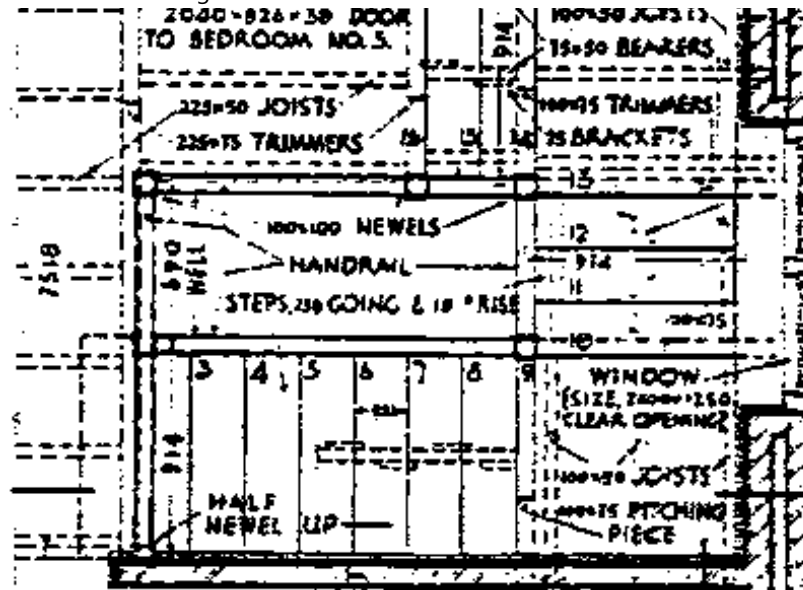

If the landing is half-space, the landing newels may terminate just below the landing as on the upper floor. The section of landing exposed between the newels is finished with an apron lining.

If a very narrow well is adopted (say 75 to 100 mm), a single newel about 250 mm wide is preferable to avoid an extremely small space between a pair of newels and its accompanying problems at handrail and landing level.

If an intermediate flight is incorporated, quarter-space landings will be formed; in small domestic stairs then landing will support itself (provided the surrounding walls are capable).

In larger stairs it is necessary to provide support to the trimmers of the landings: most simply by carrying the landing newels down to the floor below 'or: the landing and the newel may be supported on cantilever construction.

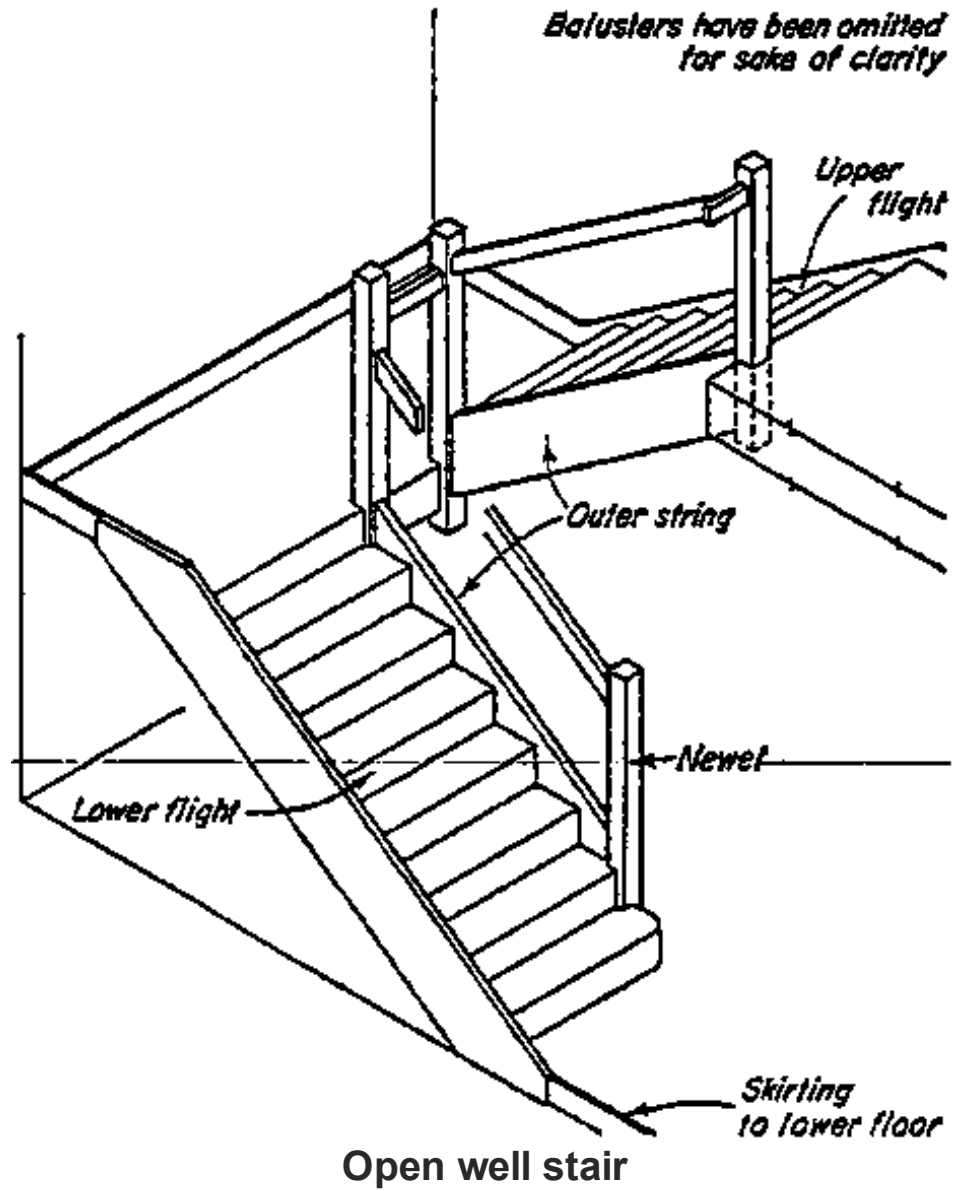

### 13.5.5 METAL STAIRS

are used as

- escape stairs
- internal accommodation stairs
- external accommodation stairs.

- Most metal stairs are manufactured from mild steel and in straight flights with intermediate half space landings.

Spiral stairs in steel are also produced but their use as an escape stair is limited by size and the number of persons likely to use the stairway in the event of a fire.

Aluminium alloy stairs are also made and are used almost exclusively as internal accommodation stairs.

- All steel stairs have the common disadvantage of requiring regular maintenance in the form of painting; as a protection against corrosion.

- Most metal stairs are supplied in a form which requires some site fabrication and this is usually carried out by the suppliers site erection staff. The main contractor having been supplied with the necessary data as to foundation pads, holding-down bolts, any special cast-in fixings and any pockets to be left in the structural members or floor slabs to enable this preparatory work to be completed before the stairs are ready to be fixed.

#### - STEEL ESCAPE STAIRS

The treads of this type of stair are bolted to the strings and can be of a variety of types ranging from perforated cast iron to patterned steel treads with removable non-slip nosings.

perforated cast iron to patterned steel treads with renewable non slip nosings.

Handrail balustrades or standards can be of steel square or tubular sections bolted to the upper surface of a channel string or to the side of a channel or steel plate string.

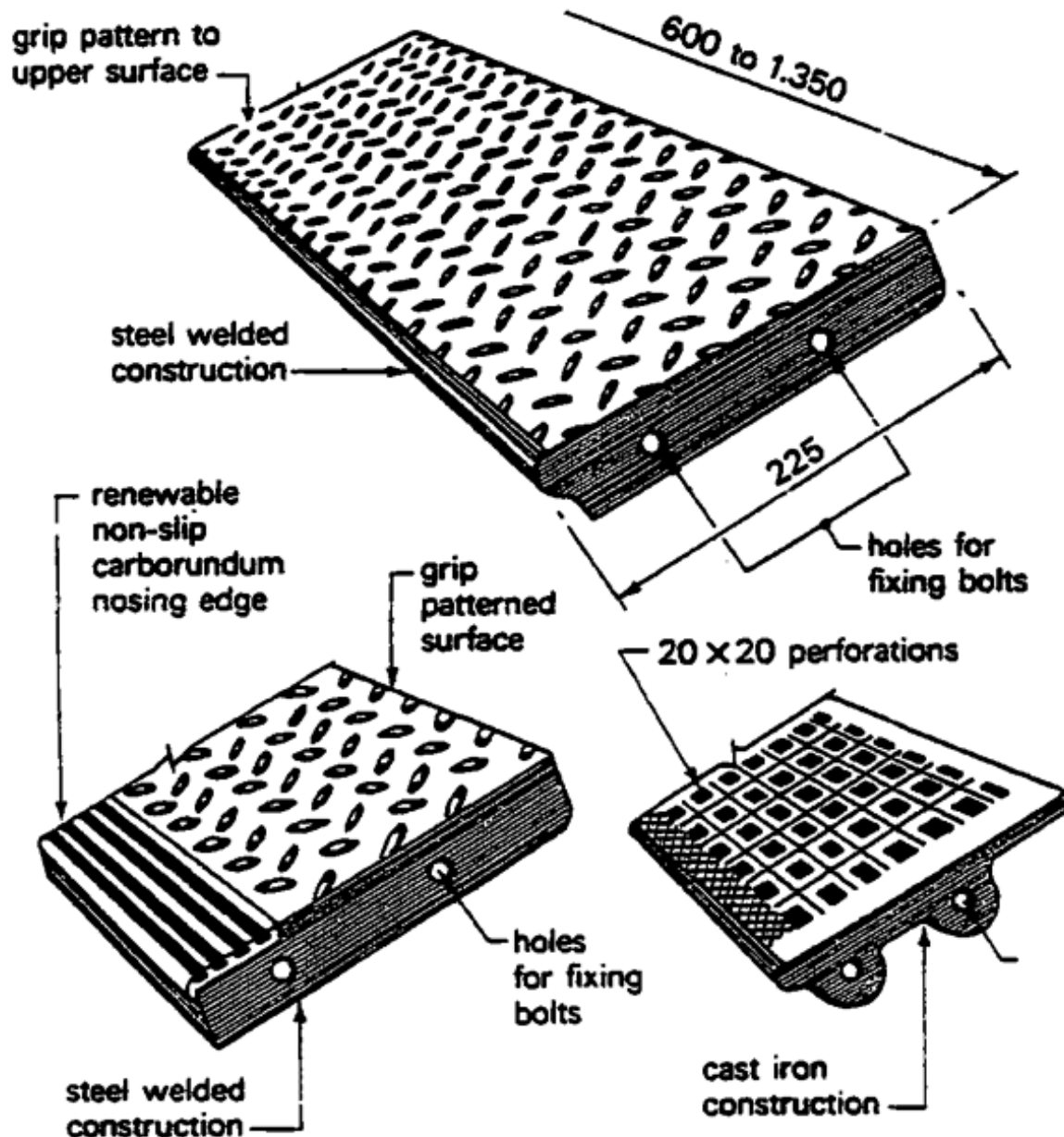



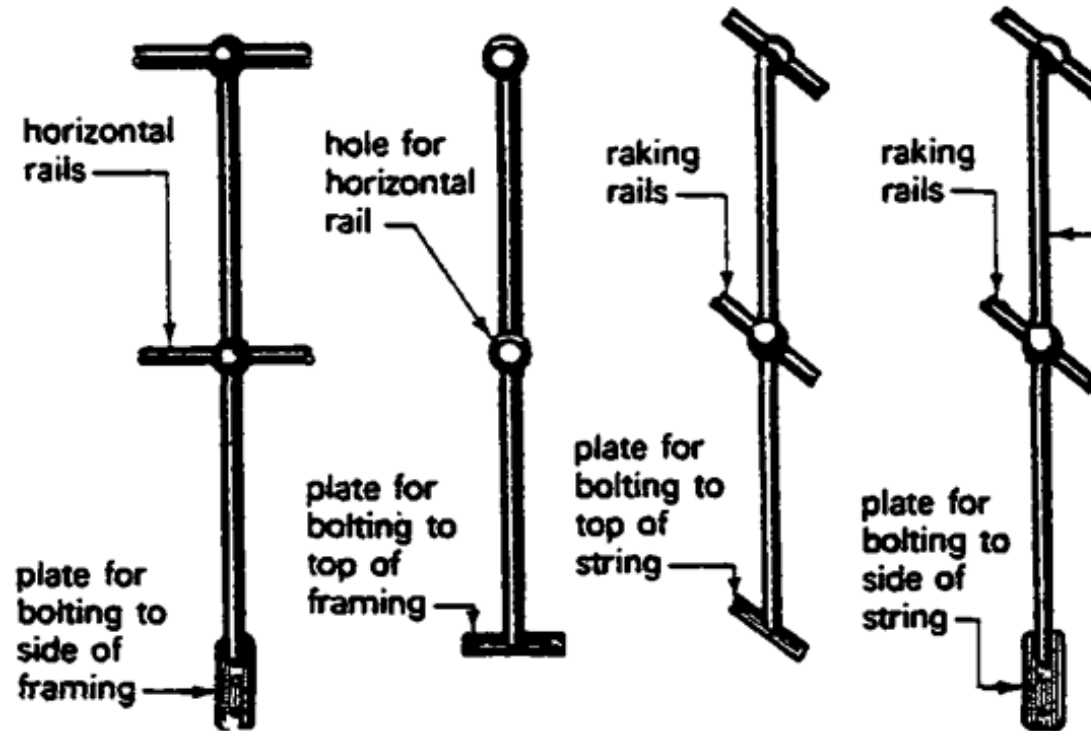

### - Steel spiral stairs

are allowed as an internal or external means of escape stairs if they are not for more than 50 persons. The maximum total rise is 9,00 m and the minimum overall diameter is 1,50 mm.

- Two basic forms are encountered:

- a) with treads, which project from the central pole or tube and
- b) those which have riser legs.

The usual plan format is to have 12 or 15 treads to complete one turn around the central core and terminating at floor level with a quarter circle landing or square landing.

The standards (like those used for precast concrete spiral stairs, pass through one tread and are secured on the underside of the tread below.

Handrails are continuously and usually convex in cross section of polished metal painted metal or plastic covered.

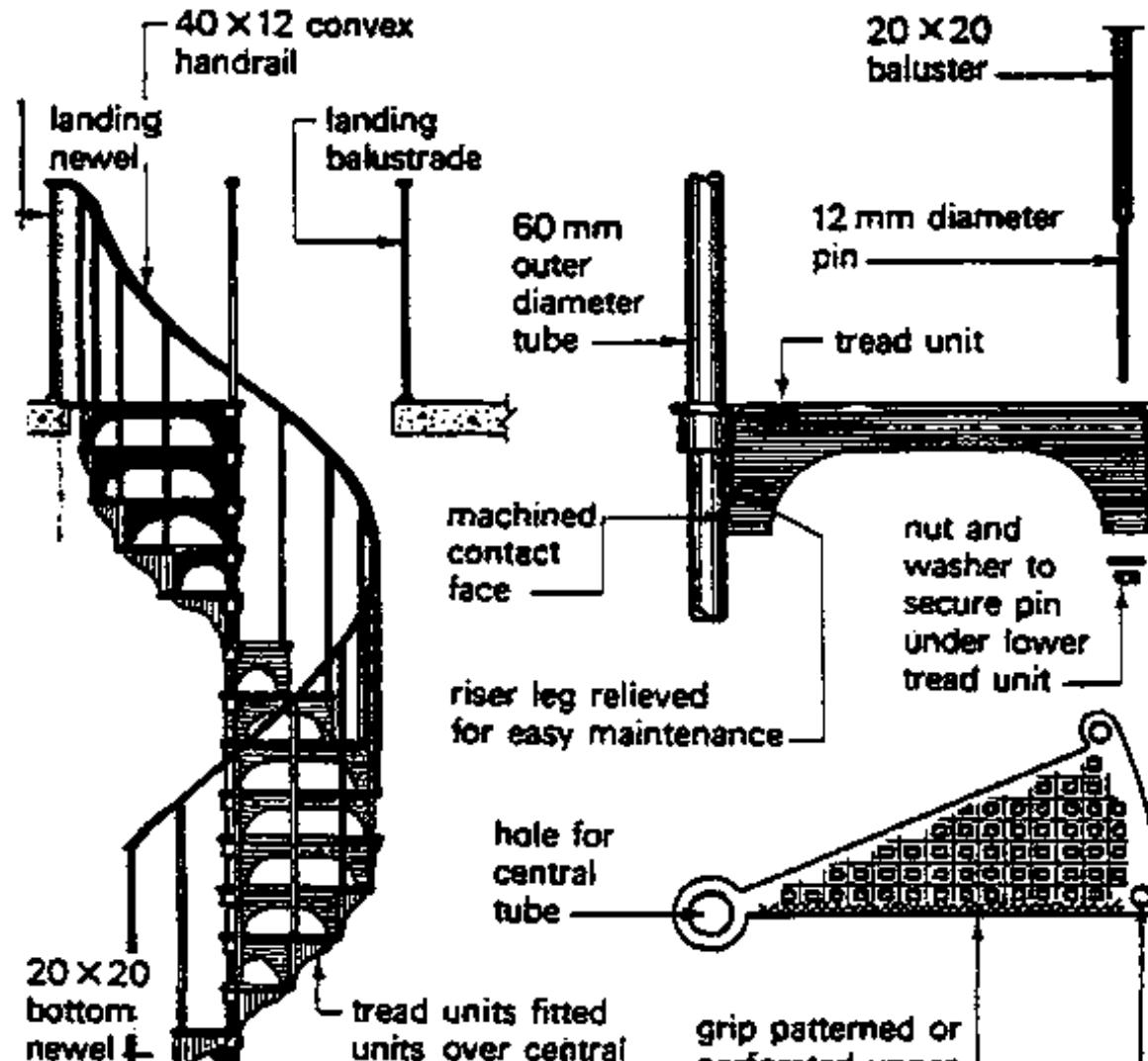

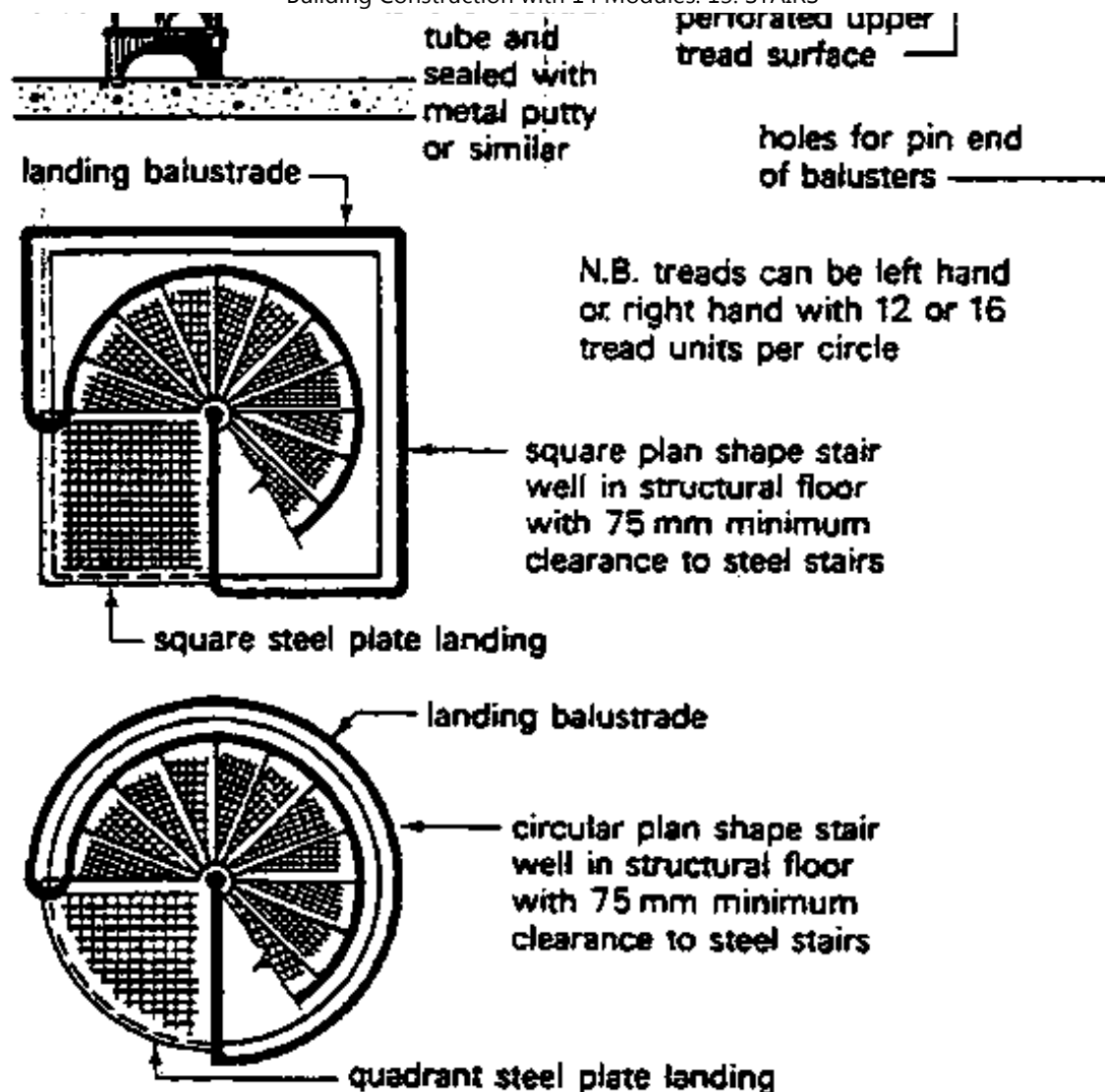

### - String beam steel stairs

used mainly to form accommodation stairs which need to be light and elegant in appearance. The strings can be of mild steel tubes, steel channels steel boxes or small universal beam sections fixed by brackets to the upper floor surfaces or landing edges to act as inclined beams. The treads, which can be hardwood timber, precast concrete or steel are supported by plate, angle or tube brackets welded to the

top of the string beam. Balustrading can be fixed through the ends of the treads or (alternatively) supported by brackets attached to the outer face of the string beam.

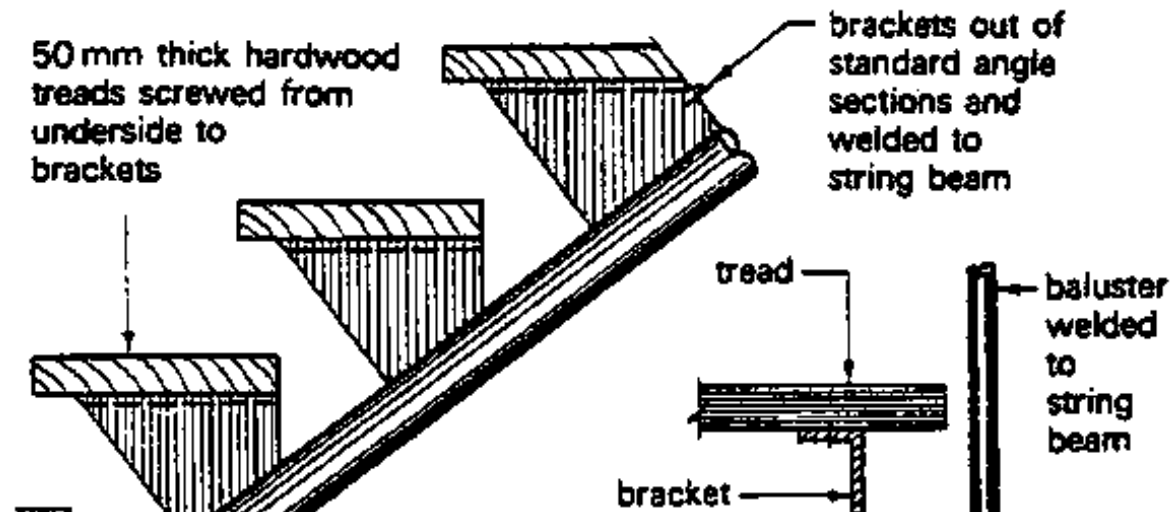
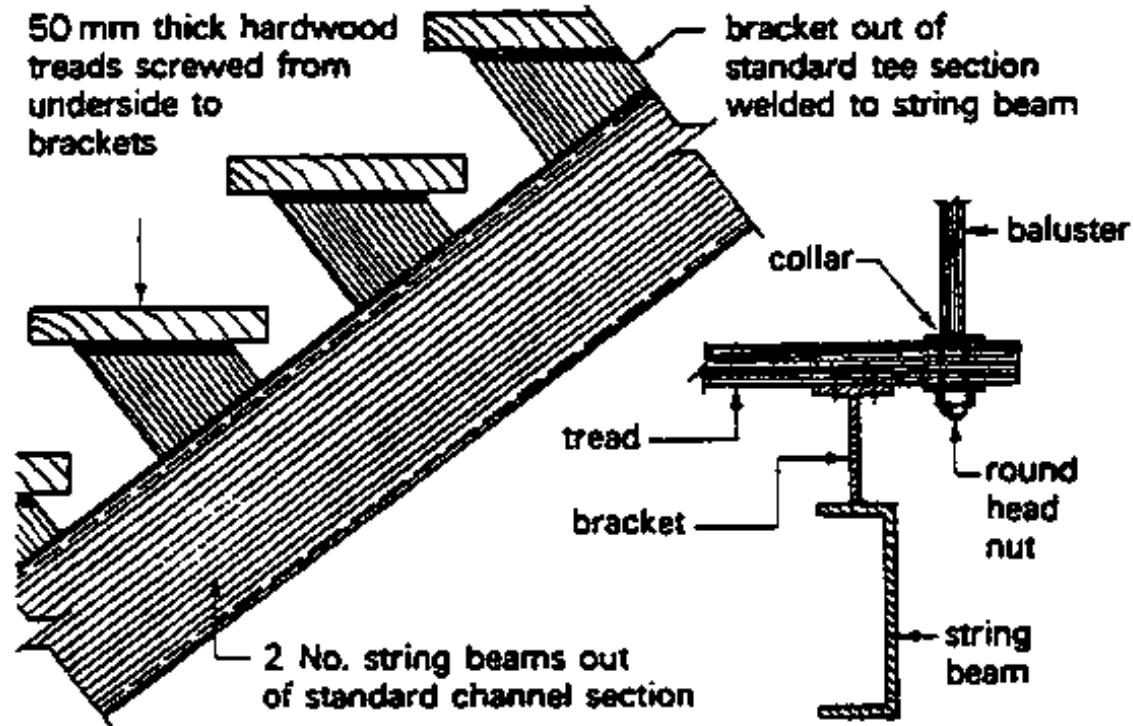

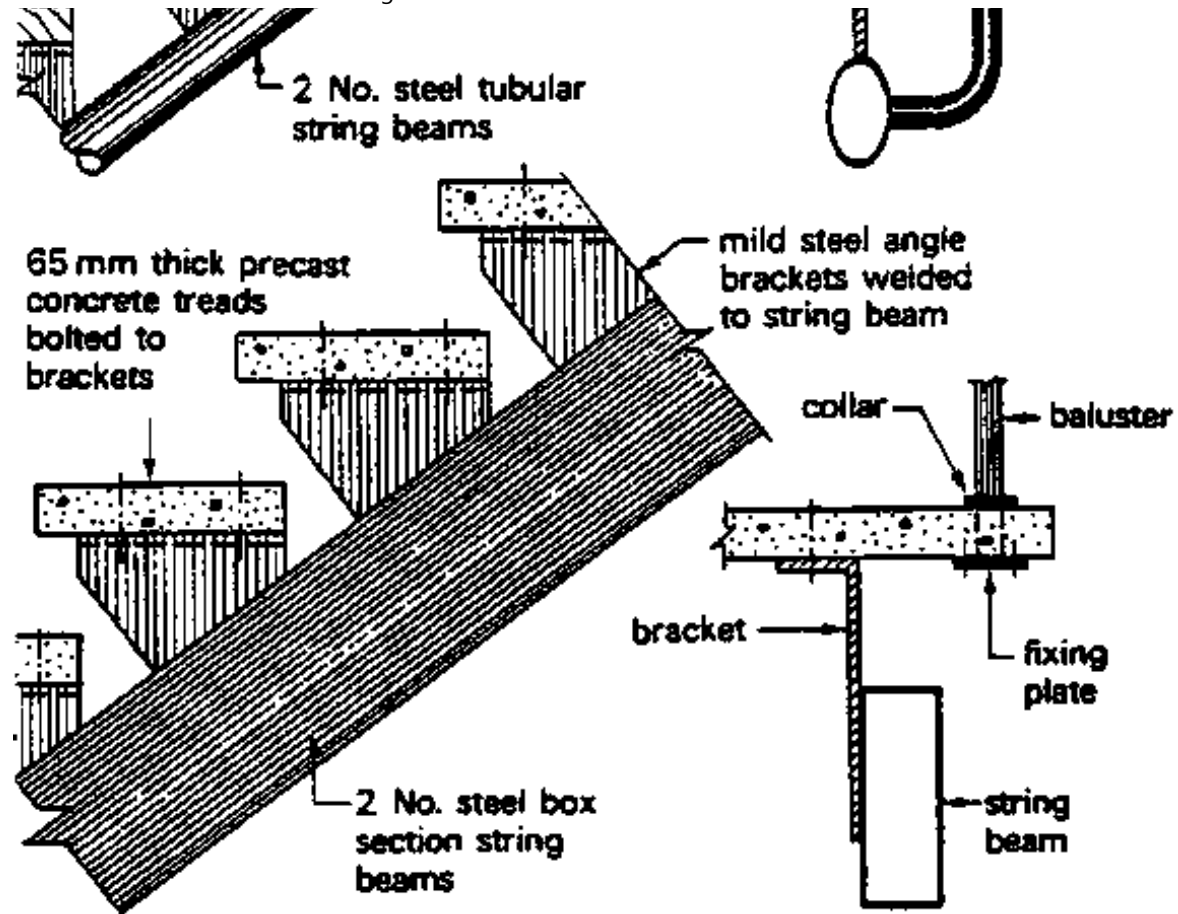

### - Pressed steel stairs

accommodation stairs made from light pressed metal such as mild steel.

Each step is usually pressed as one unit with the tread component recessed to receive a filling of concrete, granolithic, terrazzo, timber or any other suitable material.

The strings are very often in two pieces, consisting of a back plate to which the steps are fixed and a cover plate to form a box - section string.

The coverplate to be site welded

The coverplate to be site-welded.

The complete strings are secured by brackets or built in to the floors or landings and provide the support for the balustrade. Stairs of this nature are generally purpose-made to the required layout and site assembled and fixed by a specialist sub-constructor.

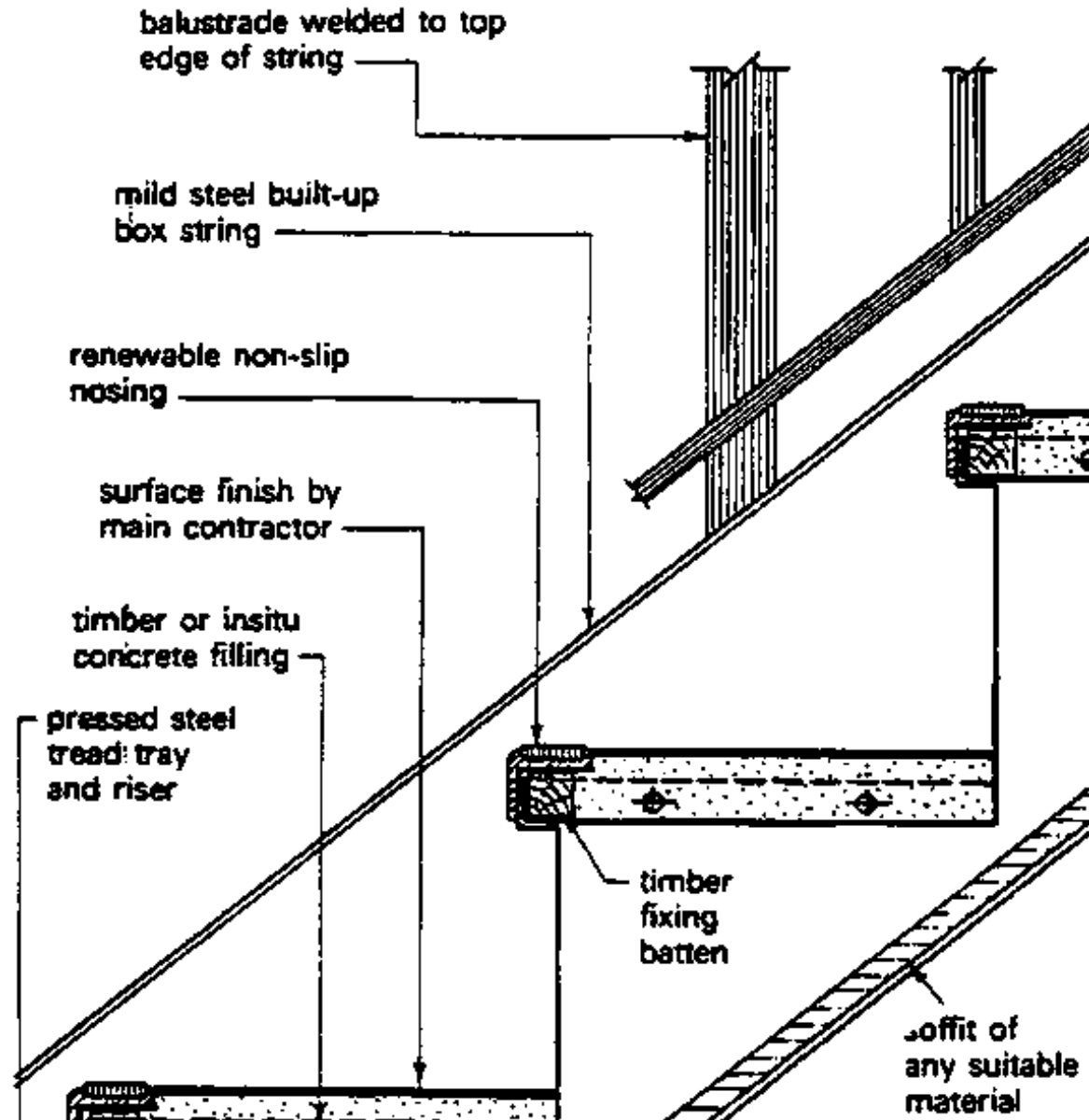

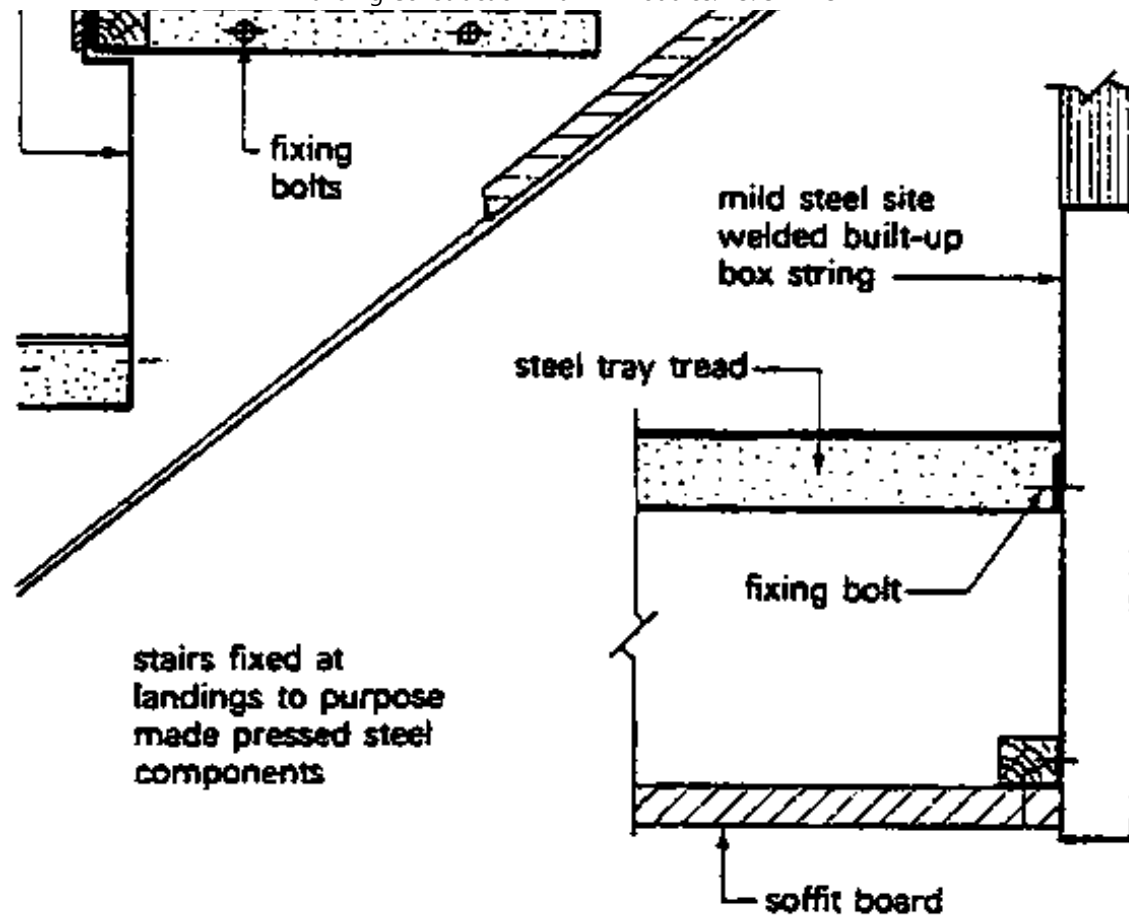

### - Aluminium alloy stairs

are suitable for accommodation stairs in public buildings, offices and shops.

The treads have a non-slip nosing with a general tread covering of any suitable floor-finish-material. Format can be open or closed riser.

The two-part box strings support the balustrade and are connected to one another by small diameter tie rods which - in turn - support the tread units.

The flights are secured by screwing to purpose made base plates or brackets fixed to floors and landings or alternatively located in preformed pockets and grouted in.

When the stairs are assembled they are very light and can usually be lifted and positioned by two men without the need for lifting gear. No decoration or maintenance is required.

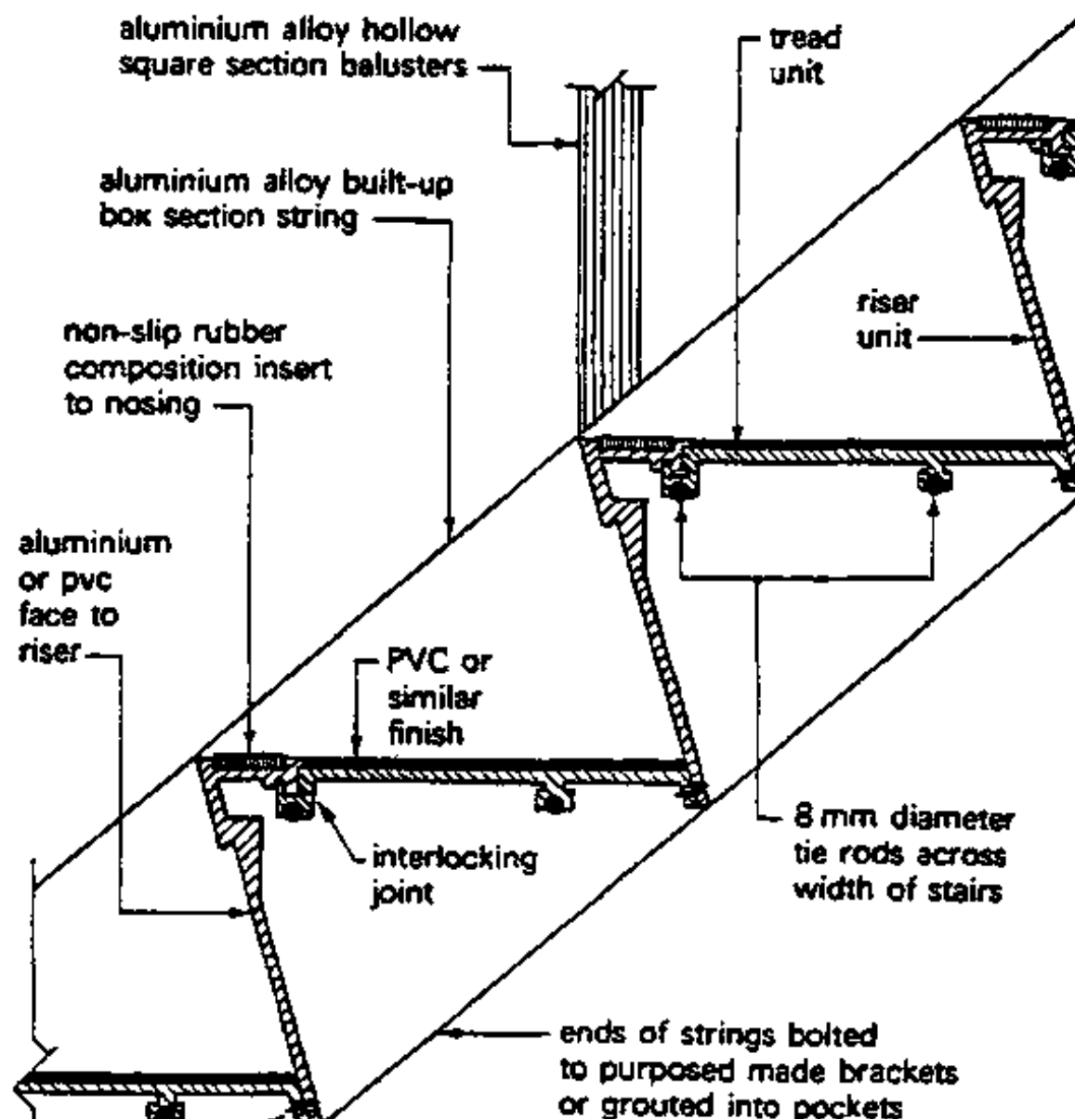



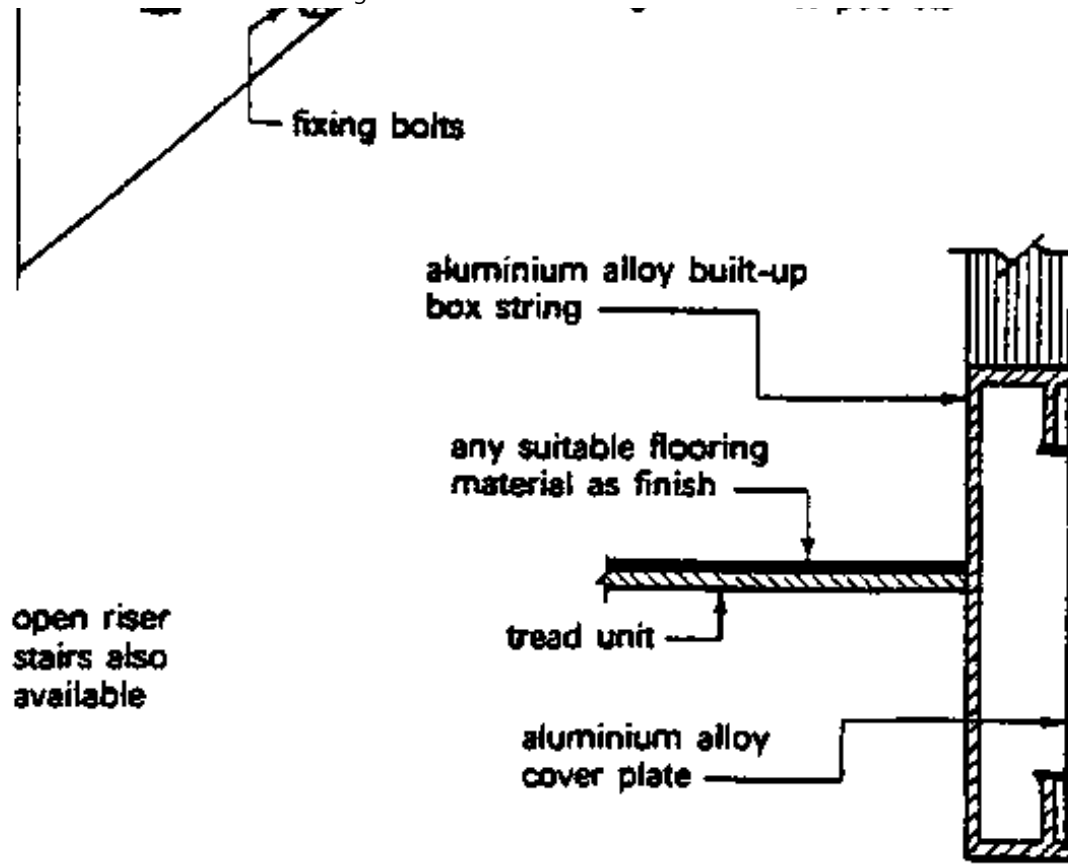

### 13.6 MISCELLANEOUS

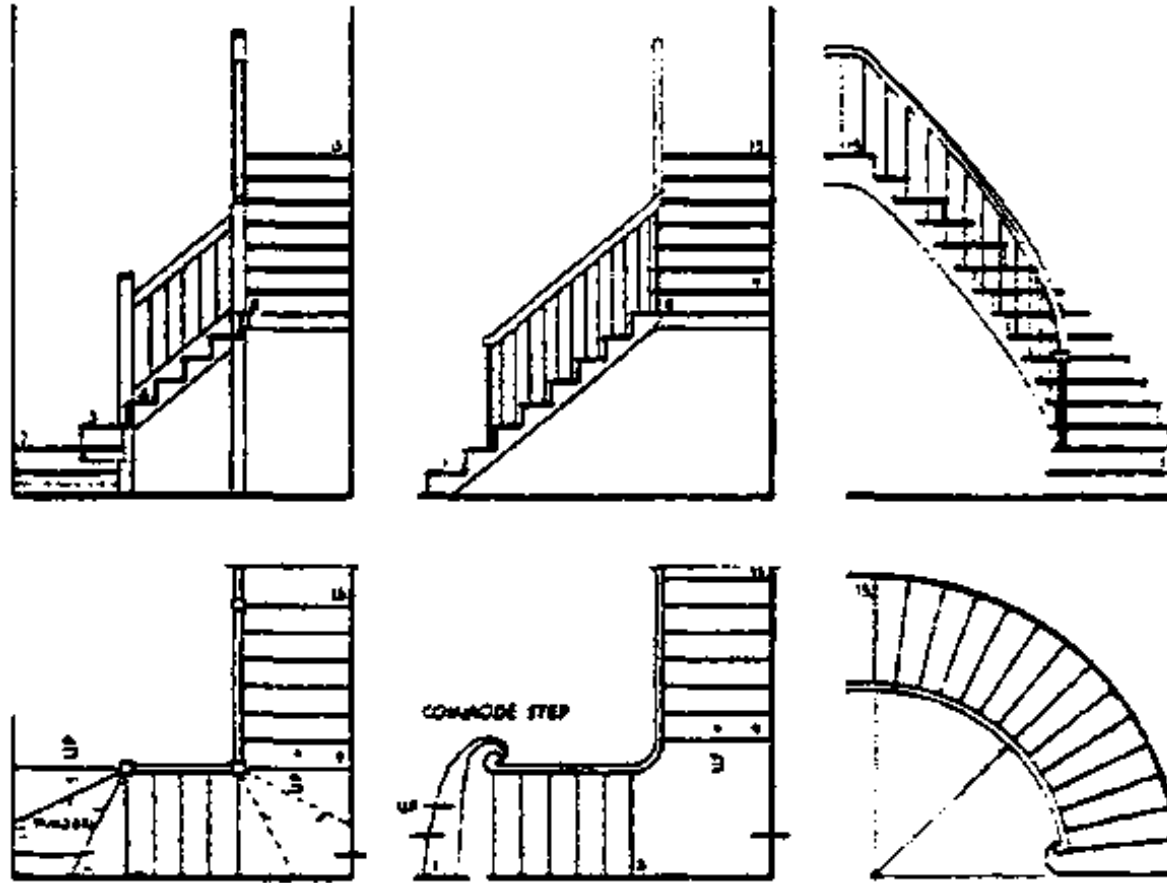

### 13.6.1 BALUSTRADES/HANDRAILS

#### Handrails

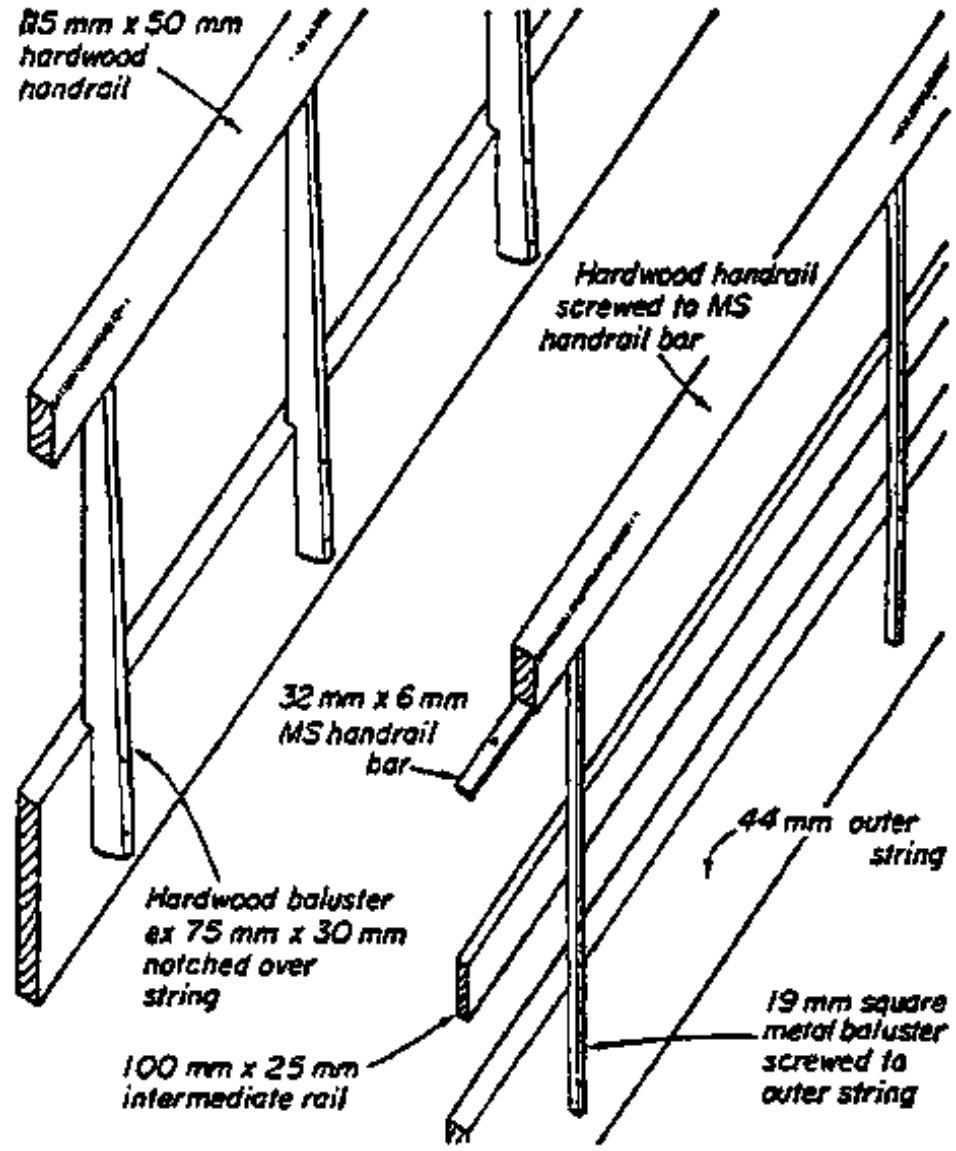

Continuous handrails of non-combustible materials at a height of between 840 and 915mm above the pitch line (line of nosings) are required to all stairs and to both sides if the stairs width exceeds 1.06 m. The height above the floor to be between 1.07 and 1.09 m.

The capping can be of a combustible material such as plastic or timber provided that it is fixed to or over a non-combustible core.

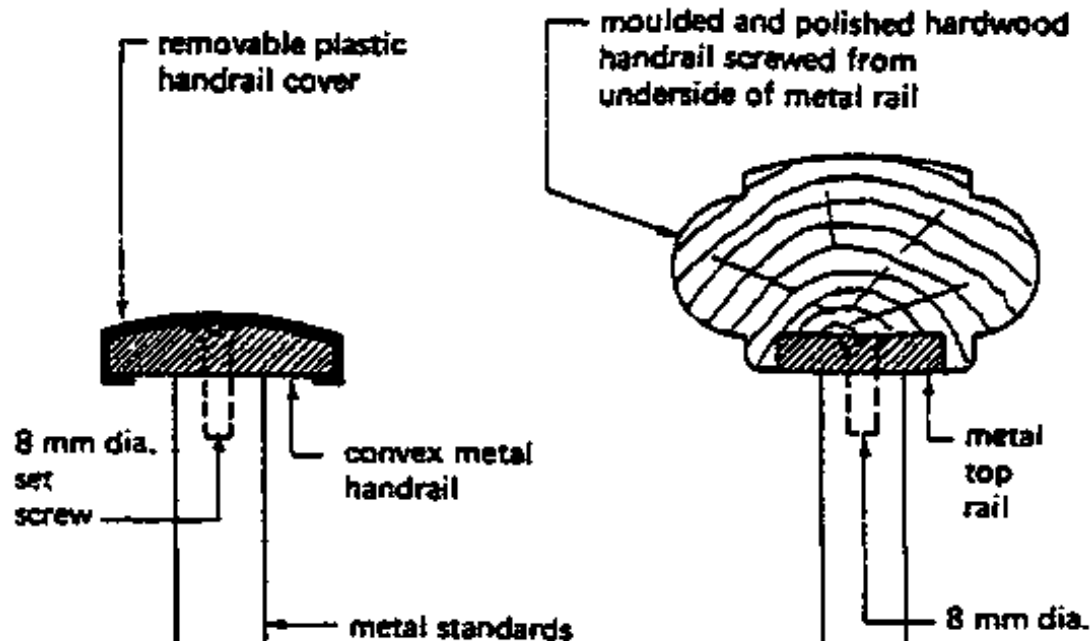
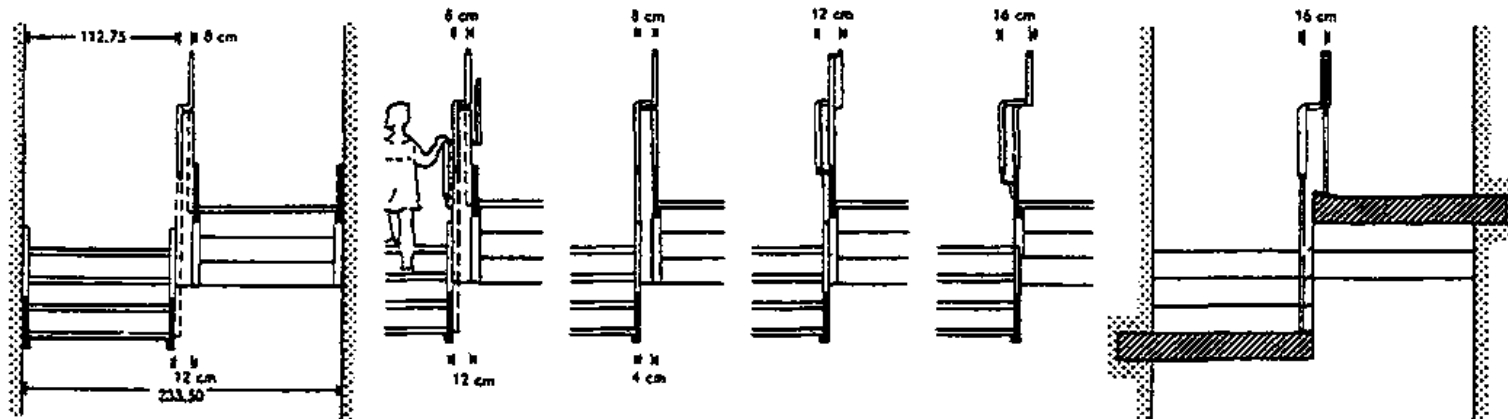



Typical handrails

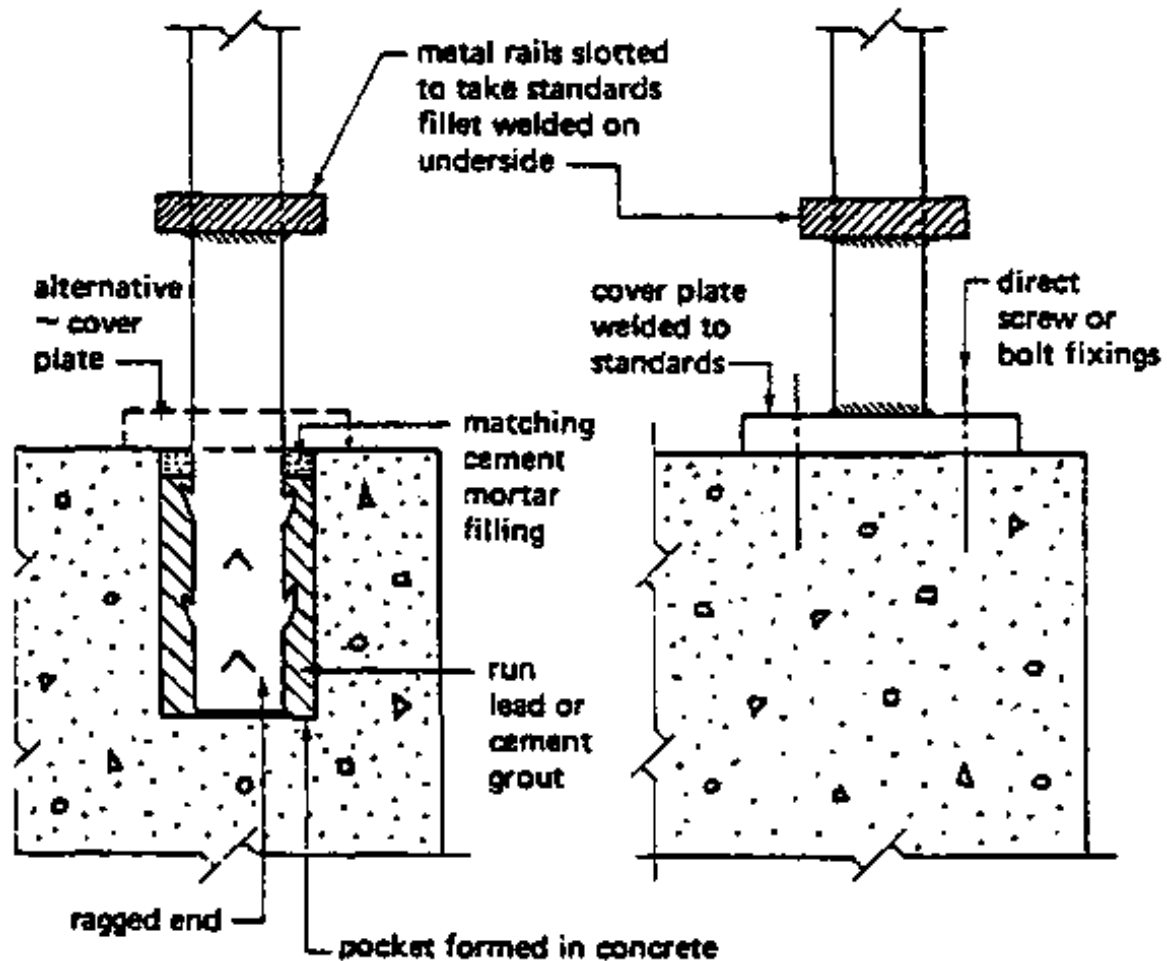

Typical fixing methods

Handrail and string details. Max space is required at hip (handrail) level, but considerably less at foot level. Width at string level therefore reduced to allow more space for stairwell. Staggering of handrail and string also offers better structural fixing of standards to strings. best with

of handrail and string also more better structural fixing of standards to string, rest with handrails 80 mm (3.2 in) apart and space between strings 120 mm (4.7 in), Additional handrail for children, height approx 600 mm (2 ft).

Less favourable string and handrail positions, with no space between strings, string above string. and stringless r.c. stair without any space between flights

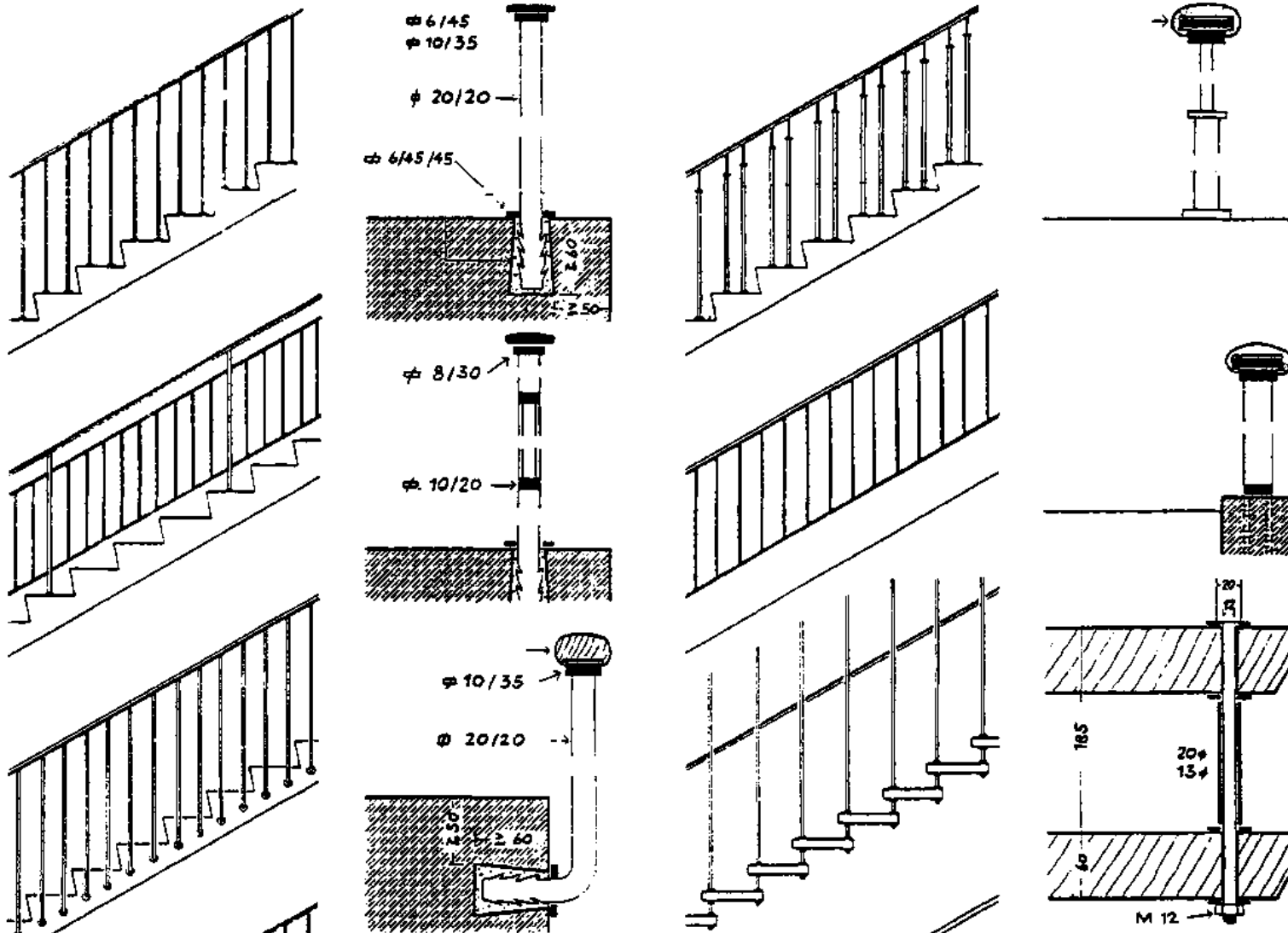

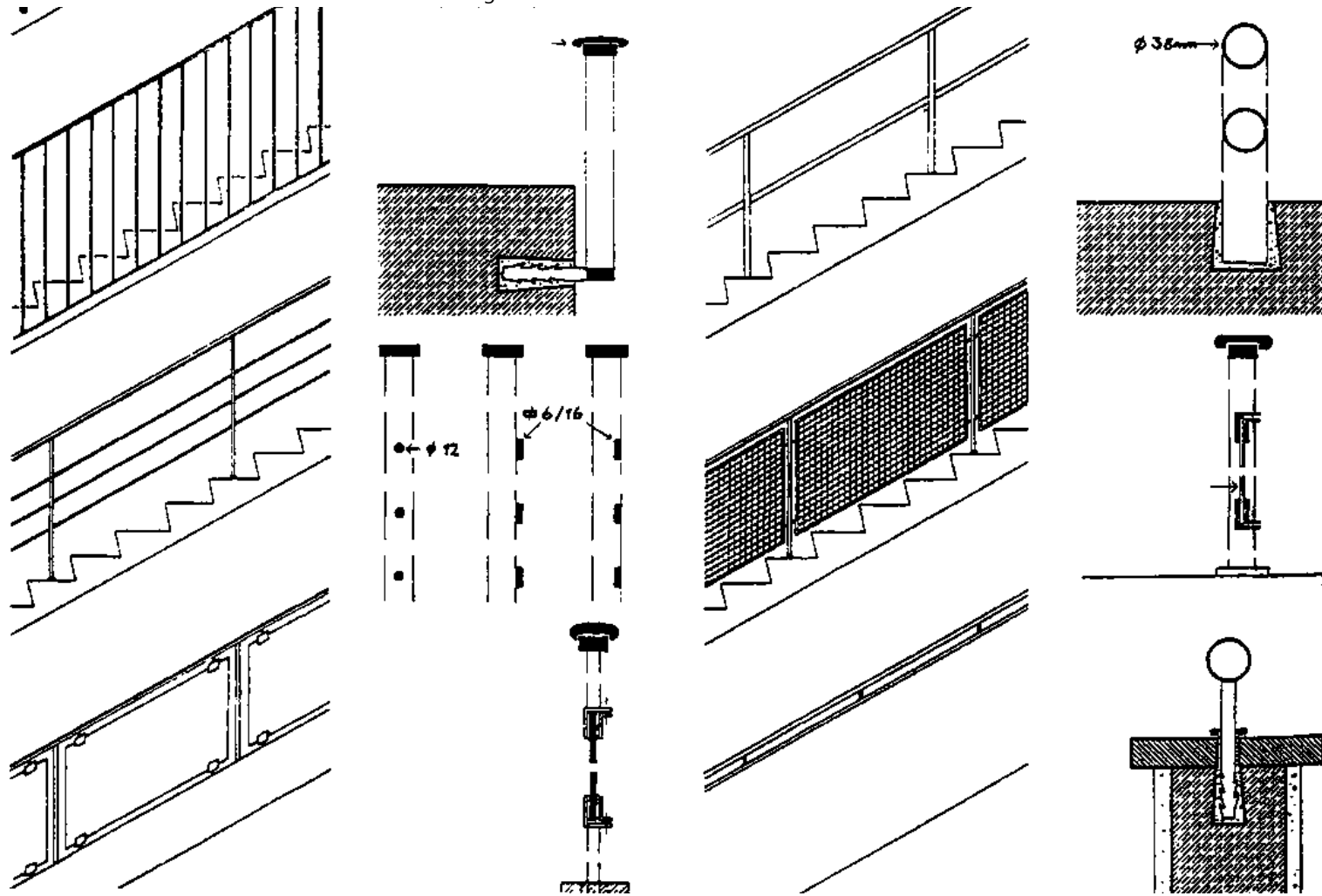

**BALUSTRADES and HANDRAIL DETAILS**

**13.6.2 'SAMBA' STAIR, LADDERS, DISAPPEAR STAIRS, RAMPS**

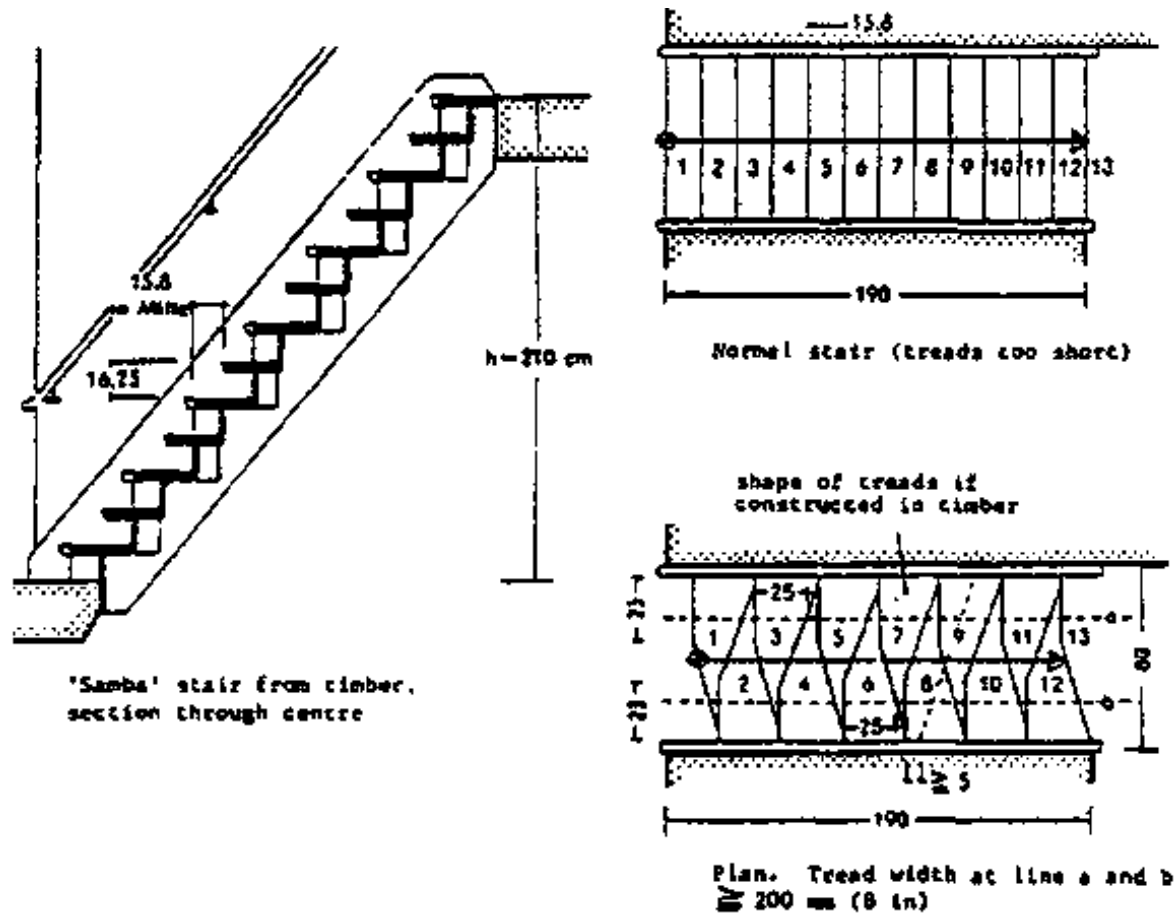

'Samba' stair

**Example.** Storey height 2.25 m (7 ft 6 in) = 12 risers = 187.5 mm (7.5 in) per rise; if constructed as a normal stair, a tread of 136 mm (5.4 in) is too small. Therefore steps are curved in such a way that on line a and b tread becomes 250 mm (10 in), fulfilling above requirement:



$2 \times 187.5 \text{ mm (7.5 in)} + 1 \times 250 \text{ mm (10 in)} = 625 \text{ mm (25 in)}$ .

Storey height from F.F.L. to underside of ceiling	Length of opening (width -ingly)	Required swing radius in attic
3.00	1.45	2.30
3.00	1.30	2.45
3.00	1.15	2.60
3.00	1.00	2.75
3.00	0.85	2.90
2.70	1.45	1.95
2.70	1.30	2.10
2.70	1.15	2.25
2.70	1.00	2.40
2.70	0.85	2.55
2.40	1.45	1.65
2.40	1.30	1.80
2.40	1.15	1.95
2.40	1.00	2.10
2.40	0.85	2.25

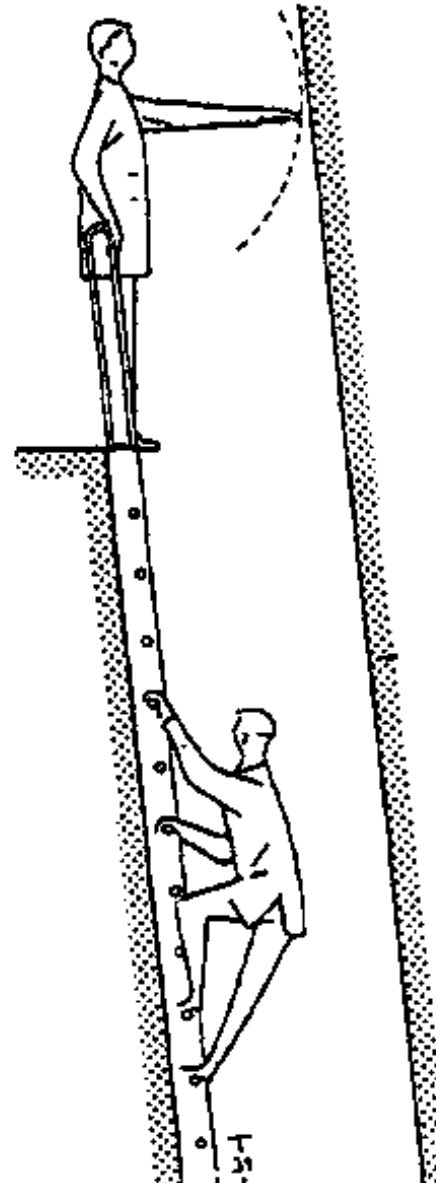

2.10	1.45	1.30
2.10	1.30	1.45
2.10	1.15	1.60
2.10	1.00	1.75
2.10	0.85	1.90

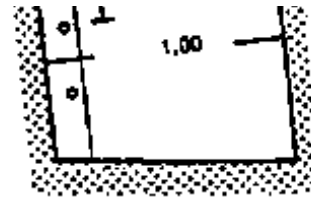

### CONCEALED CATLADDER

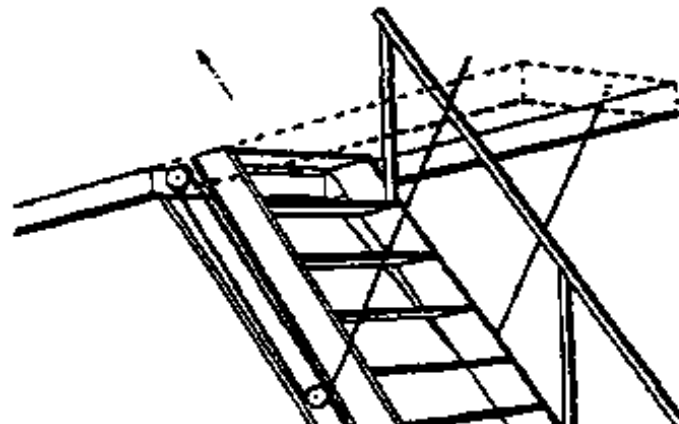
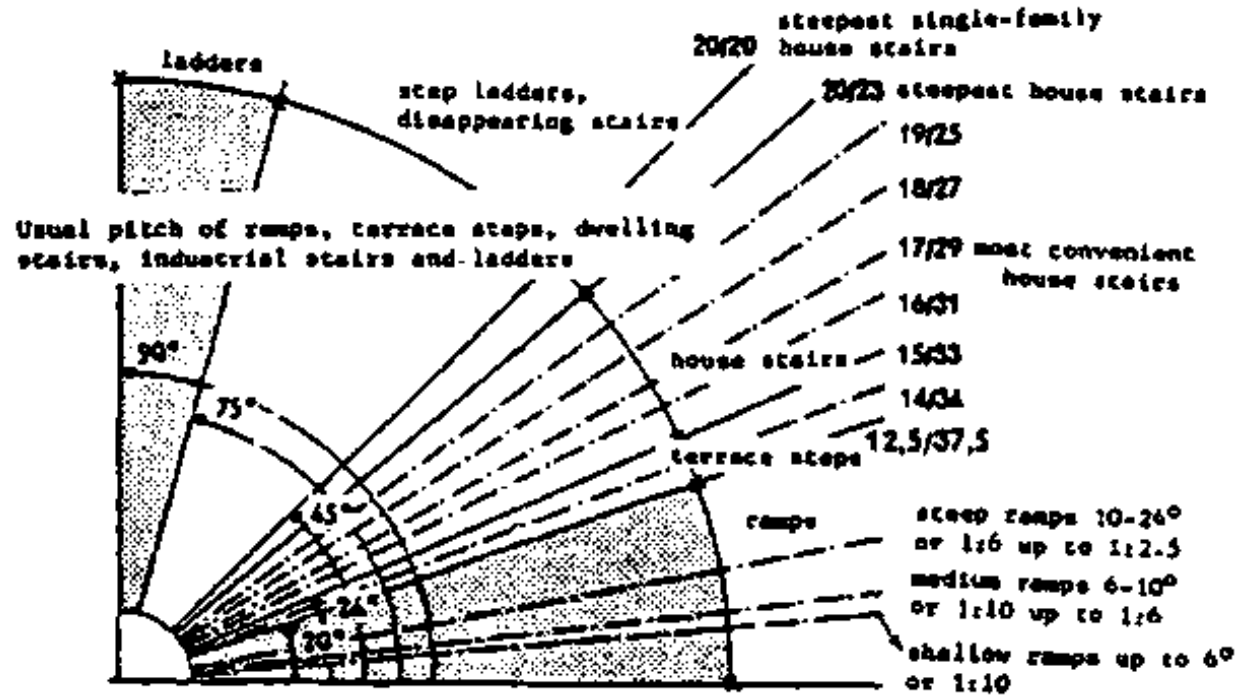

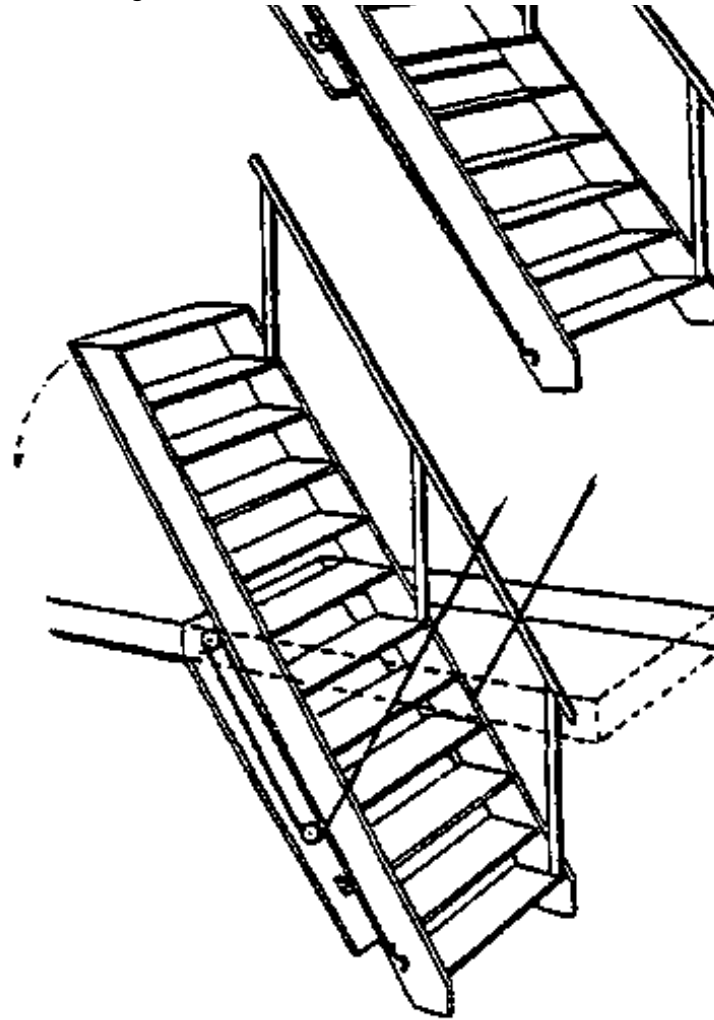

**DISAPPEARING STAIRS**

- ramps are divided according to gradient into:

1. Shallow ramps which do not require special non-slip treatment
2. Medium gradient with battens or low rise steps, or at least a rugged non-slip surface
3. Steep ramps requiring battens or low rise steps. Batten distances should be uniform

**and should conform to normal stride.**

**Steep stairs at an angle of 38-45° should be used only for short flights and little traffic. The sum of the going + twice its rise should be  $\geq 571$  mm (22.5 in).  $\leq 630$  mm (25 in).**

**Loft ladders, etc, have angle of 45-55°.**

**However, if user requirements stipulate a stair-like access (e.g. where loads are carried and available length is too short for flight of normal stairs), then stair with staggered steps, so-called Samba stair, may be designed. Risers for this type of stair should be as few as possible; riser  $\leq 200$  mm (8 in). Here 'the sum of the going + twice its rise = 630 mm (25 in) is achieved by shaping the treads; going is measured (staggered) at axes a and b. of right and left foot.**

**Movable ladders have angles of 65-80°. There are various types including extension ladders.**

**Fixed ladders have angles of 80°+ and should extend  $\geq 750$  mm (2 ft 6 in) over platform to be reached if no other precautionary measure against accident is taken. Rung-distance for fixed ladders, 295-315 mm (11.5-12.5 in).**

### **13.6.3 ESCALATORS**

**Escalators (1) are required for continuous transport of crowds (requirements of width and distance for means of escape do not take escalators into account). Automatic control by push buttons at top and bottom or through photo-electric cells reduces running times by 40-50%.**

**Escalators should be evenly distributed throughout all floors, where necessary varying width or speed. To cope with peak traffic a smaller number of escalators at speed of 1 m/sec (3 ft/sec) which move at off-peak times at 0.65 m/sec (2 ft/sec) more economical than larger number of slow moving escalators. However, in UK. max speed 0.75 m/sec (→ BS 2655).**

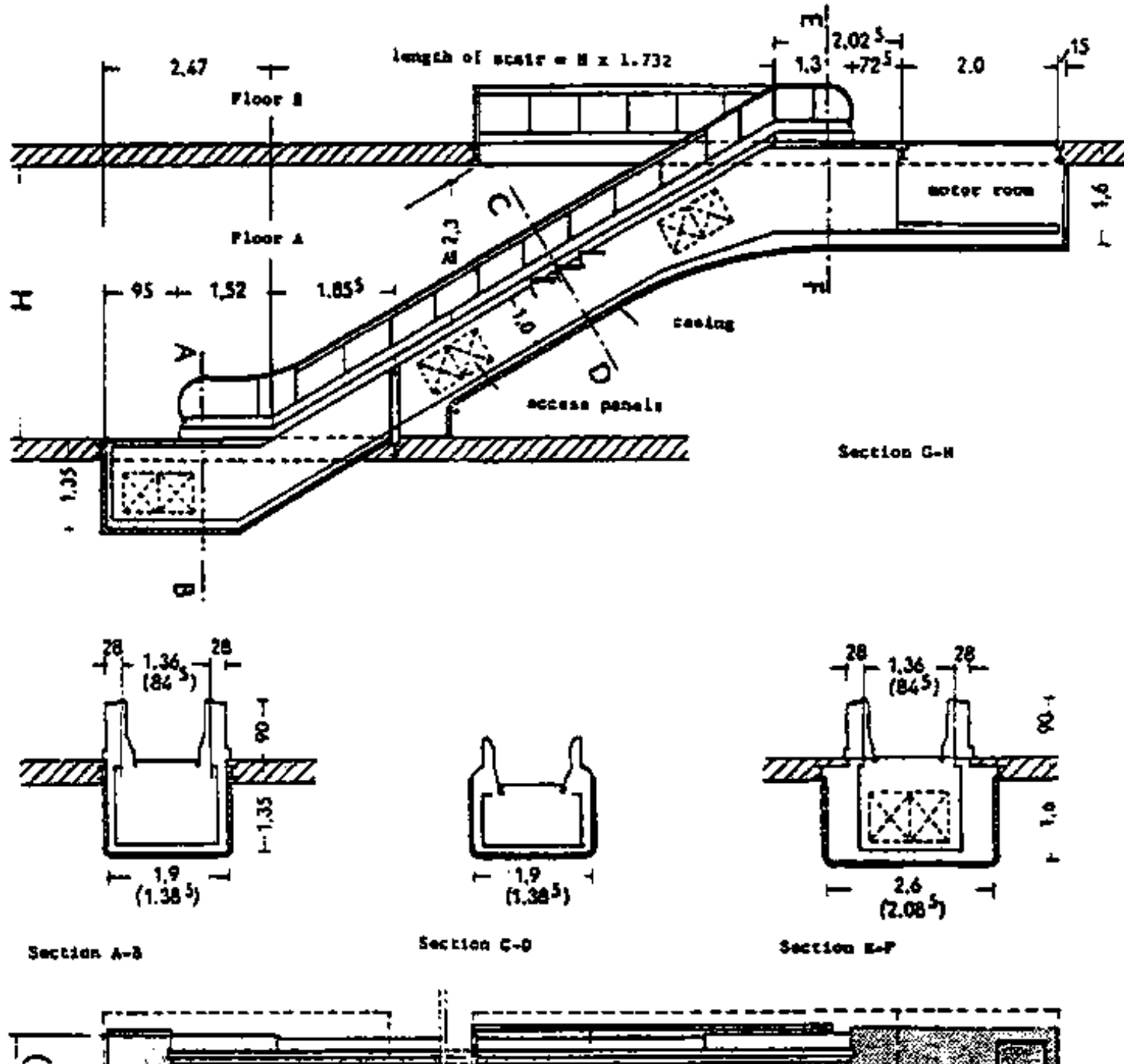

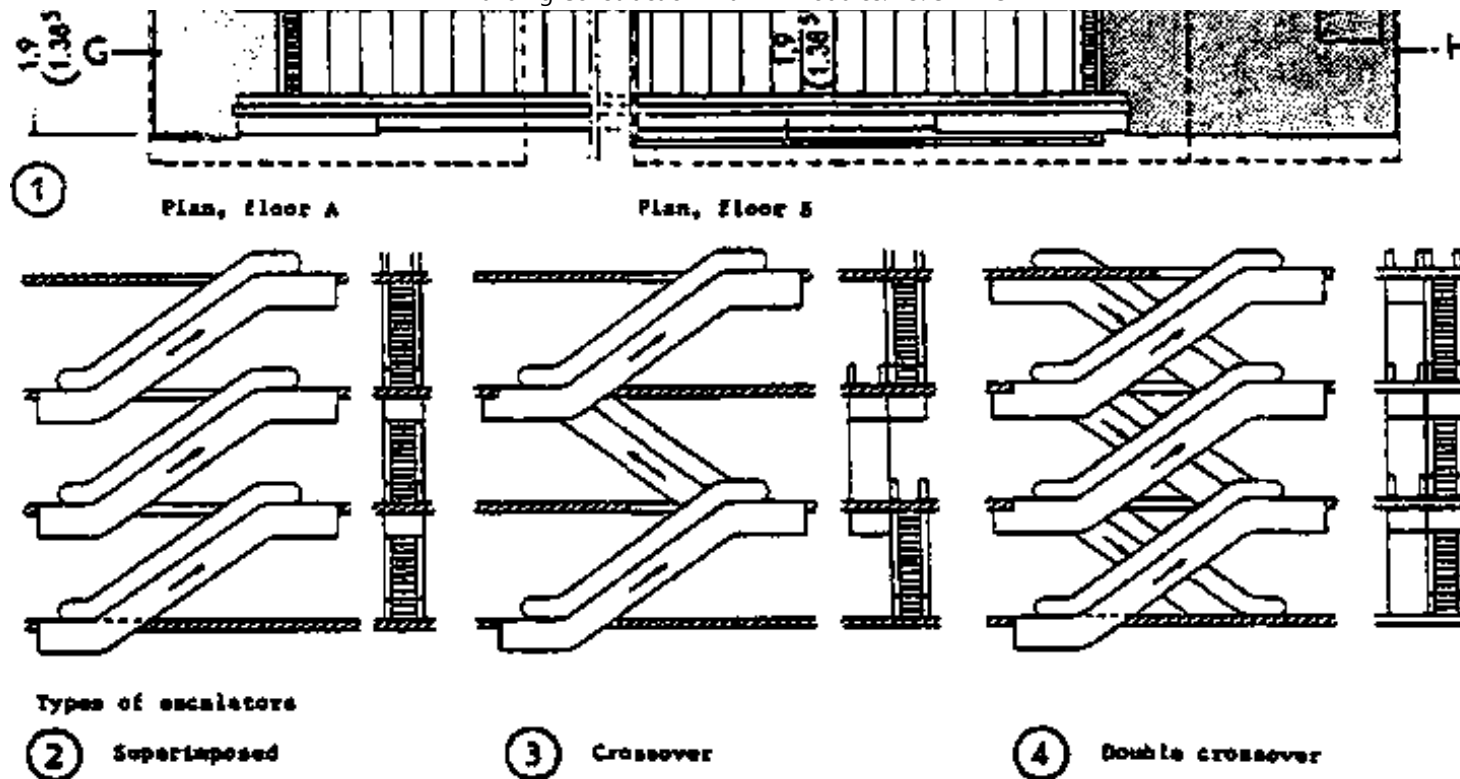

Stringent requirements (function and security); 30° angle best, going 0.40 m (1 ft 4 in), width of stairs 0.60 m (2 ft) to ≤ 1.00 m (3 ft 4 in). usual 0.80 m (2 ft 8 in). Escalators of 30° angle and 1.00 m stair width permit easy overtaking.

Conveyor belt speed: international about 0.50 m/sec (1 ft 8 in/sec). At change-over from fixed floor to escalator a handrail projection ≥ 0.80 m (2 ft 8 in) is required.

Access and exit with min. 2 horizontal goings, but escalators with larger height dimensions or greater speed ≤ 0.50 m/sec (1 ft 8 in/sec) min 3 horizontal exit goings necessary.

Max capacity/h from steps area and speed

$$M = Q_1 \times V \sqrt{2600}$$

**Capacity**  $\frac{M}{T} \times 3600$

**$Q_1$  = persons/step**

**T = going depth.(m)**

**v = conveyor speed (m/sec)**

**Output only 75-80% of M, as steps not used to capacity.**

**Control: fully automatic through time clock and programme, or intermittent through photo-electric cells, or contact mats.**

**With working height of  $\geq 6.0$  m (20 ft) a centre support is normally necessary.**

**Length in plan**

**With 30° escalator:  $1.732 \times$  storey height.**

**With 35° escalator:  $1.428 \times$  storey height.**

**Example: storey height 4.5 m (15 ft), angle 30°. Length in plan =  $1.732 \times 4.5 = 7.794$  m ( $1.732 \times 15 = 26$  ft); adding for landings top and bottom, total length approx 9 m (30 ft). allowing about 20 persons to stand in a row.**

		Person/hr transported	
	Time per person	1 person width	2 person width
<b>0.5 m/sec</b>	<b>18 sec</b>	<b>4000</b>	<b>8000</b>
<b>0.9 m/sec</b>	<b>10 sec</b>	<b>7200</b>	<b>14400</b>

## **Energy consumption:**

**4 000 person/h: 8 hp AC**

**8 000 person/h: 15 AC**

## **Repetition exercises**

**Try to answer the following questions and practice sketching where ever necessary and possible.**

### **1) Introduction**

**a) Explain the term STAIR and list suitable materials, which can be used for the construction of stairs.**

### **2) Definition of Terms**

**a) Define the following Terms:**

- Step**
- Tread**
- Rise of a step**
- Riser**
- Racking Riser**
- Nosing**
- Line of Nosings**
- Going**
- Fliers**



- **Tapered Steps**
- **Winders**
- **Dancing Steps**
- **Flight**
- **Landing**
  
- **Width**
- **Pitch or Slope**
- **Walking line**
- **Headroom**
- **Balustrade**
- **String or Stringer**
- **Staircase**

### 3) Types of Stairs

a) How are Stairs classified?

Use sketches for illustration!

### 4) Design of Stairs

a) What are the main factors in the design of Stairs?

b) Write notes on the RISE-TREAD-PROPORTION.

c) Calculate a Stair with a rise of 17-19 cm and difference of floor levels -  $h = 3.00$  m, using the

**I. CONTROL**

**II. SAFETY - RULE**

**III. COMFORT-RULE**

### **5) Construction of Stairs**

**a) Explain briefly the construction of BRICK STAIRS.**

**Use sketches for illustration!**

**b) Explain briefly the construction of STONE STAIRS.**

**Use sketches for illustration!**

**c) Explain briefly the construction of 'IN-SITU' CAST R.C. STAIRS and give structural details of:**

- **single flight concrete stairs**
- **two-flight concrete stairs with half-space landings**
- **string beam concrete stairs**
- **cranked slab concrete stairs - cantilever concrete stairs**
- **spiral concrete stairs**

**Use sketches for illustration!**

**d) Explain briefly the construction of PRECAST CONCRETE STAIR and give structural details of**

- **straight flight p.c. stairs**
- **cranked slab p.c. stairs**
- **p.c. open riser stairs**
- **p.c. spiral stairs**

- p.c. spiral stairs

**Use sketches for illustration!**

**e) Explain briefly the construction of TIMBER STAIRS and give structural details of**

- straight flight timber stairs
- open-riser or ladder timber stairs
- dog-leg timber stairs
- open well timber stairs

**Use sketches for illustration!**

**f) Explain briefly the construction of METAL STAIRS and give structural details of**

- steel escape stairs
- steel spiral stairs
- string beam steel stairs
- pressed steel stairs

**Use sketches for illustration!**

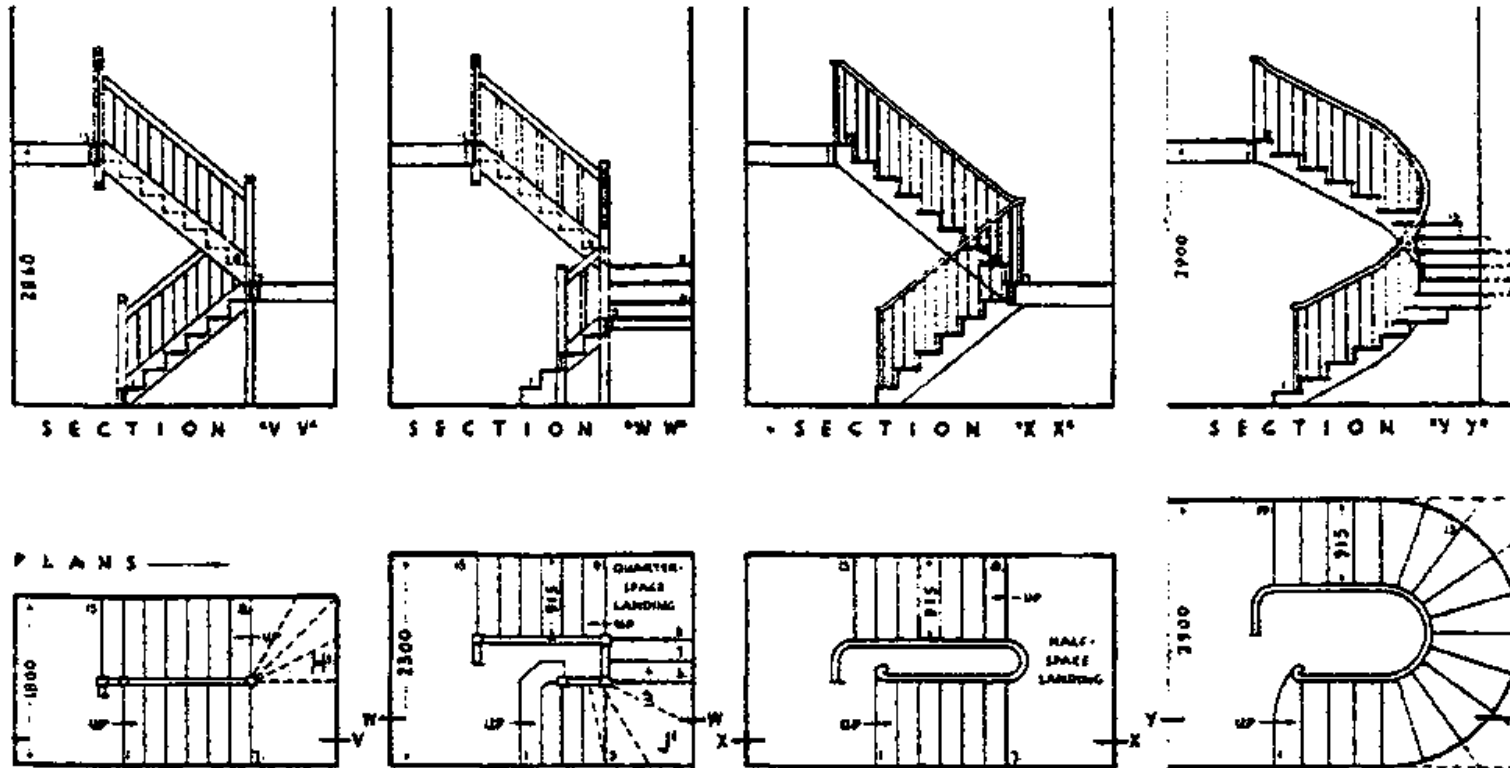

## 6) Miscellaneous

a) Describe - by using sketches - different types of balustrades and handrail details.

b) Explain the terms:

- 'samba' stair

- disappearing stair

- disappearing stair
- ladder
- ramp by using sketches for illustration!

c) What do you know about ESCALATORS?

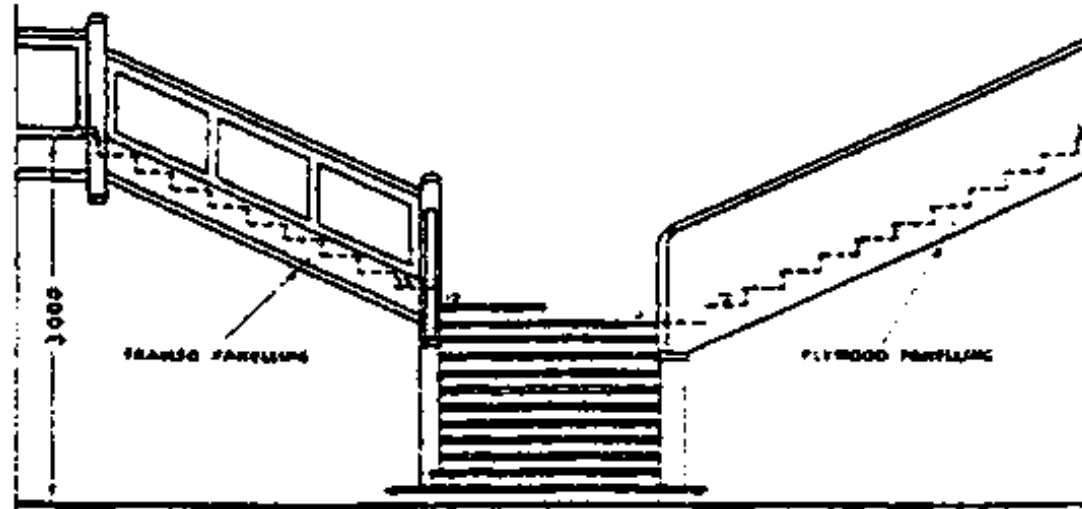

Elevation

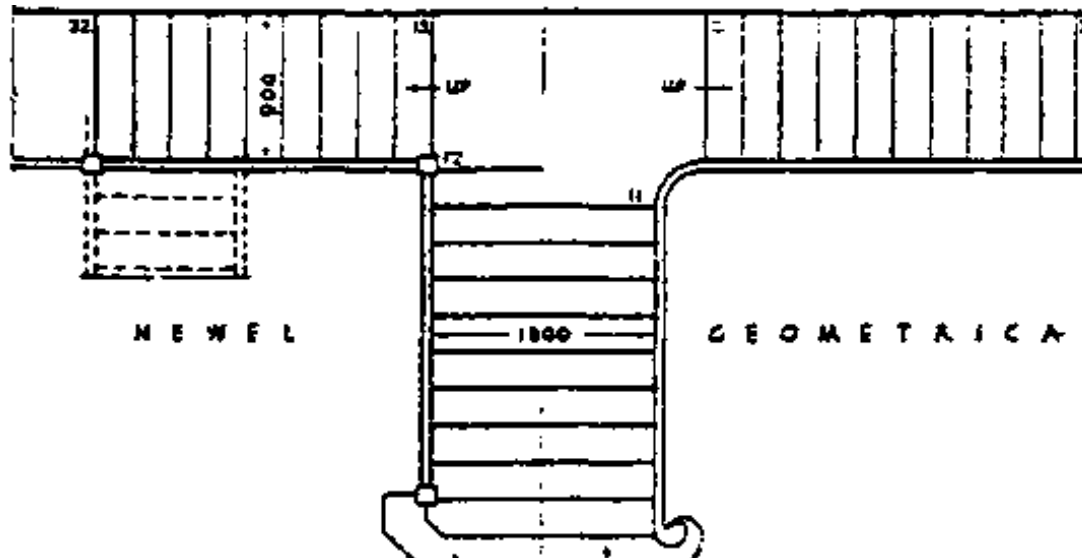

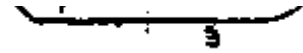

## Bifurcated stair

[Please provide your feedback](#)

[English](#) | [French](#) | [Spanish](#) | [German](#)