

Printable version

**Export document
as HTML file** [Help](#)

**Export document
as PDF file**

Construction Manual for Earthquake-Resistant Houses Built of Earth (GTZ; 2001; 53 pages)

Acknowledgement

Introduction

1. General aspects of earthquakes

1.1 Location, magnitude, intensity

1.2 Structural aspects

2. Placement of house in the case of slopes

3. Shape of plan

4. Typical failures, typical design mistakes

5. Structural design aspects

6. Rammed earth walls

6.1 General

6.2 Stabilization through mass

6.3 Stabilization through shape of elements

6.4 Internal reinforcement

7. Adobe walls

7.1 General

7.2 Internal reinforcement













7.3 Interlocking blocks

7.4 Concrete skeleton walls with adobe infill

8. Wattle and daub

9. Textile wall elements filled with earth

10. Critical joints and elements

-  **10.1 Joints between foundation, piinth and wall**
-  **10.2 Ring beams**
-  **10.3 Ring beams which act as roof support**
-  **11. Gables**
-  **12. Roofs**
 -  **12.1 General**
 -  **12.2 Separated roofs**
-  **13. Openings for doors and windows**
-  **14. Domes**
-  **15. Vaults**
-  **16. Plasters and paints**
-  **Bibliographic references**
-  **Back cover**

Construction Manual for Earthquake-Resistant Houses Built of Earth

Gernot Minke



Deutsche Gesellschaft für Technische Zusammenarbeit (GTZ) GmbH

Published by

**GATE - BASIN (Building Advisory Service and Information Network) at
GTZ GmbH (Gesellschaft für Technische Zusammenarbeit)**

**P.O. Box 5180
D-65726 Eschborn**

**Tel.: ++49-6196-79-3095
Fax: ++49-6196-79-7352**

e-mail: gate-basin@gtz.de

Homepage: <http://www.gtz.de/basin>

December 2001

Acknowledgement

This manual was first published in Spanish within the context of the research and development project "Viviendas sismorresistentes en zonas rurales de los Andes", supported by the German organizations Deutsche Forschungsgemeinschaft, Bonn (DFG), and Deutsche Gesellschaft für Technische Zusammenarbeit (GTZ) GmbH, Eschborn (gtz). It also comprises the results of former research projects of the "Forschungslabor für Experimentelles Bauen" (Building Research Laboratory, University of Kassel, Germany), directed by the author and sponsored by gtz, DAAD and the University of Kassel.

The layout and computer drawings were prepared by Friedemann Mahlke, the freehand sketches by Vera Frey.

Kassel, December 2001

Gernot Minke

Introduction

The solutions proposed in this manual concentrate on low-cost single-story houses, built from earth in rural areas of earthquake-prone zones. They are based on research projects carried out at the Forschungslabor für Experimentelles Bauen (Building Research Laboratory) of the University of Kassel, Germany, on the analysis of earthquake damage in Latin America, on studying relevant literature and on the implementation of several test structures in Germany and prototype houses in Guatemala, Ecuador and Chile.

Using locally available building materials as well as the skills of local craftsmen should be considered for the design of seismic-resistant (earthquake-proof) houses and it should be proved that the solutions are accepted by the users.

Earth as a building material has lost its credibility mainly because of the fact that most modern houses with earth walls could not withstand earthquakes, and also since earth is considered as the building material for the poor. In this context it is worth mentioning that a census conducted by the Salvadorian Government after the earthquake in January and February 2001 states that adobe houses were not worse affected than other houses.

In many areas of the Andes regions building with adobe (unburned, unstabilized handmade soil blocks) is forbidden

in many areas of the Andes regions building with adobe (unburned, uncalcined mud made with stones) is forbidden nowadays. Nevertheless, the majority of the rural population still builds with this building material, as it cannot afford to build with bricks or concrete blocks.

When designing low-cost houses for rural areas it should be taken into account that structural failures as a consequence of an earthquake have to be avoided, whereas minor damage like small cracks must be tolerated if it can be easily restored.

For more information about the different building techniques with earth, the physical and structural characteristics of earth and the possibilities of improving them, reference is made to the "Earth Construction Handbook" by the author, published at WIT Press, Southampton, UK 2000, or to the "Manual de Construcción en Tierra", publicadora Nordan, Montevideo, Uruguay 2001.

1. General aspects of earthquakes

1.1 Location, magnitude, intensity

An earthquake is produced either by movement of tectonic plates or by volcanic activity. The areas of the world that are most earthquake-prone are shown in Fig. 1-1. Earthquakes of intensity 8 on the Richter scale have been recorded in Asia and of up to 8.7 in the Andes . Nearly a hundred earthquakes of intensity higher than 6 and twenty of intensity higher than 7 on the Richter scale are recorded annually. Several thousand people are affected by earthquakes every year.

The magnitude (M) of an earthquake usually is measured on the Richter scale, which is logarithmic with an open end. It is a measure of the energy produced in the epicenter, the place where the earthquake is generated. The Mescali scale, on the other hand, is divided into 12 grades and indicates the intensity of the local impact.

The local impacts on a structure depend not only by the magnitude of the earthquake, but also on the depth of and distance from the epicenter, the geology and topography, the kind of local soil and last but not least on the duration, frequency and acceleration of the impacts.

1.2 Structural aspects

Structures are mainly affected by the horizontal forces created by the earthquake. The vertical forces are usually less than 50% of the horizontal ones.

The main danger due to horizontal movements of the earth is that the walls of buildings might fall outwards and consequently the roofs collapse. The main aim of building earthquake-resistant houses, therefore, is to avoid walls being able to fall

outwards and to ensure that the roots are fixed well to the walls, or even better that they stand on a system of posts separated from the wall, so that the roof system and the walls can swing independently due to their differing frequency.

With a "medium" earthquake the following measures have to be taken into account:

horizontal deformation: $h = 0.1$ to 0.3 m

horizontal velocity: $v = 0.1$ to 0.3 m/s

horizontal acceleration: $a = 0.1$ to 0.3 m/s²
= 0.15 to 0.30 g

A horizontal acceleration of 0.3 g means that 30% of the dead load of the structural elements acts as horizontal force against the structure ("equivalent force"). Usually simple structures are calculated by the method of "equivalent force", in which the horizontal impact is taken as a static force and not as a dynamic one.

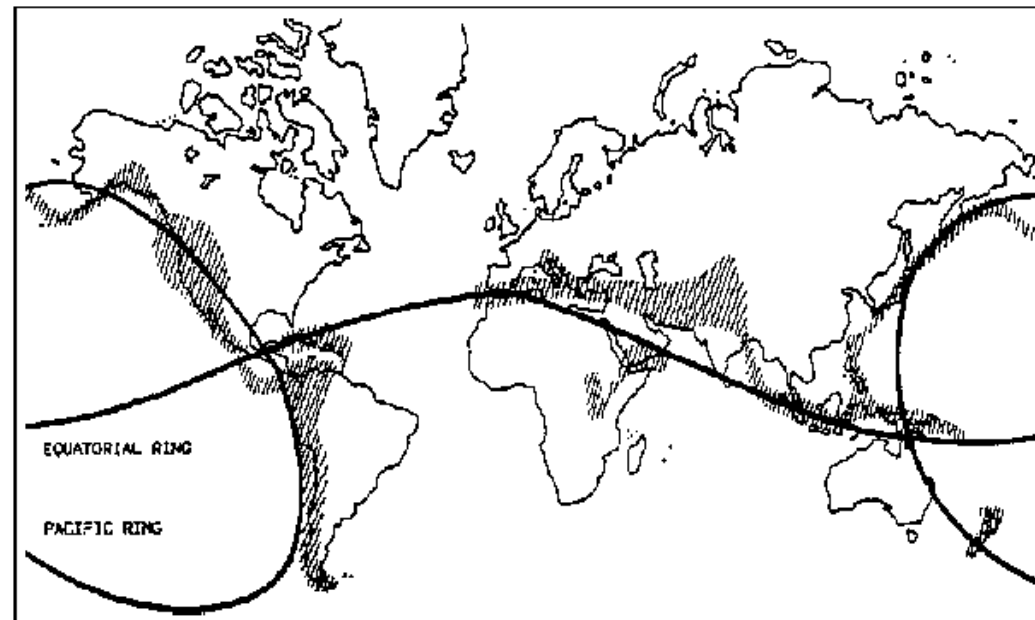

1-1 Earthquake zones (Houben, Guillaud 1984)

However, the higher the ductility, the capacity for deformation without structural failure, the lower the equivalent force is and the lower the structural resistance must be.

The quality of an earthquake-resistant structure can be expressed in the formula

$$\text{structural quality} = \text{resistance} \times \text{ductility}$$

This means the lower the resistance of the structure is, the higher the flexibility must be, and the higher the flexibility is, the lower the resistance must be (Grohmann, 1998).

The historical rammed earth houses with walls of 60 to 100 cm thick had enough resistance to withstand earthquakes and did not need to be flexible. For instance in Mendoza, Argentina, these houses withstood all earthquakes of the last centuries, whereas all modern buildings built of adobe or bricks collapsed. However, these structures are not economic nowadays. Economic solutions have less rigidity, therefore they must allow deformation during seismic shocks without collapse.

2. Placement of house in the case of slopes

In earthquake-prone areas, where the site is inclined, the following rules must be taken into account:

- a) The house should not be cut into the slope, as the adjacent wall might collapse due to the horizontal forces of the earth, see Fig. 2-1**
- b) The house should not stand on the slope as it might slip down**
- c) The house should not stand near steep slopes as it might collapse due to falling rocks or earth avalanches, see Figs. 2-3 and 2-4**
- d) If a slope is given, a platform has to be formed and the house has to be placed at sufficient distance from the slopes, see Fig. 2-5**
- e) It is recommended that massive and heavy houses stand on soft sandy soils, whereas light flexible structures can stand on rocky soils.**
- f) Different floor levels should be avoided.**

If it is necessary, the rooms should be separated.

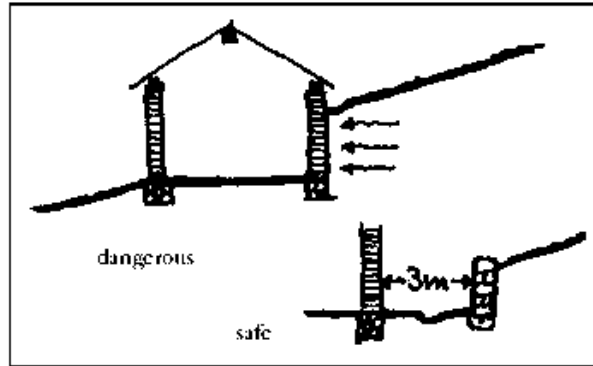

2-1



2-2

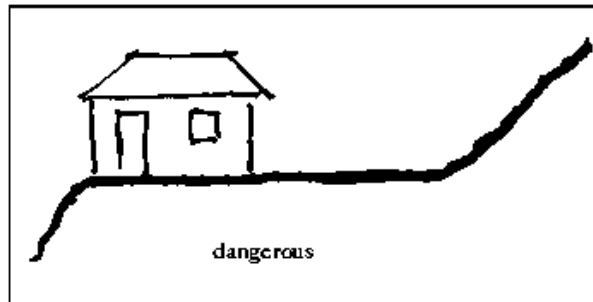

2-3

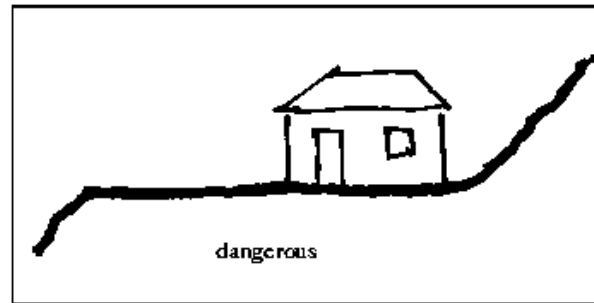

2-4

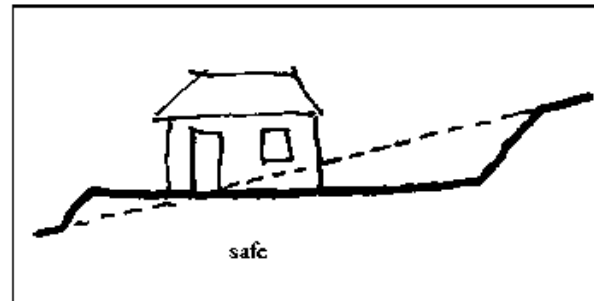

2-5

3. Shape of plan

The shape of the plan of the house might have an important influence on its stability. The following rules must be considered:

- a) The more compact a plan, the better the stability. This means a square plan is better than a rectangular one, and a circle is better than a square.
- b) L-shaped plans are less stable. The best solution in this case is to separate the elements as shown in Fig. 3-2.

At the University of Kassel a simple test method was developed within a doctorate thesis in order to show the influence of the wall shape on resistance to seismic shocks. A weight of 40 kg at the end of a 5.5 m long pendulum was dropped against the models, see Fig. 3-3. The rammed earth house with square plan showed the first large cracks after the second stroke, see Fig. 3-4. After three strokes one part of the wall separated, see Fig. 3-5, and after four strokes the house collapsed, see Fig. 3-6. The rammed earth house with circular plan, however, showed the first cracks only after three strokes, see Fig. 3-7, and only after six strokes did one small part of the wall separate, see Fig. 3-8 (Meyer, 1995). Goodstein built several

and only after six strokes did one small part of the wall separate, see Fig. 3-8 (Yazdani, 1985). Syed Sibtain built several houses in Afghanistan utilizing convex walls with buttresses, which give good stability similar to that of circular walls, see Fig. 3-9 (Sibtain, 1982). But the problem with all wall structures is that the openings weaken their stability. Therefore, openings must be carefully designed and often require additional reinforcement.

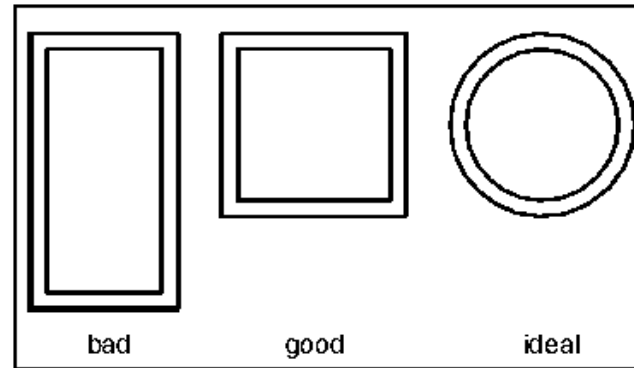

3-1 Ground plans

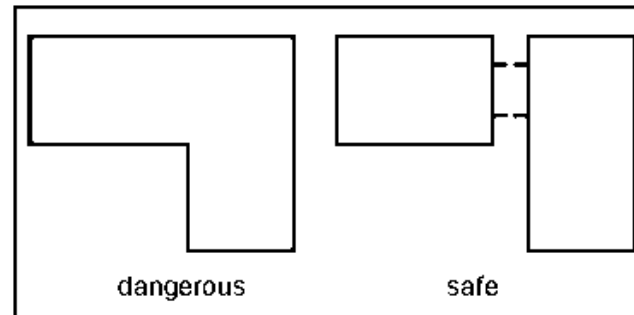

3-2





3-3 Simulation of seismic shocks (Minke 2000)

3-4 to 3-8 Earthquake tests with models of square and circular shape (Minke 2001)



3-4



3-5





3-6



3-7



3-8

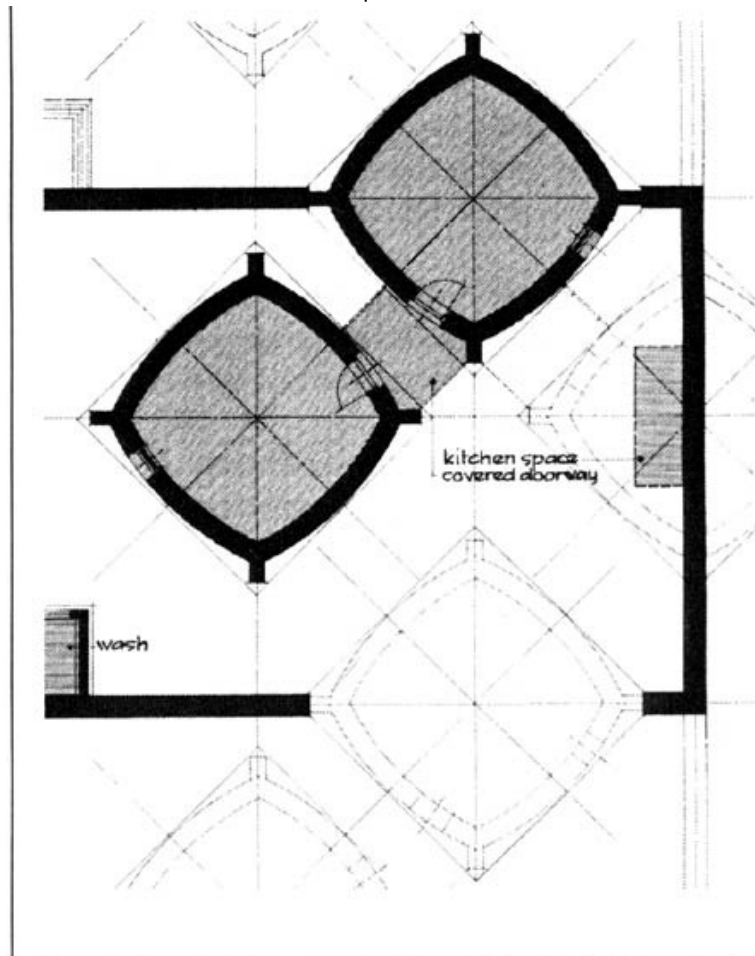

3-9 Plan of seismic-resistant houses, Afghanistan (Sibtain 1982)

4. Typical failures, typical design mistakes

Typical failures which occurred with simulated seismic movements on models in the scale of 1:5 are to be seen in Figs. 4-1 to 4-3. The most significant are:

- diagonal cracks lead from the edges of windows to the bottom of the wall,
- the lintel often destabilizes the walls, especially if it is not long enough and does not have sufficient bond with the wall,

- if the wall between window and door or between opening and corner is not long enough, it might break,
- if the wall has no ring beam at the top it breaks easily when suffering perpendicular loads which produce bending.

The houses shown in Fig. 4-4 seem to be well designed with the stabilizing buttresses at the corner. But without a ring beam they do not have sufficient stability against seismic shocks, as Fig. 4-5 and 4-6 show.

The 10 main structural mistakes which might lead to a collapse within an earthquake are explained in Fig. 4-7.

4-1 to 4-3 Typical failures caused by seismic movements (Tolles et al. 2000)

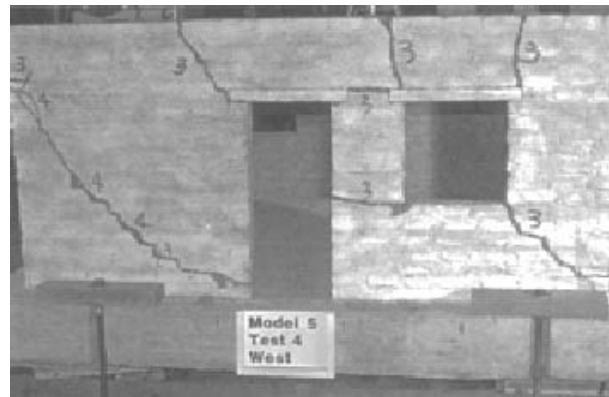

4-1

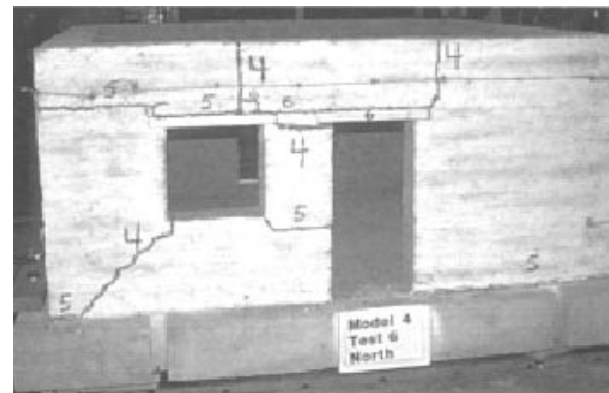

4-2



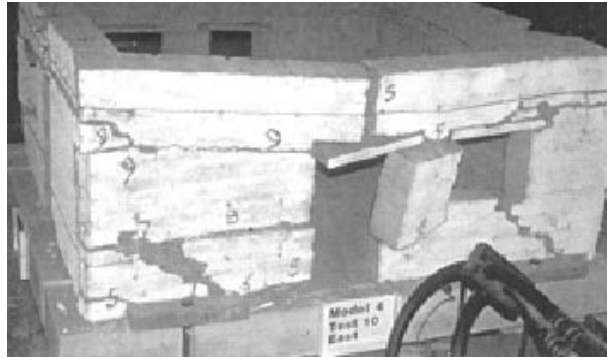

4-3

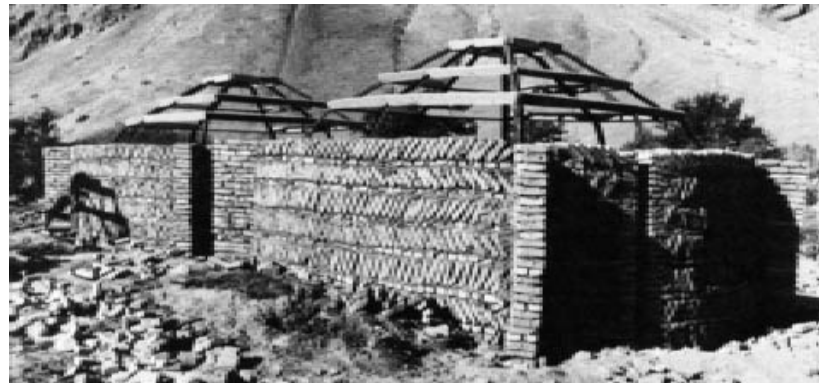

4-4 Earthquake-proof houses, Afghanistan (Sibtain 1982)

4-5 and 4-6 Models of the house in Fig. 4-4 after seismic movements (Sibtain, 1982)



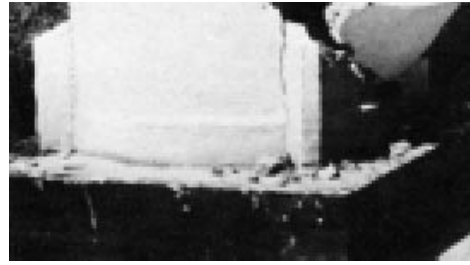

4-5



4-6

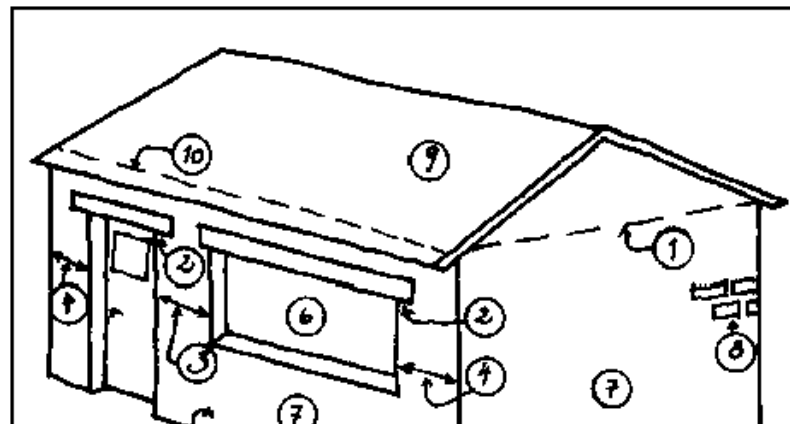

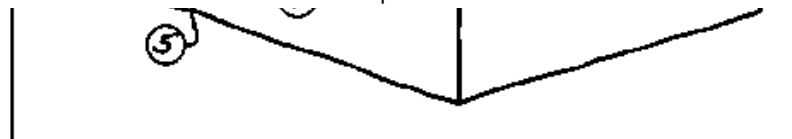

4-7 Typical design mistakes which might lead to the collapse of the house

1. Ring beam is lacking.
2. Lintels do not reach deeply enough into masonry.
3. The distance between door and window is too small.
4. The distance between openings and wall corner is too small.
5. Plinth is lacking.
6. The window is too wide in proportion to its height.
7. The wall is too thin in relation to its height.
8. The quality of the mortar is too poor, the vertical joints are not totally filled, the horizontal joints are too thick (more than 15 mm).
9. The roof is too heavy.
10. The roof is not sufficiently fixed to the wall.

5. Structural design aspects

There are three general principles for designing an earthquake-resistant structure:

1. Walls and roof are well interconnected and so rigid that no deformation occurs in the earthquake.
2. Walls are flexible enough, so that the kinetic energy of the earthquake is absorbed by deformation. In this case a ring beam, which is able to take bending forces, is necessary and the joints between wall and ring beam and ring beam and roof must be strong enough.
3. The walls are designed as mentioned in case 2, but the roof is fixed to columns separated from the wall, so that

both structural systems can move independently as they have different frequencies.

Case 1 can be a house with very thick rammed earth wall or a reinforced concrete frame structure with moment-stiff corners at the top and at the bottom, and infills of bricks, cement blocks or adobes.

A variation of a nonflexible structure is a timber frame structure which has less moment-stiff corners and is therefore stabilized by crossing diagonals of steel. In this case the danger exists that the connection of the diagonal or the elements itself may not be strong enough to withstand the concentration of stresses at the corner and breaks, causing the collapse of the wall, see Fig. 5-1.

The systems of case 2 and 3 can be built without concrete and steel and in most regions are much more economic. Walls built with the system of "wattle and daub" (in Spanish: "bahareque" or "quincha") show extreme flexibility. Fig. 5-2 shows a house which suffered under a heavy earthquake in Guatemala, but did not collapse.

As the vertical forces created by the earthquake are less important, we have to decide how the walls withstand the horizontal forces. There are two types of impacts to be considered: those forces, which act parallel to the wall and those which act perpendicular to it. (Forces acting at an inclined angle to the wall can be divided into two components, one parallel and one perpendicular to the wall.)

The perpendicular forces create a moment which might provoke a collapse of the wall if it is not stabilized by intermediate walls, buttresses and ring beams. If the walls are very thin and high, they might collapse even though stabilized, due to the bending forces that create buckling. The parallel forces are less dangerous. They produce thrust within walls which in the case of adobe walls with poor mortar create the typical diagonal cracks, shown in Fig. 4-1 and 4-2.

The most dangerous effects result when the walls fall outwards and the roofs collapse. Therefore the safest solution is to place the roof on a separate structure independent of the walls, see chapter 12.

When designing earthquake-resistant houses, we must consider that the horizontal force ("equivalent force") to be calculated is proportional to the mass of the structure and the higher the walls, the higher their displacement.



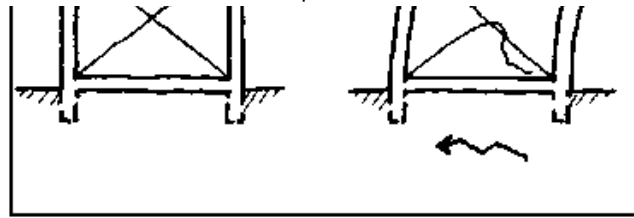

5-1



5-2 Wattle and daub structure, after a heavy earthquake in Guatemala (Minke 2000)

6. Rammed earth walls

6.1 General

In the rammed earth technique moist earth is poured into a formwork in layers 10 to 15 cm thick and compacted by ramming. The formwork consists of two parallel panels, separated and interconnected by spacers, see Fig. 6-1. By comparison with adobe masonry, rammed earth walls provide more stability as they are monolithic.

Traditional techniques use formwork with big wooden spacers, which cause openings and weak parts and often show horizontal shrinkage cracks between the layers, as the fresh layer on top of the old one shows larger shrinkage.

To avoid both disadvantages a special formwork was developed at the Building Research Laboratory (FEB), University of

Kassel, which is spaced only at the bottom by a very thin steel bar and on the top above the wall, see Fig. 6-4.

Traditional techniques use manual tampers with conical or flat heads, see Fig. 6-1. Conical tampers give a better bond between the different earth layers, but need more time. It is preferable to use a tamper with two heads, one with a round surface and the other with a square surface, see Fig. 6-2. The square tamper has to be used at the borders of the formwork. Pneumatic tampers and stronger formwork, as used nowadays for instance in Australia, can reduce the labor input by the factor of 10. (For further details see: G. Minke: Earth Construction Handbook, WIT Southampton, UK 2000)

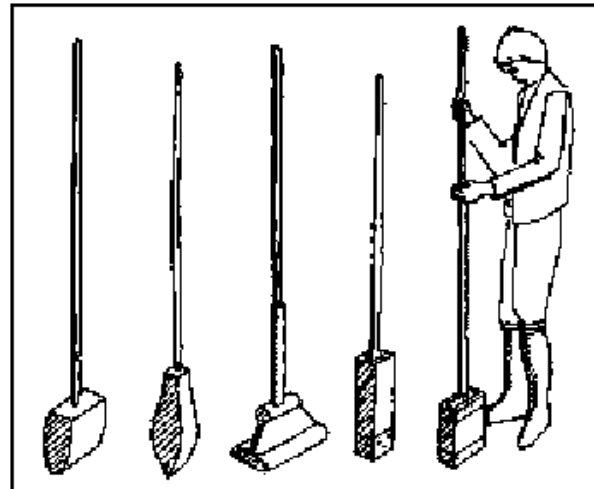

6-1 Manual tampers (Minke 2001)



6-2 Temper with two «heads», used in Ecuador (Minke 2001)

6.2 Stabilization through mass

Rammed earth walls 60 to 100 cm thick, which are not too high, can withstand horizontal seismic shocks without additional old age withstood all earthquakes, whereas newly constructed houses next to them collapsed, even when they were built with bricks and a concrete ring beam. As thick rammed earth walls are too labor-intensive and no longer affordable nowadays, new structural solutions have to be used, as set out in the following chapters

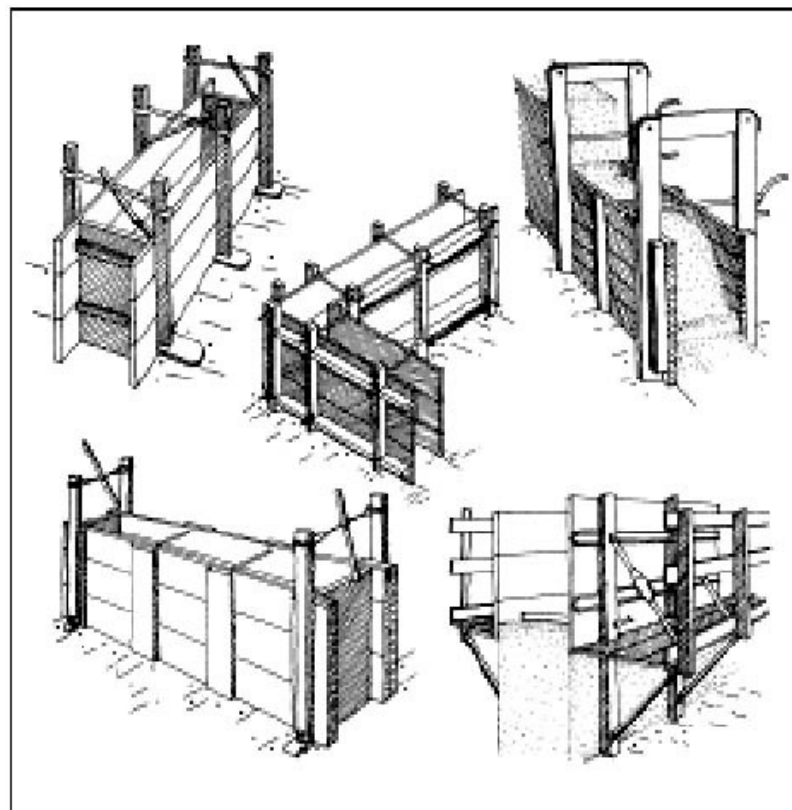

6-3 Formwork for rammed earth (Minke 2000)

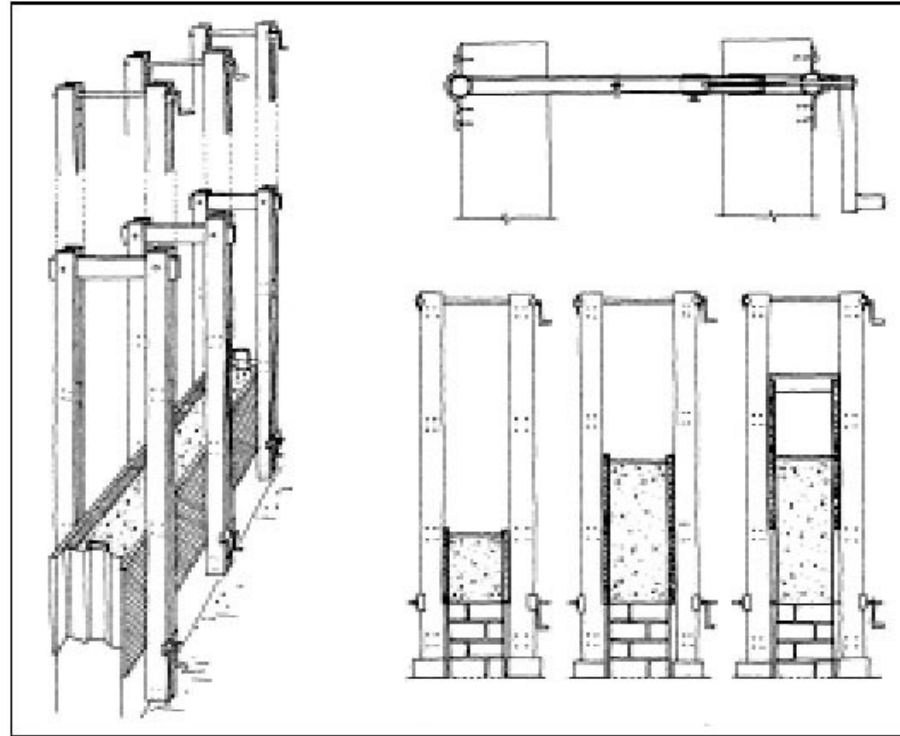

6-4 Climbing formwork (Minke 2000)

6.3 Stabilization through shape of elements

A simple solution for stabilizing rammed earth walls of lesser thickness is to use elements in the shape of L, T, U, X, Y or Z (Fig. 6-5). Due to their angles they show better stability against lateral forces. If the wall is 30 cm thick, the free ends of the elements should not be longer than $\frac{3}{4}$ and not shorter than $\frac{1}{3}$ of their height, see Fig. 6-6. This minimal length is necessary to transfer the loads diagonally to the plinth or foundation. If the free ends are longer than $\frac{3}{4}$ of its height, they should be stabilized by another angle. If the angle is well fixed on the bottom to the plinth and on the top to a ring beam, it can be larger or higher. Nevertheless, the height should not be more than 8 times the width, see Fig. 6-7.

The forces perpendicular to the wall are transferred into the angle which is parallel to the direction of the force. This means it is transferred versus a moment which creates stress concentration at the inner corner of the angle.

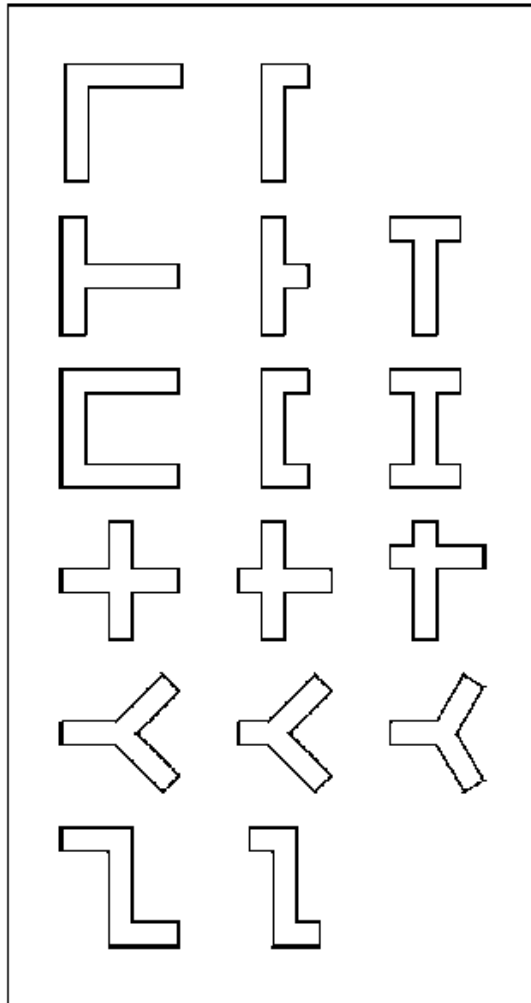

6-5 Wall elements stabilized by their shape

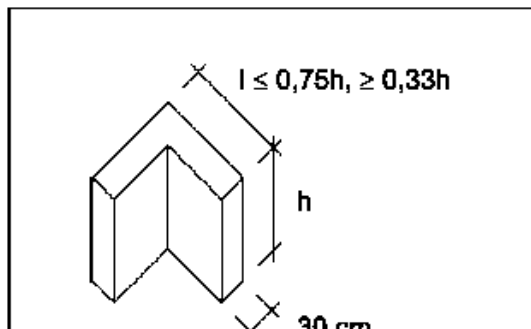

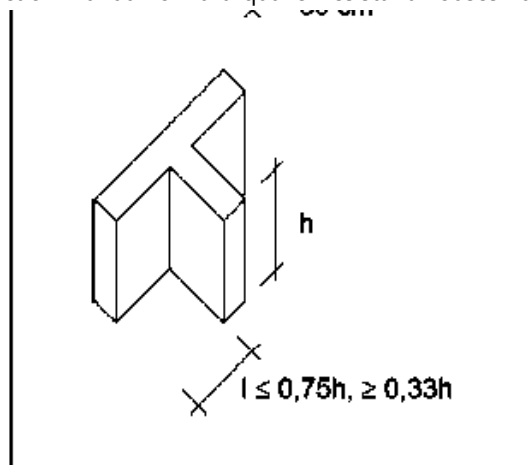

6-6 Recommended proportions

Therefore it is advisable to enlarge the section at this corner, shown in Figs. 6-8 and 6-9. Fig. 6-12 shows different proposals for plans utilizing angular elements.

To improve lateral stability the joint of two elements should be formed with tongue and groove, see Fig. 6-10. However, in order to obtain a more flexible structure, elements with shorter length and no tongue and groove joint should be used (Fig. 6-11), if the elements are well linked to a ring beam above and to a plinth below. This kind of solution is used in the project described in chapter 6.4.

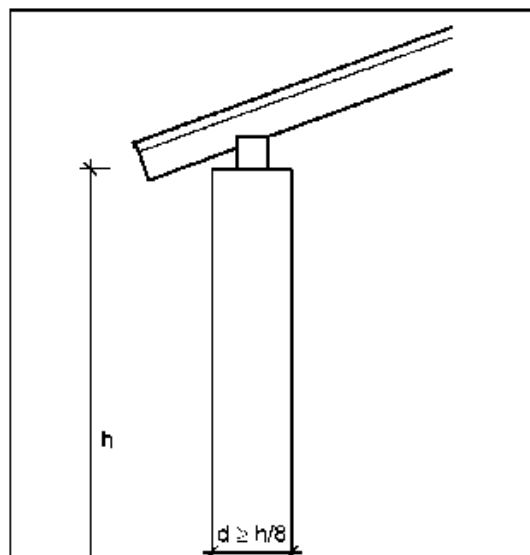

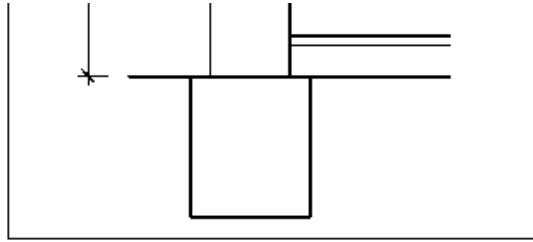

6-7 Expedient proportion of wall

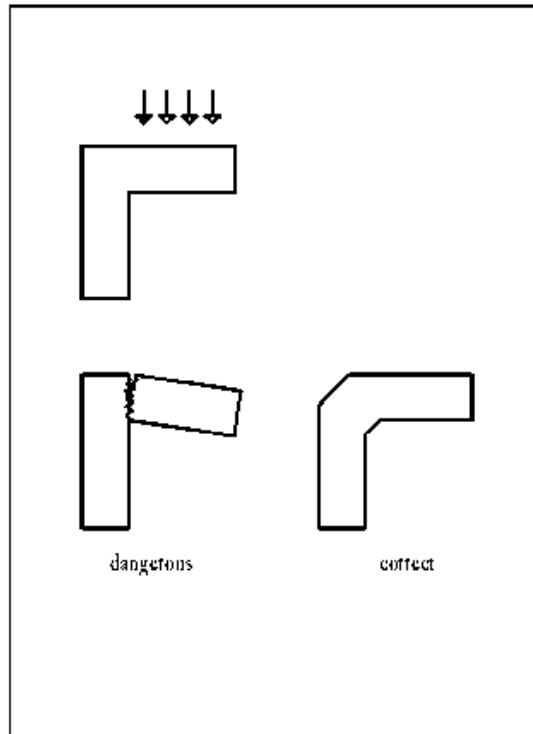

6-8 Corner solution

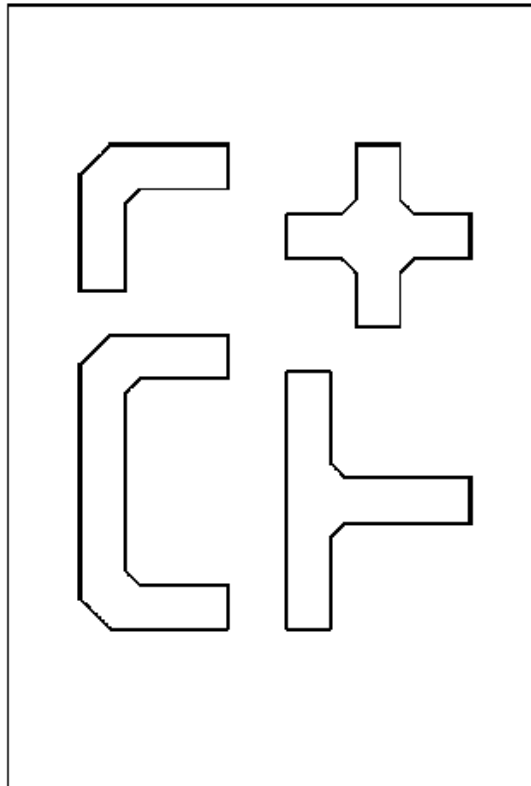

6-9 Elements with correct corner details





6-10 Joint with lateral stability

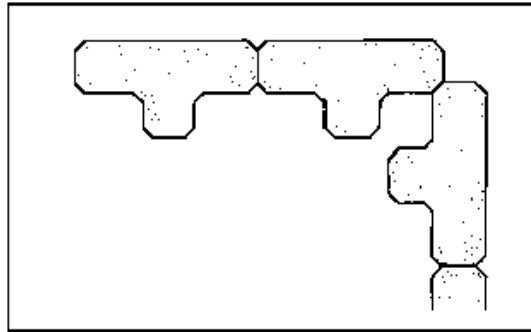

6-11

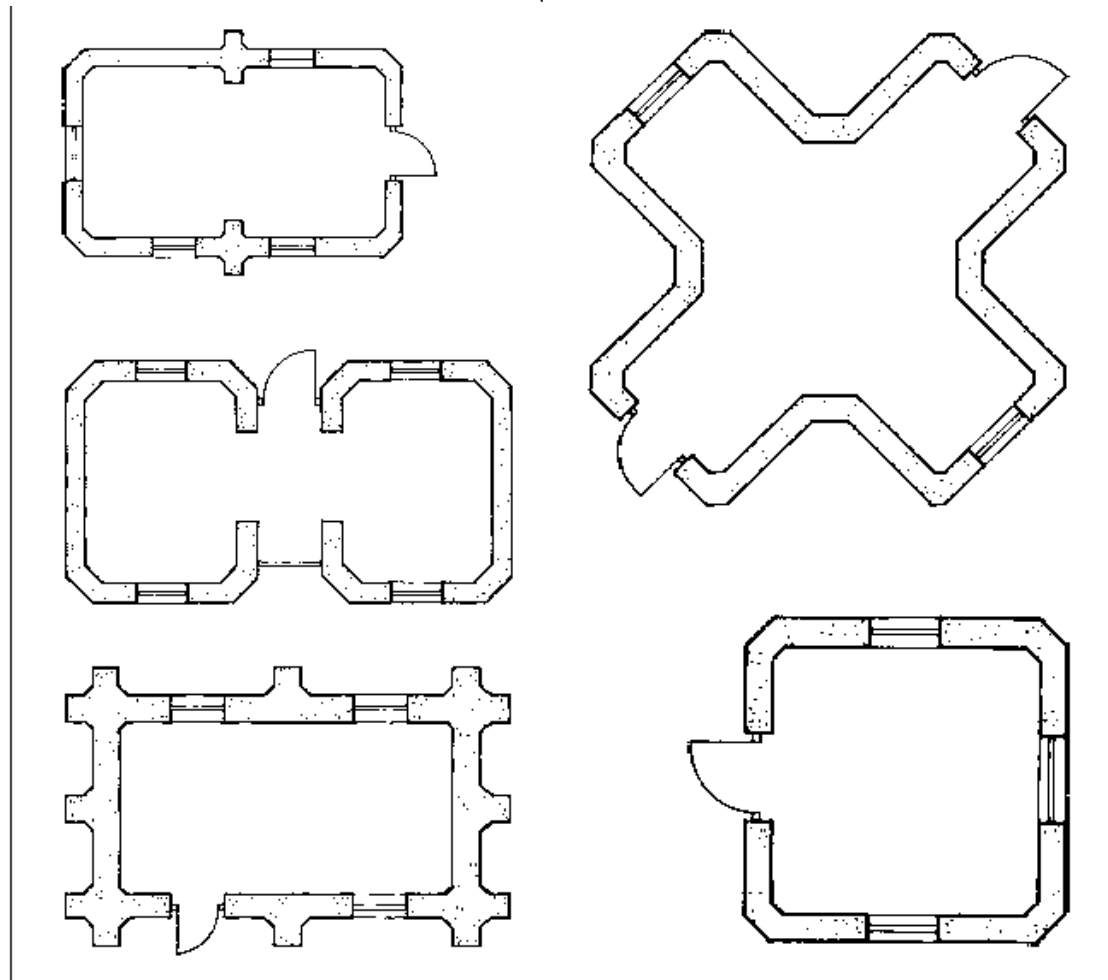

6-12 Proposals for simple plans utilizing angular elements

6.4 Internal reinforcement

One method of stabilizing rammed earth walls against horizontal forces is to use vertical rods of bamboo or wood inside the wall. These elements should be fixed to the foundation below and to a ring beam above, see Fig. 6-13. Horizontal reinforcement elements usually weaken the structure and lead to horizontal cracks, as shear forces cannot be transferred by the rods, since the bond between these elements and the earth is very poor. Furthermore in practice it is difficult to ram the earth well underneath these elements, due to their elastic behavior when hit.

A new system utilizing bamboo as vertical reinforcement for element-type rammed earth walls was developed in 1978 at the

FEB and successfully implemented together with the University Francisco Marroquin (UFM) and Centre of Appropriate Technology (CEMAT), both from Guatemala. The low-cost housing prototype built is depicted in Figs. 6-14 to 6-19. The wall elements were rammed in a metal T-shape form, 40 cm high, 80 cm large and 14 respectively 30 cm wide, see Figs. 6-16 and 6-19. The rib plays an important role in the stabilization of the element against horizontal forces, as it acts like a buttress. The elements are reinforced by 4 vertical bamboo rods of 2 to 3 cm diameter. The bamboo rods were fixed at the bottom to the horizontal bamboo ring beam and the stretched vertical rods of the plinth, see Fig. 6-14.

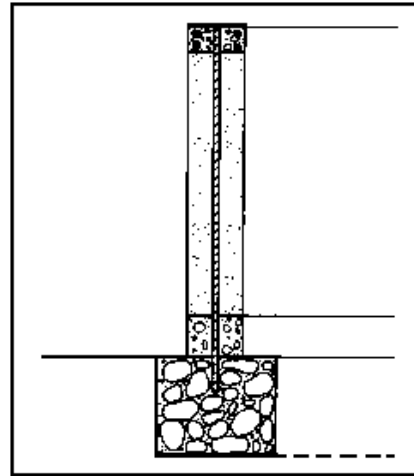

6-13

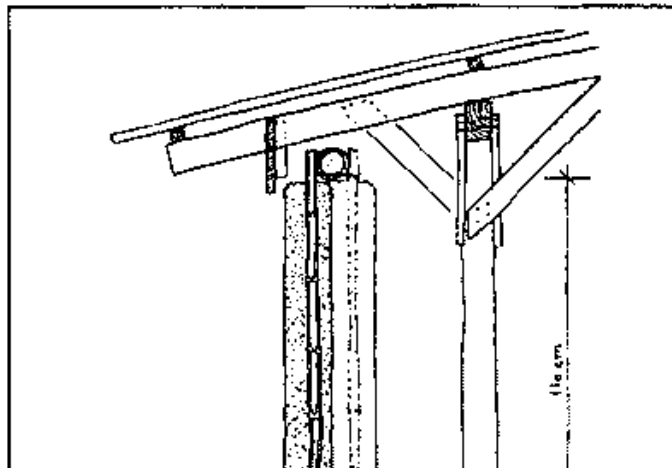

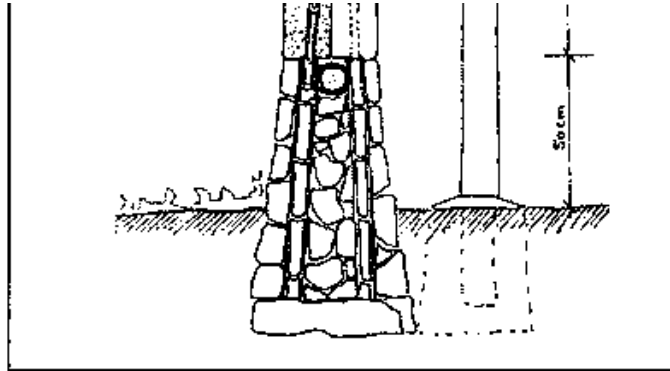

6-14

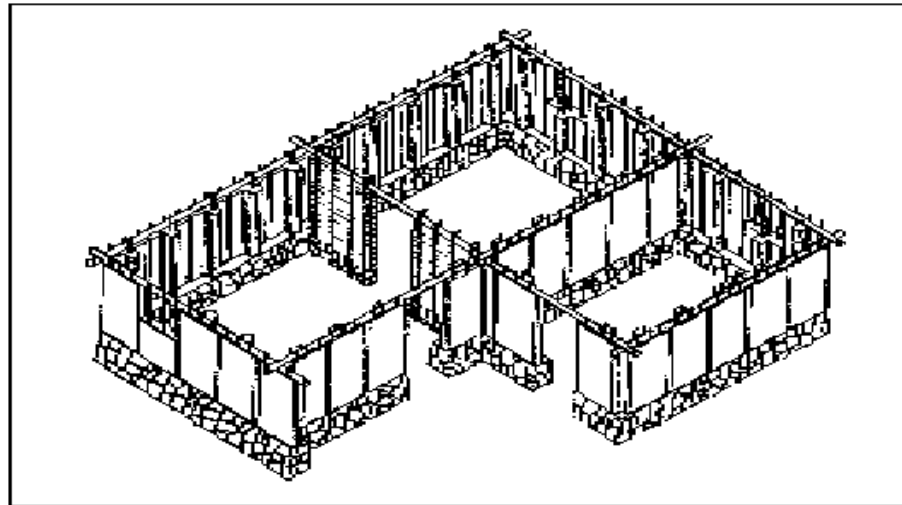

6-15





6-16

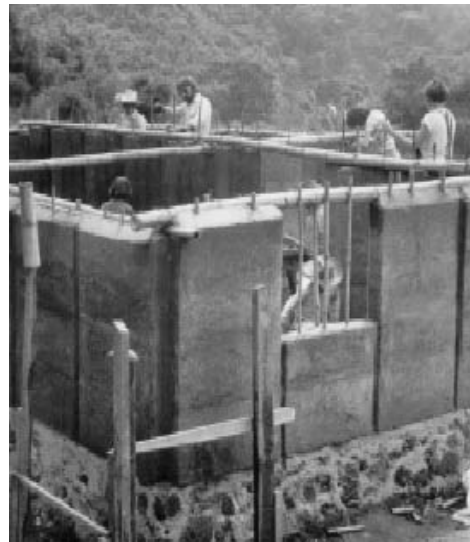

6-17

After drying vertical gaps of 1 to 2 cm appeared between the elements, which were then closed by earth. These vertical joints are predesigned rupture joints which can crack in an earthquake and allow independent movements of each element. So the kinetic energy of the seismic shock will be absorbed by deformation, but the element being fixed at the top and bottom will not fall. After the earthquake the open joints can easily be closed again with earth. Using this idea an earth wall system was developed, which is massive and flexible at the same time. The second new fact with this prototype structure was that the roof rests on posts standing 50 cm inside the walls, so that the roof and the walls can swing independently of each other within the earthquake.



6-18

In 1998 the FEB developed another reinforced rammed earth wall system which was utilized for a low-cost housing project built in cooperation with the University Santiago de Chile in 2001 in Alhué, Chile, see Figs. 6-20 and 6-21. Here too the idea was to separate the roof from the wall system and to use U-shape and L-shape elements, which stabilize themselves by their shape.

The corners of the angular elements were cut under 45 degrees in order to increase their strength as described in chapter 6.3. To obtain additional stabilization they were reinforced by vertical rods of colligue (similar to bamboo), 3 to 5 cm in diameter. Furthermore, the wall elements were always separated by light, flexible elements, or doors and windows. The lower parts of the windows and the parts above the doors were not built with massive elements, but instead of light timber elements. The gables were built in lightweight straw-loam stabilized by wooden elements, similar to the wattle and daub system.

6-14 to 6-19 Earthquake resistant low-cost housing project, Guatemala (Minke 2001)

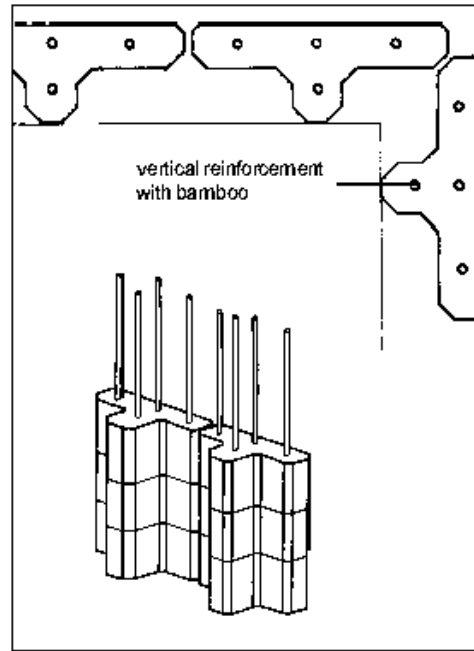

6-19

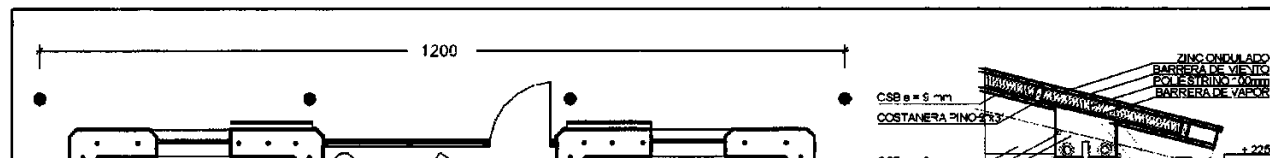

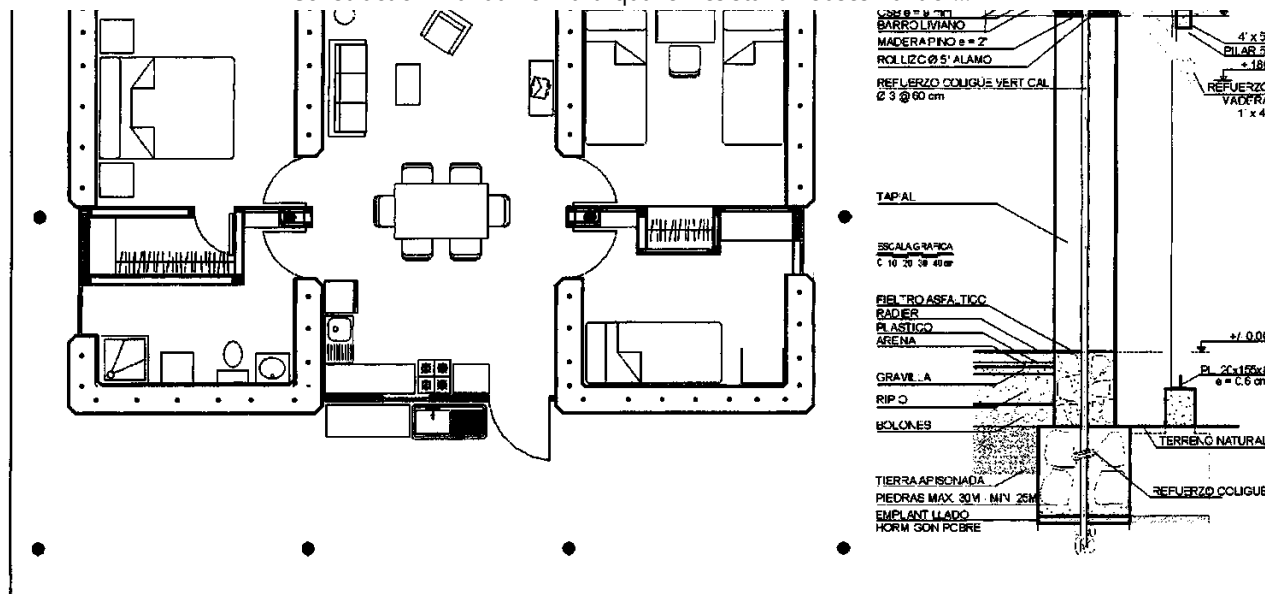

6-20 and 6-21 Earthquake resistant prototype building, Alhué, Chile 2001

7. Adobe walls

7.1 General

Blocks of earth produced manually by throwing wet earth into a formwork are called adobes, or mud bricks or sometimes sun-dried earth blocks. When moist earth is compacted in a manual or powered press, the compressed elements so formed are called soil blocks. Blocks produced by an extrusion process in a brick plant, are called green bricks in their unburnt state. Larger blocks compacted in a formwork by ramming are called rammed earth blocks.

There are many different shapes known all over the world. Fig. 7-1 shows some samples.

Different manually operated presses are known too. Fig. 7.3 shows one of the first, the widespread CINVA-Ram, and Fig. 7-4 the CETA-Ram, which can produce 3 smaller blocks at the same time. Blocks produced by these presses have the advantage of a more exact shape with sharp corners than handmade adobes. Their disadvantages are that they usually need the addition of 4-8% cement to the soil in order to obtain sufficient stability and that the production output is only half by comparison with adobes.

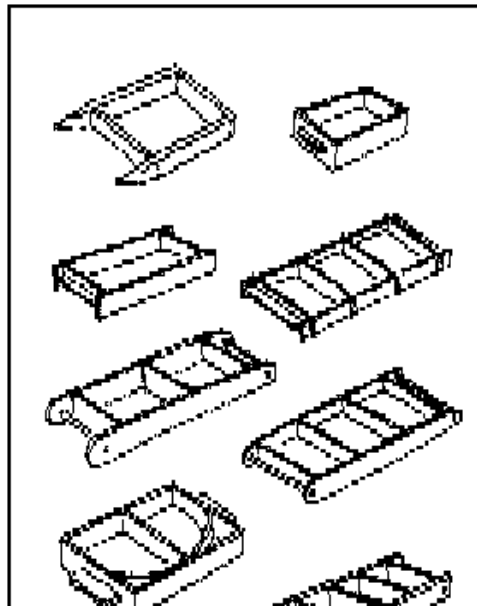

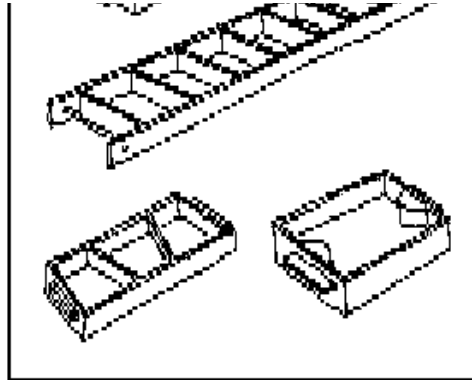

7-1 Adobe forms (Minke 2000)

7-2 Production of adobes in Ecuador



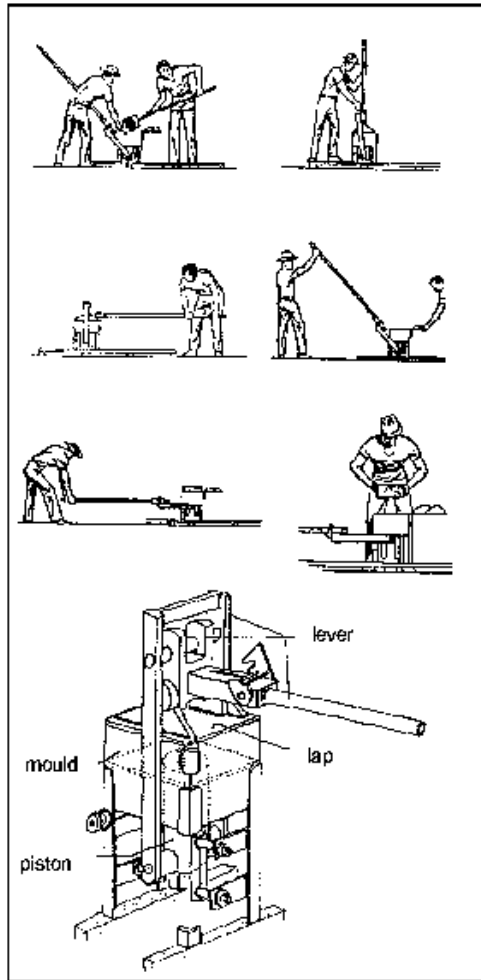

7-3 CINVA-Ram, Colombia



7-4 CETA-Ram, Paraguay

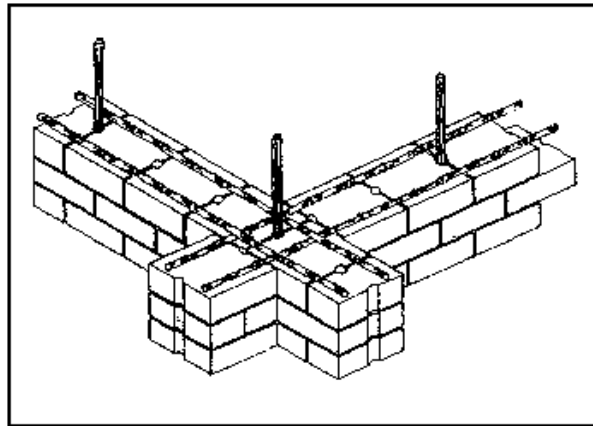

7-5 System ININVI, Peru

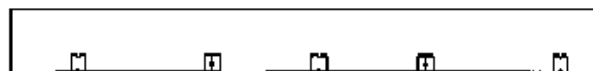

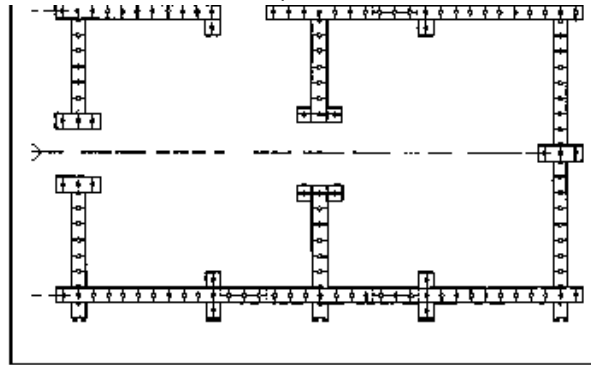

7-6 Ground plan with system ININVI, Perú (Pereira 1995)

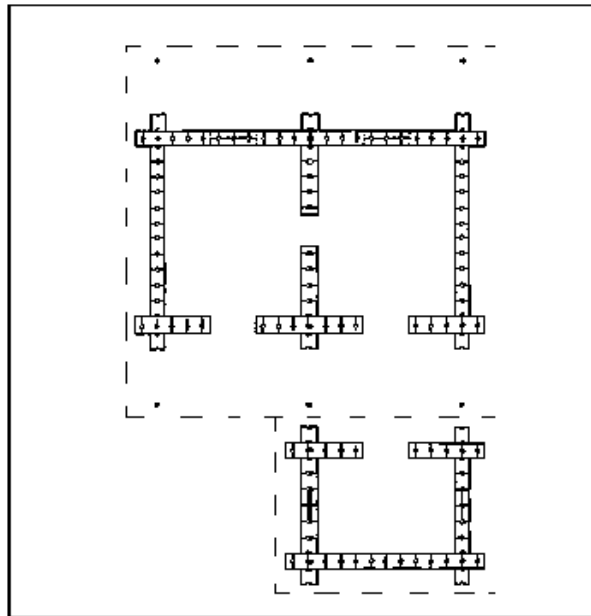

7-7 Improved ground plan with system ININVI, (Equipo Maiz, El Salvador 1995)

7.2 Internal reinforcement

The "Instituto nacional de investigación y normalización de la vivienda (ININVI), Peru, developed a system of adobe walls which are stabilized by vertical bamboo rods that fit into holes of 5 cm diameter, formed by grooves at the side of square adobes and halved ones, see Fig. 7-5. Corner buttresses and intermediate buttresses stabilize the wall, see Fig. 7-6. In Fig. 7-8 it can be seen that the horizontal elements of the roof trusses rest on and are fixed to the buttresses. It is important to mention that if the length of a wall is 12 times larger than its thickness, it should have an intermediate buttress, see Fig. 7-6

and 7-9. Interior walls must also have a buttress when they meet the exterior walls. Fig. 7-7 shows a simple design with shorter walls and a separate kitchen built in Salvador (Equipo Maiz, 2001).

Horizontal bamboo rods, as shown in Fig. 7-5, normally do not strengthen the structure. They weaken the walls as they disturb the transfer of shear forces. This is due to the fact, that in practice there is not sufficient bonding between the rods and the adobe, as they are not always covered by 2 cm of mortar and as the quality of the mortar is too poor to take the shear forces.

The buttresses at the corners can be substituted by columns of reinforced concrete, see Fig. 7-10. In the case of the solution shown on the left, it is necessary to place horizontal steel bars at least every 50 cm which grip into the joints with their angles. This detail was forgotten in all publications which illustrate this solution. Without this bond, the column will separate from the wall when strong horizontal shock occurs in the earthquake.



7-8 Educational centre Acomayo, Perú (Pereira 1995)
[c_anti_quake_earth_housing page no: 40 of 91](#)

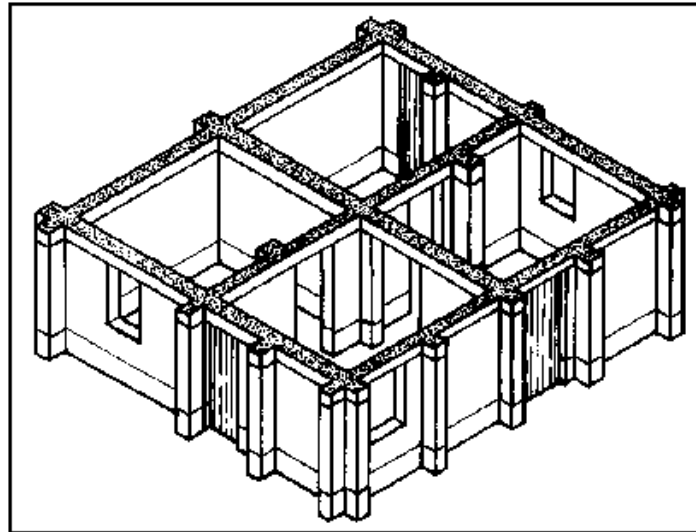

7-9 Adobe walls reinforced by butresses

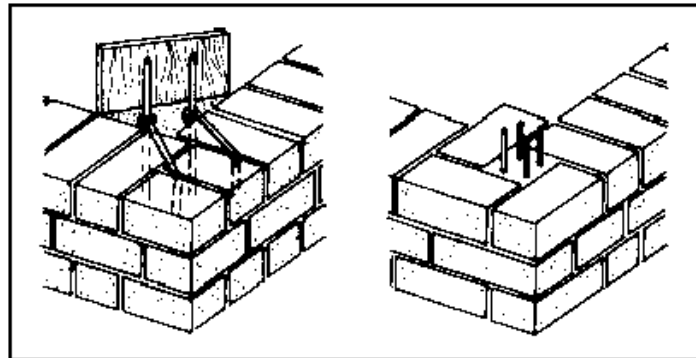

7-10 Stabilized corners

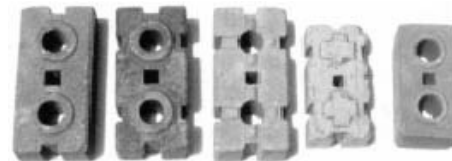

7-11 Interlocking blocks (Weinhuber 1995)

7-12 and 7-13 Prototype house, Thailand 1984 (Weinhuber 1995)



7-15 Improved interlocking system of FEB, Kassel, 2001

7.3 Interlocking blocks

Walls without mortar can be built with interlocking blocks. The blocks have holes for vertical reinforcement elements from

Walls without mortar can be built with interlocking blocks. The blocks have holes for vertical reinforcement elements from steel rods or bamboo canes fixed by pouring cement sludge into the holes. The blocks are pressed in special molds and normally stabilized with cement, see Fig. 7-11. If they have enough vertical reinforcement elements, at least at corners and intersections, and if these are well fixed to the plinth and the ring beam, these walls are supposed to be earthquake-resistant due to their flexibility. The system was developed at the Asian Institute of Technology, Bangkok. Figs. 7-12 and 7-13 shows the first demonstration building, built in 1984 in Thailand. In this case the holes were filled with a mixture of cement and sand in the ratio 1:3.

Fig. 7-14 shows a similar system, developed by the University of the Andes, Mérida, Venezuela. The blocks have grooves and tongues which interlock. Horizontal ring beams of reinforced concrete are placed at a height of 1.20 m and on top of the wall.

If stacked without mortar these walls do not show any high resistance to horizontal forces as the interlocking effect is only given by a height of some millimeters.

Therefore the author developed an improved interlocking system, with blocks showing tongues and grooves 40 mm high, in horizontal as well as in vertical joints, see Fig. 7-15. If these blocks are displaced or lifted up by seismic shocks, they always fall back into their normal position. The holes act as gripholes for easy handling, but can also be used to install vertical reinforcement elements. But these additional reinforcement elements are not necessary if the wall corners are formed by concrete columns, which interlock with the block as shown in Fig. 7-15, and these columns are interconnected by a ring beam.

7.4 Concrete skeleton walls with adobe infill

Normal masonry walls are not very stable against seismic shocks. Therefore, nowadays the masonry walls are often framed by concrete which forms a skeleton structure with adobe (or brick) infill, see Fig. 7-2 and 7-3. The vertical concrete columns should have 4 steel bars of at least 14 mm diameter. It is important that the concrete and the adobes interlock, as shown in Fig. 7-16. For low-cost housing projects this solution is normally too expensive. Moreover it shows hardly any flexibility.

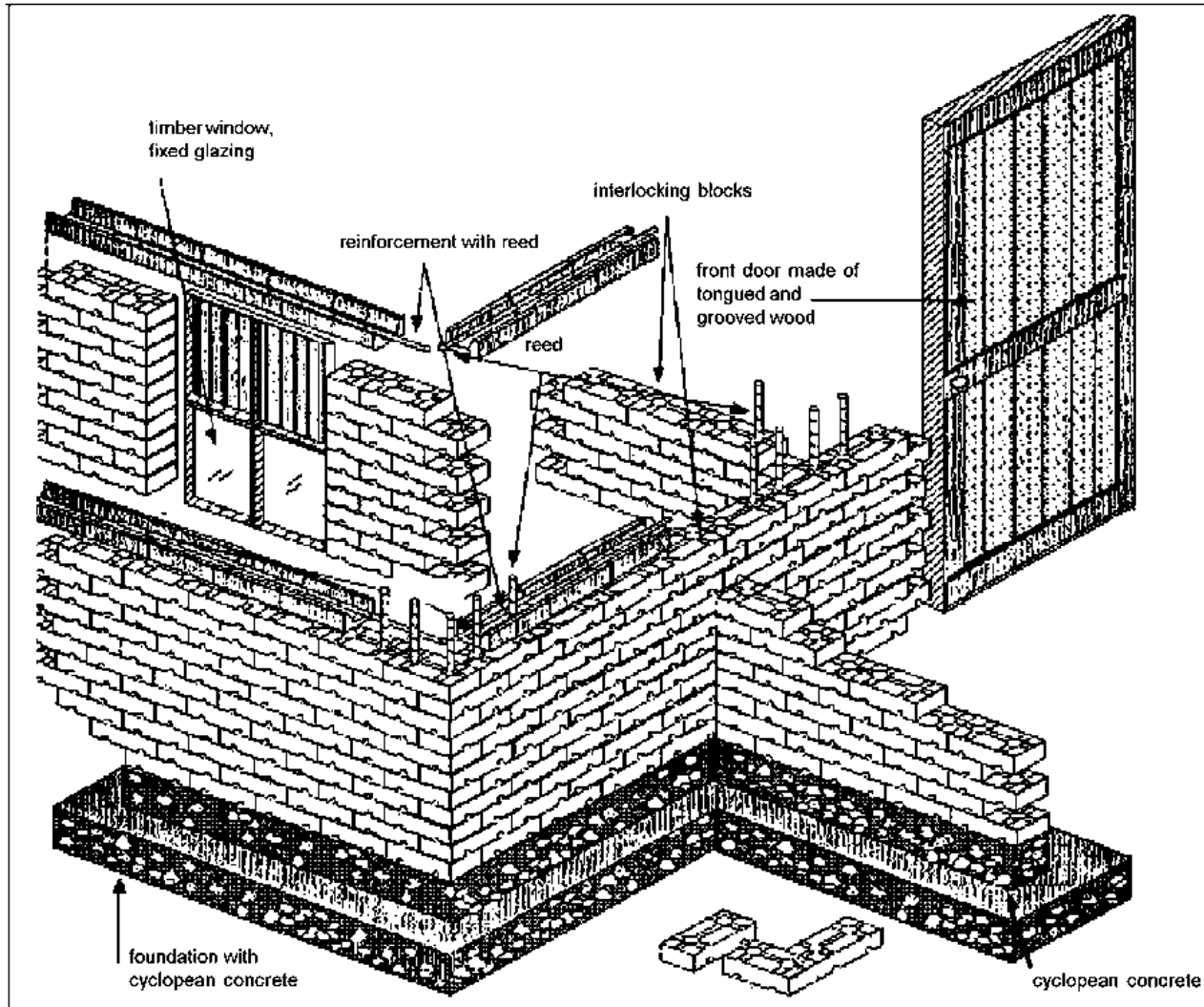

7-14 Building system invented by Universidad de los Andes, Mérida, Venezuela (Pereira 1995)

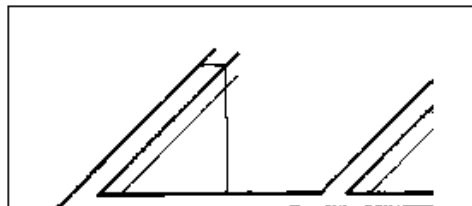

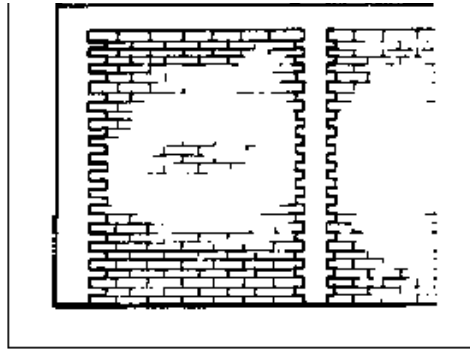

7-16

8. Wattle and daub

The wattle and daub wall system, which is called bahareque or quincha in Latin America, consists of vertical and horizontal elements made of timber or bamboo, forming a double layer grid which is filled with earth. Single-layer systems also exist, see Fig. 8-1. The vertical elements are usually tree trunks, the horizontal ones bamboo, reed or twigs. This is the most flexible system, as it is basically a timber grid structure with flexible joints and earth infill.

The disadvantage of this system is that it needs a lot of maintenance, as it cracks easily due to the thin cover of the wood elements and the swelling and shrinking of the wood. In practice there are often cracks and holes, where erosion starts and where insects can live; for instance in Latin America those that create the "decease mal de chagaz". Fig. 8-3 shows a system, developed by CEPED, Camari, Brazil, with prefabricated wall elements, to be filled locally with earth. The design in Fig. 8-4 by the architects Kühn, Poblete and Trebilcock show an interesting combination of rammed earth columns and wattle and daub intersections. This design was developed during a workshop on earthquake-resistant house design, sponsored by DFG and held by the author in 1998 at Santiago de Chile.

A very poor, unstable solution is shown in Fig. 8-5, sometimes built in Latin America after earthquakes as a quick solution to create shelter. The timber frame walls are filled with adobes, mounted upright and held by barbed wire on both sides. As the distance between the vertical posts is too large and the wires are not tightened enough, the adobes easily fall down.





8-1 Traditional wattle and daub system, Venezuela (Minke 2001)

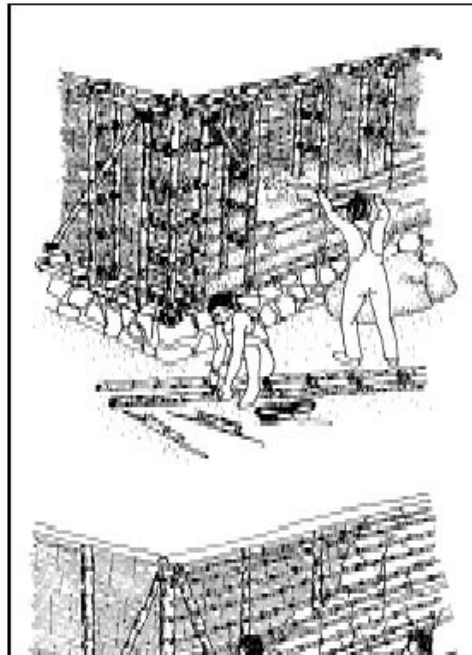

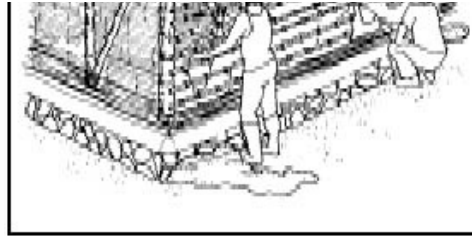

8-2 Wattle and daub systems (after Vorhauer 1979)



8-3 Prefabricated system CEPED, Brasil

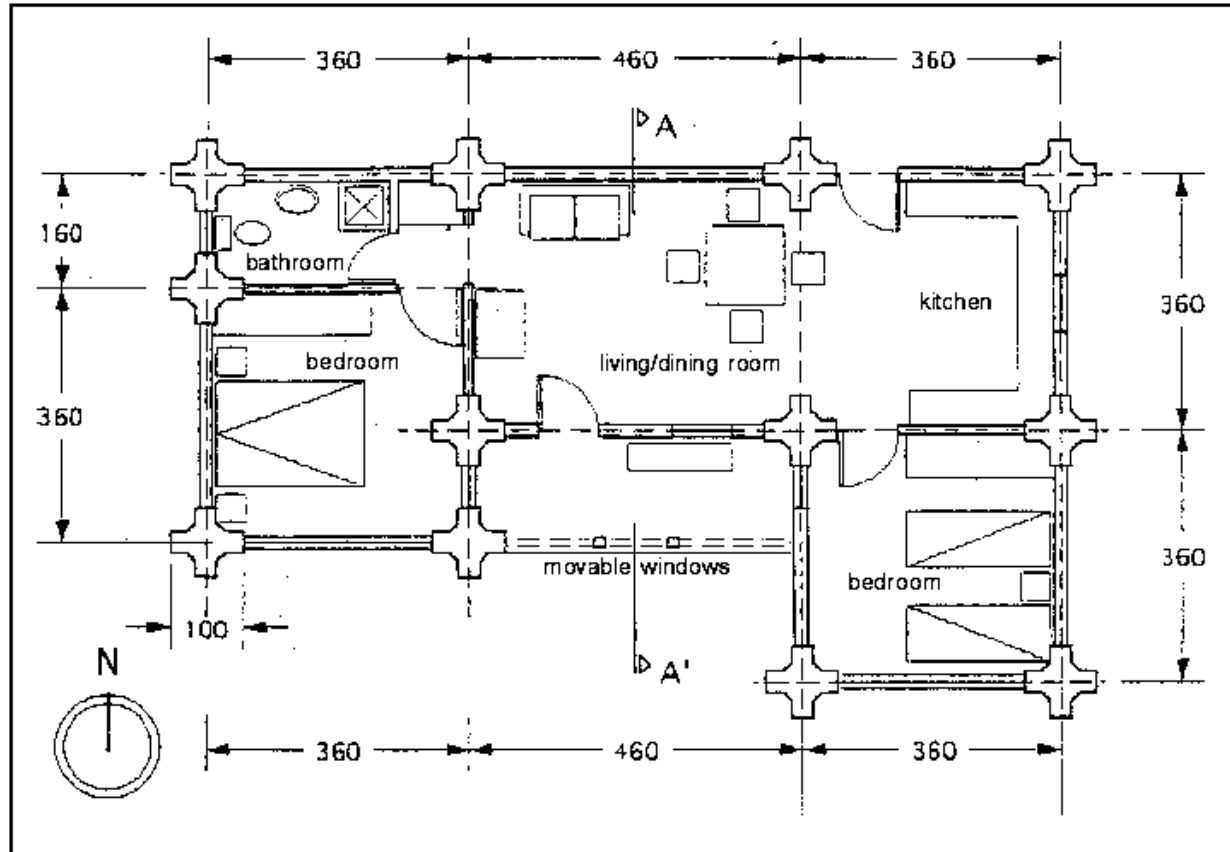

8-4



8-5 Dangerous solution, Chile

9. Textile wall elements filled with earth

At the Building Research Laboratory (FEB), University of Kassel, different solutions using textile earth-filled elements for walls were tested. Fig. 9-1 shows a prototype building, built in 1978 in Kassel. The wall consists of hoses made of jute fabric filled with earth and pumice aggregate, stacked without mortar but fixed with strips of cut bamboo driven through the layers. The elements were laid in a U-shape, the top of the wall was fixed to a ring beam, see Fig. 9-2. In order to avoid rotting of the fabric, the wall was covered with 4 layers of thin lime paint, see Fig. 9-3. The roof structure, built of tree trunks, rests on posts separated from the wall.

Within a research project concerning seismic-proof low-cost housing the FEB together with the University Francisco Marroquin and CEMAT, Guatemala, built a prototype house of 55 m² in Guatemala in 1978, see Fig. 9-7. In this case cotton hoses of 10 cm diameter were sewed, filled with earth and pumice (Fig. 9-4), dipped into lime milk (Fig. 9-5) and stacked between thin bamboo sticks (Fig. 9-6).



9-1 Low-cost housing prototype, University of Kassel, Germany 1978

9-2 and 9-3 Wall with filled textile hoses





9-4 to 9-6 Filling and stacking of textile elements







9-7 Earthquake resistant low-cost housing prototype, Guatemala 1978

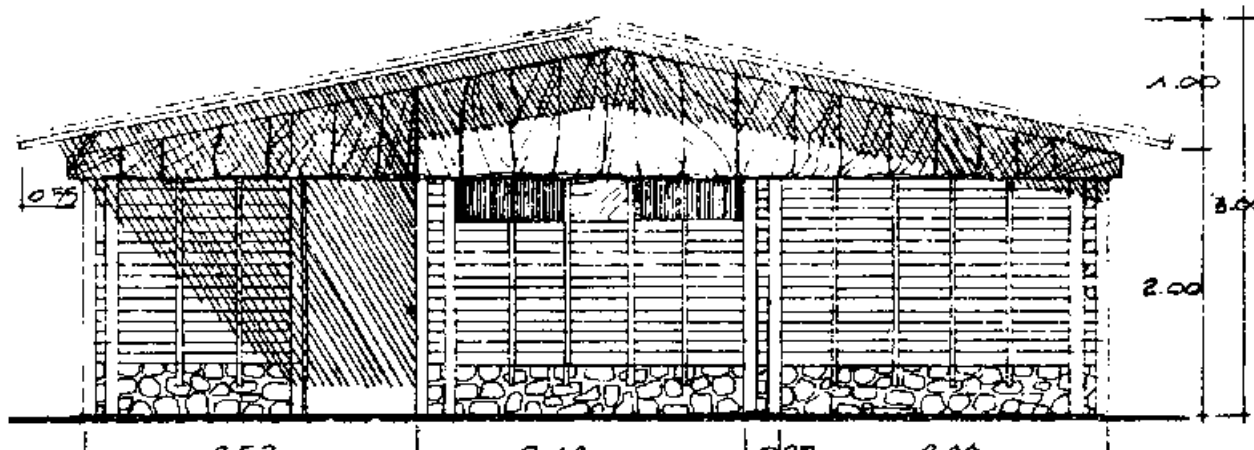

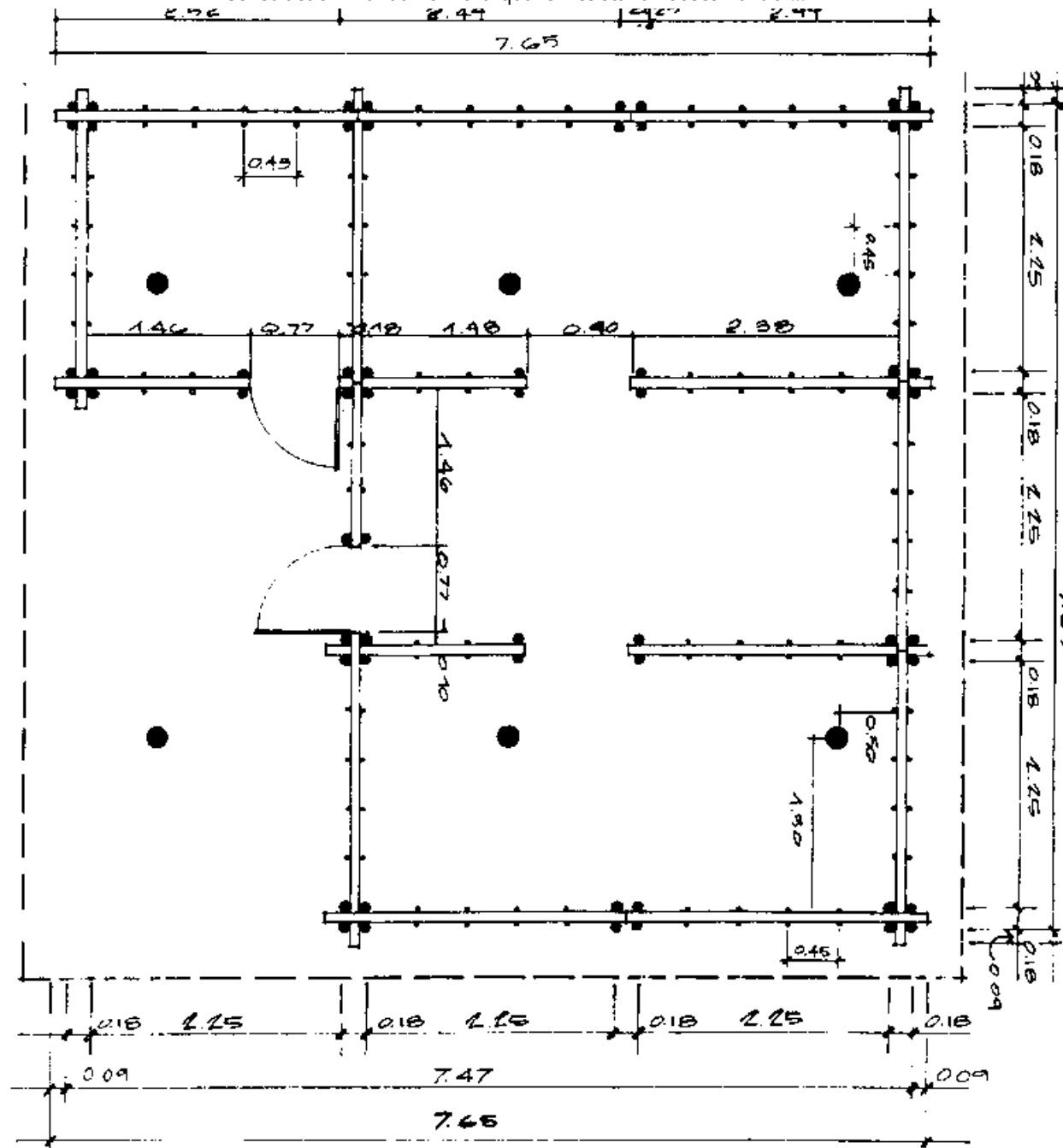

9-8 Earthquake resistant low-cost housing prototype, Guatemala 1978

Four vertical posts every 2.15 m and thin bamboo rods of 2 to 4 cm diameter every 45 cm stabilized the wall. The surfaces

were painted with a paint made of 1 bag of lime, 4 kg kitchen salt, 2 kg alum and 30 liters of water. In the prototype structure, shown in Fig. 9-1, another new textile system was tested, which is to be seen at the right side of the house. It consists of a prefabricated U-shaped wall of jute fabric, kept by wooden sticks pushed into the earth. The container ("bag") formed in this way was then filled with pumice and earth, see Fig. 9-9. The model of this system is shown in Fig. 9-10 and 9-11.

9-9 to 9-11 Textile wall elements filled with earth





10. Critical joints and elements

10.1 Joints between foundation, plinth and wall

For a wall 30 to 40 cm of thick the foundation should usually be 20 cm wider and 40 cm or more high, see Fig. 10-1, depending on the rigidity of the soil. With a 50 cm thick rammed earth wall the plinth and foundation can be of the same width. The plinth is usually built of rubble random stone or bricks, but can also be of concrete with large stone aggregates. As it shelters the wall against splashing rain water, the height should be at least 30 cm. The joints between foundation and plinth as well as between plinth and wall have to have a good bond in order to be able to transfer shear forces. They should be situated every 30 to 50 cm. The easiest solution is to integrate a vertical wooden rod and to create a rough plinth surface, see Fig. 10-2. In the case of adobe walls the mortar must have a very good adhesion and a high bending strength. Horizontal damp-proof courses will interrupt the necessary bond.

A proposal by the author, not yet tested, is a "floating" foundation created by a channel of round pebbles which reduce the kinetic energy of the horizontal shocks, see Fig. 10-3.

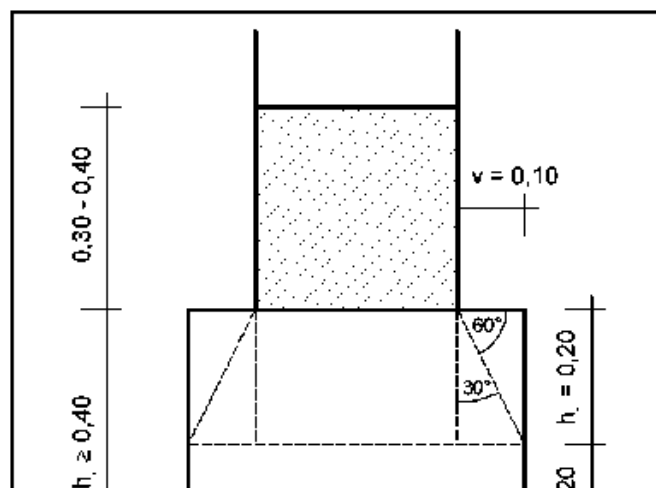

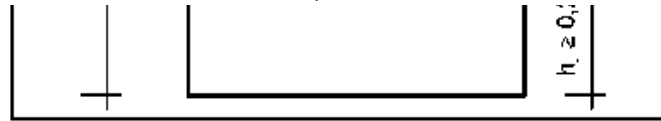

10-1 Foundation of external walls

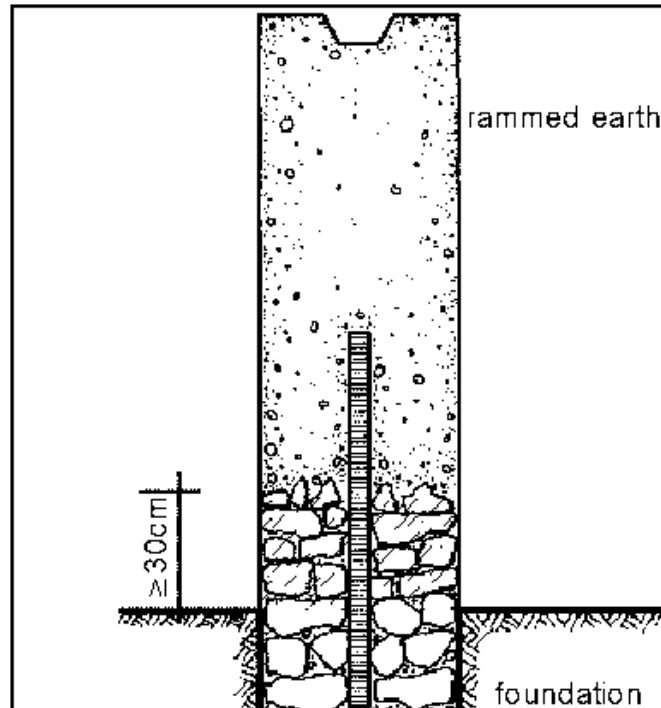



10-2

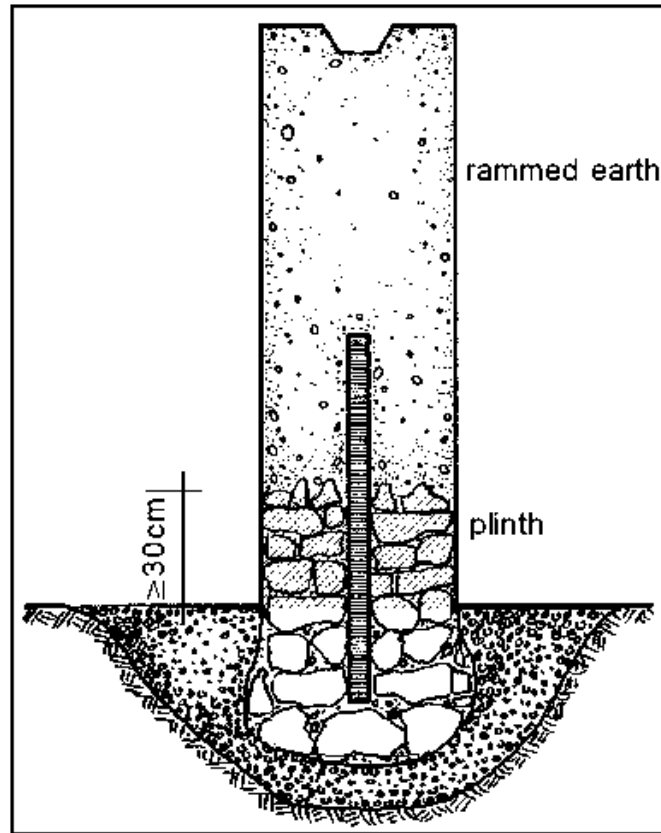

10-3 Floating foundation

10.2 Ring beams

Walls always have to be kept on top by a closed ring beam, which must be able to take bending loads when there are lateral forces against the wall. In order to prevent the walls from buckling and falling, the connection between wall and ring beam must be very strong. The ring beams can also act as a support for the roof structure. Fig. 10-4 shows one way of fixing a wooden ring beam to a rammed earth wall. A better solution is shown in Fig. 10-5 and 10-21, where a vertical interior reinforcement element of wood or bamboo is fixed to the foundation at the bottom and to a double ring beam at the top.

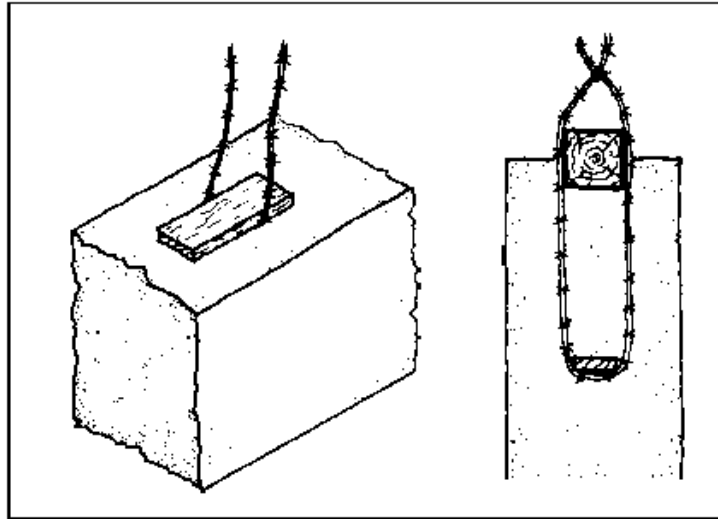
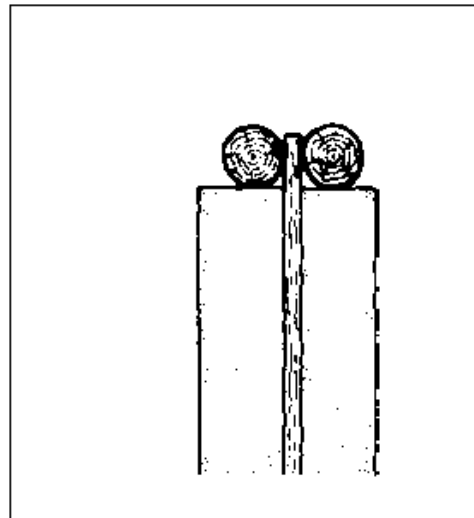
**10-4 Fixing of ring beam****10-5 Fixing of ring beam**

With adobe walls without vertical reinforcement elements it is not so easy to obtain a good bond between the masonry work and the ring beam. In the case of a reinforced concrete ring beam it is necessary to leave the last layer of adobes with open vertical joints so that the concrete will go into the gaps. In the case of adobe walls, if the ring beam is made from timber, as seen in Fig. 10-6, these elements must be covered by 2 cm of mortar with good adhesion values.

As corners of ring beams have to be able to transfer moments under seismic forces, they must be stiff. Figs. 10-6 to 10-8 and 10-12 show solutions for stiffening the corners for timber ring beams, while Figs. 10-9 to 10-11 show solutions for reinforced concrete ring beams.

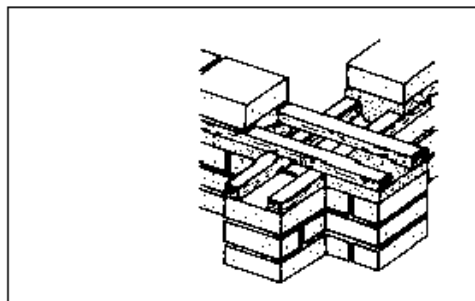

10-6

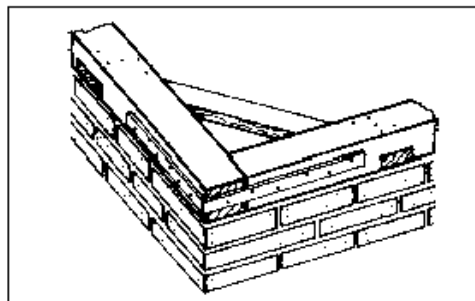

10-7

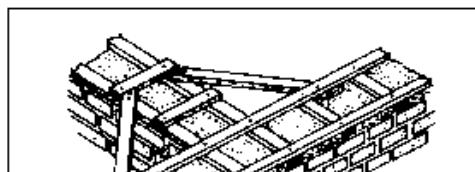



10-8

10.3 Ring beams which act as roof support

If the ring beams act as support for the roof structure, they have to be positioned centrally over the wall (Fig. 10-13). In the case of adobe walls the upper layer of adobe may break under seismic movement, therefore it is recommended that a top layer of burnt bricks be built for better stress distribution, see Fig. 10-14. In order to transfer the load uniformly from the roof beams to the wall, wedges of wood or concrete should be used. Also additional fixing is advisable, see Fig. 10-15.

10-6 to 10-12 Solutions of stiffening of corners

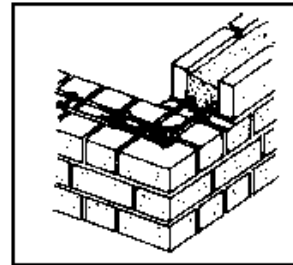

10-9

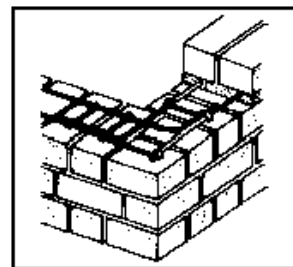

10-10

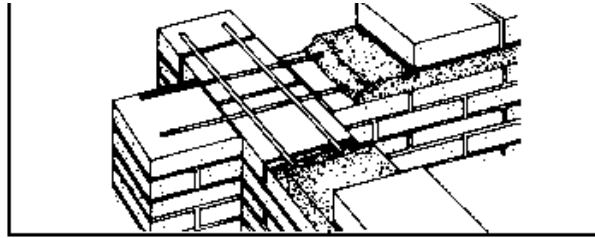

10-11

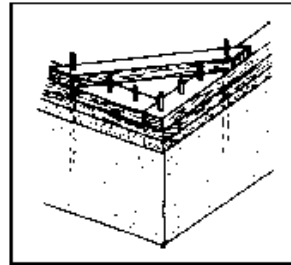

10-12

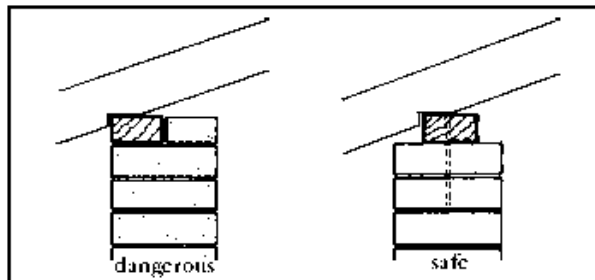

10-13

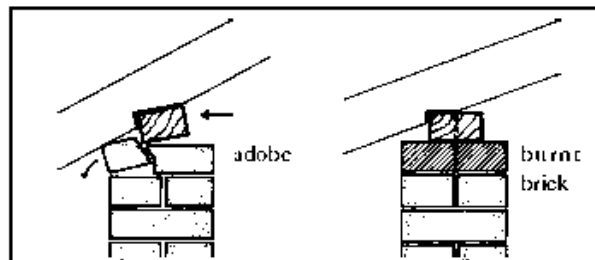

dangerous

safe

10-14

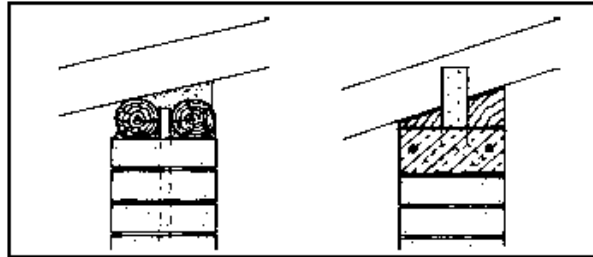

10-15

11. Gables

If gables are part of the wall, they are very weak against perpendicular forces. The best solution for avoiding this problem is to build a roof with four inclined planes (pyramidal shape), with which no gables appear. The second best solution is to build a light gable which is fixed only to the roof, as Fig. 11-1 shows. The third best solution is to build a gable wall and to stabilize it with a buttress, see Fig. 11-2. If a concrete skeleton structure is used, which is the most expensive solution, the gable also has to be stabilized by reinforced concrete elements, as shown in Fig. 11-3.

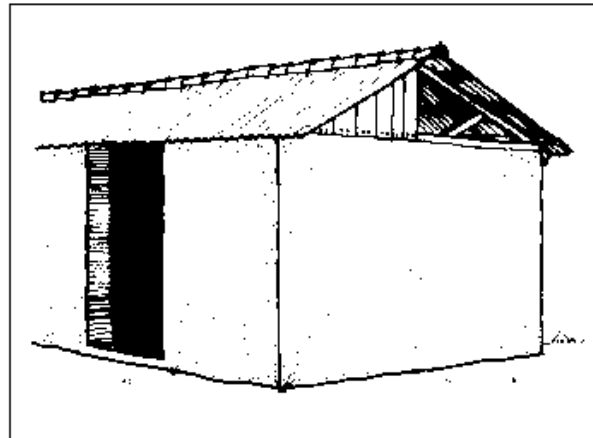

11-1 Gable fixed roof

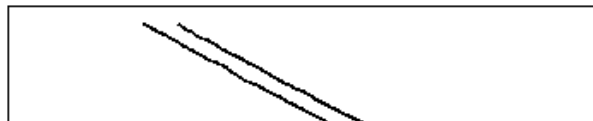

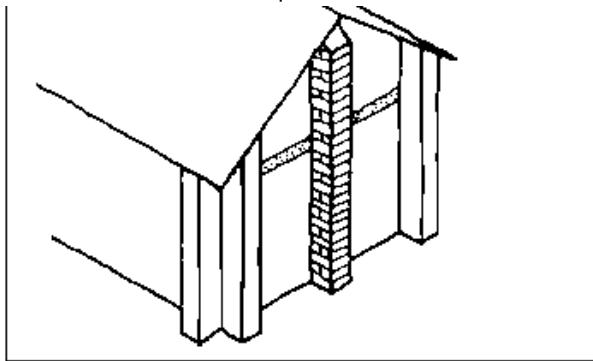

11-2 Stabilization by buttresses

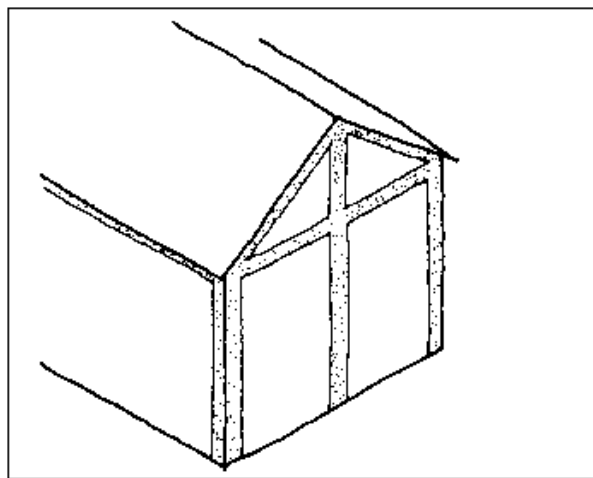

11-3 Stabilization by reinforced concrete structure

12. Roofs

12.1 General

The roof should be built as light as possible. Roofs with tiles or stone plates are not recommended, as they are heavy and in case of an earthquake the tiles or plates might fall into the house.

For earthquake-resistant houses a pyramidal roof with 4 inclined planes, which rest on a horizontal ring beam, is the best solution. A simple roof of this kind is shown in Figs. 12-8 and 12-9. The most used solution is a roof with one ridge and two inclined surfaces, but in this case the beams on which the roof rests, must form a ring and cross the gable, which needs extra stabilization, see chapter 11, or must be fixed to the roof instead being a part of the wall, see Fig. 11-1.

For smaller houses a roof with a single inclined plane is more economical, but in this case the beams on which the roof rests need to be interconnected, forming an inclined ring beam.

12.2 Separated roofs

As the frequency of the movements of roofs and walls differs during seismic activities, due to their different moment and weight, the safest solution is to separate the roof from the wall and have it resting on columns which are positioned inside or outside the wall. Then the roof and wall systems can move independently of each other. Figs. 12-1 to 12-4 show different proposals of the author, utilizing this idea. It is necessary to fix the columns to the ground at the bottom and to the roof structure at the top in such a way that these connections are partially moment-stiff, but still allow some ductility. At the top of wooden columns short diagonals give best solution, see Figs. 12-1 to 12-9.

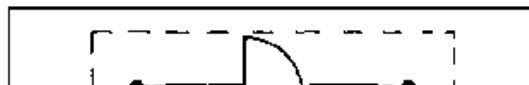

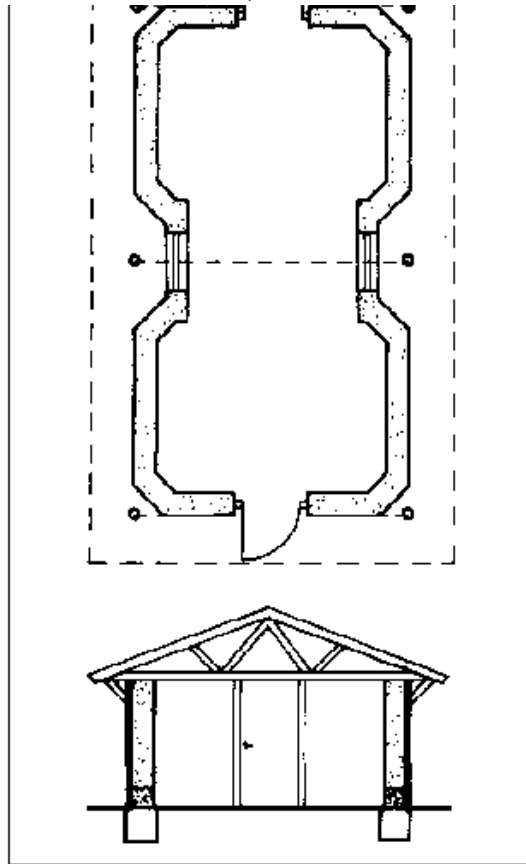

12-1

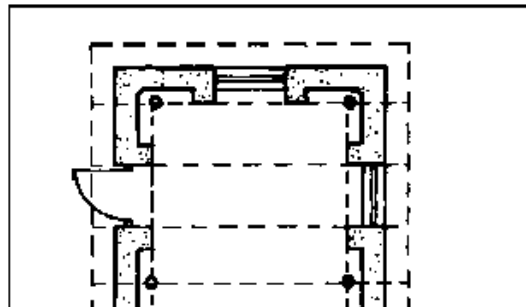

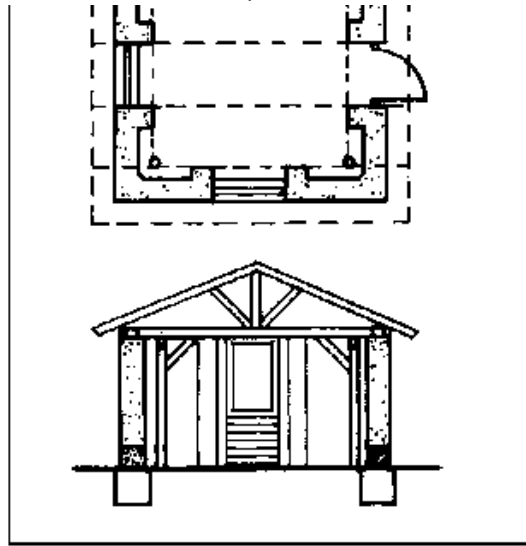

12-2

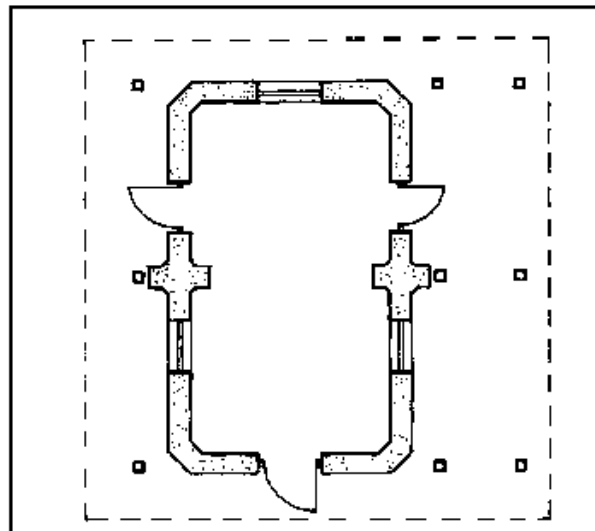

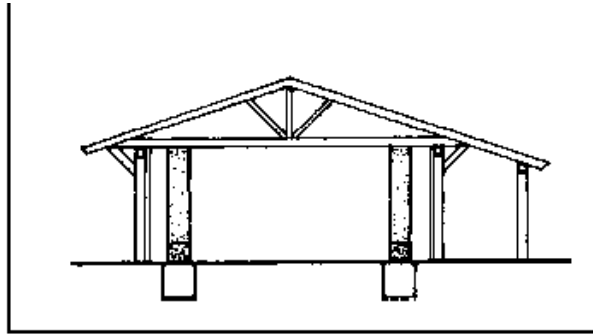

12-3

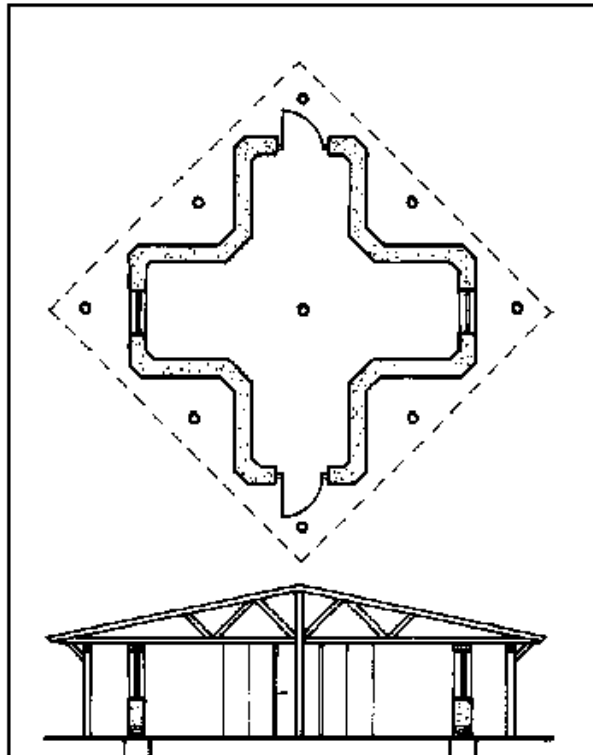



12-4

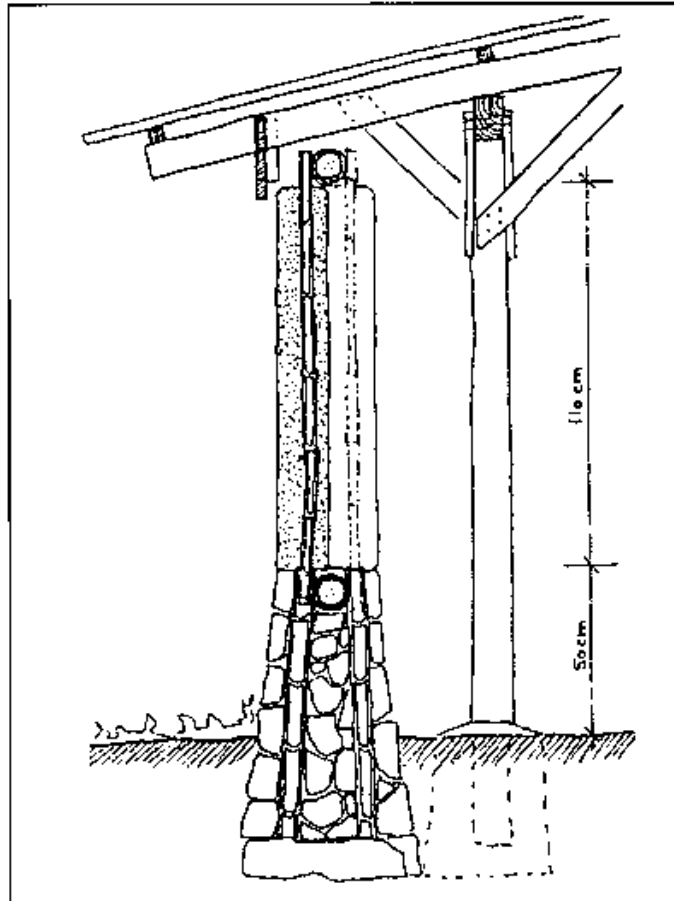

12-5 Reinforced rammed earth wall system Guatemala, 1978 (Minke 2001)

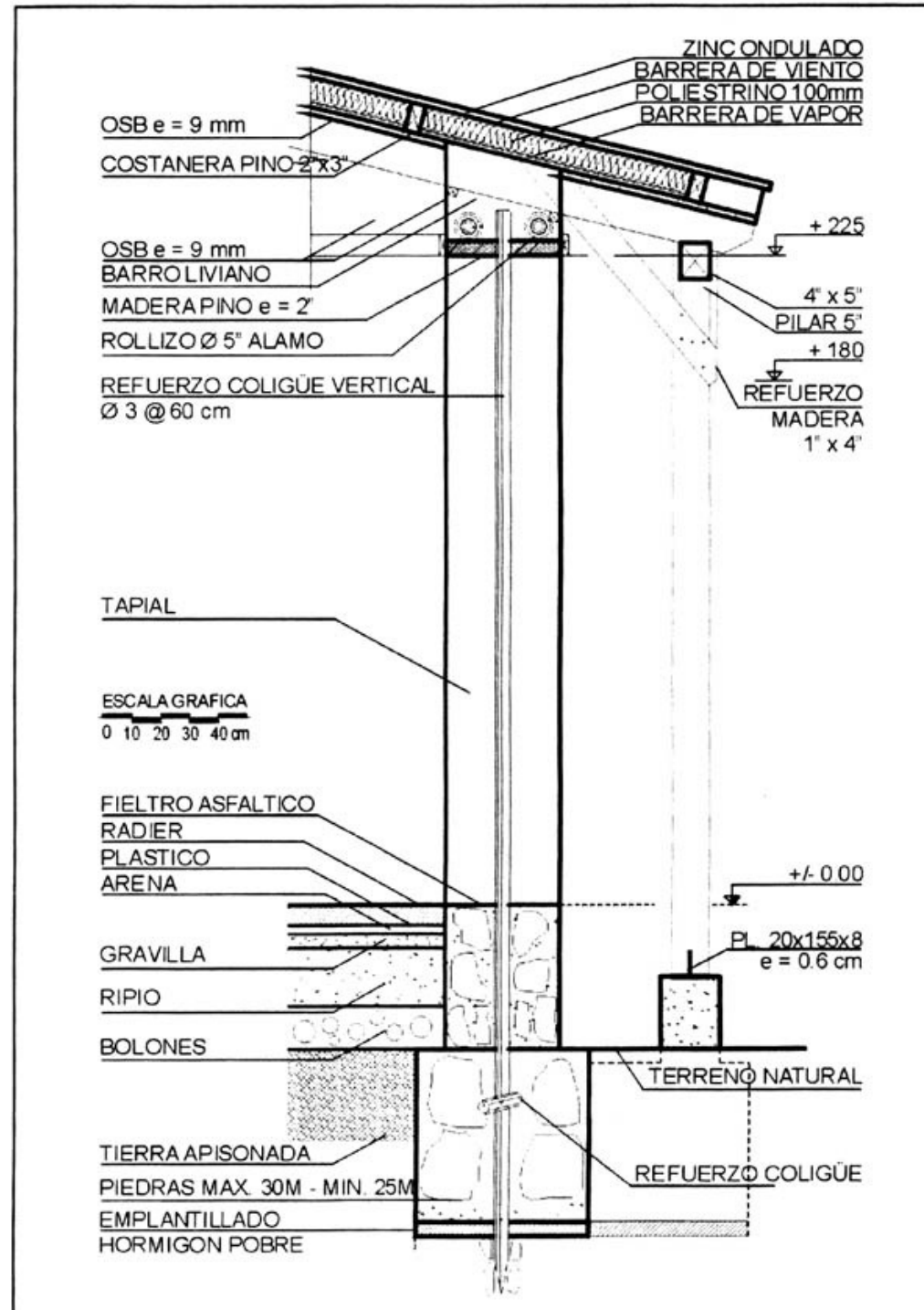

12-6 Reinforced rammed earth wall system Alhué, Chile 2001

12-7 to 12- 9 Proposals for plans with separated roof structure

12-7 to 12- 9 Earthquake resistant low-cost housing project Pujili, Ecuador 1989





Figs. 12-5 and 12-6 show solutions of projects which were described in chapter 6.4. In the first case the columns are positioned inside, in the second case outside the walls.

Figs. 12-7 to 12-9 show the construction of an earthquake-resistant low-cost housing project built in 1989 at Pujili, Ecuador (design: Gernot Minke and FUNHABIT, Quito). In this project the walls are built of two U-shaped rammed earth elements 40 cm thick, separated by a door or a window. The roof rests on four wooden columns, which stand outside the walls at the corners of the square. Though the columns reach into the foundation and are fixed to the ring beam by diagonals, the roof system shows sufficient ductility within an earthquake.

The roof was built of eucalyptus trunks, covered by caña brava (a kind of reed) and then plastered with a mixture of clayey soil with pumice, animal dung, sisal fibers and waste car oil. After drying it was painted with white paint.

13. Openings for doors and windows

Openings within the walls destabilize the wall system. In an earthquake diagonal cracks often occur, starting at the window edges, see Figs. 4-1 and 4-2. Lintels have to penetrate into the wall for at least 40 cm in order to achieve a good bond, see Fig. 13-1. However, in this case the part above the lintel may be weak and come off in an earthquake, and therefore the best solution is to also use the lintel as a ring beam on which the roof structure rests. It is also recommended that the part below the window be built as a light flexible structure, for instance from wooden panels or wattle and daub. The following rules have to be taken into account, see Figs. 13-5 and 13-6:

- a) The length of the windows should not be more than 1.20 m and not more than 1/3 of the length of the wall.**
- b) The length of walls between openings must be at least 1/3 of their height and not less than 1 m.**
- c) Doors must be opened towards the outside. Opposite the entrance door there should be a large window or another door, which acts as emergency exit, see Fig. 13-6.**

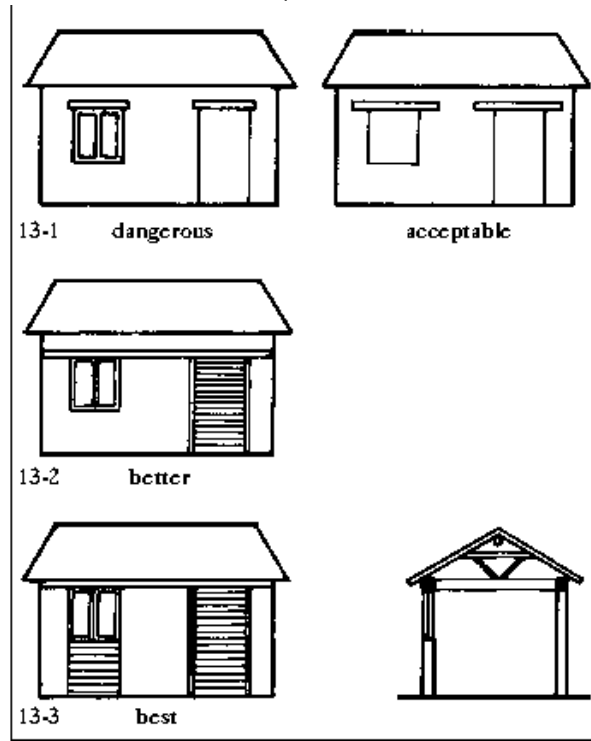

13-1 to 13-3

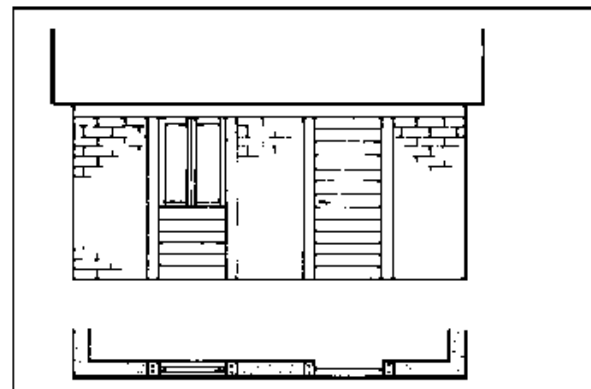

13-4 Stabilized openings

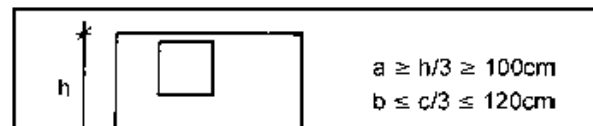

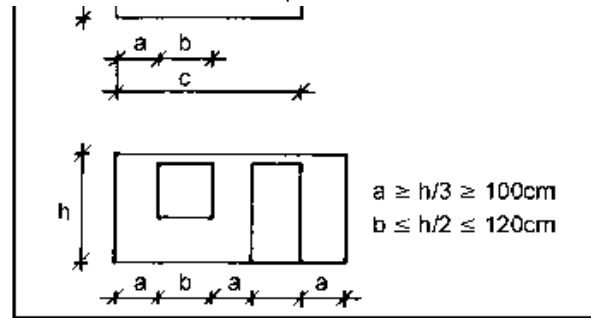

13-5 Recommendable dimensions of openings

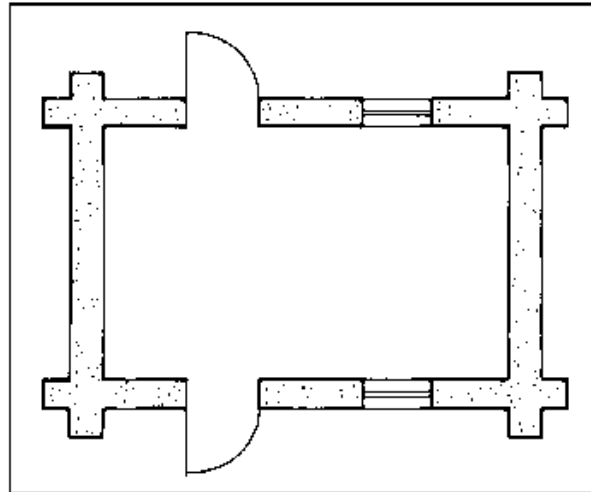

13-6 Recommendable positions of openings

14. Domes

The problem with the structural design of domes is the stress transfer to the foundation. The inclined thrust force can be divided into a horizontal and a vertical component, see Fig. 14-1. The steeper the thrust (resultant), the smaller the horizontal component.

The support of a dome must be a circular horizontal ring of reinforced cement concrete, steel or possibly also timber, and it must be able to take the horizontal forces of the dome. The joint between dome and plinth or foundation must be inclined in

order to resist the horizontal seismic movement, see Figs. 14-2 and 14-3. Because of the heavy weight of a dome, high ring beams and walls need to be stabilized by buttresses and the joint of ring beam and wall must be able to transfer large horizontal forces, see Fig. 14-3.

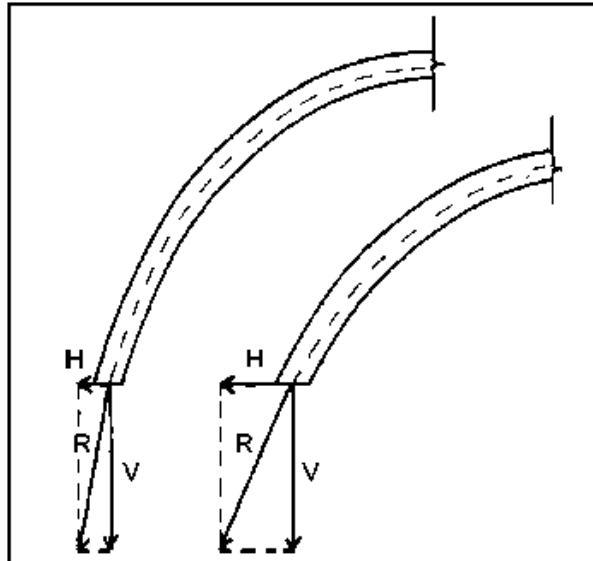

14-1 Resultant forces and their components (Minke 2000)

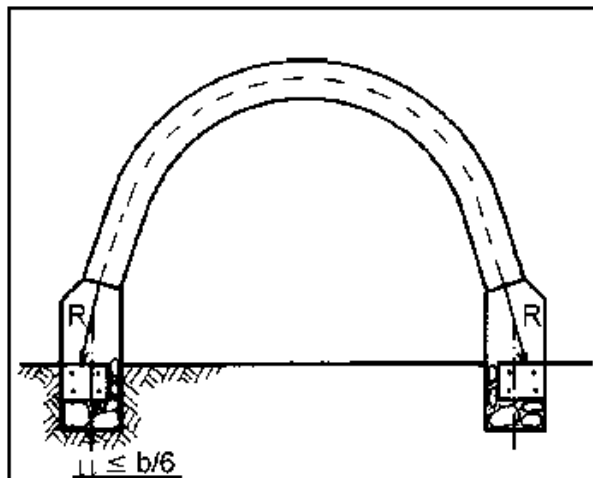

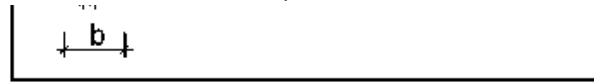
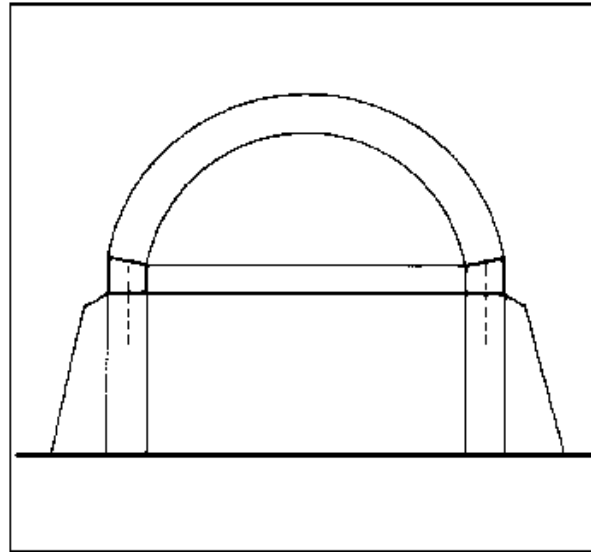
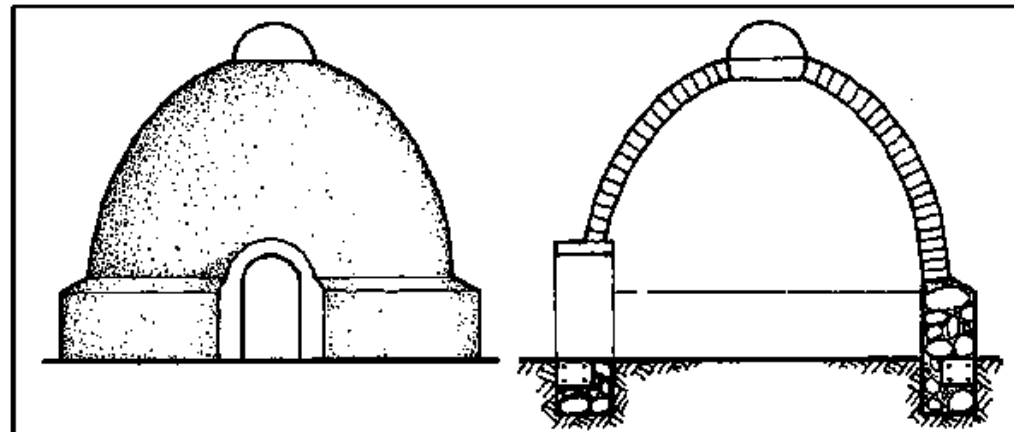
**14-2 Allowable eccentricity****14-3 Ring beam stabilized by buttresses****14-4 Stabilization of dome entrance**

If the dome rests directly on a low plinth, the structure is much more stable in an earthquake, see Fig. 14-2. In this case the foundation has to act as horizontal ring beam, and is usually built of reinforced cement concrete. It is important to check that the resultant force of the dome stays within the center third of the width of the plinth measured above the ring beam, i.e. the

eccentricity must not be more than 1/6 of the base.

If the dome starts above a plinth, it must be taken into account that openings like doors and windows destabilize the dome structure. Therefore the tops of door and windows must be designed as vaults which penetrate the dome and are able to transfer the stresses from the dome to their sides, see Fig. 14-4.

An earthquake-resistant dome must have a certain section, which guarantees that all forces are transferred vertically to the foundation without creating tensile or compressive ring forces. The resultant forces must always be within the center of the dome wall, the eccentricity must be less than 1/6.

14-7 Dome coordinates for 7 different proportions (Minke 2000)

| Nr | y | X | y | X | y | X | y | X | y | X | y | X | y | X |
|----|--------|--------|--------|--------|--------|--------|--------|--------|--------|--------|--------|--------|--------|--------|
| 1 | 0,0000 | 1,0000 | 0,0000 | 1,0000 | 0,0000 | 1,0000 | 0,0000 | 1,0000 | 0,0000 | 1,0000 | 0,0000 | 1,0000 | 0,0000 | 1,0000 |
| 2 | 0,0452 | 0,9854 | 0,0454 | 0,9875 | 0,0479 | 0,9885 | 0,0470 | 0,9902 | 0,0422 | 0,9912 | 0,0494 | 0,9918 | 0,0469 | 0,9929 |
| 3 | 0,0973 | 0,9674 | 0,0982 | 0,9720 | 0,1013 | 0,9750 | 0,1007 | 0,9783 | 0,1016 | 0,9807 | 0,1036 | 0,9823 | 0,1013 | 0,9844 |
| 4 | 0,1489 | 0,9483 | 0,1508 | 0,9556 | 0,1544 | 0,9608 | 0,1543 | 0,9658 | 0,1555 | 0,9696 | 0,1578 | 0,9724 | 0,1556 | 0,9755 |
| 5 | 0,2001 | 0,9279 | 0,2030 | 0,9381 | 0,2073 | 0,9456 | 0,2077 | 0,9526 | 0,2093 | 0,9579 | 0,2118 | 0,9620 | 0,2098 | 0,9662 |
| 6 | 0,2506 | 0,9061 | 0,2548 | 0,9195 | 0,2600 | 0,9295 | 0,2610 | 0,9386 | 0,2629 | 0,9456 | 0,2657 | 0,9511 | 0,2640 | 0,9565 |
| 7 | 0,3005 | 0,8827 | 0,3061 | 0,8996 | 0,3123 | 0,9124 | 0,3139 | 0,9237 | 0,3164 | 0,9326 | 0,3195 | 0,9396 | 0,3180 | 0,9462 |
| 8 | 0,3495 | 0,8575 | 0,3569 | 0,8782 | 0,3642 | 0,8940 | 0,3667 | 0,9079 | 0,3697 | 0,9188 | 0,3732 | 0,9274 | 0,3720 | 0,9354 |
| 9 | 0,3974 | 0,8303 | 0,4069 | 0,8552 | 0,4156 | 0,8744 | 0,4191 | 0,8911 | 0,4227 | 0,9041 | 0,4267 | 0,9145 | 0,4258 | 0,9241 |
| 10 | 0,4441 | 0,8011 | 0,4562 | 0,8305 | 0,4665 | 0,8533 | 0,4711 | 0,8730 | 0,4755 | 0,8885 | 0,4800 | 0,9008 | 0,4795 | 0,9121 |
| 11 | 0,4893 | 0,7695 | 0,5043 | 0,8038 | 0,5167 | 0,8306 | 0,5226 | 0,8536 | 0,5280 | 0,8718 | 0,5331 | 0,8863 | 0,5331 | 0,8993 |
| 12 | 0,5327 | 0,7355 | 0,5513 | 0,7749 | 0,5660 | 0,8060 | 0,5736 | 0,8328 | 0,5800 | 0,8540 | 0,5859 | 0,8708 | 0,5864 | 0,8858 |
| 13 | 0,5738 | 0,6987 | 0,5967 | 0,7436 | 0,6143 | 0,7795 | 0,6239 | 0,8103 | 0,6316 | 0,8347 | 0,6384 | 0,8542 | 0,6396 | 0,8714 |

| | | | | | | | | | | | | | | |
|----|--------|--------|--------|--------|--------|--------|--------|--------|--------|--------|--------|--------|--------|--------|
| 14 | 0,6124 | 0,6592 | 0,6402 | 0,7097 | 0,6613 | 0,7507 | 0,6733 | 0,7860 | 0,6827 | 0,8140 | 0,6905 | 0,8364 | 0,6924 | 0,8561 |
| 15 | 0,6479 | 0,6170 | 0,6815 | 0,6731 | 0,7067 | 0,7194 | 0,7217 | 0,7596 | 0,7330 | 0,7917 | 0,7422 | 0,8173 | 0,7450 | 0,8397 |
| 16 | 0,6799 | 0,5721 | 0,7200 | 0,6337 | 0,7502 | 0,6855 | 0,7688 | 0,7309 | 0,7825 | 0,7674 | 0,7932 | 0,7966 | 0,7971 | 0,8220 |
| 17 | 0,7081 | 0,5246 | 0,7554 | 0,5913 | 0,7913 | 0,6487 | 0,8143 | 0,6998 | 0,8309 | 0,7411 | 0,8436 | 0,7743 | 0,8488 | 0,8030 |
| 18 | 0,7322 | 0,4750 | 0,7872 | 0,5462 | 0,8296 | 0,6090 | 0,8578 | 0,6658 | 0,8780 | 0,7124 | 0,8930 | 0,7500 | 0,8999 | 0,7825 |
| 19 | 0,7522 | 0,4235 | 0,8149 | 0,4984 | 0,8646 | 0,5663 | 0,8988 | 0,6290 | 0,9234 | 0,6811 | 0,9414 | 0,7235 | 0,9503 | 0,7602 |
| 20 | 0,7680 | 0,3707 | 0,8384 | 0,4485 | 0,8957 | 0,5207 | 0,9369 | 0,5891 | 0,9667 | 0,6470 | 0,9883 | 0,6947 | 0,9998 | 0,7360 |
| 21 | 0,7801 | 0,3168 | 0,8576 | 0,3967 | 0,9227 | 0,4725 | 0,9716 | 0,5461 | 1,0076 | 0,6099 | 1,0336 | 0,6632 | 1,0482 | 0,7096 |
| 22 | 0,7887 | 0,2624 | 0,8725 | 0,3436 | 0,9452 | 0,4221 | 1,0023 | 0,5002 | 1,0453 | 0,5696 | 1,0767 | 0,6287 | 1,0951 | 0,6807 |
| 23 | 0,7944 | 0,2076 | 0,8836 | 0,2896 | 0,9633 | 0,3700 | 1,0286 | 0,4517 | 1,0795 | 0,5262 | 1,1172 | 0,5912 | 1,1403 | 0,6491 |
| 24 | 0,7978 | 0,1526 | 0,8912 | 0,2350 | 0,9771 | 0,3165 | 1,0504 | 0,4009 | 1,1095 | 0,4799 | 1,1544 | 0,5505 | 1,1830 | 0,6145 |
| 25 | 0,7994 | 0,0975 | 0,8961 | 0,1801 | 0,9870 | 0,2623 | 1,0675 | 0,3485 | 1,1350 | 0,4309 | 1,1879 | 0,5065 | 1,2236 | 0,5768 |
| 26 | 0,8000 | 0,0425 | 0,8987 | 0,1251 | 0,9936 | 0,2075 | 1,0804 | 0,2948 | 1,1557 | 0,3798 | 1,2170 | 0,4596 | 1,2606 | 0,5358 |
| 27 | 0,8000 | 0,0000 | 0,8998 | 0,0700 | 0,9974 | 0,1526 | 1,0894 | 0,2404 | 1,1719 | 0,3270 | 1,2415 | 0,4101 | 1,2933 | 0,4915 |
| 28 | | | 0,9000 | 0,0000 | 0,9993 | 0,0975 | 1,0951 | 0,1856 | 1,1836 | 0,2731 | 1,2611 | 0,3585 | 1,3222 | 0,4443 |
| 29 | | | | | 0,9999 | 0,0425 | 1,0983 | 0,1306 | 1,1916 | 0,2185 | 1,2761 | 0,3054 | 1,3459 | 0,3944 |
| 30 | | | | | 1,0000 | 0,0000 | 1,0997 | 0,0755 | 1,1965 | 0,1636 | 1,2867 | 0,2513 | 1,3648 | 0,3425 |
| 31 | | | | | | | 1,1000 | 0,0205 | 1,1990 | 0,1086 | 1,2936 | 0,1966 | 1,3789 | 0,2892 |
| 32 | | | | | | | 1,1000 | 0,0000 | 1,1999 | 0,0535 | 1,2976 | 0,1416 | 1,3887 | 0,2349 |
| 33 | | | | | | | | | 1,2000 | 0,0000 | 1,2995 | 0,0865 | 1,3949 | 0,1801 |
| 34 | | | | | | | | | | | 1,3000 | 0,0315 | 1,3983 | 0,1251 |
| 35 | | | | | | | | | | | 1,3000 | 0,0000 | 1,3997 | 0,0700 |

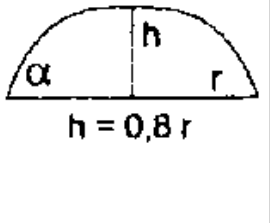
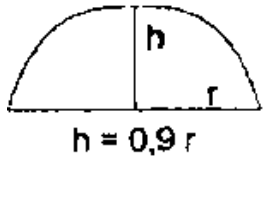
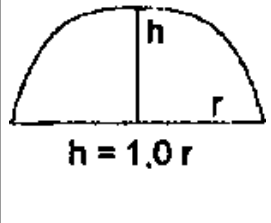
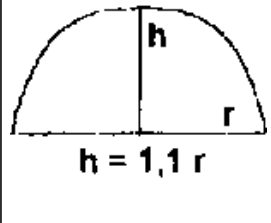
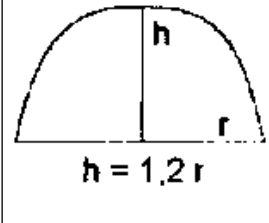
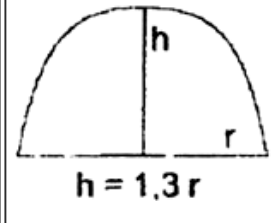
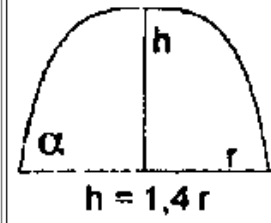
| | | | | | | | | | | | | | | |
|----------|---|-------|---|-------|--|-------|---|-------|---|-------|---|-------|---|--------|
| 36 | | | | | | | | | | | | | 1,4000 | 0,0150 |
| 37 | | | | | | | | | | | | | 1,4000 | 0,0000 |
| |  | |  | |  | |  | |  | |  | |  | |
| α | 72,6 | Grad | 75,0 | Grad | 76,9 | Grad | 78,5 | Grad | 79,7 | Grad | 80,7 | Grad | 81,6 | Grad |
| A | 5,3374 | r^2 | 5,7789 | r^2 | 6,2195 | r^2 | 6,6941 | r^2 | 7,1685 | r^2 | 7,6426 | r^2 | 8,1514 | r^2 |
| V | 16,1064 | r^3 | 18,2911 | r^3 | 20,4262 | r^3 | 22,6921 | r^3 | 24,9307 | r^3 | 27,1455 | r^3 | 29,5145 | r^3 |

In a dome with a semicircular section the resultants of the forces act inside the center line, thus creating tensile ring forces which can easily lead to collapse, see Fig. 14-5. In Fig. 14-6 the ideal section line, which does not create ring forces, is shown in contrast to other usual curves. This curve was derived by a computer program. However, it can be found for 7 different proportions of height to radius, when using the coordinates listed in Fig. 14-7, where r is the radius and h the height of the dome - always measured to the center of the wall, α is the angle of inclination at the bottom, A the area and V the volume.

In order to construct such a structurally optimized dome without formwork, at the FEB a rotational guide was developed which is fixed to a vertical mast. At the end of the rotating arm an angle is fixed against which the mason lays the adobe or soil block. So each block can be placed in position exactly. Figs. 14-8 to 14-11 show the application of this construction technique for a dome of 8.80 m free span and 5.50 m height, built in La Paz, Bolivia, in 2000. The adobes for this dome were made by hand in a special mould with rounded edges, in order to provide good sound distribution within the dome. The acoustic behavior of the dome was further refined by deepening the vertical joints in order to achieve some sound absorption and by a slight cantilevering position, which avoids the sound focusing effect towards the center of the dome.

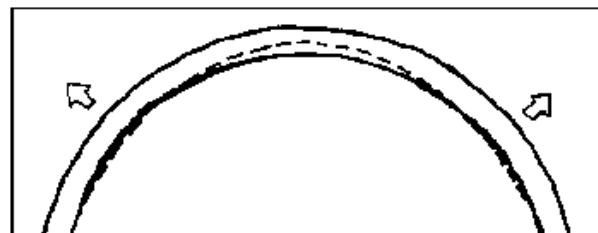



14-5 A semicircle is dangerous for dome section (Minke 2001)

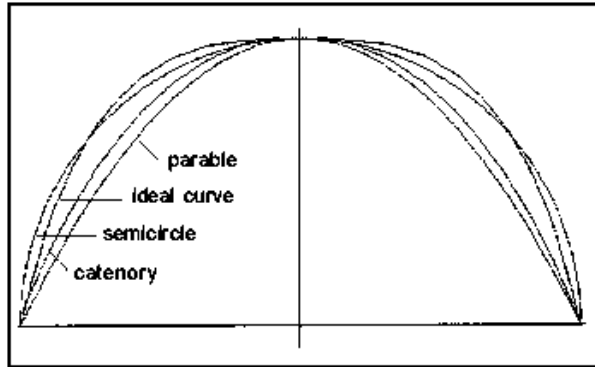

14-6 Ideal section curve in relation to other well known curves (Minke 2001)





14-8



14-9



14-10





14-11 to 14-11 Building of an adobe dome La Paz, Bolivia 2000

15. Vaults

In an earthquake vaults are less stable than domes, as described in chapter 14. It is advisable to have a square plan. If a rectangular plan is desired, buttresses or tensile elements connecting the beams are required, see Fig. 15-1. To create more stability, a vault should start directly above a low plinth instead of above a wall, see Fig. 15-2.

The vertical section of a vault should have the shape of an inverted catenary if it only has to transfer its own load. Then it only transfers forces in compression, see Fig. 15-3.

An important rule for the design of plinth and foundation is that the resultant force at the bottom of the vault should go through the inner third of the surface of the foundation. This means that the eccentricity should be less than $1/6$, see Fig. 15-2. The foundation must have a reinforced concrete beam, which can also withstand the additional horizontal forces created by an earthquake.

Fig. 15-4 shows a section of a building which was built in an earthquake-prone area in Bolivia. Its plinth has structurally dangerous proportions, as the resultant force from the vault creates a bending moment in the plinth and does not stay within

dangerous proportions, as the resultant force from the vault creates a bending moment in the piers and does not stay within the inner third of the wall, as necessary.

The facades of vaults should be stabilized like the gables described in chapter 11. However, the best solution is to build them light and flexible with "wattle and daub", mats covered with earth plaster, or with timber planks.

Fig. 15-5 shows a design of the author for an earthquake-resistant low-cost-housing project in the region of Gujarat, India.

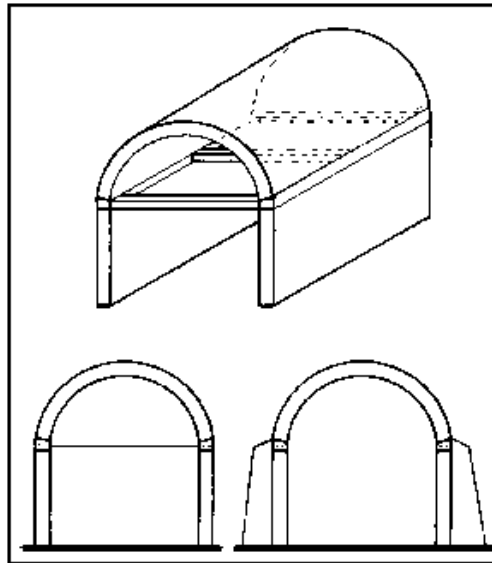

15-1 Ring beams stabilized by tensors or buttresses

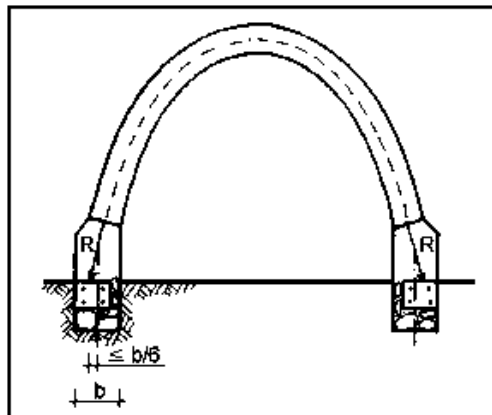

15-2 Permitted eccentricity

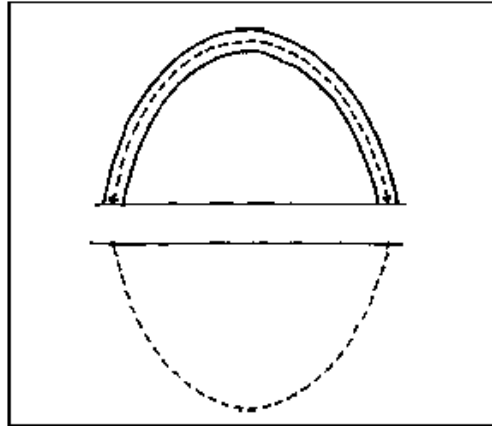

15-3 Inverted catenary as ideal section for vaults (Minke 2000)

A proposal for stabilizing adobe vaults by bamboo arches also guaranteeing a certain ductility was realized within a test structure built in 2001 at the University of Kassel, see Figs. 15-6 to 15-9. This was built with special U-shaped adobes which rest on an arch, built of three layers of split bamboo. The bamboo sections were kept in water for 3 days in order to be able to bend them. Then they were bent over sticks, which were pushed into the ground in a catenary line, see Fig. 15-7. In order

to keep the arch in form, the three bamboo sections were wrapped together with galvanized steel wire every 50 cm. The arch was put into a vertical position and fixed to steel bars which stick out of the plinth. This connection must be able to take tensile forces within an earthquake. Above the adobe vault a membrane of PVC-coated polyester fabric is fixed and tightened to the plinth. This has two functions: firstly it gives shelter against rain and wind, and secondly it pretensions the arch and therefore increases its stability against movements created by the earthquake.

These movements may deform the vault to a certain extent, so that the adobe joints may open, but the vault will not collapse as it is held by the tensile prestressed membrane at the top and the compressive prestressed bamboo arch underneath. Thus the stability of this structure depends mainly on its ductility. However, it must be taken into account that if the pretension of the membrane is high, the optimal section of the vault is more like an ellipse.

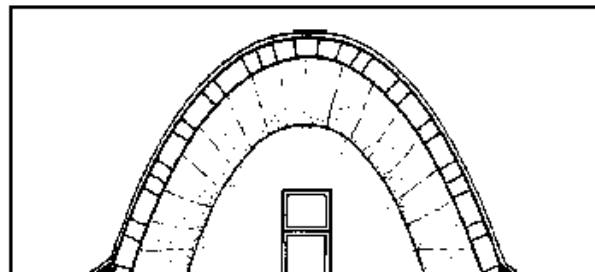

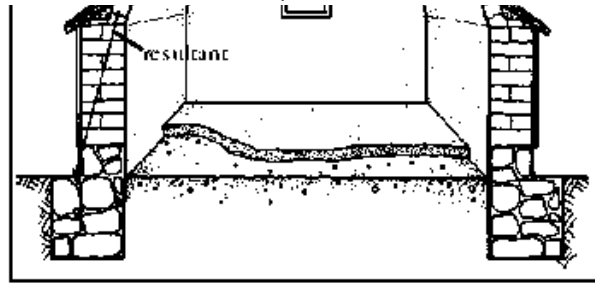

15-4 Badly designed plinth with eccentric thrust line

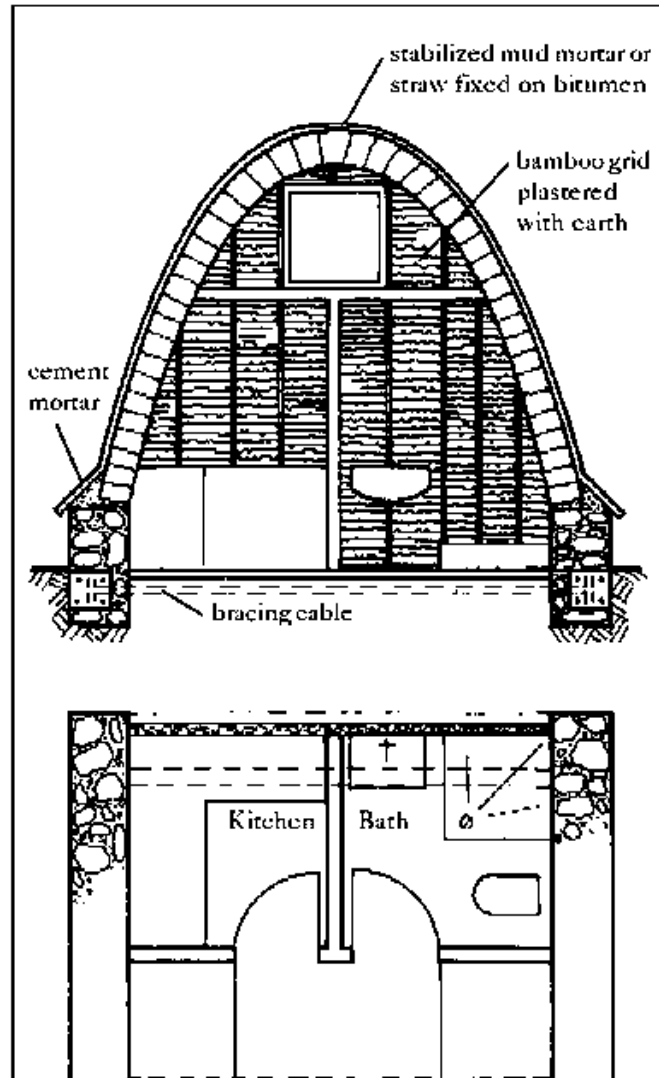

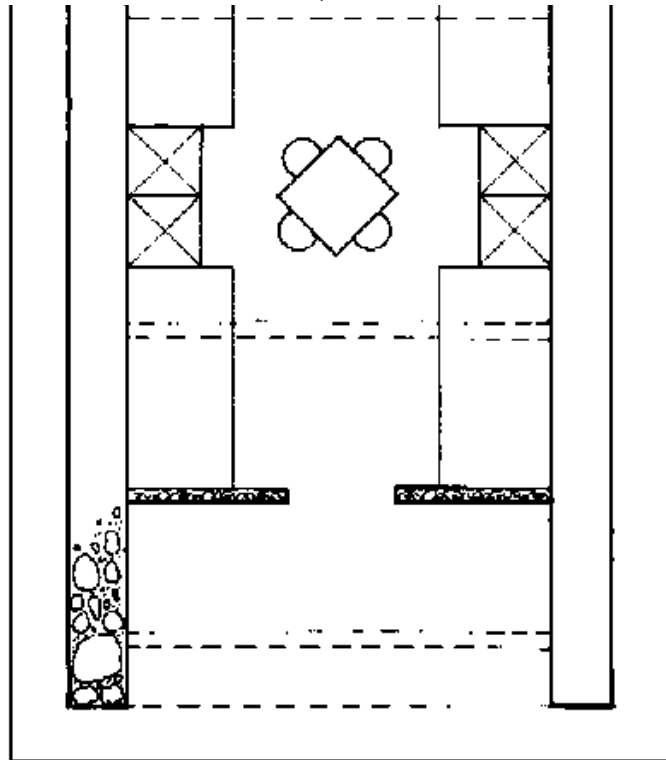

15-5 Proposal for an earthquake resistant vault structure for India



15-6 Production of special adobes



15-7 Construction of the arc with split bamboo

15-8 and 15-9 Earthquake resistant vault reinforced with bamboo FEB, Kassel, 2001







16. Plasters and paints

Adobe walls have to be plastered by mortars made of earth or lime, or by earth stabilized with cement, lime or bitumen. A pure cement plaster should never be used, as it is too brittle and tends to crack under thermal loads (through expansion and retraction) and under mechanical impacts. If water penetrates through these cracks, the earth underneath will expand creating more cracks, or even burst off.

The church at Ranchos de Taos, New Mexico, see Fig. 16-1, which was built in 1815 with adobe walls, was plastered with cement plaster during a restoration in 1967. Eleven years later the plaster had to be taken off, as rain water had penetrated through the many cracks and caused the destruction of many parts of the surface.

If an earth mortar is used for plastering, it is recommended that the surface be made waterproof by applying a paint of lime or lime-casein. Rammed earth walls do not need plastering. It is better to smoothe the surface with a trowel while it is still humid and then add two or three layers of thin lime or lime-casein paint. The first layer must have a high water content, so that it penetrates 2 or 3 mm deep into the wall.



16-1 Church San Francisco de Asís, Ranchos de Taos, EEUU

Bibliographic references

Equipo Maiz (ed.): La casa de adobe sismorresistente, El Salvador 2001

Grohmann, M.: Introducción al diseño sismorresistente, in: Laboratorio de Construcción Experimental, Universidad de Kassel (ed.): Viviendas sismoresistentes (Report, not published), Kassel, German, 1998

Houben, H.; Guillaud, H.: Earth Construction Primer, Brussels, Belgium 1984

ININVI (Instituto Nacional de Investigación y Normalización de la vivienda de Perú): Construcciones en adobe, Lima, Perú

Minke, G.: Earth Construction Handbook, WIT Press, Southampton, UK 2000

Pereira, G.H.: Habiterra (Catalogue of exposition), Bogota, Colombia, 1995

Sibtain, S.N.: To build a village, Parramata, N.S.W. Australia, 1982

Tolles, E.L.; Kimbro, E.E. et al.: Seismic stabilization of historic adobe structures, Getty Conservation Institute, Los Angeles, USA, 2000

Vorhauer, K.: Low Cost / Self Help Housing (Gate Modul 6/6, Eschborn, Germany, 1979)

Weinhuber, K.: Building with Interlocking Blocks, in: basin at gate/gtz (ed.) Wall Building, Technical Brief, Eschborn, Germany, 1995

Yazdani, H.: Erhöhung der Lebensdauer von Lehmbauten in erdbebengefährdeten Gebieten Afghanistans (Doctoral thesis, not published), University of Kassel, Germany, 1985

The figures without sources quoted are from the author.

About the author





Gernot Minke is architect and professor at Kassel University, Germany, where he heads the Forschungslabor für Experimentelles Bauen (FEB) (Building Research Laboratory). Since 1974 more than 30 research and development projects have been realized in the field of ecological building, low-cost-housing and especially building with earth.

In his private architectural office he has designed many private and public buildings, all of them having earth as a predominant building material. His buildings stand not only in Europe, but also in Central and South America and India. He is the author of several books, more than 200 articles, has been invited to more than 30 international conferences and was visiting professor in Mexico, Guatemala, Paraguay and Venezuela.

Back cover



Deutsche Gesellschaft für Technische Zusammenarbeit (GTZ) GmbH

**Dag-Hammarskjöld-Weg 1-5
Postfach 51 80
65726 Eschborn**

**Telefon (0 61 96) 79-0
Telex 4 07 501-0 gtz d
Telefax (0 61 96) 79-11 15
Internet: <http://www.gtz.de>**

[Please provide your feedback](#)

[English](#) | [French](#) | [Spanish](#) | [German](#)