





## **Appropriate Building Materials: a Catalogue of Potential Solutions (SKAT, 1988, 430 p.)**

### **Fundamental information on building elements**

-  **Foundations**
-  **Floors and ceilings**
-  **Walls**
-  **Roofs**
-  **Building systems**

## **Appropriate Building Materials: a Catalogue of Potential Solutions (SKAT, 1988, 430 p.)**

### **Fundamental information on building elements**

#### **Foundations**

##### **General**

**The stability of a building depends primarily on the foundation it is built on. The construction of the foundation is in turn dependent on the type of building and, above all, on the loadbearing capacity of the ground. Soft soils, or those that become soft when wet, require more sophisticated and expensive foundations than hard soils. Natural hazards, such as earthquakes, hurricanes, floods, etc., also have an influence on foundation construction.**

**On account of the numerous requirements and constraints, there is a large variety of foundations. With regards to low-cost constructions, five main types are briefly dealt with**

**here.**

## **Types of Foundations**

### **Linear or strip foundation**

**This is the most common type of foundation, consisting of a continuous strip, which supports a load-bearing wall along its full length. It is also used to bridge or cantilever over soft portions of the ground, in which case, it must be reinforced.**

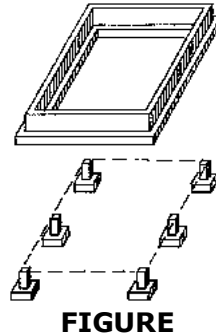

**FIGURE**

### **Spot or pad foundation**

**This is the common foundation for columns or poles (skeleton constructions), and mainly comprises a square (sometimes rectangular) footing, which is thicker than the width or diameter of the column or pole, the length and breadth each being at least three times the thickness.**

### **Slab or raft foundation**

**This type of foundation is often used for small buildings or structures with uniformly distributed loads (eg water tanks). Slabs on homogeneous ground can do without reinforcement, but over large areas, reinforcement is advisable, as non-uniform ground conditions lead to differential stresses.**

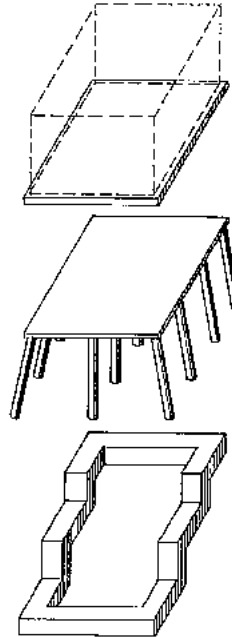

**FIGURE**

### **Pile foundation**

**Building on poor soils or under water calls for this type of foundation. Holes are dug down**

**through the weak soil up to the loadbearing layer, and filled with stable foundation material (either placed in situ or precast). The piles carry a reinforced concrete slab or are connected at the top by beams, which act like strip foundations. Lateral stability is achieved by placing some of the piles at a slant.**

### **Stepped foundation**

**Building on sloping ground makes a stepped foundation necessary. It is a special form of strip foundation, designed to save material, and to provide horizontal surfaces at intervals along the slope.**

**Most other types of foundation are variations of the ones presented above, or are of special types, which are less relevant in low-cost constructions.**

### **Design Considerations**

#### **Basic parts of a foundation**

**A linear or strip foundation is built up as follows:**

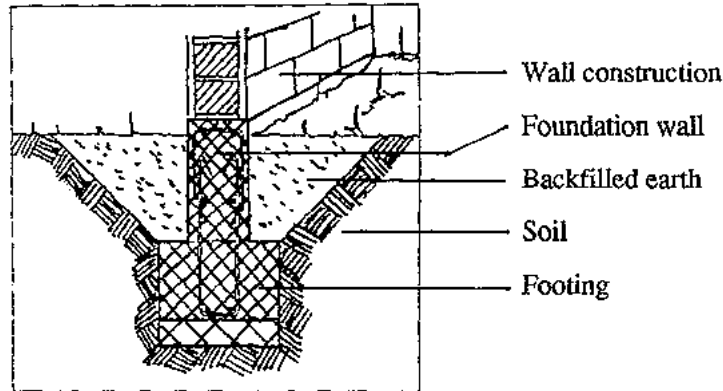

**FIGURE**

- **The footing serves three main purposes: 1. to provide a solid, level base for the foundation walls; 2. to transmit the weight of the house evenly to the soil; 3. to resist the lifting forces of hurricanes.**
- **The foundation wall also serves three main purposes: 1. to provide a level base for the wall; 2. to provide the necessary bending and torsion strength for the construction of the house; 3. to prevent underground moisture from moving up into the walls.**

### **Dimensions**

- **The footing must be deep enough to reach good solid earth free from plants, roots, filled-up materials, etc. Average depths are generally 50 to 100 cm, but should be considerably deeper, if washing out or shifting due to rain or flooding is expected.**
- **The "easy method" of determining the depth of footing is by asking neighbours, whose houses have shown good stability (without cracks or other damage). In case of doubt,**

**deeper footings are advisable.**

- **Sizes of footing depend on the strength of the soil and weight of the house. The height should preferably exceed the wall or column thickness and the base should be wide enough to permit a 60° angle of load distribution. Average footing widths lie between 30 and 60 cm.**
- **Foundation walls should preferably be thicker than the walls they support, and high enough above ground to protect the wall from rain splash. Heights of 20 to 50 cm above the ground are common, but depend on rainfall intensity and roof overhang.**

### **Excavation**

- **Foundation trenches should be carefully dug to provide a hard, level bottom surface and side walls at right angles to it. Rounded edges must be avoided.**

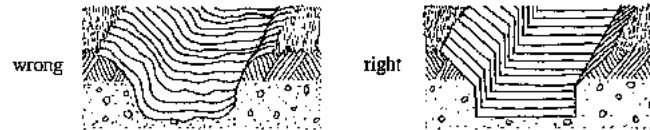

**FIGURE**

- **The excavated soil should be retained for backfilling, when the foundation wall is ready. The backfilling should have the same characteristics (soil type, moisture, density) as the surrounding, undisturbed soil.**

### **Materials**

- **Foundations can be made of several materials with differing qualities. A good reinforced concrete foundation is the strongest and best foundation for any type of residential**

**building. Where cement is too expensive or scarce, other materials can provide satisfactory results.**

<b><i>Material</i></b>	<b><i>Quality of foundation</i></b>
Reinforced concrete	Very good. Earthquake-resistant construction
Cement blocks	Poor to good
Stones and mortar	Medium to good
Burnt bricks	Medium
Stabilized mud bricks	Poor to good
Stabilized rammed earth	For arid or semi-arid regions only

### **Protection of foundations**

- **Penetration of rainwater and ground moisture is largely prevented by good waterproof concrete, natural stone, waterproof burnt bricks, but also with a waterproof coating or membrane, and protective roof overhang. Drainage tubes laid in a gravel bed alongside the footing are also effective.**
- **For protection against termites. see section on Biological Agents.**

**The foundation can be attacked by:**

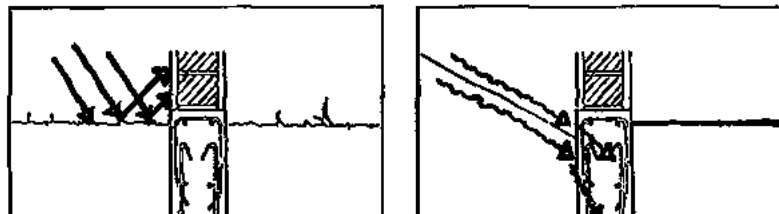

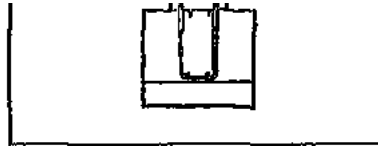

1. Rain and wind

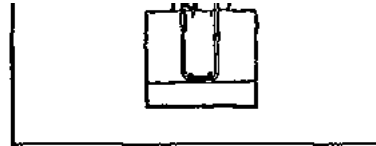

2. Hillside surface water

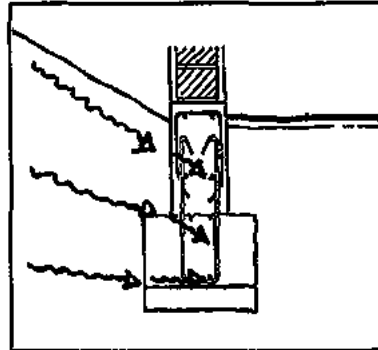

3. Hillside underground water

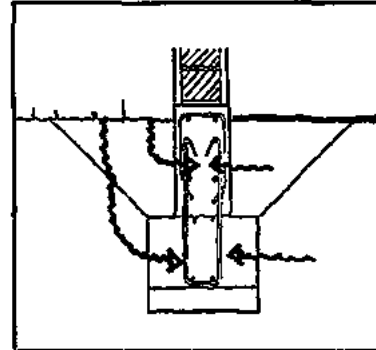

4. Seepage water

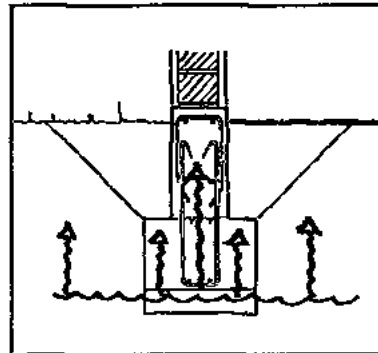

5. Ground water

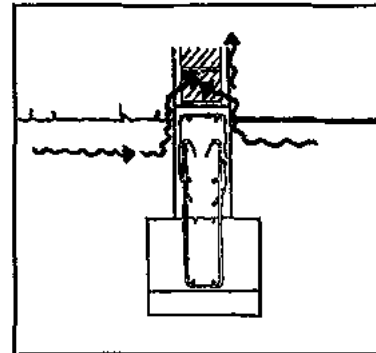

6. Termites



**FIGURE**

- 1. Rain and wind**
- 2. Hillside surface water**
- 3. Hillside underground water**
- 4. Seepage water**
- 5. Ground water**
- 6. Termites**

**Miscellaneous Aspects**

- **Soft clayey soils, which are unsuitable to build on, can be consolidated by providing vertical drains which draw out the water. These can be rigid sand drains or flexible drains. Cheap and effective flexible drains using coir and jute fabric have been developed at the University of Singapore and the Central Building Research Institute in India.**
- **The water from fresh concrete or from the mortar in masonry foundations is quickly absorbed by the soil, if it is very dry. Therefore, foundation trenches should be properly watered before placing the foundation material, so that absorption is reduced.**
- **In highland regions, in which temperatures can also fall below 0° C, the water in the soil can freeze and expand, damaging the foundation and consequently the whole building. This problem, called frost heave, occurs mainly in silty soils. The problem is avoided by placing the footing below the frost line, which can lie between 50 and 100 cm, or much lower in colder climates.**

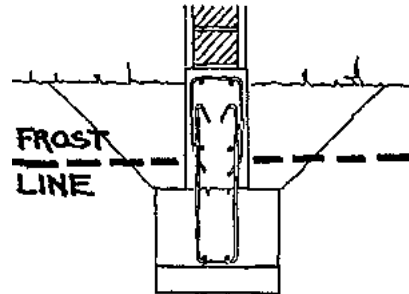

FIGURE

## Floors and ceilings

### General

**In many traditional societies in developing countries it is customary for all daily activities, such as working, preparing food, cooking, eating and sleeping, to take place on the floor. Hence, the floor construction and, more so, the type of surface is of great importance, especially in terms of comfort and cleanliness.**

**But even if activities do not take place primarily on the floor, careful thought should be given to its design and the choice of materials, particularly with respect to the local climatic and environmental conditions, as well as to traditional lifestyles and natural hazards.**

**Although composite climates are more common, design considerations for floor and ceiling construction in the two major climatic regions (warm humid and hot dry climates) show the two extremes, between which a variety of intermediary solutions are possible.**

## **Design Considerations**

- **It is always advantageous to construct floors well above the ground surface: protection against splashing rain and flood water in predominantly humid climates, exclusion of windblown sand in predominantly dry regions.**
- **In warm humid climates, floors raised off the ground, with an air space below, are preferred mainly to facilitate air movement (needed to reduce heat and moisture) and for protection against vermin.**
- **In hot dry climates, floors should preferably be in contact with the ground to facilitate heat conduction from building to earth.**
- **In regions which may experience brief but marked seasonal cooling, the normally welcome coolness of paved flooring may be temporarily mitigated by area rugs, carpets or mats.**
- **The choice of colour on floors exposed to sunshine is determined by a compromise between avoiding glare and discouraging heat absorption. Smooth surfaces are best in all areas subject to dust, but non-slip surfaces must be remembered for steps in wet areas.**
- **Non-uniform ground conditions can cause the foundations and/or floors to subside partially, causing serious damage. Hence, in some cases, it is advisable to construct movement joints between the floor and wall (or foundation).**
- **A dampproof course is required where ground moisture is a problem.**
- **The design of ceilings must take into account the problem of sound transmission from the higher to the lower floor: resilient materials and improper ceiling-to-wall connections can cause acoustical problems.**

## Common Materials for Floors and Ceilings

<b>Material</b>	<b>Characteristics</b>
Stone slabs or tiles	Medium costs to expensive; provides cool, clean surface; impermeable, if joints are waterproof.
Earth	Cheap; suitable for hot dry climates; in warm humid climates raised well above ground; stabilizer and / or water proofing treatment and frequent renewal required (in some regions, cow dung is traditionally used and very effective).
Burnt clay bricks and tiles	Medium costs; provides cool surface; requires careful placement to avoid unevenness; suitable for all climates; structural clay filler blocks on precast concrete joists reduce time of construction and provide good alternatives to concrete ceilings.
Concrete slabs	Expensive; strong; suitable for all climates; with reinforcement good resistance to differential settling of soil; used mainly as substructure; in situ or precast construction.
Screed and concrete tiles	Expensive; strong; screed used as jointless floor surface or as bed for floor tiles; concrete tiles available in large variety of shapes and sizes.
Bamboo	Low to medium costs; used in warm humid regions for floors without ground contact; suitable for substructure and covering, preferably with bamboo boards (split and flat tened culms); very good workmanship and protection against biological agents and fire necessary.
Timber	Medium costs; similar considerations as for bamboo.
Plastics	Medium costs; mainly PVC (polyvinyl chloride) tiles and sheets as floor covering laid on rough timber or screed base.

Sulphur concrete	Medium costs; provides cool, clean and impermeable surface; protection against excessive heat necessary.
Wastes	Low to medium costs; large variety of applications as pozzolana and aggregate in concrete, thermal insulation material, adhesives, boards and tiles.

## **Walls**

### **General**

**The main functions of walls are:**

- **exclusion of heat or cold, rain, wind, dust, noise, and other undesirable climatic and environmental elements;**
- **regulation of indoor climate (temperature, moisture, air movement);**
- **privacy;**
- **security against human and animal intrusion;**
- **support of ceiling and roof structure (though not the case in frame constructions with infill walls).**

**There are principally two ways of building a wall:**

- **massive or loadbearing wall construction;**
- **skeleton or frame construction with non-loadbearing walls.**

**Massive wall constructions usually comprise materials of high compressive strength (eg stone, earth, brick, concrete), by virtue of which they support their own weight and that of**

## the ceiling or roof.

**A skeleton structure consists of vertical, horizontal and angular members (eg timber, bamboo, reinforced concrete), which are joined together to form the loadbearing framework of the building. The space between them may remain open or can be filled in with in-situ wall construction materials (eg masonry wall, straw-clay) or prefabricated panels (eg timber and composite boards, concrete, ferrocement and brick panels). These help to strengthen the frame to prevent distortion. Well-braced frames can also carry a lightweight cladding (eg plywood and bamboo boards, fibre concrete, slate).**

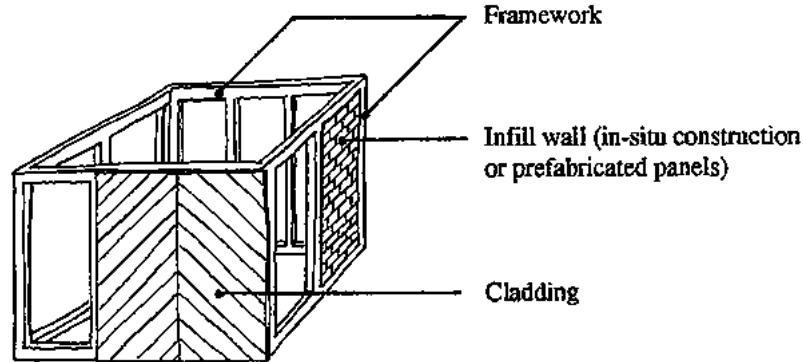

**FIGURE**

## Design Considerations

### Climatic aspects

- **In warm humid regions, diurnal and annual temperatures remain fairly constant, so that walls of low thermal capacity are required, together with large openings for cross-ventilation.**

- **In hot arid zones, in which diurnal and annual temperature variations are large, it is desirable for walls to absorb heat during the 9 - 12 hours of solar radiation and then to emit the heat to the interior until the cold pre-dawn hours, thus maintaining thermal comfort inside the building at all times (time-lag design theory). Small openings, located at higher levels should permit hot air to escape, and exclude solar radiation and glare.**
- **In all warm climates, the long axes of buildings should be orientated in east-west direction, with openings in the walls facing east and west being avoided or kept small, as it is difficult to shade them from the low morning and evening sun. Openings in walls facing south and north are easy to shade from the high noon sun by means of wide roof overhangs.**
- **While the east-west orientation of buildings is important, in warm humid regions priority must be given to orientation for air movement; in hot arid zones, importance must be given to exclusion of hot air, sand and dust.**
- **The absorption of solar heat can be greatly reduced by reflective wall surfaces. The ground adjacent to the building should be shaded or have some vegetation to avoid reflection onto walls, but heat emission at night should not be hindered.**

### **Solid walls**

- **Solid walls with high thermal capacities are common in hot arid climates, as they transfer the absorbed heat to the interior with a time lag, thus restraining the heat when external temperatures are high, and releasing it when temperatures are low.**
- **Typical solid walls are made of stone, earth, burnt clay bricks and concrete.**
- **Insulation on the outside of a solid wall gives a four times greater time lag than if it were placed on the inside, but it also hinders heat dissipation during the night.**

## **Cavity walls**

- **Double walled construction has many advantages, both in warm humid and hot arid regions:**
- **the outer layer protects the inner layer from direct solar radiation, which first heats up the outer layer. With a reflective outer surface, this heat absorption is greatly reduced;**
- **only a part of the heat that passes through the outer layers reaches the inner layer by radiation or convection, and if provided with a reflective surface, it will not absorb all the heat;**
- **if the cavity is not ventilated (as in hollow or perforated bricks), it will act as an insulator, which can be advantageous, but can also hinder the passage of heat from the inside to the outer skin;**
- **openings at the top and bottom of the cavities allow the hot air, which will have accumulated within, to escape at the top, while fresh air is drawn in at the lower side (however, this ventilation of the air space does not affect the radiation from the outer to the inner layer); during the day, when the fresh air is also hot, air circulation will have no cooling effect, so that it would be ideal (but not practical) to be able to close the openings during the day and open them at night;**
- **sound transmission is reduced by the air space.**
- **In warm humid climates, double walled constructions have the additional advantage of protecting the inner layer from rain and moisture penetration. Any moisture that passes through the outer layer is removed by ventilation, and condensation water can trickle down and out through the opening below.**



- **The materials used for cavity walls can be of various types, depending on several factors, such as temperature range, intensity and duration of solar radiation, humidity, rainfall, building usage, nature of immediate surroundings.**
- **In warm humid conditions, the inner skin should not be impermeable, as moisture movement is required, while the outer skin (usually thin panels or tiles on lathing) can be either impermeable or not, but care must be taken to avoid moisture bridging from the outer to the inner skin.**
- **In hot arid environments, materials of lower thermal capacity can be used in cavity walls, for instance, if the outer skin has good reflectivity and thermal insulation. However, the inner layer is generally a soil, brick or concrete construction, but of less thickness than for solid walls, as the heat accumulation over a 9 to 12 hour time-lag period is greatly reduced. The outer skin is typically of thin brickwork, concrete elements or a cladding of flat or corrugated sheets or tiles (eg metal, clay tiles, slate, fibre concrete).**
- **A disadvantage of cavity walls is that insects and vermin may nest in them. To avoid this problem, the interior surfaces of the cavity should be smooth and hard, and occasional washing will remove any accumulated dirt or insects.**

### **Lightweight walls**

- **These are usually thin panels, matting, sheets or tiles of low thermal capacity, fixed to a framework. In some rare cases they can be thermally insulating.**
- **Such walls are only of use in warm humid regions, where heat storage is not needed. The main functions of lightweight walls are to provide shade and privacy, as well as protection from wind, rain and intruders.**
- **Sufficient openings facing the main wind direction are required to facilitate cross-**

## **ventilation for the improvement of indoor comfort.**

• **Lightweight walls are advantageous in earthquake zones, because their failure cannot cause as much devastation as heavy walls. However, in hurricane zones, lightweight walls can be susceptible to serious damage under strong wind pressure, hence strong connections, and avoidance of small elements and projecting parts are essential requirements.**

### **Surface treatment**

- **Depending on the type of material and construction system, wall surfaces can be left untreated or be treated to increase their durability by protecting them against rain, abrasion and vermin, to improve the thermal and moisture performance of the wall, or to improve its appearance by covering unsightly surfaces, or applying decorative effects and colours.**
- **Cement or lime mortars and a variety of stabilized mud plasters are the most common types of surface treatment on concrete, brick and earth structures, whereby special knowledge and experience is required in using the correct rendering for each type of wall material.**
- **Other types of surface treatment are lime and cement washes, varnishes (on timber) and several types of paints (principally oil-based or emulsion paints). Wall paper is less common in tropical regions, but decorative woven fabric and mats are fairly widespread.**

### **Common Wall Construction Materials**

<b><i>Material</i></b>	<b><i>Characteristics</i></b>
Stone	Low to medium costs; high thermal capacity, suitable for climates with large temperature fluctuations; low earthquake resistance; surfaces often harsh, requiring

	rendering in building interiors.
Earth	Cheap; good material for most climates, except consistently humid areas; durability achieved by good compaction, stabilization surface treatment (regularly renewed); low earthquake resistance.
Burnt clay bricks	Medium costs; suitable for all climates; used for loadbearing
and concrete blocks	masonry, infill walls and precast panels; with good workmanship, unlimited durability and good resistance to all natural hazards and fire, surface treatment not always necessary.
Concrete	Expensive; suitable for all climates, mainly for skeleton structures and loadbearing constructions; good durability and resistance to all natural hazards and fire; with good workmanship and formwork, no surface treatment needed.
Ferrocement	Medium costs; mainly used for light infill wall panels or cladding elements; otherwise same characteristics as concrete.
Fibre concrete	Low to medium costs; mainly sheets and tiles for cladding; lighter and weaker than ferrocement.
Natural fibres,	Cheap; only used in warm humid climates for lightweight, infill
grasses, leaves	wall panels and cladding; low durability and resistance to natural hazards, except earthquakes (lightweight and flexible).
Bamboo	Cheap; used in warm humid areas; ideal for skeleton structure, infill walls and cladding; otherwise similar to fibres, grasses, and leaves.
Timber	Medium costs; good for most climates; ideal material for skeleton structures; also lightweight infill panels and cladding; sufficiently thick sections resist fire, but otherwise low resistance to biological hazards; good earthquake and hurricane resistance.
Steelwork	Medium costs; good for loadbearing walls in all conditions except extreme heat.

Suipnur concrete	medium costs; good for loadbearing walls in all conditions except extreme heat; surfaces attractive without rendering, easy to clean.
---------------------	--

## **Roofs**

### **General**

**The roof is the most essential of a house (a house without a roof is not considered a house). It is the part that costs the most, by area and orientation it is the part most exposed to the elements, and it is the part primarily responsible both for indoor comfort and for damage suffered during earthquakes and hurricanes. A well-designed durable roof can compensate for a great number of problems that may arise in other parts of the building.**

**However, technical aspects are not the only determinants of roof design. Many traditional cultures give more importance to various other criteria, such as religious belief, local lifestyles and social status, and these must be respected in designing housing schemes, especially in order to avoid the depressing monotony of present day housing colonies, which look the same in about all parts of the world.**

**While traditional, non-technical aspects of roof design are important, these cannot be dealt with in a technology orientated book of this kind. The basically different types of roofs and the main design criteria for roofs in the two major climatic regions, that is, those that are predominantly warm-humid and those predominantly hot-arid, are summarized below.**

### **Common Roof Types**

#### **Flat roofs**

- **These can be monolithic slabs, sheets or space frame structures, or simple systems using beams, girders and decking elements of low span capability.**
- **By definition, roofs with inclinations less than 10° to the horizontal are classified as flat roofs. For rainwater run-off at least 2° slope is needed.**
- **Strong winds tend to pull off the roof by suction, hence flat roofs are less suitable for hurricane prone areas.**
- **Flat roofs are most common in predominantly hot arid regions, with low annual precipitation. The roofs provide additional living space (for household activities and sleeping at night) and facilitate vertical extensions of the building.**
- **Sheet decking must be laid in falls with large overlaps. An ingenious alternative to corrugated sheets are canaletas (trough-shaped asbestos cement roofing elements) which can span entire dwellings without supporting structures, thus saving material, costs and lime of installation. A good material, in terms of strength and durability, is asbestos cement, which most likely will not be used in developing countries in the course of lime (because of the health hazards). Nevertheless, galvanized iron canaletas (eg produced in Mexico) are a good alternative, and continued fibre concrete research will hopefully bring forth an equally good alternative to asbestos cement.**
- **Space frame roofs, consisting of three-dimensionally triangulated supporting members, are especially suited for large span roofs. They have great lateral rigidity and require only light roof decking.**

### **Sloped roofs**

- **These can be single pitched, gabled and tripped roofs, either of monolithic slabs or sheets or with a system of rafters, purling, trusses or space frames.**

- **Sloped roofs are more common in predominantly warm humid regions with significant rainfall.**
- **Low pitches are cheaper, requiring less wall construction material and less roofing material (smaller roof surface), but suction forces are strongest at 10° pitch. In hurricane areas, minimum roof slopes should be 30° (about 1: 1.7 or 58 %) and wide overhangs (needed for shading and rain protection) should be avoided.**
- **Gabled roofs leave end walls exposed; tripped roofs protect all walls, save on wall area and costs, are less susceptible to wind damage, but are more difficult to construct.**
- **Roofs of courtyard houses should slope inwards for better indoor climate and to facilitate rainwater collection.**
- **Although roof slopes are often given in degrees, angles are difficult to measure out on the site. Therefore, roof slopes should be expressed in simple relations between height and span (eg 1: 1; 1: 2.5; 1: 10), preferably in round numbers.**
- **As the main function of roof slopes is to drain off rainwater, the lower the permeability of the roofing material, the less slope is required. Each material therefore has its own appropriate pitch, as shown in the following table.**

<i>Roof covering material</i>	<i>Minimum slope required</i>	
	<b>Ratio</b>	<b>Angle</b>
Grass thatching	1:1	45°
Timber shingles:		
- untreated timber	1:1	45°
- pressure impregnated timber	1:1.5	33°

Burnt clay and fibre concrete roof tiles:		
- plain tiles and Spanish type	1:1.5	33°
- Roman type (without waterproofing membrane)	1:2	26°
- Roman type (with waterproofing membrane)	1:3	18°
Corrugated galvanized iron sheets:		
- with end laps (ie more than one sheet in direction of fall)	1:3	18°
- with no end laps (ie one sheet between ridge and eaves)	1:5	11°
Canaletas (troughed elements, with no end laps)	1:10	05°

### Curved roofs

- **These include vaults, domes, bow-string or shell structures, lightweight tensile roofs and a variety of more sophisticated types.**
- **Vaults and dome-shaped roofs are common in hot dry climates: the curved surface area being considerably larger than the base, receives less solar heat per unit area, thus lowering surface temperatures and facilitating reradiation after sunset. However, the acoustics inside domes can be very unsatisfactory.**
- **Masonry vaults and domes are likely to fail in earthquakes, while bow-string and concrete shell structures can easily withstand such hazards.**
- **Tensile roofs, using a system of tough membranes on cables or ropes, can cover wide spans, are relatively economical, but aerodynamically unstable with light deck, and are therefore generally used for temporary structures.**

### Roofs for Warm Humid Climates

- **Sloped roofs with wide overhanging eaves are ideal to facilitate rapid rainwater run-off and to protect and shade outer walls and openings. Horizontal valley and internal gutters should be avoided, as these accumulate dirt and water.**
- **Flat roofs with good drainage are common in composite and upland climates with warm dry seasons, which permit activities and sleeping on roofs.**
- **Primary requirements for roofing materials (supporting structure and cladding): low thermal capacity (to avoid heat build-up, which cannot be dissipated at night, since there is no temperature drop); resistance to rain penetration, yet permeable enough to absorb moisture (eg water vapour, condensation) and release it when the air is drier; resistance to fungus, insects, rodents and solar radiation; good reflectivity (to reduce heat load and thermal movements); resistance to impact (hailstones, dropping coconuts, vandalism, etc.); resistance to temperature and moisture fluctuations; freedom from toxic materials (especially if rainwater is collected from roofs).**
- **Ventilated (double-layered) roofs are most effective in providing good indoor living conditions: the outer layer shades the inner building enclosure (reducing heat accumulation); any heat that builds up between the two layers is carried away by cross-ventilation; the difference between temperatures in the building interior and the ventilated air space is not so large as to cause condensation problems; any rain or moisture that penetrates through or develops beneath the outer skin evaporates or drips along the inner surface to the eaves, so that the inner roof layer remains unaffected.**
- **Waterproofing with an impermeable membrane can be unsuitable, since water vapour cannot escape and causes condensation.**
- **Insulating materials prevent release of heat during nights.**
- **Openings at the ridge (sloped roofs), or just below the suspended ceiling or flat roof,**



help to discharge accumulated heat.

- Measures for sound absorption should be considered, as tropical downpours can cause unbearable noise.

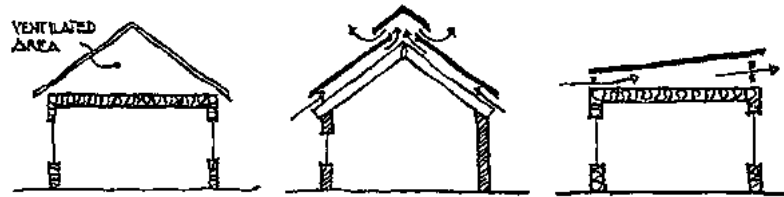

Examples of ventilated roofs (from Bibl. 00.51)

HOT-DRY CLIMATE

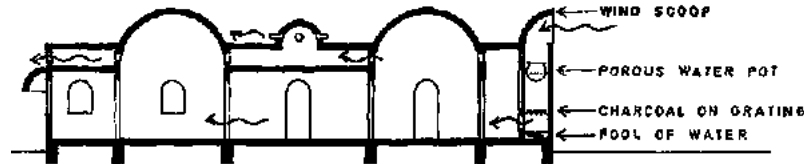

FIGURE

### Roofs for Hot Dry Climates

- As rainwater run-off is no major requirement, flat roofs are most common, providing space for outdoor activities and sleeping.
- Vaults and dome shaped roofs are also common, providing good thermal comfort.
- Primary requirements for roofing materials (supporting structure and cladding): high

**thermal capacity (to absorb solar heat during the day and release it during the night, when the temperature drops considerably); good reflectivity (to reduce heat load and thermal movements); resistance to embrittlement (caused by repeated cycles of heating and cooling) and abrasion (caused by wind-blown sand); smooth surfaces to prevent collection of sand and dust.**

- **Double layered roofs (with sufficient air space to dissipate hot air and with the upper surfaces of each layer designed to reflect heat) can be of lightweight, low thermal capacity materials, whereby the outer layer can be of insulating material.**
- **Wind catchers (towers with openings facing the main direction of wind) are advantageous to redirect higher level breezes into the building.**

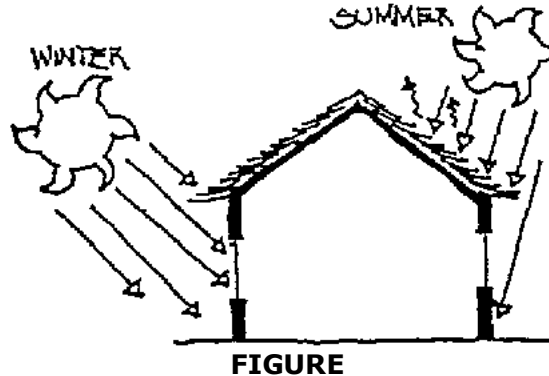

**In some regions it is desirable to exclude the sun during the summer and to use the solar radiation for room heating through windows during winter. This effect can be obtained with an appropriate roof overhang. Its dimension depends on the angle of the solar**

**radiation.****Summary of Common Roofing Materials**

<b><i>Material</i></b>	<b><i>Characteristics</i></b>
Earth	Cheap; good thermal qualities; heavy construction; suitable for houses in dry climates only; not recommended in earthquake areas.
Stabilized soil tiles	Cheap; easy handling; light construction; local production of tiles; resistance to rain only effective with "over"-stabilization, thus forfeiting its economic advantage; medium resistance to hurricanes.
Burnt clay tiles	Medium costs; easy handling; light construction; good resistance to rain and hurricanes; however, tile production consumes a great deal of energy.
Reinforced concrete	Expensive; strong, heavy construction; suitable for most climates; resistant to most natural hazards; but limited availability and high cost of cement makes it less recommended for single storey low-cost housing.
Fibre concrete roofing sheets and pantiles	Low to medium costs; promising material for village production good thermal qualities and resistance to rain and hurricanes.
Corrugated iron sheets	Medium costs; easy handling and transport; good rain resistance; bad thermal and acoustical qualities; good for earthquake areas; good resistance to termites and fungus.
Bamboo	Low to medium costs; easy handling; good rain resistance; good for earthquake areas; low resistance to hurricanes; easily attacked by biological agents and fire.
Thatch	Cheap; easy handling; rapid decay; harbours insects; presents fire hazard.

**Grass roofs (soil roofs with growing grass cover), which are becoming popular in some**

**industrialized countries, have several advantages: use of natural, local material; maintenance of moderate outdoor and indoor microclimate (balance of moisture and temperature); generation of oxygen and humidity; high stability through root reinforcement; good sound absorption. In hot climates, problems may arise in the dry season, requiring watering of roofs to maintain growth, and the roofs are likely to attract insects and small animals, which can be harmful to people. Research is needed to find acceptable solutions.**

## **Building systems**

### **General**

**Building systems are generally understood as industrialized building methods, which involve a high degree of prefabrication, in order to reduce site work to a minimum. Further advantages are:**

- **reduced number of materials and components,**
- **reduced volume of materials and less wastage,**
- **simplified construction details and assembly procedures,**
- **greater accuracy and speed of construction.**

**In industrialized countries, in which these systems were developed and have reached a high degree of perfection, there is the additional advantage of reduced manpower, incurring lower labour costs and consequently lower costs of construction. This is rarely an advantage in developing countries, where labour costs are lower and the aim is to create more employment. Furthermore, the high capital input, quite often requiring imported machinery and equipment, makes industrialized production methods more**

**expensive than conventional constructions (Bibl. 00.34).**

**There are, however, circumstances in developing countries in which industrialized systems are justified, for instance, in emergency housing and building in remote places. But, on the whole, complete systems of prefabrication will continue to be the exception rather than the rule in low-cost construction, while there is great potential in the development of partial prefabrication, dimensional coordination and simplification of procedures for the provision of higher standard constructions at greater speed and lower costs.**

**Complete rejection of industrialized systems is as short-sighted as the total disregard of traditional construction methods. Promising innovative solutions for developing countries always lie somewhere in between, as for example, fibre concrete roofing and the use of cement replacement materials produced from industrial and agricultural wastes.**

### **Examples of Building Systems**

**In this book, the term "Building Systems" is dealt with in a broader sense. The section on Examples of Building Systems includes construction methods, in which the degree of prefabrication differs greatly, as well as traditional, conventional and innovative methods, in which the inherent qualities of a single material are well demonstrated.**

**Hence, the examples show systems with different objectives:**

- systems that utilize only one material for the whole building,**
- systems that improve accuracy and speed of construction,**
- systems that combine the advantages of industrially produced components and those of traditional materials,**

- **systems that provide special protection against natural hazards,**
- **systems that utilize waste materials as alternatives to conventional ones.**

**A great number of other interesting examples could also be included, but the choice was governed mainly by the availability of information and the attempt to cover a wide range of materials and building techniques.**





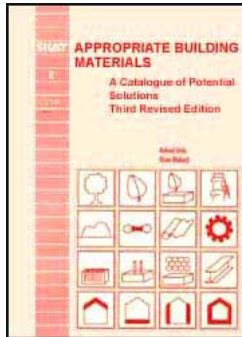

[Home](#) > [ar.cn.de.en.es.fr.id.it.ph.po.ru.sw](#)



## **Appropriate Building Materials: a Catalogue of Potential Solutions (SKAT, 1988, 430 p.)**

### **Fundamental information on protective measures**

-  **Biological agents**
-  **Fire**
-  **Wind and rain**
-  **Earthquakes**

**Appropriate Building Materials: a Catalogue of Potential Solutions (SKAT, 1988, 430 p.)**

**Fundamental information on protective measures**

**Biological agents**

**General**

**Biological agents that can cause problems in buildings are:**

- **insects (termites, borer beetles, triatomine bugs, cockroaches, mosquitos, flies, etc.), which either attack and destroy building materials (such as timber, bamboo, some plastics, etc.), represent a health hazard or are simply a nuisance to the occupants;**
- **animals (rats, bats, birds, snakes, etc.), which can nest in uncontrolled cavities, and can not only create health problems and disturb occupants, but also restrict important functions of the building, for example, by building nests which block ventilation openings or clog drains;**
- **fungi (moulds, stains, rots, etc.), which develop in moist dark conditions on timber and other vegetable building materials, some fungi being non-destructive (blue stain), while others (dry rot, wet rot) lead to decay and destruction.**

**Many methods of protecting buildings and occupants against these agents exist, but some protective measures can create new problems, if implemented without sufficient care and consideration of the consequences. Good building design and use of materials should always be considered before resorting to using chemicals, which can destroy fungi, insects, rats, pets, children .....**

**Protective Measures****Insects**

- **Maintenance of clean conditions on the building site is vital, as dense vegetation, debris, dirt and moisture provide ideal environments for biological agents to thrive in. If termite colonies are found in the vicinity, the use of vegetable building materials should be avoided as far as possible, or used only for non-structural components.**

- **Good drainage of the site is essential, to avoid moist conditions (which attract insects) and standing water (in which mosquitos breed).**
- **Soil poisoning below and around buildings is advocated in most publications, but it should be remembered that the poison will sooner or later be washed into the ground water, losing its protective effect against termites, but contaminating drinking water supplies.**
- **A continuous reinforced concrete floor slab under the entire building can effectively keep out subterranean termites. If joints are necessary, these should be rough and sloping or tongue and groove joints.**
- **Termite shields fixed continuously around the base of the building, V-shaped grooves (45° angle) and metal caps projecting 5 - 8 cm around pipes and columns, provide sharp corners, around which termite tunnels cannot be built. These are also visible barriers that help to detect the development of tunnels, which can then be destroyed.**



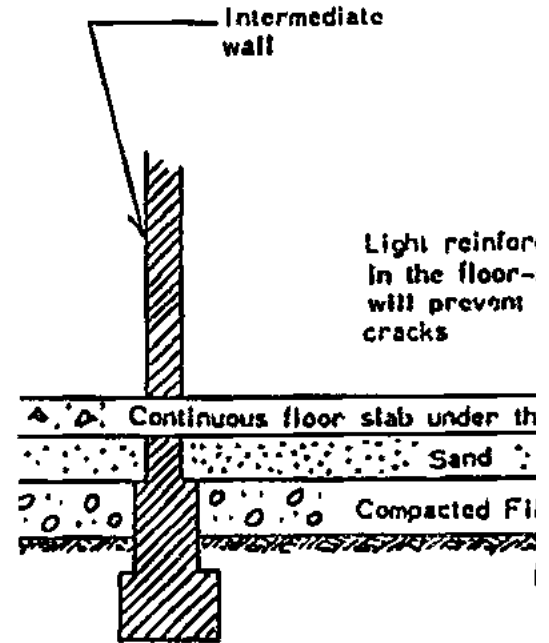
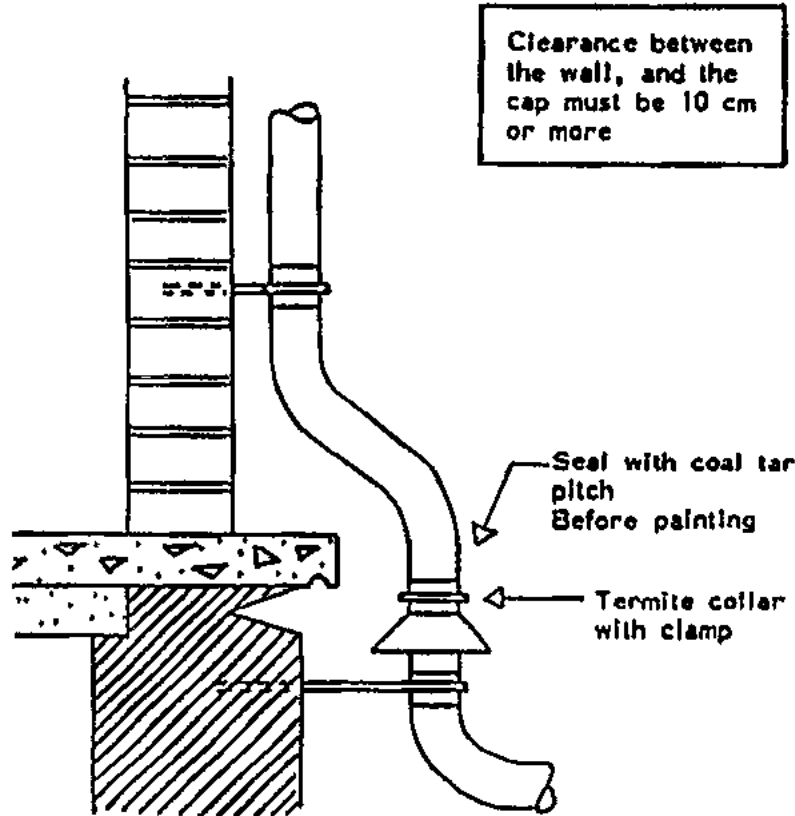

A non-load-bearing wall will also need a foundation

**Protective measures against termites (T. Se, Bibl. 25.12)**

- Buildings raised 80 - 100 cm off the ground on poles or columns (not continuous footing)

**wall) permit visual inspections underneath the floor (to keep away termites and other insects, and maintain clean conditions), and also facilitate ventilation (keeping the floor dry). Exposed foundations and columns should be painted in a light colour to help detect termite galleries easily from a distance.**

- **Foundations and floor slabs must be constructed with great care to avoid the development of cracks through differential settling. Cracks can also develop due to drying shrinkage, thermal and mechanical stresses, or bad quality materials and workmanship, and these should be carefully sealed, especially in walls, to avoid nesting of insects, such as triatomine bugs, which are responsible for the Chagas disease (an illness from which more than 20 million people in the rural areas of Latin America are suffering).**
- **Certain timber and bamboo species have a natural resistance to insect attack, and should be used wherever possible. However, these species are usually rare and expensive, so that less resistant species are mostly in use. Hence proper seasoning and some form of chemical treatment is necessary to avoid early deterioration. (Please refer to the sections on Bamboo and Timber.) Under no circumstance should bamboo or timber components be embedded in the ground.**
- **Mosquitos, flies, flying termites, and numerous other insects can be kept out of buildings by covering all openings with fine wire mesh, but this also causes a reduction of cross ventilation.**
- **New methods of termite control by natural means are being investigated in the Federal Republic of Germany (Bibl. 25.12): by special cross-breeding and elimination of the reproductive capacity of termites; by producing sexual hormones to disorient the termites or alarming pheromones and repellents to start a reaction of escape; by subjecting termites to certain toxic fungi (effective only in the first 3 weeks of the fungus' life). However, these biotechnical and microbiological methods still present problems that**

**warrant extensive research.**

## **Animals**

- **Rats and mice are eliminated by depriving them of nesting places and every possible source of food. Rubbish heaps, piles of stone or wood, tall grass, etc. should be removed.**
- **Food stores can be made rat-proof if the entrance is high enough above the ground and thus inaccessible to rats. Metal sheet strips about 30 cm wide, running parallel to and 60 cm above the ground, prevent rats from climbing up walls. Metal termite caps, projecting farther outwards (about 20 cm), prevent them from climbing up columns and pipes.**

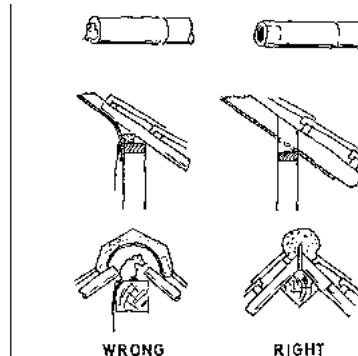
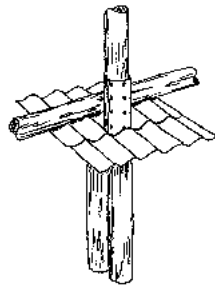

**A simple ratguard (Bibl. 25.08); Prevention of rat nesting (Bibl. 13.13)**

- **Concrete floor slabs prevent animals from gaining access to the building from below.**
- **Birds and bats, which nest under roofs or in cavities, and snakes and other animals that can enter through ventilation slots and pipes, are kept out by covering all openings with a wire mesh.**

- **In general, smooth, hard surfaces, clean conditions and regular inspections are very effective in keeping a place free from pests.**

## **Fungi**

- **Fungi are simple plants which cannot produce their own food from air, water and sunlight, but live on dead organic matter (timber, bamboo, etc.) located in damp, dark, warm and poorly ventilated places. Therefore, the best protection against fungi is to maintain clean, dry, light and well ventilated conditions. Moisture contents of timber should be less than 20 % (achieved by proper seasoning).**
- **Temperatures below 0° C (unrealistic in the tropics) and above 40° C also prevent fungal growth, as well as complete submersion in water.**
- **Designs with timber and other vegetable material should ensure quick drainage of water and avoidance of direct contact with concrete or masonry (achieved by placing a damp-proof membrane to separate the materials).**
- **Timber, affected by dry rot, should preferably be replaced by a fresh, unaffected component, while the affected timber should be burnt.**
- **Chemical treatment can help to eliminate fungi, but here again the comments in the sections on Bamboo and Timber apply.**

## **Fire**

### **General**

**Fire is a chemical reaction which takes place when a combustible material is heated in the presence of oxygen. The liquid or solid fuel gives off vapour when treated and burns as**

**flame.**

**The surface area of a material relative to its volume and density is a major criterium of its ability to burn. Thick, solid material is relatively difficult to ignite and burns only at or near the surface. Thin sheets burn rapidly, while finely divided or pulverized material can become explosive when suspended in air.**

**Fires can break out in buildings by accident (eg when cooking on open fires, as is common in many developing countries), by self-ignition (eg by the discharge of sparks due to friction between materials in very dry conditions, or by concentration of the sun's rays by the lens effect of some glasses), or by natural hazards (eg lightning, or earthquakes).**

**The damaging effects of fires in buildings depends on the materials used and the design and construction of the building. Some materials merely shrink and crack, while others may expand, melt or disintegrate causing total destruction. Lives are endangered by burns, collapsing walls and roofs, inhalation of toxic gases and smoke, panic and loss of sensibility and vision.**

**In hot arid zones, houses are normally built with thick, heavy materials, which do not readily ignite. In warm humid zones, combustible materials are commonly used, but humidity and rainfall can have the same effect. Nevertheless, there is always a fire risk in all climatic zones, and must be taken into consideration in all building designs.**

**Protective Measures**

- **With regard to planning in warm humid zones, where buildings are generally placed well apart for good cross-ventilation, care must also be taken to maintain a good distance between buildings in the direction of the prevailing winds, to avoid spreading of fire from one house to another.**

- **Climatically appropriate design in hot dry zones calls for close spacing of buildings, but sufficiently wide escape lanes and access roads for fire-fighting vehicles are essential.**
- **Combustible building elements should not be used closer than 1 metre to potential sources of fire (stoves, chimneys, etc.); similarly combustible materials stored in and around the house must be shielded from such sources by means of non-combustible materials (eg gypsum, glass, bricks, concrete, metals, stones, mineral wool).**
- **The design of cavities should take into consideration that they can act as flues, spreading fires rapidly.**
- **Chemical treatment of timbers and other vegetable products is possible (mainly impregnation with borax compounds), but expensive, and complete resistance is never achieved.**
- **A fire retardant thatch roof construction has been developed by CBRI, Roorkee in India: a non-erodable bitumen stabilized mud plaster is applied on the upper surface and the drying shrinkage cracks sealed with a slurry of soil and cow dung mixed with a small proportion of bitumen cutback. In this way the dense covering layer stops the passage of air and retards ignition for at least one hour. As an additional advantage, the roof is waterproof.**
- **As a general precautionary measure, it is advisable to have a water reservoir, hose pipe and pump, and/or hand fire-extinguishers close by.**

***Combustible and non-combustible materials (from Bibl. 00.14)***

<b><i>Combustible</i></b>	<b><i>Non-combustible</i></b>
- Timber (even if impregnated with flame retardant)	- Asbestos-cement products
- Fibre building boards (even if impregnated with flame retardant)	- Fibre concrete products

	- Gypsum plaster
- Cork	- Glass
- Wood-wool slabs	- Glasswool (containing not
- Compressed straw slabs	more than 4 - 5 % bonding agent)
- Gypsum plaster board (rendered combustible by the paper liner)	- Bricks
- Bitumen felts (including asbestos fibre-based felt)	- Stones
- Glass wool or mineral wool with combustible bonding agent or covering	- Concretes
	- Metals
- Bitumen protected metal sheet	- Vermiculite
- All plastics and rubbers	- Mineral wool

## Wind and rain

### General

**The hazards dealt with in this section are principally of three types:**

- **Sand and dust**
- **Tropical downpours**
- **Cyclonic storms**

### Sand and dust

- **These are common hazards in hot dry regions, capable of causing problems of durability of building components and great discomfort for the dwellers.**
- **Continuous attack by wind-blown sand causes abrasion of materials and dulling of surfaces; sand and dust can enter buildings through cracks and gaps between materials; accumulation of sand in parts of buildings can be a nuisance, but also a hazard, if loads increase on weak components; rainfall mixed with sand and dust can produce a messy sludge.**
- **Under normal conditions sand particles roll or bounce on hard surfaces to heights between 1 and 1.5 metres, while dust can be carried to any altitude in the earth's atmosphere.**

### **Tropical downpours**

- **These can occur suddenly and with great intensity, producing floods in a very short time.**
- **Heavy rains in the tropics can loosen and dislocate building components; cause breakage and penetration of water; wash off coatings, insecticides and fungicides; create unbearable noise on some types of roofs.**
- **Inundation of buildings causes people to seek refuge on the roofs, which can collapse under the extra load.**
- **The softening of soils and exposure of foundations can cause severe building damages.**
- **Rain penetration in buildings can encourage fungal growth and corrosion of metals.**

### **Cyclonic storms**

- **These storms, commonly called hurricanes (in Atlantic and Caribbean regions), typhoons**



**(in the Pacific region) or tornados (in all inland regions), can reach wind speeds exceeding 300 km per hour. Hurricanes and typhoons are generally accompanied by torrential rains and, since they occur mainly in coastal and island regions, create storm surges, which send seawater several kilometres inland, causing floods and destruction.**

- **The high wind pressures affect all parts of the building, so that light structures are the most vulnerable. Roofs with slopes less than 30° can be torn off by the high negative pressure (suction) on the leeward side.**
- **Flying debris also cause considerable destruction; due to the lashing rain, water penetrates unprotected parts of buildings; components get dislodged and a rewashd away; trees, power transmission poles, chimneys, etc., fall on houses and people; and a number of other effects of tropical cyclones can account for thousands of deaths and total devastation.**

## **Protective Measures**

### **Sand and dust**

- **Wind-blown sand is effectively excluded by surrounding houses with sand barriers (eg masonry walls) of at least 1.60 m height. Better still are houses with completely enclosed courtyards, whereby the outer walls have no openings, or just small ones located at a high level.**
- **Vegetation around houses can greatly reduce the amount of flying sand and dust. Narrow, zig-zag streets with high walls on either side have a similar effect.**
- **Projecting components and cavities should be avoided on outer walls to prevent accumulation of sand and dust. Surfaces should be smooth and resistant to abrasion.**

## **Tropical downpours**

- **The siting of buildings should facilitate quick drainage of water. Houses raised well above the ground surface and drainage channels surrounding them are important.**
- **Wide overhanging sloped roofs are required to protect outer walls and openings, and discharge the rainwater at a sufficient distance from the wall base, avoiding dirt and erosion by splashing water.**
- **Tight, waterproof joints and water-resistant materials or surface treatments are essential to avoid rainwater penetration. Facilities for cross-ventilation to remove indoor moisture are equally important.**
- **Insecticides and fungicides applied externally can be washed out, losing their function, but contaminating the surroundings; hence they should be used with great care or avoided, if possible.**
- **Metal connectors and components that can corrode should be protected from rainwater and well ventilated to prevent moisture retention.**
- **To prevent noise problems on sheet metal roofs, shorter spans between supports, bitumen coating on the underside of sheets, rubber washers at the suspension points, and an insulating layer or suspended ceiling, all contribute towards noise reduction, and are effective in combination with each other. Quite often layers of straw are placed on the roof, but must be tied down, as winds can blow them off.**
- **In flood prone areas, roofs must be especially strong to carry the load of dwellers seeking refuge. Provision of storage space just under the roof and openings for trapped air to escape are further useful measures. House constructions that permit the house to float on flood water can avoid a lot of damage, providing it is anchored at the same spot.**

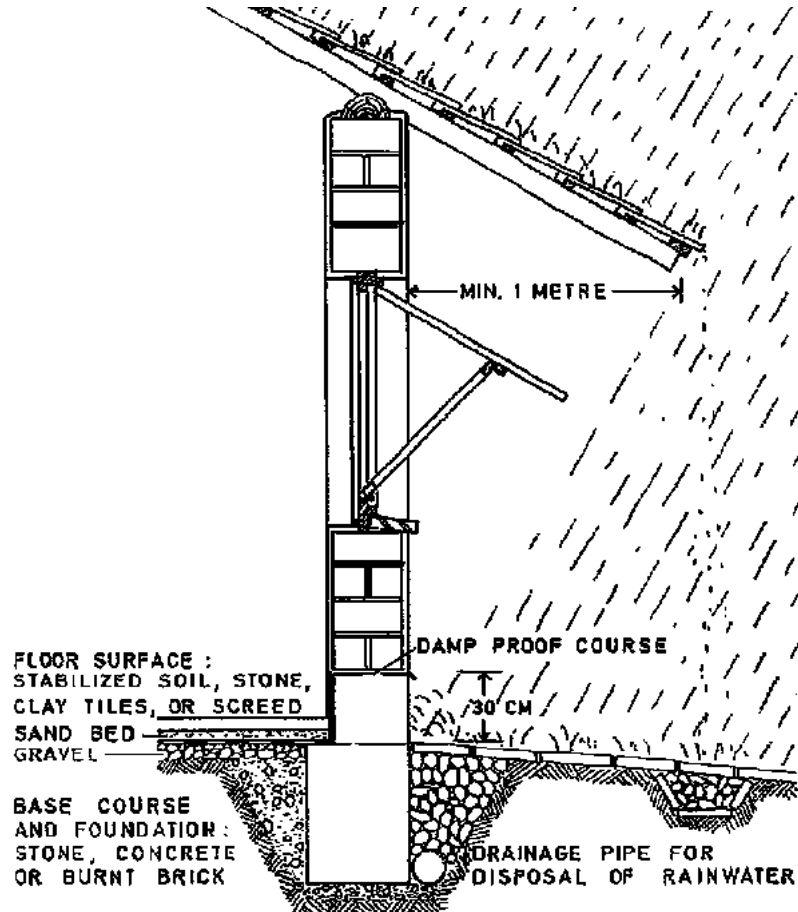

**Rain protection of stabilized soil block construction 00.12)**

## **Cyclonic storms**

- **Building sites should preferably be at higher levels, sufficiently distant from the seashore, and topographies or the surrounding buildings should not cause a funnel effect or increase wind velocities. Clusters of trees act as natural wind-breaks.**
- **Foundations should be generously dimensioned and wide at the base to resist uplifting forces or tilting due to pressure from the side. Connections between foundations and walls or columns need to be exceptionally strong.**
- **Stability is increased by division of floor plans into smaller rooms, the walls being strong enough to resist lateral forces (eg strong corners, diagonal bracing, etc.) and securely fixed to the foundations and roof; outer walls should be smooth and streamlined (eg rounded corners, no projections) to provide least resistance to winds.**
- **Roofs should be sloped at least 30°, to reduce the danger of lift-off; for the same reason, wide overhangs must be avoided (which contradicts the requirement for rain protection); connections to the substructure must be particularly strong and rigid, as forces act from all sides.**
- **Openings should be small and provided with shutters (folding or sliding, rather than hinged); glass panes, especially thin varieties, should be avoided.**
- **In general, good materials and workmanship are the principal protective measures, and designs should permit easy access to vulnerable parts for regular inspection and maintenance.**

**Location**

1. Take advantage of natural wind-breaks such as trees or hedges when deciding on a site for a building. Such a location can reduce the impact of prevailing winds.

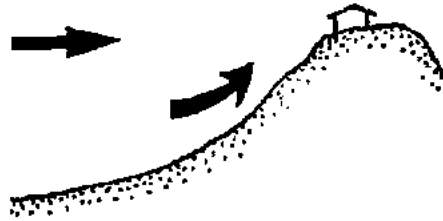

2. Be careful of sites on hills or near hilltops where windspeeds can be much higher.

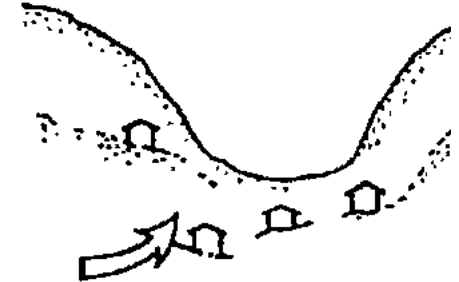

3. Valleys funnel winds and can create higher windspeeds.

**Shape of building**

4. Carefully consider the pitch of the roof.

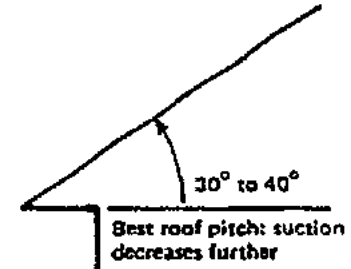
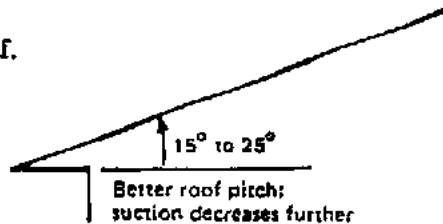
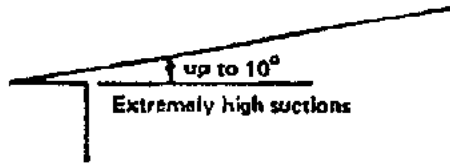
**Aspects of building to withstand strong winds (Bibl. 25.06)****Earthquakes****General**

Of all natural disasters, earthquakes cause the greatest amount of death and destruction. They generally occur without any warning and, depending on their intensity, can within a

**few seconds turn a prosperous town into a pile of rubble.**

**There are several causes for seismic tremors, the main cause being the movement of large continental plates (a few millimetres per year), which collide, move apart or rub against each other, building up immense tension within the rock formations, which at a certain point readjust themselves with a sudden violent motion, sending out seismic waves in all directions. Another cause is the leaking out of molten magma through faults in the earth's crust, which can happen deep beneath the sea or in the form of volcanic eruption. Quakes beneath the sea give rise to tsunamis (Japanese name for seismic sea waves), which can cause total devastation in coastal areas. Volcanic eruptions affect a comparatively small area and damage is mainly caused by molten lava and ash descending on houses and fields.**

**Artificial causes of earthquakes have recently resulted from the construction of dams, where the large water reservoirs exert great pressure on the earth's crust and lubricate faults, which release the pressure in seismic waves. The exploitation of oil and gas deposits disrupts the balance of pressures and thus can also lead to seismic tremors.**

**These causes make certain regions more prone to earthquakes than other areas, but exact forecasts of time and intensity are not possible so far. Special measures to minimize damage to lives and property are recommended in these regions, but complete safety cannot be achieved.**

**Seismic waves comprise horizontal, vertical and torsional (twisting) movements acting simultaneously. Weak, non-elastic components break apart or disintegrate; elastic materials vibrate and absorb the tremors; while tough and rigid materials can remain unaffected. Destruction of buildings mainly begins with walls falling apart; the ceilings and roofs, lacking support, follow suit, burying the dwellers and property beneath them. However, far greater damage results from secondary effects of earthquakes, such as fire,**

landslides, damburst, epidemics, etc. A series of smaller tremors follow major earthquakes and can lead to further collapse of buildings, greatly complicating rescue work.

The greatest casualties occur where the population is poorest and houses are built with cheap, sub-standard materials and methods, on dangerous sites, such as slopes, sea shores, valleys below dams, etc. Earthquakes of comparable intensities cause far less destruction and deaths in industrialized countries and rich areas of Third World cities, than in the poor rural areas and slums of developing countries. Hence, earthquakes are often called "classquakes".

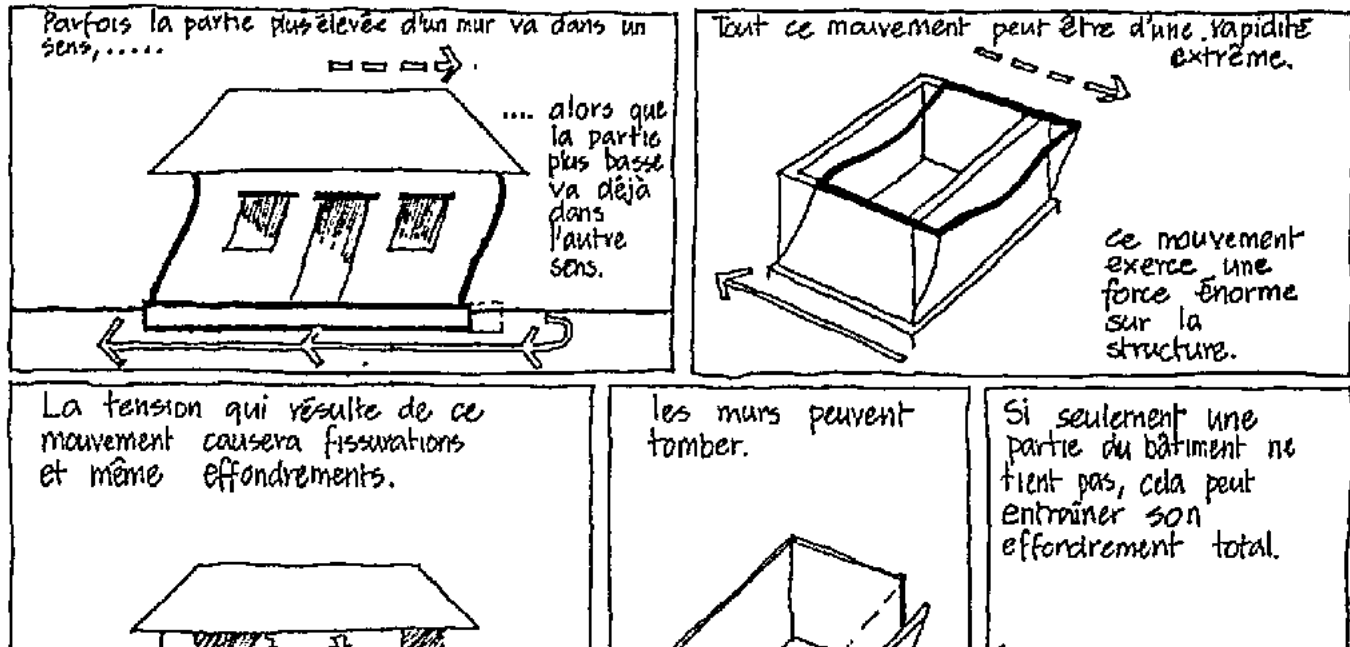

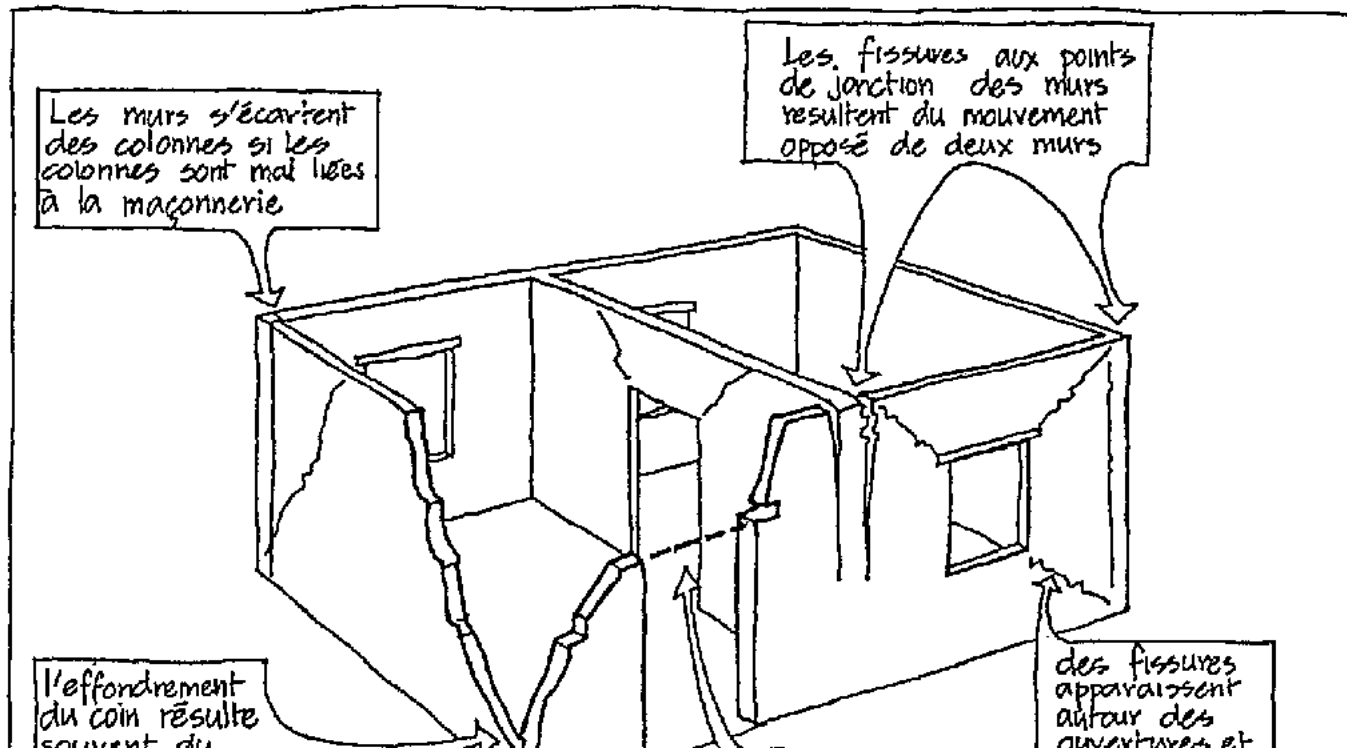
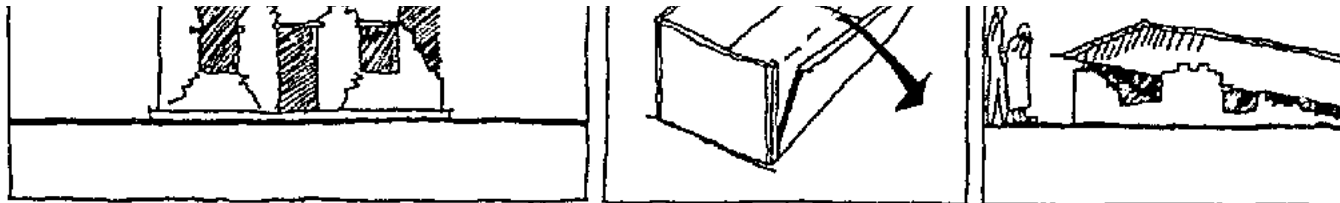





**Typical earthquake effects and damage (drawings by John Norton, Bibl. 25.10)**

### **Protective Measures**

- **Building sites should not be on or close to hillsides (danger of landslides, avalanches), or near the sea (risk of tsunamis); sufficient distance from neighbouring structures (danger of collapse), especially in prevailing wind direction (fire risk), and downstream from reservoirs (danger of dam-burst) should be maintained. Filled ditches and watercourses should be avoided.**
- **Building forms must be simple and symmetrical (both horizontally and vertically); complicated forms are possible, if subdivided into independent, simple components.**
- **Foundations should be of reinforced concrete, constructed on solid ground (preferably rock), maintaining uniform depths (no stepping on sloping ground) and having continuous reinforcement. On poor soils, strong slab foundations have the advantage of "floating" on seismic waves, thus avoiding damage.**
- **Walls should be relatively light (to lower the centre of gravity of the building and reduce the damaging effects of collapsing walls), capable of absorbing vibrations, but with rigid connections to foundations, adjoining walls and roof. Frame structures (timber, bamboo, reinforced concrete, metal) with light infill walls are most resistant to earthquakes, conventional masonry structures require a strong, continuous ring beam on top of the walls, to prevent them from falling apart.**

- Openings should be small, not less than 50 cm from corners or other openings; glass panes should be avoided.

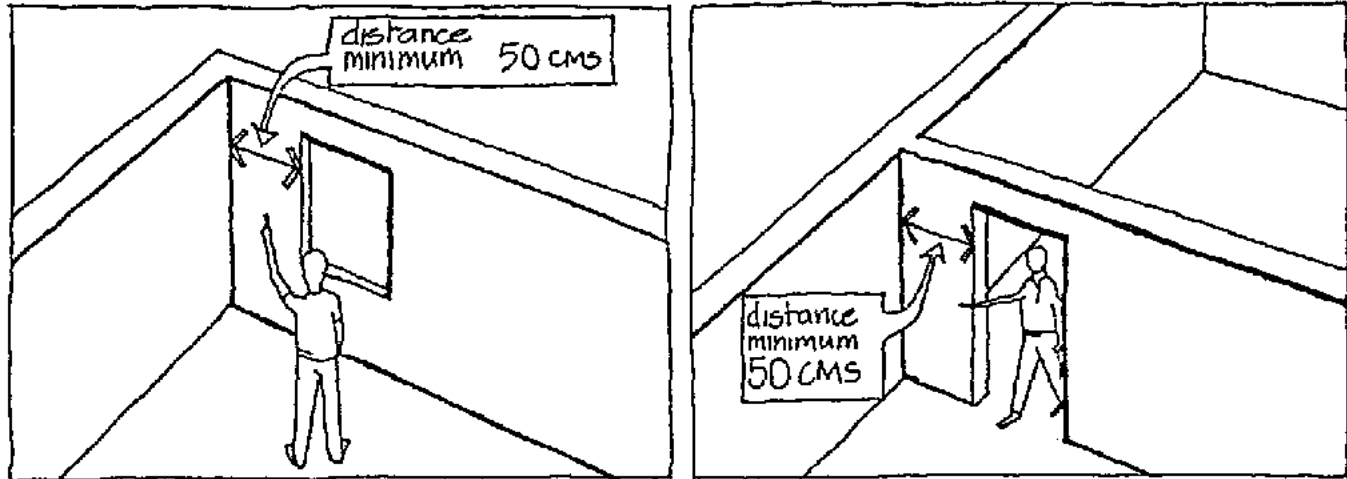

FIGURE

- Roofs should be as light as possible, either monolithic (with high tensile strength, eg reinforced concrete), or of strong, flexible members, firmly tied to the supporting structure; compact symmetrical shapes with spans as small as possible. Roofs must be securely fixed to the ring beam or building frame. Alternatively, roofs can be fixed to independent supports, structurally separated from the walls, which, in the event of failure, would not cause the roof also to collapse.
- Appendages (eg parapets, chimneys, water tanks), if they cannot be omitted, should be very securely fixed, to avoid their being shaken off.

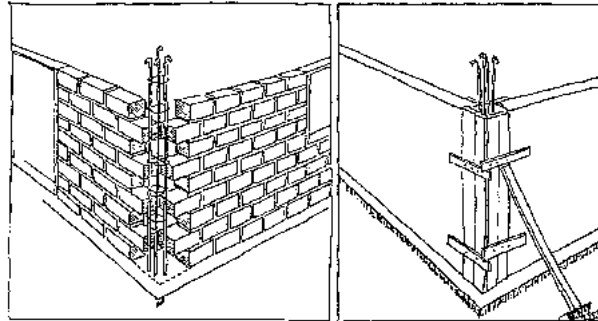

**Strengthening of masonry walls with reinforced concrete (Bibl. 25.10)**

- **Stone, earth and clay brick walls generally perform poorly in earthquakes. Improved resistance to collapse is achieved by strengthening and reinforcing corners; ring beams are essential. Masonry walls and domes should be avoided in earthquake zones. Clay tile roofs need strong and heavy timber substructures, which are a hazard when they collapse, and the tiles tend to fall down under vibration.**
- **Reinforced concrete and ferrocement are ideal materials for seismic resistant constructions, if the qualities of cement, aggregate and workmanship are good, and the metal reinforcements are protected from corrosion. Concrete frames and thin shell structures are best, but heavy ceiling and roof slabs must be avoided.**
- **Timber and bamboo frames with light infill walls or cladding provide optimum earthquake resistance, and cause less destruction than heavier materials in case of collapse, but represent a fire hazard, which is of significance during earthquakes (due to breakage of chimneys, power and gas supply lines, etc.). Protection against biological hazards is essential to avoid weakening of the construction.**
- **Metal frames permit light, flexible constructions, but design and dimensioning should**

**take into account the risk of buckling; fire protection and good resistance to corrosion are essential. Metal sheet roofs generally perform well in earthquakes.**

**• General precautionary measures are in all cases good workmanship and regular inspections of critical parts for maintenance and repairs; also all protective measures against fire.**





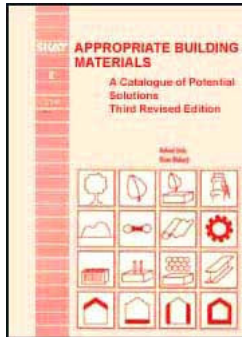

[Home](#)''' ''''''> [ar.cn.de.en.es.fr.id.it.ph.po.ru.sw](#)



 **Appropriate Building Materials: a Catalogue of Potential Solutions (SKAT, 1988, 430 p.)**

➔  **Examples of foundation materials**

-  **Natural stone foundations**
-  **Rammed earth foundations**
-  **Burnt brick foundations**
-  **Concrete foundations**
-  **Split-bamboo piles**
-  **Wooden post foundation**

**Appropriate Building Materials: a Catalogue of Potential Solutions (SKAT, 1988, 430 p.)**

**Examples of foundation materials**

**Natural stone foundations**

**KEYWORDS:**

<b>Special properties</b>	Suitable where concrete is expansive
<b>Economical aspects</b>	Low cost
<b>Stability</b>	Good
<b>Skills required</b>	Skilled labour
<b>Equipment required</b>	Masonry equipment
<b>Resistance to earthquake</b>	Medium to good; depends on overall design
<b>Resistance to hurricane</b>	Good
<b>Resistance to rain</b>	Good
<b>Resistance to insects</b>	Very good
<b>Climatic suitability</b>	All climates
<b>Stage of experience</b>	Widely used

### SHORT DESCRIPTION:

- **Stone foundations are made of rubble (undressed stone) or squared stone; similar construction is possible with broken brick and concrete from demolished buildings.**
- **The quality of mortar is of importance to achieve good strength. An example of a good mix is:**
  - **4 parts cement**
  - **1 part lime**
  - **12 parts clean sand**
  - **sufficient water to make a workable mix.**
- **Construction should start on firm, uniform strong subsoil. It should not be started on grass, black fertile soil, filled up materials or mud.**

- **Under the foundation there should be a layer of lean concrete (min. 5 cm) or tamped sand; minimum depth 40 cm.**
- **In earthquake areas, reinforcement with wire mesh or steel rods is required, but professional advice should be sought. Further information: Bibl. 01.01, 01.05, 01.06, 20.05.**

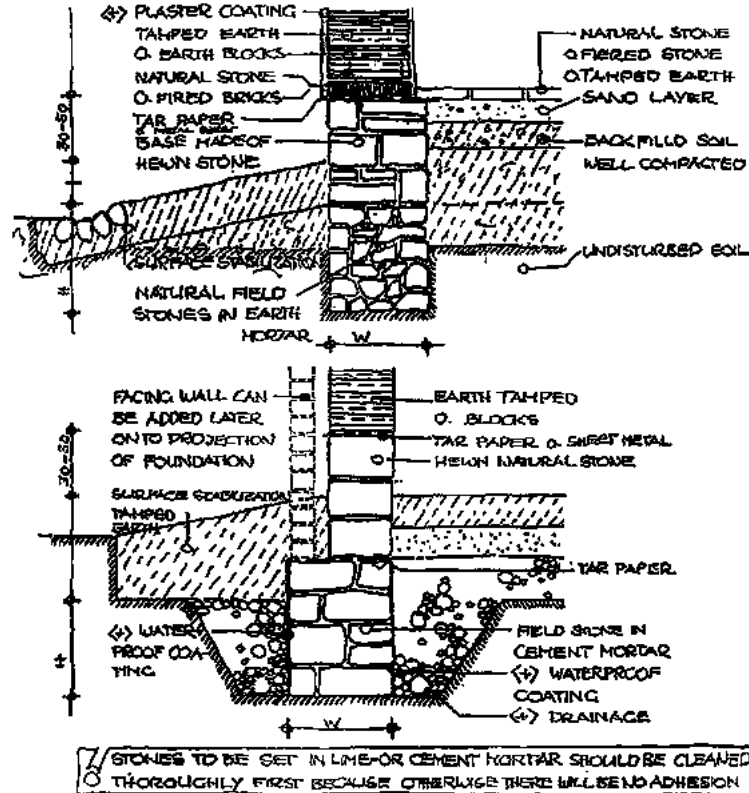

Stone in Earth Mortar (from Vorhauer, Bibl. 20.05); Stone in Cement Mortar (Bibl. 20.05)

## Rammed earth foundations

### KEYWORDS:

<b>Special properties</b>	Only used for earth constructions on dry sites
<b>Economical aspects</b>	Low cost
<b>Stability</b>	Poor to medium
<b>Skills required</b>	Semi-skilled labour
<b>Equipment required</b>	Excavation and tamping equipment
<b>Resistance to earthquake</b>	Low
<b>Resistance to hurricane</b>	Low
<b>Resistance to rain</b>	Low
<b>Resistance to insects</b>	Low
<b>Climatic suitability</b>	Only very dry climates
<b>Stage of experience</b>	Traditional method

### SHORT DESCRIPTION:

- **Rammed earth foundations are made of well graded soil, preferably with a stabiliser for water resistance and higher strength.**
- **The site must be well drained and great care is needed to protect the foundation from ground moisture, especially with a plastic foil or bitumen felt. Bitumen paint, or a facing of rubble stone or burnt bricks are alternatives.**
- **When in doubt about suitability of rammed earth foundations, they should not be used. Stabilized soil blocks can be used instead, but similar protective measures are necessary.**
- **Wherever possible, the earth foundation should be placed on a concrete footing.**
- **The foundation is made in formwork, in the same way as the walls: layers of 10 cm soil**



are tamped down to 6 - 7 cm, before the next layer is filled up.

Further information: Bibl. 02.06, 02.08, 02.19, 02.32, 20.05.

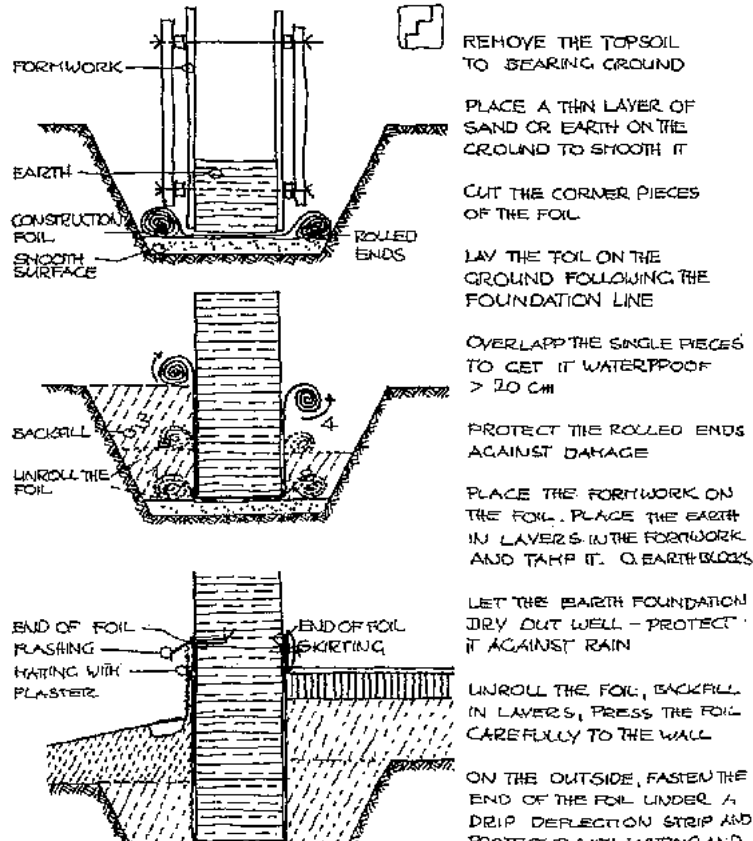

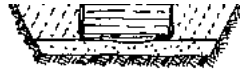

PROTECT IT WITH RAMMING AND  
PLASTER.

ON THE INSIDE, NAIL THE END OF  
THE FOIL TO THE WALL UNDER  
THE EXISTING

## Procedure of Constructing a Rammed Earth Foundation (Bibl. 20.05)

### Burnt brick foundations

#### KEYWORDS:

<b>Special properties</b>	Good alternative to concrete foundation
<b>Economical aspects</b>	Medium costs
<b>Stability</b>	Medium to good
<b>Skills required</b>	Masonry skills
<b>Equipment required</b>	Masonry equipment
<b>Resistance to earthquake</b>	Medium to good
<b>Resistance to hurricane</b>	Medium to good
<b>Resistance to rain</b>	Good
<b>Resistance to insects</b>	Good
<b>Climatic suitability</b>	Most climates, except consistently wet areas
<b>Stage of experience</b>	Widely used

#### SHORT DESCRIPTION:

- **Burnt brick foundations are principally the same as masonry wall constructions, but begun under the ground, either directly on a bed of tamped sand or lean concrete, or on a concrete footing.**

- **A widened base is preferable to distribute the weight of the walls.**
- **Care must be taken to lay the bricks in perfectly level courses, and measures for waterproofing are important.**
- **A good mortar for masonry foundations is:**
  - **4 parts cement**
  - **1 part lime**
  - **12 parts clean sand**
  - **sufficient water to make a workable mix.**
- **In earthquake areas, masonry foundations should be reinforced with wire mesh or thin rods. Professional advice should be sought. Further information: Bibl. 20.04, 20.05.**

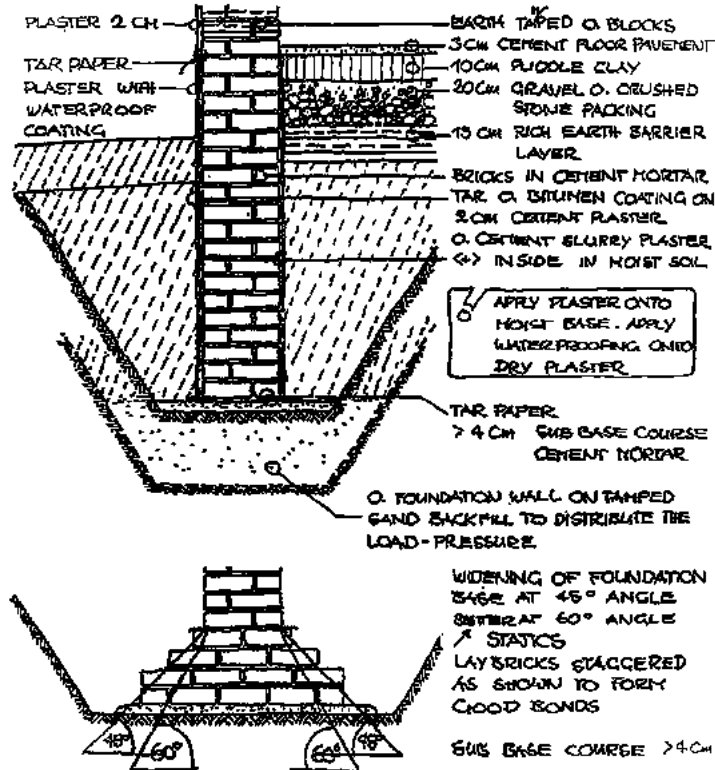

**Burnt Bricks in Cement Mortar (Bibl. 20.05)**

## Concrete foundations

### KEYWORDS:

<b>Special properties</b>	Strongest foundation
<b>Economical aspects</b>	Expensive
<b>Stability</b>	Very good
<b>Skills required</b>	Skilled labour
<b>Equipment required</b>	Form work, cement mixer
<b>Resistance to earthquake</b>	Very good
<b>Resistance to hurricane</b>	Very good
<b>Resistance to rain</b>	Very good
<b>Resistance to insects</b>	Very good
<b>Climatic suitability</b>	All climates
<b>Stage of experience</b>	Commonly used worldwide

### **SHORT DESCRIPTION:**

- **Concrete foundations on hard, uniform ground can be made without steel reinforcement, if not in an earthquake or hurricane prone area.**
- **All non-uniform and problem soils require reinforced concrete foundations, especially in areas of medium to high rainfall and natural hazard regions.**
- **Depending on the strengths required, concrete mixes can vary from 1: 3: 4 (cement: sand : gravel) to 1: 4: 7, the higher proportion of cement being required for reinforced concrete.**
- **Water contents of fresh mixes should make them just easily workable. Excessive water leaves pores in the concrete, making it weak and water absorbent. Foundation trenches**

**should also be properly wetted to avoid excessive absorption of the water from the mix.**

- **The concrete should be wet-cured for 3 to 7 days before building the walls. A damp-proof course should be laid between foundation and wall.**

**Further information: Bibl. 20.03, 20.04, 20.05.**

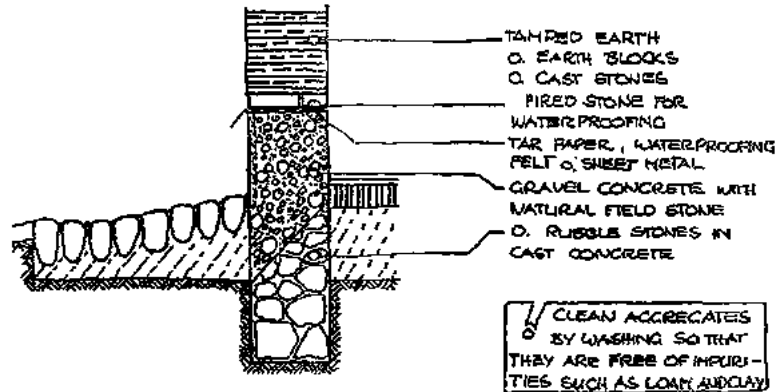

✓ CLEAN AGGREGATES BY WASHING SO THAT THEY ARE FREE OF IMPURITIES SUCH AS LOAM AND CLAY

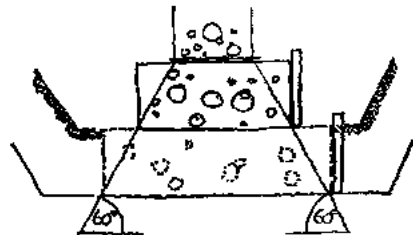

WIDENING OF FOUNDATION OF CONCRETE AT 60° ANGLE / STATICS

CONCRETE FOUNDATION IS RECOMMENDED FOR ALL EARTH WALL CONSTRUCTIONS

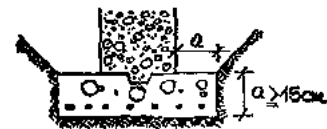

REINFORCED FOUNDATION BASE FOR POOR SOIL NON-SLIDING INDENTED JOINT

**Cast Concrete Foundations (Bibl. 20.05)**



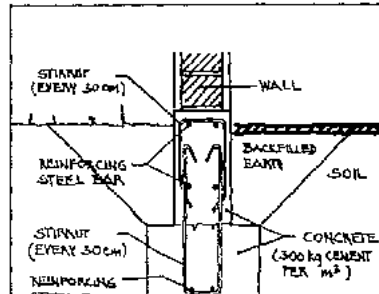
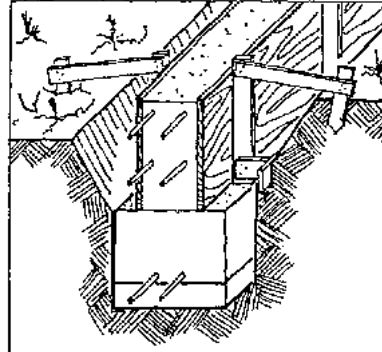
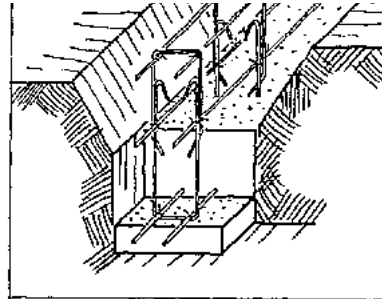



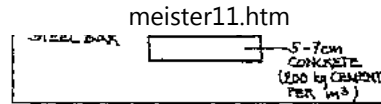

## Reinforced Foundations

**Placing concrete footing without shuttering: the reinforcement is laid after the lowest course of lean concrete is hardened. The richer second layer holds the reinforcement.**

**Foundation strip poured into shuttering of wood or plywood. These should be oiled before pouring concrete, to facilitate removal after hardening.**

**The finished foundation, with the trench filled up with the previously excavated soil and well compacted.**

### Foundations on Expansive Clay (Bibl. 20.03)

- **Certain clayey soils respond to moisture movements (in rainy and dry seasons, moisture extraction by trees, etc.) with excessive swelling and shrinkage, which can severely damage foundations and consequently entire buildings.**
- **Damage can be avoided by either installing foundations which penetrate through the zone of ground movement, or by constructing foundations and superstructures which are tolerant of ground movement.**
- **Pile-and-beam-foundation: Small diameter piles are installed below the zone of clay movement; RC ground beams, which span between pile heads are constructed on compressible material (eg expanded polystyrene), which absorbs ground movement without affecting the beams and superstructure.**
- **Pad-and-beam-foundation: Pads are installed on stable ground below the movement zone; RC columns support ground beams, which are constructed in the same way as in the**

### pile-and-beam-foundation.

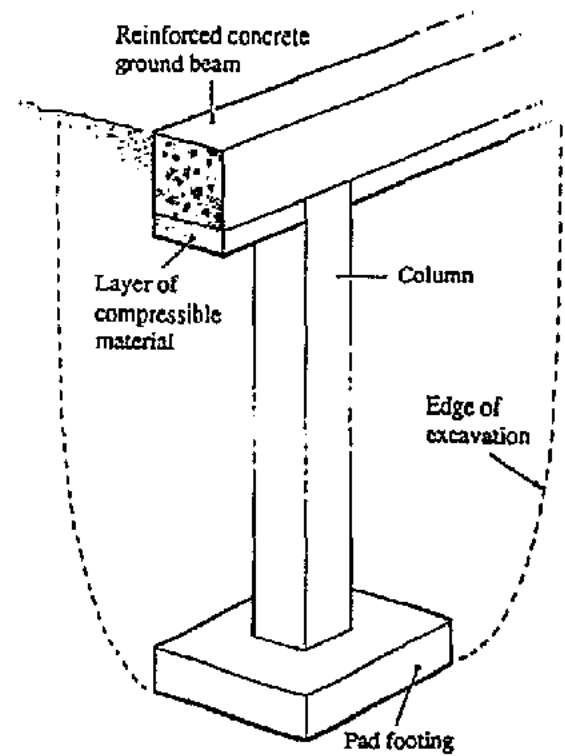
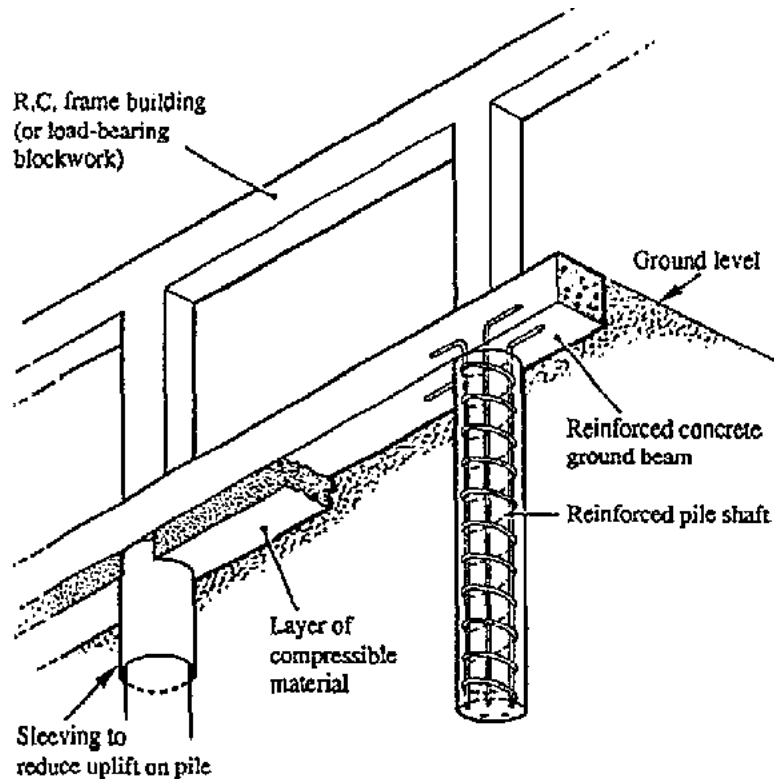

**Pile-and-beam-foundation; Pad-and-beam-foundation**

## Split-bamboo piles

### KEYWORDS:

<b>Special properties</b>	Used for subsoil stabilization
<b>Economical aspects</b>	Low cost
<b>Stability</b>	Good
<b>Skills required</b>	Special training
<b>Equipment required</b>	Drop hammer
<b>Resistance to earthquake</b>	Good
<b>Resistance to hurricane</b>	Good
<b>Resistance to rain</b>	Good, helps to drain water
<b>Resistance to insects</b>	Low
<b>Climatic suitability</b>	All tropical areas
<b>Stage of experience</b>	Experimental

### SHORT DESCRIPTION:

- **Split-bamboo piles have been developed to improve the bearing capacity of soft compressible soils and to reduce settlements for various types of construction works, such as buildings, roads, etc.**
- **The hollow bamboo culms are filled up with loosely wound coconut coir and jute thread wrapped in jute fabric; holes in the culm permit the water in the soil to tackle in, thus drying out the soil and improving its load-bearing capacity.**

**Further information: Dr. M.A. Aziz or Dr. S.D. Ramaswamy, Department of Civil**

**Engineering, National University of Singapore, 10 Kent Ridge Crescent, Singapore 0511;  
Bibl. 20.01.**

### Split-Bamboo Pile

Split-bamboo piles filled up with loosely wound coconut coir strands of about 6 mm diameter each tied up with spirally wound jute thread along its length and wrapped with a layer of thickly knit jute burlap have been successfully used. Treated split-bamboo steps were holed at random points and tied up together at regular intervals with galvanized iron wire after putting the coconut coir wicks inside along its entire length (Fig. 1).

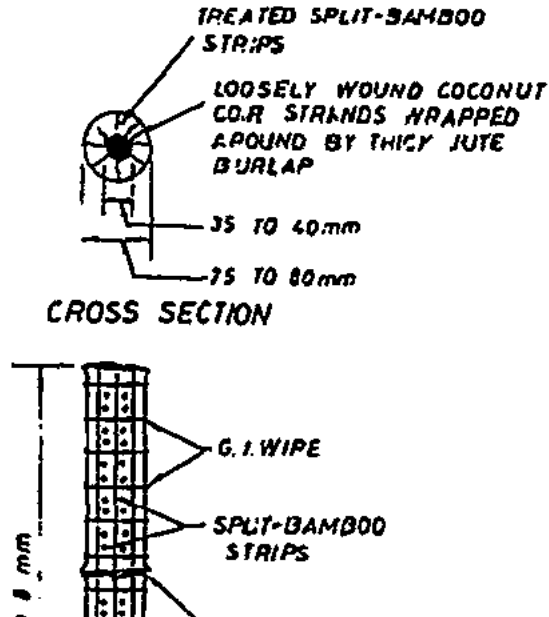

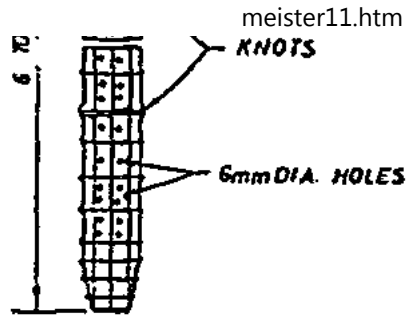

ELEVATION

Fig. 1 Split-bamboo piles

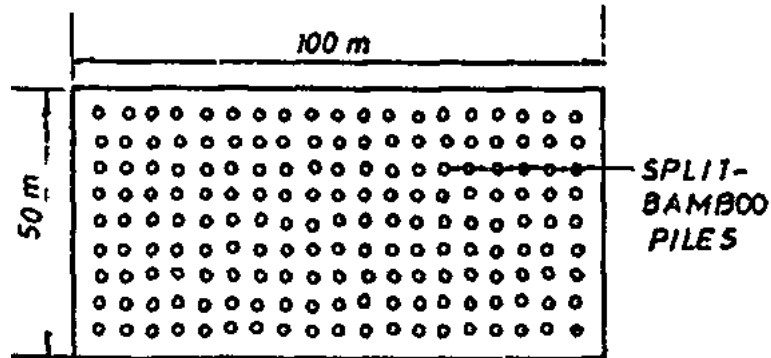

PLAN

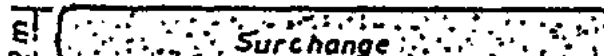

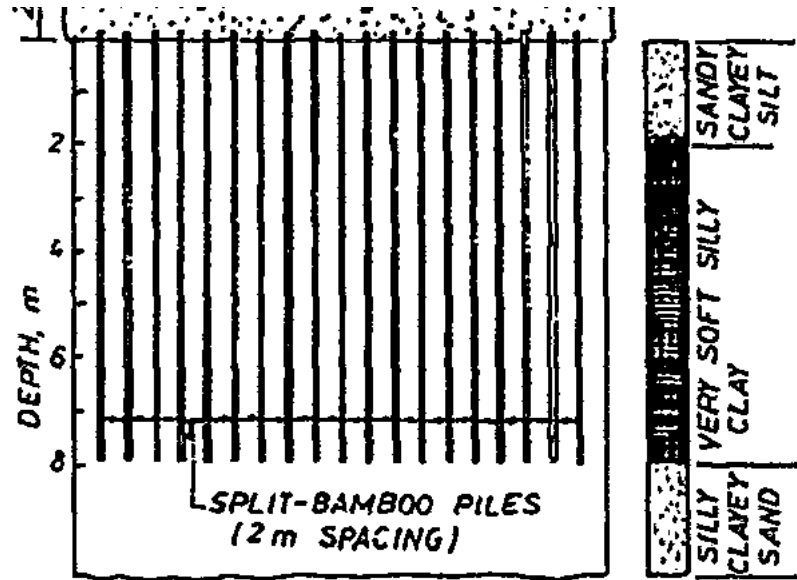

ELEVATION  
FIGURE 1; FIGURE 2

SOIL PROFILE

### Stabilized Area

These specially made split-bamboo piles were used in stabilizing the soft compressible subsoil of an actual construction site (Fig. 2) which consisted of a top layer of about 2 m thick soft to medium stiff sandy clayey silt underlain by a layer of about 6 m thick very soft silty clay which was again underlain by a layer of medium dense silty clayey sand. The split-bamboo piles, each about 8 m long, 80 to 90 mm diameter, were driven by a drop

**hammer at 2 m spacing in a square grid. After installation of the piles the entire area was covered with about 2 m surcharge of sandy materials (Bibl. 20.01).**

## **Wooden post foundation**

### **KEYWORDS:**

<b>Special properties</b>	Used for spot and pile foundations
<b>Economical aspects</b>	Low cost, if sufficient timber is available
<b>Stability</b>	Low to good
<b>Skills required</b>	Carpentry and construction skills
<b>Equipment required</b>	Carpentry and masonry equipment
<b>Resistance to earthquake</b>	Low to good
<b>Resistance to hurricane</b>	Low to good
<b>Resistance to rain</b>	Low to good
<b>Resistance to insects</b>	Low
<b>Climatic suitability</b>	All, except consistently wet climates
<b>Stage of experience</b>	Traditional methods

### **SHORT DESCRIPTION:**

- **Wooden post foundations can only be used for lightweight structures, that is buildings made of timber, bamboo and/or other vegetable material.**
- **The main drawback of using timber for foundations is the risk of weakening due to attack by insects (mainly termites and beetles), fungus and rodents. Hence, protective measures are necessary. (See sections on Timber and PROTECTIVE MEASURES.)**

- Timber posts can be driven into the ground, if the climate is predominantly dry, the site is well drained and destructive biological agents (mainly termites) are not common in the area. Further information: Bibl. 14.18, 14.22, 20.04, 20.05.

### Simple Wooden Post Foundations (Bibl. 20.05)

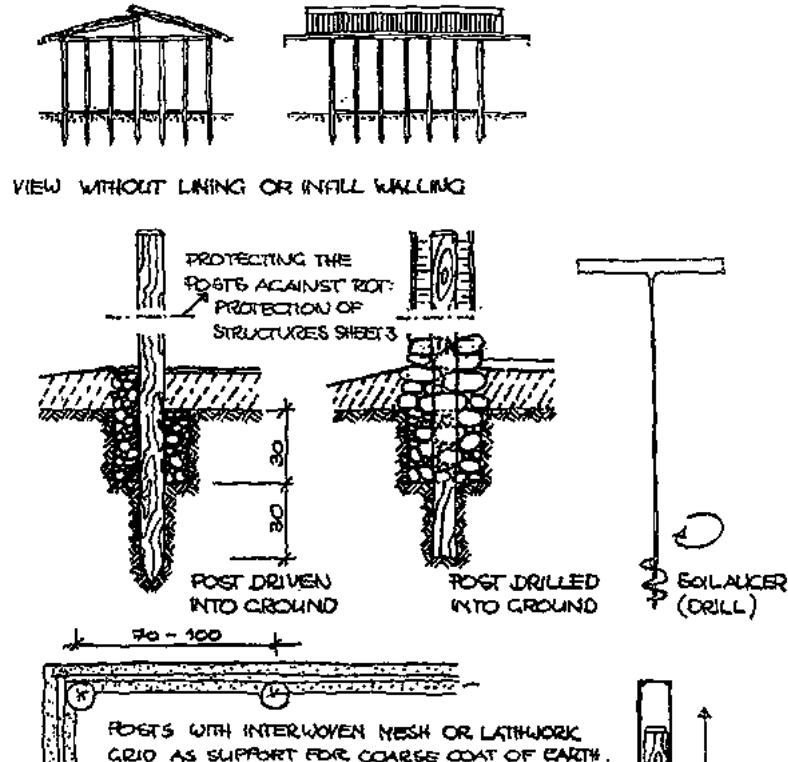



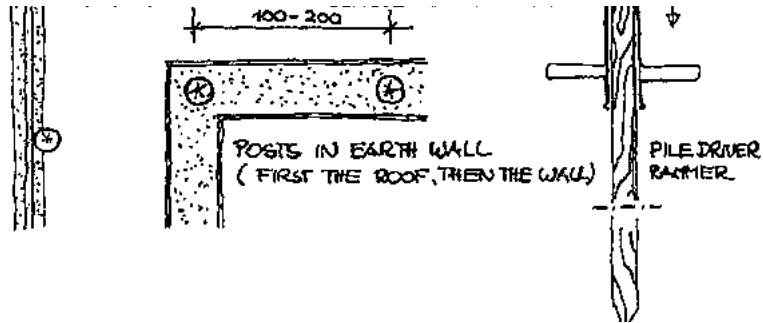

**Only for dry areas without termites.**

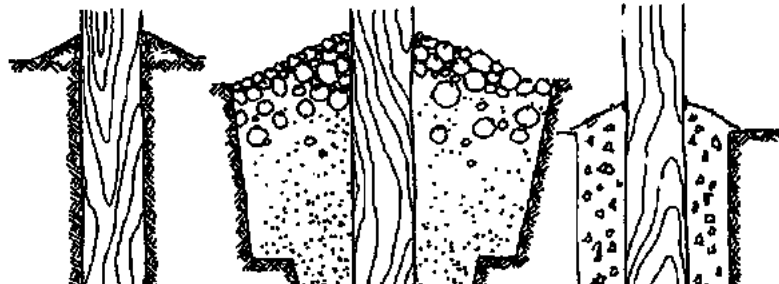
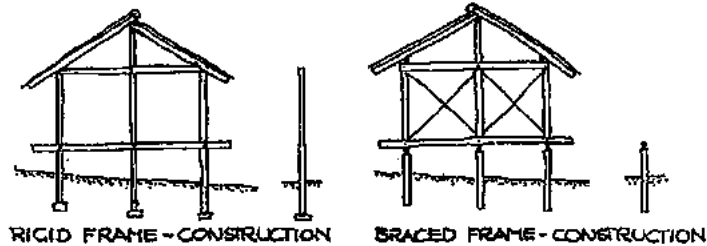



POST IN DRILLED HOLE



POST ON CONCRETE FOOTING

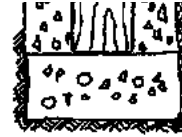

POST ON CONCRETE FOOTING

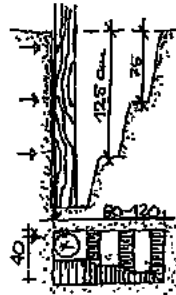

EXCAVATE THE HOLE FOR THE POST IN SUCH A WAY THAT IF POSSIBLE THE POST CAN BE LEANED AGAINST NATURAL SOIL

PROTECTION AGAINST ROT 2 / PROTECTION OF CONSTRUCTION SHEET 3

HOLE FILLED WITH EARTH (NO TOP SOIL)  
 0. SAND AND GRAVEL  
 0. EARTH - GRAVEL - CEMENT - MIXTURE  
 BACKFILL COMPRESSED IN LAYERS.

### Wooden Posts on Concrete Footings (Bibl. 20.05)

Only for dry areas without termites.

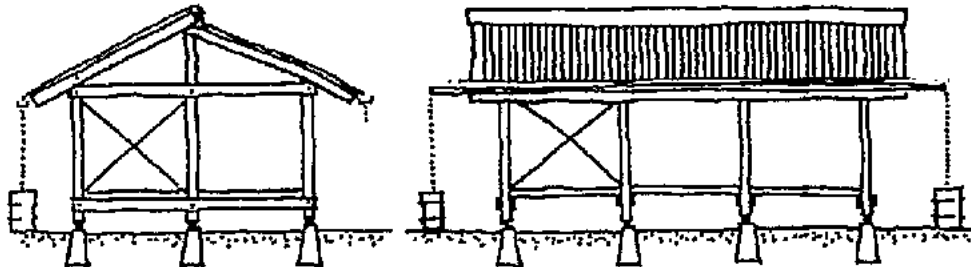

# FRAME - CONSTRUCTION

100/100 — 150/150 CM WOODEN POSTS  
 L 100/200 CM RIGHT-ANGLE PIECE WITH BOLTS

PLACE THE  
 PATTERN ON  
 THE BASE AND  
 INSERT THE  
 BOLTS INTO THE  
 SOFT CONCRETE

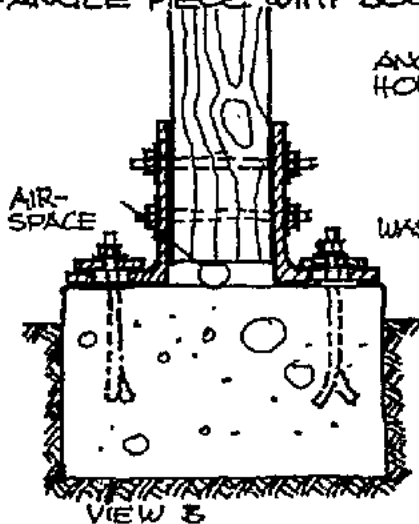
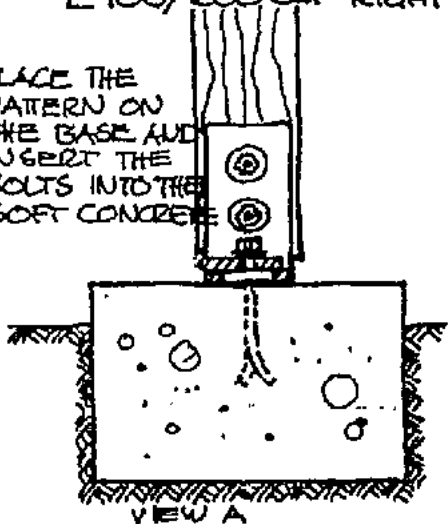

ANCHOR  
 HOLE

WASHER

PLAN  
 VIEW

ANCHOR HOLE LARGE  
 ENOUGH TO COMPENSATE  
 FOR INACCURACIES WHEN  
 THE BOLTS ARE INSERTED  
 INTO THE CONCRETE

WASHER > ANCHOR HOLE

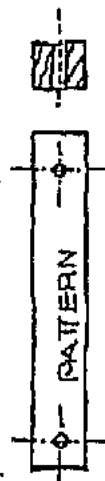

## WOODEN POLES WITH STORMPROTECTION



Ø OR □ POSTS  
 WITH  
 ANCHOR LOOP  
 O.  
 LASHING



ELEVATED  
 FOOTING  
 FOR PRO-  
 TECTION  
 AGAINST  
 MOISTURE



RAIL WITH  
 OUT BOTTOM  
 AS FORM

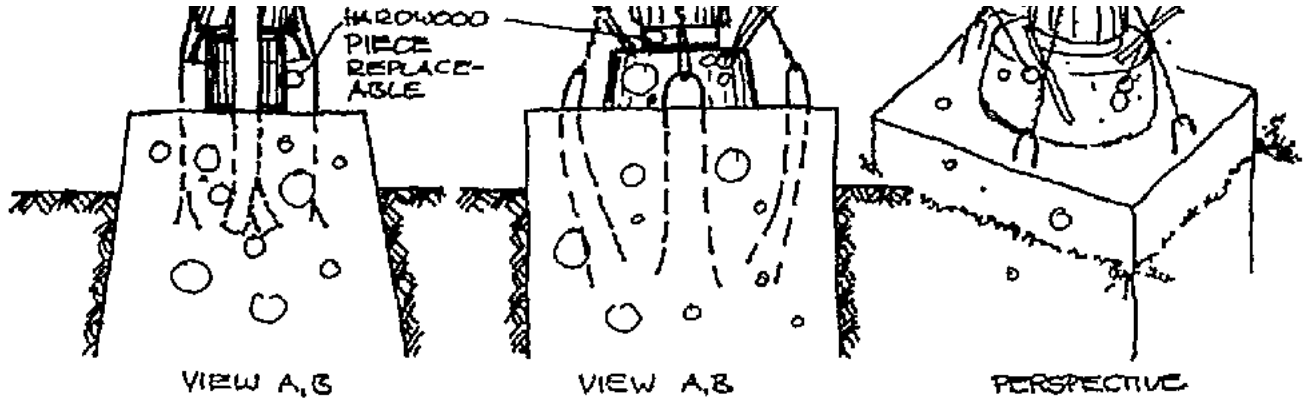

Wooden Posts without Ground Contact (Bibl. 20.05)





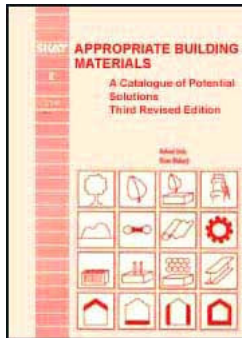



[Home](#) > [ar](#) [cn](#) [de](#) [en](#) [es](#) [fr](#) [id](#) [it](#) [ph](#) [po](#) [ru](#) [sw](#)



 **Appropriate Building Materials: a Catalogue of Potential Solutions (SKAT, 1988, 430 p.)**

  **Examples of floor materials**

-  **Stabilized earth floors**
-  **Burnt clay and concrete components**
-  **Precast concrete ceiling components**
-  **Bamboo floors**
  
-  **Timber floors**
-  **Sulphur concrete floors**

 **Common floor finishes**

**Appropriate Building Materials: a Catalogue of Potential Solutions (SKAT, 1988, 430 p.)**

### Examples of floor materials

#### Stabilized earth floors

#### KEYWORDS:

<b>Special properties</b>	Natural, local material
<b>Economical aspects</b>	Low cost
<b>Stability</b>	Low to medium
<b>Skills required</b>	Experience in soil construction
<b>Equipment required</b>	Rammer or vibrating plate; soil blocks press
<b>Resistance to earthquake</b>	Low
<b>Resistance to hurricane</b>	Low, if water enters the house
<b>Resistance to rain</b>	Low, if water enters the house
<b>Resistance to insects</b>	Low
<b>Climatic suitability</b>	Dry climates
<b>Stage of experience</b>	Experimental

#### SHORT DESCRIPTION:

- **Earth floors are common in all developing countries, especially rural housing: the top soil (with organic matter) is removed and filled up with inorganic soil (clay, sand, gravel) well compacted. Surface coats of a clay - cow dung mix provide some stabilization, but have to**

**be renewed frequently, to be effective.**

- **At Kassel College of Technology, Federal Republic of Germany, a rammed earth floor was developed, using a finely grained soil mix, stabilized with linseed oil: the clay content of the soil should be less than 15 %; no coarse sand or gravel; for 100 litres of dry soil, 3-4 litres of linseed oil (depending on clay content) are diluted with 1-2 litres of water.**

- **Several layers are required (see description overleaf) and the surface can be plain rammed earth in a grid of wooden lathing or small timber blocks embedded in the soil mix. Alternatively, compressed, stabilized soil blocks (made in a soil block press) can be used instead of the timber blocks.**

**Further information: Bibl.21.10.**

**Floor Construction**

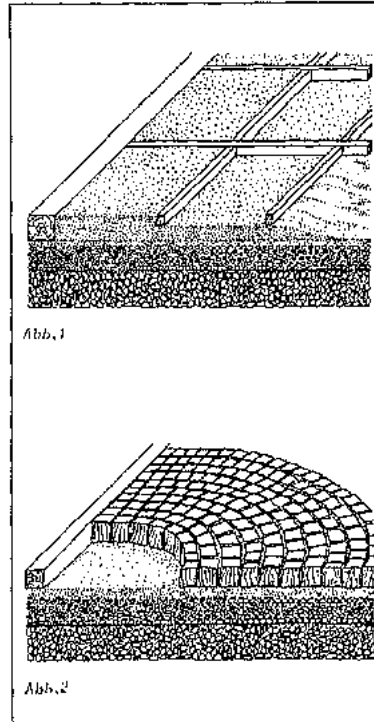

**FIGURE**

- **On a well-compacted, planed surface, coarse gravel (15 cm) is laid to prevent moisture absorption by capillary action.**
- **This is covered by a 3 - 5 cm layer of fine gravel or coarse sand and sealed with a waterproof membrane.**

- **In cold regions, a 10 cm layer of insulating material (eg expanded clay nodules) can be placed before**
- **the first layer of stabilized soil is evenly spread out and tamped with a manual rammer or vibrating plate.**
- **A grid (1.80 x 1.80 m) of sawn timber (10 x 10 cm) is laid on the first layer and filled with the soil mix and tamped.**
- **A grid (30 x 30 cm) of wooden laths (2 x 4 cm) is placed on the second layer and the final layer is filled in and carefully tamped. The top surface is then smoothed with the edge of a trowel under considerable pressure, to get "shiny" appearance.**
- **After several months of hardening, the surface can be treated with a thin coat of hard wax polish, for greater durability and moisture resistance (however, the strong smell may be a problem).**
- **Instead of the last two layers of soil mix, wooden blocks can be laid and the joints carefully filled with the same mix.**
- **Alternatively, stabilized soil blocks, made with a block press (see ANNEX) can be used instead of timber blocks. However, the blocks must be well stabilized (eg with lime or cement) to resist abrasion and moisture penetration.**

### **Burnt clay and concrete components**

#### **KEYWORDS:**

<b>Special properties</b>	Simple prefabrication systems, rapid construction
<b>Economical aspects</b>	Medium to high costs



<b>Stability</b>	Very good
<b>Skills required</b>	Masonry skills and semi-skilled labour
<b>Equipment required</b>	Standard equipment for masonry and concrete work
<b>Resistance to earthquake</b>	Good
<b>Resistance to hurricane</b>	Good
<b>Resistance to rain</b>	Good
<b>Resistance to insects</b>	Good
<b>Climatic suitability</b>	All climates
<b>Stage of experience</b>	Experimental

#### **SHORT DESCRIPTION:**

- **These prefabrication techniques for ceilings were designed to achieve strong and durable constructions of qualities approaching those of reinforced concrete, but with considerably less cement.**
- **Ceilings and roofs can be constructed without or with considerably less timber formwork, than is required for standard reinforced concrete constructions. Saving on timber not only reduces costs, but also helps to conserve the rapidly diminishing forests.**
- **The materials and constructions are capable of withstanding all kinds of destructive agents in the same way as reinforced concrete.**
- **However, the main precondition for the implementation of these techniques is the availability of good quality bricks and tiles, a requirement that may not always be fulfilled by local brick production in rural areas.**

**Further information: Bibl. 00.12, 00.41, 21.03, 21.07, 21.09, 23.12.**

# Reinforced Brick / Tile Panels

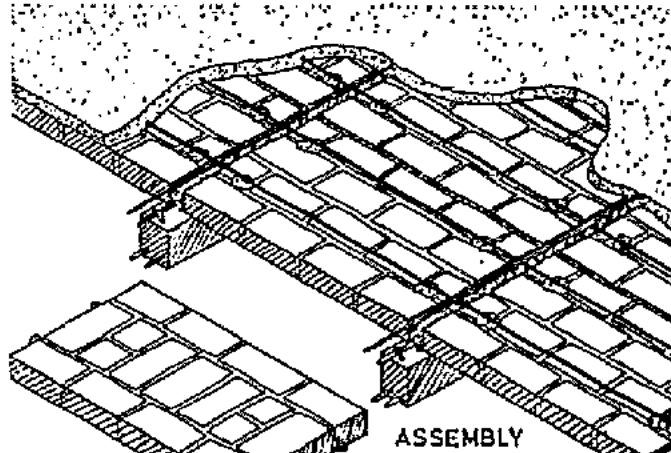
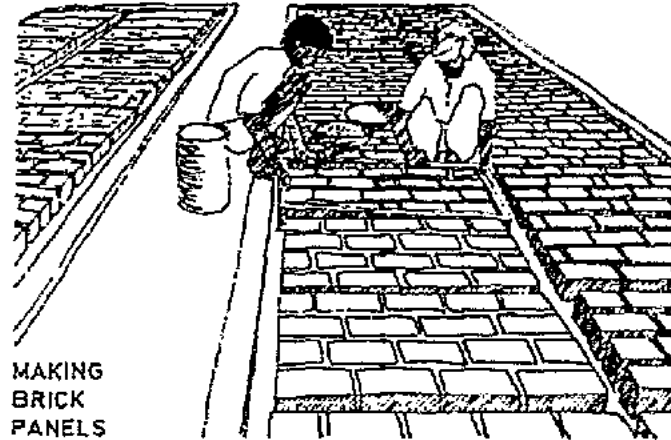

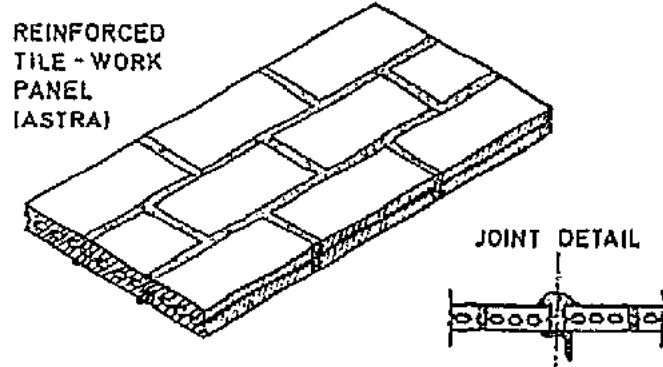
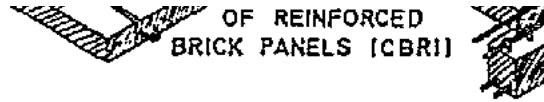

ARCHED PANELS FOR FLAT ROOF OR CEILING

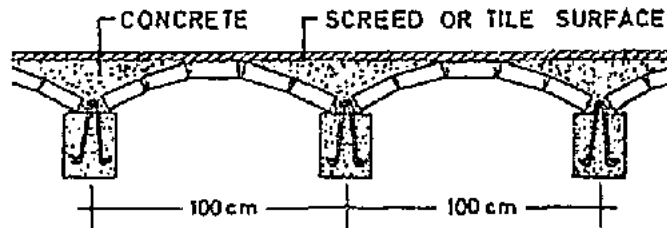

FIGURE

- The brick / tile panels described here were developed in India.

- **In principle, the panels are made by assembling bricks or tiles on an appropriate surface, laying reinforcing rods in the longitudinal joints and bonding the components with mortar. Reinforced concrete joists of relatively small cross-section are precast in lengths corresponding to the roof span. These are placed manually on top of the walls at distances slightly greater than the length of the panels. The joists are propped and the panels arranged in parallel across them. Reinforcing rods are laid along and at right angles to the joints. A 1: 3 (cement: sand) mortar is filled in the joints and concrete spread about 30 mm thick over the panels, thus forming a T-beam structure, with the deck concrete acting as the flange.**
- **The flat panels, developed by the Central Building Research Institute in Roorkee, are made of standard burnt bricks, forming 75 mm thick panels of 560 mm width and lengths of 1040 or 1200 mm.**
- **Similar panels have been developed at ASTRA, Indian Institute of Science in Bangalore. Extruded hollow tiles are used instead of solid bricks, thus reducing the dead load. The tile height of 50 mm also reduces the panel thickness while the tile dimensions of 250 x 125 mm result in panel sizes of 400 x 800 mm and 400 x 1050 mm with 9 and 12 tiles respectively.**
- **Arched panels can also be produced and used for ceilings. They are capable of carrying greater loads than the flat panels, but need more deck concrete to even out the curvature for the floor above.**

### **Structural Clay Joist and Filler Elements**



STRUCTURAL CLAY  
JOIST AND FILLER ELEMENTS



ALTERNATIVE  
CLAMPS

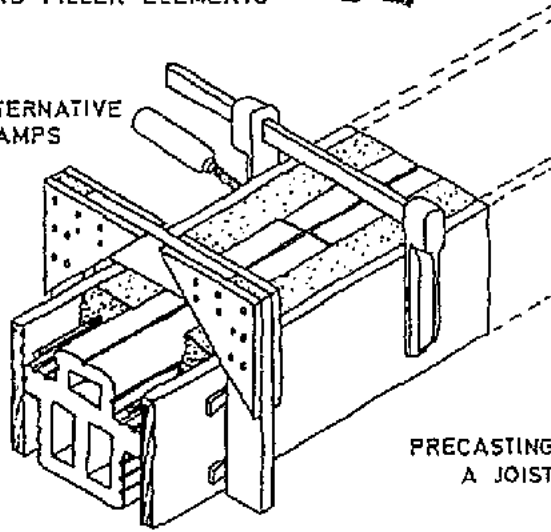

PRECASTING  
A JOIST



CONSTRUCTING  
A CEILING

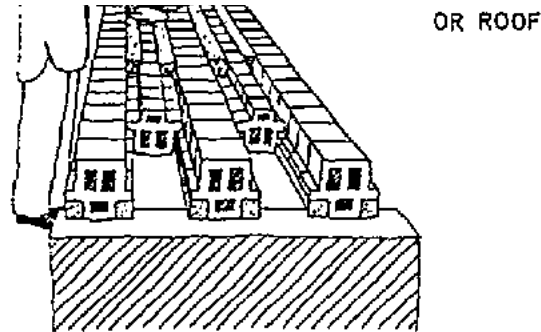

**FIGURE**

- An extruded structural clay unit, which by virtue of its shape is used both as Joist and filler elements, has been developed at CBRI, Roorkee. The dimensions of the unit are 16.5 x 15.0 x 19.0 cm. It has three rectangular cavities, and the outer faces have grooves for better bonding of mortar and concrete.
- The prefabrication of a joist is done by laying the fired clay units end to end on a flat surface, in a row of desired length, with the wider base below, and joined with a 1: 3 (cement: sand) mortar. Two wooden planks, cleaned and oiled are placed on either side and held together with clamps. The gaps between the clay units and planks are filled with concrete, in which reinforcing rods are embedded. The planks can be removed after 45 to 90 minutes, depending on the weather conditions; the joists are water-cured for 7 days and air-cured for 21 days, before use.
- When constructing the ceiling or roof, the joists, which weigh about 80 - 90 kg, are inverted and laid manually in parallel lines, at distances of 30 cm (centre to centre). For rigidity and levelling, they are placed on levelling pads of cement-sand mortar, and temporarily propped where necessary. The structural clay units, with their wider base

below, are laid between the joists as filler units, ensuring that the joints in the joist member and filler units are broken (by using half length units at the ends). The joints and gaps are filled with mortar, reinforcement and concrete, as in the prefabrication of the joists, and the completed slab kept wet for 14 days, before finishing the floor surface.

### Reinforced Concrete - Brick Composite Beams

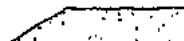
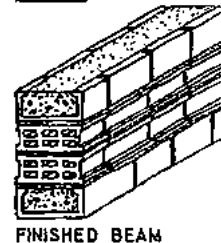
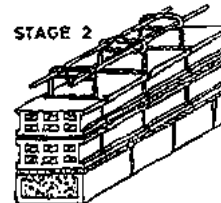
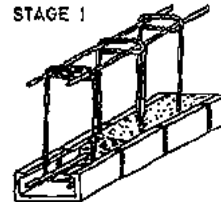

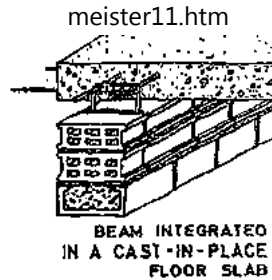

**FIGURE**

- In order to reduce the need for timber formwork, which is becoming increasingly expensive and environmentally unacceptable, in view of the rapidly depleting forests, a substitute for reinforced concrete beams was developed at Chulalongkorn University in Bangkok.
- U-section clay tiles are laid in a row of required length and bonded together with cement-sand mortar, thus forming a channel. Longitudinal steel bars and stirrups are placed in the channel, which is subsequently filled with concrete. One or more layers of structural clay bricks (wetted from all sides) are laid in between the stirrups, forming the centre portion of the beam. The joints are filled with cement-sand mortar. The top compression zone can comprise another row of U-section tiles filled with concrete.
- Alternatively, this top layer (and even the centre portion) can be completed after installing the beam, which is lighter and can be placed manually. The top layer can also be integrated in a cast-in-place floor slab, producing a T-beam structure.
- In addition to the simplicity of construction, the composite beams have been found to cost 11 - 35 % less than reinforced concrete beams of the same dimensions and reinforcement.



**(Source: Bibl. 21.09)**

## **Precast concrete ceiling components**

### **KEYWORDS:**

<b>Special properties</b>	Simple prefabrication and installation
<b>Economical aspects</b>	Medium to high costs
<b>Stability</b>	Very good
<b>Skills required</b>	Semi-skilled labour, carpentry and masonry skills
<b>Equipment required</b>	Formwork (of wood and steel), vibrator
<b>Resistance to earthquake</b>	Good
<b>Resistance to hurricane</b>	Good
<b>Resistance to rain</b>	Good
<b>Resistance to insects</b>	Good
<b>Climatic suitability</b>	All climates
<b>Stage of experience</b>	Practical applications in India and China

### **SHORT DESCRIPTION:**

- **These reinforced concrete components can be precast on the building site without expensive equipment or lifting gear.**
- **They are designed to provide high strength with a minimum volume of concrete, thus requiring only manual operations in production and installation, and reducing cement consumption.**

- **The major advantages of using precast concrete components are the avoidance of shuttering for ceiling construction (apart from a few props) and the speed of installation.**
- **Depending on the costs and availability of cement, these construction methods can be more expensive than non-concrete ceilings, but provide greater strength and durability without special maintenance.**

**Further information: Bibl. 21.01, 21.04, 21.08.**

### **Channel Units (Bibl. 21.04)**

- **The units, developed at the Central Building Research Institute, Roorkee, India, are 13 cm high and 30 or 60 cm wide, while the lengths can vary according to the required span, but not more than 4 m, as greater lengths reduce stiffness and load-bearing capacity.**
- **The moulds can be of timber or steel. The corrugations on the outer sides and the vertical grooves at the ends provide the necessary shear key action.**
- **The mould is oiled, the reinforcement cage placed with 12 mm spacers and concrete filled and compacted with a plate vibrator. The fresh unit is moist cured for 2 days, after which it is demoulded and cured for 12 days, keeping the trough filled with water. A further 14 days of air-curing is needed before installation in the building.**
- **Assembly is possible without props by placing the channel units in parallel on top of the walls, and filling the joints with concrete and a reinforcing rod.**

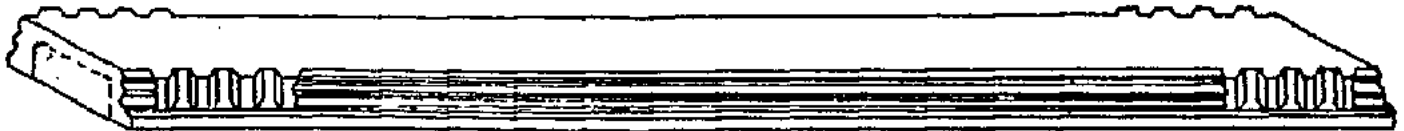
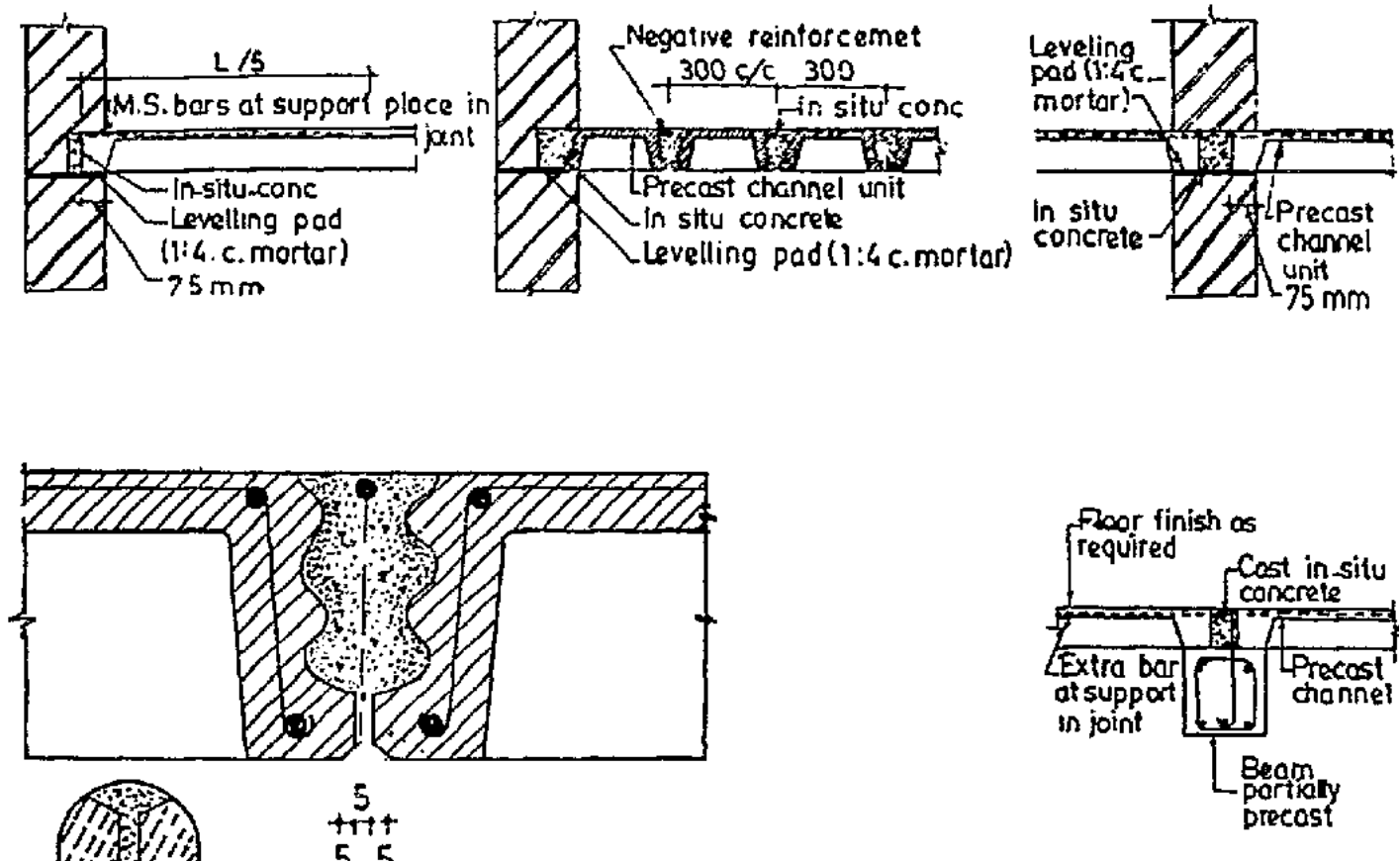

FIG. 1 A CHANNEL UNIT





Ruled joint



V JOINT

## Details of installation

### Details of installation

#### Reinforced Concrete Planks (Bibl. 21.01)

- The system, also developed in India, mainly comprises a 3 cm thick reinforced concrete plank measuring 30 x 145 cm, with a 6 cm thick haunch portion in the centre, and 10 cm wide tapering fillets to strengthen the plank during handling. Joists of 15 x 15 cm cross-section, with stirrups projecting out on the top side, are also precast in simple timber or steel moulds.
- The joists are placed at 150 cm centres and propped at mid-span. The planks are placed over the joists side by side. After fixing reinforcements across the joists, screed is cast in-situ. Once it attains its final strength, the props are removed. No structural deck concrete is required over the planks.

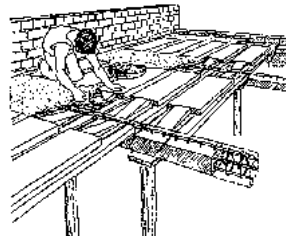

**FIGURE**

The mould...

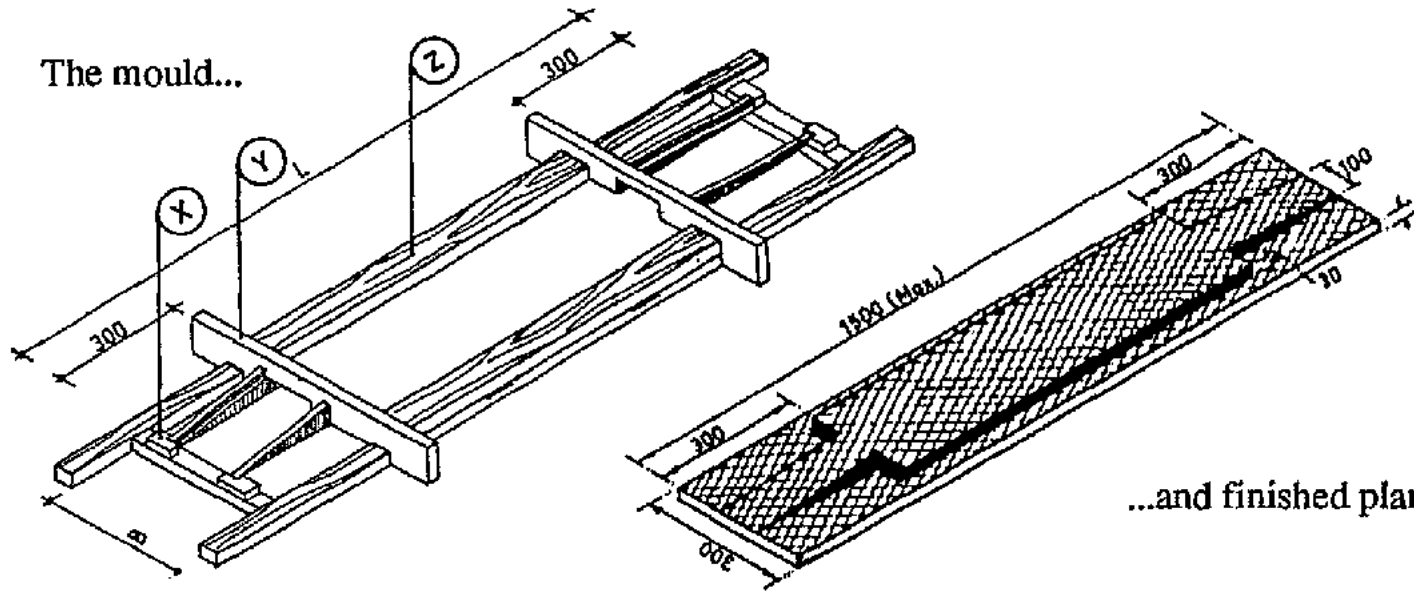

...and finished plank

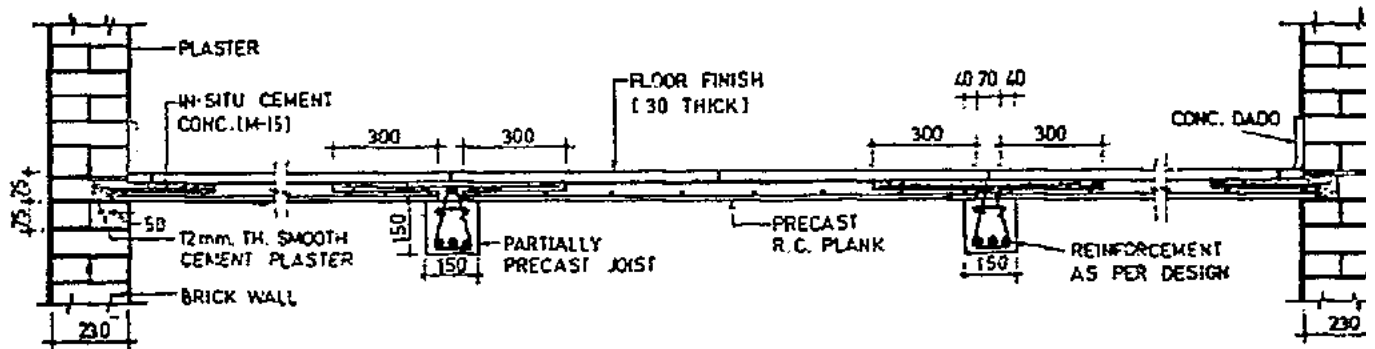

## Details of installation

### Hollow Floor Slabs (Bibl. 21.08)

- **This is a simple method for the on-site-prefabrication of reinforced concrete hollow floor slabs, a technology developed and practised in China 20 - 25 slabs of 333 x 60 x 12 cm can be produced during a normal working day.**
- **The wooden framework is fixed to a cradle-like, (rocking), welded steel substructure. The steel end-pieces with 4 openings define a trapezium-shaped cross-section of the floor slab, so that when finally assembled, the V-shaped gaps between slabs can easily be filled with concrete.**
- **A canvas-like cloth is placed within the formwork to prevent concrete from sticking to it. Reinforcing steel is laid with sufficient distance from the ultimate slab surface. Four steel pipes are pushed lengthwise through the holes in the end-pieces, the concrete is poured and compacted simultaneously, to ensure that no air-pockets develop around the pipes. The concrete is cast very dry so that it will not collapse when the pipes are removed.**
- **After completing the concreting phase, 3 or 4 men turn the entire cradle-like structure in one continuous movement, such that the freshly made slab lands directly on the ground, covered with loose sand to prevent sticking. The pipes are gently tapped and then pulled out one by one with an electrically-driven winch.**
- **The formwork is removed and immediately reassembled for the production of the next slab. One complete production cycle takes about 15 minutes with 3 - 4 men.**

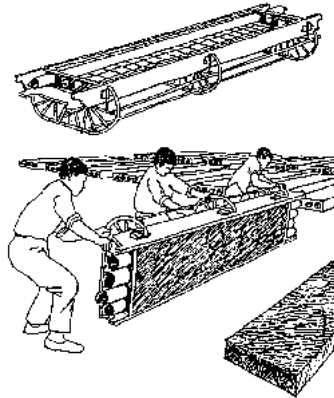

**Turning over the mould**

## Bamboo floors

### KEYWORDS:

<b>Special properties</b>	Light, flexible, replaceable
<b>Economical aspects</b>	Low cost
<b>Stability</b>	Medium to good
<b>Skills required</b>	Traditional skills
<b>Equipment required</b>	Tools for cutting and splitting bamboo
<b>Resistance to earthquake</b>	Good
<b>Resistance to hurricane</b>	Medium to good
<b>Resistance to rain</b>	Medium
<b>Resistance to insects</b>	Low

<b>Climatic suitability</b>	Warm humid regions
<b>Stage of experience</b>	Traditional

### **SHORT DESCRIPTION:**

- **Bamboo floors are common in bamboo structures and to some extent in timber framed houses.**
- **The simplest method is to lay bamboo culms in parallel, tied to the supporting framework. However, this gives a very uneven surface and can be uncomfortable to sit or stand on for long.**
- **More even surfaces are achieved by using bamboo board (split and flattened culms), or by cutting bamboo strips, which are woven into boards.**
- **Since bamboo components cannot be joined together without leaving gaps, the floors are well ventilated, improving the indoor climate and preventing moisture accumulation.**
- **Precautionary measures are required to minimize attack by biological agents and fire (see PROTECTIVE MEASURES).**

**Further information: Bibl. 13.02, 13.04, 13.05, 13.09, 13.10, 13.12, 13.13.**

**Bamboo Floors (after Dunkelberg, Bibl. 13.02)**

## **Whole culms**

## **Bam**





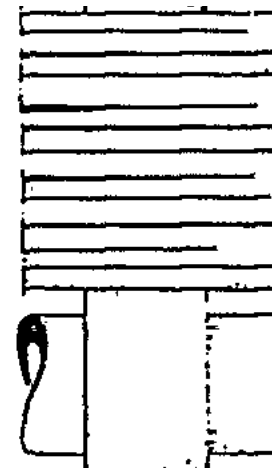
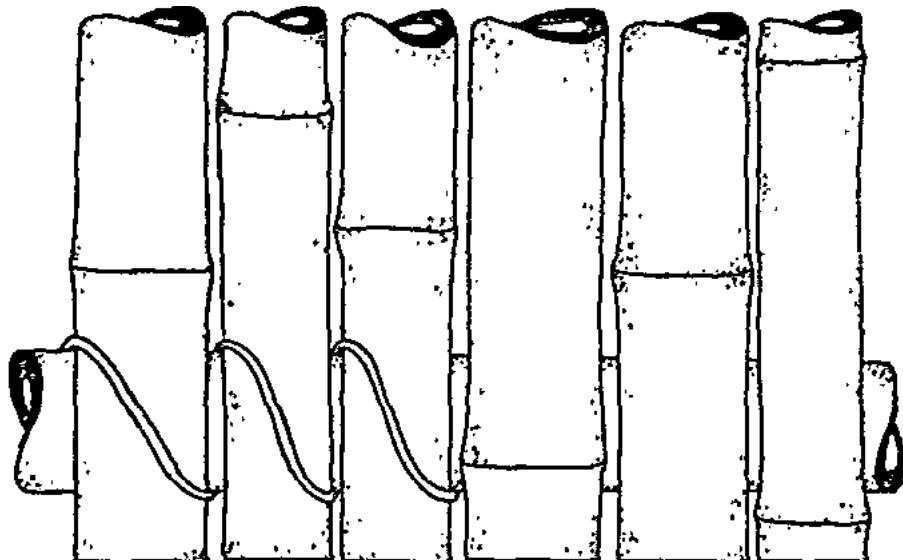

VERTIKALSCHNITT  
VERTICAL SECTION

GEBUNDEN  
TIED

LOSE VERLEGT  
LOOSE LAID

VERTIKALSCHNITT  
VERTICAL SECTION

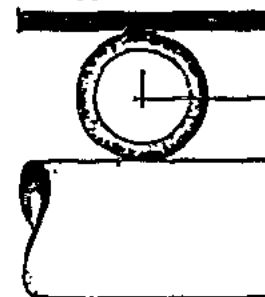
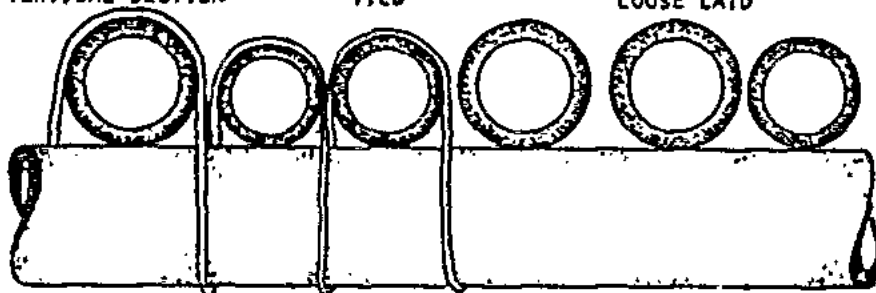

## Bamboo floors made of woven bamboc

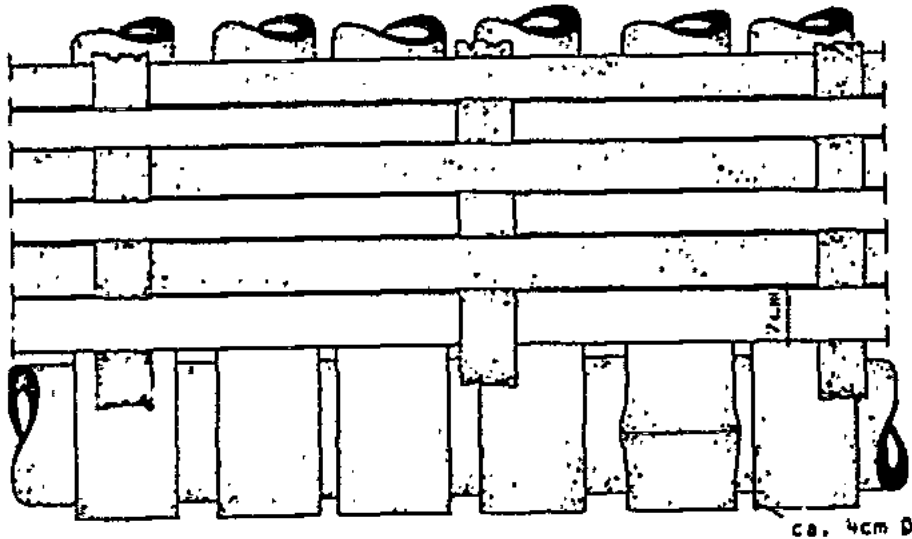

VERTICALSCHNITT  
VERTICAL SECTION

BAMBUSLEISTEN

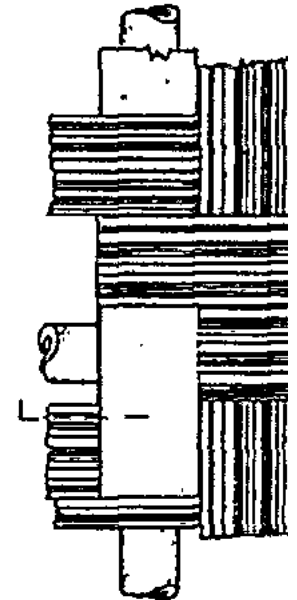

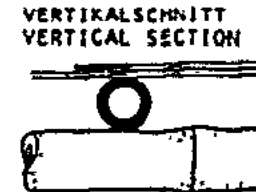
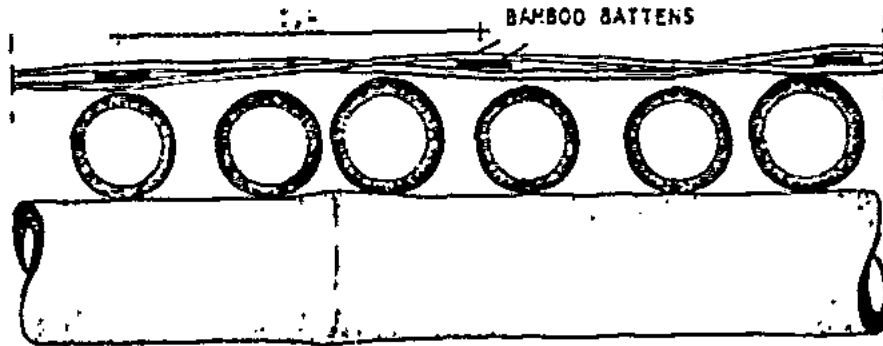

**Whole culms; Bamboo board (flattened culms); Bamboo floors made of woven bamboo strips**

## Timber floors

### KEYWORDS:

<b>Special properties</b>	Suitable for prefabrication, quick assembly
<b>Economical aspects</b>	Medium costs
<b>Stability</b>	Good
<b>Skills required</b>	Carpentry skills
<b>Equipment required</b>	Carpentry tools
<b>Resistance to earthquake</b>	Good
<b>Resistance to hurricane</b>	Low to medium
<b>Resistance to rain</b>	Low to medium
<b>Resistance to insects</b>	Low
<b>Climatic suitability</b>	Warm humid climates

<b>Climatic suitability</b>	Warm humid climates
<b>Stage of experience</b>	Standard construction

### **SHORT DESCRIPTION:**

- **Wooden floors are standard constructions in all parts of the world.**
- **They are principally made of wooden planks, nailed onto a sawn timber sub-structure.**

**The smaller the distance between the members of the supporting structure, the stronger the floor or ceiling and the less the vibration and sound transmission, but also the higher the costs (as more timber is needed).**

- **Protective measures against biological agents and fire are essential (see section on PROTECTIVE MEASURES).**
- **The illustrations on the next three pages are taken from the excellently illustrated UNIDO**

**Manual on Wooden House Construction, which was prepared by the Instituto de Pesquisas Tecnologicas (IPT), Sao Paulo, Brazil, for a self-help community building project at**

**Coroados, Manaus, under a contract with the Housing Society for the Amazon State (SHAM).**

**Further information: Instituto de Pesquisas Tecnologicas (IPI) do Estado de Sao Paulo, S.A., P.O. Box 7141, 05508 Sao Paulo, Brazil; Bibl. 14.22.**

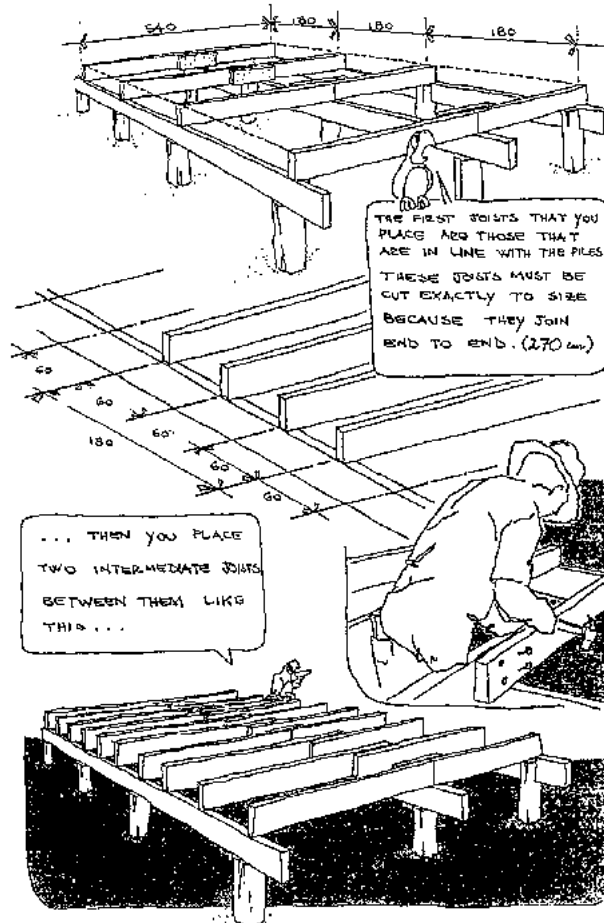

### Timber Floor Construction (Bibl. 14.22)

AND FINALLY YOU CAN PLACE THE FLOOR BOARDS...

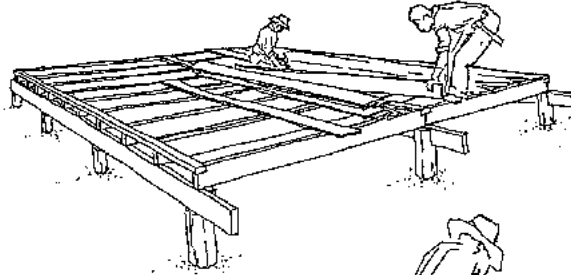

THE FLOOR BOARD JOINTS MUST BE VERY TIGHT. TO NAIL THE FLOOR BOARDS USE THREE NAILS PER JOINT IN EACH OF THE BOARDS, ON THE LINES OF THE JOINTS.

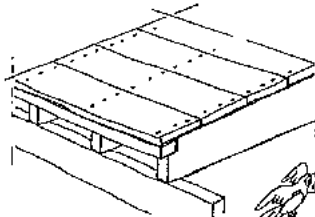

VERIFY THAT THE EDGES OF THE FLOOR PLATFORM ARE FACED AND WELL FINISHED.

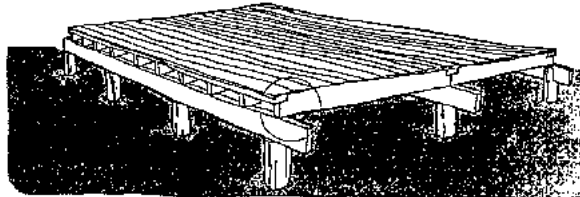

**FIGURE****Sulphur concrete floors****KEYWORDS:**

<b>Special properties</b>	Strong, durable and water-resistant
<b>Economical aspects</b>	Medium costs
<b>Stability</b>	Very good
<b>Skills required</b>	Experience in use of sulphur
<b>Equipment required</b>	Conventional mixer equipped with a heater
<b>Resistance to earthquake</b>	Good
<b>Resistance to hurricane</b>	Good
<b>Resistance to rain</b>	Good
<b>Resistance to insects</b>	Good
<b>Climatic suitability</b>	All climates
<b>Stage of experience</b>	Experimental

**SHORT DESCRIPTION:**

- **Sulphur concrete floors comprise elemental sulphur and an inorganic aggregate, usually coarse and fine sand (see section on Sulphur).**
- **The sulphur concrete can either be poured in situ or precast as floor tiles of any appropriate shape.**
- **In situ constructions require skill, experience and speed, as the molten sulphur hardens**

**rapidly on cooling.**

• **Sulphur concrete tiles can be laid in sand beds in the same way as fired clay, concrete and other floor tiles. Further information: Alvaro Ortega, Research Consultant, 3460 Peel Street, Apt. 811, Montreal P.Q., Canada; Bibl. 18.01, 18.04, 18.05, 18.06, 18.07.**

### **Experimental Sulphur Concrete Floors**

**Sulphur concrete topping on bamboo-polyurethane ceiling construction, developed by Christopher Alexander for a low-cost housing scheme in Peru (PREVI Proyecto Experimental de Vivienda, international competition sponsored by the United Nations, Peruvian Government and Housing Bank, 1969). (Bibl. 18.01)**

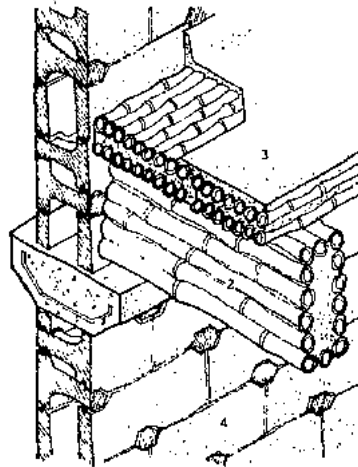

**FIGURE**



## Common floor finishes

### KEYWORDS:

<b>Special properties</b>	Medium to high standard durable flooring
<b>Economical aspects</b>	Medium to high costs
<b>Stability</b>	Very good
<b>Skills required</b>	Special skills
<b>Equipment required</b>	Standard construction equipment
<b>Resistance to earthquake</b>	Good
<b>Resistance to hurricane</b>	Good
<b>Resistance to rain</b>	Good
<b>Resistance to insects</b>	Good
<b>Climatic suitability</b>	All climates
<b>Stage of experience</b>	Standard constructions

### SHORT DESCRIPTION:

• The functions of floor finishes, which are the finishing layers over or covering of the structural floor, have been aptly summarized in Bibl. 21.11 as follows:

- to have a high wearing resistance and long life span;
- to provide a safe, non-slip and easy-to-clean surface of the floor;
- to increase the structural floor's fire-, insect- and termite resistance;
- to reduce sound transmission and to provide insulation;
- to contribute to the aesthetic effect of the interior of a building;
- to have a high enough degree of flexibility; so as not to be affected by slight shrinkage,

**settlement or thermal movement in the structural floor (or sub-floor).**

• Some common floor finishes are illustrated on the following pages, showing a variety of good construction details.

• Since in developing countries a number of activities (eg food preparation, cooking, playing games, meeting friends) take place outdoors (on verandahs, in courtyards, on rooftops, etc.), an example of verandah floor construction is also shown. Further information: Bibl. 00.55, 21.11.

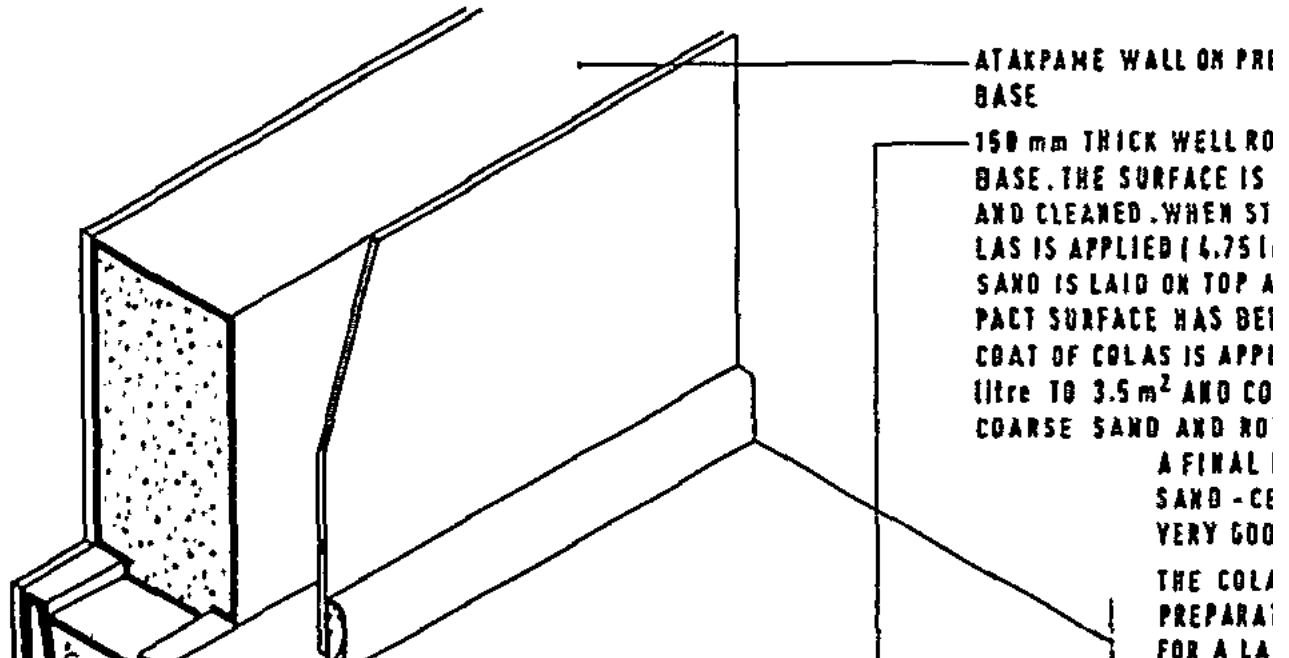

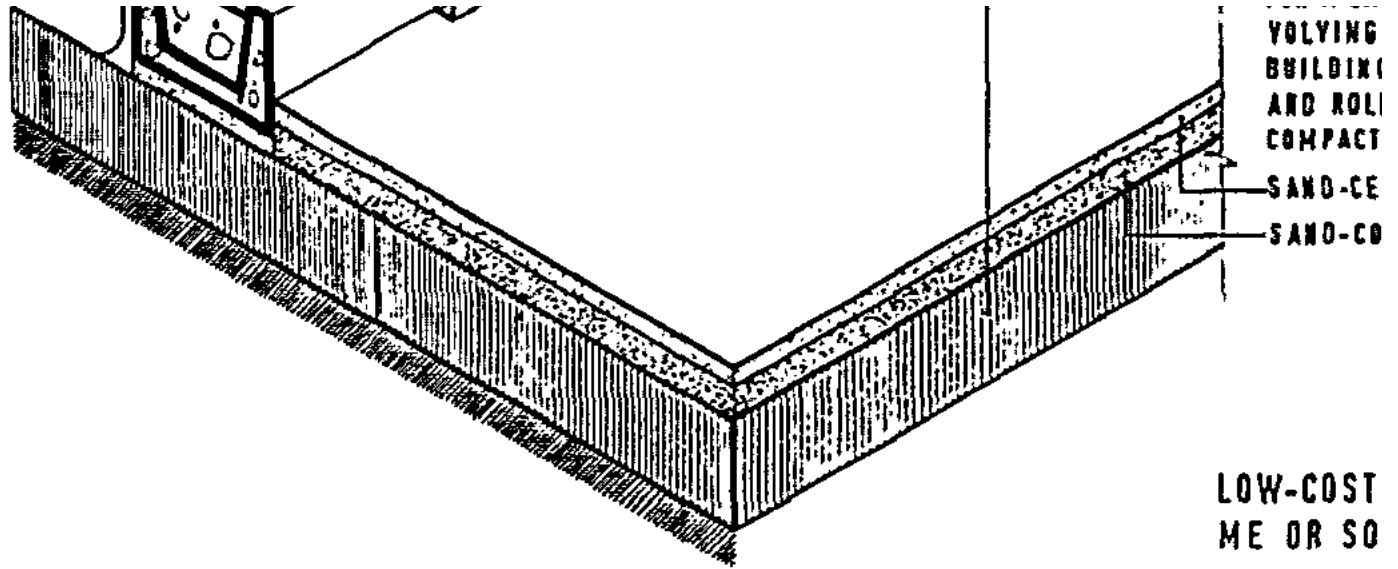

LOW-COST  
ME OR SO

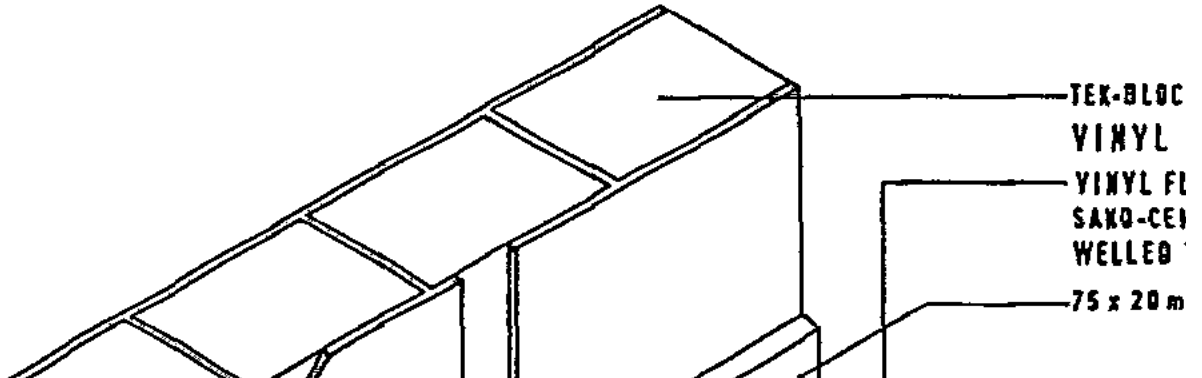

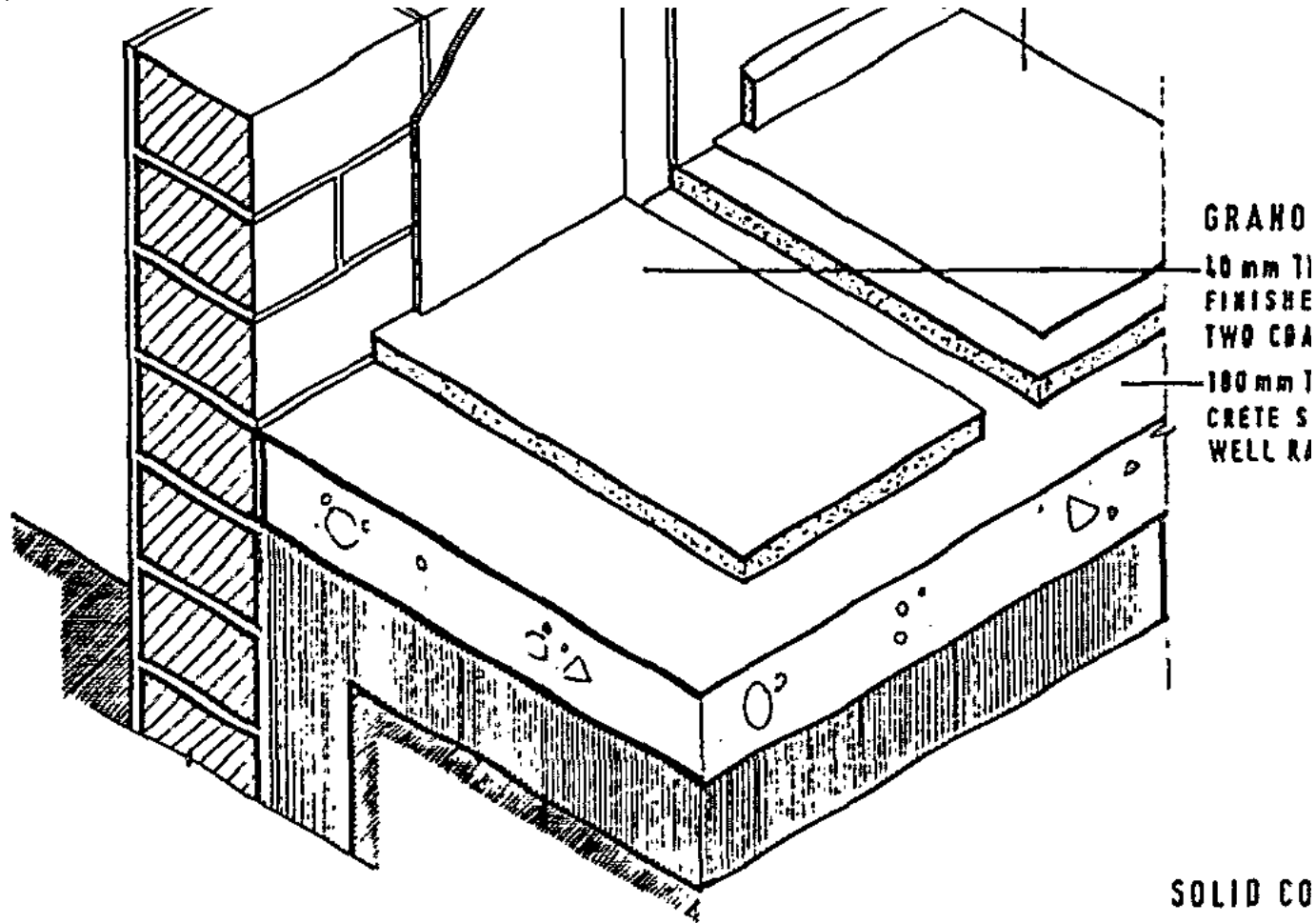

GRAND  
10 mm T1  
FINISHE  
TWO CBA  
180 mm T  
CRETE S  
WELL RA

SOLID CO

### Floors and Floor Finishes (Bibl. 21.11)

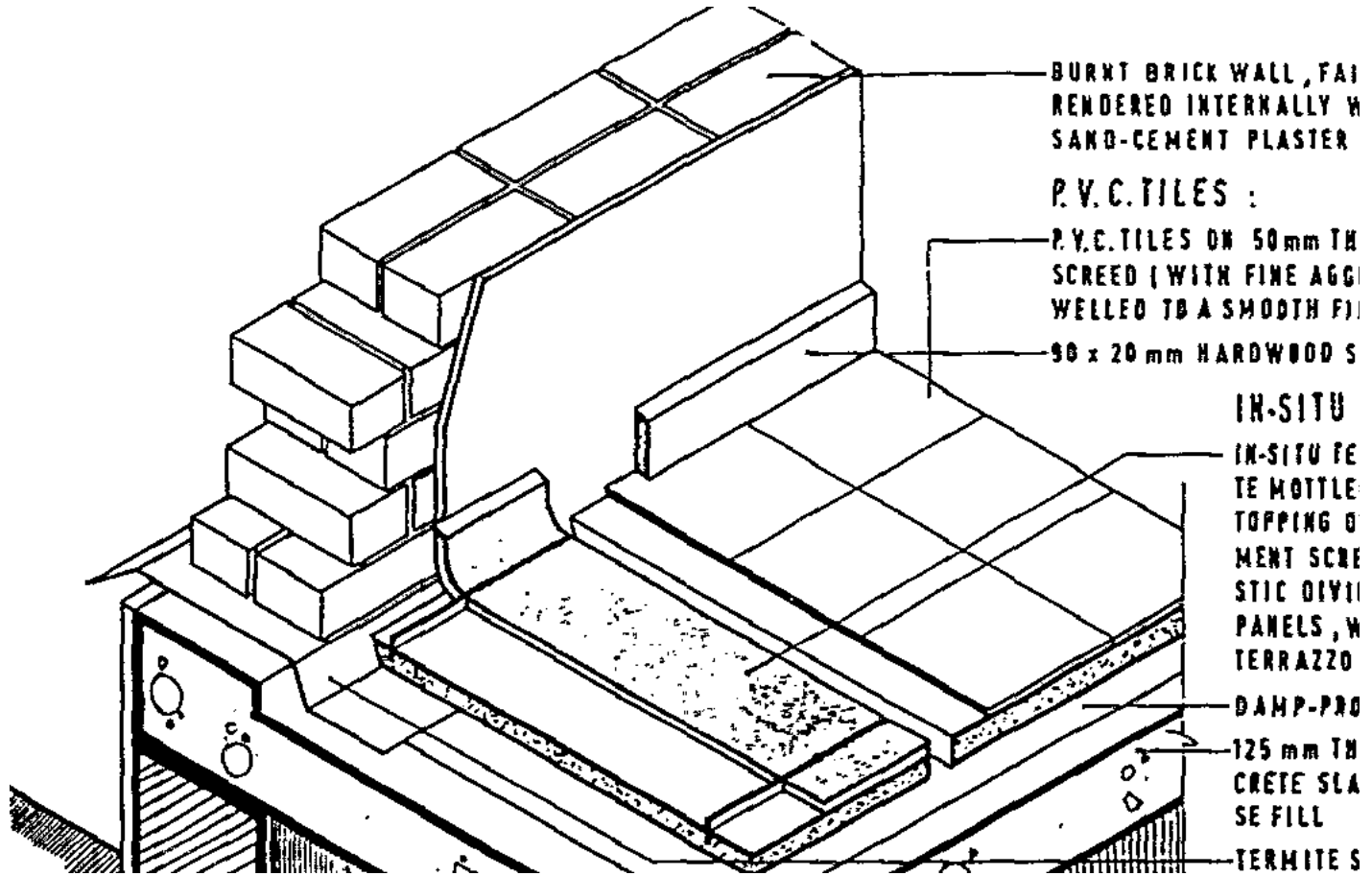

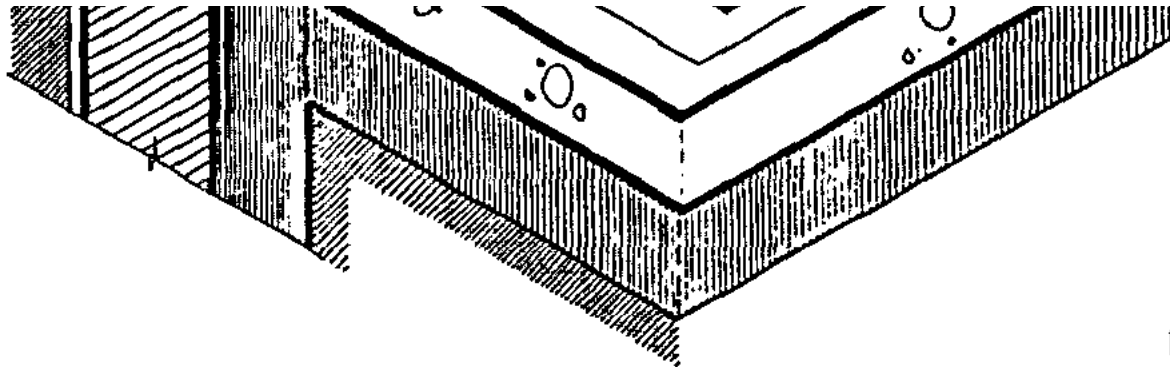

SAME TIM  
 COURSE  
 THIS FLOOR  
 FOR AREA:  
 TIONS AND  
 MITES.

SUSPENDED  
 CRETE FLOOR

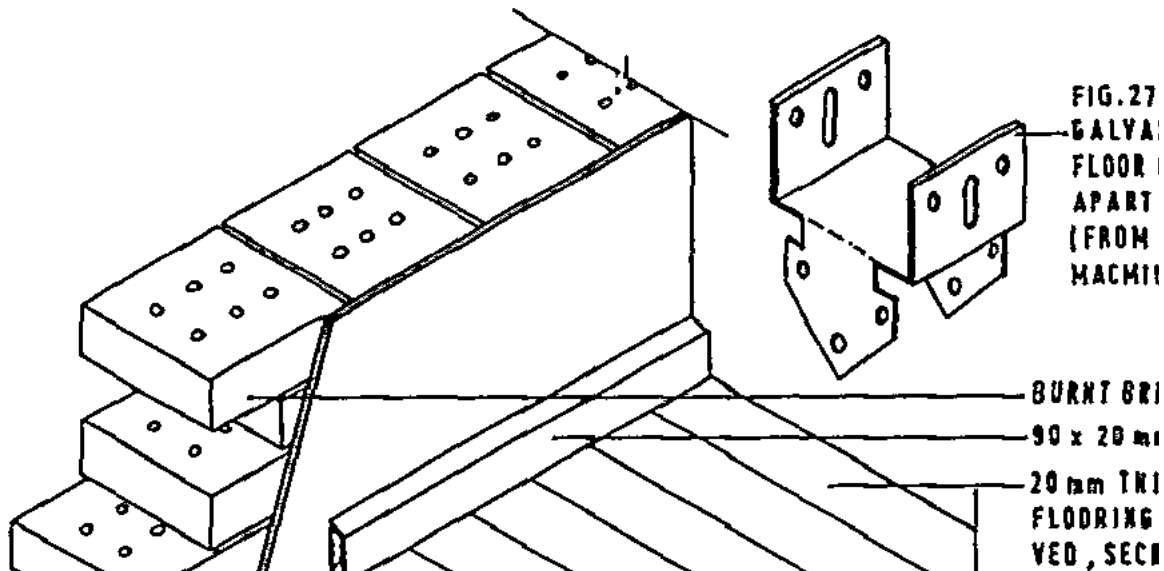
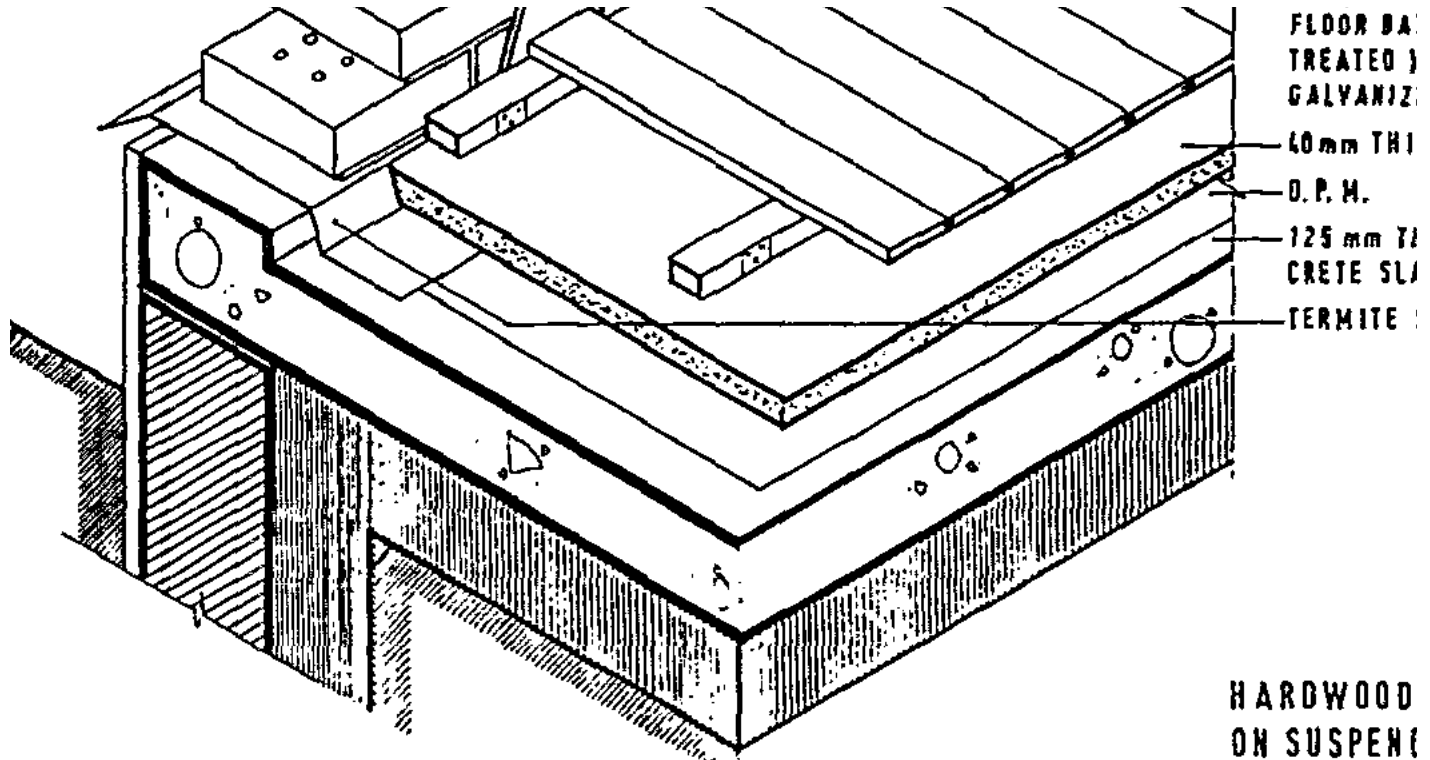

FIG. 27  
 GALVA  
 FLOOR  
 APART  
 (FROM  
 MACHIN

BURNT BR  
 90 x 20 ml  
 20 mm TH  
 FLOORING  
 VED, SECH



FIGURE

### Verandah Floors (Bibl. 00.55)

- The construction of a verandah floor differs from that of an indoor floor in three ways:

- Verandah floors are built with a small slope (about 1 %) towards the outside, so that rainwater can run off quickly (a).
- A projecting outside edge (b) is provided (2 or 3 cm are sufficient) to prevent the development of cracks, which would otherwise soon appear along the edge.
- Expansion gaps, filled with wet sand (c), are constructed to accommodate thermal movement caused by direct exposure to the sun.

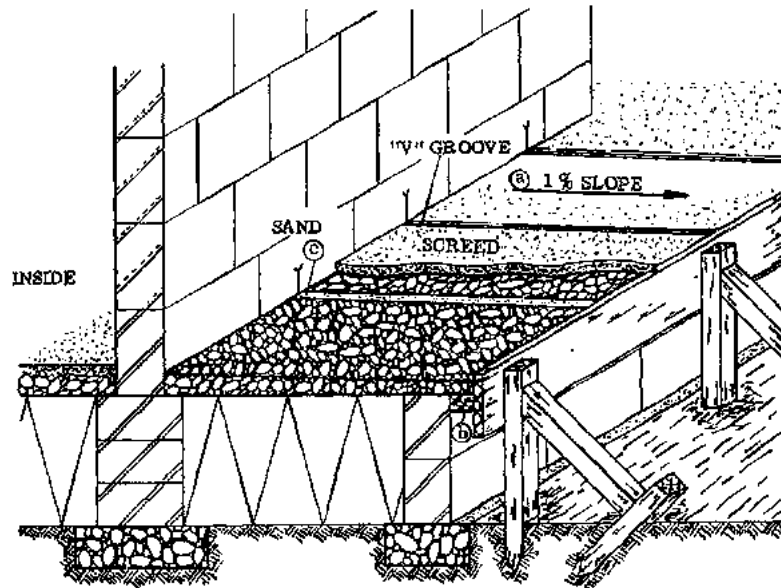

FIGURE



20/10/2011



meister11.htm

