



➔  **Small-Scale Brickmaking (ILO - WEP, 1984, 228 p.)**

 **(introduction...)**

 **ACKNOWLEDGEMENTS**

 **PREFACE**

 **CHAPTER I - INTRODUCTION**

 **I. Purpose and objectives of the memorandum**

 **II. Target audience**

 **III. Comparison between bricks and other building materials**

 **IV. Scales of production covered by this memorandum**

 **V. Content of the memorandum**

 **CHAPTER II - RAW MATERIALS**

 **I. Origin and distribution of raw materials**

 **II. Types of clay**

 **III. Clay testing and significance of results**

 **CHAPTER III - QUARRYING TECHNIQUES**

 **I. Organisation and management of the quarry**

 **II. Methods of winning the clay**

























 **III. Transportation to the works**























 **CHAPTER IV - CLAY PREPARATION**







 **(introduction...)**

 **I. Main clay preparation phases**

 **II. Sorting**

-  **III. Crushing**
-  **IV. Sieving**
-  **V. Proportioning**
-  **VI. Mixing, wetting and tempering**
-  **VII. Testing**
-  **CHAPTER V - SHAPING**
 -  **I. Description of bricks to be produced**
 -  **II. Methods of shaping**
 -  **III. Transportation of bricks to drying areas**
 -  **IV. Skill requirements and training**
 -  **V. Productivity of labour**
-  **CHAPTER VI - DRYING**
 -  **I. Objectives of drying**
 -  **II. Artificial drying**
 -  **III. Natural drying**
 -  **IV. Shrinkage**
-  **CHAPTER VII - FIRING**
 -  **I. Objectives of firing**
 -  **II. Techniques of firing**
 -  **III. Kiln designs**
 -  **IV. Auxiliary equipment**
 -  **V. Fuel**
 -  **VI. Productivity**
 -  **VII. Brick testing**
-  **CHAPTER VIII - MORTARS AND RENDERINGS**















-  **I. Purpose and principles**
-  **II. Mortar types**
-  **III. Mixing and use**
-  **CHAPTER IX - ORGANISATION OF PRODUCTION**
 -  **I. Preliminary investigations**
 -  **II. Infrastructure**
 -  **III. Layout**
 -  **IV. Skill requirements**
-  **CHAPTER X - METHODOLOGICAL FRAMEWORK FOR THE ESTIMATION OF UNIT PRODUCTION COSTS**
 -  *(introduction...)*
 -  **I. The methodological framework**
 -  **II. Application of the methodological framework**
-  **CHAPTER XI - SOCIO-ECONOMIC IMPACT OF ALTERNATIVE BRICK MANUFACTURING TECHNIQUES**
 -  *(introduction...)*
 -  **I. Employment generation**
 -  **II. Total investment costs and foreign exchange savings**
 -  **III. Unit production cost**
 -  **IV. Rural industrialisation**
 -  **V. Multiplier effects**
 -  **VI. Energy requirements**
 -  **VII. Conclusion**
-  **APPENDICES**

-  **APPENDIX I - Glossary of technical terms**
-  **APPENDIX II - Bibliographical references**
-  **APPENDIX III - Institutes from where information can be obtained**
-  **APPENDIX IV - List of equipment suppliers**
-  **QUESTIONNAIRE**
-  **OTHER ILO PUBLICATIONS**
-  **BACK COVER**



[Home](#) > [ar.cn.de.en.es.fr.id.it.ph.po.ru.sw](#)



-  **Small-Scale Brickmaking (ILO - WEP, 1984, 228 p.)**
-   **(introduction...)**
-  **ACKNOWLEDGEMENTS**
-  **PREFACE**
-  **CHAPTER I - INTRODUCTION**
-  **CHAPTER II - RAW MATERIALS**
-  **CHAPTER III - QUARRYING TECHNIQUES**
-  **CHAPTER IV - CLAY PREPARATION**
-  **CHAPTER V - SHAPING**
-  **CHAPTER VI - DRYING**
-  **CHAPTER VII - FIRING**
-  **CHAPTER VIII - MORTARS AND RENDERINGS**
-  **CHAPTER IX - ORGANISATION OF PRODUCTION**
-  **CHAPTER X - METHODOLOGICAL FRAMEWORK FOR THE**

- ❏ **ESTIMATION OF UNIT PRODUCTION COSTS**
- ❏ **CHAPTER XI - SOCIO-ECONOMIC IMPACT OF ALTERNATIVE BRICK MANUFACTURING TECHNIQUES**
- ❏ **APPENDICES**
- 📄 **QUESTIONNAIRE**
- 📄 **OTHER ILO PUBLICATIONS**
- 📄 **BACK COVER**

TECHNOLOGY SERIES

Technical Memorandum No. 6

Prepared under the joint auspices of the International Labour Office and the United Nations Industrial Development Organisation



International Labour Office Geneva

Copyright © International Labour Organisation 1984

Publications of the International Labour Office enjoy copyright under Protocol 2 of the Universal Copyright Convention. Nevertheless, short excerpts from them may be reproduced without authorisation, on condition that the source is indicated. For rights of reproduction or translation, application should be made to the Publications Branch (Rights and Permissions), International Labour Office, CH-1211 Geneva 22, Switzerland. The International Labour Office welcomes such applications.

ISBN 92-2-103567-0**ISSN 0252-2004*****First published 1984******Third impression 1990***

The designations employed in ILO publications, which are in conformity with United Nations practice, and the presentation of material therein do not imply the expression of any opinion whatsoever on the part of the International Labour Office concerning the legal status of any country, area or territory or of its authorities, or concerning the delimitation of its frontiers. The responsibility for opinions expressed in signed articles, studies and other contributions rests solely with their authors, and publication does not constitute an endorsement by the International Labour Office of the opinions expressed in them. Reference to names of firms and commercial products and processes does not imply their endorsement by the International Labour Office, and any failure to mention a particular firm, commercial product or process is not a sign of disapproval.

ILO publications can be obtained through major booksellers or ILO local offices in many countries, or direct from ILO Publications, International Labour Office, CH-1211 Geneva 22, Switzerland. A catalogue or list of new publications will be sent free of charge from the above address.

The World Employment Programme (WEP) was launched by the International Labour Organisation in 1969, as the ILO's main contribution to the International Development Strategy for the Second United Nations Development Decade.

The means of action adopted by the WEP have included the following:

- short-term high-level advisory missions;
- longer-term national or regional employment teams; and

- a wide-ranging research programme.

Through these activities the ILO has been able to help national decision-makers to reshape their policies and plans with the aim of eradicating mass poverty and unemployment.

A landmark in the development of the WEP was the World Employment Conference of 1976, which proclaimed inter alia that "strategies and national development plans should include as a priority objective the promotion of employment and the satisfaction of the basic needs of each country's population". The Declaration of Principles and Programme of Action adopted by the Conference will remain the cornerstone of WEP technical assistance and research activities during the 1980s.

This publication is the outcome of a WEP project.





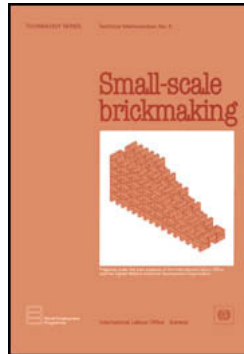



[Home](#) > [ar](#) [cn](#) [de](#) [en](#) [es](#) [fr](#) [id](#) [it](#) [ph](#) [po](#) [ru](#) [sw](#)



Small-Scale Brickmaking (ILO - WEP, 1984, 228 p.)

CHAPTER VII - FIRING

-  **I. Objectives of firing**
-  **II. Techniques of firing**
-  **III. Kiln designs**
-  **IV. Auxiliary equipment**
-  **V. Fuel**
-  **VI. Productivity**
-  **VII. Brick testing**

Small-Scale Brickmaking (ILO - WEP, 1984, 228 p.)

CHAPTER VII - FIRING

I. Objectives of firing

The firing of green bricks changes their physical structure and gives them good mechanical properties and resistance to slaking by water. If carried out properly, the firing process should minimise the occurrence of the following problems:

- the splitting of bricks due to the incomplete removal of moisture before firing;**
- Low strength bricks due to insufficiently hard firing;**
- Slaking by water, due to inadequate control of the firing temperature;**
- Bricks fused together, melted on one face, or distorted by the load imposed by other bricks on top; these problems are caused by too high a temperature;**
- Variety of sizes of fired bricks although the green bricks were of the same size; this is caused by temperature variations between different parts of the kiln;**
- Fine cracking over brick surfaces resulting from a too rapid temperature change, either during heating or cooling, or from condensation of water vapour from heated bricks on to cooler bricks(47);**
- Local cracking over hard lumps or stones mixed in the clay. These inclusions should have been removed during clay preparation, although rapid changes of temperature may have aggravated the problem;**
- Black cores in bricks: these are not necessarily detrimental if they are due to the presence of carbon although the latter ought to have been burnt up as a contributory fuel in the interest of cost reduction (48). Black cores may also be due**

to iron in the reduced, low valency ferrous form. Both causes may be remedied by providing sufficient oxygen (e.g. by leaving adequate paths for the flow of air between the bricks and through the kiln(47)). An opening material may also need to be mixed in the body;

- Bloating: cracked blisters appear on the surface of the bricks as a result of the pressure of gases produced after vitrification has commenced; holding the temperature steady at an earlier stage could allow the gases to diffuse out while the body is still permeable. The problem may also be alleviated by incorporating an opening material in the clay;

- Limebursting: this problem may be solved by removal or grinding of pieces of limestone, or in some cases, by adding salt(49). Alternatively, the quicklime formed within the brick may be dead burnt by heating to approximately 1,100 °C (50);

- Efflorescence and sulphate attack of cement-based mortars and renderings: this problem may be reduced by harder firing, as an alternative to other methods and precautions (see Chapter IV);

- Scum on brick surfaces may be minimised by preventing condensation of products of combustion on cold, green bricks.

II. Techniques of firing

Whatever system of firing is used, it is recommended that a low heat be first applied to the green bricks in order to drive off any residual moisture. This should continue until no more steam is evolved. This part of the heating is known as water-smoking. The completion of this firing stage may be simply tested by inserting a cold iron bar into a space purposely left between the bricks in the kiln, and by withdrawing it after only a few

seconds. Condensation on the bar indicates that steam is still being evolved, and low heat should be continued until no condensation is found on the cold bar after re-insertion. This could take a whole week in some cases and needs plenty of air through the kiln.

Once water-smoking is complete, a rate of rise of temperature of 50 °C per hour may be safe in fully - controlled kilns, which are outside the scope of this memorandum. At the critical temperatures (e.g. quartz inversion) the rate can be temporarily reduced to avoid problems. In more simple kilns, the heating rate should be slower partly because of the lack of precise temperature control and partly because of the impossibility of getting enough fuel burning in some kiln designs. Although a slow rate of heating is safer, faster rates involve less heating time, lower heat losses and, therefore, lower costs. The optimal heating rate is that which requires the shortest heating schedule while yielding a product of satisfactory quality. A maximum of two weeks may be needed for the whole firing process.

Maximum temperatures with little air should be held for at least several hours. A whole day may be needed with some kilns with poor heat distribution in order to ensure a maximum yield of good quality bricks. During this firing stage, known as the "soaking" stage, the heat diffuses through the kiln, various chemical reactions take place and a glassy material is formed. Once the soaking is complete, the heat source may be removed.

The cooling rate should not be too rapid. In practice, natural cooling within the large mass of thousands of bricks, with limited air flow, is satisfactory. Cooling may take a whole week. More air may be allowed in once lower temperatures are reached in order to speed up cooling.

III. Kiln designs

In general, large kilns are more economical on the use of fuel than small kilns as less heat is lost through the proportionally smaller outside area of the kiln. Thus, separate teams of

brickmakers may use the same large kiln on a co-operative basis, and thus benefit from lower firing costs.

There is a wide variety of kiln types and sizes. These may be split into two major groups: the intermittent kilns and the continuous kilns.

Intermittent kilns are filled with green bricks which are first heated up to the maximum temperature and then cooled before they are drawn out from the kiln. Thus, the kiln structure is also heated during the process.

Consequently, all the heat within the bricks and kiln is lost into the atmosphere during cooling. Intermittent kilns are very adaptable to changing market demands, but are not the most fuel efficient. They include the clamp, scove, scotch and draught kilns.

The continuous kilns have fires alight in some part of them all the time. Fired bricks are continuously removed and replaced by green bricks in another part of the kiln which is then heated. Consequently, the rate of output is approximately constant. The continuous group of kilns includes various versions of the Hoffmann kiln, including the Bull's trench, zig-zag and high draft kilns, and the tunnel kiln. The latter is a capital-intensive, large-scale continuous kiln, which is outside the scope of this memorandum.¹ Continuous kilns utilise heat from the cooling bricks to pre-heat green bricks and combustion air, or to dry bricks before they are put into the kiln. Consequently, continuous kilns are economical in the use of fuel.

¹ In the tunnel kiln, bricks stacked on heat-resistant trolleys or cars are subjected to increasingly hotter temperatures, then cool off before leaving the tunnel.

III.1 The clamp

The clamp is the most basic type of kiln since no permanent kiln structure is built. It consists essentially of a pile of green bricks interspersed with combustible material. Normally, the clay from which the bricks are moulded also includes fuel material. The clamp kilns were commonly used in the United Kingdom. Some of these, containing one and a quarter million bricks, are still used for the production of bricks of various colours and textures.

It is possible to use a variety of burnable waste materials in brick clays (e.g. sifted rubbish, small particles of coke, coal dust with ashes, breeze). In countries where timber is produced, large quantities of sawdust may be mixed with clay before firing. This will reduce the expenditure on the main fuel for burning the bricks. Waste materials should be of relatively small size and should not exceed in weight 5 to 10 per cent of the total mixture. Otherwise, the clay will become difficult to mould or the finished product may become too weak or too porous. Furthermore, the added fuel material should be thoroughly mixed with the clay.

A flat, dry area of land is first chosen, and a checkerwork pattern of spaced out, already burnt bricks laid down over an area of approximately 15 m by 12 m. Fuel in the form of coke, breeze or small coal² is then spread between the checkerwork bricks, covering the latter with a layer at least 20 cm thick. Dry, green bricks are next closed-laid on edge upon this fuel bed.

² Coke or breeze is generally used in clamp kilns in the United Kingdom. Small coal is used in a number of developing countries, such as Zambia (51).

A clamp is generally made up of approximately 28 layers of bricks. Its sides are sloped for stability (see figures VII.1 and VII.2). Three or four holes¹ at the base of one of the clamp walls are formed in order to allow the initial ignition of the fuel bed. Two courses of already fired bricks are next laid on top of the green bricks for insulation purposes. Fired

bricks are also laid against the sloping sides of the clamp as it progresses. Sometimes, a second thin bed of fuel is laid at a higher level in the clamp(51).

1 These holes are known as the "eyes" of the clamp.

Once several metres of the length of the clamp have been built up, the fuel bed may be ignited with wood stuffed into the eyes of the clamp. The latter are bricked up with loosely placed burnt bricks once the fuel bed is alight. As the fire advances, more green bricks are built into the clamp.

During burning, the heat rises through the bricks above, fumes and sometimes smoke leaving the top of the clamp. The rate of burning is not easily controlled and depends upon several factors, including wind strength and direction. Some wind protection with screens can help control the temperature. Ventilation, and hence burning rate, can also be controlled, to some extent by an adjustment of the burnt brick covering the top of the clamp. For example, these bricks may be spaced out or removed in order to speed up the firing of the bricks in a given area. Conversely, they may be tightened up or covered with ashes in order to slow down the burning rate. It is desirable to have the fire advancing with a straight front at a steady rate. Bricks close to the edges of the clamp will tend to be underfired as a result of higher heat losses. This may be partially rectified by placing a little more fuel near the edges of the clamp. Extra fuel may also be spread between the top bricks during firing.

The firing process is indicated by the sinking of the top of the clamp. Under the right circumstances, the latter will settle evenly. Once the fire has passed through a particular point, the bricks start to cool. They may then be withdrawn, sorted into various grades, and sold. Thus, bricks within one clamp are set and drawn simultaneously. After a number of weeks, the fire reaches the end of the clamp. Before then, construction and lighting of a new clamp may be started as previously, if market demand requires it.

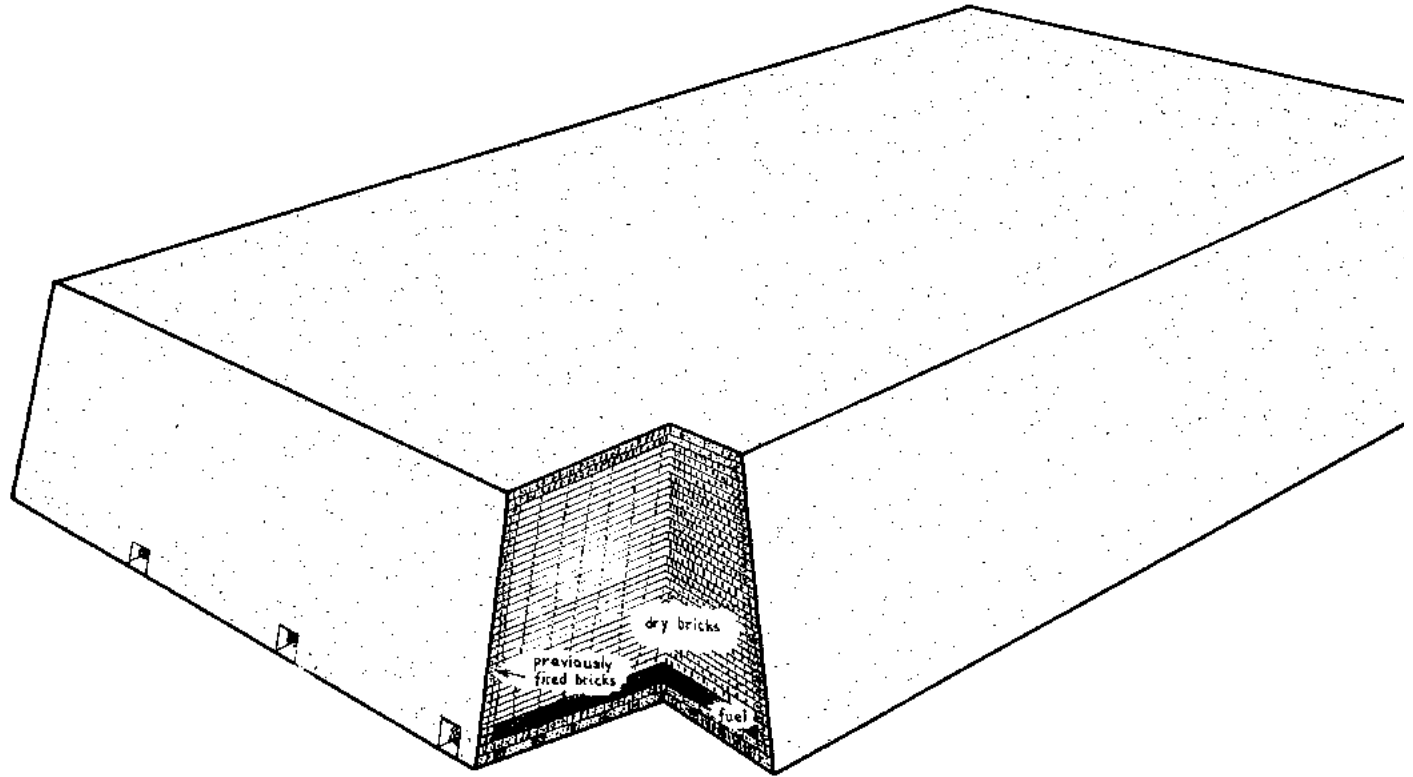

Figure VII.1 - Clamp kiln - schematic drawing



Figure VII.2 - Clamp kiln (United Kingdom)

If enough air flows through the bricks during firing, the oxidising process will give them a red colour. Where air is scarce, reducing conditions due to the gases from the burnt fuel will yield orange or yellow bricks, especially if a limy clay is used for moulding. Variations in colours will be normal even on a single brick face.

As the fuel is in close contact with the green bricks, the fuel efficiency of a large clamp of 100,000 to 1 million bricks can be fairly high (e.g. about 7,000 MJ per 1,000 bricks). Smaller clamps will be less efficient, as a result of the greater proportion of outer cooling area for a given volume. However, they may be operated successfully with only 10,000 bricks. For low production rates, it is only necessary to fire a clamp occasionally and have the bricks in place until they are sold.

The bricks near the centre of the clamp will be the hardest. Others should be sufficiently good for many uses. They should be sorted for sale as best, "seconds" and soft-burnt

bricks. However, 20 per cent of the bricks may still not be saleable. Fortunately, many of these rejects can be put into the next clamp for refiring, or used in the clamp base, sides or top.

III.2 The scove kiln

A widely used adaptation of the clamp is the scove kiln, also mistakenly called a clamp. If the fuel available is of a type which cannot be spread as a thin bed at the base of the kiln and/or is not in sufficient quantity to burn all the bricks without the need for replenishment, tunnels can be built through the base of the pile in order to feed additional fuel (figure VII.3). This is a suitable method of burning wood, the latter being one of the most frequently used fuels for small-scale brickmaking in developing countries. Usually, the outer surface of the piled-up bricks is scoved, that is to say plastered all over its sides, with mud (figure VII.4). Thus, the name of the scove kiln.

The construction of a scove requires a level, dry area of land. Previously fired bricks, if available, lay bed face down to form a good, flat surface. Three or four layers of bricks are used to form the bottom of the tunnels. The width of each tunnel is approximately equal to that of two brick lengths. Three lengths of bricks separate the tunnels. Alternate courses are laid at right angles to each other (i.e. a course of headers, followed by a course of stretchers). Two short tunnels (e.g. approximately 2 m long) may be sufficient for a small number of bricks. For large numbers of bricks, tunnels cannot be longer than approximately 6 m. Otherwise, fuel inserted from both ends will not reach the centre of the tunnel. Large numbers of bricks are dealt with by extending the number of tunnels to cope with the requirement. Figure VII.5 illustrates the construction of a four-tunnel scove.



Figure VII.3 - Scove (Madagascar)



Figure VII.4 - Scoving face of kiln (Madagascar)

The fourth and successive courses of bricks are laid in such a way that rows of brickwork finally meet, and tunnels are thus completed. The progression of the early stages of construction of a scove is shown in figure VII.6. In the foreground, a few courses of fired bricks are set, marking out the tunnel positions. In the middle of the picture, the first corbelled-out course of green bricks is partly set, while further back several courses are laid.

Green bricks are set above tunnel level, in alternate courses of headers and stretchers up to a height of at least 3 m above the ground. At the edge of the scove, each course is stepped in a centimetre or so, to give a sloping side. Small spaces are left between the bricks to allow the hot gases from the fires to rise. The required maximum spacing

between bricks is a 'finger width'. This is easy to achieve although a narrower spacing may be satisfactory. As the scove is built up, an outer layer of previously burnt bricks is laid, to provide insulation. This will also allow the proper firing of the outer layers of green bricks.

On the top of the green bricks, two or three courses of previously fired bricks should be laid, bed face down and closely packed. The whole structure should then be scoved with wet mud to seal air gaps. Turves are sometimes laid on top to reduce heat losses. The wet mud should not contain a high fraction of clay if cracks are to be avoided during firing.

Some of the top bricks half-way between the tunnels must not be scoved so that they may be lifted out to increase air flow through the kiln as required. The provision of this adjustable ventilation can be most useful in controlling the rate of burning.

Firewood is set into the tunnels (figure VII.7) for firing. It should preferably be at least 10 cm across, in pieces about 1 m in length. Kindling should be set in the mouth and bottom of the tunnel. Since the heat of the fire is to rise up into the bricks, it is essential that strong winds do not blow through the tunnels, cooling bricks down, and wasting heat. Such winds may increase fuel consumption by 25 per cent. A number of measures may be taken to avoid this waste of heat, including the blocking of the centre of the tunnel during construction, or the temporary blocking of tunnel mouths with bricks. In the latter case, one end may be bricked up and fire set at the other end. Once the fire is well alight, that end may be bricked up while the previous one is opened and lighted. Thereafter, the fires may be controlled by bricking up tunnel mouths with loose bricks and adjusting the vents on top. As fuel burns away, it must be replenished.

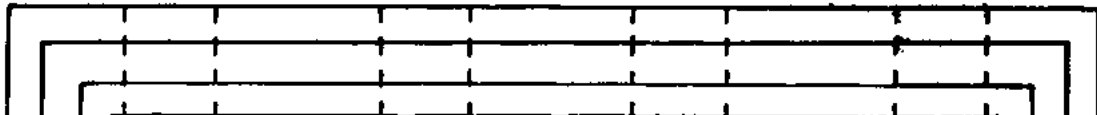

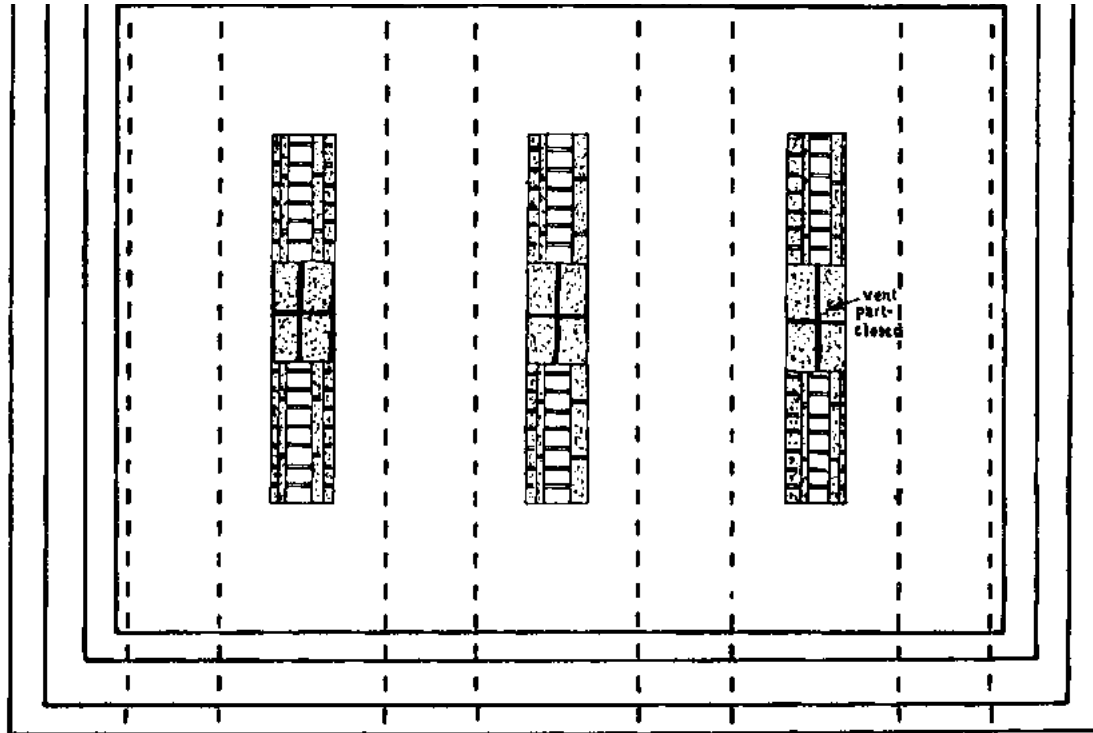

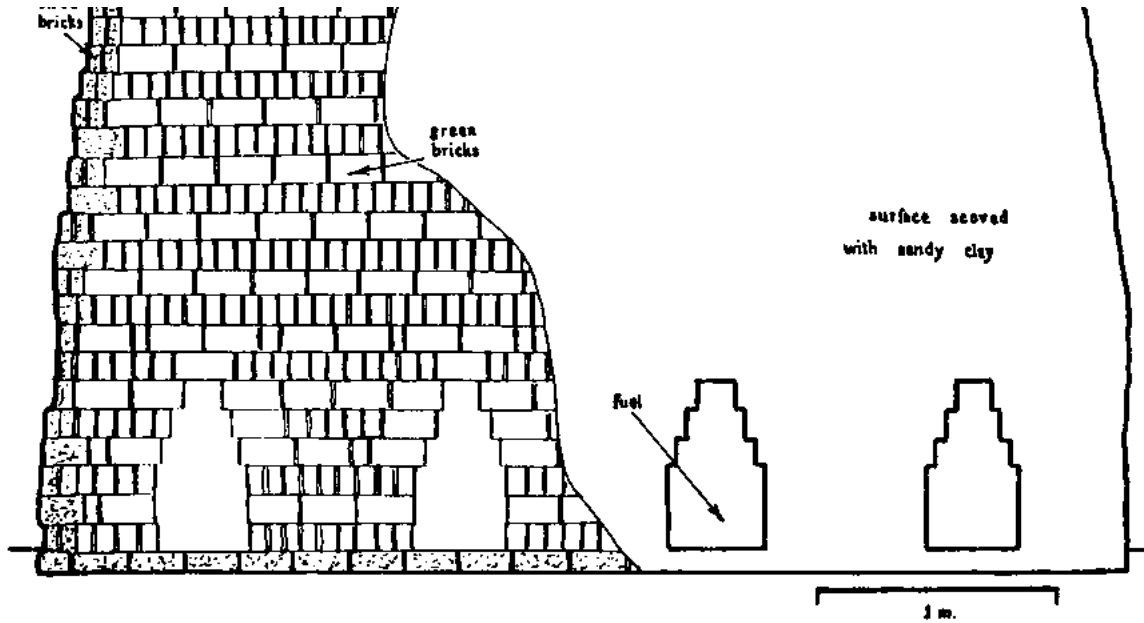

Figure VII.5 - Scove: schematic drawing



Figure VII.6 - Corbelling scove tunnel (Sudan)



Figure VII.7 - Wood in scove tunnel (Sudan)

As with all kilns, heat must be gentle at first until all the water in the bricks is driven off. Adequate air flow is therefore essential to remove the steam produced. Thus, the vents should be open, and the fires kept low so long as steam is seen to rise from the top of the scove. This water smoking period may last several days.

Once the water smoking stage is completed, the fires may be built up gradually to increase temperatures up to a maximum over a period of a few days. A maximum temperature is indicated by the charring of dry grass or paper thrown on top of the scove, or the appearance of a red glow by night. The vents should be closed with fired bricks well before the maximum temperature is attained in order to regulate the burning rate and, thus, help to even out the temperature amongst the bricks. The maintaining of this

temperature for several hours (i.e. soaking stage) requires a last charge of fuel, the closure of the tunnel mouths and the sealing of closed vents with mud.

The scove should be left to cool naturally for at least three to four days. Then if necessary some bricks may be removed from the outside to speed the later stages of cooling. Subsequently, the bricks may be left in position until sold. Before collection or despatch, under- and over-fired bricks must be discarded and the remainder, if of variable quality, should be sorted out into good quality, 'seconds' and soft-fired bricks. Rejects may be incorporated in the next scove.

Although wood is generally the fuel used in scoves, oil-burners are used in some countries. Coal, which is also an alternative fuel for scoves, requires a special grate at each end of the tunnel mouth, and is therefore more appropriate for firing in permanent kilns.

The fuel efficiency of scoves is low, 16000 MJ of heat being required per 1,000 bricks for a typical African scove (10, 52). A square scove has a smaller cooling area than a rectangular scove, for a given number of bricks. However, it will require a relatively longer tunnel which may exceed the allowed length for proper lighting of the scove. Thus, small kilns could be square while larger ones may need to be rectangular.

In order to increase the heat efficiency, the height of a scove should be as great as possible, so long as saleable bricks are obtained from the top. Safety must be borne in mind, however, as high scoves tend to be unstable as a result of shrinkage of bricks during firing. Moreover, a high setting complicates the placing of green bricks on top courses, and increases the risk of accidents. Figure VII.8 shows a high scove of approximately 60,000 bricks, after firing and stripping of the outer bricks.

A scove may be built for firing a few thousand bricks only, but will be less fuel efficient than larger scoves.

III.3 The Scotch kiln

The Scotch kiln is similar to the scove, except that the base, the fire tunnels and the outer walls are permanently built with bricks set in mortar (figure VII.9). The kiln itself has no permanent top, green bricks being set inside the kiln, as shown on the extreme left of figure VII.9. Much basic construction work is thus saved. A plane and section of a seven-tunnel Scotch kiln is shown in figure VII.10. Walls on either side are buttressed, and corners are massively constructed. Access into the kiln is through a doorway in the end walls. This doorway is filled temporarily with closely laid bricks (without mortar) during kiln operations. In some kilns the whole end wall is temporarily erected (40).

Wood is often used for firing the kiln, although oil burners or coal grates may also be installed. The sink of the bricks - after shrinkage - is more easily measured than in the clamp or scove kiln, since the fixed position of the permanent side walls may be used as a reference point. The sink gives an indication of the firing process within the kiln.

The advantages of the Scotch kiln over other permanent kiln structures are its simple design and easy erection. Setting and drawing of bricks are also simple.

The Scotch kilns, like the clamp and scove, are updraught kilns. They have been widely used in developing countries. Their chief failing is the irregular heating and consequent large proportion of under- and over-burnt bricks. This is especially true for clays with a short vitrification range as they cannot be fired without a good temperature control.

Fuel consumption of the order of 16,000 MJ per 1,000 bricks is generally the norm for Scotch kilns (8, 42).

III.4 The down-draught kiln

In the down-draught kiln, hot gases from burning fuel are deflected to the top of the kiln

which must have a permanent roof. They then flow down between the green bricks to warm and fire them. The green bricks rest either upon an open-work support of previously fired bricks (figure VII.12) or upon a perforated floor through which the warm gases flow. These gases are then exhausted through a chimney outside the area of the kiln after passage through a flue linking the kiln floor to the chimney. The warm gases rising through the height of the chimney provide sufficient draught to pull the hot gases down continually through the stack of green bricks.

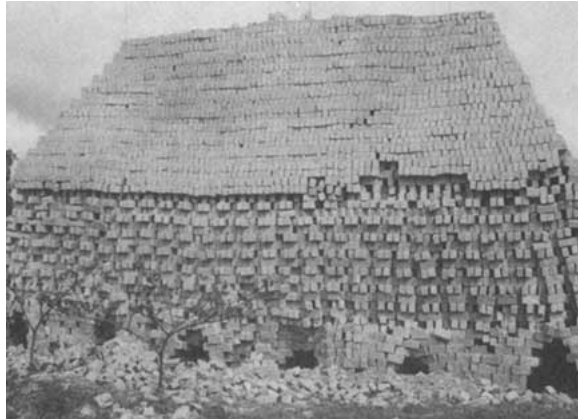

Figure VII.8 - A high six-tunnel scove (Madagascar)



Figure VII.9 - Small Scotch kiln (Madagascar)

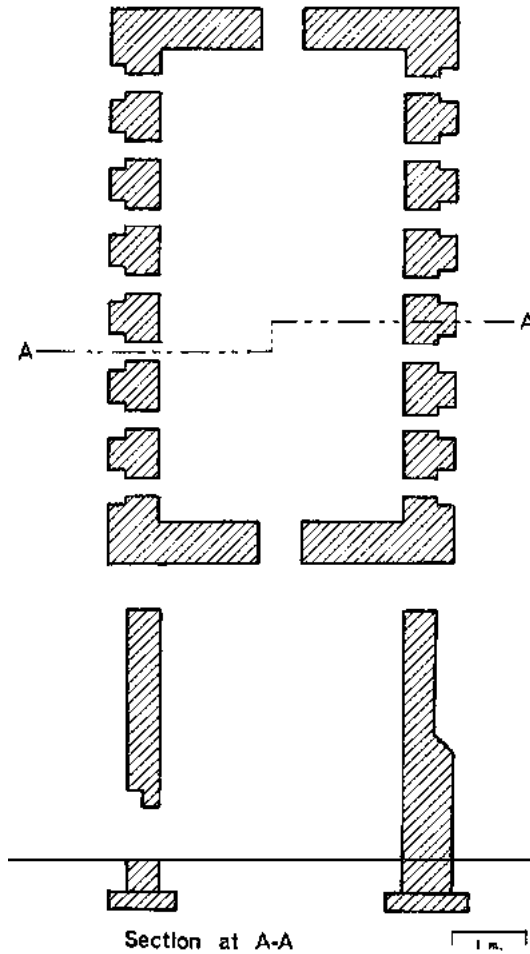

Figure VII.10 - Scotch kiln - Schematic drawing

The down-draught kiln is more heat efficient than the up-draught kiln described earlier. It can be used for various ceramic products (e.g. drainage pipes and tiles of various types) in addition to the firing of bricks. The kiln can be operated at high temperatures and may then be used for the production of refractory ware.

Circular down-draught kilns may be built in place of rectangular kilns. They are stronger than the latter, but require reinforcement with steel bands to keep the brickwork from deteriorating through periodic cooling and heating. Rectangular down-draught kilns are more simple to build, although they require also steel tie-bars as a reinforcement. They however have the advantage of being easier to set with green bricks than circular kilns. Figure VII.11 shows the ground level plan of a rectangular down-draught kiln of massive construction, with 14 grates for burning fuel. A number of grates stocked with lighted wood are shown in figure VII.13. The grates may be prefabricated from iron bars, as indicated in figure VII.11. A "flash" wall is built behind the grates to keep the flames off the nearby green bricks. The wall in the figure is continuous. Alternatively, separate "bag" walls can be built around the back of each fire (see figure VII.12 right-hand side). The continuous wall tends to even out the heating effect.

Hot gases rise to the arched crown of the kiln and are drawn down between open set bricks (figure VII.12) by the chimney "suction", through the perforated floor (shown in the figure) along its centre line. There should be a few small holes at the base of the flash wall, in the underground flue in order to ensure the burning of bricks near the bottom of the wall. A metal sheet damper is available near the bottom of the chimney in order to vary the flow of gases and exercise control over the operation of the kiln. The control of air flow is achieved by the use of metal doors. These should be thick enough to avoid distortions (figure VII.14).

Entrance to the kiln is through small arched doorways (figure VII. 15) referred to as "wickets". These are bricked up temporarily during firing.

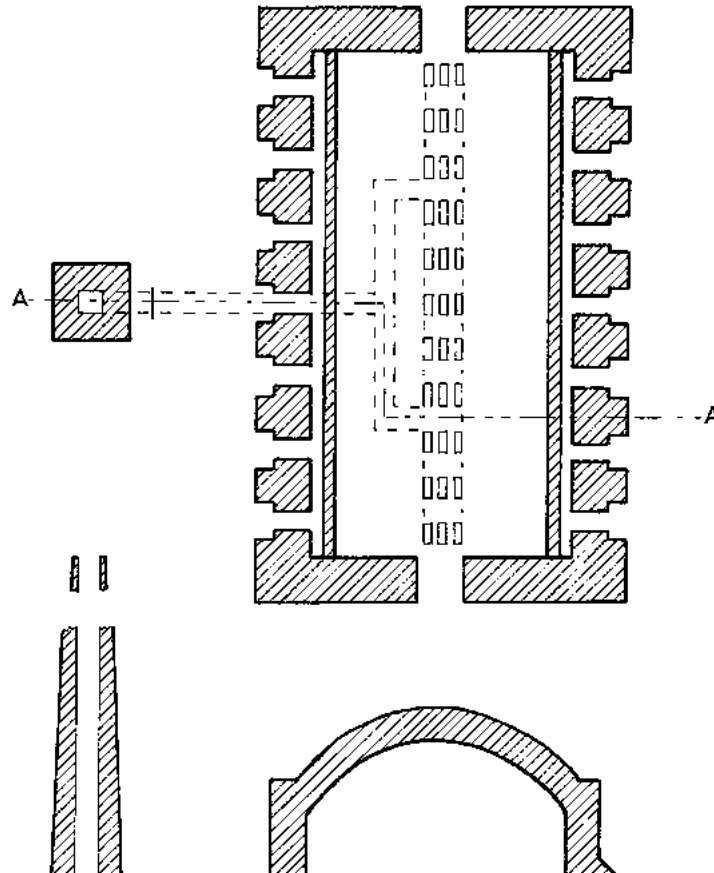

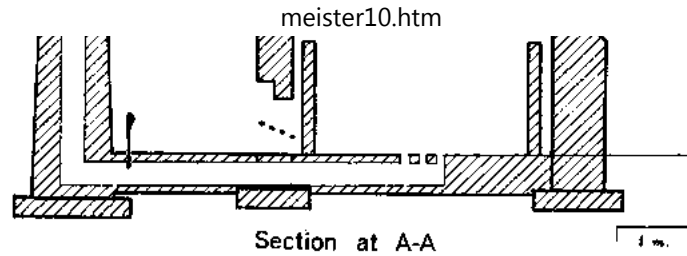

Figure VII.11 - Rectangular down-draught kiln



Figure VII.12 - Setting and bag walls in down-draught kiln (Ghana)



Figure VII.13 - Fires in kiln grates (West Africa)



Figure VII.14 - Metal damper door for kiln grate (West Africa)



Figure VII.15 - Rectangular down-draught kiln with covering (Ghana)

The height of downdraught kilns should not be too great, as it is difficult and time consuming to set bricks at heights that may not be easily reached by workers.

Down-draught kilns may hold from 10,000 to 100,000 bricks. The one shown in figure VII.15 takes 40,000 bricks.

Fuel consumption depends greatly upon the condition of the kiln, the manner of setting the bricks and the control of the firing process. For example, damp foundations absorb heat, and a badly fitting damper may waste fuel. The loss of heat varies from one type of kiln to another. Large kilns consume less fuel than small kilns, for a given number of bricks. An under-filled kiln loses as much heat as one properly filled. An over-filled kiln prevents the passage of hot gases, and this requires a longer burning cycle. Too much draught allows more heat to be wasted up the chimney. Given the above varying circumstances, the heat required by downdraught kilns varies from 12,000 to 19,000 MJ per 1,000 bricks. An exact estimate of heat consumption requires an in-depth study of the characteristics of the kiln (5, 24, 33).

III.5 Original circular Hoffmann kiln

The Hoffmann kiln is a multi-chamber kiln where the air warmed by cooling bricks in some chambers pre-heats the combustion air for the fire, and exhaust gases from combustion pre-heat the green bricks. The main advantage of this kiln is its particularly low fuel consumption rate.

The original Hoffmann kiln was circular (see figure VII.16) and built around a central chimney. An arched-top tunnel surrounds the chimney at a distance of a few metres, and is connected to it by 12 flues passing through the brickwork between the tunnel and the chimney. Each flue can be closed off by dropping a damper. Entrance into the tunnel is

through any one of 12 wickets. During operation most of the kiln's tunnel is full of bricks either warming, being fired or cooling.

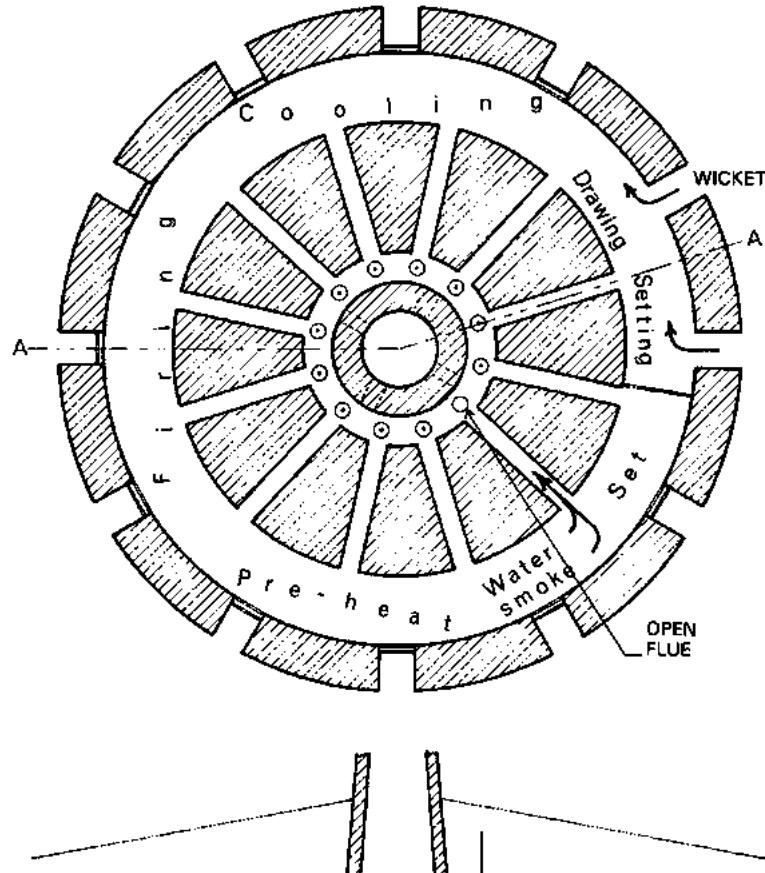

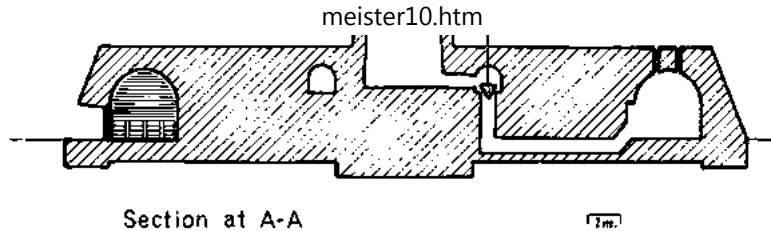

Figure VII.16 - Original Hoffmann kiln

A typical condition of the kiln is shown in figure VII.16. All but two neighbouring wickets are closed. Cold fired bricks are drawn from one part of the tunnel adjacent to one of the open wickets and dry green bricks are set by the other wicket. Cold air flows to the warm chimney through both wickets. This air cannot pass through the recently set bricks as they are sealed off with a paper damper across the whole width of the annular tunnel. The air flows through the bricks which are drawn, into warm bricks further down the kiln (counter-clockwise in the figure) close to the fire. As the air flows counter-clockwise, its temperature rises through contact with increasingly hot bricks. The air is thus pre-heated and ready for efficient combustion in the firing zone of the kiln where fuel is fed in through closeable holes in the tunnel roof. Thus, little fuel is consumed for heating the combustion air. The latter also performs the useful task of cooling bricks for drawing, thus making kiln space available on a relatively short time. The hot products of combustion cannot be vented straight to the chimney through the nearest flue, as the latter is closed (this is indicated by a dot in the circle centre in the figure). Instead, the hot gases pre-heat unburnt bricks. Thus, less fuel is required at the firing stage in order to get the bricks to the maximum temperature. Next, the cooled gases flow through recently set green bricks, bringing the latter to the water smoking stage. These bricks are sufficiently warm to exclude the forming of condensation. Figure VII.16 shows the gases leaving from the open damper (no dot in the circle). Subsequently, this damper is closed, the next one (counter-clockwise) is opened and the bricks marked "set" start the water smoking stage. The fuel feed, and the drawing and setting operations, are also moved counter-clockwise at this

stage¹. Once the part of the tunnel marked "setting" has been filled with green bricks up to the next flue, a paper damper is pasted over the bricks and the wicket (counter-clockwise) is then broken down and cooled fired bricks are withdrawn. The paper dampers can be torn open by reaching through the fueling points with a metal rod.

¹ The Hoffmann kiln described in this memorandum is operated counter-clockwise. Other kilns may, however, be operated in a clockwise fashion.

Figure VII.16 also shows a sectional drawing of the Hoffmann kiln. Bricks in the firing zone are on the left-hand side of the figure, and the empty part of the kiln - between drawing and re-setting - including the closed flue damper, is on the right-hand side. A roof covering protects the kiln from adverse weather. Wickets are shown as two thin walls, separated by an air gap. Thus, heat is kept in the kiln without the need for expensive building work at the wickets.

In the original Hoffmann kiln, fuel fed through the roof falls into hollow pillars formed by bricks set for firing. Ash from the fuel causes some discoloration of the bricks.

The tunnel is subdivided into 12 notional chambers which are identified by the flue positions. Each chamber is approximately 3.5 m long and 5 m wide. The height of each chamber is restricted to about 2.5 m for easy working conditions.

Daily rate of production from such a continuous kiln is at least 10,000 bricks.

The advantages of the original Hoffmann design include the identical chambers, the fairly short flues and low fuel consumption (2,000 MJ per 1,000 bricks(8)).

III.6 Modern Hoffmann kilns

Increased demand for bricks in industrialised countries require the erection of

substantially larger kilns than those originally designed by Hoffmann. Consequently, the original circular kiln has been modified for the following reasons:

- increases in the floor area of the chambers require considerably more building work between the chambers and the chimney;**
- larger diameter kilns and longer flues increased costs considerably and greatly complicated the operation of the kiln;**
- the circular shape of the kiln is inconvenient for some sites;**
- curved walls make the setting of bricks a difficult operation;**
- a circular kiln does not allow the construction of a long tunnel unless the diameter is to be increased considerably. Yet a long tunnel is more appropriate for the transfer of waste heat.**

Under these circumstances, the original design was modified into the so-called elliptical Hoffmann kiln, which has long straight walls and a few curved chambers at the end (see figure VII.17). The operating principle is exactly the same as that of the original design. The main difference relates to the larger number of chambers available in the elliptical design.

The operation of the modern elliptical Hoffmann kiln may be summarised with reference to figure VII.17. It includes the following sequence of events¹:

- open wickets allow fresh air into chambers 16, 1 and 2 while bricks are drawn from chamber 2;**
- other bricks are cooled and air heated in chambers 3 to 6;**

- **the hot air is used for graduated combustion in the next three chambers 7 to 9;**
- **exhaust combustion gases are pulled by the action of the chimney through chambers 10 to 13, thus preheating the bricks;**
- **gases leave the kiln at the end of chamber 13.**

1 The dotted lines in figure VII.17 indicate the boundaries between chambers, and the position of paper cross dampers is shown at inter-chamber boundaries by continuous thick lines.

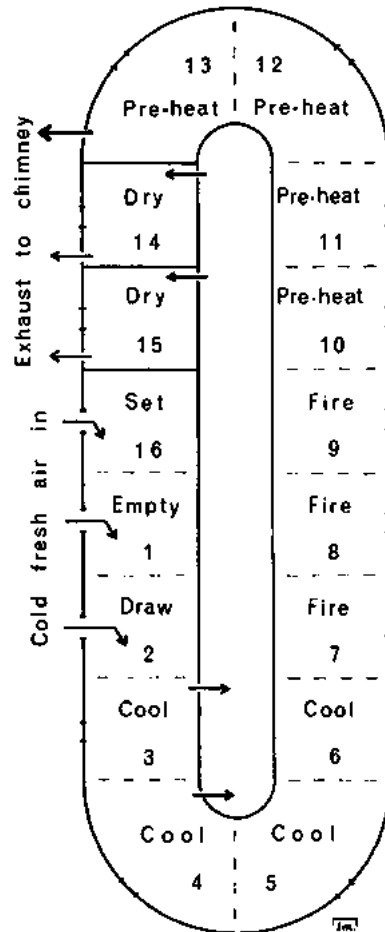

Figure VII.17 - Scheme for operating a modern elliptical Hoffmann kiln

In this type of kiln, gases are too cool for water smoking. As they carry much water vapour, there is a risk of spoiling green bricks by condensation (e.g. softening of bricks, surface cracking, and scumming by salts deposited from the products of combustion). Overcoming these problems - which may arise with exhaust gases at less than 120 °C and which are present to some extent in the original circular Hoffmann kiln - requires a second flue which connects all the chambers. Any of the latter may be connected or disconnected to this so-called hot air flue by opening or closing dampers in the same manner as for the main flue connection. In figure VII.17, the hot air flue is regarded as being in the central island of the kiln. Some of the warmed fresh air is taken off by the chimney suction applied to the flue. It is provided by chambers 3 and 4 where bricks are still hot, passed down the hot air flue, then into chambers 14 and 15 where drying, or water smoking takes place. Hence the drying is done with clean warm air, containing no moisture or products of combustion. This air then flows from chambers 14 to 15 into flues (where damper are open) and is exhausted by the chimney. Meanwhile, fresh green bricks are set in chamber 16.

The production rate of most Hoffmann kilns is approximately 25,000 or more per day, a too large output for the type of brickworks considered in this memorandum. However, small kilns can be built to produce only 2,000 bricks per day(8). Figure VII.18 shows hollow clay blocks set within an elliptical Hoffmann kiln with a capacity of about 10,000 ordinary size bricks per day. This is an interesting kiln since wood is used for firing in place of coal (figure VII. 19). A wide variety of agricultural wastes may also be used in place of wood in the top-fed kiln shown in figure VII. 19. For example, sawdust has been used in Honduras (10).

Fuel consumption of elliptical Hoffmann kilns vary according to the kiln condition and method of operation, as mentioned in the previous section. It is estimated at approximately 5,000 MJ per 1,000 bricks.

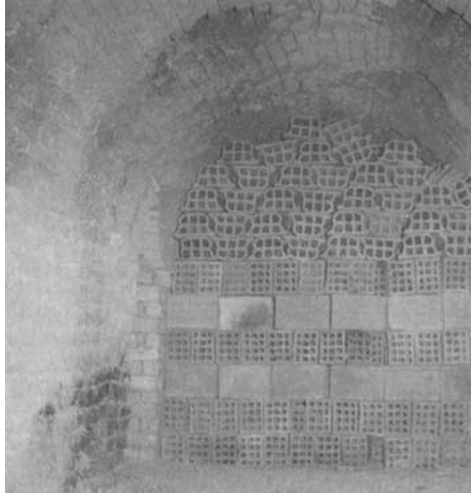

Figure VII.18 - Blocks in small Hoffmann kiln (Madagascar)



Figure VII.19 - Feeding of Hoffmann kiln with wood (Madagascar)

VII.7 Bull's Trench kiln

A large fraction of the cost of construction of the Hoffmann kiln is in the building of the arch of the long tunnel, and in the provision of a chimney, with connecting flues and dampers. Thus, the idea behind the design of an archless kiln by a British engineer (W. Bull) in 1876.

As with the two types of Hoffmann kiln, the Bull's trench kiln may be circular or elliptical. Both forms have been widely used throughout the Indian subcontinent. Construction of this type of kiln is briefly described below.

A trench is dug in a dry soil area which is not subject to flooding. It is approximately 6 m wide and 2 to 2.5 m deep.¹ Alternatively, especially if the soil is not sufficiently dry, the trench may be dug to only half of this depth, while excavated material is piled up on the

trench side, and held out off the trench by a brick wall starting at the bottom of the trench (figure VII.20). The total length of the trench is approximately 120 m. It is so constructed as to constitute a continuous trench.

1 Excavated soil may be suitable for brickmaking.

When in operation, the Bull's Trench is full of bricks warming, being fired or cooling. Cooled bricks are drawn and new green bricks are set, while the fire is moved progressively around the kiln. The exhaust gases are drawn off through 16 m high moveable metal chimneys with wide bases, which fit over the openable vent holes set in the brick and ash top of the kiln. These chimneys are guyed with ropes to protect them from strong winds. The type of chimneys shown in figure VII.21 require six men to move them. This figure also shows the method of fueling whereby small shovelfuls of less than 1.5 cm size coals are transferred from storage bins on top of the kiln, and sprinkled in amongst the hot bricks through the removable cast-iron feed holes. Metal sheet dampers are used within the set bricks to control draught.

Figure VII.22 shows the sequence of events diagrammatically. The setting of the bricks within the kiln must be such as to allow sufficient air flow between the bricks and wide enough spaces for the insertion and burning of fuel and the accumulation of ashes. However, the whole setting must be sufficiently strong and stable to ensure safe operation of the kiln. The setting in figure VII.20 shows occasional cross link bricks, between the separate bungs or pillars of bricks, tying bungs together. Information on the firing of these kilns is available (54) and kiln designs are standardised(55).

Modifications to this type of kiln have involved the provision of flues from the trench so that chimneys can be moved on rails located on the centre island rather than over the setting bricks in the kiln. A major problem is the corrosion of the mild steel chimneys normally used. They may rust through within only a few months. Accordingly, some kilns

have been redesigned with dampers opening to flues connected to a permanent brick chimney.



Figure VII.20 - Cross-link bricks between the separate bungs or pillars of bricks in Bull's Trench kiln

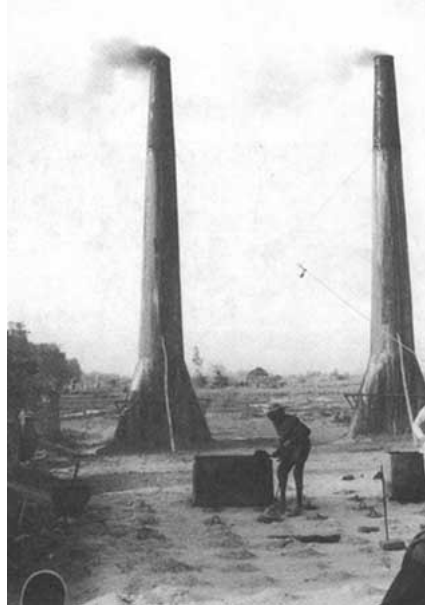

Figure VII.21 - Bull's Trench kiln: chimney and feeding (India)

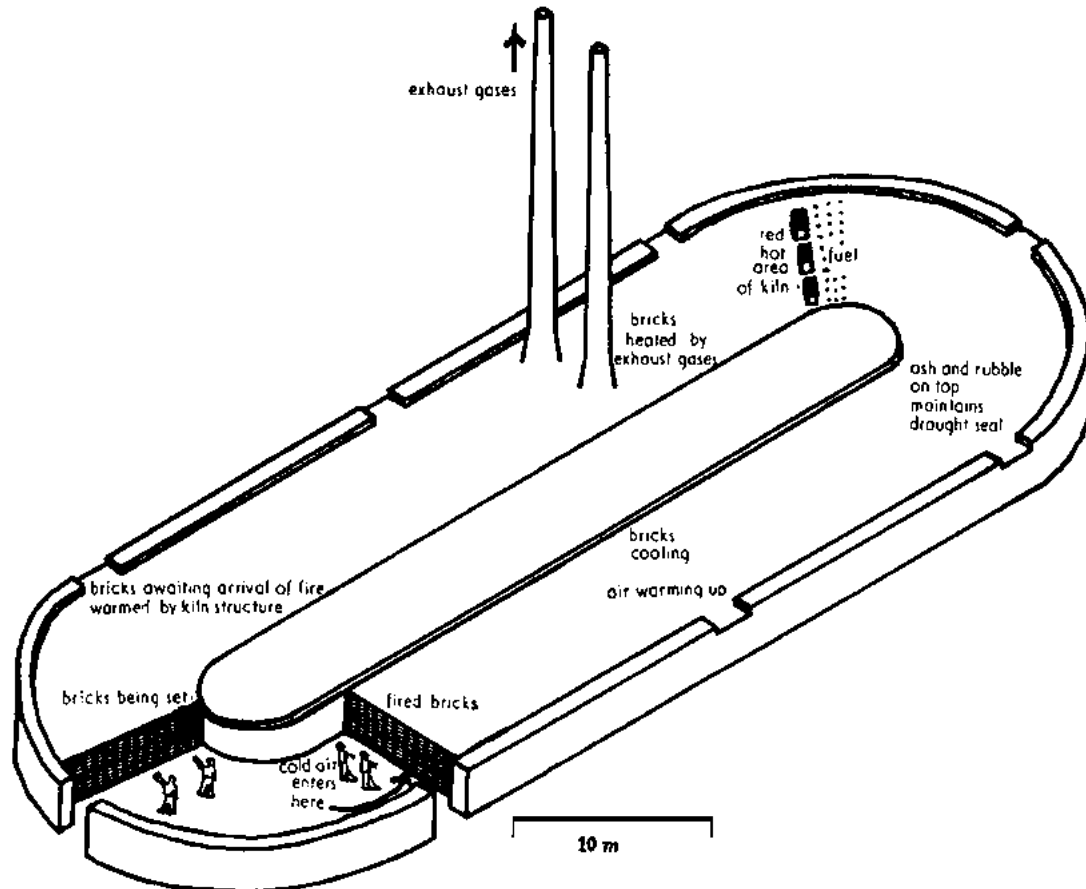

Figure VII.22 - Bull's Trench kiln - Firing sequence

The whole Bull's Trench kiln is very large, a normal output being 28,000 bricks per day. With a narrow trench output could be reduced to 14,000 bricks per day. It is not possible to shorten the trench as this will affect the heat transfer efficiency. The depth of the trench cannot be reduced either without impairing the firing behaviour. The kiln would be very big to roof over, and is most suited to dry weather conditions. The chief advantage of this type of kiln is its low initial construction costs.

Fuel consumption is much better than in intermittent kilns, 4,500 MJ being required for firing 1,000 bricks (10, 22, 56). About 70 per cent first-class bricks can be obtained, the remaining bricks being of poorer quality.

III.8 Habla kiln

The effective tunnel length of the Hoffmann type kiln may be increased by the building of zigzagged chambers. The resulting kilns, known as the zigzag kilns, have a faster firing schedule than the Hoffmann kiln. However, they require a fan - and therefore electrical power - as air must travel a longer path and a simple chimney does not provide sufficient draught for air circulation. Fans provide a more steady draught than chimneys and can be better controlled. They allow a larger transfer of heat to the water-smoking stage, thus saving fuel. However, it is best to avoid condensation on fan blades and subsequent corrosion of the latter by having gases extracted at 120 °C. This is especially important if fuel or clay contain sulphur compounds such as pyrites which are transformed into sulphuric acid in the kiln gases.

The zigzag kiln developed by A. Habla is an archless kiln. One additional simplifying feature of this kiln is that the zigzagging walls are temporary structures of green bricks which may be sold after firing. Habla kilns are of various designs: in some kilns the flues are returned from all chambers to the central island while in others, some of the flues are returned to the outer walls. Figure VII.23 illustrates the former type of kiln. For simplicity,

it omits the hot air flue which can be carried above the main flue for providing clean drying air.

The Habla kiln is rectangular, but close to a square. The one illustrated in figure VII.23 has chambers numbered 1 to 20, every second chambers being accessible through a wicket. Partition walls of dried green bricks, with a thickness of only one brick length, are alternatively built out from the central island and the outer wall. These partition walls deflect the gases from the island to the outer wall, through the wide-set bricks between the partitions. As the temperature of any particular chamber rises, the wide-set bricks are first heated. Then, as bricks in the partition shrink a little, draught through the partitions increases, and the bricks in that partition as well as the wide-set ones become fired.

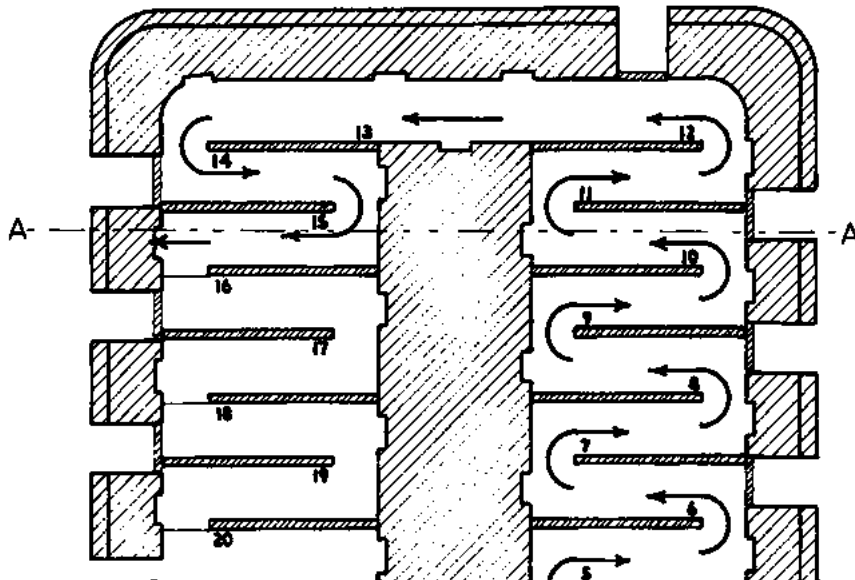

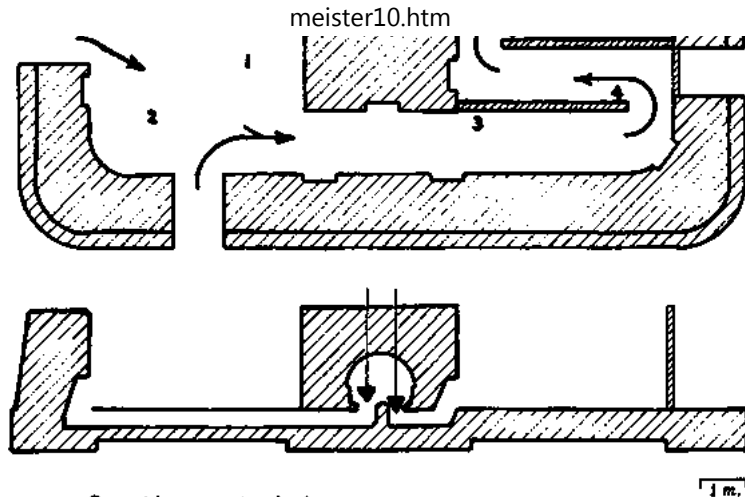

Section at A-A

Figure VII.23 - Habla type kiln - Firing sequence

In figure VII.23, chambers 1 and 2 are empty. Bricks are drawn from chamber 3. Air passing through the open wickets is warmed as it cools bricks in chambers 4 and the following ones. After the firing zone, the exhaust gases preheat bricks, flow out of chamber 15 through the chamber flue and open damper (shown in the section drawing), and enter the main flue from where they are expelled through a short chimney by the fan. Bricks in chambers 16 to 19 are water smoked by clean warm air from chambers 4 to 6. Paper dampers are used as in the case of the Hoffmann kiln.

An interesting modification to the layout shown in figure VII.23 is to build a pair of short partitions in line with each other, approaching from the island and outer wall, but leaving a gap in the middle. Secondly, a wall may be built in the middle of the kiln, separated by two gaps from the island and outer walls. The fire can then travel along two paths

simultaneously, around both ends of the second partition, through the central gap of the third, then around both sides of the fourth and so on. This modification should help speed the rate of firing.

Large Habla kilns, producing 25,000 bricks per day (57), have been built in a number of countries. Recently, in India, a 24-chamber high-draught kiln of this type has been developed (58) for an output of 30,000 bricks per day. It is fired with coal and wood. Figure VII.24 is based on published information on this Indian kiln. The latter may be reduced in size for a production of 15,000 bricks per day. Roofed zigzag kilns may also be built for as few as 3,000 bricks per day (8).

The Habla kiln is economical to construct and operate. It has a larger capacity relative to its area than other continuous kilns. This feature reduces the costs of land and construction. Furthermore, the kiln has a long firing zone, allowing difficult clays to be fired more easily. The long-firing path assists heat exchange between gases and bricks, thus improving fuel efficiency. Because partitions are of green bricks, less permanent brickwork has to be heated and cooled, thus adding to fuel efficiency. The shrinkage of bricks in the partitions and consequent leakage of hot gases shortens the distance travelled by the latter. Thus, less power is needed to drive the fan. As a result of partition leakage, the kiln has relatively few "dead spaces" where heat is insufficient to fire bricks properly. The building of partitions of green bricks at the start of each operation does not increase labour costs since the bricks are removed for sale and may thus be regarded as part of the whole setting. Another advantage of the Habla kiln is the easy access to the structure.

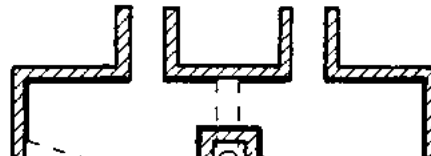

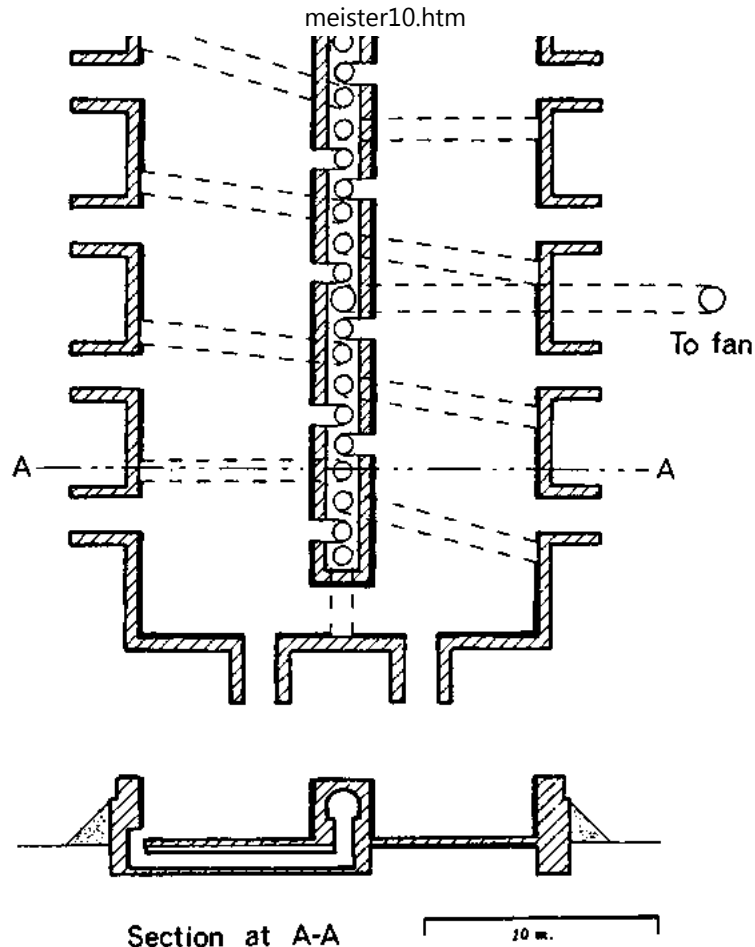

Figure VII.24: Central Building Research Institute high-draught kiln (India)

Fuel consumption of a zigzag kiln is estimated at 3,000 MJ per 1,000 bricks(57). Consumption in the high-draught Indian archless kiln is also approximately 3,000 MJ per 1,000 bricks.

IV. Auxiliary equipment

IV.1 Kiln control

Temperature control, including control of the temperature attained and of the rates of increase and decrease, is an essential activity in brickmaking. Such control may be carried out in a number of ways, including the following:

Analysis of the colour of gases coming off the kiln: During the initial stage of heating (water-smoking) white gases indicate that the bricks are not thoroughly dry. Thus, the fires must be kept low. The presence of wetness on an iron bar withdrawn from the kiln after only a few seconds' insertion is indicative of the water-smoking stage. From approximately 500 °C upwards, the colour of the hot kiln provides clues to the temperature attained. The interpretation of kiln colours should be based on previous temperature readings and colour examination. For example, the colour of smoke of a scove kiln varies as the whole kiln reaches top temperatures. The sink of the bricks is also an indication of the process of vitrification.

Use of instruments: Instruments are also available to assist the kiln operator. At the water-smoking stage, a thermometer within a protective metal sheath may be pushed in or lowered on a chain amongst the bricks. The presence of moisture on the metal (after withdrawal of the thermometer) is indicative of the water-smoking stage. A reading of the temperature may be obtained by keeping the thermometer amongst the bricks for a longer period. While moisture is still being driven off, the temperature remains at about 100 °C. Once it rises to 120 °C, fires may be increased as moisture in the bricks will have been removed. Thermocouples may be used in place of thermometers especially if a continuous

reading of the temperature is required. A chart recorder, which displays the temperatures measured by several thermocouples, may be used for this purpose. In a continuous kiln, thermocouples could be placed in the preheating zone, the maximum temperature firing zone, in the coolest part of the cooling chamber from which air is being taken to the chimney, in the base of the chimney and in the hot air flue if it exists (48). A reading of the chart will indicate the state of the kiln and the need to adjust firing in order to obtain better quality bricks or to improve fuel efficiency. It also gives the manager an indication of the quality of the kiln operation. Thermocouple probes must be of a corrosion-resistant metal or in protective sheaths.

Pyrometric cones, which better measure the effect of both time and temperature upon clay, may be used in place of thermocouples. They are made from carefully controlled mixes of clays and fluxes, and will therefore deform, or squat at different stages in a heating schedule. For example, a cone which squats at 1,140 °C with a rise of 60 °C per hour, will squat at 1,230 °C with a temperature rise of 300 °C per hour. Thus, pyrometric cones indicate the way in which fired clay products perform in a kiln. The temperature at which cones squat, when heated at a standard rate, is known as the pyrometric cone equivalent (PCE). Cones may be used in laboratory experiments and in full-size production kilns, and are useful in applying the results of laboratory investigations. In practice, three cones are used to control the firing temperatures within a kiln at a given PCE: one cone of the adopted PCE value, one of 20 °C less, and one of 20 °C more. These cones are set in a fireclay base and placed between bricks well in from the kiln wall but in line with a plugged spy hole, sealed with clay. The cones are checked periodically until the first cone, with the lowest PCE rating, begins to bend over. The fire should then be stocked less as the cone with the highest PCE rating should not be allowed to squat. In other words, only the first and second cones should squat. Squatting of the third cone indicates that the kiln has been heated beyond the intended temperature. Sets of cones can be placed amongst the bricks remote from the holes in order to check temperatures attained in any part of the kiln. Alternative systems, using rings or bars, are also used.

Draught gauges, consisting essentially of water-filled, open-ended U-tubes of glass, may be used to measure the draught or suction at any given point of the kiln by connecting one end of the tube to a chamber or chimney and measuring the difference in water levels in the tube. This gives a quick check on the kiln's functioning, and indicates whether dampers should be adjusted.

It is good practice to keep a record book of all kiln operations, including temperatures, draught, numbers and sizes of bricks set, and the number and size of saleable bricks of various grades. The quantity of fuel, operators on duty and any incidental remarks about wind, rain, etc. should be noted in the record book.

IV.2 Brick handling

Labour costs may be substantially lowered if the handling of bricks (e.g. green, dried, and fired bricks) can be rationalised, and if efficient transport devices are used. Furthermore, these devices can be of considerable assistance in relieving the burden of workers. A simple litter borne by two people can be used for the transport of bricks as in the case of clay. The crowding barrow (figure VII.25) is extremely useful, especially in confined spaces such as in the circular draught kiln. The barrow is short, with its wheel well placed under the load which may be stacked high. The balance of the barrow is adjusted by placing the bricks according to the workers' height. Thus, little weight is taken on his hands and the load does not tip forward.

V. Fuel

Given the high prices and scarcity of many fuels, achievement of fuel efficiency becomes an important factor in brickmaking. Table VII.1 compares typical requirements of the different kilns described in Section III. It must be appreciated that actual amounts could vary widely from those given, depending upon the size of kiln, size of bricks, nature of clay, firing temperature, the condition of the kiln, and the skill of the operators. Calorific

values of wood, coal and oil have been taken as 16,000, 27,000 and 44,000 MJ per tonne respectively. Figures in brackets indicate that the fuel is not suitable for a particular kiln.

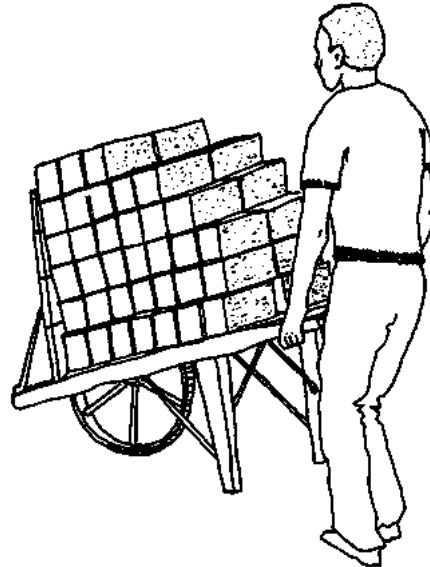

Figure VII.25 - Crowding barrow

Table VII.1

Typical fuel requirements of kilns

Type of kiln	Heat requirement (MJ/1,000 bricks)	Quantity of fuel required (Tonnes/1,000 bricks)		
		Wood	Coal	Oil

<u>Intermittent</u>				
Clamp	7,000	(0.44)	0.26	(0.16)
Scove	16,000	1.00	0.59	0.36
Scotch	16,000	1.00	0.59	0.36
Downdraught	15,500	0.97	0.57	(0.35)
<u>Continuous</u>				
Original Hoffmann	2,000	0.13	0.07	0.05
Modern Hoffmann	5,000	0.31	0.19	0.11
Bull's Trench	4,500	0.28	0.17	(0.10)
Habla	3,000	0.19	0.11	(0.07)
Tunnel	4,000	(0.25)	(0.15)	0.09

Source: 5, 8, 10, 22, 24, 33, 44, 52, 56, 57, 58.

Where wood is used as a fuel, trees should be replanted to replenish supplies. Sometimes, commercial ventures provide an incidental supply of wood (e.g. in the rubber estates, where trees fulfil their latex-yielding life within 30 years or so). The practice of coppicing is worthwhile: small-size wood is cut from a low level, thus allowing the trees to continue to grow. Coppicing may yield 125 tonnes of wood every year from a square kilometre (22).

Many other materials can be utilised to assist in the firing of bricks, in addition to wood, coal and oil. Gas, either naturally occurring such as Sui gas in Pakistan, or made from plant wastes by gasification or by bio degradation processes (biogas), may be burnt in simple burners, preferably set low down in the kiln.

Agricultural and plant wastes may also be used for firing, including sawdust (e.g. in Honduras (10)) and rice husk (e.g. in experimental kilns and in a Bull's Trench kiln in

Pakistan). A large quantity of ash, some 18 to 22 per cent of the weight of the husk, is produced on burning. As this ash may block the bottom of the Bull's Trench kiln, coal is used without husk on every few blades. Groundnut husks, coffee husks, chaff, straw and coconut husks have also been used on an experimental basis. They may be burnt in the grate of an intermittent kiln, or fed in through the top of Hoffmann, Bull's or Habla kilns. However, the volume required for sufficient heating is very large in most cases. These wastes may not be easily burnt in kilns equipped with grates. They may therefore constitute only part of the fuel source. Dung is a traditional fuel in Sudan.

Waste materials may also be mixed with clay (e.g. 5 to 10 per cent by weight) instead of being directly used as a fuel source. While this method is technically feasible, it may produce more porous and weaker bricks.

Other wastes have been tried in a number of kilns. These include old rubber tyres, waste engine oil, ashes, clinker, pulverised fuel ash from coal-fired power stations, and coal washery wastes.

The optimum air flow for highest fuel efficiency in a kiln can be determined by experiment, especially if good records are kept. Adequate air is necessary to obtain full combustion of fuel. However, too much air will have a detrimental cooling effect.

The best use of fuel is generally obtained in continuous kilns, properly maintained and run, using a fraction of waste materials. Economy of scale favours the larger kilns, but fuel for transportation of bricks from a large-scale plant may negate the fuel savings from the operation of the kilns.

VI. Productivity

The range of outputs of the various kilns described in Section III is shown in table VII.2 Although smaller units might be built than those quoted, lack of data on these units

precluded their inclusion in the table.

Table VII.2

Range of outputs from various kiln types

Type of kiln	Capacity (bricks, '000s)	Capacity (bricks per day, '000s)
<u>Intermittent</u>		
Clamp	10 - 1,000	
Scove	5 - 100	
Scotch	15 - 25	
Downdraught	10 - 50	
<u>Continuous</u>		
Original Hoffmann		10 - 15
Modern Hoffmann		2 - 24
Bull's Trench		14 - 28
Habla		15 - 30

Many factors affect the obtained outputs. In general, good maintenance and provision of roofs over kilns will improve the quantity of bricks produced, but will add to costs. Quantities produced will also depend upon the required quality standard and the skill of the operators. The market demand, weather, infrastructure and supply of raw materials will govern the rate at which production may proceed.

Capital-intensive equipment is available for transportation and the setting of bricks, but all the kilns described in Section III may be operated on a labour-intensive basis. All but the draught and Hoffmann kilns involve the extra task of covering the green bricks with

previously burnt ones and ashes.

Most of the kilns described in this memorandum are operated on a fairly labour-intensive basis. Table VII.3 shows the difference in labour requirements between these kilns and more automated kilns used in industrialised countries.

Table VII.3

Labour requirements

Type	Location	Labour requirements for firing, including drying (man-hours/1,000 bricks)
Traditional plant with clamp	Lesotho	15
Traditional plant with coal-fired clamp	Turkey	16
Moderately mechanised plant	United Kingdom	1.5
Highly automated plant	United States	0.6

Source: 10

VII. Brick testing

VII.1 Purpose of testing

The purpose of testing is to check the production process; to remedy faults to ensure a saleable product; and to guarantee the quality and performance of marketed bricks. Given the intended use of bricks in housing construction, they must resist local weather

conditions and should not contain materials which will damage them or the applied finishes such as renderings, plaster or paint. They must be strong enough to withstand both the dead load of the building itself, and the live load imposed by occupancy or wind. The thermal or moisture movements should not also be so large as to build up unduly large stresses. Testing should therefore consist of ensuring that bricks have all the required characteristics for efficient use in building.

VII.2 Initial checks on quality

A quick check of quality consists in striking two hand-held bricks. A high-noted ring indicates that they have been thoroughly fired. On the other hand, a dull sound indicates either cracked or soft-fired material. Similarly, bricks which cannot be scratched and rubbed away with the edge of a coin are hard and of good quality. Nevertheless, bricks without a good ring or which can be marked may still be perfectly suitable for many construction purposes. These two tests only serve to identify some of the best materials.

The general appearance of bricks may give a quick indication of quality. Regular shapes and sizes, sharp arrises, unblemished surfaces and freedom from cracks are signs of good bricks. Colour is difficult to interpret. However, within a batch of bricks from any one brickworks, the darker colours are likely to relate to the harder fired, stronger and more durable bricks.

VII.3 Standard specifications

Many countries have published their own standard specifications for bricks, and reference should be made to these where available. The methods of testing described in the British Standard(37) have been devised after much research and many years of experience, and are of wide interest. However, they may not necessarily be appropriate for other countries. Actual numerical limits must be decided locally according to what is required and what can be made.

VII.4 Sampling

The testing of bricks should be made on a representative sample of the latter since variations in preparation of raw materials, drying and firing produce bricks of variable characteristics. The testing sample should preferably contain 40 bricks picked up at random while they are being unloaded from the kiln. It is more difficult to obtain random samples once they have been placed in a large stack.

VII.5 Dimensions

Since bricks are used in fairly long runs, the testing of brick dimensions need not be carried out on individual bricks. Instead, 24 bricks should be chosen at random from the sample 40 bricks and small blisters or bumps knocked off. The 24 bricks should then be placed against an end stop touching end to end on a long bench. If the nominal length of each brick must be, for example, 21.5 cm, the far end of the row of 24 bricks should be 516 cm from the end stop. The permissible variations (for example 508.5 to 523.5 cm as in the British Standard for 21.5 cm bricks) should be clearly marked above the level of the bricks on a board behind the bench. Similarly, the width and height of the 24 bricks should be checked as bricks which comply with the standards for one dimension do not necessarily comply in other dimensions. Table VII.4 gives the dimensions calculated from batches of African bricks and the requirements of a relevant Standard: none complies in all three dimensions.

Table VII.4

Overall dimensions of 24 bricks

Brick source	Length (cm)	Width (cm)	Height (cm)
1	530.6	250.2	181.1
2	520.0*	252.2	181.2

2	559.0	255.2	184.2
3	542.3*	265.2	177.8*
4	543.8*	255.5*	168.4
<u>Standard</u>			
Minimum	533.4	254.0	170.2
Maximum	548.6	264.0	180.3

***Dimension complies**

Source: 51

VII.6 Compressive strength

The compressive strength of harder fired bricks is greater than that of other bricks although the strength of most bricks is likely to be adequate for simple buildings. Even a fairly weak brick with a compressive strength of only 7 MN/m² may support a 300 m column of bricks without crushing. However, loadings in actual buildings are increased in supporting pillars and around wall openings.

As the strength of dry bricks is higher than that of wet bricks, the former should be immersed in water for 24 hours before testing. Although a simple wooden beam, used as a lever, can be sufficient to crush green bricks or adobe, it is unlikely to be successful for higher strength burnt bricks. Instead, a compression testing machine is commonly used in public works departments, universities, and technical and research institutes. To avoid high local loadings due to small irregularities on the bed faces of bricks in contact with the steel plattens of the machine, thin plywood plattens should be placed on both bed faces. Bricks with frogs or large perforations should be bedded in mortar which is allowed to set prior to testing. Ten bricks should be tested, and the mean strength calculated.

Table VII.5 gives test results obtained on batches of bricks from two different works in East Africa. They were tested by the British Standard method. Although a few individual bricks from one works are weaker than required for a particular grading (not the lowest), the mean value complies with the standard requirement. Similarly, a few bricks from the other works would not meet a requirement of the Indian Standard(36), but the mean value is satisfactory.

Table VII.5

Compressive strength of 10 bricks

Brick source	Compressive strength MN/m ²			
	Individual bricks	Mean	Minimum requirement	
			British Ordinary	Indian Class II
A	4.1, 4.0, 8.1, 8.1,	7.1	5.2	7.5
	11.1, 10.9, 7.7,			
	4.0, 6.1, 7.1			
B	6.2, 6.5, 6.5, 8.8	8.5		
	11.4, 7.7, 11.5,			
	6.3, 10.3, 9.9			

Source: 61

For calculated load-bearing structures and civil engineering works, the strength of the bricks should be determined and used in the design calculations.

For non-load-bearing partitions, bricks of only 1.4 MN/m^2 may be used(37).

A low-cost impact testing method, claimed to give useful information on brick strength, consists in dropping a weight several times on the pieces of a broken brick in a containing cylinder(62).

The density of dry bricks is easily determined, and is sometimes quoted instead of strength.

VII.7 Resistance to erosion by water

Although compressive strengths may be more than adequate, dampness and flowing water can cause severe deterioration in buildings. Unfired earth bricks or adobes are eroded or slaked by water. On the other hand, firing yields bricks with excellent resistance to water erosion. The testing of resistance to erosion by water requires the soaking of brick samples in water for 24 hours. Good bricks should show no sign of softening or slaking.

A more severe test consists in spraying water on bricks for several weeks. This test allows the separation of bricks into various quality groups as low-quality bricks get eroded while high-quality ones remain unaffected.

VII.8. Water absorption

Hard fired bricks will absorb less water than other types of bricks. The quantity of water absorbed by a dry sample of bricks, when immersed in water for 24 hours or eight days(7), or boiled for five hours(37) is often estimated in testing laboratories. However, the results of this simple test are not easy to interpret. Generally, absorptions of less than 15 per cent by weight in the cold tests would be indicative of satisfactory brick strength and durability. Exceptionally, higher absorptions may be found with some types of clay although the bricks may still be satisfactory.

VII.9 Rain penetration

In practice, moderately high water absorption is acceptable in a brick wall, since rain water dries out once good weather conditions return. On the other hand, under some circumstances, rain running on walls made of low absorption bricks may enter the wall surface through small cracks between bricks and mortar. Rain penetration tests may be set up by building walls exposed to either rain or a water spray on one side, and observing the other sheltered side of the wall. The quality of not only the bricks but also of the workmanship in laying them, is of significance in determining the performance of the brickwork.

VII.10 Efflorescence, soluble salts and sulphate attack

Appearance of efflorescence on brickwork is considered unsightly and in extreme cases may cause spalling of faces of bricks. It may occur on initial drying or after subsequent wetting of the bricks. One test for determining the presence of efflorescence consists in half immersing bricks in distilled water for two weeks. Soluble salts, if present, will dry out on the top corners of the bricks as water is being soaked up. If only slight efflorescence occurs, it may be assumed that no problems are likely to arise in practice(7). Alternatively, sample bricks can be covered with a polythene sheet to prevent evaporation from the non-visible face in the finished brickwork, while exposing the other face upwards. A bottle of distilled water is then inverted on this latter face and the water allowed to soak in. Subsequently, the water dries out, and salts present in the bricks are carried to the surface where the amount of such salts may be estimated. Generally, if more than half of the exposed area is covered with salts, or if the surface flakes, the bricks would be regarded as efflorescent(37).

The nature of soluble salts can be determined in the laboratory by standard methods of chemical analysis carried out on powder obtained by drilling or fine grinding of brick

samples. More than 3 per cent by weight of salts is considered a high concentration. For special quality brickwork, acid soluble sulphates should not exceed 0.5 per cent, calcium 0.3 per cent, magnesium 0.03 per cent, potassium 0.03 per cent and sodium 0.03 per cent(37).

VII.11 Lime blowing

Hydration of quicklime particles derived from limestone in brickmaking clays can cause pitting on brick faces. When, in spite of precautions in manufacture, a problem persists, it may be possible to alleviate it by docking the bricks (i.e. by immersing them in water(50)). Docking apparently slakes the lime to a softer form which may extrude into neighbouring brick pores. Bricks should be soaked for approximately 10 minutes so that water penetrates at least 15 mm. Otherwise, the problem may worsen. Large quantities of water are required, and the increased weight of the bricks may add to transportation costs. Efflorescence may appear as the water dries out.

Testing for lime blowing can be done by immersing brick samples into boiling water for 3 minutes(50), or preferably into a steamy oven(63).

VII.12 Frost

Frost is one of the most destructive natural agents but only when brickwork is frozen while in a very wet condition. In climates where frost occurs, outdoor test walls or laboratory freezing and thawing tests can be used to assess frost resistance (10, 64). Harder fired, less porous bricks are generally more resistant to frost.

VII.13 Moisture and thermal movement

Reversible and irreversible moisture movements are likely to be small and of little consequence for small buildings. Tests can be carried out to determine these movements if

bricks are to be used for long runs of brickwork, or in tall structures. Thermal expansion is of similar significance and may be measured: it is likely to be approximately 4×10^{-6} m per °C (i.e. a change in temperature of 20 °C will cause a 12 m run of brickwork to change 1 mm in length).

VII.14 Durability and abrasion resistance

To investigate performance, including resistance to abrasion by wind-blown sand, small test walls should be constructed outdoors from the various types of bricks made at any works. Changes in the brick surface over various periods of time will indicate the degree of resistance of bricks to abrasion.

VII.15 Use of substandard bricks

Bricks that do not meet the required standards may be used for other purposes, and not be entirely wasted.

Underburnt bricks may be returned for refiring, or may be useful in kiln construction. Overburnt bricks may also be used in kiln construction or can be broken up and used as concrete aggregate.

Reject bricks may be broken up and used for road building or soakaways. If finely ground, they may be used as grogs in brickmaking.

Reject, underfired bricks exhibit pozzolanic properties when ground down to powder. The latter may thus be mixed with lime for the production of a cement substitute. Alternatively, the lime released when ordinary Portland cement sets will react with the brick powder. Thus, crushed soft-fired clay could constitute a useful mortar ingredient.





Small-Scale Brickmaking (ILO - WEP, 1984, 228 p.)

CHAPTER VIII - MORTARS AND RENDERINGS

I. Purpose and principles

II. Mortar types

III. Mixing and use

Small-Scale Brickmaking (ILO - WEP, 1984, 228 p.)

CHAPTER VIII - MORTARS AND RENDERINGS

I. Purpose and principles

Mortar is used to accommodate slight irregularities in size, shape and surface finish of bricks, thus providing accuracy and stability to a wall. In so doing, gaps between bricks are also closed, thus excluding wind and rain and increasing the wall strength.

Rendering applied to the external surface of brick walls can help prevent ingress of rainwater into a building. However, if materials are of good quality and bricklaying techniques are correct, rendering is usually unnecessary. Rendering is preferred, in some countries, for mainly aesthetic reasons while bare fair-faced brickwork is preferred in others.

In general, mortars need not be stronger than the bricks, and renderings should be mixed and used so that they do not crack (see section III).

Mixes for mortar and render are frequently made from ordinary Portland cement or lime, together with a large proportion of sand. In principle, a good solid mortar should contain two-thirds sand and one-third binder. If less than a third is used, the wet mix will be less workable and less strong when set. If more than a third is used, greater shrinkages will occur, and the risk of cracking will increase. Furthermore, the cost of mortar will be unnecessarily high.

II. Mortar types

II.1 Mud

The most elementary mortar, mud, is made from soil mixed with water. It may be suitable for laying adobe, but is not recommended for fired bricks. Mud mortar exposed to the weather in fair-faced work will quickly be eroded by wind-blown sand and rain (figure VIII.1). A good-quality rendering is essential if mud mortar is used. However, cement used in the render mix will be better utilised in making a more durable mortar.

II.2 Bitumen/mud

The addition of bitumen as a cut-back or emulsion makes a mud more water-resistant. Asphalt may be used as an alternative material.

II.3 Animal dung

Mud renderings may be made more weather-resistant by the incorporation of cow dung. A thin paste made by adding water to a mix of one part cow dung with five parts of soil may also be used to wash over a mud rendering(20).

II.4 Lime/sand

Lime and sand mixes are traditional materials. Lime varies in purity and thus gives different types of mortar. If the lime is very pure, consisting of a large proportion of calcium hydroxide, the hardening of the mortar will be due solely to carbonation, caused by the slow reaction with carbon dioxide in the air. On the other hand, impure limes often contain a proportion of siliceous material from clay contained in the limestone. In this case, lime burning yields a hydraulic lime, which sets under water if needed. The hardening is in this case a reaction between silica and calcium hydroxide which gives calcium silicate. Hydraulic limes also carbonate in air. This type of mortar can be very good, but slow hardening makes it less attractive than cement mortars. Replacement of some lime by cement gives a useful increase in early strength.

It is essential that lime be completely slaked before use. Commonly, slaked lime may be purchased as such, and quality may well be satisfactory. Alternatively, quicklime can be used, but it must first be mixed with water in a pit. A slight excess of water should be added, and the mixture covered to prevent drying out. Several days in the slacking pit are needed for its hydration. If any particles of unslaked material remain, they may slake later in the set mortars, and spoil the mortar.

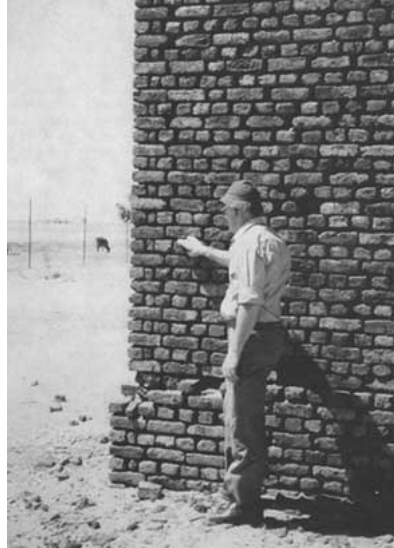

Figure VIII.1 - Erosion of mud mortar after two years (West Sudan)

II.5 Pozzolime

In the same way as silica from the clay heated during lime-burning could react with lime as described earlier, so naturally occurring volcanic ashes may contain siliceous material which can have a pozzolanic reaction with lime. In Tanzania, three parts of ash and one of lime are mixed together to form a "cement". The latter is then mixed with sand for the production of mortar (65).

II.6 Rice husk ash cement

Rice husks burnt at temperatures below 750 °C yield approximately 20 per cent of their

weight in pure ash. A cement-like material can be produced by mixing two parts by weight of this ash with one part of lime (66). One part of this rice husk ash cement may then be mixed with three parts of sand (by volume) and water for the production of mortar or rendering.

A similar material can be made from rice husks and lime sludge waste derived from sugar or paper industries(67).

II.7 Brick-dust/lime

Brickmaking clays fired to only 700 °C produce a pozzolanic material when crushed to a fine powder. Two parts of the latter (known as surkhi in India) are mixed with one part of lime for the production of a cement-like material. The latter may then be mixed with sand for the production of mortar (68).

II.8 Ordinary Portland Cement (OPC)

OPC is widely used for mortars and renderings. Excessively strong mixes may be harmful and unnecessarily expensive. Where sulphates from bricks cause problems by reacting with OPC mortars, the use of sulphate-resisting cement might be considered.

II.9 Pulverised fuel ash

Pulverised fuel ash from modern coal-fired electricity generating plants exhibits pozzolanic properties. 30 per cent of this material may be mixed with 70 per cent of ordinary Portland cement for the production of pozzolanic cement. Pulverised fuel ash may also be used with lime. The Indian standard(69) for this and other pozzolanic materials requires that mortar cubes of one part pozzolanic mixture and three parts sand by weight show an initial set in not less than two hours, and a final set within one, one-and-a-half, or two days, depending upon grading. For these three grades, 28-days compressive

strengths should be at least 4, 2 and 0.7MN/m^2 respectively.

II.10 Plasticisers

Mixes of ordinary Portland cement and sand are made more workable by substituting lime for some of the cement. The wet mix is then buttery and easy to spread by the masons. Instead of lime, very small additions of purpose-made vinsol resins may be added. The latter form minute bubbles during mixing. However, it is difficult to obtain a mortar with the required properties as the mixing operation cannot be easily controlled. Factors affecting the properties of the mortar include the amount and hardness of water in the mix; cement content; fineness and composition; grading of the sand; and the efficiency and duration of mixing. Unless all these factors are properly controlled, problems may arise. For example, the mortar may squeeze out after several courses have been laid, and the brickwork may get out of vertical alignment if too much air is incorporated in the mix. Furthermore, strength may decrease and mortar may become too permeable to water after setting. On the other hand, too little air will reduce the mortar workability. Thus, spreading of mortar may not be carried out properly, resulting in low strength brickwork and poor resistance to rain penetration(70).

Masonry cements (made with ordinary Portland cement and plasticisers) should show an initial set in not less than 45 minutes, and a final set within 10 hours, if they are to comply with the British Standard(71). A 28-days compressive strength should not be less than 6MN/m^2 .

II.11 Gypsum plaster

Any substance which sets from a fluid into a solid may be regarded as cementitious(72). Gypsum plasters, made by heating naturally occurring (or industrially produced) gypsum will set quickly. They have been used as mortar in arch building without centring. Being

slightly soluble in water they are not suitable for exterior use in wet climates. They are widely used for interior wall finishes.

III. Mixing and use

Dry ingredients of mixes should be measured out carefully. Although weighing may be preferred, gauge boxes are often used to obtain constant proportions by volume. However, if the water content of sand varies, gauge boxes may not provide accurate mixes.

The dry ingredients should be first mixed thoroughly prior to final mixing with water. Mixing may be done by hand with spades, or in a mortar-mixing machine.

If mortars are made very strong, which is usually accomplished by using a high proportion of ordinary Portland cement, the resulting brickwork may be less able to accommodate any slight movement. For example, edges of bricks may be damaged and any cracking will probably go through the bricks themselves if movement takes place. A weaker mortar might yield a little more under stress, and any cracking would then preferably go through the mortar joints. Such cracking is easier to repair in fair-faced work. For high strength work both bricks and mortar will need to be strong. Table VIII.1 provides the properties of various mixes of ordinary Portland cement (OPC), lime and sand.

Table VIII.1

Mortar mixes

Mix proportions by volume				Compressive strength	Ability to accomodate movement
OPC	Lime	Sand	With plasticiser (small amounts)	28 days (MN/m²)	

			OPC	Sand		
1	0-.25	3	-	-	11.0	Least able
1	.5	4-4.5	1	3-4	4.5	
1	1	5-6	1	5-6	2.5	
1	2	8-9	1	7-8	1.0	Most able

Source: 73

Strong renderings are more likely to shrink and crack than weaker ones. Cracks in rendering (figure VIII.2) allow water to get into the brickwork, which may not dry out easily. A mix of one part cement, one part lime and six parts sand by volume is excellent for rendering purposes. A 1:2:9 mix may also prove satisfactory. Water content should be kept as low as possible, since wetter mixes shrink more on drying, thus increasing the risk of cracking.

The mix should be used while still fresh, especially if based on OPC. A good mortar will hang on the mason's trowel, then spread easily on the bricks. It may be necessary to kill the suction of the bricks by dipping or splashing them with water, thus preventing a large proportion of the mixing water being instantly pulled out of the mix as soon as it touches the bricks. If much water is lost, it will not be possible to spread the mix as either mortar or render, and there may also be insufficient water in the mix to allow the hydration reactions to take place properly. For the same reason, it would be best to avoid working in the full sun, and to keep the work damp for 24 hours to allow curing to take place. On the other hand, if the mortar is too wet, it may have higher porosity, greater shrinkage, and lower strength, and the appearance of finished work may be poor.

Wide mortar joints are sometimes used in brickworks (figure VIII.3). If bricks are badly shaped, this is unavoidable. Where possible, joints should not be wider than 1 cm if one is to economise on materials and labour. Renderings may be of one or two coats, depending

upon the required quality of surface finish.

In the building of brick walls, frogged bricks may be laid frog down if the use of mortar is to be minimised. On the other hand, maximum strength is achieved with bricks laid frog up. If the mortar bed is furrowed before bricks are set into it, the strength of brickwork will be reduced(74). Vertical joints (or perpends) between bricks should be completely filled with mortar to obtain the best resistance to rain penetration. Figure VIII.4 shows a 40-years-old brick wall which is still in a satisfactory condition.

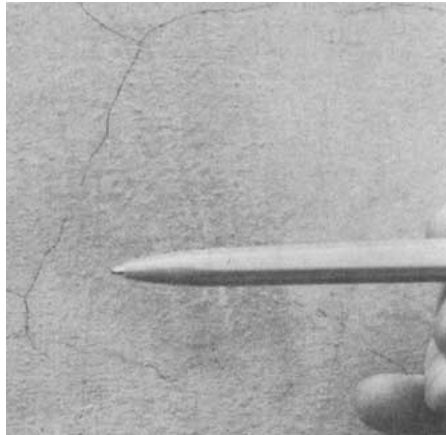

Figure VIII.2 - Cracks in rendering (India)



Figure VIII.3 - Old brickwork with extra-wide mortar (India)

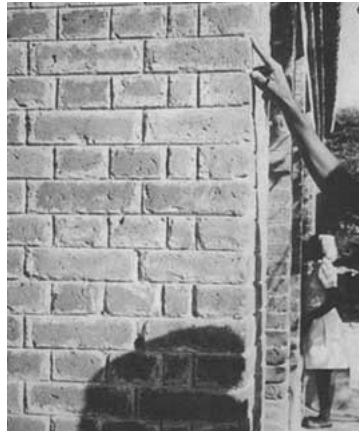

Figure VIII.4 - Bricks and mortar in satisfactory condition after 40 years of service (West



[Home](#) > [ar](#) [cn](#) [de](#) [en](#) [es](#) [fr](#) [id](#) [it](#) [ph](#) [po](#) [ru](#) [sw](#)



 **Small-Scale Brickmaking (ILO - WEP, 1984, 228 p.)**

➔  **CHAPTER IX - ORGANISATION OF PRODUCTION**

 **I. Preliminary investigations**

 **II. Infrastructure**

 **III. Layout**

 **IV. Skill requirements**

Small-Scale Brickmaking (ILO - WEP, 1984, 228 p.)

CHAPTER IX - ORGANISATION OF PRODUCTION

I. Preliminary investigations

A number of factors must first be investigated prior to investing in a brick manufacturing unit. These factors are briefly reviewed below.

A market for the product must first be ascertained. The mere knowledge that more building materials than available are needed at the present time constitutes an insufficient justification for embarking upon a new venture. There must be a reasonable degree of

certainty that bricks produced in the early stages of operation of the works do not quickly satisfy a demand which has accumulated over many years. Sustained demand is a prerequisite for profitable operation of the plant.

Future demand for wall-building materials should be investigated by examining housing development proposals, government five-year plans, etc., and by obtaining information from the Housing Ministry and other government or local authorities.

The availability, extent of use, cost and performance of alternative building materials should be examined. The probability of a profitable investment will be greater if bricks constitute a favoured building material for one reason or another (e.g., quick availability, better performance or durability, or lower cost for the finished walls).

The site must be chosen in relation to the available infrastructure and raw materials supply.

The need for permission or licences to operate the brickworks in a chosen location must be investigated. Similarly, information should be obtained on restrictions which may exist on the quantity or maximum depth which can be quarried.

The location of the works should be such that undue nuisance is not caused by noise, smoke, smell, pollution of air or water as regulations may be in force regarding the protection of the environment.

II. Infrastructure

There are several major factors which should be considered when planning the establishment of a brickworks. These are briefly described below.

II.1 Site and access

The site should preferably be flat and free from flooding. Whatever the size of the plant, suitable access must be provided to allow the easy transport of materials and output by barrow, bullock cart or lorry. The access road should not be too steep or twisting. Whenever a clay deposit is far from a good track or road, the construction and maintenance cost of a feeder road should be considered in project evaluation.

II.2 Transportation routes

In small works, customers frequently collect the bricks they purchase. Whether this is the case or not, it is advantageous to have good roads leading to the main market areas, especially if the produced bricks must compete against other building materials produced in the same region. Although rail transportation might appear an attractive means of transport, it is less adaptable for delivery to individual construction sites. Furthermore, additional handling of bricks is required, thus increasing not only labour costs but also the chances of bricks breakage.

II.3 Clay

Sufficient clay must be available for the expected life of the works, bearing in mind variation in quality and thickness of the clay deposits. It is preferable to have a larger quantity in reserve in case production is increased at a later date. Whereas a large works might be planned to have a life of 50 years, small-scale works are not usually established for such a long period. While no clear guidance on the life of small-scale brickmaking plants can be provided, it would be sensible to have enough clay in reserve for 20 to 30 years. At the lowest levels of investment, shorter periods may be acceptable.

For bricks 21.5 x 10.3 x 6.5 cm(37), approximately 2m³ of clay is used per 1,000 bricks (allowing a 5 per cent drying loss, a 5 per cent firing loss and an overall shrinkage of 10 per cent). Thus, if the clay is dug to a depth of 1 m, 1,000 bricks will require clay from an

area of 2 m². Consequently, a plant producing 1,000 bricks per day, for 200 days per year and for 25 years will require approximately one hectare of clay deposits.

II.4 Sand

Sand, which may be necessary to reduce shrinkage of a fat clay, can constitute a major item of cost if not available at the brickworks site. If a 20 per cent addition of sand is necessary, a plant producing 1,000 bricks per day will require 3m³ of sand (a lorry load) per week.

Alternatively, if it is anticipated that 20 per cent of the bricks will be rejected, the latter could just supply sufficient grog.

II.5 Water

A considerable quantity of water may be required for the preparation of dry-dug clays, the actual amount depending upon the nature of the clay and the forming process. A works producing 1,000 bricks per day and using clay with a 25 per cent moisture content, will require 500 l of water (two oil drums) per day. If this water is to be brought from a distant water source, a small lorry would be required. Extra supplies of water for the wetting of moulds, the cleaning of equipment and washing purposes should be taken into consideration at the project planning stage.

II.6 Fuel

Fuel requirements will depend chiefly on the type, size and operating conditions of the kiln. Estimates of such requirements were already provided in table VII.1. For example, the intermittent scove kiln may require 1 tonne of firewood per 1,000 bricks. Thus, a brickmaking plant operating 200 days per year, and having an expected life of 25 years,

would consume the timber produced on nearly 1 km² of an African forest(22).

Alternatively, the coppicing of a plantation of a slightly larger area (e.g. 1.5 km²) may provide an equivalent amount of fuel. It may also be noted that some continuous kilns only use one-fifth of the above amount of fuel. Either coppicing or use of fast-growing species, such as eucalyptus, require planning, land and capital. Otherwise, one may not count on a continuous and reliable supply of timber.

Another example relates to coal consumption by a scove kiln. The latter consumes approximately 4 tonnes of coal (a lorry load) per week, for an output of 1,000 bricks per day. The same amount of coal should be sufficient for one month's operation of a Bull's Trench kiln of the same capacity.

Electricity may be essential for some machines and is convenient for many general purposes.

II.7 Labour

Sufficient skilled and unskilled labour should be available within a short distance of the brickmaking plant, especially since the brick kiln requires frequent attention through day and night. In some areas, brickmaking must be temporarily discontinued during the agricultural peak seasons as the workers must return to their farms.

Labour requirements depend upon the type of material used, the degree of mechanisation, the productivity of labour and the quantity and quality of produced bricks. In small-scale, labour-intensive plants, the hand-winning of clay (including removal of overburden and transportation of clay to a nearby brickworks) requires 7 man-hours per tonne (75) or approximately 20 man-hours per 1,000 bricks. Preparation, moulding and firing require another 20 man-hours (5), giving a total of 40 man-hours per 1,000 bricks. Other plants may require 14 to 62 man-hours per 1,000 bricks. A summary of productivity data

collected in a number of countries is provided in table IX.1.

Table IX.1

Labour requirements per 1,000 bricks

Production method and quantity (bricks per day)	Location	Man-hours per 1,000 bricks	Reference
Hand-winning and moulding, burning in clamp (2,000)	United Kingdom	40	75,5
Hand-winning, sand-moulding Scotch type kiln (2,000)	Ghana	14	30
Hand-winning, slop-moulding wood fired scove	Lesotho	31	10
Hand-winning, slop-moulding coal-fired clamp	Turkey	32	10
Hand-winning, slop-moulding wood scove	Tanzania	54	10
Hand-winning, sand-moulding wood scove	Sudan	62	10
Hand-winning, soft mud (Berry machine), clamp-firing (8,000)	United Kingdom	19	5
Hand-winning, extrusion, hot floor-drying, Hoffman kiln (20,000)	United Kingdom	15	5
Moderately mechanised brick plant	United Kingdom	5	10

III. Layout

III.1 Guidelines

The layout of the works should follow a logical sequence of production stages between the location of the clay deposit and the roadway. Transportation distances within the works, and the amount of handling, should be kept to a minimum. Maximum use should be made of covered areas, where these can be afforded, especially in climates where frequent rain may interrupt or spoil the product.

The alternative sequences of production stages are represented in the form of a flow chart in figure IX.1. Modifications to the chart can be made if deemed necessary. For example, pugged clay may be suitable for shaping without tempering, and further processing stages may be added, such as the option of using a washmill as part of the clay preparation process.

III.2 Example of a general plant layout

The sequence of operations in a small, labour-intensive brickworks producing approximately 2,000 bricks a day with equipment developed at the Intermediate Technology Workshop (United Kingdom) is shown in figure IX.2. Dry, hand-won clay is brought by barrow to pendulum crushers. The fines collected from beneath the sieve are transferred into bins, a layer at a time. Each layer is then watered. The clay is retained by boards set in vertical rebates at the bin fronts. After tempering in the bins overnight or longer, the clay is moved in portable containers, picked up on a forked sack barrow, and set down by each moulder. The table moulds produce stiff green bricks which are set down on edge on small portable shelving units with the help of small pallets. Once they are full, they are moved with the sack barrow and left to dry for a few days. The shelving units are free for re-use, once the bricks reach the leather-hard stage. The bricks are then stacked on the ground for further drying. Fully dried stacks of bricks may then be moved on the sack barrow to the kiln area where they are fired, cooled and prepared for shipping.

The drawing in figure IX.2 is adapted from one produced by ITW. It shows all operations,

except winning which is conducted under three separate covers. In practice, the kiln should be positioned in such a manner that smoke and smell are not carried by the wind over the workers. For example, the kiln in figure IX.2 could have been placed further away from the other work stations.

III.3 Required areas for various scales of production

The total area of a given plant will depend on a large number of factors. No estimates of areas will thus be given in this section. Rather, a few illustrative examples are provided below for interested readers. A labour-intensive works in Ghana (32), set up to produce 1,500 bricks per day, covers a total roofed area of 40 m x 18 m. All processes, from clay preparation to hand moulding, drying in racks and firing in a semi-permanent kiln structure, are thus protected against rain. The chimney of the kiln penetrates the shed roof. The latter is of great benefit but accounts for approximately half of the capital cost.

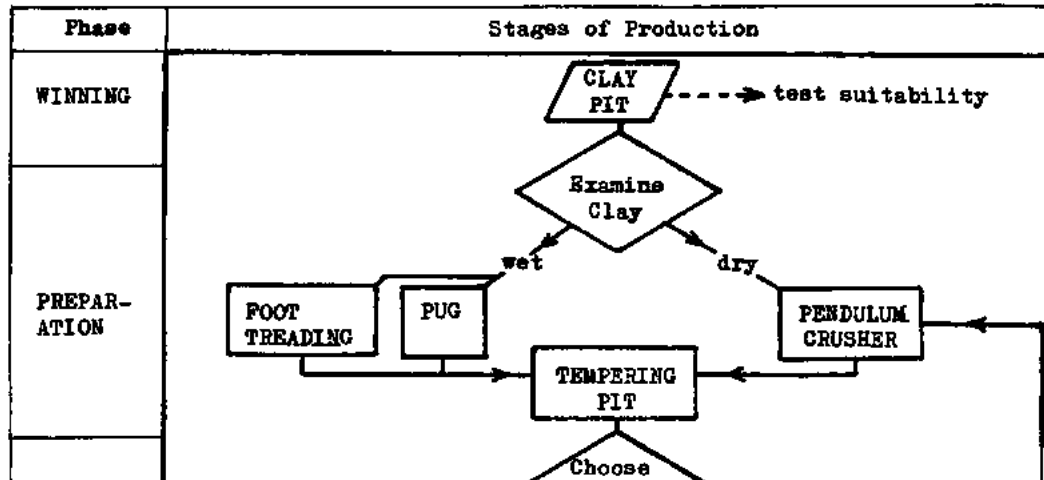

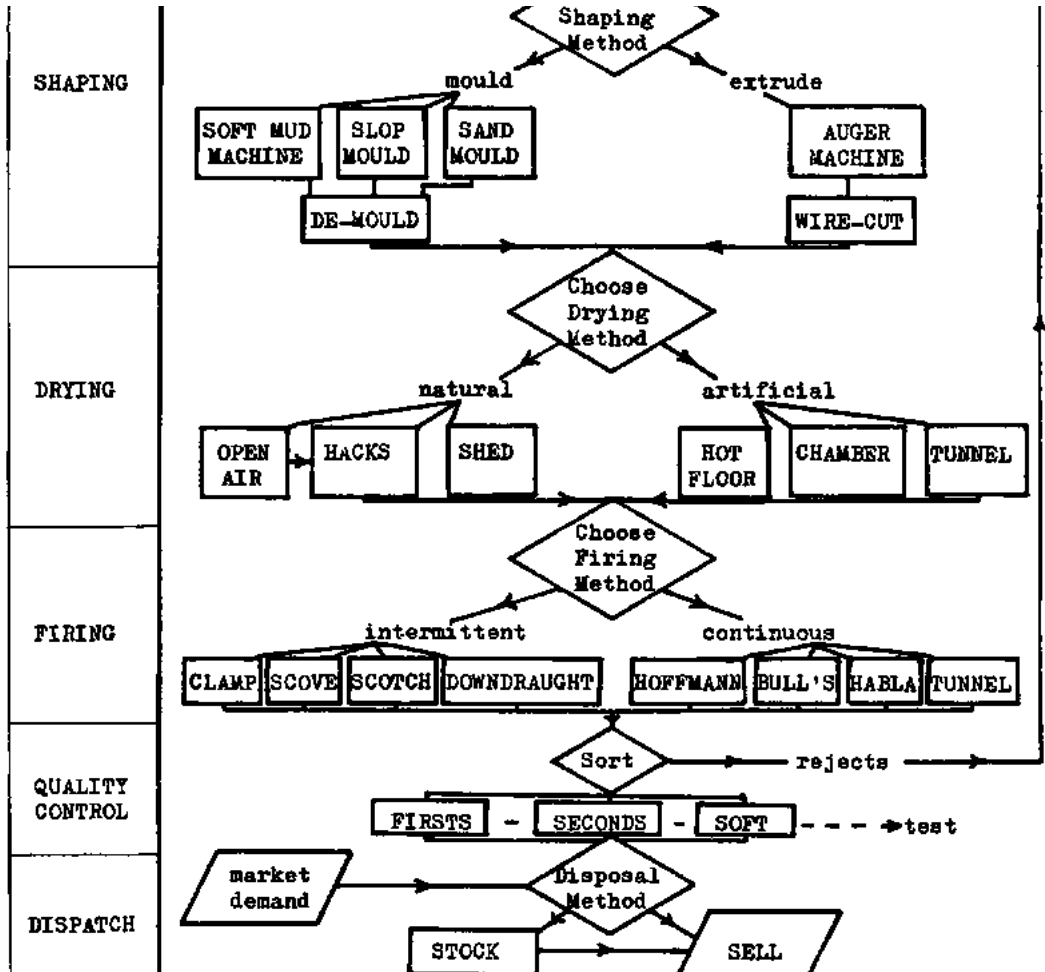
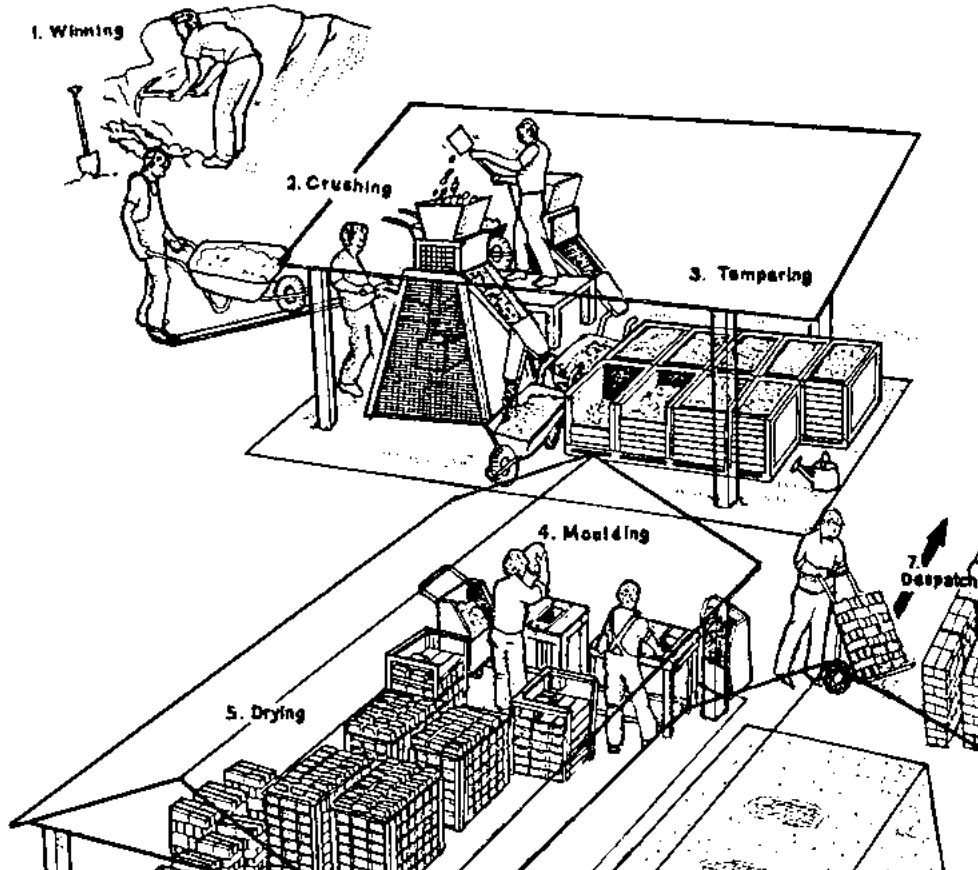

Figure IX.1: Brickmaking flowchart



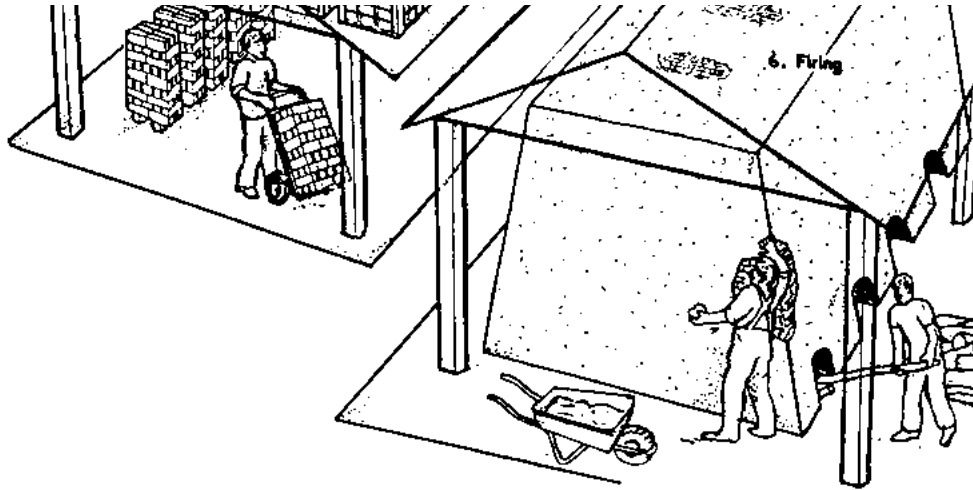

Figure IX.2: Intermediate technology brickmaking plant

Open air drying or drying in covered hacks, with good access between stacks of bricks, requires an area of approximately 1,000 m² for an output of 1,000 bricks per day.

An Indian brickmaking plant (35) producing 20,000 bricks per day, and using a washmill, settling ponds, hand moulding, open air drying and a Bull's Trench kiln (60 m x 23 m), covers an area of at least 21,000 m². This is at least three times the area used in the Ghana plant per unit of output.

The Bull's Trench kiln brickworks, without a washmill but with an open air drying area, would need twice the area of the small-scale Ghanaian plant per unit of output.

The above examples illustrate extremes in area requirements. Intermediate areas may be

required for various types of plants.

Depending on circumstances, sufficient space should also be allocated for offices, sanitary installations and appropriate eating accommodations.

IV. Skill requirements

The owner or manager of a brickworks should have the necessary skills for managing people as well as equipment and materials. The types of skills necessary for brickmaking are briefly described below.

Digging clay manually or by machine may be thought of as requiring no skill. This is, however, not the case as the careful choice of material at the pit face, and mixing by taking vertical cuts, are essential to good brickmaking. An appreciation of the dip and strike of the clay, and the reasons for rejecting overburden, roots and stones, is desirable. These skills may be taught or obtained from on-the-job training. Care and maintenance of tools should also be part of the skills of pit workers.

Skills are also required for the preparation of the clay for brickmaking, and in appreciating the requirements of a good clay body. Equipment should not be abused and should receive proper maintenance.

Moulding skills are essential to the forming of good bricks. The hand moulder and machine operator must know, for example, that the addition of extra water to the clay, so as to make moulding or extrusion easier, will increase shrinkage and thus the risk of cracking. The hand moulder must have a "feel" for the clay, be able to throw it accurately into the centre of the mould, and produce well-formed bricks at a fast rate over long periods. An understanding of required brick quality will help an operator to maintain his mould or die sizes within the necessary tolerances, allowing for shrinkage on drying and firing. As mechanical devices are likely to wear quickly, checks must be made occasionally, and

appropriate maintenance, repair and replacements undertaken whenever necessary.





Those responsible for drying bricks must understand the necessity for careful handling of the latter, especially before they are leather-hard. The operators must know when to turn bricks early in the drying stage (to allow the underneath to dry) and when they are dry enough for firing.

Firing bricks calls for great skill in order to get a good and uniform product. The overall dimension and setting pattern of the brick in building up a kiln, and the spacing between individual bricks in different parts of the kiln, are very important factors. The rate of heating and cooling must be carefully controlled and calls for special skills in the interpretation of various phenomena. Skills are also necessary for the control of the temperature through adjustment of fuel-feeding and draught.

Skilled labour is needed for the sorting of bricks into various grades.



[Home](#) > [ar](#) [cn](#) [de](#) [en](#) [es](#) [fr](#) [id](#) [it](#) [ph](#) [po](#) [ru](#) [sw](#)

-  **Small-Scale Brickmaking (ILO - WEP, 1984, 228 p.)**
-  **CHAPTER X - METHODOLOGICAL FRAMEWORK FOR THE ESTIMATION OF UNIT PRODUCTION COSTS**
-  ***(introduction...)***
-  **I. The methodological framework**
-  **II. Application of the methodological framework**



Small-Scale Brickmaking (ILO - WEP, 1984, 228 p.)

CHAPTER X - METHODOLOGICAL FRAMEWORK FOR THE ESTIMATION OF UNIT PRODUCTION COSTS

This chapter is intended to assist practising brickmakers wishing to improve their plant and entrepreneurs envisaging to engage in brickmaking by providing them with a methodological framework for the evaluation of alternative brickmaking techniques. Staff of financial institutions, businessmen and government officers may have their own evaluation methodologies, but could still find the following methodological framework useful, especially if they are unfamiliar with brickmaking.

I. The methodological framework

The methodological framework consists of two main parts:

- (i) the determination of the quantities of various inputs used in the brickmaking process (Step 1 to 5);**

(ii) the estimation of the cost for each input, and that of the unit production cost (Step 6 to 12).

These steps are briefly described below. Producers who wish to identify the most appropriate technique should repeat these steps for each technology which may yield the required output.

Step 1: Determination of the number of bricks to be produced each year. This number is a function of market demand, availability of investment funds, the adopted production technique, etc. Chapter IX provides some guidelines for determining the scale of production.

Step 2: Estimation of the quantities of the various materials inputs for the adopted scale of production. The main materials are:

- brickmaking clay**
- sand, or an equivalent material (e.g. grog)**
- water**
- fuel**

Guidelines for determining the quantities of each material are given in Chapter IX.

Step 3: Compilation of a list of required equipment, including spare parts and servicing equipment. The list should also include transport equipment whenever necessary as well as testing equipment. Both locally made and imported equipment should be included. Chapters II to VII provide guidelines for the compilation of the above list.

Step 4: Labour requirements. The productivity of the labour force may be significantly different from one country to another. Estimates of labour productivity are given in Chapter IX. These estimates may need to be adjusted for part-time workers. The number

of shifts per day, working days per week, and working weeks per year should also be specified, taking into consideration the possible closing down of the plant during the peak agricultural seasons. The number and skills of workers may be established on the basis of the above information.

Step 5: The local infrastructure required must be determined. It may include:

- land for exploitation of the quarry;**
- land for access and buildings;**
- land for drying grounds and kilns if not within the buildings;**
- land for storage of raw materials and of product;**
- buildings required, such as covered areas for making, drying or firing; offices; and other amenities.**

Chapter IX provide guidelines for the estimation of the area of each of the above items.

Step 6: Working capital. Apart from purchase of land and equipment, it is necessary to have sufficient initial financial resources to enable the purchase of raw materials, including fuel. Working capital will also be required for the payment of wages during an initial period, and for the building up of a stock of bricks for sale.

It is recommended that sufficient working capital be available for two months' materials and fuel, and one month's salaries. If difficulties are anticipated in obtaining supplies of any particular commodity, it may be necessary to hold a stock sufficient for more than two months' production.

Step 7: Equipment and buildings annual depreciation costs. Whatever type of equipment is

used, it will have a limited life. An estimate must thus be made of the annual depreciation costs for separate equipment items. The depreciation cost of buildings must also be estimated. These costs will depend upon the initial purchase price, the life of equipment and buildings and the prevailing interest rate. Table X.1 may be used to estimate these depreciation costs. It gives the discount factors (F) for interest rates up to 40 per cent and expected life periods up to 25 years. Thus, if Z is the purchase price of the equipment or the cost of the building, the annual depreciation cost is equal to Z/F .

Hence, the longer the useful life, the lower the annual depreciation cost, and the higher the prevailing interest rate, the higher this cost.

The C.I.F prices of imported pieces of equipment may be obtained from local importers or equipment suppliers (see Appendix IV). The prices of local equipment and buildings may be obtained from local contractors and equipment manufacturers.

Step 8: Land has an infinite life, and the pit may be restored to its original use in some instances. Thus, the annual cost of land may be assumed to be equal to the annual rent of equivalent land. Alternatively, if land is owned by the brickmaker, a hypothetical annual rental rate should be used when estimating the annual land cost.

Step 9: The annual cost of consumable items identified in Step 2 must be calculated. Clay, sand and water are often extremely cheap commodities. The only significant part of their cost, in comparison with that of fuel, is that incurred in extracting and transporting them. Thus, the cost of sand and clay is often included in the cost of labour, land rental rate and equipment depreciation costs. Fuel costs are of major importance and must be determined locally by examining current market prices.

Step 10: The cost of labour varies greatly from one country to another. They must thus be calculated on the basis of local wage rates. The labour requirements are those identified in Step 4.

Step 11: Working capital raised for the project will require an allowance in the annual costs for interest payments to be made on that capital.

Step 12: The total annual cost consists of the sum of the separate annual costs itemised in Steps 7 to 11.

Total annual cost =

Depreciation costs of equipment and buildings +

Annual land rental cost +

Annual labour costs +

Annual fuel costs +

Annual costs of sand and clay (if the latter are purchased rather than won on land belonging (or rented) by the producer) +

Annual cost of water (if the latter is purchased rather than pumped from a river or well within the production unit) +

Annual cost of electricity (if used) +

Annual interest payments on working capital.

The unit production cost of bricks is then equal to:

Total annual cost \div Annual output.

The use of the above methodological framework is illustrated in the following example.

II. Application of the methodological framework

The framework is used to estimate the unit cost of bricks produced by a small-scale brickmaking unit typical of those covered by this memorandum. Production takes place six days per week all year long. The production technique is similar to that described in Section IV.1 of Chapter I.

Step 1: Annual production of bricks: 624,000 (approximately 2,000 bricks/day)

Step 2: Annual requirements of clay, sand, water and wood fuel:

Clay: $624 \times 2 \text{ m}^3 = 1,248 \text{ m}^3$
Sand: 20 per cent of clay input = 250 m^3
Water: 500 l per 1,000 bricks = 312,000 l
Wood fuel: 1 tonne per 1,000 bricks = 624 tonnes

Step 3: List of equipment:

Winning: 3 wheelbarrows, picks, shovels

Preparation:

- flat concrete area
- 2 table moulds (actual mould boxes imported; tables manufactured locally)

Drying: Mobile rack to hold 4,000 bricks

Spares: 10 per cent of cost of equipment.**Step 4: Labour requirements:**

Supervision:	1 manager
	1 foreman
Winning:	2 unskilled workers
Preparing:	3 unskilled workers
Shaping:	2 skilled workers
Kiln building and firing:	3 skilled workers (three shifts occasionally worked)
	1 unskilled worker
Carrying, etc.:	1 unskilled worker

Step 5: Land and building requirements

Land for quarry, dug 2 m deep for 25 years	1.6 ha
Land for access and buildings (including drying)	0.3 ha
Kiln area	0.2 ha
Land for storage of product	0.1 ha
Total land requirement	2.2 ha
Buildings:	
covered area 20 x 20 m	400 m ²
office 3 x 3 m	9m ²
staff amenities 4 x 3 m	12 m ²

Step 6: Working capital**Working capital to cover cost of materials for 2 months****(See step 2) and salaries for 1 month**

Clay:	208 m ³
Sand:	42 m ³
Water:	52,000 l
Wood fuel:	104 t
One manager:	1 month
One foreman:	1 month
Five skilled workers:	5 months
Seven unskilled workers:	7 months

Step 7: Depreciation costs:

For the small plant under consideration, the useful life of the buildings is 25 years. The various tools and pieces of equipment used for production will have much shorter lives. Wheelbarrows, buckets, hand tools, moulds and drying racks, etc. may need replacement after two years.

Annual depreciation costs of the above items are calculated as follows:

<u>Initial costs</u>	<u>Tanzania shillings</u>
	20,000
- Covered area of 400 m ² at 50/= per m ²	20,000

- Office and amenities: 21 m ² at 300/= per m ²	6,300
- Barrows, sundry tools, moulds and racks	4,000
- Spares (10 per cent of tools and equipment cost)	<u>400</u>
Total	30,700

Annual depreciation costs

The discount factor F is equal to (see table X.1):

- **7.843** for buildings with a 25 years, life and a 12 per cent interest rate
- **1.690** for equipment with a 2 years, life and a 12 per cent interest rate

The annual depreciation cost of buildings is then equal to:

$$\frac{26,300/}{7.843} = 3,350/=$$

and that of equipment is equal to

$$\frac{4,400/}{1.690} = 2,600/=$$

Total annual depreciation costs are therefore equal to:

$$3,350/= + 2,600/= = \underline{5,950/=}$$

Step 8: Annual rental rate of land:

Land utilised for brickmaking is likely to be situated in areas commanding low land value or rental. If brickworks are known to be operating in similar land, rentals paid for the

latter may serve as a guide to prospective brickmakers. Otherwise, agricultural land price or rentals may be used for comparative purposes.

The annual rental rate in this example is assumed to be 500 T. Shillings.

Step 9: Annual cost of materials:

	<u>Tanzania Shillings</u>
- clay 1,248 m ³ at 0.72/m ³	= 90
- sand 250 m ³ at 0.12/m ³	= 30
- water 320 m ³ at 0.385/m ³	= 120
- wood fuel 624 tonnes at 60/tonne	= <u>37,440</u>
Total annual cost of materials	= 37,680

Step 10: Annual labour costs:

	<u>Tanzania Shillings</u>
1 manager at 450/= per month	= 5,400
1 foreman at 400/= per month	= 4,800
5 skilled workers at 250/= per month each	= 15,000
7 unskilled workers at 200/= per month each	= <u>16,800</u>
Total annual labour cost	= 42,000

Step 11: Interest payments on working capital:

The cost of materials and labour listed in step 6 is equal to 9,780/=, given the unit prices indicated in steps 9 and 10.

The annual interest payments are therefore equal to:

$$9,780/= \times .12 = 1,170 \text{ Tanzania Shillings}$$

Step 12: Total unit production cost:

The total annual production cost is equal to:

$$5,950/= + 500/= + 37,680/= + 42,000/= + 1,170/= = 87,300 \text{ Tanzania Shillings}$$

The unit production cost of bricks is then equal to:

$$87,300/= \div 624,000/= = 0.14/= \text{ (14 cents)}$$

TABLE X.1: PRESENT WORTH OF AN ANNUITY FACTOR (F)

Year (X)	Interest Rate (I)														
	5%	6%	8%	10%	12%	14%	15%	16%	18%	20%	22%	24%	25%	26%	28%
1	0.952	0.943	0.926	0.909	0.893	0.877	0.870	0.862	0.847	0.833	0.820	0.806	0.800	0.794	0.78
2	1.859	1.833	1.783	1.736	1.690	1.647	1.626	1.605	1.566	1.528	1.492	1.457	1.440	1.424	1.39
3	2.723	2.673	2.577	2.487	2.402	2.322	2.283	2.246	2.174	2.106	2.042	1.981	1.952	1.923	1.86
A	3.546	3.465	3.312	3.170	3.037	2.914	2.855	2.798	2.690	2.589	2.494	2.404	2.362	2.320	2.24
5	4.330	4.212	3.993	3.791	3.605	3.433	3.352	3.274	3.127	2.991	2.864	2.745	2.689	2.635	2.53
6	5.076	4.917	4.623	4.355	4.111	3.889	3.784	3.685	3.498	3.326	3.167	3.020	2.951	2.885	2.75
7	5.786	5.582	5.206	4.868	4.564	4.288	4.160	4.039	3.812	3.605	3.416	3.242	3.161	3.083	2.93
8	6.463	6.210	5.747	5.335	4.968	4.639	4.487	4.344	4.078	3.837	3.619	3.421	3.329	3.241	3.07
9	7.108	6.802	6.247	5.759	5.328	4.946	4.772	4.607	4.303	4.031	3.786	3.566	3.463	3.366	3.18

10	7.722	7.360	6.710	6.145	5.650	5.216	5.019	4.833	4.494	4.192	3.923	3.682	3.571	3.465	3.26
11	8.306	7.887	7.139	6.495	5.938	5.453	5.234	5.029	4.656	4.327	4.035	3.776	3.656	3.544	3.33
12	8.863	8.384	7.536	6.814	6.194	5.660	5.421	5.197	4.793	4.439	4.127	3.851	3.725	3.606	3.38
13	9.394	8.853	7.904	7.103	6.424	5.842	5.583	5.342	4.910	4.533	4.203	3.912	3.780	3.656	3.42
14	9.899	9.295	8.244	7.367	6.628	6.002	5.724	5.468	5.008	4.611	4.265	3.962	3.824	3.695	3.45
15	10.380	9.712	8.559	7.606	6.811	6.142	5.847	5.575	5.092	4.675	4.315	4.001	3.859	3.726	3.48
16	10.838	10.106	8.851	7.824	6.974	6.265	5.954	5.669	5.162	4.730	4.357	4.033	3.887	3.751	3.50
17	11.274	10.477	9.122	8.022	7.120	6.373	6.047	5.749	5.222	4.775	4.391	4.059	3.910	3.771	3.51
18	11.690	10.828	9.372	8.201	7.250	6.467	6.128	5.818	5.273	4.812	4.419	4.080	3.928	3.786	3.52
19	12.085	11.158	9.604	8.365	7.366	6.550	6.198	5.877	5.316	4.844	4.442	4.097	3.942	3.799	3.53
20	12.462	11.470	9.818	8.514	7.469	6.623	6.259	5.929	5.353	4.870	4.460	4.110	3.954	3.808	3.54
21	12.821	11.764	10.017	8.649	7.562	6.687	6.312	5.973	5.384	4.891	4.476	4.121	3.963	3.816	3.55
22	13.163	12.042	10.201	8.772	7.645	6.743	6.359	6.011	5.410	4.909	4.488	4.130	3.970	3.822	3.55
23	13.489	12.303	10.371	8.883	7.718	6.792	6.399	6.044	5.432	4.925	4.499	4.137	3.976	3.827	3.55
24	13.799	12.550	10.529	8.985	7.784	6.835	6.434	6.073	5.451	4.937	4.507	4.143	3.981	3.831	3.56
25	14.094	12.783	10.675	9.077	7.843	6.873	6.464	6.097	5.467	4.948	4.514	4.147	3.985	3.834	3.56



[Home](#) > [ar](#) [cn](#) [de](#) [en](#) [es](#) [fr](#) [id](#) [it](#) [ph](#) [po](#) [ru](#) [sw](#)



Small-Scale Brickmaking (ILO - WEP, 1984, 228 p.)



CHAPTER XI - SOCIO-ECONOMIC IMPACT OF ALTERNATIVE





BRICK MANUFACTURING TECHNIQUES

 **(introduction...)**

 **I. Employment generation**

 **II. Total investment costs and foreign exchange savings**

 **III. Unit production cost**

 **IV. Rural industrialisation**

 **V. Multiplier effects**

 **VI. Energy requirements**

 **VII. Conclusion**

Small-Scale Brickmaking (ILO - WEP, 1984, 228 p.)

CHAPTER XI - SOCIO-ECONOMIC IMPACT OF ALTERNATIVE BRICK MANUFACTURING TECHNIQUES

The social and economic effects of various brickmaking options should be of particular interest to public planners, financial institutions, business men, housing authorities and project evaluators from industrial development agencies. The purpose of this chapter is therefore to shed light on these various effects with a view to helping public planners identify technologies consonant with national socio-economic objectives, and formulate appropriate policies for the promotion of these technologies.

I. Employment generation

Employment generation constitutes one major objective of national development plans of developing countries. Thus, technologies which require more labour per unit of output than other technologies should be favoured as long as labour is used in an efficient manner. Consequently, small-scale brickmaking techniques should be favoured - from an

employment viewpoint - over those used in large-scale turnkey factories as they do generate substantially more employment than the latter technologies. For example, a study of brickmaking techniques in Bogot (Colombia) shows that large-scale brick manufacturing plants produce 83 per cent of the national brick production although they use only one-third of the total labour force in the brick industry. In other words, small-scale units, using relatively labour-intensive techniques, require approximately ten times more labour than large-scale plants per unit of production (76). Another study carried out in Colombia (43) shows that the labour-capital ratio in small-scale brickmaking units is over 100 times greater than that for large-scale manufacturing plants.

Table XI.1 provides estimates of labour inputs per 10 million bricks for various scales of production and techniques. It may be seen that the small-scale plants require between 20 and 25 times more labour than the highly automated plants for the same output.

Table XI.1

Scales of production and labour generation

Description of brickmaking methods	Production rate of one plant (bricks per day)	Labour per 10 million bricks per year
Small-scale, traditional manual processes	2 000	160
Small-scale, intermediate technology	2 000	200
Soft-mud machine, otherwise manual	14 000	76
Moderately mechanised	164 000	20

II. Total investment costs and foreign exchange savings

The import of expensive equipment with subsequent need for spare parts and services can be a burden on a country's foreign exchange reserves. The choice of small-scale techniques and the use of locally manufactured equipment, which can be repaired by local craftsmen, may thus partly alleviate the need for imports and scarce foreign exchange.

A large number of developing countries also suffer from shortages of local capital funds as exemplified by the high interest rates prevailing in these countries. Consequently, technologies which minimise the use of capital investments should be favoured.

Table XI.2 shows that, from a foreign exchange and capital investment viewpoint, small-scale brickmaking technologies are, by far, much more appropriate than large-scale, automated plants. Thus, capital investments in large-scale plants are six to 100 times larger than those for small-scale plants. Similarly, the import component of these investments is five to 15 times larger for the automated plants than for small-scale units.

Table XI.2

Capital costs and foreign exchange inputs

Description of brickmaking processes	Total cost for 10 million bricks per year ('000 US\$)	Proportion of costs (per cent)	
		Import	Local
Small-scale, traditional manual process	34	5	95
Small-scale intermediate technology	670	15	85

Small-scale intermediate technology	370	13	03
Mechanical plant with Hoffman kiln	3,880	75	25

Source: 77

III. Unit production cost

A major component of the cost of a house in developing countries is that of building materials. This is particularly the case for low-cost housing or various self-help schemes. It is therefore important to promote the production of low-cost building materials in order to facilitate home ownership by low-income groups and to reduce public investments by housing authorities. In the case of bricks, production techniques and scales of production which minimise unit production costs should therefore be favoured. Although reliable estimates of these costs are not available, recent studies (78) tend to indicate that small-scale plants, using intermediate technologies, produce bricks at a lower cost than large-scale, capital-intensive plants. Results of these studies are summarised in table XI.3. It may be seen that the unit price of bricks produced in small-scale plants is two to three times lower than that of bricks produced in large-scale plants.

Table XI.3

Unit production costs

Classification of brickmaking process	Unit production cost (US cents per brick)	
	Medium wage regime	Low wage regime
Capital-intensive, all year round	6.5	6.2
"Least-cost", all year round	3.1	2.3
"Least-cost", seasonal working only	2.9	2.0

Source: 78**IV. Rural industrialisation**

It is desirable to set up industries in rural areas, to counterbalance the faster growth rate of urban areas (2). These rural industries, however, must be of a size appropriate to the local markets and to the social needs of the people. It should particularly be noted that the higher the degree of automation (or of mechanisation) the higher the required professional qualifications (7). Consequently, the chosen level of technology should be such as to ensure that any maintenance or repair can be carried out on site. Small-scale plants, which can operate without electricity, are also particularly suitable for rural areas.

It is also essential that the adopted technology be consonant with the qualification level of the local labour force. Some aspects of skill requirements for brickmaking have been discussed in Section IV of Chapter IX. These requirements do not constitute a major constraint to the establishment of rural brickmaking units, especially if equipment is locally produced and repaired. Furthermore, small-scale production techniques should be flexible enough so that production may be increased according to market requirements (30). The brickmaking plants may also have to operate on a seasonal basis (according to weather conditions and the availability of workers during peak agricultural seasons), a condition which overrules the adoption of large-scale, capital-intensive plants in rural areas.

V. Multiplier effects

Alternative production techniques will have different multiplier effects on the national economy (i.e. backward and forward linkages) depending on the scale of production and the origin of equipment and materials. From a socio-economic viewpoint, technologies associated with the largest multiplier effects should, all other things being equal, be favoured over those with limited effects.

Small-scale, relatively labour-intensive brickmaking technologies are generally associated with larger multiplier effects than large-scale, capital-intensive technologies for the following reasons. Firstly, most, if not all, the equipment (e.g. table moulds, mixing equipment) may be manufactured locally instead of being imported (see section II). Production of such equipment should thus generate additional employment and incomes. Secondly, small-scale plants use local fuel (e.g. wood, agricultural wastes) while large-scale plants often rely on oil. The gathering and processing of fuel wood or other local materials will thus generate additional employment. Finally, the marketing and transport of bricks produced by small-scale units should also generate more employment than those of the output of large-scale plants. Altogether, employment generated through multiplier effects will further expand that generated through the production of bricks.

VI. Energy requirements

Fuel requirements of various types of kilns have already been considered in Chapter VII. The apparent higher fuel efficiency of large kilns must be weighed against the fact that large plants operate with a considerable amount of energy-consuming equipment. For example, a large plant producing 10 million bricks per year may require 300 kWh electricity supply for the running of the equipment(7). Furthermore, transportation costs are likely to be higher in large-scale plants than in small-scale plants. Thus, the low fuel efficiency of small-scale kilns is partly offset by the higher energy inputs for equipment used in large-scale plants. However, as energy requirements are partly a function of the efficiency of kiln-operating procedures, it is difficult to compare the relative fuel efficiency of small and large production units.

VII. Conclusion

Small-scale production of bricks is generally preferable to large-scale production under the following circumstances: where low wage regimes exist; where foreign exchange is in

short supply; where no well-developed industrial base exists; where infrastructure and technical skills are insufficient; and where the market is small or widespread.

Labour-intensive brickmaking techniques are often considered the most appropriate techniques under conditions prevailing in developing countries. However, recent studies (78) show that this may not always be the case if the factors mentioned above are not present. Thus, project evaluators should properly consider all available alternatives prior to promoting one technology or another. The evaluation of alternative technologies should take into consideration the fact that small-scale production generates more employment than large-scale production while minimising capital investments and foreign exchange costs.







Home > [ar.cn.de.en.es.fr.id.it.ph.po.ru.sw](#)



 **Small-Scale Brickmaking (ILO - WEP, 1984, 228 p.)**

  **APPENDICES**

-  **APPENDIX I - Glossary of technical terms**
-  **APPENDIX II - Bibliographical references**
-  **APPENDIX III - Institutes from where information can be obtained**
-  **APPENDIX IV - List of equipment suppliers**

Small-Scale Brickmaking (ILO - WEP, 1984, 228 p.)

APPENDICES**APPENDIX I - Glossary of technical terms**

Adobe	Mud brick; hand made, dried in the sun, not fired.
Alluvial material	Clay, sand or mud laid down by the flooding of a river.
Arris	The edge where two clay faces meet.
Auger	Tool for boring a hole in the ground or taking a sample of the soil; it has a screw-like action. Also a machine which forces clay through an aperture by means of a screw thread rotating inside a barrel containing the clay.
Bag wall	The brick wall built around the back of each of the fires of a downdraught kiln.
Batter	To slope the face of an embankment or quarry; opposite of overhand.
Bed face	The underneath surface of a brick as laid in a wall, usually the largest face; the face of a brick bedded in the mortar.
Benching	Method of winning clay from the pit simultaneously at several different levels, by working at several benches or steps.
Binder	The material which binds together separate particles: for example. cement and lime.

used to make mortars, are binders.

- Blade** A thin section of brick across the whole width of a kiln.
- Bloating** Creation of gas bubbles within the near-vitrified clay in the kiln, causing blisters and craking on brick surfaces.
- Block** A building unit larger than a brick, usually requiring two hands to lift it.
- Body** The material after processing.
- Bond** The pattern of arrangement of bricks in a wall, usually such that vertical joints between bricks are not immediately above each other in adjoining courses.
- Brick** A unit from which walls may be built and which is of such size and weight that it can be laid with one hand allowing the other hand to be used for operating with a trowel.
- Bulking of sand** A given weight of sand will have various volumes, depending upon the water content.
- Bull's trench kiln** An archless continuous kiln based on the principle of the Hoffmann kiln.
- Burning** Firing. In the case of bricks, burning them changes the nature of the clay from which they have been shaped, increasing their strength and durability.

Calcium
silicate

A generally durable compound formed when lime reacts with silica, as for example during the high pressure and high temperature methods of treating lime and silica sand to make calcium silicate bricks.

Centring

Wooden or other formwork built up to support a brick arch while the mortar sets.

Clamp

Large pile of green bricks with fuel between those in the bottom courses, which is set on fire to burn the bricks. Sometimes, this term is also used to describe a similar pile but with the fuel placed in tunnels through the lower courses of the pile.

Continuous
kiln

A kiln in which the fire is always burning, bricks being warmed, fired, and cooled simultaneously in different parts of the kiln.

Coppicing

The annual cutting of wood from trees, which therefore do not grow to full size, yet continue to provide useful materials such as fuel.

Course

A horizontal layer of bricks.

Cuckhold

A concave-bladed spade for cutting off lumps of prepared clay.

Cuckle

A curved metal strip with two handles for cutting off a piece of clay from a large lump.

Dip

The slope of a clay deposit compared with the horizontal.

Docking

Immersing fired bricks in water for a short while so that a thin outer skin is thoroughly wetted.

Claimed by several authorities to reduce the incidence of lime blowing.

Downdraught kiln A kiln in which hot gases pass down between the bricks which are being fired.

Ettringite A compound formed from sulphates and calcium aluminate; if it is formed after the mortar between the bricks is well set, it may cause softening and expansion of the mortar joints.

Eye The point near the base of a clamp where the fire is first lit.

Fair-faced brickwork Brick walling of an acceptable standard of appearance and quality, without rendering or plastering.

Fat soil Highly plastic soil; usually a clay rich soil with high drying shrinkage.

Firing Heating in a kiln to partially vitrify (see burning).

Flash A silver of clay on the arris of a brick, formed in the crack or air inlet in the mould.

Flash wall A long wall behind the fires on one side of a down-draught kiln, serving to deflect the hot gases upward.

Flux A mineral in the clay which reduces the temperature required to obtain vitrification.

Froa Indentation in one or sometimes both of the bed faces of a brick. A froa cannot be put

into an extruded, wirecut brick, but is easily formed in moulded or pressed bricks.

Ghol	Clay washing tank (Indian).
Green brick	Brick formed into shape but not yet fired.
Grog	Fired clay, often reject bricks, crushed to a fine size, for addition to the clay body. Such material reduces shrinkage and opens the body.
Habla kiln	An archless zigzag continuous kiln, based on the Hoffmann kiln.
Hard fired bricks	Bricks fired to a relatively high temperature, producing a moderate amount of vitrification and consequent good strength and durability.
Header	The small end of a brick showing in the face of brickwork.
Heat work	The combination of temperature and time and its effect on ceramic reactions.
Hoffmann kiln	A brick-arched continuous kiln, circular or elliptical, in which waste heat is used to preheat both the combustion air and the bricks, so increasing fuel efficiency.
Hydraulic lime	A lime which will set under water. This is due to certain siliceous impurities which react with the lime itself. Non-hydraulic limes harden only by carbonation caused by carbon dioxide in the air.

Igneous
rocks

Rocks of volcanic origin; rocks which were molten at one time.

Intermittent
kiln

A kiln in which the fire is allowed to die out and the bricks to cool after they have been fired. The kiln must be emptied, refilled and a new fire started for each load of bricks.

Lean soil

Low plasticity soil, usually due to lack of the finer sizes of clay fractions. In contrast to fat soil.

Leather-hard
bricks

Bricks which have partly dried so that they can be picked up without distorting them.

Loam

Sandy clay often suitable for shaping into bricks, and having a low drying shrinkage.

Marl

Natural mixture of clay and chalk.

Open the
clay body

To increase the permeability to gases of a ceramic body.

Overburden

The material lying on top of a natural deposit of brick clay.

Oxidising

Conditions of surroundings in which oxygen is freely available.

PCE

Abbreviation for pyrometric cone equivalent.

Perpend	The visible vertical joints between bricks in a wall.
Plastic material	Material able to be deformed by moderate pressure and retaining the deformed shape when the pressure is removed.
Plasticity	Possessing the property of being plastic.
Profile	A section taken through the various strata of a soil.
Puddle	To mix up dry soil or lime with water, usually manually.
Pyrometric cone	A small clay-based cone which will squat after undergoing a certain amount of heat work.
Reducing	Conditions of surroundings in which little or no oxygen is available.
Refractory	Heat-resisting.
Render	To cover an exterior wall surface with a cement-lime based mix.
Ring	The high-pitched metallic sound obtained when two well-fired bricks are struck against each other.
Runner	Person who carries slopmoulded bricks in mould to the drying ground.

Scove To cover over with mud. The name of the scove kiln originates from the practice of

scoving the outside bricks in order to stop the heat from escaping from the pile of bricks being fired.

Sesquioxides The oxides of aluminium and iron.

Shale Soft laminated slate-like rock, harder than most clays.

Short material Lacking plasticity, lean.

Siliceous Having a high proportion of silica.

Slake To fall apart when immersed in water.

Slip A thin slurry of clay in water; very wet and runny mix of clay.

Soak stage Period during which bricks are kept at a fixed elevated temperature in a kiln. Also immersion of bricks in water.

Soft-fired bricks Bricks heated in a kiln to a relatively low temperature; bricks so treated do not exhibit optimal physical properties.

Solar gain Heat obtained from the sun.

Sour Leave clay in contact with water for a long period.

Spall	Flake away from the surface.
Specific surface area	The total area of either the many fine particles or the many fine pores in a solid within a standard weight of the material.
Squat	The deformation of a clay near its vitrification point, especially the deformation of a pyrometric cone.
Strain	A measure of the change in size compared to the original size.
Strata	The various layers in a sedimentary deposit.
Stress	A measure of the force applied to produce strain in an object
Stretcher	The long face of a brick (not the bed face) showing in a wall.
Strike	The direction in a clay deposit in which the clay is at the same depth. Also a piece of wood for pushing off excess clay in slop moulding.
Striker	Piece of wood for pushing off excess clay in slop moulding.
Sump	A depression into which water may be drained off, or wastes deposited.
Surkhi	Soft-fired clay, around up, for mixing with lime to make mortar (Indian).

Temper	Leave in wet condition, often overnight or longer to make clay more workable and easier to mould.
Terracing	Benching.
Thermal capacity	A measure of the quantity of heat which an object can hold; high values in building components reduce temperature extremes within the building.
Tunnel kiln	Closed kiln or dryer through which the bricks are carried on wheeled cars.
Updraught kiln	A kiln in which the hot combustion gases pass upward through the bricks which are being fired.
Water-smoking	The first stages of heating in a kiln during which only a gentle heat is applied to remove remaining water from the green bricks.
Wicket	The doorway for access into a kiln. It is bricked up temporarily whilst the bricks are being fired.
Winning	Obtaining raw material from a deposit.
Worked out	Description applied to a deposit which has been completely dug.

APPENDIX II - Bibliographical references

- (1) Habitat: Global review of housing, conference on Human Settlements, Doc. No. A/CONF/70/A1 (Vancouver, 1976).**
- (2) United Nations Commission on Human Settlements: Report on Fifth Session, Habitat News (Nairobi), Vol. 4, No. 2, Aug.-Sep. 1982, p. 10.**
- (3) Sikander, A.S.; Quadeer, M.A.: "Squatter settlements - A functional view", in Vol. 2 of the Proceedings of a conference of the International Association for Housing Science held in Dharan in 1978, (New York, Wiley and Sons, 1982), pp. 437-446.**
- (4) UNIDO: Development of clay building materials industries in developing countries, report of seminar held in Copenhagen, Doc. No. ID/28 (Vienna, 1968).**
- (5) UNIDO: Establishment of the brick and tile industry, Doc. No. ID/15 (Vienna, 1969).**
- (6) UNIDO: Brickmaking plant. Industry profile. Development and transfer of technology series No. 10 (New York, 1978).**
- (7) Bender, W.: The planning of brickworks (Plymouth, Macdonald and Evans, 1978).**
- (8) Searle, A.B.: Modern brickmaking (London, Ernest Benn, 1956).**
- (9) UNIDO: Clay building materials industries in Africa, report of a workshop held in Tunis in 1970 (Vienna, 1971).**
- (10) Parry, J.P.M.: Brickmaking in developing countries (Garston, Watford, British Research Institute, 1979).**
- (11) Lunt, M.G.: Stabilised soil blocks for buildings. Overseas Building Note No. 184 (Garston, British Research Institute, 1980).**

(12) Smith, R.G.: "Small-scale production of gypsum plaster for building in the Cape Verde Islands" in Appropriate Technology (London, Intermediate Technology Development Group) 1982, Vol. 8, No. 4, pp. 4-6.

(13) Smith, R.G.: Long-term unrestrained expansion of test bricks in Transactions of the British Ceramic Society (London), 1973, Vol. 72, No. 1, pp. 1-5.,

(14) British Research Institute: "Materials for concrete" in Digest No. 237 (Garston, Watford), 1980, p. 237.

(15) British Research Institute: "Repairing brickworks" in Digest No. 200 (Garston), 1981, p. 2.

(16) Schumacher, E.F.: Small is beautiful: A study of economics as if people mattered (London, Blond and Briggs, 1973).

(17) Grimshaw, R.W.: The chemistry and physics of clay, (London, Ernest Benn, 1971).

(18) British Standards Institution: Methods of test for soils for engineering purposes Doc. No. BS1377 (London, 1975).

(19) Doat, P.; Hay, A.; Houben, H.; Matuk, S.; and Vitoux, F.: Construire en terre (Paris, Collection An-Architecture, 1979).

(20) Stulz, R.: Appropriate building materials. Publication No. 12 (St. Gall, Swiss Centre for Appropriate Technology 1981).

(21) Department of Housing and Urban Development, Office of International Affairs: Handbook for building houses of earth, (Washington, DC, n.d.).

(22) Knizek, I.: Brickmaking plant. Industry profile. Development and transfer of

technology series No. 10 (New York, UNIDO, 1978).

(23) Butterworth, B.: Methods of assessing the suitability of clays for brickmaking (London, Claycraft, 1947).

(24) Clews, F.H.: Heavy clay technology, (Stoke-on-Trent, British Ceramic Research Association, 1969).

(25) West, H.W.H.: Production technology - Winning, preparation and shaping of clay, Doc. No. ID/WG/81/4 (New York, UNIDO, 1970).

(26) Smith, R.G.: Brickmaking by Malagasy artisans and the establishment of a pilot centre (Geneva, ILO, 1980).

(27) Sedalia, B.M.: Structural clay industry (Bandung, United Nations Regional Housing Centre, 1976).

(28) Svare, T.I.: Better burnt bricks, technical pamphlet No. 1 (Dar-es-Salaam, National Housing and Building Research Unit, 1971).

(29) Harley, G.T.: "A study of shovelling" in Transactions of the British Ceramics Society (Stoke-on-Trent), 1932, Vol. 31, No. 1, pp. 1-35.

(30) Chatterjee, A.K.: "Clay preparation and product manufacture", in Small - Scale Building and Road Research News (Khumasi), 1977, Vol. 2, No. 2.

(31) Srinivasan S. and Jain L.C.: "Lime bursting in bricks" in Digest No. 113 (Roorke, India, Central Building Research Institute, 1975).

(32) Amonoo-Neizer, K.: Asokwa brick project, Special. Report No. SR 1/73 (Kumasi, Ghana, Building and Road Research Institute, 1973).

- (33) Woodforde, J.: Bricks to build a house (London, Routledge and Kegan Paul, 1976).
- (34) Hammond, M.: Bricks and brickmaking (Princes Risborough, United Kingdom, Shirs Publications, 1981).
- (35) Prakash, S.; Majundar, N.C.: "Manufacture of bricks of improved quality in Bhopal", in Journal of Engineers and Planners (New Delhi), 1974, Vol. 2, Nos. 8 & 9, pp. 27-30.
- (36) Indian Standards Institution: Specification for burnt clay facing bricks, Doc. No. IS 2691-1972 (New Delhi, 1972).
- (37) British Standards Institution: Specification for clay bricks and blocks, Doc. No. IS No. 3921-1974 (London, 1974).
- (38) Majumdar, N.C.; Wadhwa, S.S.; Hiralal, E.S.: "Manufacture of building bricks by a semi-mechanised process", in Transactions of the Indian Ceramics Society (New Delhi), 1969, Vol. XXVIII, No. 4, pp. 121-128.
- (39) Majumdar, N.C.; Hiralal, E.S.; Handa, S.K.: An appropriate technology for mechanised production of building bricks. Proceedings of a national seminar on building materials - their science and technology (New Delhi, 1982).
- (40) Thomas, D.W.: Small-scale manufacture of burned building brick (Arlington, Virginia, Volunteers in Technical Assistance, 1977).
- (41) Smith, R.G.: "Improved moulding devices for hand-made bricks", in Appropriate Technology (London, Intermediate Technology Publications), 1981 Vol. 7, No. 4.
- (42) Weller, H.O.; Campbell, A.J.: Brickmaking in East Africa (Nairobi, East African Industrial Research Board, 1945).

- (43) Baily, M.A.: "Brick manufacturing in Colombia: A case study of alternative technologies", in World Development (London, Pergamon Press), 1981, pp. 201-213.
- (44) Ford, R.W.: Drying, Institute of Ceramics Textbook series No. 3 (London, Maclaren, 1974).
- (45) Macey, H.H.: Drying in the heavy clay industry, National Brick Advisory Council Paper No. 3 (London, Her Majesty Stationary Office, 1950).
- (46) Small Industries Development Organisation: Burnt clay brickmaking, Rural Industries Guide No. 4 (Dar-es-Salaam, n.d.).
- (47) Schmidt, H.: "Measures to counteract defects in bricks during firing in Ziegelindustrie International, Issue No. 3, Mar. 1980, pp. 153-162.
- (48) Noble, W.: The firing of common bricks, National Brick Advisory Council Paper No. 4 (London, Her Majesty Stationary Office, 1950).
- (49) Jain, L.C.: "Effect of sodium chloride on the prevention of lime blowing" in Indian Ceramics (New Delhi), Mar. 1980, Vol. 17, No. 7, pp. 262-266.
- (50) Laird, R.T.; Worcester, M.: "The inhibiting of lime blowing in bricks" in Transactions of the British Ceramic Society, 1956, Vol. 55, No. 8.
- (51) Spence, R.J.S.: An investigation of the properties of rural and urban bricks, Paper No. TR9 (Lusaka, National Council for Scientific Research, 1971).
- (52) Gundry, D.G.: "Brickmaking on the farm" in Rhodesia Agricultural Journal (Harare), 1951, Vol. XLVIII, No. 4, pp. 330-343.
- (53) Hill, N.R.: "A clamp can be appropriate for the burning of bricks", in Appropriate

Technology, 1980, Vol. 7, No. 1,.

(54) Majumdar, N.C.: "Firing of Bull's Trench kilns", in Indian Builder, Sep. 1957.

(55) Indian Standard Institution: Guide for the design and manufacture of brick kilns, Doc. No. IS 4805-1968 (New Delhi, 1968).

(56) Spence, R.J.S.: "Brick manufacture using the bull's trench kiln", in Appropriate Technology, 1975, Vol. 2, No. 1.

(57) "New archless continuous kiln", in British Clayworker (London), May 1929.

(58) Majumdar, N.C.; Hiralal, E.S.: "High draught kiln: its operation, control and economics", in Brick and Tiles News (Roorke, India, Central Building Research Institute), 1980, pp. 47-51.

(59) Salmang, H.: Ceramics: physical and chemical fundamentals (London, Butterworths, 1961).

(60) FAO: Yearbook 1981 (Rome, 1982).

(61) Madibbo, A.M.; Richter, M.: "Fired clay bricks in the Sudan", in Building Research Digest (Khartoum, National Building Research Station), 1970, No. 6, Phase 1.

(62) Rad, P.F.: "A simple technique for determining strength of brick", in Proceedings of the North American Masonry Conference (1978) Part. 40, pp. 1-10.

(63) Jain, L.C.: "Accelerated test for lime blowing", in British Clayworker, 1971, Vol. 80, No. 947, pp. 40-41.

(64) Butterworth, B.: "The frost resistance of bricks and tiles - A review", in Journal of the

British Ceramic Society (Stoke-on-Trent), 1964, Vol. 1, No. 2, pp. 203-223.

(65) Spence, R.J.S.: Small-scale production of cementitious materials (London, Intermediate Technology Publications, 1980).

(66) Smith, R.G.: Rice husk ash cement (Rugby, United Kingdom, Intermediate Technology Industrial Service, 1983).

(67) Central Building Research Institute: Cementitious binder from waste lime sludge and rice husk, Technical Note No. 72,(Roorke, India, 2nd edition, 1980).

(68) Spence, R.J.S.: Alternative cements in India (London, Intermediate Technology Development Group, 1976).

(69) Indian Standards Institution: Specification for lime pozzolana mixture, No. IS 4098-1967 (New Delhi, 1967).

(70) Beningfield, N.: Aspects of cement-based mortars for brickwork and blockwork concrete (London, 1980).

(71) Smith, R.G.: Gypsum, Proceedings of a meeting on small-scale manufacture of cementitious materials (London, Intermediate Technology Publications, 1974).

(72) British Standards Institution: Specification for masonry cement, Doc. No. BS 5224-1976 (London, 1976).

(73) British Standards Institution: Code of practice for structural use of masonry, Part 1: Unreinforced Masonry, Doc. No. BS 5628 Ptl-1978 (London, 1978).

(74) Butterworth, B.: The properties of clay building materials. Paper presented to a Ceramics Symposium (Stoke-on-Trent, British Ceramic Society, 1953).

(75) Macey, H.H.; Green, A.T.: The labour involved in making and firing common bricks, National Brick Advisory Council Paper No. 2 (London, HMSO, 1947).

(76) Centro Nacional de la Construcción: Diagnosis of the economic and technological State of the Colombian brickmaking industry, Doc. No. GEN 10-76 (Bogota, 1976).

(77) Parry, J.P.M.: Technical options in brick and tile production, Paper presented to an Intermediate Technology Workshop (Birmingham, 1983).

(78) Keddie, J.; Cleghorn, W.: "Least cost brickmaking", in Appropriate Technology, 1978, Vol. 5, No. 3, pp. 24-27.

(79) British Research Establishment: Building research centres and similar organisations throughout the world, Overseas Building Note No. 163 (Garston, Watford, 1978).

(80) UNIDO: Information sources on the ceramics industry, Guide to Information Sources No. 17 (New York, 1975).

APPENDIX III - Institutes from where information can be obtained

ARGENTINA

**Association Tecnica Argentina de Ceramica,
Talcahuano 847,
P.B. Buenos Aires.**

AUSTRALIA

**Division of Building Research,
CSIRO,
Graham Road,**

Highett, Victoria 3190.

AUSTRIA

**United Nations Industrial Development Organisation,
Vienna International Centre,
P.O. Box 400,
A-1400 Vienna.**

BOTSWANA

**Ministry of Local Government and Lands,
Private Bag 006,
Gaborone.**

COLOMBIA

**National Centre for Construction Studies,
Ciudad Universitaria C1145-Cra 30,
Edificio CINVA,
AA34219 Bogota.**

EGYPT

**General Organisation for Housing, Building and Planning Research,
P.O. Box 1170,
El-Tahreer Street, Dokky,
Cairo.**

FRANCE

**Centre Technique des Tuiles et Briques,
2, avenue Hoche,
75008 Paris.**

**International Union of Testing and Research Laboratories (RILEM),
12, rue Brancion,
75737 Paris**

FEDERAL REPUBLIC OF GERMANY

**Institut fr Ziegelforschung, Essen e V, Am Zehnthof,
4300 Essen-Kray.**

GHANA

**Building and Road Research Institute,
University, P.O. Box 40,
Kumasi.**

INDIA

**Central Building Research Institute,
Roorke (Uttar Pradesh), 277672.**

INDONESIA

**Directorate of Building Research,
United Nations Regional Housing Centre,
P.O. Box 15,
84 Jalan Tamansari,**

Bandung.

IRAQ

**Building Research Centre,
P.O. Box 127,
Jadiriya, Bagdad.**

ISRAEL

**Building Research Station,
Israel Institute of Technology,
Technion City, Haifa.**

IVORY COAST

**Socit des Briqueteries de Cte d'Ivoire,
B.P. 10303,
Abidjan.**

JORDAN

**Building Materials Research Centre,
Royal Scientific Society,
P.O. Box 6945,
Amman.**

MADAGASCAR

**Centre National de l'Artisanat Malagasy,
B.P. 540,**

Antananarivo.

MALAWI

**Malawi Housing Corporation,
P.O. Box 414,
Blantyre.**

NETHERLANDS

**International Council for Building Research Studies and Documentation (CIB),
Weena 704, Post Box 20704,
3001 JA Rotterdam.**

PAKISTAN

**Pakistan Council for Scientific and Industrial Research,
Off University Road,
Karachi 39.**

PAPUA NEW GUINEA

**Department of Public Works,
P.O. Box 1108,
Boroko.**

PHILIPPINES

**Ceramic Association of the Philippines,
P.O. Box 499,
Makati, Rizal.**

SUDAN

**Building and Road Research Institute,
University of Khartoum,
P.O. Box 35,
Khartoum**

SWITZERLAND

**Technology and Employment Branch,
International Labour Office,
CH-1211 Geneva 22.**

**International Standard Organisation,
1, rue de Varemb,
CH-1211 Geneva**

TANZANIA

**Small Industries Development Organisation,
P.O. Box 2476,
Dar-es-Salaam.**

THAILAND

**Applied Scientific Research Corporation of Thailand
196 Phahonyothin Road,
Bankkhen,
Bangkok.**

TRINIDAD

**Caribbean Industrial Research Institute,
Post office box,
Tunapuna.**

UNITED KINGDOM

**British Ceramic Research Association,
Queens Road,
Penkhull,
Stoke-on-Trent ST4 7LG.**

**Building Research Establishment,
Bucknalls Lane,
Garston, Watford, Herts WD2 7JR.**

**Intermediate Technology Development Group,
9, King Street,
Covent Garden, London WC2E 8HN.**

**Intermediate Technology Workshop,
Corngreaves Trading Estate,
Overend Road,
Warley, West Midlands B64 7DD.**

UNITED STATES

**American Ceramic Society, Inc.,
4055 North High Street,**

Columbus, Ohio 43214.

**Volunteers in Technical Assistance,
1815 N. Lynn Street,
Suite 200,
P.O. Box 12438,
Arlington, Virginia 22209**

UPPER VOLTA

**Socit Voltaque de Briqueterie et de Cramique
B.P. 148,
Ouagadougou.**

ZAMBIA

**National Council for Scientific Research,
P.O. Box CH 158,
Chelston, Lusaka.**

APPENDIX IV - List of equipment suppliers

AUSTRALIA

**Automet Industries Pty Ltd.,
P.O. Box 68,
88 Beattie Street,
Balmain NSW 2014,**

Type of equipment

General equipment

BELGIUM

General equipment

20/10/2011

[meister10.htm](#)

Sa Samic,
Hanswijvaart 21,
2800 Mechelen

DENMARK

Niro Atomizer A/S,
Gladsaxevej 305,
DK-2860 Soeborg

General equipment

FRANCE

CERIC International,
18, rue Royale,
75008 Paris

General equipment

GHANA

Agricultural Engineers,
Accra

Trough mixer

INDIA

Raj Clay Products,
5 Mill Officers' Colony,
Ashram Road,
Navrangpura,
Ahmedabad 380009

Semi-mechanised equipment

ITALY

General equipment

20/10/2011

meister10.htm

Unimorando Consortium,
Corson Don Minzoni 182,
14100 Asti

KENYA

Christian Industrial Training Centre (CITC),
Meru Road, Pumwani
P.O. Box 729935
Nairobi

Crusher, table mould

NETHERLANDS

Joh's Aberson bv.,
8120 AA, Olst

Soft mud

UNITED KINGDOM

Craven Fawcett Ltd.,
P.O. Box 21, Dewsbury Road,
Wakefield, Yorkshire, WF2 9BD

General equipment

William Boulton Ltd,
Providence Engineering Works,
Burslem,
Stoke-on-Trent, Staffs, ST6 3BQ

General equipment

Croker Ltd.,
Runnings Road,
Cheltenham, Glos.

Pan mixer

British Ceramic Plant Manufacturers's
Association,
P.O. Box 107,
Broadstone, Dorset BH18 8LQ

General information service

W.G. Cannon,
Broadway House,
The Broadway,
London SW19

Fans

Auto Combustions Hoistrack Ltd,
Hartcourt,
Halesfield 13,
Telford, Salop. TF7 4QR

Oil burners

Intermediate Technology Workshops,
J.P.M. Marry and Assts. Ltd.,
Overend Road,
Cradley Heath, West Midlands B64 7DD

Crusher, table moulds,
Handling equipment.

Allied Insulators,
Albion works,
Uttoxeter Road,
Longton, Stoke-on-Trent ST3 1HP

Pyrometric cones and rings

Bair and Tatlock Ltd..

General laboratory equipment

20/10/2011

meister10.htm

Freshwater Road, Chadwell Heath, Essex

William Boulton Ltd.,
Providence Engineering Works,
Burslem, Stoke-on-Trent, Staff ST6 3BQ

Clay machinery

Podmore and Sons Ltd., Shelton,
Stoke-on-Trent ST1 4PQ

Clay machinery

British Ceramics Service Co. Ltd.,
Bricesco House,
Park Avenue,
Wolstanton,
Newcastle-under-Lyme, Staffs, ST4 8AT

Kilns

Kilns and Furnaces Ltd.,
Keele Street,
Tunstall,
Stoke-on-Trent, Staffs, ST6 5AS

Kilns

Leonard Farnell and Co. Ltd.,
Station Road,
North Mymms,
Hatfield, Herts AL9 7SR

Testing apparatus and augers

UNITED STATES

Interkiln Corporation of America,

General equipment

P.O. Box 2048,
Houston, Texas 77252

ZIMBABWE

World Radio Systems,
Bush House, 72-72 Cameron Street,
P.O. Box 2772,
Harare

Crusher, table moulds



[Home](#) > [ar.cn.de.en.es.fr.id.it.ph.po.ru.sw](#)



Small-Scale Brickmaking (ILO - WEP, 1984, 228 p.)

 **(introduction...)**

 **ACKNOWLEDGEMENTS**

 **PREFACE**

 **CHAPTER I - INTRODUCTION**

 **CHAPTER II - RAW MATERIALS**

 **CHAPTER III - QUARRYING TECHNIQUES**

 **CHAPTER IV - CLAY PREPARATION**

 **CHAPTER V - SHAPING**

 **CHAPTER VI - DRYING**

 **CHAPTER VII - FIRING**

 **CHAPTER VIII - MORTARS AND RENDERINGS**

 **CHAPTER IX - ORGANISATION OF PRODUCTION**

 **CHAPTER X - METHODOLOGICAL FRAMEWORK FOR THE**

ESTIMATION OF UNIT PRODUCTION COSTS

 **CHAPTER XI - SOCIO-ECONOMIC IMPACT OF ALTERNATIVE BRICK MANUFACTURING TECHNIQUES**

 **APPENDICES**

  **QUESTIONNAIRE**

 **OTHER ILO PUBLICATIONS**

 **BACK COVER**

QUESTIONNAIRE

1. Full name _____

2. Address _____

3. Profession (check the appropriate case)

Established brickmaker _____

If yes, indicate scale of production _____

Government official _____

If yes, specify position _____

Employee of a financial institution _____

If yes, specify position _____

University staff member

Staff member of a technology institution _____
If yes, indicate name of institution _____

Staff member of a training institution _____
If yes, specify _____

Other, specify _____

4. From where did you get a copy of this memorandum?

Specify if obtained free or bought

5. Did the memorandum help you achieve the following:

(Check the appropriate case)

Learn about brickmaking techniques you were not aware of

Obtain names of equipment suppliers

Estimate unit production costs for various scales of production/technologies

Order equipment for local manufacture

Improve your current production technique

Cut down operating costs

Improve the quality of produced bricks

Decide which scale of production/technology to adopt for a new brickmaking plant

If a Government employee, to formulate new measures and policies for the brickmaking industry

If an employee of a financial institution, to assess a request of a loan for the establishment of a brickmaking plant

If a trainer in a training institution, to use the memorandum as a supplementary training material

If an international expert, to better advise counterparts on brickmaking technologies

6. Is the memorandum detailed enough in terms of:

Yes

No

- Description of technical aspects _____

- Names of equipment suppliers _____

- Costing information _____

- Information on socio-economic impact _____

- Bibliographical information _____

If some of the answers are 'No', please indicate why below or on a separate sheet:

7. How may this memorandum be improved if a second edition is to be published?

8. Please send this questionnaire, duly completed to:

**Technology and Employment Branch
International Labour Office
CH-1211 GENEVA 22 (Switzerland)**

9. In case you need additional information on some of the issues covered by this memorandum, the ILO would do its best to provide the requested information.



[Home](#) > [ar](#).[cn](#).[de](#).[en](#).[es](#).[fr](#).[id](#).[it](#).[ph](#).[po](#).[ru](#).[sw](#)

 **Small-Scale Brickmaking (ILO - WEP, 1984, 228 p.)**

 **(introduction...)**

 **ACKNOWLEDGEMENTS**

 **PREFACE**



- ☐ **CHAPTER I - INTRODUCTION**
- ☐ **CHAPTER II - RAW MATERIALS**
- ☐ **CHAPTER III - QUARRYING TECHNIQUES**
- ☐ **CHAPTER IV - CLAY PREPARATION**
- ☐ **CHAPTER V - SHAPING**
- ☐ **CHAPTER VI - DRYING**
- ☐ **CHAPTER VII - FIRING**
- ☐ **CHAPTER VIII - MORTARS AND RENDERINGS**
- ☐ **CHAPTER IX - ORGANISATION OF PRODUCTION**
- ☐ **CHAPTER X - METHODOLOGICAL FRAMEWORK FOR THE ESTIMATION OF UNIT PRODUCTION COSTS**
- ☐ **CHAPTER XI - SOCIO-ECONOMIC IMPACT OF ALTERNATIVE BRICK MANUFACTURING TECHNIQUES**
- ☐ **APPENDICES**
- 📄 **QUESTIONNAIRE**
- ➔ 📄 **OTHER ILO PUBLICATIONS**
- 📄 **BACK COVER**

OTHER ILO PUBLICATIONS

Technology Series

The object of the technical memoranda in this series is to help to disseminate, among small-scale producers, extension officers and project evaluators, information on small-scale processing technologies that are appropriate to the socio-economic conditions of developing countries.

ISSN 0252-2004**Small-scale processing of fish (Technology Series - Technical Memorandum No. 3)**

This technical memorandum covers, in detail, technologies that are suitable for the small-scale processing of fish: that is, drying, salting, smoking, boiling and fermenting. Thermal processing is described only briefly, as it is used mainly in large-scale production. Enough information is given about the technologies to meet most of the needs of small-scale processors. Two chapters of interest to public planners compare, from a socio-economic viewpoint, the various technologies described in the memorandum and analyse their impact on the environment.

ISBN 92-2-103205-1**17.50 Swiss francs****Small-scale oil extraction from groundnuts and copra (Technology Series - Technical Memorandum No. 5)**

Covers, in detail, various technologies for the extraction of oil from groundnuts and copra: baby expeller mills, small package expellers and power ghanis. Three main stages of processing are considered, namely the pre-processing stages (drying, crushing, scorching), the oil extraction stage and the post-treatment stages (filtering, cake breaking, packaging, bagging). The economic and technical details provided on the stages of processing should help would-be or practising small-scale producers to identify and apply the oil extraction technology best suited to local conditions. A chapter of interest to public planners compares small-scale plants and large-scale plants from a socio-economic viewpoint and suggests various policy measures for the promotion of the right mix of oil extraction techniques.

ISBN 92-2-103503-4**17.50 Swiss francs****Small-scale maize milling (Technology Series - Technical Memorandum No. 7)**

Provides detailed information on alternative techniques for the production of whole meal, bolted meal and super-sifted meal. It covers all processing stages, including grain preparation, shelling, milling, sifting and packaging. The techniques described are mostly of interest to custom mills and small-scale merchant mills located in rural and urban areas. The first chapter of the memorandum gives in-depth information on the effects of different maize-milling techniques, including the nutritional value of various kinds of maize meal, employment generation, foreign exchange savings and so on. It also provides some general guide-lines for the formulation and implementation of measures for the promotion of appropriate maize-milling techniques.

ISBN 92-2-103640-5**17.50 Swiss francs****Small-scale paper-making (Technology Series - Technical Memorandum No. 8)**

Provides technical and economic information on alternative paper-making technologies, describes the characteristics of various types and grades of paper products and gives guidance in the choice of paper machines. The information relates mostly to small-scale paper mills with a capacity of 30 tonnes of paper per day or less. The raw materials suggested for such mills include straw, bagasse, waste paper, rags and cotton waste, as well as other agricultural residues and imported wood pulp. Unlike other memoranda in the series, this memorandum is not a technical introduction to paper-making in general, nor is it a basic textbook on the subject. Instead, it provides people already in possession

of the necessary background knowledge with criteria for choosing amongst different methods of paper-making.

ISBN 92-2-103971-4

22.50 Swiss francs

Small-scale processing of pork (Technology Series - Technical Memorandum No. 9)

Provides detailed technical information on small-scale technologies for the production of a variety of pig-meat products, including fresh sausage, Mortadella, ham, bacon, Metwurst and so on. Information is provided on the raw materials required, processing equipment, plant layout and hygiene, and the processing stages for each pig-meat product. A methodological framework for the evaluation of alternative meat processing technologies and scales of production is included for the benefit of potential meat processors. The focus is placed on the establishment of pork processing units which operate as a separate business. However, with some adaptation, the information supplied should also allow planners to assess the feasibility of attaching a processing unit to an existing slaughterhouse or butchery business.

ISBN 92-2-100542-9

20 Swiss francs

Small-scale processing of beef (Technology Series - Technical Memorandum No. 10)

Provides detailed technical information on small-scale technologies for the production of a variety of beef products, including beefburgers, chill con carne, biltong, charqui, frankfurters, beef cervelat and so on. Information is provided on the raw materials required, processing equipment, plant layout and hygiene, and the processing stages for

each beef product. A methodological framework for the evaluation of alternative meat processing technologies and scales of production is included for the benefit of potential meat processors. The focus is placed on the establishment of beef processing units which operate as a separate business. However, with some adaptation, the information supplied should also allow planners to assess the feasibility of attaching a processing unit to an existing slaughterhouse or butchery business.

ISBN 92-2-105050-5

20 Swiss francs



[Home](#) > [ar](#) [cn](#) [de](#) [en](#) [es](#) [fr](#) [id](#) [it](#) [ph](#) [po](#) [ru](#) [sw](#)

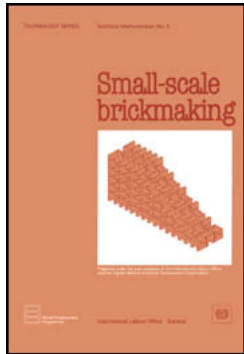

 **Small-Scale Brickmaking (ILO - WEP, 1984, 228 p.)**

 *(introduction...)*

 **ACKNOWLEDGEMENTS**

 **PREFACE**

 **CHAPTER I - INTRODUCTION**

 **CHAPTER II - RAW MATERIALS**

 **CHAPTER III - QUARRYING TECHNIQUES**

 **CHAPTER IV - CLAY PREPARATION**

 **CHAPTER V - SHAPING**

 **CHAPTER VI - DRYING**

 **CHAPTER VII - FIRING**

 **CHAPTER VIII - MORTARS AND RENDERINGS**



- ❏ **CHAPTER IX - ORGANISATION OF PRODUCTION**
- ❏ **CHAPTER X - METHODOLOGICAL FRAMEWORK FOR THE ESTIMATION OF UNIT PRODUCTION COSTS**
- ❏ **CHAPTER XI - SOCIO-ECONOMIC IMPACT OF ALTERNATIVE BRICK MANUFACTURING TECHNIQUES**
- ❏ **APPENDICES**
- 📄 **QUESTIONNAIRE**
- 📄 **OTHER ILO PUBLICATIONS**
- ➔ 📄 **BACK COVER**

BACK COVER

Small-scale brickmaking

This technical memorandum, which forms part of a series being prepared jointly by the ILO and UNIDO, is the first of three on building materials for low-cost housing. The object of the series is to acquaint small-scale producers with alternative production techniques for specific products and processes, so as to help them to choose and apply those techniques which are most appropriate to local socio-economic conditions.

The memorandum provides detailed technical information on alternative brickmaking techniques and covers all processing stages, including quarrying, clay preparation, moulding, drying, firing and testing finished bricks. The techniques described are mostly of interest to small-scale producers in both rural and urban areas. The processes and equipment are described in great detail, with drawings of equipment and tools which may be produced locally, floor plans, information on labour and skill requirements, materials and fuel inputs per unit of output, and so on. A list of equipment suppliers in both developed and developing countries is also supplied to help the would-be brickmaker to import the equipment he needs. A chapter of interest to public planners compares, from a

socio-economic viewpoint, the various brickmaking techniques described in the memorandum.

It is hoped that the information contained in this memorandum will help would-be or practising brickmakers to choose and apply brickmaking techniques that minimise production costs while improving the quality of the finished bricks.

ISBN 92-2-103567-0



[Home](#) > [ar](#).[cn](#).[de](#).[en](#).[es](#).[fr](#).[id](#).[it](#).[ph](#).[po](#).[ru](#).[sw](#)



 **Small-Scale Brickmaking (ILO - WEP, 1984, 228 p.)**

 **(introduction...)**

  **ACKNOWLEDGEMENTS**

 **PREFACE**

 **CHAPTER I - INTRODUCTION**

 **CHAPTER II - RAW MATERIALS**

 **CHAPTER III - QUARRYING TECHNIQUES**

 **CHAPTER IV - CLAY PREPARATION**

 **CHAPTER V - SHAPING**

 **CHAPTER VI - DRYING**

 **CHAPTER VII - FIRING**

 **CHAPTER VIII - MORTARS AND RENDERINGS**

 **CHAPTER IX - ORGANISATION OF PRODUCTION**

 **CHAPTER X - METHODOLOGICAL FRAMEWORK FOR THE**

- 📁 **ESTIMATION OF UNIT PRODUCTION COSTS**
- 📁 **CHAPTER XI - SOCIO-ECONOMIC IMPACT OF ALTERNATIVE BRICK MANUFACTURING TECHNIQUES**
- 📁 **APPENDICES**
- 📄 **QUESTIONNAIRE**
- 📄 **OTHER ILO PUBLICATIONS**
- 📄 **BACK COVER**

ACKNOWLEDGEMENTS









The publication of this memorandum has been made possible by a grant from the Swedish International Development Authority (SIDA). The International Labour Office and the United Nations Industrial Development Organisation acknowledge this generous support.



[Home](#) > [ar.cn.de.en.es.fr.id.it.ph.po.ru.sw](#)



- 📖 **Small-Scale Brickmaking (ILO - WEP, 1984, 228 p.)**
- 📄 *(introduction...)*
- 📄 **ACKNOWLEDGEMENTS**
- ➔ 📄 **PREFACE**
- 📁 **CHAPTER I - INTRODUCTION**
- 📁 **CHAPTER II - RAW MATERIALS**
- 📁 **CHAPTER III - QUARRYING TECHNIQUES**
- 📁 **CHAPTER IV - CLAY PREPARATION**
- 📁 **CHAPTER V - SHAPING**
- 📁 **CHAPTER VI - DRYING**

-  **CHAPTER VII - FIRING**
-  **CHAPTER VIII - MORTARS AND RENDERINGS**
-  **CHAPTER IX - ORGANISATION OF PRODUCTION**
-  **CHAPTER X - METHODOLOGICAL FRAMEWORK FOR THE ESTIMATION OF UNIT PRODUCTION COSTS**
-  **CHAPTER XI - SOCIO-ECONOMIC IMPACT OF ALTERNATIVE BRICK MANUFACTURING TECHNIQUES**
-  **APPENDICES**
-  **QUESTIONNAIRE**
-  **OTHER ILO PUBLICATIONS**
-  **BACK COVER**

PREFACE

This technical memorandum on small-scale brickmaking is the sixth of a series of memoranda being currently prepared by the ILO and UNIDO. It is the first of three technical memoranda on building materials for low-cost housing.¹

¹The other two technical memoranda, currently under preparation, cover respectively the production of stabilised earth blocks and that of windows and doors.

The main objective of technical memoranda is to provide small-scale producers in developing countries with detailed technical information on small-scale technologies, which have been successfully applied in a number of countries, but are not well known outside the latter. A secondary objective is to assist public planners identify and promote technologies consonant with national socio-economic objectives, such as employment

generation, foreign exchange savings, rural industrialisation, or the fulfilment of the basic needs of low-income groups.

The information contained in the memoranda is detailed enough to ensure that small-scale producers should be able, in a large number of cases, to identify and apply the technologies described in the memoranda without the need for further information. Thus, detailed drawings of equipment, which may be manufactured locally, are provided, while a list of equipment suppliers, from both developed and developing countries, may be used for the acquisition of equipment which must be imported. In the few instances where the available information is not sufficient, the reader may obtain additional technical details, from publications listed in the bibliography or from technology institutions identified in a separate appendix of the memoranda.

Technical memoranda are not intended as training manuals. It is assumed that the potential users of the technologies described in the memoranda are trained practitioners and that the memoranda are only supposed to provide them with information on alternative technological choices. Memoranda may, however, be used as complementary training material by training institutions.

This technical memorandum on small-scale brick manufacturing is of particular importance to developing countries as low-cost housing constitutes one of the most important basic needs of low-income groups, and bricks are particularly suitable materials for the construction of this type of housing. Furthermore, the adoption of small-scale brickmaking techniques should generate substantial employment, especially in rural areas. It is hoped that the information contained in this memorandum will slow down the adoption of large-scale, capital-intensive, turnkey brickmaking plants which have often proved to be unsuitable for conditions prevailing in the majority of developing countries.

This memorandum contains 11 chapters, nine of these dealing with the various

subprocesses in brick manufacturing. Chapter X provides a methodological framework for the estimation of the unit production cost of bricks, using the technical data from the previous chapters. It is of particular interest to potential brickmakers who wish to identify the least-cost or most profitable production technique. Chapter XI is mostly intended for public planners and project evaluators from industrial development agencies who wish to obtain information on the various socio-economic effects of alternative brickmaking techniques with a view to identifying and promoting those which are particularly suitable to local socio-economic conditions.

This memorandum also contains four appendices which could be of interest to the reader. Appendix I provides a glossary of technical terms, and should therefore be of assistance to non-specialists. Appendices II and III provide sources of additional information, either from available publications (Appendix II) or from specialised technology institutions (Appendix III). Finally, Appendix IV provides a list of equipment suppliers from both developing and developed countries. It may be noted that this list is far from being exhaustive, and that it does not imply a special endorsement of these suppliers by the ILO. The listed names are only provided for illustrative purposes, and brickmakers should try to obtain information from as many suppliers as feasible.

A questionnaire is attached at the end of the memorandum for those readers who may wish to send to the ILO or UNIDO their comments and observations on the content and usefulness of this publication. These will be taken into consideration in the future preparation of additional technical memoranda.

This memorandum was prepared by Mr. R.G. Smith (consultant) in collaboration with Mr. M. Allal, staff member in charge of the preparation of the Technical Memoranda series within the Technology and Employment Branch of the International Labour Office.

A. S. Bhalla,

**Chief,
Technology and Employment Branch.**



[Home](#) > [ar](#) [cn](#) [de](#) [en](#) [es](#) [fr](#) [id](#) [it](#) [ph](#) [po](#) [ru](#) [sw](#)



 **Small-Scale Brickmaking (ILO - WEP, 1984, 228 p.)**

➔  **CHAPTER I - INTRODUCTION**

-  **I. Purpose and objectives of the memorandum**
-  **II. Target audience**
-  **III. Comparison between bricks and other building materials**
-  **IV. Scales of production covered by this memorandum**
-  **V. Content of the memorandum**

Small-Scale Brickmaking (ILO - WEP, 1984, 228 p.)

CHAPTER I - INTRODUCTION

I. Purpose and objectives of the memorandum

Housing constitutes one of the most important basic needs of low-income groups in developing countries. However, it is the most difficult to satisfy as land and building costs are often outside the means of the unemployed and underemployed in both rural and urban areas. Thus, many governments have launched various schemes with a view to facilitating housing ownership by low-income groups, including self-help housing

schemes, granting of housing subsidies, provision of credit at low interest rates, etc. Given the limited means at the disposal of governments and potential home owners, it is important to seek ways to lower the cost of low-income housing while minimising repair and maintenance costs. In particular, governments should promote the production and use of cheap yet durable building materials as the latter constitute a very large proportion of total low-income housing costs in developing countries (1). Furthermore, it would be useful if the production of these building materials could contribute to the fulfilment of important development objectives of these countries, such as the generation of productive employment, rural industrialisation, and a decreased dependence on essential imports.

A number of traditional building materials exist which have proved themselves to be the most suitable materials for use in a wide variety of situations, and have a great potential for increased use in the future. These traditional materials, which make use of locally available raw materials, can be manufactured close to the construction site with little equipment (which may be produced locally), and are often more appropriate to the environment than modern materials. One such building material is clay bricks. The purpose of this technical memorandum is to provide detailed technical and economic information on small-scale brick manufacturing with a view to assisting rural and urban entrepreneurs to start up new plants or improving their production techniques. It is also hoped that the information contained in this memorandum will help slow down the establishment of large-scale, capital-intensive plants which are not always suitable to socio-economic conditions of developing countries.

I.1 Need for improved brick production techniques

Various production methods are used for brickmaking in developing countries. Traditional hand digging, moulding and handling are used by a large number of small production units. Some larger units tend to use equipment for digging or mixing, while a number of developing countries have chosen to import large-scale capital-intensive plants.

The choice of brickmaking technology is mostly a function of market demand (e.g. scale and location of demand, required quality standard), availability of investment funds, and unit production costs associated with alternative production techniques. In some cases, governments may also impose various policy measures with a view to favouring the adoption of techniques consonant with the national development objectives. Whatever the adopted technique, quality may be improved and costs reduced if appropriate measures are taken during the production process.

Experience shows that a large fraction of bricks are often wasted during the various production stages. For example, moulded bricks get eroded by the rain before firing or distorted by bad handling methods. Sometimes, incorrectly adjusted machines yield inconsistent or inferior output which may not be marketed. With attention to the basic principles of brickmaking and more care, a greater number of bricks could be produced for the same expenditure of labour, raw materials and fuel.

In some instances, more careful preparation of raw materials would minimise problems at subsequent manufacturing stages. For example, if stones or hard dry lumps of clay are included in the moist clay used for moulding, they will exhibit different drying shrinkages from the moist clay and give rise to cracks in the dried or fired bricks. The remedy in such a case would have been to select a more uniform raw material, or to remove the offending particles, or to break the material down to a fine size (e.g. by manual means or with a crushing machine).

Use of a good product, of regular shape and size and of consistent properties, will enable the accurate building of walls while minimising the use of mortar between bricks. Renderings, often applied in developing countries, will also require less mix for a given wall area if the brickwork face is accurate. Alternatively, if the brick quality is sufficiently good, it may be unnecessary to apply renderings at all. A good product will thus favourably impress the customer and save materials, time and money. It should therefore

improve future demand for the product. Good bricks should be durable and brickwork should be long lasting.

I.2 Availability of information on brickmaking

The techniques of brickmaking are often handed down from father to son in small works, or are taught in various technical schools, training centres, etc. Articles and books have been published(2) but are often too brief or mostly concerned with large-scale production, scientific investigations or laboratory tests. They also often relate to conditions and needs of the more developed countries. With few exceptions(3), there is a lack of information on practical details of small-scale production in rural or peri-urban areas.

Information on sophisticated high capital cost brickmaking plants can be obtained from published books and scientific and trade journals, or from equipment manufacturers and consultants. On the other hand, it is more difficult to obtain information on small-scale, labour-intensive production. Many appropriate technology institutes, building research centres and university departments do generate information on appropriate production techniques (see list in Appendix III). However, this information is either not published or is not disseminated to other developing countries. This memorandum seeks, therefore, to provide information on small-scale brickmaking with a view to partially filling the current information gap. It does not provide technical details on all possible circumstances, but will, it may be hoped, induce small-scale producers to try production techniques which have already been successfully adopted in a number of developing countries.

II. Target audience

This memorandum is intended for several groups of individuals in developing countries, including the following:

- small-scale brickmaking producers in rural and urban areas, and those**

considering starting brick production. These could be either individual entrepreneurs or groups of artisans associated in a manufacturing co-operative. These producers will be mostly interested in the information contained in Chapters II to VII, and Chapters IX and X.

- housing authorities, public planners and project evaluators in various industrial development agencies may be interested in the information contained in Chapters II and XI. This latter chapter, which focuses on the socio-economic implications of alternative brickmaking techniques, will be of particular interest to public planners concerned with employment generation, foreign exchange saving, etc.

- financial institutions, businessmen, government officials and banks should be mostly interested in Chapter X which provides the necessary information for costing alternative production techniques.

- handicraft promotion institutions, village crafts organisations and equipment manufacturers should find the technical chapters II to VII useful.

- voluntary organisations, foreign experts, extension workers and staff of technical colleges will wish to compare bricks with other building materials, as detailed in Chapter I (section III). They may also benefit from the technical information contained in Chapters II to VII.

It must be stressed that this is not a technical memorandum on the use of bricks in building, although some of the information contained in Chapter VIII may be of interest to builders.

III. Comparison between bricks and other building materials

This section compares the properties of fired clay bricks with those of other alternative

walling materials. Table I.1 gives specific values for some of the properties discussed below. This comparison should be useful to housing authorities in deciding which building materials should be most appropriate for various types of housing or housing projects.

III.1. Strength

Compressive strength of fired-clay bricks varies enormously, depending upon clay type and processing. Strength requirements for single-storey housing are easily met.

Calcium silicate bricks, made from sand with high silica content and good quality, low magnesia, lime, may have strengths approaching those of good fired clay bricks. However, high capital cost machinery is used for the mixing, pressing and autoclaving. Furthermore, calcium silicate bricks must be produced in large-scale plants.

Concrete bricks and blocks have sufficient strength, but require cement which is expensive, and must often be imported.

Lightweight concrete blocks, made with either natural or artificial lightweight aggregate, have adequate strength but require cement.

Aerated concrete has low strength which may be sufficient for one-storey buildings. Particularly careful production control is necessary, using autoclaving to reduce subsequent moisture shrinkage of blocks made from this material.

Many types of soil have sufficient compressive strength when dry. However, this strength is considerably reduced once they become saturated with water.

Table I.1

Range of properties of bricks and blocks

Property	Fired clay bricks	Calcium silicate bricks	Dense concrete bricks	Aerated concrete blocks	Lightweight concrete blocks	Stabilised soil blocks
Wet compressive strength (MN/m ²)	10 to 60	10 to 55	7 to 50	2 to 6	2 to 20	1 to 40
Reversible moisture movement (% linear)	0 to 0.02	0.01 to 0.035	0.02 to 0.05	0.05 to 0.10	0.04 to 0.08	0.02 to 0.2
Density (g/cm ³)	1.4 to 2.4	1.6 to 2.1	1.7 to 2.2	0.4 to 0.9	0.6 to 1.6	1.5 to 1.9
Thermal conductivity (W/m°C)	0.7 to 1.3	1.1 to 1.6	1.0 to 1.7	0.1 to 0.2	0.15 to 0.7	0.5 to 0.7
Durability under severe natural exposure	Excellent to very poor	Good to moderate	Good to poor	Good to moderate	Good to poor	Good to very poor

Waterproofers such as bitumen, or stabilisers such as lime or cement, may be used with certain soils to improve wet strength. On the other hand, the strength of the other previously mentioned materials is only reduced slightly when they are wetted.

Gypsum, which occurs as a soft rock, or in some places as a fine sand, can be converted to plaster by gentle heating and then mixed with fine and coarse aggregate and cast into building blocks(5). Strength will be adequate for single-storey constructions, though wetting will reduce compressive strength to 50 per cent of the dry value.

Thus bricks are seen to be at the top of the list for strength, especially when wet.

Many other walling systems exist, notably panels made either from woven plant leaves or stems, or manufactured from cement, plastics, wood or metal. However, the strength of walls made from these panels will depend largely upon the frame which is built to hold them.

III.2. Moisture movement

Most porous building materials expand when wetted and contract again as they dry. Excessive movement can cause spalling, cracking or other failures in buildings. This reversible expansion is very small in fired clay bricks. However, a slow irreversible expansion commences as soon as bricks leave the kiln. This irreversible expansion may vary from virtually zero to 0.1 per cent linear movement. Under normal circumstances much of this expansion will have taken place before bricks are built into walls. Thus, the remaining expansion is likely to be insignificant in the context of small buildings(6).

Properly made calcium silicate bricks and concrete bricks are unlikely to have more than a fairly small amount of moisture movement. However, lightweight and aerated concrete units exhibit a greater movement. This sometimes leads to shrinkage cracking in buildings as they dry out initially.

Soil, especially plastic clay, may have a very large moisture movement of several percentage points. This is a major cause of failure in earth building. The problem is reduced if stabilisers are incorporated into the soil.

Timber, bamboo and other plant materials exhibit variable, but sometimes large, moisture movements. The latter take place especially across the grain rather than in line with it.

Moisture movement becomes especially important when two materials with different movement characteristics are in close juxtaposition in a building. Differential movements give rise to stress which may be sufficient to break the bond between the materials, or

lead to other damage. For example, cement renderings often become detached from mud walling, and gaps appear sometimes between timber frames and infill materials.

Bricks thus compare favourably with alternative construction materials. Moreover, brickwork can be built without timber frames, thus excluding the possibility for differential movements.

III.3. Density and thermal properties

Fired clay bricks are amongst the most dense of building materials. This high density may constitute a disadvantage for transportation over long distances or in multi-storey framed buildings where the loads on frames would be high. On the one hand, weight is of little consequence whenever bricks are produced locally for close-by markets and single-storey buildings. On the other hand, the high density of bricks has the advantage over lightweight building materials of greater thermal capacity. This characteristic is sought in the tropics where extremes of temperature will be moderated inside buildings made of bricks.

Aerated and lightweight aggregate concretes have good thermal insulating properties but lack thermal capacity, while thick mud walls have fairly good insulation and good thermal capacity. Lightweight cladding materials, such as woven leaves and matting, metal sheeting and asbestos cement sheeting, have neither high insulation nor high thermal capacity.

Thus, bricks are particularly advantageous for low-cost housing as they considerably improve environmental conditions within the building.

III.4. Durability, appearance and maintenance

Evidence for the excellent durability of brickwork may be seen in many countries of the world. In the Middle East, brickwork 4,000 years old still remains. Bricks made 2,000

years ago in Roman times are still in use today. Indeed, properly made bricks are amongst the most durable of materials, having typical properties of ceramics such as good strength, resistance to abrasion, sunlight, heat and water, excellent resistance to chemicals and attacks by insects and bacteria, etc. If bricks are not well made (e.g. if the time or temperature in the kiln is insufficient), these desirable ceramic properties will not be developed, and performance will be nearer to that of mud bricks. Furthermore, to achieve the best performance from brickwork, attention must be paid to the correct formulation and use of mortar. Fired clay brickwork should sustain the adverse impact of the environment without the need of any surface protection (e.g. rendering). No maintenance should be required subsequent to building.

In some communities it is traditional to render the brick wall surface, although this is not necessary from either the appearance or performance point of view. Furthermore, lime washing on rendering is often used to achieve a white finish. A white finish is beneficial in reducing solar gain. It may be applied directly on the bricks without rendering, thus saving materials.

Other brick and block materials may also have good durability, if well made. However, the lightweight aggregate, aerated concrete and mud bricks normally require rendering to improve resistance to water.

The ultra-violet component of sunlight causes deterioration of many organic materials. These include timber and other plant-derived materials, plastics, paints, varnishes and bitumen. Inorganic materials, such as bricks, are immune to sunlight deterioration.

Termites occur in many developing countries and can attack and damage soft materials such as various species of timber. Other insects also attack timber. Hard materials such as bricks are entirely resistant.

Under damp conditions, timber and many other organic materials may rot through attacks

by fungi, moulds and bacteria. Although some plant growth and mould may be seen on porous inorganic building materials, especially in hot-damp climates, damage is unlikely.

Fire can quickly destroy many building materials such as timber, woven matting and plastics. Cement products do not burn, but high temperatures in fires could break down some of the calcium and alumino silicates of which they are composed, causing loss of strength. In practice concrete may successfully sustain somewhat elevated temperatures without serious effect, though if concrete contains siliceous aggregates, such as flint, it is likely to spall(7). Reinforcing steel and steel frames lose strength and distort in fire, but are normally encased, and are thus protected to a large extent. Although clay brickwork could spall, crack and bulge in a severe fire, bricks are less likely to suffer damage than concrete and calcium silicate bricks as they have already been exposed to fire. Sudden cooling of hot areas by quenching with water in the course of fire-fighting may cause spalling. This does not generally affect the strength and stability of the brick wall seriously.

III.5. Earthquake areas

In general, bricks and blocks, whether of fired clay, calcium silicate, concrete, or stabilised soil, require steel reinforcement in seismic zones. Mud building, lightweight concrete and aerated concrete materials will also be at risk in these areas if not similarly reinforced.

III.6. Production cost and foreign exchange

The production costs of various building materials depend upon raw materials prices, methods used, markets, etc. which vary from time to time and place to place, making comparisons difficult. However, bricks are often amongst the cheapest of walling materials. It should be borne in mind that if, as stated at a United Nations Conference, a house is to retain its usefulness, it must be maintained, repaired, adapted and renovated. Thus, choices concerning standards, materials and technology should consider resource

requirements over the whole expected life of the asset and not merely the monetary cost of its initial production(8). Durable materials such as bricks have a cost advantage in this respect.

The production of bricks from indigenous clays, especially if labour-intensive methods are used to avoid importation of capital-intensive equipment, will conserve foreign exchange. This is in contrast with some of the alternative materials.

IV. Scales of production covered by this memorandum

Bricks manufacturing may be undertaken at various scales of production, depending upon local circumstances. Table I.2 summarises the production techniques used at small, medium and large scales of production.

Table I.2

Scales of production in brick manufacturing

Scale of production	Number of bricks per day (average)	Example of process used	Appropriate for market area
Small	1 000	Hand made, clamp-burnt	Rural village
Medium	10 000	Mechanised press, Bull's trench kiln	Near towns
Large	100 000	Fully automated Extruded wire cut, tunnel kiln	Industrialised areas of high demand and well-developed infra-structure

This memorandum is concerned primarily with small-scale production, though some consideration is given to medium-scale. Large-scale will be mentioned briefly for comparative purposes.

IV.1 Small-scale concept

A small brickworks producing 1,000 bricks per day may supply enough bricks each week for the building of an average size house. This may be adequate in a small village community. However, if demand were to increase suddenly, production could be increased to several thousand bricks per day merely by making additional wooden moulds and hiring more workers. In this case, the management staff does not need to be expanded. This larger production unit might also be established in small towns. Conversely, at times of recession or when weather prevents construction work, the demand will fall and production can be reduced temporarily. Thus, such small-scale industry is very adaptable to a changing market.

Small-scale production should be undertaken near the clay source, and within a short distance of the area where bricks will be sold and used. This will reduce transport cost while saving fuel. Small-scale production will not unduly spoil the landscape nor cause excessive pollution. An electricity supply may not be necessary and fossil fuels need not be used. Kilns may utilise waste materials for fuel, such as saw dust, rice husks, animal dung and scrub wood. The small works will provide employment within the local community. Capital investment is low for small-scale production and is thus appropriate for poor communities. Furthermore, equipment for small-scale brickmaking can be made and repaired within the local community.

IV.2. Large-scale concept

In contrast to the points mentioned above, the introduction of large brickworks necessitates capital investment of millions of dollars, mostly in foreign exchange for the

import of the sophisticated production machines and control systems. Commissioning over a period of months and subsequent purchase of spares will further increase costs. Large areas will have to be cleared not only for the works, but also for the clay pit. The process itself and the transport of raw materials and products can prove a nuisance. Production of many millions of bricks per year necessitates the finding of sufficient markets, and involves the use of fuel for getting bricks to the building sites. Feasibility studies for large-scale plants commonly assume several shifts being worked per day for nearly all the days of the year. Such plants are not adaptable to variations in market demand. There is no allowance for workers' absenteeism (e.g. during the agricultural season), neither do they usually take into account the difficulty of obtaining spare parts from overseas in the event of a breakdown. If the latter does occur, the whole production ceases. These large plants require electric power and high grades of fuel for the kilns.

In those situations where a large plant may be considered, it would be normal to conduct a full feasibility study, examining raw material quality and reserves for the expected life of the works (e.g. 50 years), and a thorough market survey. A specialist consultant would be required for such a feasibility study.

V. Content of the memorandum

The following eight chapters of this memorandum deal with the technical aspects of brick manufacturing. Chapter II describes various raw materials entering in the production of bricks while Chapters III to IX describe the various production processes in the following order:

Chapter III Quarrying (methods and equipment)

Chapter IV Preprocessing (grinding, sieving, wetting, etc.)

Chapter V. Forming (equipment, skill requirements, etc.)

Chapter VI Drying (natural and artificial, drying shrinkage, etc.)

Chapter VII Firing (kiln types, fuels, etc.)

Chapter VIII Mortars and renderings (purpose, types, etc.)

Chapter IX Organisation of production (plant layout, water and fuel supplies, labour, etc.)

Technical details on each subprocess are provided, including advice for improving product quality, saving fuel, increasing labour productivity, minimising losses, etc.

Chapter X outlines a methodological framework for estimating unit production costs associated with alternative production techniques. An illustrative example is provided with a view to showing how this framework may be applied to a specific bricks production unit. Finally, Chapter XI analyses the various socio-economic effects of alternative production techniques, including employment generation, foreign exchange savings, fuel utilisation, etc. The memorandum concludes with the following appendices: Glossary of technical terms, bibliography, list of institutions concerned with brickmaking, and list of equipment suppliers.

Note:

1 The references are to entries in the bibliography (Appendix II).

