

➔ **Climate Responsive Building - Appropriate Building Construction in Tropical and Subtropical Regions (SKAT, 1993, 324 p.)**

 **(introduction...)**

 **1. Foreword**

 **2. Fundamentals**

 **2.1 Climate zones**

 **2.2 Climatic factors.**

 **2.3 Human requirements regarding indoor climate**

 **2.4 Physics**

 **3. Design rules**

 **3.0 Design methodology**

 **3.1 General guidelines**

 **3.2 Design for hot-arid zones**

 **3.3 Design for warm-humid zones**

 **3.4 Design for temperate and upland zones**

 **4. Case studies**

 **4.0 Preliminary remarks**

 **4.1 Experiment in Ghardaia, Algeria**

 **4.2 Simulation in Ghardaia, Algeria**

 **4.3 Buildings in Shanti Nagar, Orissa, India**

 **4.4 Experiments in Cairo, Egypt**

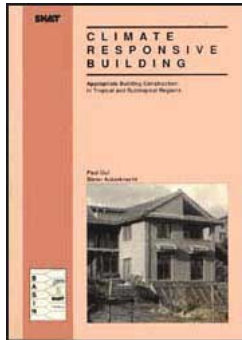
 **4.5 Buildings in the Dominican Republic**

 **4.6 Buildings in Kathmandu, Nepal**

- 📄 4.7 Buildings in New Delhi, India
- 📄 4.8 Movable louvres for a school in Kathmandu, Nepal
- 📄 4.9 Mountain hut in Langtang National Park, Nepal
- 📁 5. Appendices
  - 📄 5.1 Physical data
  - 📄 5.2 Literature
  - 📄 5.3 Solar ecliptic charts
  - 📄 5.4 Conversion factors to SI units
  - 📄 5.5 List of possible plant species



[Home](#) > [ar.cn.de.en.es.fr.id.it.ph.po.ru.sw](#)



- 📖 **Climate Responsive Building - Appropriate Building Construction in Tropical and Subtropical Regions (SKAT, 1993, 324 p.)**
- ➔ 📄 *(introduction...)*
- 📄 1. Foreword
- 📁 2. Fundamentals
- 📁 3. Design rules
- 📁 4. Case studies
- 📁 5. Appendices

**Appropriate Building Construction in Tropical and Subtropical Regions**

**SKAT 1993**

**Paul Gut  
Dieter Ackerknecht**

**First edition: 1993 by SKAT, Swiss Centre for Development Cooperation in Technology and Management**

**Authors: Paul Gut, Fislisbach, Switzerland  
Dieter Ackerknecht, Zollikon, Switzerland**

**Published by: SKAT, Swiss Centre for Development Cooperation in Technology and Management**

**Illustrations: Mirjam Zimmermann, Zrich, Switzerland  
Layout: Paul Gut , Werner Fuchs, SKAT**

**Copyright: SKAT**

**Comments: Please send any comments concerning this publication to:  
SKAT**

**Vadianstrasse 42  
CH-9000 St. Gallen, Switzerland**

**Printed by:  
Niedermann AG, St. Gallen, Switzerland**

**ISBN: 3-908001-39-0**

**This book describes alternative techniques for designing buildings to specific climates in tropical and subtropical regions. Emphasis is given to "soft measures" and natural means**

**that will reduce energy consumption, well considered construction and appropriate selection of materials.**

**It gives the theoretical background which is necessary to understand the climate factors, the principles of thermal processes and climatic design.**

**Based on practical experience the author describes the many practical applications and design approaches used in different climatic zones to improve indoor conditions without excessive use of energy. The use and control of solar radiation, existing wind and natural ventilation as well as the correct use of building materials based on their thermal properties are discussed as central issues, covering multiple applications from town planning, site selection and orientation up to detail design.**

**Several case studies analyze the thermal performance of various materials and structures and indicate their possibilities and limits to show the reader the magnitude of the effects of construction alternatives on climatic performance.**

**The appendices include: data on building materials, solar ecliptic diagrams and conversion tables.**

**ISBN 3-908001-39-0**



[Home](#) > [ar.cn.de.en.es.fr.id.it.ph.po.ru.sw](#)

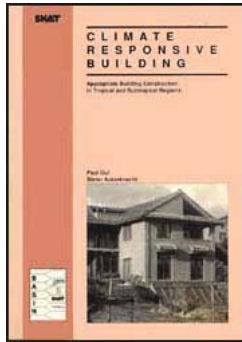
 **Climate Responsive Building - Appropriate Building Construction in Tropical and Subtropical Regions (SKAT, 1993, 324 p.)**



*(introduction...)*



**1. Foreword**



- **2. Fundamentals**
- **3. Design rules**
- **4. Case studies**
- **5. Appendices**

## 1. Foreword

<i>Background</i>	<p>In view of the global economic, demographic, social and ecological development, the future for a healthy environment looks uncertain. The facts are well-known about the increasing consumption of energy and other resources, the resulting pollution and the dependence on oil and oil producing countries and, therefore, the possible environmental scenarios. The threat of a global greenhouse effect is ever present. The consequences regarding the environment and the energy situation are obvious as ecological systems suffer everywhere.</p>
<i>Non-adapted buildings</i>	<p>One particular aspect has to be pointed out in this context: the steadily increasing energy consumption by climatically non-adapted building designs or architecture, urban design and planning. Too often climatic factors are neglected in construction because they are not of immediate interest and concern to the building industry, builders, designers, developers and owners. This can be said not only for structures in hot climate zones, but also for those in temperate and cold climate zones. With the input of sufficient energy almost everything seems possible. Present trends in construction in tropical and subtropical regions still show little</p>

	<p>awareness about energy conservation. The widely applied "international concrete box and iron sheet style" of ubiquitous buildings is not adapted to local climatic conditions and hence its influence on living conditions is questionable.</p> <p>The unrestricted demand by the affluent for more comfort and higher building and living standards and changing life-styles, and the unconsidered use of technical means increase these tendencies. On the other hand, those who cannot afford these higher standards suffer in unhealthy, overheated or cold shelters.</p> <p>For various reasons, new buildings and constructions are often not adapted to the local context. Therefore, the loss of indigenous know-how and experience is also taking place in many areas.</p>
<i>Possible alternatives</i>	<p>A possible alternative is the application of "soft measures" and natural means to reduce energy consumption by design, construction and materials which are adapted to a specific climate. This also has its positive consequences in terms of economy as well as in terms of proper use of local resources.</p> <p>Improvements can be achieved when buildings are conceived in an integrated approach. This already includes the settlement pattern and urban forms and the selection of the site according to microclimatic criteria. The shape and type of buildings and their orientation, the integration of suitable vegetation and the arrangement of the external and internal space require careful consideration. The correct use of building materials, designs of openings and their shading, natural cooling, passive solar heating and the well-aimed utilization of prevailing winds for ventilation are important supporting elements.</p> <p>These potentials are explored theoretically and practically by many concerned institutions and individuals. The future outlook to improve the quality of buildings and settlements with regard to indoor climate, without additional or even with reduced energy consumption, looks promising.</p>
<i>Contents of this</i>	<p>This publication provides the required information for the planning and construction of settlements and buildings in tropical and subtropical regions with respect to natural</p>

<i>publication</i>	climate control by passive methods ( i.e. without energy consuming appliances). In the main, <del>lowcost and appropriate technology concepts are envisaged.</del>
<i>Target users</i>	It is addressed to practitioners working in the field such as builders and architects, project managers, local technical staff, technical schools, etc., particularly in developing countries. Thus it does not intend to be scientifically comprehensive.
<i>Theory</i>	In Chapter 2 the minimum required theoretical background is given which is needed to understand the principles of thermal processes and climatic design.
<i>Practical rules</i>	Chapter 3 deals with practical applications and describes the manifold design approaches which can be used in different climatic zones when designing for an improved indoor climate without the excessive use of energy.
<i>Practical experience</i>	Chapter 4 presents several case studies where the thermal performance of built examples has been monitored. The results of these studies offer experiences from which it is possible to assess the practical effect that different kinds of construction have had on climatic performance and their limits.
<i>Appendix</i>	The Appendix contains the physical data required to assess the properties of the main building materials and other useful lists such as an extensive bibliography, solar ecliptic charts for tropical and subtropical regions, conversion factors, an English / German dictionary of technical terms and a list of possible plant species.
<i>Calculations</i>	Prior to making any calculations, basic conceptual considerations should be made with a rough estimate of the expected effectiveness. This is possible only with an understanding of the principles and from experience. Where this know-how is lacking, it is difficult to find the correct concept, even with sophisticated calculation methods. As a consequence, they are not presented in this publication. The reason also lies in the fact that today extensive calculation and simulation methods, including computerized methods, exist. Such programs are not usually accessible locally to designers of low and medium cost housing. The facilities to use such techniques are often not available and, moreover, specialized professionals may be out of reach.

	However, where available, such exact calculation methods may be applied at a later stage to examine and improve the design further and to achieve more accurate results.
<i>Air conditioning and active solar systems</i>	The application and theory of higher technologies such as air conditioning and active solar systems are only referred to where applicable, but are not a subject of this publication.
<i>Hazards</i>	It is recognized that natural calamities such as storms, earthquakes, floods etc. also have to be considered, but their influence on the design of buildings is dealt with only marginally.
<i>Maintenance</i>	In addition, the suitability of the materials and constructions with respect to maintenance is not discussed but should not be neglected.
<i>Definition north/south facing</i>	For ease of reference, these terms are used in the sense of the northern hemisphere. For the southern hemisphere the terms have to be reversed. For example, where north orientation is recommended, then this is valid for the northern hemisphere only. For the southern hemisphere the orientation would naturally be south.

**The authors have received comments, suggestions and support from numerous sources and are grateful for all these valuable contributions. Special thanks are given to those who undertook the troublesome task of monitoring and analysing the performance of the case study buildings, namely the staff of Development Alternatives in New Delhi; H.U. Lobsiger in Shanti Nagar; K. Rhyner and Martin Melendes of Sofonias in the Dominican Republic and H. Rosenlund of Lund University for providing the informative computer simulation results.**

**R. Stulz provided general comments and advices in organizational matters, H. Haas contributed many ideas with regard to the integration of vegetation, A. Baumgartner and R. Sigg provided valuable support in the field of physics and physiology, and M.**



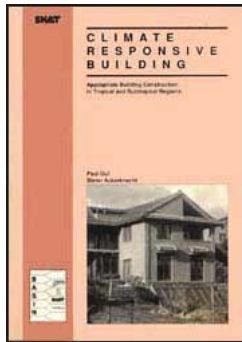
**Zimmermann showed immense patience in preparing the majority of the illustrations.**

**Finally, the text was proofread by B. Ikin and G. Kennworthy.**

**Fislisbach and Zollikon, 1993**



[Home](#) > [ar.cn.de.en.es.fr.id.it.ph.po.ru.sw](#)



## **Climate Responsive Building - Appropriate Building Construction in Tropical and Subtropical Regions (SKAT, 1993, 324 p.)**



### **2. Fundamentals**



#### **2.1 Climate zones**



#### **2.2 Climatic factors.**



#### **2.3 Human requirements regarding indoor climate**



#### **2.4 Physics**

**Climate Responsive Building - Appropriate Building Construction in Tropical and Subtropical Regions (SKAT, 1993, 324 p.)**

## **2. Fundamentals**

### **2.1 Climate zones**

**The climates prevailing around the globe vary greatly, ranging from the polar extreme to tropical climates. These are primarily influenced by the sun's energy heating up the land**

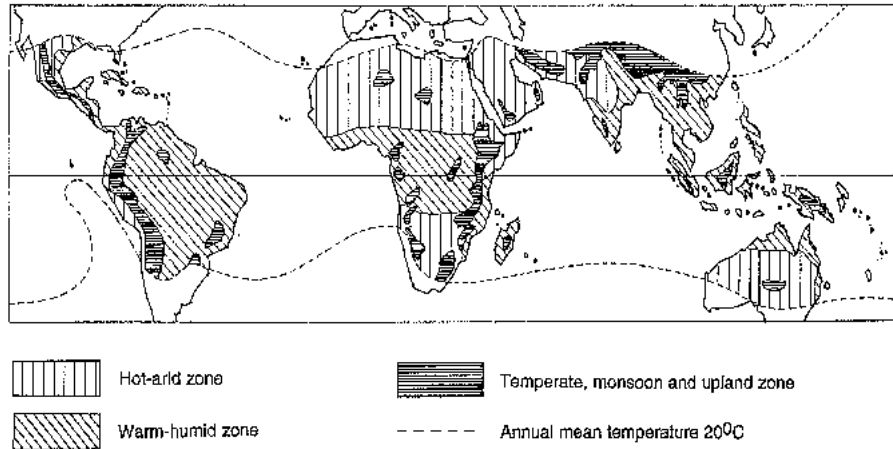
**and water masses. At the regional level, the climate is influenced by altitude, topography, patterns of wind and ocean currents, the relation of land to water masses, the geomorphology, and by the vegetation pattern.**

**Accordingly, the tropical and subtropical regions can be divided into many different climatic zones, but for practical reasons, in this publication three main climate zones are considered:**

- **the hot-arid zone, including the desert or semi desert climate and the hot-dry maritime climate**
- **the warm-humid zone, including the equatorial climate and the warm-humid island climate**
- **the temperate zone, including the monsoon climate and the tropical upland zone**

**The main climatic factors relevant to construction are those affecting human comfort:**

- **air temperature, its extremes and the difference between day and night, and between summer and winter temperatures.**
- **humidity and precipitation**
- **incoming and outgoing radiation and the influence of the sky condition**
- **air movements and winds**



**Fig 2/1 World climatic zones**

### 2.1.1 The hot-arid zone

**This zone is situated in two belts at latitudes between approximately 15° and 30° North and South of the equator. Its main characteristics are the very hot summer season and a cooler winter season, and the great temperature difference between day and night.**

#### Temperature in summer

**In the hot season the air temperature rises quickly after sun rise up to a mean maximum well above 40°C, with a recorded maximum of 58°C. At nighttime the temperature falls by about 20°C.**

#### Temperature in winter

**In the cool season the mean maximum lies at about 30°C and falls at night by about 10 to 20 °C or more, according to altitude. In addition ground frost is possible at night.**

### **Coastal areas**

**In the maritime region the temperatures are somewhat less extreme but in the hot season the mean maximum temperature also reaches about 40°C and drops at night by 10 to 15°C . In the cool season the mean maximum lies at about 25°C with a similar drop at night.**

### **Humidity and precipitation**

**The relative humidity is very low in the continental areas and varies between 10% and 55%. In the coastal areas, however, it can reach up to 90% which, together with the high temperature, makes the climate very uncomfortable. Precipitation is scarce, irregular and unreliable.**

### **Radiation**

**The sky is mostly clear, with some haze in the coastal regions, allowing a very strong solar radiation during the daytime. A considerable release of the heat stored during daytime takes place in the form of radiation toward the cold night sky.**

### **Wind**

**The winds which vary greatly are usually caused by thermals created by humidity and temperature differences. During the daytime they are often strong and violent with a tendency to evolve to sand or dust storms. In the coastal regions a regular wind pattern exists, blowing landward from the sea during the daytime and seaward at night.**

### **2.1.2 The warm-humid zone**

**This zone covers an area around the equator extending from about 15° N to 15°S. There is very little seasonal variation throughout the year.**

### **Temperature**

**The air temperature varies very little throughout the year or between day and night. It reaches a mean daytime maximum between 20°C and 32°C and a nighttime minimum between 21°C and 27°C.**

### **Humidity and precipitation**

**The relative humidity varies between 55% and 100%, but generally lies around 75%. Precipitation is high throughout the year and often occurs in the form of torrential rains with heavy winds and storms.**

### **Radiation**

**The sky is fairly cloudy throughout the year; in coastal regions, however, it is often clear. Accordingly, the solar radiation is to a great extent diffused and partly reflected by the high vapour content. Thus at night the accumulated heat is not readily dissipated.**

### **Wind**

**The wind velocity is generally low except during rain squalls, when usually one or two dominant wind directions prevail. In coastal regions, however, regular thermic winds provide relief from heat and humidity. Storms are common in this region.**

### **2.1.3 The temperate, monsoon and upland zones**

**These climatic regions are generally located around the Tropic of Cancer and the Tropic of Capricorn. The climate is neither consistently hot and dry, nor warm and humid. Their**

**characteristics change from season to season, alternating between hot, dry periods and periods of concentrated rainfall and high humidity.**

### **Three seasons**

**Three main seasons can thus be distinguished:**

- **the hot and arid pre-monsoon season,**
- **the warm-humid monsoon period,**
- **the moderate or even cool winter period.**

### **Temperatures in lowland areas**

**The lowland monsoon area is characterized by air temperatures which are highest in the pre-monsoon season, i.e. around 35 to 45°C in the daytime and a drop at nighttime of about 10 to 15°C. With the start of the monsoon rains the temperature drops considerably. In winter the lowlands have moderate temperatures.**

### **Temperatures in upland areas**

**In the upland areas the temperature naturally depends on altitude. In winter night frost is possible. This can also happen in continental areas.**

### **Humidity and precipitation**

**The relative humidity varies in the dry season between 20% and 55%, and in the wet period between 50% and 100%, depending on precipitation.**

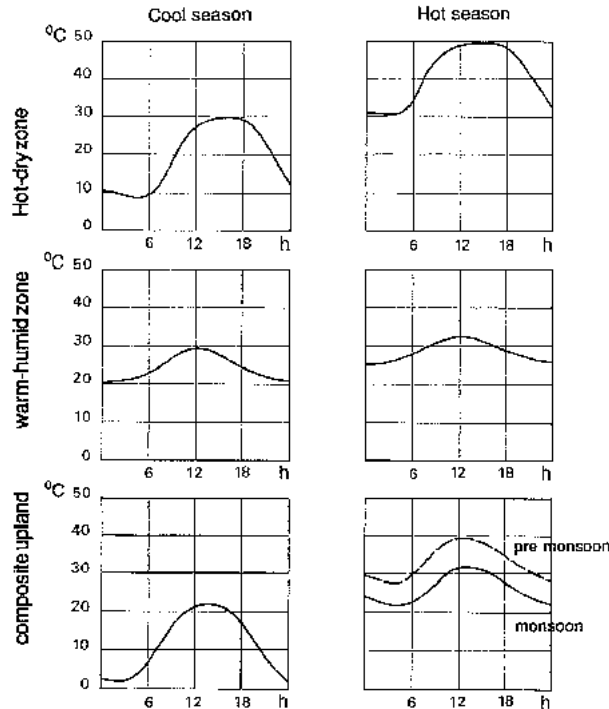
### **Radiation**

**The sky condition varies with the seasons. In the dry and cool season it is clear with**

**intense direct solar radiation. In the hottest period the sky is rather hazy and radiation is more diffused. During the monsoon period, heavy and low clouds often cover the sky, alternating with periods of clear sky and intense solar radiation.**

## **Wind**

**Winds are variable and influenced by topographical conditions. During the dry period winds are dusty and hot in lower areas. In mountainous regions, strong and regular valley winds of thermic origin occur in the afternoon.**



**Fig 2/2 Diagrams showing the typical mean temperature curves for the three zones over 24 hours during the hot and cool seasons.**

### 2.1.4 Microclimate

The above described division into three climatic zones is very generalized, since many areas exist with differing climates or a combination of types. Local conditions, however,



**may also differ substantially from the prevailing climate of a region, depending on the topography, the altitude and the surroundings which may be either natural or built by humans.**

### **Cold air pool**

**A phenomenon often observed is that of the cold air pool. Because cold air flows downwards, similar to water, it causes cold air “lakes” in depressions and in the bottom of valleys if there are insufficient outlets. This occurs especially at night, but can also prevail over a longer period and can prevent air circulation. In urban areas which are located in such depressions this phenomenon favours the development of smog conditions.**

### **Local wind**

**Local wind conditions strongly influence the climate. They are determined mainly by the topography. When a wind blows over an obstacle such as a hill or tree, its velocity on the windward side is greater than on the wind-protected leeward side, and is greatest on the crest.**

### **Water bodies**

**Large water bodies such as lakes and seas generally have a balancing effect on the temperature in the adjacent areas due to the great thermal storage capacity of the water. Water is also a source of local winds because it accelerates thermic air movements.**

### **Urbanization**

**Heavy urbanization of an area (townships) generally increases the temperature compared to the rural surroundings. Differences of up to 10°C are possible. Wind velocity and its ventilation effects are generally decreased, but the channeling effect of narrow streets can**

**also cause the opposite to occur.**

### **Altitude**

**Altitude is a major factor influencing air temperature. As a rule of thumb, the temperature is reduced by 2°C for every 300 m increase in altitude.**

### **Ground surface**

**The properties of the ground surface cover also influence the climate. Bare or denuded surfaces store little or no humidity, but absorb solar heat radiation and heat up. Surfaces covered with vegetation heat up much less, and thus have a regulating effect on the temperature and increase humidity. The more intense the vegetation, the greater is its balancing effect.**

### **Response to microclimate**

**While considering the general climatic characteristics may be sufficient in working out the rough concept of a building, the individual site conditions, as observed according to the above criteria, need to be considered in designing the details. If possible, these factors should already be considered when selecting the construction site.**

## **2.2 Climatic factors.**

**The main natural elements that define the climate, are**

- solar radiation,**
- wind, and**
- humidity, in the form of vapour and precipitation.**

**Their characteristics and relevance for construction depend largely on the geographical**

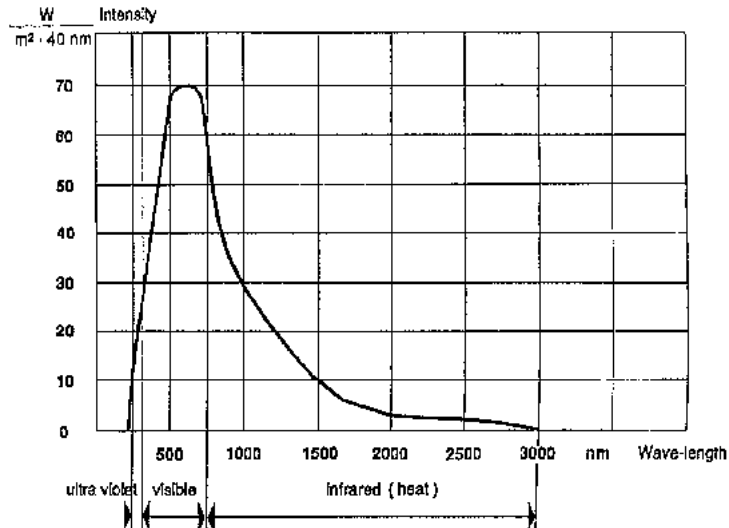
location, but also on the topography, altitude and properties of the earth's surface and its coverage.

## 2.2.1 Sun

The earth receives almost all its thermal energy from the sun in the form of radiation. Thus the sun is the dominant factor that influences climate.

### 2.2.1.1 Solar radiation

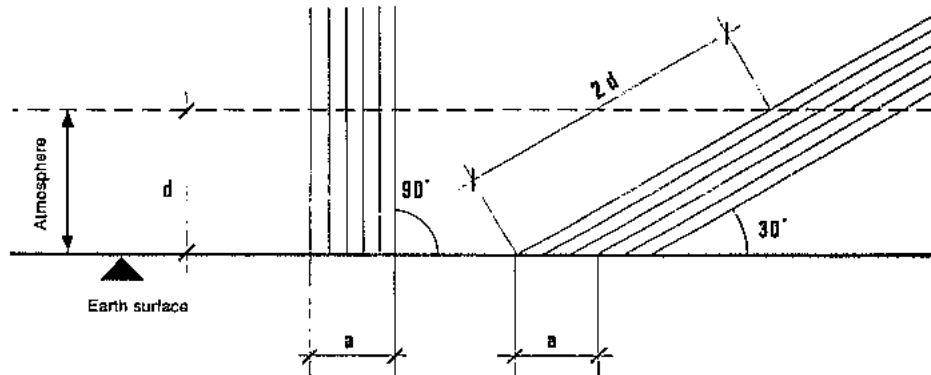
The spectrum of solar radiation extends from ultra violet through visible light, to infrared radiation. The latter is the main medium of energy, in the form of heat.



**Fig 2/3 Spectrum of the solar radiation**

**The solar energy from the sun is always constant. How much heat is received at a given point on earth depends on**

- the angle of incidence
- atmospheric conditions
- the length of the day



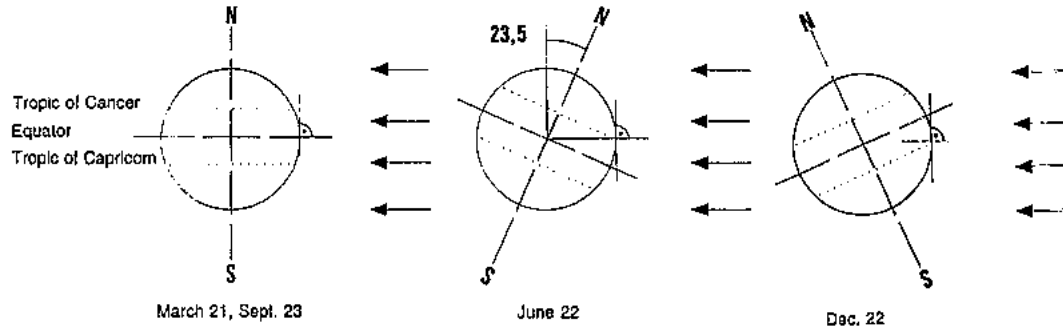
**Fig 2/4 With the changing angle of incidence the radiation intensity changes**

**At an angle of 30°, a given area (a) only receives half the amount of solar rays it would at an angle of 90°.**

**The distance (d) that solar rays have to pass through the atmosphere at an angle of 30° is double that if the angle were 90°.**

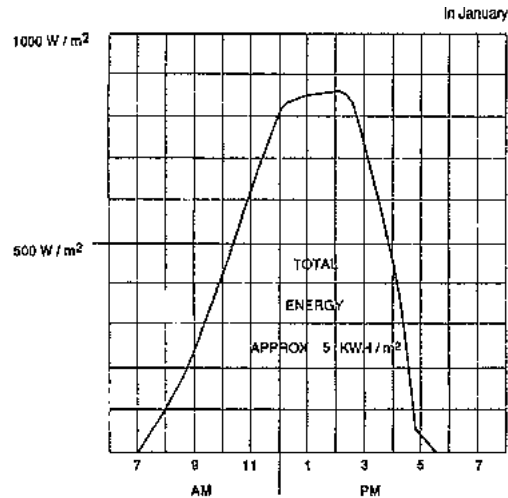
**This increased distance reduces the energy received on the earth surface considerably, especially if the atmosphere is humid or dusty.**

**The angle of incidence changes not only in the course of the day, but also with the seasons. This is due to the earth's path around the sun.**



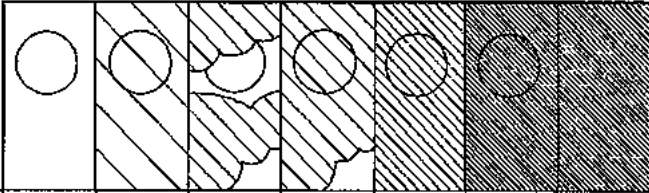
**Fig 2/5 The angle of incidence changing with the seasons**

**The amount of energy received on a given surface varies during the course of the day, depending on the angle of incidence of the sun. The graph below illustrates a typical amount of energy received by a south facing and inclined solar collector surface. The total energy received during this day amounts to about 5 kWh/m<sup>2</sup>.**



**Fig 2/6 Sun intensity on a south-facing, inclined surface in January during a clear day, latitude 27° North**

**Major factors influencing the amount of solar energy received are the weather and the pollution content of the atmosphere.**



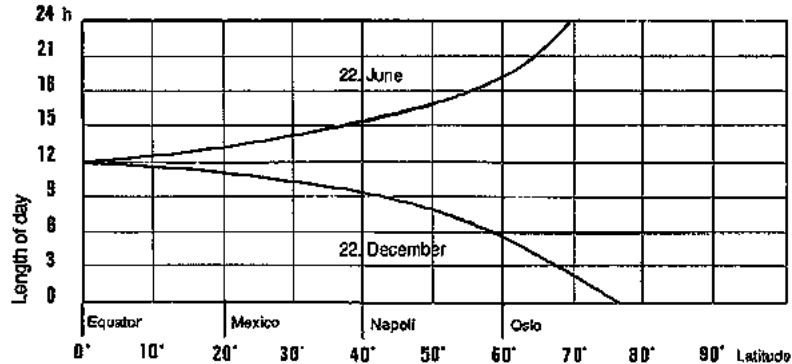
SKY CONDITION	CLEAR	HAZY	PARTLY CLOUDY	SUN AS YELLOW DISK	SUN AS WHITE DISK	SUN OUT-LINE JUST VISIBLE	DAFK AND CLOUDY
RADIATION	1000 W/m <sup>2</sup>	1000 W/m <sup>2</sup>	600 W/m <sup>2</sup>	450 W/m <sup>2</sup>	300 W/m <sup>2</sup>	200 W/m <sup>2</sup>	100 W/m <sup>2</sup>
DIFRUS	10 %	50 %	30 %	50 %	70 %	100 %	100 %

**Fig 2/7 Solar energy received on a surface vertical to radiation (angle of incidence 90°).  
Source: [ 137 ]**

Similar to the energy gain during daytime, nighttime heat loss by radiation to the sky is also greatly dependent on atmospheric conditions. A clear sky allows maximum, a thick cloud cover minimal heat loss.

(see Chapter 2.4.1)

**Length of the day.** According to the geographic latitude, the length of the day and hence the duration of sunshine varies during the year.



**Fig 2/8 Length of the shortest and longest day at different latitudes in the northern hemisphere.**

### 2.2.1.2 The sun's path

**While designing buildings anywhere in the world, the sun's path must be considered as an important factor.**

**The position of the sun depends upon**

- the geographic location (latitude)
- the time of year (season)
- the time of day (hour)

**It can be determined most easily, and for our purposes sufficiently exactly with the help of the diagrams given in Appendix 5.3**

**How to read the diagram:**



- Select the diagram for the latitude of the building site.
- Find the point at which the time of the day and date you are interested in cross each other.
- Read the solar altitude and the azimuth.

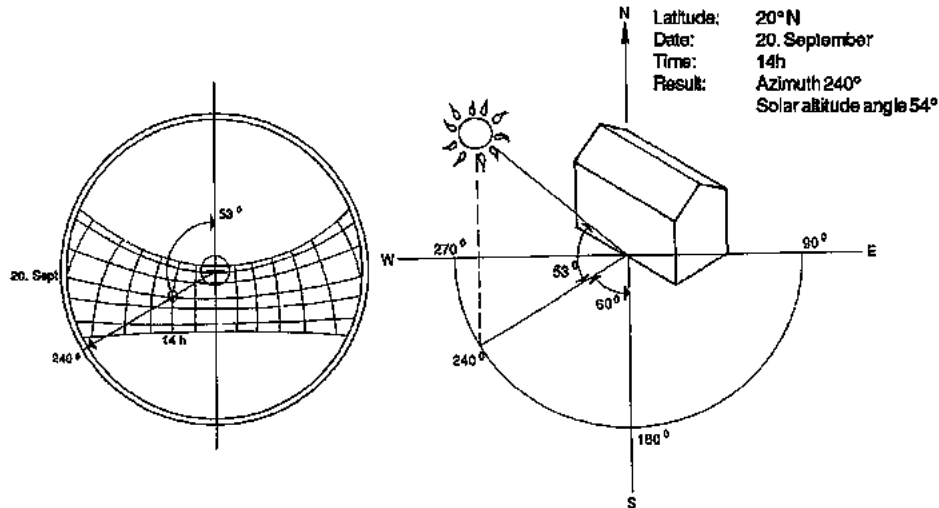


Fig 2/9 How to use the sun path diagram

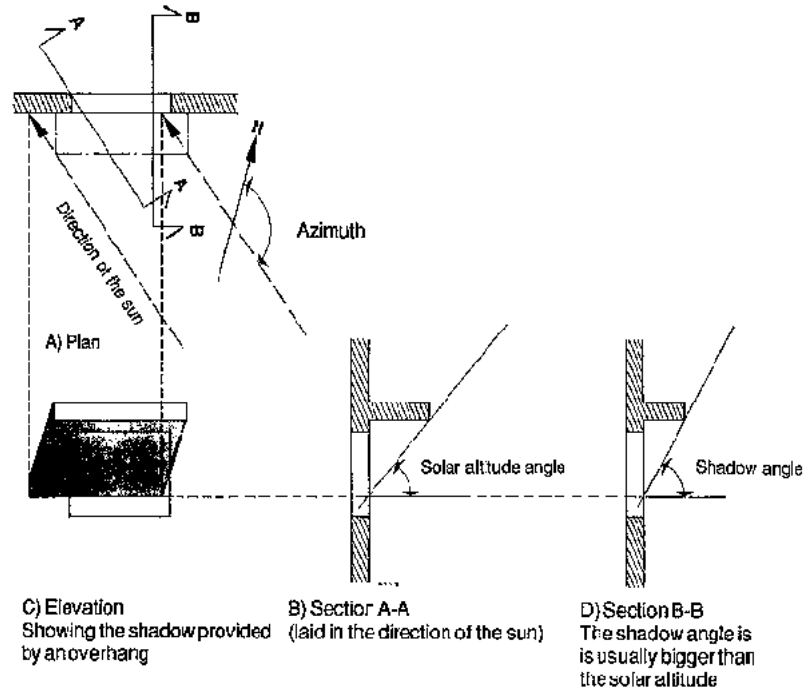
### 2.2.1.3 The geometry of shadows

Knowing the sun's position, the geometry of shadows on buildings, facades and shading devices can be derived.

Detailed methods, with the help of the sun-path diagram and a shadow angle protractor, are found in the literature.

[i.e. 2, 8, 11, 13 ]

If these tools are not at hand, the following simple geometrical method can be used:



**Fig 2/10 Geometry of shadows**

**Method:**

- 1) Draw a plan of the building part, e.g. a window with overhang, and enter the direction of the solar radiation with the help of the azimuth.**
- 2) Draw section A-A parallel to the direction of the solar radiation and enter the solar altitude angle.**
- 3) From the plan and section derive the elevation with the shadow picture.**
- 4) Drawing the normal section B-B provides the shadow angle. This is always bigger than the solar altitude angle except in the case where the direction of the sun is at right-angles to the building elevation. In this case the two angles are identical.**

**This simple method, analogously applied, provides information about the shading performance of any shape of shading devices or building components, and also shading by surrounding buildings. It provides a basis for planning the orientation and grouping of buildings, and for the design of shading devices and openings.**

**(Relevance to planning and construction see Chapter 3.)**

### **2.2.2 Wind**

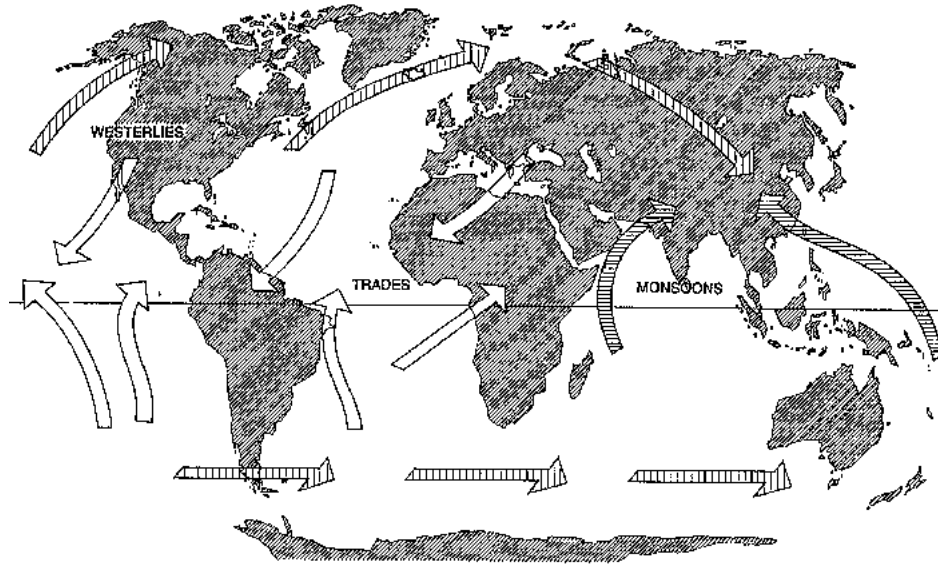
#### **The phenomenon**

**The reasons for the development of winds are manifold and vastly complex. The main reason, however, is the uneven distribution of solar radiation over the globe. It results in differing surface heating and temperatures. This causes differences in air pressure and, as a consequence, the development of winds.**

#### **Typical main winds**

**The prevailing air pressure pattern on earth is fairly regular. Together with the rotation of**

**the earth, the main winds can be determined.**



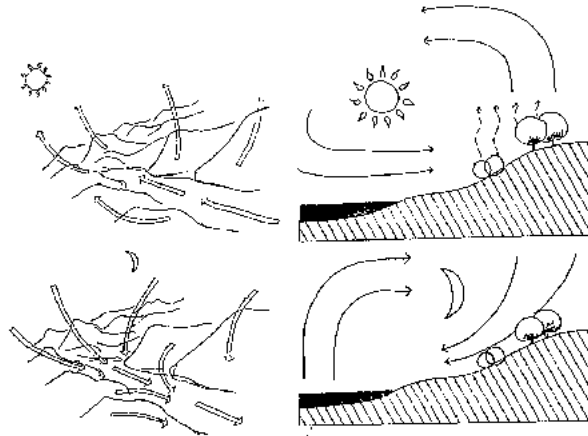
**Fig 2/11 Main global winds**

### **Local winds**

**These main winds are overlaid with secondary winds, mainly of thermic origin.**

**The daily variations in heating and cooling of land and water surfaces (seas, lakes), of mountainous and flat land areas, and of bare and land covered with vegetation, cause regular wind patterns in certain areas, such as sea winds or valley winds in the daytime, and land winds or mountain winds at nighttime.**

## Valley and mountain winds; Sea and land winds



Valley and mountain winds Sea and land winds

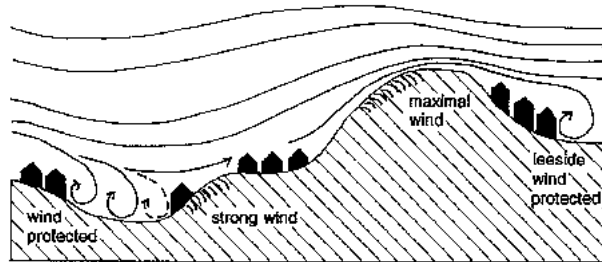
**Fig 2/12 Thermic wind pattern varying between day and night**

### Thermic bubbles

**Strong solar radiation also causes irregular local thermic winds. This is due to air that is heated near the ground and rises from time to time in the form of bubbles.**

### Influence of topography

**Topography influences wind characteristics. Valley bottoms are generally wind protected areas whereas elevated locations receive more and stronger winds.**



**Fig 2/13 Topographical influence on wind speed**

## Monsoon wind

The monsoon wind is a result of seasonal differences in the heating up of land and sea areas and is of great importance to a large area in the tropics.

## Characteristics of winds

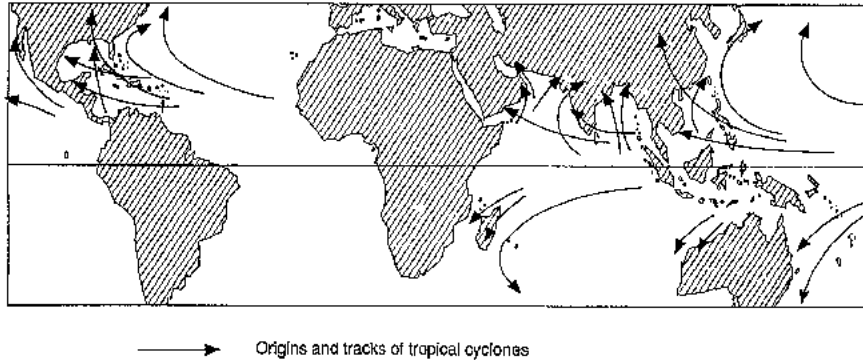
Depending on the origin of the wind, its quality differs. It can be dry or humid, clean, dusty or sandy, hot or cool compared to the prevailing temperature, constant or irregular. Its speed too can vary.

Accordingly, wind can either be utilized for improvements to the indoor climate of buildings or measures must be taken to protect against it.  
(Relevance for planning and construction, see Chapter 3.)

## Storms

Wind can have a disastrous effect in the form of storms. Due to climatic constraints, certain zones on the globe are prone to storms. In these areas buildings require special structural protection. In most other zones, however, storms occasionally occur as well,

**but probable with less intensity. As a consequence, adequate protection is also required there. (see Chapter 3.1.4)**



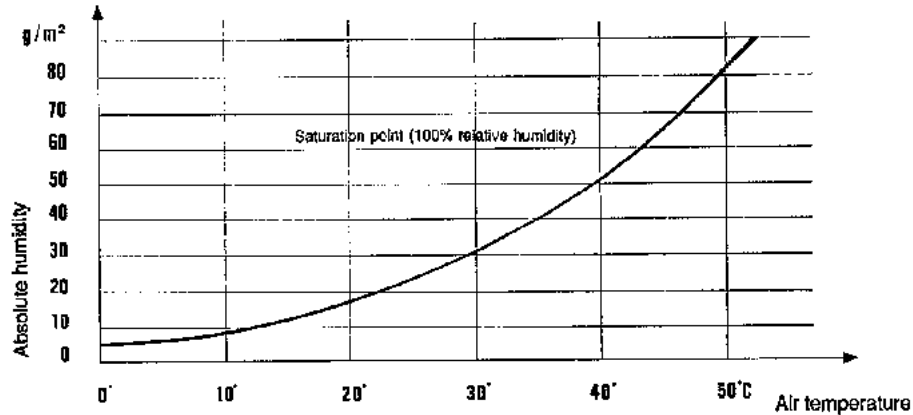
**Fig 2/14 Regular storm zones. Source: [ 11 ]**

### **2.2.3 Humidity and precipitation**

**A major factor in climatic characteristics is water. It occurs as rain, hail, snow, clouds and vapour.**

#### **Relative humidity**

**Vapour is water in the form of gas, absorbed by air. Depending on the temperature, the absorption capacity of the air varies.**



**Fig 2/15 Saturation point**

**The curve shows the maximum absorption capacity in relation to the air temperature. This represents 100% relative humidity.**

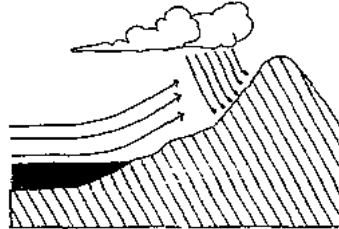
**Relative humidity is defined as**

**humidity at saturation point (g/m<sup>3</sup>) . 100 / effective humidity (g/m<sup>3</sup>) = ... %**

**Fog, clouds and precipitation**

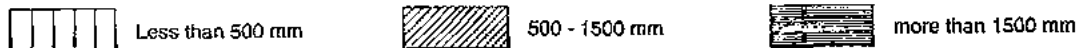
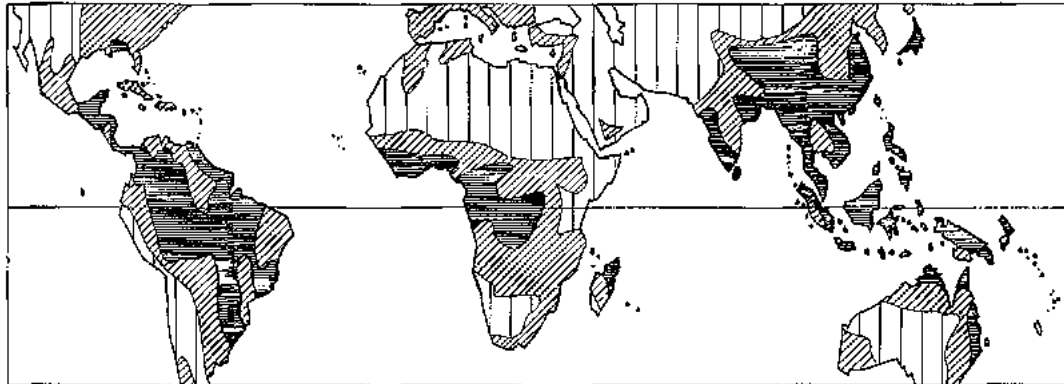
**Air temperature fluctuates considerably during the day and night, and with it the saturation point. Because the absolute humidity remains constant, the relative humidity changes. If, however, the absolute humidity exceeds the saturation point, the surplus water condenses and occurs in the form of fog, clouds, dew or precipitation. The same can be observed when air rises and thus cools down. Strong thermic upwinds result in cumulus clouds; winds crossing mountains create clouds and precipitation.**





**Fig 2/16**

**Due to topography, distribution of water bodies and winds, the types and quantity of precipitation varies strongly.**



**Fig 2/17 Annual precipitation values, based on [ 11 ]**

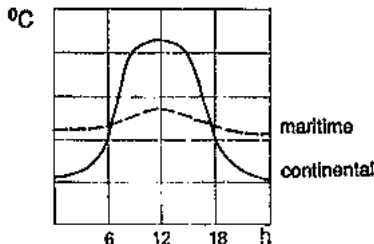
**Not only the quantity, but also the types and seasonal distribution of precipitation are manifold. For example, in monsoon areas rainfall is concentrated over a certain period of the year and can be extremely intense and long-lasting. In warm-humid regions it can occur over the whole year with short downpours almost every day.**

**These differences in precipitation patterns are reflected in construction details and building types, at least traditionally. This can be illustrated by typical building types for different regions (Relevance for planning and constructions see Chapter 3)**

### **Thermal capacity of water**

**Water has an extremely high thermal capacity, and can thus store and emit large quantities of thermal energy. For instance, the temperature of 1m<sup>3</sup> earth increases five times more than that of 1m<sup>3</sup> water, when putting in the same quantity of heat energy.**

**This explains the temperature-regulating effect of large water bodies such as seas or lakes, resulting in the typical maritime climate on the one hand and the continental climate on the other.**



**Fig 2/18 Difference between continental and maritime climate**

**A similar balancing effect is caused by a thick vegetation cover such as a forest, partly**

**because it contains large quantities of water.**

### **2.3 Human requirements regarding indoor climate**

**One of the main functions of buildings is to protect the inhabitants from outdoor climatic conditions which are often harsh and hostile. The building must provide an environment that does not harm the health of the inhabitants. Moreover, it should provide living and working conditions which are comfortable.**

**To achieve this, the physiological functions of the human body are to be considered. It is also necessary to know under which thermal conditions human beings feel comfortable.**

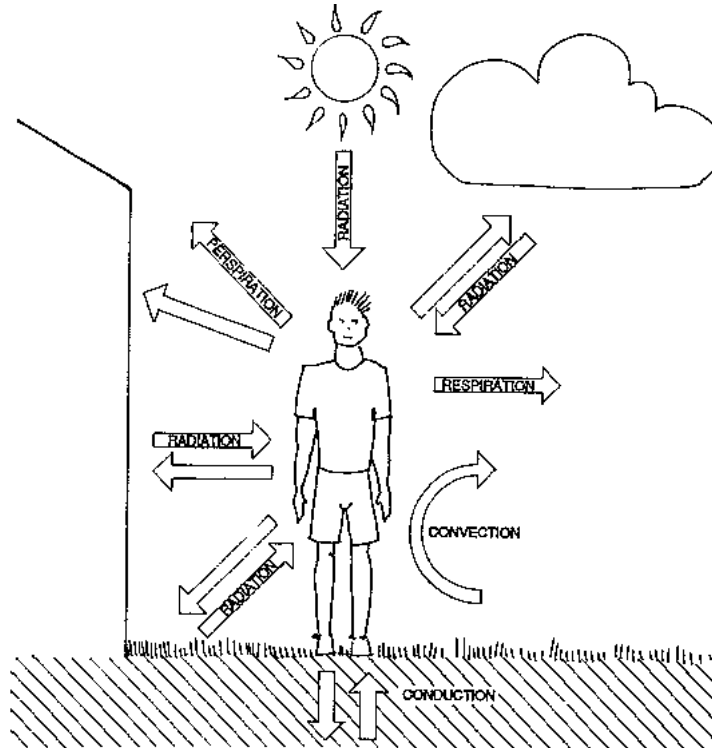
#### **2.3.1 Human physiology**

**Physiological factors are of primary importance with regard to comfort. The internal temperature of the human body must always be kept within narrow limits at around 37°C. Any fluctuation from this value is a sign of illness, and a rise of 5°C or a drop of 2°C from this value can lead to death.**

**The body has the ability to balance its temperature by various means.**

**This thermal balance is determined, on the one hand, by the "internal heat load" and on the other, by the energy flow (thermal exchange) between the body and the environment.**

**The thermal exchange between the body and the environment takes place in four different ways: conduction, convection, radiation and evaporation (perspiration and respiration).**



**Fig 2/19 Ways of thermal exchange by the human body**

### **Conduction**

**The contribution that conduction makes to the heat exchange process depends on the thermal conductivity of the materials in immediate contact with the skin. Conduction**

usually accounts for only a small part of the whole heat exchange. It is limited to local cooling of particular parts of the body when they come in contact with materials which are good conductors. This is of practical importance in the choice of flooring materials, especially where people usually sit on the floor.

## Convection

Heat exchange by convection depends primarily on the temperature difference between the skin and the air and on air movement. It can, to a certain extent, be controlled by adequate clothing.

The insulation effect of clothing can be expressed by a clothing-value ("clo-value").

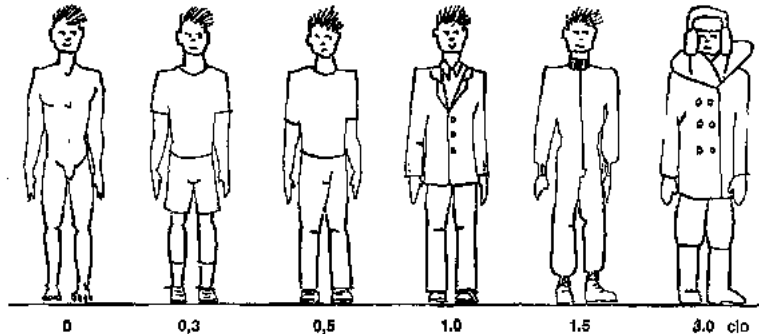


Fig 2/20 Insulation values of different kind of clothing (1 clo =  $0.155 \text{ m}^2\text{K/W}$ ). Source: [ 121 ]

## Radiation

Radiation takes place between the human body and the surrounding surfaces such as

**walls and windows; and, in the open air, the sky and sun. In this process temperature, humidity and air movement have practically no influence on the amount of heat transmitted. This amount of heat depends mainly on the difference in temperature between the person's skin and the surrounding or enclosing surface.**

**The body may gain or lose heat by above described processes depending on whether the environment is colder or warmer than the body surface. When the surrounding temperature (air and surfaces) is above 25°C, the clothed human body cannot get rid of enough heat by conduction, convection or radiation.**

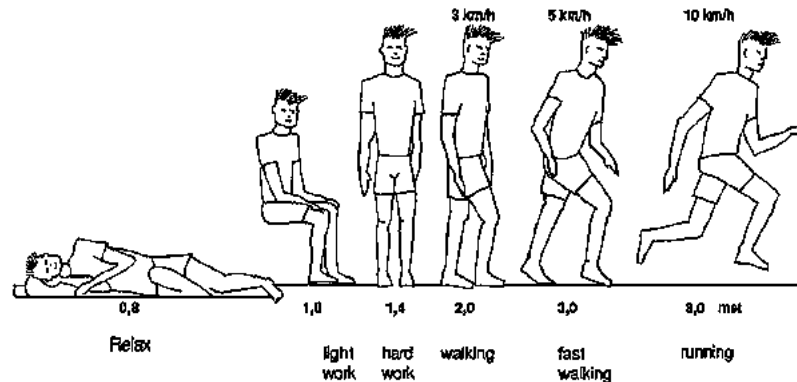
**Evaporation (perspiration and respiration)**

**In this case the sole compensatory mechanism is evaporation by the loss of perspiration, together with, to a certain extent, respiration. During evaporation water absorbs heat, and as humans normally lose about one litre of water a day in perspiration, a fair amount of heat is taken from the body to evaporate it. The lower the vapour pressure (dry air) and the greater the air movement, the greater is the evaporation potential.**

**This explains why extreme temperatures in humid climates are less bearable compared to the same temperatures in dry climates.**

**Internal heat load**

**The "internal heat load" of a body depends on its metabolic activity and varies greatly (see table below).**



**Fig 2/21 Metabolic rate of different activities (1 met = 58 W/m<sup>2</sup>) [ 121 ]**

### 2.3.2 Thermal comfort zone

#### Definition

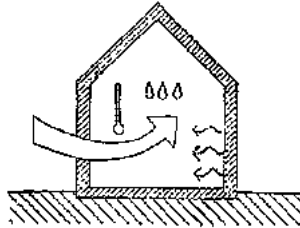
The optimum thermal condition can be defined as the situation in which the least extra effort is required to maintain the human body's thermal balance. The greater the effort that is required, the less comfortable the climate is felt to be.

The maximum comfort condition can usually not be achieved. However, it is the aim of the designer to build houses that provide an indoor climate close to an optimum, within a certain range in which thermal comfort is still experienced.

This range is called the comfort zone. It differs somewhat with individuals. It depends also on the clothing worn, the physical activity, age and health condition. Although ethnic differences are not of importance, the geographical location plays a role because of habit and of the acclimatization capacity of individuals.

**Four main factors, beside of many other psychological and physiological factors, determine the comfort zone:**

- **air temperature**
- **temperature of the surrounding surfaces (radiant heat)**
- **relative humidity**
- **air velocity**



**Fig 2/22 Physical factors of climatic comfort**

**The relation of these four factors is well illustrated in the bioclimatic chart.**



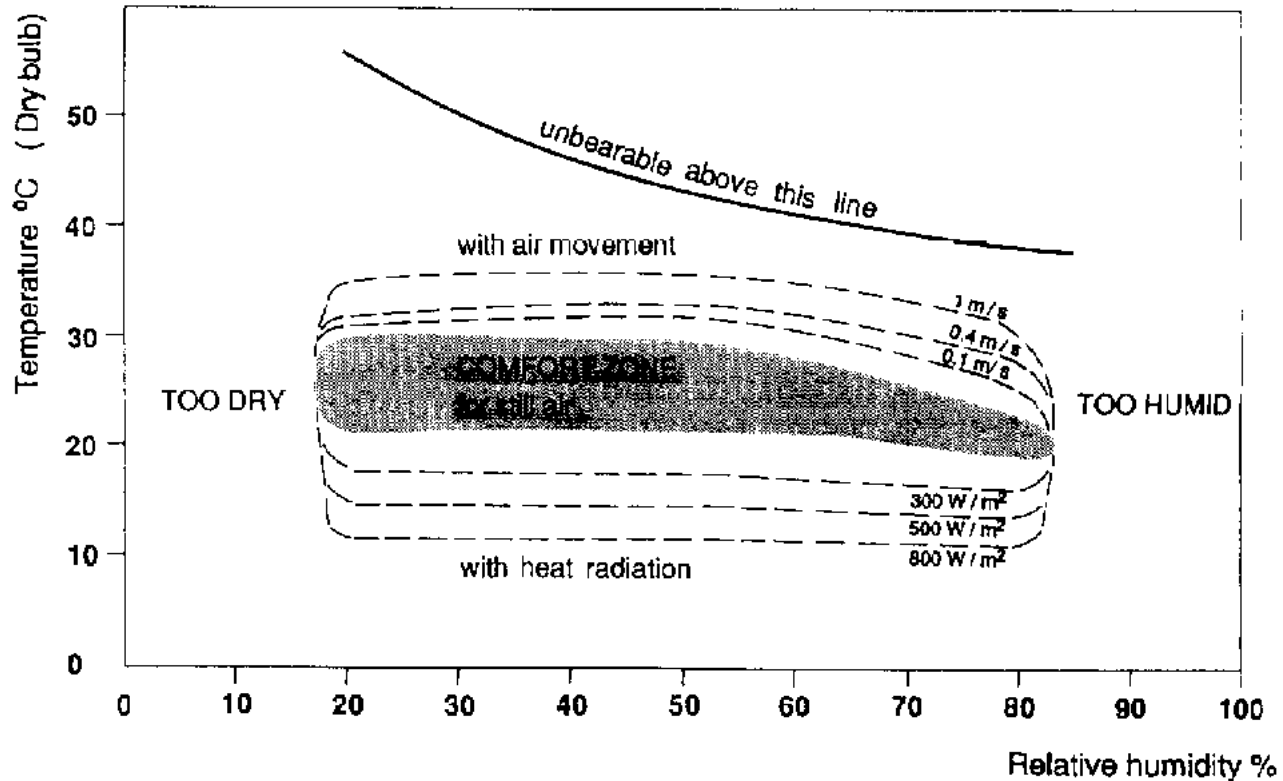


Fig 2/23 Bioclimatic chart according to [ 13 ]

The chart indicates the zone where comfort is felt in moderate climate zones, wearing indoor clothing and doing light work. It also assumes that not only the air temperature, but also the temperature of surrounding surfaces lie within this range.

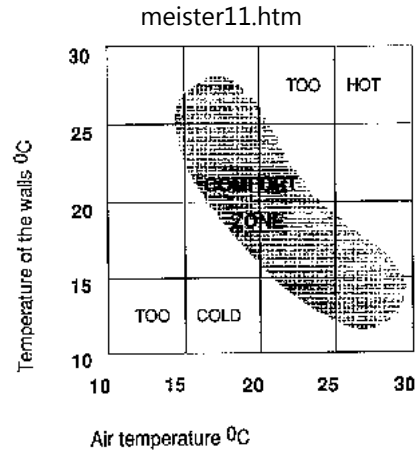
## **The sol-air temperature**

**Radiation and temperature act together to produce the heat experienced by a body or surface. (see Chapter 2.4)**

**This is expressed as the sol-air temperature and is composed of three temperatures:**

- a) outdoor air temperature**
- b) solar radiation absorbed by the body or surface**
- c) long-wave radiant heat exchange with the environment**

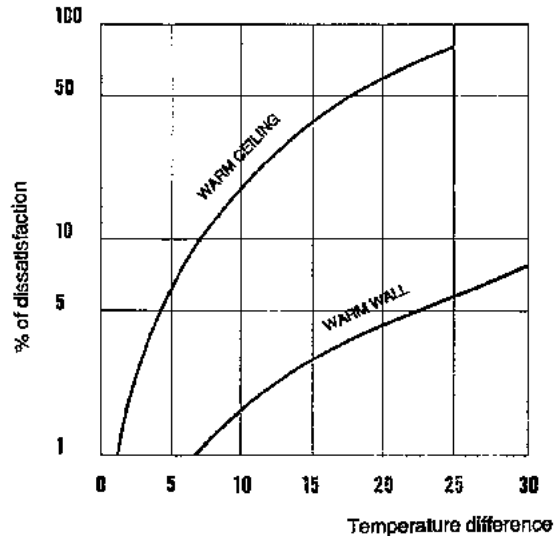
**Air- and surface temperatures often differ. This is especially the case where there are great differences between day and night temperatures and also where building components receive strong solar radiation. To a certain extent, high air temperatures can be compensated by low surface temperatures or vice versa, as is shown in the graph below.**



**Fig 2/24 Comfort zone in differing air and surface temperatures**

**The temperature difference between air and surfaces, however, should not exceed 10 - 15°C if comfort is still to be maintained. As research has shown, this fact is less valid for walls, but especially important for ceilings.**

**The graph shows how people react to different surfaces which have a temperature differing from the temperature of the other surfaces.**



**Fig 2/25 Percentage of dissatisfied persons in relation to uneven surface temperatures [ - 121 ]**

**The design of the roof is therefore of the utmost importance.**

**The fact that the roof receives the greatest amount of solar radiation and re-radiates most at night is a further reason for the importance of roof design. A typical example of the effect of the roof design on inside temperatures is the plain concrete roof slab under a tropical sun which can result in an unbearable indoor climate in the evening, with inside surface temperatures of up to 50 or 60°C.**

### **Humidity**

**The humidity level affects the amount that a person perspires. It also influences, therefore, how temperatures are felt. High humidity reduces the comfortable maximum temperature; low humidity allows a tolerance for higher temperature. At the lower limit of the comfort level humidity has little influence.**

**Range of comfort in relation to humidity, with light summer clothes or 1 blanket at night**

<b>Humidity %</b>	<b>Day temp °C</b>	<b>Night temp °C</b>
0-30	22-30	20-27
30-50	22-29	20-26
50-70	22-28	20-26
70-100	22-27	20-25

**Humidity alone does not have a very significant influence on the comfortable temperature range, but in combination with air circulation it gains much importance.**

### **Wind speed**

**As the figures below shows, air circulation influences the temperature felt. The cooling effect of wind increases with lower temperatures and higher wind speed.**

Indoor wind speed m/sec	Mechanical effect	Effect on human	Cooling effect (°C)				
			Dry skin			Moist skin	
			Ambient air temperature				
			15°C	20°C	25°C	30°C	30°C
0.1	Minimum likely in domestic situations	May feel stuffy	0	0	0	0	0
0.25	Smoke from cigarette indicates movement	Movement not noticeable except at low air temperature	2	1.3	0.8	0.5	0.7
0.5	Flame from a candle flickers	Feels fresh at comfortable temperatures, but draughty at cool temperatures	4	2.7	1.7	1.0	1.2
1.0	Loose papers may be moved, equivalent to walking speed	Generally pleasant when comfortable or warm, but causing constant awareness of motion, maximum limit for night comfort	6.7	4.5	2.8	1.7	2.2
1.5	Too fast for desk work with loose papers	Draughty at comfortable temperatures, maximum limit for indoor activities	8.5	5.7	3.5	2.0	3.3
2.0	Equivalent to a fast walking speed	Acceptable only in very hot and humid conditions when no other relief is available	10	6.7	4.0	2.3	4.2

Note: Effect on human relates to domestic situations. In factories and other buildings higher wind speed may be desirable and comfortable.

Source: [ 136 ]

**This increased cooling effect of enhanced wind speed has another important consequence: the higher the air temperature, the higher the wind speed which is still felt to be comfortable .**

**Acclimatization and seasonal changes**

**To a certain extent human beings have the ability to become acclimatized. Therefore the resident population feels less stressed by a harsh climate than a passing traveler coming from another type of climate would. Analogously this can also be said for seasonal climatic changes, to which people can become adjusted. A certain temperature may be felt to be too cool in summer but too hot in winter.**

**The table below shows an example of the seasonal changes in the comfort zone as observed in Dhahran.**

Day and nighttime comfort temperature ranges for Dhahran

Time	Month											
	Jan	Feb	Mar	Apr	May	June	Jul	Aug	Sept	Oct	Nov	Dec
Day	22.5	22.5	28.5	30.5	32.5	32.5	32.5	32.5	30.5	30.5	28.5	22.5
	18	18	22.5	28.5	29.5	29.5	29.5	28.5	28.5	28.5	22.5	18
Night	20	20	20	25.6	26	29	28.5	28.5	28	25.5	20	20
	16	16	16	20	20	26.5	28	28	25.5	20	18	16

**Source: [ 164 ]**

### **Changes between indoor and outdoor climate**

**Drastic changes which can occur, especially in air-conditioned buildings, may give discomfort (stress situation) and may also be negative for health.**

### **Clo-value and met-value, tolerance**

**As mentioned above, clothing and metabolic activity have a great effect on the comfort zone. Moreover, they also influence the acceptable temperature range (tolerance). A physically highly active person can bear quite wide temperature differences, whereas a**

sleeping person is more sensitive to differences.

The figure below illustrates this relationship. The temperatures are valid for middle-European conditions.

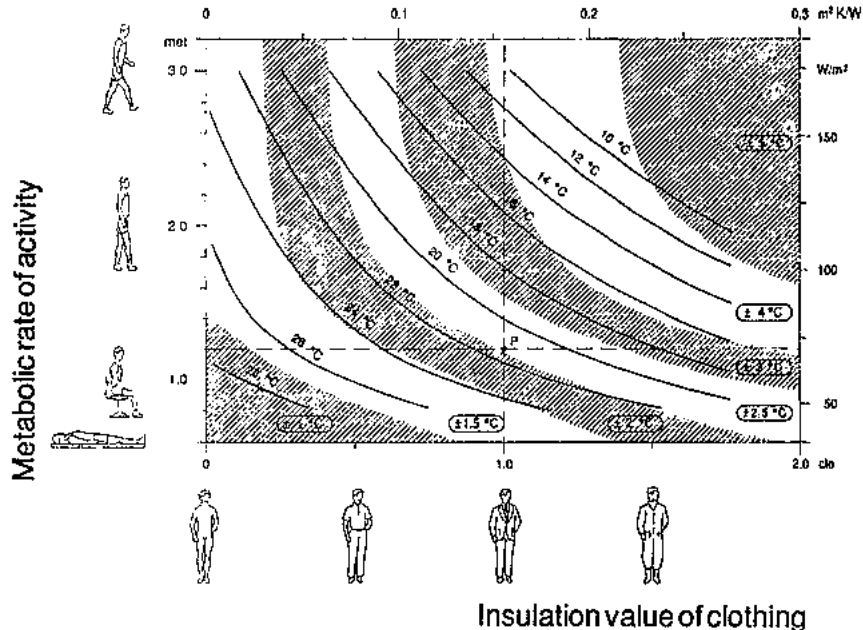


Fig 2/26 Optimum room temperature in relation to activity and clothing

Source: ISO 7730 (1984): Moderate environment, Determination of the PMV and PPD indices and specifications for thermal comfort, and element 29, Zurich, 1990



**The white and shaded areas indicate an incidence of less than 10% of persons dissatisfied (PPD). This illustrates that the higher the clo value or the activity level of a person, the greater his tolerance for differences in temperature will be.**

### **Example:**

**For a seated person wearing a suit (clo = 1.0; met = 1.2) the ideal room temperature is 21.5°C with a tolerance of +-2°C.**

### **Other factors**

**Factors other than climatic ones influence also the well being of the inhabitants, for example, psycho-social condition, age and health condition, air quality and acoustical and optical influences. Although these factors cannot be improved by climatically adapted construction, they should not be forgotten, because they may considerably reduce the tolerance. For example, ill people lying in a hospital or people under extreme noise stress are much more sensitive to climate than people enjoying a garden restaurant.**

### **Conclusions**

**Due to the many factors described above which determine the comfort zone, it is not possible to describe it accurately in a single figure or chart. Summarizing, the bioclimatic diagram (Fig 2/23) may be applied considering the following parameters:**

- **Air and surface temperature may not differ more than 10 - 15°C.**
- **The temperature of the ceiling should not be much higher than the room temperature.**
- **At the upper limit of comfort, the temperature should be lower with increasing humidity.**
- **With increased air temperature, air circulation should be enhanced.**

- **The temperature that is felt to be comfortable changes with the seasons.**
- **The temperature that is felt to be comfortable also depends on the degree of acclimatization.**
- **The temperature that is felt to be comfortable is affected by the clothing worn and the physical activity level.**
- **With additional clothing and increased activity, the tolerable temperature range extends.**
- **Drastic temperature changes, as may be the case in air-conditioned buildings, should be avoided.**
- **Factors other than climatic ones (e.g. psycho-sozial factors) may decrease the tolerable temperature range.**

### **2.3.3 Requirements for buildings according to their functions**

**Comfort conditions as described are not usually found outdoors and clothing alone is often not sufficient to compensate. An important function of buildings is to provide the necessary protection against the outdoor climate. However, not all types of buildings and not all rooms in a building have to fulfill the same requirements.**

**While designing a building and working out the thermal concept, the following functional parameters should be analyzed and considered:**

- **What type of activities and functions will be carried out in the building ?**
- **When do these activities take place during the course of the day ?**
- **Where and in which room do these activities take place ?**
- **What are the anticipated seasonal changes for these functions ?**

## **Working space**

**Such areas are usually used in daytime only. As a consequence the design should be optimized such as to provide favourable conditions in daytime. The performance at night is of little importance. In areas where hard physical labour is carried out, the temperature should be generally lower than in areas, where sitting activities are predominate.**

## **Residential space**

**Structures for residential purposes are generally occupied throughout day and night. They should therefore be designed for an optimization over the whole period. Special attention should be paid to sleeping areas and their nighttime conditions, as the body is more sensitive to discomfort when at rest.**

## **Seasonal differences**

**Similarly, requirements for buildings and rooms may differ throughout the seasons. A house which is used mainly in summer would certainly differ from a house used mainly in winter.**

**The daily routine of the inhabitants may also vary with the seasons. For example, in the hot season, people may start work early, thus benefiting from favourable temperatures. During the hottest hours a break may be taken. At this time the indoor temperature should still be at a comfortable level to allow relaxation. The late afternoon and evening hours may be spent outdoors when the temperature is past its peak. In the cold season the customs may be different: activities are started later in the morning, a great part of the day is spent outdoors and the evening is spent inside.**

### **2.3.4 Limitations**

## **No ideal solution**

**No ideal solution** From the technical and economical point of view it is usually impossible to provide buildings that fulfill the climatic requirements of all the inhabitants and under all prevailing climatic conditions throughout the year. As a general rule, buildings may be designed to satisfy about 80-% of the inhabitants during approximately 90% of the time during the course of the year. On exceptionally hot or cold days a greater degree of discomfort may be acceptable.

**The hottest and coldest 10% of days do generally not have to be considered.**

## **2.4 Physics**

**Obviously, indoor climate depends largely on outdoor climate, especially in the case of passive buildings that are neither heated nor cooled. To a certain extent, however, the indoor climate can be influenced with the help of appropriate designs and materials. This influence depends on the physical processes that occur.**

### **General principles**

**In order to gain a general understanding of the most important processes, the main physical principles are explained. Together with the physical data given in Appendix 5.1 a rough assessment of the characteristics of the most common materials and composite constructions is possible.**

**The main physical processes that govern the indoor climate are:**

- **Thermal radiation**
- **Heat transmission**
- **Convection**

- **Heat storage and time lag**
- **Internal heat sources**

### **Practical recommendations**

**This chapter explains only the basic physical phenomena. Evaluation and recommendations for particular materials and for a specific situation are given in Chapter 3.**

### **Detailed information**

**To verify the exact thermal performance of building components is a rather complex task. Detailed information and calculation methods necessary for the study of specific problems can be obtained from various technical books [-8, 11, 127-]**

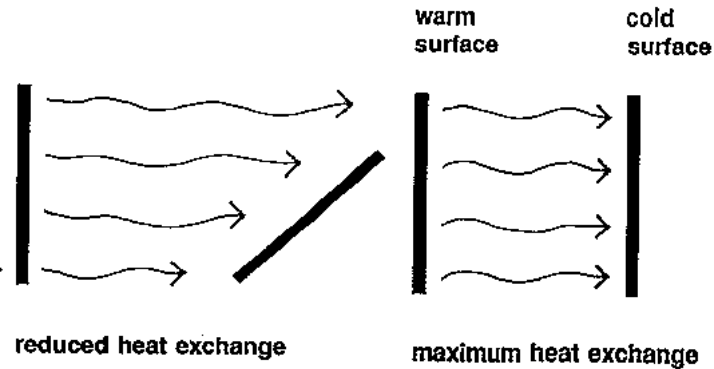
#### **2.4.1 Thermal radiation (also see Chapter 3.1.4)**

##### **Definition**

**Radiation is the heat transfer from a warmer surface to a cooler surface which are facing each other. This happens in the form of waves and a transmitting media (e.g. air) is thus not required.**

##### **Emittance**

**The warmer surface emits thermal energy in the form of radiant heat always towards a cooler surface. The quantity of emitted energy depends on the temperature difference between the surfaces, and also on the material property (emissivity) of the warmer surface.**



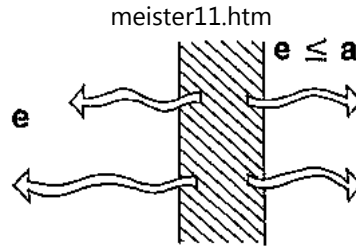
**Fig 2/27 Emittance  $\epsilon$**

### **Absorption and reflectance**

Depending on these surface properties the radiation received by the cooler surface can be partly absorbed and partly reflected. These properties are called absorbance-( $a$ ) and reflectance-( $r$ ).

( $a$ )+-( $r$ ) always equals 1.

Light-colored, smooth and shiny surfaces tend to have a higher reflectance. For the perfect theoretical white surface the reflectance is 1 and the absorbance is 0; for the perfect "black body" absorber the reflectance is 0 and the absorbance is 1.

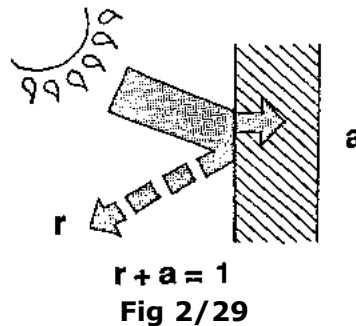


**Fig 2/28 Absorbance  $a$  and reflectance  $r$**

### Geometrical location

The quantity of radiant heat that a body receives depends also on the geometrical location with regard to the heat source.

Surfaces which directly face each other exchange the greatest thermal radiation, whereas surfaces that are turned away from each other exchange less.



### Balancing effect

**As a consequence of this radiation, the warmer surface cools down and the cooler surface heats up.**

**(Values of emittance and reflectance of the main building materials see Appendix 5.1 )**

### **2.4.2 Heat transmission (also see Chapter 3.1.4)**

**Heat always flows from a higher temperature to a lower temperature. The quantity of heat transmitted through a material depends on**

- **its conductivity;**
- **the temperature difference between outside and inside;**
- **the thickness of the material; and**
- **the surface conductance.**

#### **The conductivity $k$ (W/mK)**

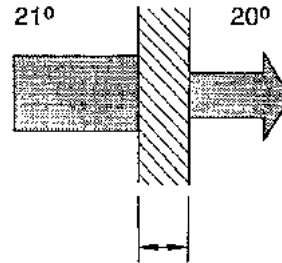
**In conduction, the spread of molecular movement constitutes the flow of heat. The rate of heat flow varies with different materials and depends on its thermal conductivity ( $k$ ). It is defined as the rate of heat flow through a unit area of unit thickness of the material, by a unit temperature difference between the two sides. The dimension is W/m°C. This value is used to compare the thermal insulation effectiveness of materials that are homogeneous in composition. Its value ranges from 0.03 W/m°C for thermal insulation materials up to 400 W/m°C for metals. The lower the conductivity, the better an insulator is the material.**

**( $k$ -values of different materials see Appendix 5.1 )**

**(The  $k$ -value corresponds with  $\lambda$  in the German system)**



How much heat passes through a homogeneous section?



$$k = \frac{W}{m} \cdot K \cdot \left( \frac{W}{m^2} \cdot \frac{m}{K} \right)$$

**Fig 2/30 Conductivity k**

### **Air is a most efficient insulator**

**Air has an extremely low k-value. The higher the percentage of air enclosed in the material, the better is its insulation value, as long as convection does not occur. To avoid convection, the air enclosures must be fine. The finer the air inclusions, the less convection takes place.**

**Low weight materials tend to contain more air, thus their conductivity is less. This relationship is generally true for materials of the same kind but of varying densities, and of the same materials with varying moisture content.**

### **Humid materials are poor insulators**

**Water has a conductivity of 580 W/m°C versus 0.026 W/m°C for still air. Therefore, if the**

**air enclosed in the is replaced by water, the material's conductivity is rapidly increased. For example, an asbestos insulating board in dry conditions has a conductivity four times lower than that of the same board soaked with water.**

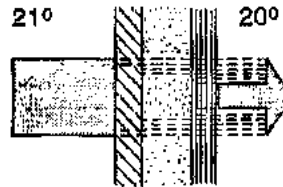
**Resistance R ( $\text{m}^2\text{K}/\text{W}$ )**

**The resistance depends on the conductivity and the thickness of a material.**

**It is defined as thickness /  $k = R$**

**How much heat is prevented from passing through a non-homogeneous section?**

**The total resistance of a composite construction is the sum of the resistance of its components, thus  $R_1 + R_2 + R_3 \dots = R_{\text{total}}$**



$$R_T = R_1 + R_2 + R_3$$

**Fig 2/31 Resistance R**

**Heat transfer at the surface or surface conductance  $f$  ( $\text{W}/\text{m}^2\text{K}$ )**

**A thin layer of air film separates the material surface from the surrounding ambient air, and this air film has a specific conductance ( $f$ ) in relation to the transfer between material and the surrounding air. Surface conductance includes the convection and radiant components of the heat exchange at the surfaces. The resistance of these films is**

**expressed as  $1/f$ .**

**For internal surfaces this resistance ( $f_i$ ) is around  $0.15\text{-m}^2\text{°C/W}$ , and for external surfaces ( $f_o$ ) it varies between  $0.1$  and  $0.01\text{ m}^2\text{°C/W}$  depending on wind exposure.**

**Transmittance  $U$  ( $\text{W/m}^2\text{K}$ )  
(see Appendix 5.1 )**

**Adding the surface resistance  $1/f$  to  $R$  total, the total heat transmission can be calculated:**

$$\frac{1}{U} = \frac{1}{f_i} + R_{total} + \frac{1}{f_o}$$

**The reciprocal value is the thermal transmittance  $U$ .**

**(The  $U$ -value corresponds with the  $k$ -value in the German system)**

**Quantity of transmitted heat**

**The  $U$ -value represents the total heat transmitted through a composite construction by a temperature difference of  $1\text{°C}$ . Multiplying it with the effective temperature difference gives the total heat energy transmitted:**

**Total heat transmission =  $U \cdot (t_i - t_o) \cdot (\text{W/m}^2)$**

**This value, however, is only valid for the theoretical case of stable temperature conditions over a longer period. In reality, the outdoor temperature fluctuates during the course of the day. This is of special relevance in the case of warm climates, where the houses are neither heated nor cooled and the heat flow is thus not unidirectional. Here the time lag, the decrement factor and the thermal capacity play important roles.**

### **2.4.3 Heat storage**

**(also see Chapter 3.1.4)**

### **Specific heat (Wh/kgK)**

**This is defined as the amount of energy required for a unit temperature increase in a unit mass of material. The higher the specific heat of a material, the more heat it will absorb for a given increase in temperature. Of all common materials, water has the highest specific heat.**

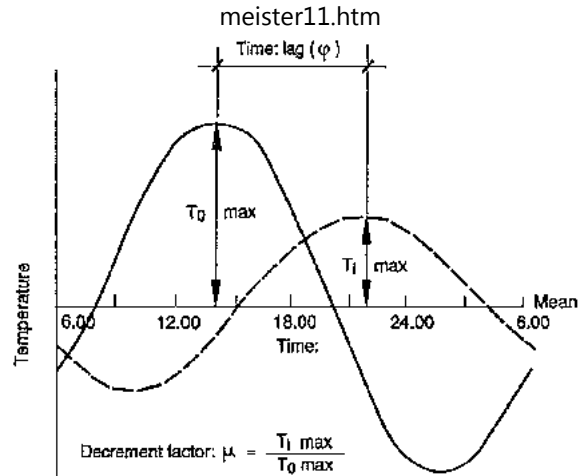
### **Heat capacity Q (Wh/m<sup>2</sup> K)**

**This is defined as the amount of heat energy required for a unit temperature increase in a unit of area.**

**Thickness x specific mass x specific heat = heat capacity (Q)**

### **Time lag O (h) and decrement factor**

**The time lag is defined as the time difference between the peak outer surface temperature and the peak inner surface temperature; it is actually the time required for the heat to pass through a material. It is of importance, for instance, in the case where one wants to take advantage in the evening of day time surplus heat energy.**



**Fig 2/32. Source [ 8 ]**

### Decrement factor

The decrement factor is the ratio between the temperature fluctuation on the outer and the inner surface. It is the measure of the damping effect. Generally, the higher the thermal capacity or the higher the thermal resistance of a material, the stronger is the damping effect.

The time lag can be controlled by the selection of materials and their thickness. It depends on the thermal capacity  $Q$  and the resistance  $R$ .

For heavy materials the time lag can be roughly calculated using the formula

$$\text{time lag } O = 1.38 + (Q \times R)^{1/2}$$

**For composite constructions, an additional estimated lag should be added to the individual sum of the time lags. It is customary for two layers and light construction walls to add an additional 0.5 hour; for three or more layers, or for very heavy constructions, one additional hour lag is assumed.**

**(Time lag values of common materials and composite constructions see Appendix 5.1 )**

### **Active heat storage capacity**

**The heat storage capacity and the time lag of a building structure can be utilized for balancing the indoor temperature. In such a case, however, the so-called active mass only, and not the entire building mass, is taken into account ( see Chapter 3.1.4 ).**

### **2.4.4 Solar heat gain factor**

**When selecting construction materials in areas with intense solar radiation an important criterion is the solar heat gain factor (SHF). This is defined as the rate of heat flow through the construction due to solar radiation expressed as a percentage of the incident solar radiation. [ 8 ].**

**SHF (%) = 100 x transmitted solar energy / incident solar energy**

**As this value can be related to the increase in the inner surface temperature, a performance standard can be established on the basis of experience. Its value should not exceed 4% in warm-humid climates or 3% in hot-dry climates.**

**A graphic method exists for calculating the SHF. [ 120 ].**

**For instant practical use a table with the values for common constructions can be found in Appendix 5.1**

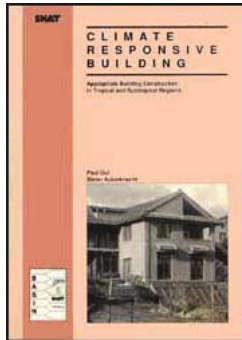
## 2.4.5 Vapour diffusion

**Water in the form of vapour diffuses through the outer building shell when the outside and inside vapour pressures differ. Vapour usually diffuses from the warmer towards the cooler side of the shell.**







**This phenomenon requires attention in the case where there is likely to be an area of condensation inside the shell (e.g. "vapour barrier" on the cooler side). This happens when the saturation point is reached, particularly in heated or constantly cooled buildings. In air-conditioned buildings, especially, this aspect requires consideration. However, in naturally climatized buildings such conditions usually do not occur. Hence vapour diffusion is not dealt with in this publication.**



[Home](#) > [ar.cn.de.en.es.fr.id.it.ph.po.ru.sw](#)



### **Climate Responsive Building - Appropriate Building Construction in Tropical and Subtropical Regions (SKAT, 1993, 324 p.)**

- ➔  **3. Design rules**
  -  **3.0 Design methodology**
  -  **3.1 General guidelines**
  -  **3.2 Design for hot-arid zones**
  -  **3.3 Design for warm-humid zones**
  -  **3.4 Design for temperate and upland zones**

## **Climate Responsive Building - Appropriate Building Construction in Tropical and**

## **Subtropical Regions (SKAT, 1993, 324 p.)**

### **3. Design rules**

#### **3.0 Design methodology**

##### **The main points:**

- **Collect information about the local climate factors and the requirements of the user.**
- **Analyse this information.**
- **Develop the appropriate design concept.**

##### **Function**

**When planning any new construction, many factors have to be considered. First of all the functions of the building have to be defined which have a primary influence on its type, form, size and layout. The requirements or needs of the user - such as his expectations with regard to comfort - are important determinants.**

##### **Safety**

**Factors which may impair the safety of the building are very important. Amongst these are earthquakes, storms, floods and tidal waves.**

##### **Economy**

**Economic aspects also influence the design and determine the technical possibilities and standard of building.**

##### **Ecology**



**The adequate application of the available local resources and materials has to be taken into account.**

## **Climate**

**A major component are the prevailing climatic conditions insofar, as they influence the indoor comfort conditions. These are the main subject of this publication.**

**Climate is formed by**

- **solar radiation**
- **glare**
- **temperature and its fluctuations**
- **precipitation**
- **humidity**
- **air movement**
- **air pollution**
- **sand and dust**

**General information about the climate of a country can usually be obtained from meteorological stations. The particular microclimate at a given site may however differ substantially. It is important, therefore, to observe local conditions.**

**It is also important to bear in mind, at what time of the day or night, or during which season, the structure will mainly be used.**

## **Design approach**

**The basic steps in the design approach are:**

- **Information collection about the factors listed above.**
- **Analysis of collected information.**
- **Development of appropriate design measures.**

**With an appropriate design and the selection of suitable materials, a natural form of climate control can be achieved. By being merely self-regulating, this control provides, to a great extent, protection from the occasionally hostile environment.**

**Compared to solutions employing technical equipment, such natural means of climatization are usually very economical solutions, both in terms of construction and running costs. Nevertheless, the use of modern technical means is under certain circumstances unavoidable in trying to meet today's requirements for adequate comfort.**

### **New building concepts**

**It is necessary to develop new building concepts which include essential energy and climate considerations, but are also linked to the functional, physiological and socio-psychological requirements of today's society.**

**This chapter illustrates the possibilities and methods for a natural form of climate control. It provides general recommendations and rules: in the first part, such rules which are valid for tropical and subtropical regions in general; and in the subsequent parts, for typical types of climates.**

**In some cases, the local conditions do not correspond exactly to the typical climates described. The rules require a meaningful interpretation, and sometimes compromises will be necessary.**

### **Limitations of passive means**

**With the technology available, the majority of responses to harsh climatic conditions has been the creation of artificial environments, leading to a complete dependence on electrical power. A number of mechanical devices generating additional heat have been introduced into homes. With the increasing interest in tropical regions, however, much research has been done to improve the design and materials of the different building components (walls, roofs, openings, etc.) so that this dependence may be reduced.[ 124 ]. Nevertheless, it seems almost impossible to fulfil today's higher requirements and create a comfortable, cool indoor climate for living and working during the hot season with only traditional methods and without additional technical means. Where sufficient water is available, it can contribute to cooling by integrating landscaping into urban design and buildings.**

### **Heating**

**In general, active and passive heating of a building is easier than cooling. Nevertheless, for ecological reasons, burning of wood should be reduced in many regions.**

**In many places today, a wide choice of building materials is available to meet specific needs, but they must be tested and selected carefully. [ 106 ]**

### **Hazards**

**Traditional structures and materials may not be suitable in hazardous conditions such as earthquakes, floods and heavy precipitations. Occasional storms can generally be disregarded when designing for comfortable indoor climate. However, for safety reasons, they demand a firm structure.**

### **Maintenance**

**One of the main problems of building in the long run is proper maintenance. This aspect**

**must be considered in the choice of materials and construction details.**

### **The human factor**

**Measures to improve the indoor climate are manifold. Some of them are purely connected with the selection of a suitable site, planning, layout arrangements and construction details. Other measures involve the inhabitants, who should take an active role in the operation of the buildings, e.g. by opening and closing windows at the appropriate time, by sprinkling water, or using movable shading devices etc.**

**Although the second type of measures - using humans in an active role - may appear more effective than purely structural measures, the latter are usually given a higher priority. It must not be overlooked that humans often behave differently from what the designer expects them to do. Also, a proper understanding and awareness on the part of the inhabitants cannot always be relied upon. Sophisticated and complicated solutions often fail due to such human factors.**

### **Learning from tradition**

**The principles of thermal control through the proper use of structure and materials are well illustrated in traditional buildings which meet the demands of the climate. However, purely traditional solutions also assume a continuity of lifestyles and kinds of work, which seems rather unlikely in many regions. Particular solutions, settlement and building forms, also using multi-story structures, have to be found for today's urban and traffic situations. A combination of traditional knowledge and advanced technology may therefore be necessary.**

**A good method, as an approach towards a design concept is to analyse traditional settlement patterns and building types. In addition, settlements are influenced by many social and cultural factors, and usually respond in an optimal way to the local conditions,**

**giving many useful indications. This is true, especially for solutions aiming at natural climate control. Factors to be taken into account are the use of local construction methods and available materials, and the technical ability of the local builders.**

### **3.1 General guidelines**

**The main points:**

- **Minimize heat gain during daytime and maximize heat loss at night in hot seasons, and reverse in cold seasons.**
- **Minimize internal heat gain in the hot season.**
- **Select the site according to microclimatic criteria**
- **Optimize the building structure (especially regarding thermal storage and time lag).**
- **Control solar radiation.**
- **Regulate air circulation.**

#### **3.1.1 Climate and design in general**

**Climatic conditions**

**In general, in tropical and subtropical regions the daytime temperature is uncomfortably high, particularly during the warmer seasons and in low altitude locations. However, the differences between regions are immense, depending mainly on the distance from the equator and on altitude.**

**Air humidity is also of great importance. This factor influences the precipitation pattern and the amount of solar radiation that reaches the earth's surface. The influence of a cloud cover is most obvious, but invisible humidity in the atmosphere also alters the amount of radiation. Whereas with dry air conditions the radiation is strong and direct, humid air results in a less intense but diffuse radiation and also reduces the amount of re-radiation to the night sky.**

**These factors result in mean temperatures that differ highly from place to place. Annual and diurnal fluctuations also vary sharply.  
(also see Chapter 2.2)**

### **Design objectives and response**

**The main objective of climatic design is to provide comfortable living conditions with a minimum and meaningful input of artificial energy. This also reduces investment and running costs as well as ecological damage.**

**The above-mentioned main points are the framework for design in tropical and subtropical climate conditions. They have to be adapted to each climatic zone because the dominant climatic factors differ highly between these zones. This leads to different solutions for various climate types.**

**Such solutions are described in the corresponding chapters.**

### **3.1.2 Settlement Planning**

**Different factors have to be considered when planning settlements. Transportation means and ways, water access, water supply, available materials and technical means, infrastructure, social structure and defense considerations are but a few of them.**

**In view of the general goal of protection from the harsh climate as well as risks, the following main criteria have to be considered :**

### **The main points**

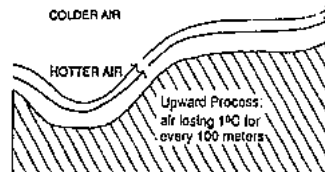
- **Topography, to benefit from microclimatic variations.**
- **Orientation, to optimize sun and wind impact.**
- **Wind, to achieve the required ventilation.**
- **Pattern and form, to optimize the reciprocal impact between buildings.**
- **Hazards, for safety reasons**

#### **3.1.2.1 Topographical location of settlements**

**In selecting the location for a settlement, the microclimatic advantages caused by topographical features of different sites should be considered.**

##### **a) Locations on slopes, hills and in valleys**

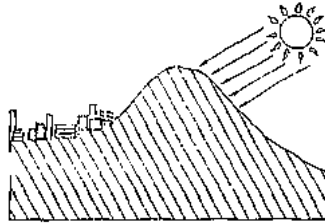
**In general, elevated sites are preferable. Locations at higher altitude have lower temperatures due to the adiabatic phenomenon. The mean temperature decreases by 1°C with 100-m altitude difference.**



**Fig 3/1**

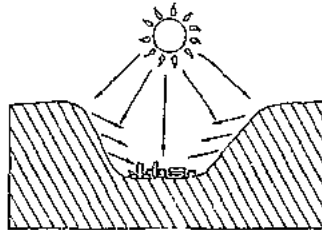
##### **b) Sun-orientation**

**Settlements are preferably placed on northern slopes to avoid excessive sun exposure, using natural shade. West slopes should be avoided. At higher altitude south exposure might be adequate for reasons of passive heating.**



**Fig 3/2**

**Valley bottoms are additionally heated by reflection of sun radiation from the surrounding slopes .**



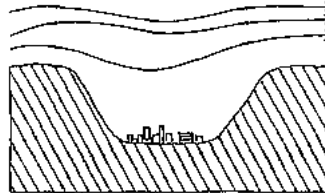
**Fig 3/3**

### **c) Wind - orientation**

**Locations situated at the bottom of valleys are often handicapped. Air movement is usually much better at higher locations. Valleys tend to have lower wind velocity and hence the**



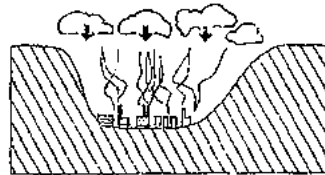
**cooling effect by wind is reduced.**



**Fig 3/4**

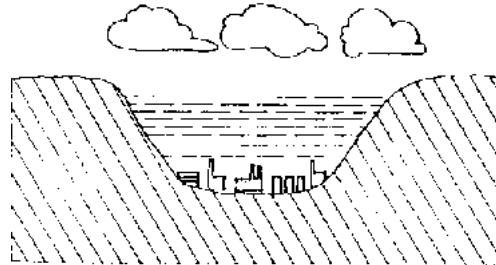
**d) Air pollution**

**Further negative effects of a site located in a valley can be caused by air pollution, especially when polluting industries are combined with poor air movement.**



**Fig 3/5**

**Under certain circumstances the air movement in a valley can be reduced by inversion. It occurs when a relatively cooler layer of air accumulates at the bottom of a valley. If no dynamic winds prevail, this cooler air cannot be replaced because the phenomenon prevents air movement by thermic winds. An air trap may result, and with it, a dangerous increase in air pollution.**



cold air lake in winter, poorly ventilated

**Fig 3/6**

### **e) Location near water bodies and green areas**

**Where possible, settlements should be placed near large bodies of water such as lakes - preferably on the leeward side - and green areas. Water has a regulating effect on the climate because the water temperature is near to the annual mean temperature. Due to the large thermal capacity of water it can absorb surplus daytime heat and reduce the nighttime drop. The resulting temperature difference between the land area and the water surface furthermore produces thermal winds, which blow towards the land during the day and at night away from the land. Green areas have the advantage of cooling by shade and evaporation.**

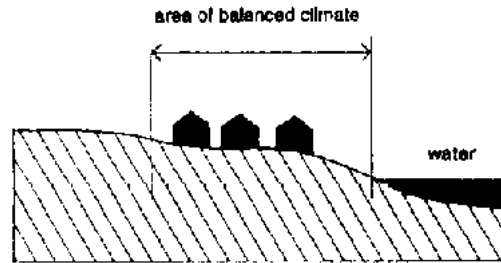


Fig 3/7

### 3.1.2.2 Hazards

#### Floods and landslides

**A threat to building in valleys may be the danger of floods and landslides. Although seldom, even in arid regions heavy rain can occur, causing torrent streams combined with masses of mud, rocks and boulders.**

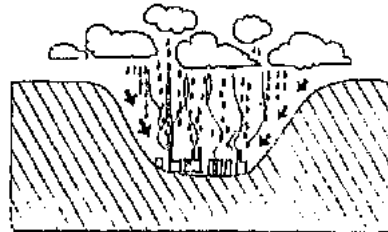


Fig 3/8

#### Winds

**In almost all areas, heavy winds occur and a firm structure is required. Special care, however, has to be taken in areas that are threatened by hurricanes and sandstorms.**

## **Earthquakes**

**Despite the fact that earthquakes are not a topic of climatic design, the location of settlements has to be checked for possible earthquake risks and safe constructions have to be made. They may be in contradiction to traditional design or climatic construction requirements.**

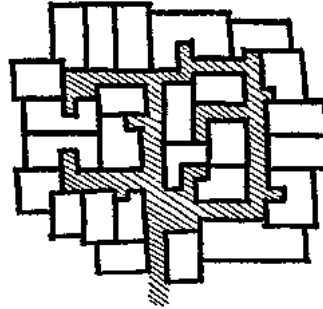
### **3.1.2.3 Urban forms and external space**

**Urban forms depend strongly on climate and are designed differently in each climatic zone. Basic concerns are the provision of shading and air movement by alternative means.**

**The urban form cannot change the regional climate, but can moderate the city's microclimate and improve the conditions for the buildings and their inhabitants.**

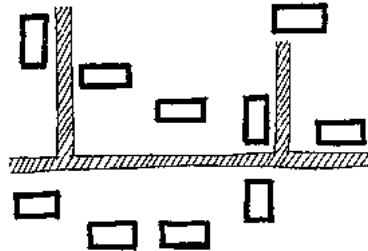
**The influence of the climate on the external space of traditional settlements can be well illustrated by the following examples:**

**Settlements for hot, dry climates are characterized by optimal protection against solar radiation by mutual shading, which leads to compact settlements, narrow streets and small squares which are shaded by tall vegetation.**



**Fig 3/9 Typical settlement for hot-dry regions**

**Settlements for warm humid areas are laid out to make maximum use of the prevailing breeze. Buildings are scattered, vegetation is arranged to provide maximum shade without hindering natural ventilation.**



**Fig 3/10 Typical settlement for warm-humid regions**

**Although modern requirements are often in contradiction to traditional patterns, their advantages should be adapted as far as possible.**

**The use of vegetation in landscaping**

**Designs using vegetation in the urban environment are of functional, aesthetic as well as climatic importance for its radiation absorbent surface and its evaporative and shade-giving properties. The vegetation in and around cities also has definite effects on air movement.**

**Vegetation is desirable both for providing shade, thus reducing the temperature in such shaded areas, and for reducing the effects of strong solar radiation on the walls of buildings and structures. Also, by forming a thick barrier of foliage, the velocity of strong wind is reduced. The foliage of different types of wooded land (e.g. hedges) acts as a filter and purifies the atmosphere by keeping down dust.**

### **Advantages of vegetation**

**Landscaping using vegetation has many advantages:**

- **It improves the microclimate both outdoors and indoors.**
- **It checks hot and dusty winds in arid regions.**
- **Through the transpiration of leaves temperatures are lowered.**
- **Its shade lowers daytime temperatures and heat emission at night is also reduced, thus resulting in more balanced temperatures.**
- **It balances the humidity. During precipitation much of the free water is absorbed and during dry periods water is evaporated.**

**Plants offer longterm energy saving free of cost, both in financial and in ecological terms.**

**In hot-arid areas with limited water reserves, plants with high water requirements may not be possible, but plants adapted to local conditions are always advantageous.**

**Moreover, plants increase the value of indoor and outdoor living space. Outdoor space becomes a more useful area and can accommodate a variety of functions which are not possible in a barren area.**

**The cooling effect of vegetation can be illustrated by the following measurements which were taken in South Africa:**

Slate roof in the sun	43°C
Concrete surface in the sun	35°C
Short grass in the sun	31°C
Leaf surface of tree in shade	27°C
Short grass in shade	26°C

**[ 12 ] (also see Fig 3/94 in Chapter 3.2.2.3)**

### **Selection of plant species**

**When selecting the plant material, it is strongly advisable to consult local plant nurseries about their stocks and their experiences. The suitability and performance of plants depends highly on the specific local conditions:**

- **the climatical factors, temperature, air humidity etc.**
- **soil condition**
- **soil moisture (ground water level)**
- **altitude**

**If there are doubts, plants should first be tested under local conditions, before they are used in a larger scale.**

## **Caution**

**In large cities, where water in abundance can be made available, the excessive use of vegetation and water surfaces can also create a less comfortable microclimate because of too much evaporation that increases the humidity.**

**For the use of vegetation also see Chapter 3.1.3.4, 3.1.5.1, 3.2.2.3, 3.3.2.3, 3.3.5.1, 3.4.5.1 and Appendix 5.6.**

## **Landscaping elements**

**Natural elements of landscape design include the meaningful use of trees, streetscaping with vegetation, surface water management and with it the utilization of the cooling effect of water.**

### **a) Trees**

**Trees and shrubs are a very effective means of improving the climate on a larger scale. They are the simplest way of shading outdoor space and buildings.**

**It is important to select the appropriate type of tree**

**One simple solution for regulating shading by trees throughout the year is the use of deciduous trees, which provide shade during the hot season and allow solar radiation in winter.**

**Another factor that can help in the selection of the right tree is its "cooling factor". When measuring the radiation intensity in the shade of a tree the efficiency of different species varies.**

**The "cooling factor" for the examples given here indicates the radiation intensity**



**compared to unshaded conditions.**



**Millettia atropurpurea**  
Cooling Factor 28%

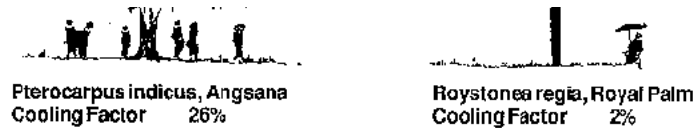


**Delonix regia, Red Flame**  
Cooling Factor 14%



**Enterolobium saman, Rain Tree**  
Cooling Factor 18.5%

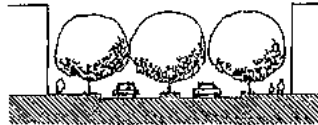




**Fig 3/11 Selected trees and their "cooling factor" (drawing H. Haas)**

### **b) Streetscaping using vegetation**

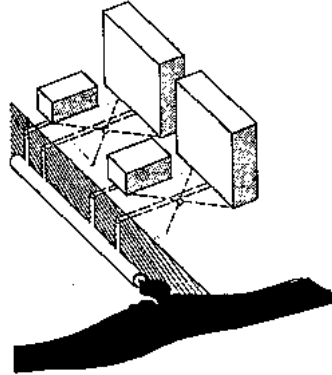
**The furnishing of space with trees and hedges greatly improves the microclimate and quality of life.**



**Fig 3/12 Green street space**

### **c) Surface water management**

**An important aim of road planners is usually, to design drainage systems that ensure a rapid rainwater run-off. Such systems, together with a high percentage of paved surfaces - as is common in urban areas - have the disadvantage that shortly after rainfalls the surroundings are dry again and the cooling effect of the water is lost. Furthermore, the functioning of the drainage systems depend to a great extent on their maintenance. Blocked drainage systems may cause dangerous flood situations. Floods can also occur further down near the river, because the water quantity is not balanced.**



**Fig 3/14 Problems of quick drainage systems: rainwater is moving fast from the sealed surfaces, forming forceful streams**

#### **d) Utilizing the cooling effect of water**

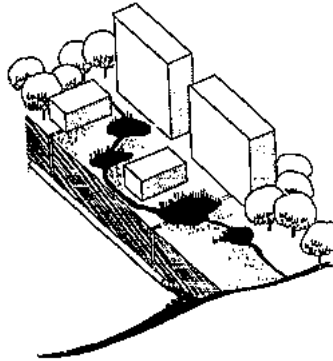
**An alternative approach would be to retain as much surface water as possible for a longer period. This can be achieved by keeping surfaces unpaved wherever feasible. Public open spaces, streets, squares and parks should only be covered by hard top when absolutely necessary.**

**In addition, drainage systems can be combined with ponds and artificial lakes e.g. in park areas. The advantages are obvious:**

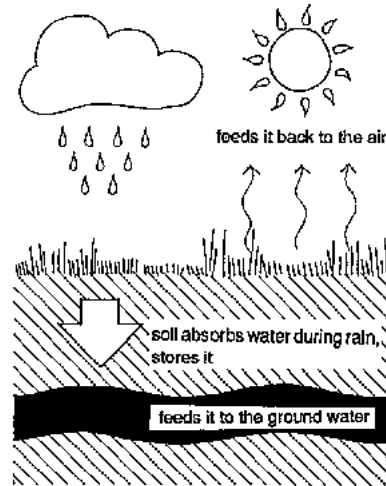
- The increased water content in the air and soil improves the microclimate. It also supports and promotes vegetation which is an additional factor for a favourable microclimate.**
- Such a system also feeds the ground water, which is an important factor with regard to**

**water supply.**

- **The drainage system can be designed for smaller peak flows.**
- **The danger of floods due to blocked drainage systems is reduced.**



**Fig 3/15 Advantages of slow drainage systems: intercepts the rainwater in the greenery, in the ground and ponds, the natural way to prevent floodings**



**Fig 3/16 Water cycle with unpaved surfaces: the soil absorbs water during rain, stores it and feeds it to the ground water and back to the air.**

### **3.1.3 Building design**

#### **The main points**

- **Orientation and room placement, for optimal response to sun and wind.**
- **Form, providing protection where required.**
- **Shade, as much as required.**
- **Ventilation, by excluding climatically adverse side-effects.**

#### **3.1.3.1 Orientation of buildings**

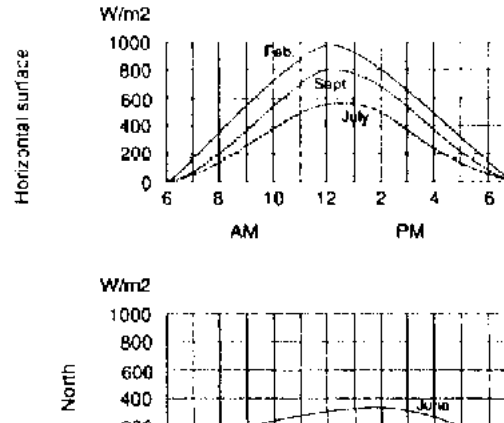
To define the optimal orientation of a building, three factors have to be considered:

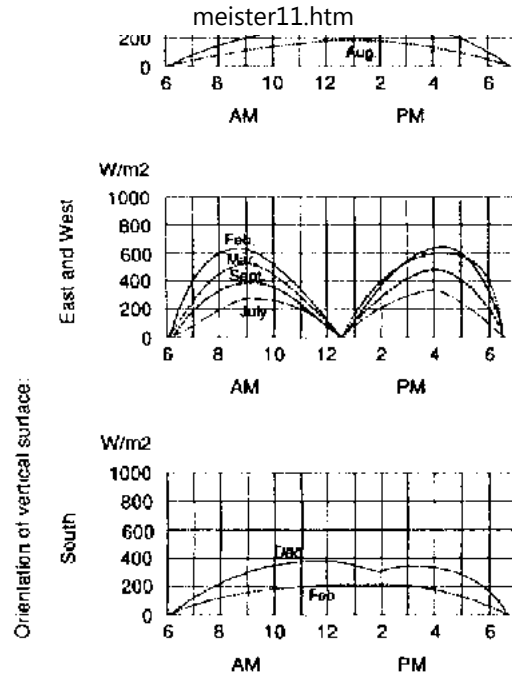
- Solar radiation
- Prevailing wind
- Topography

To define the optimal orientation with regard to heat gain by solar radiation, it is useful to analyse the radiation intensity on differently oriented surfaces, its diurnal change and its change with seasons.

The diagram (Fig 3./17) shows an example of an analysis for 1o South (Nairobi). It indicates, depending on whether heat gain is desired or not:

- What is the optimal orientation ?
- Where are large openings, small or no openings desirable ?
- What kind of structure and shading devices are appropriate for a given surface ?

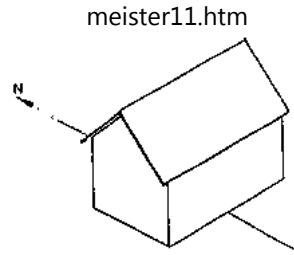




**Fig 3/17 Analysis of the solar radiation intensity in Nairobi [ 8 ]**

**Optimal sun-orientation reduces radiation to a minimum in the hot periods, while allowing adequate radiation during the cool months.**

**East and west facing walls receive the highest intensities of radiation, especially during the hot periods. These walls should thus normally be kept as small as possible and contain as few and small openings as possible.**

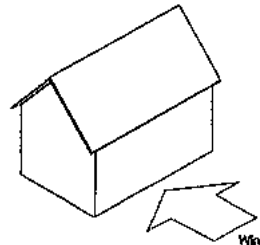


**Fig 3/18 In general, north and south facing is the preferred orientation**

**By plotting the directions of maximum radiant gain for both hot and cool months, it is possible to determine the optimum orientation for any given situation. Some compromise must be made in order to achieve the most satisfactory distribution of the total heat gained in all seasons. [ 10, 11 ]**

### **Wind-orientation**

**Usually cooling by ventilation is desired. Buildings should therefore be oriented across the prevailing breeze. This direction often does not coincide with the best orientation according to the sun. Here a compromise should be found, paying more attention to the effects of solar radiation, because the direction of the wind can be influenced to a certain extent by structural elements**

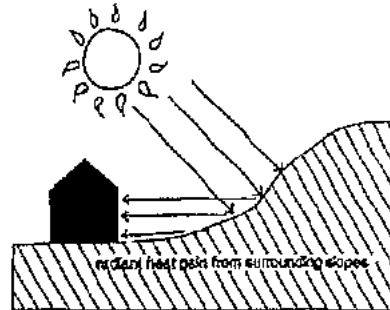




**Fig 3/19 In general, facing the wind is the preferred orientation****Topographical orientation**

The surface of the surroundings may store and reflect solar radiant heat towards the building, depending on the surface's angle relative to the solar radiation and on the type of surface. Where this solar heat is not desired, the orientation of the building should be changed or the surface of the surroundings should be covered with greenery that improves the microclimate.

The topography may also alter the prevailing wind and provide shade at certain time of the day. Such elements should also be considered.

**Fig 3/20 Topography reflecting solar radiation****3.1.3.2 Shape and volume**

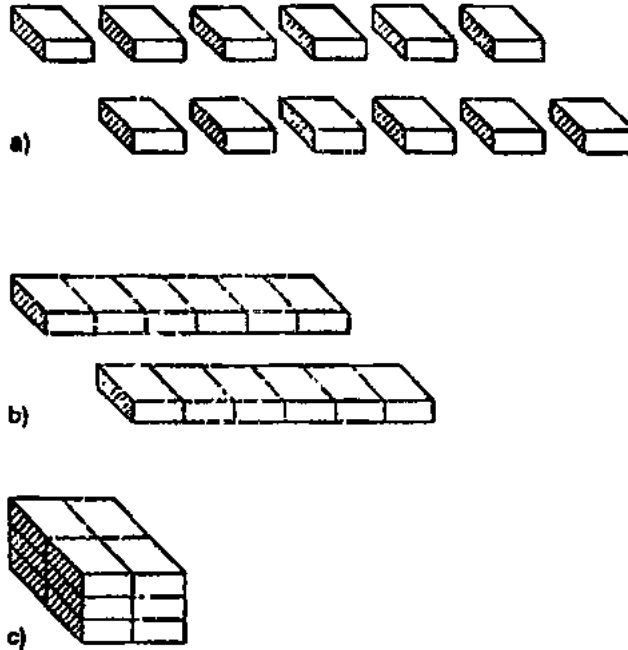
The functional as well as socio-cultural requirements and particularly the climatic conditions define the form of the buildings.

**The heat exchange between the building and the environment depends greatly on the exposed surfaces. A compact building gains less heat during the daytime and loses less heat at night. Therefore, the ratio of surface to volume is an important factor.**

**A simple model calculation on differently arranged building units illustrates this.**

**12 building units of 7 x 7 m width and 3 m height are arranged as individual bungalows, as row houses or as a compact 3-story building. The volume : surface ratio changes drastically.**

	<b>Volume</b>	<b>Surface</b>	<b>Ratio</b>
a) as individual bungalows	1764 m <sup>3</sup>	1596 m <sup>2</sup>	1:1.
b) as row houses	1764 m <sup>3</sup>	1134 m <sup>2</sup>	1:1.6
c) as compact 3-story building	1764 m <sup>3</sup>	700 m <sup>2</sup>	1:2.5



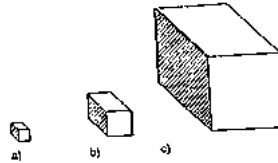
**Fig 3/21 Volume to surface ratio by differently arranged building units**

**A similar phenomenon can be observed when comparing large buildings with small buildings of the same shape.**

**This can be demonstrated when comparing cubes of differing volumes:**

Volume	Surface	Ratio

a) cube 3 x 3 x 3 m	27 m <sup>3</sup>	45 m <sup>2</sup>	1:0.6
b) cube 7 x 7 x 7 m	343 m <sup>3</sup>	245 m <sup>2</sup>	1:1.4
c) cube 20 x 20 x 20 m	8000 m <sup>3</sup>	2000 m <sup>2</sup>	1:4.0



**Fig 3/22 Volume to surface ratio by different sized cubes**

**In general, where little heat exchange between the interior and the environment is desired, the surface to volume factor should be small. The indoor temperature will be near to the average outdoor temperature.**

**Where heat exchange is desired, for instance to gain from cool nights in warm-humid areas, the surface to volume factor should be bigger. This also favours a higher ventilation rate.**

### **3.1.3.3 Type and form of buildings**

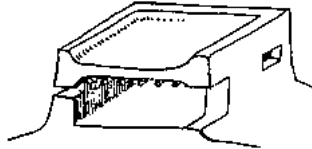
**The suitable form of buildings differs very much between the main climatic zones. Traditional regional dwelling types illustrate this clearly.**

**a) The compact, inward oriented house of the hot-arid zone (see Chapter 3.2.3).**

**Massive wall and roof structures even out the indoor climate in conditions of hot days and cold nights. The surface is kept at a minimum compared to the volume so that the exchange of heat and cold is minimized. Ventilation should be controlled: minimized**

**during the heat and increased during periods when the outdoor temperature is at comfort level.**

**Such types are generally appropriate in areas with large temperature differences between day and night.**

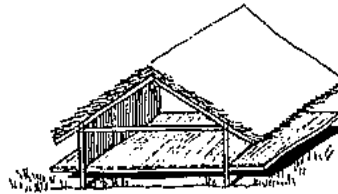


**Fig 3/23 Typical house of the hot-arid zone**

**b) The open, outward oriented, detached, built on stilts house of the warm-humid zone (see Chapter 3.3.3)**

**The surface is large compared to the volume and therefore the exchange of heat energy high. As a consequence the indoor temperature approaches the outdoor temperature. The walls are light and maximum ventilation can easily be achieved. Large overhanging roofs are the main important element.**

**This type is appropriate in zones with even day and nighttime temperatures.**



**Fig 3/24 Typical house of the warm-humid zone**

**c) A compromise between the two extremes is the house of the temperate zone.  
(see Chapter 3.4.3)**

**It is composed of shading roofs as well as protective walls which are less massive than in a) above.**

**The windows are of medium size, providing good ventilation and moderate solar heat gain.**



**Fig 3/25 Typical house of the temperate zone**

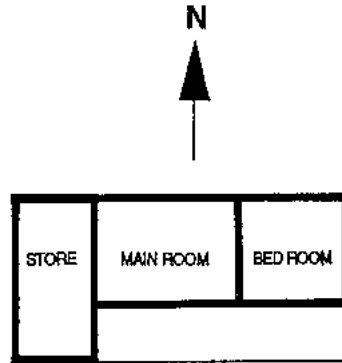
### **Room arrangements**

**When designing the floor plan of a building, apart from the functional arrangements, room connections and privacy requirements, the following aspects should be considered:**

- At what time of the day will the room be used ?**
- Is the room of prime importance or is it an auxiliary space ?**

**Important rooms should be located at places with climatic advantages. For instance, in hot climates a bedroom is preferably located on the east side where it is relatively cool in the evening, whereas the living room is placed on the northern side. Auxiliary spaces should be located on the disadvantaged sides, mainly west.**

**Rooms with high internal heat load, such as kitchens, should be detached from the main rooms.**



**Fig 3/26 Typical room arrangement**

### **Minimize internal heat gain**

**Internal heat gains, in the form of heat output from human bodies, equipment, cooking and lighting (often referred to as "wild heat"), can present quite a problem and should be minimized in hot seasons. In cool seasons it can be welcome as a heating source.**

**It is not possible to avoid these heat sources, but one aspect for reducing the indoor temperature in buildings is to minimize their quantity as well as their impact on the main rooms. This involves technical measures and also has consequences with regard to the room arrangements.**

#### **a) Heat gains from human bodies**

**As far as is possible, the number of people living in a house should be reduced. To provide more space is, of course, very much an economical question.**

**To avoid overcrowded indoor areas the outdoor space should be designed in such a way**

**that as much activity as possible can take place there.**

### **b) Lighting**

**Daylight provision should be adjusted to the necessary level only, not too excessive and diffuse rather than direct.**

**Where artificial lighting is needed, high efficiency light sources should be used which produce less heat.**

**Unnecessary lighting should be avoided and background lighting should be of low level.**

### **c) Equipment**

**In hot seasons heat producing equipment should be placed remotely, away from occupants.**

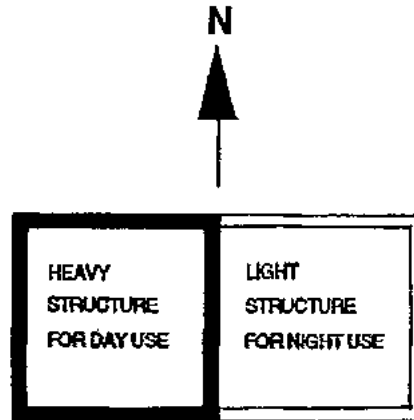
**When placing such equipment, the prevailing air movement should be considered. It should be placed on the lee-side of the main rooms, if possible in a separately ventilated, detached room.**

**A high ventilation around heat-producing equipment may be required.**

**Separate zones for day and night, summer and winter**

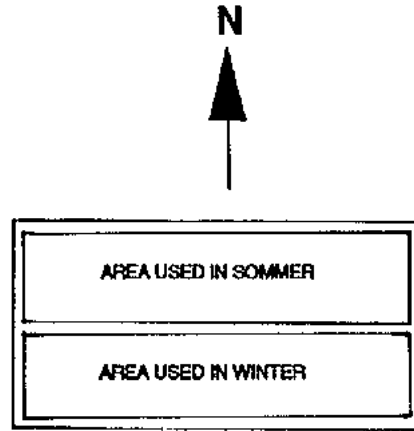
**Separate day and night zones may be provided in the house. The day zone would be a heavy structure retaining the coolness of the night and oriented towards west. The night zone would be a light structure which cools down quickly after sunset and is oriented towards east.**





**Fig 3/27 Use of heavy and light building parts as day and night space**

**Similarly, variation in living spaces used in summer time or in winter time could be provided - a concept which is feasible mainly in temperate zones.  
(see Chapter 3.4.3.3)**



**Fig 3/28 Orientation of space used in summer or winter**

### **3.1.3.4 Immediate external space**

**In tropical and subtropical regions the outdoor space is actively used. A major part of the social life and the daily routine work takes place there.**

**Depending on the climatic conditions, various forms of courtyards, protected niches and alcoves are common. Such elements should be carefully designed.**

#### **Vegetation**

**Trees and other plants are important elements of immediate outdoor spaces. They are inexpensive elements which regulate and improve the climate. At the same time they add to the attractiveness of this space.**

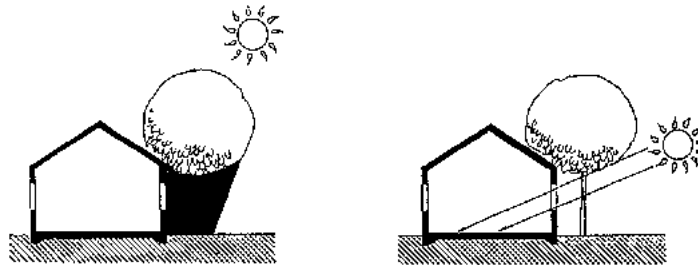
**When planting trees, some basic rules should be kept in mind:**

**a) Basically, the same considerations for designing shading devices are also applicable to trees:**

- **At what time of the day and at what seasons of the year is shade desired ?**
- **What is the sun's path?**

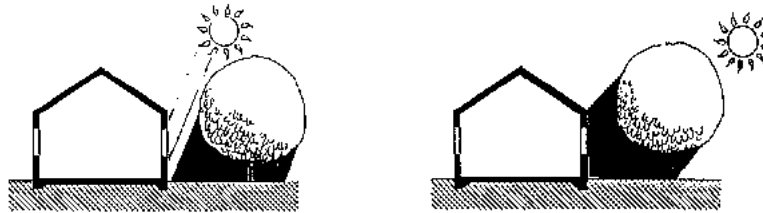
**b) A tree planted close to the building, even with the crown covering the roof, provides the best protection from the intense midday sun, but allows access to the sun in evening hours, when in certain situations this is welcome.**

**Deciduous trees allow enough heat gain for passive heating and daylight during the winter season.**



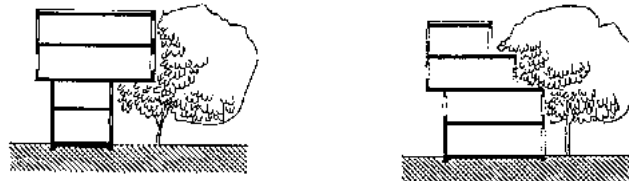
**Fig 3/29 Tree close to a building**

**c) A tree planted within a certain distance of a building provides shade only during evening or morning hours, but not at midday, the hottest time.**



**Fig 3/30 Tree far from a building**

**d) Planting a tree close to a building does not necessarily harm it. While growing, trees always adapt their shape according to the nearby building form. Certain constant observations and maintenance measures are however necessary. These include some trimming and removal of branches which are likely to break off.**



**Fig 3/31 Tree adapting to the form of a building**

### **3.1.4 Building components (Technical data see Appendix 5.1 )**

#### **The main points**

- **Heat storage and time lag, which provide a balanced indoor climate and take advantage of outdoor temperature fluctuations.**

- **Thermal insulation, which prevent undesired heat gain, but do not impede emission of surplus heat.**
- **Reflectivity, absorption and emissivity, which regulate the radiation from and to the sky and the surroundings.**

**All building components should work together as a balanced system to create a comfortable indoor climate.**

**The appropriate design of floors, walls, roofs and openings varies greatly with different climatic zones. Solutions cannot therefore be generalised and have to be worked out according to the individual situation as well as to basic physical principles.**

**In the following section, the main characteristics of heat storage, time lag, thermal insulation and reflectivity are discussed, their influence on the indoor climate explained.**

**The most commonly used building materials and details are listed and then their main properties and suitability described.**

**3.1.4.0 The principles of heat storage; time lag; thermal insulation; reflectivity, absorption and emissivity; and condensation  
(also see Chapter 2.4)**

**Heat storage and time lag (see table in Appendix .5.1 )**

**The capacity of building components to store heat and to release it later has an important regulating effect on the indoor climate. A high internal mass reduces the indoor temperature swing. During the daytime it is thus cooler and at night warmer than outdoors.**

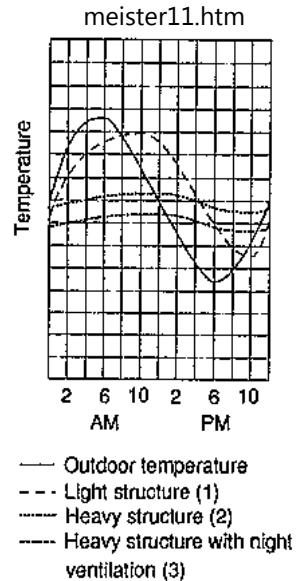
**The main performance range is shown in Fig 3/32.**

**The indoor temperature of a light structure (1) is similar to the outdoor temperature ( $T_o$ ) with a slight time lag. Without proper reflection of the solar radiation this temperature can also rise far above the outdoor temperature.**

**The indoor temperature of a heavy structure (2) remains near the average outdoor temperature, with a longer time lag.**

**The temperature can be considerably lowered during the day by combining a heavy structure with proper night ventilation (3).**

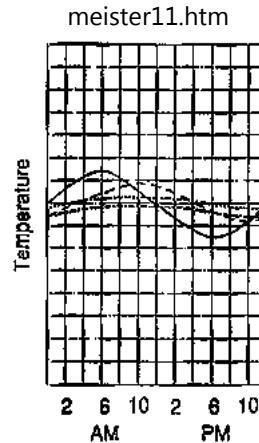
**The effect of heat storage and time lag in conditions of a wide diurnal temperature range can clearly be seen in Fig 3/32.**



**Fig 3/32 Wide diurnal temperature range**

**This effect can be ignored in conditions with a narrow diurnal temperature range as illustrated in Fig 3/33.**

**Hence, heat storage is only valuable in climates where the diurnal temperature range is wide and falls below comfort level at night. In this situation one likes to get rid of surplus heat - or part of it - during the day; on the other hand, this heat may be welcome in the evening or during the night.**



**Fig 3/33 Narrow diurnal temperature range**

### **Active heat storage capacity**

**The amount of heat stored depends on the effective thermal storage capacity. The entire building mass cannot be activated to store heat.**

- **Outer walls and roof:**

**If thermal insulation is used, only the mass inside of the insulation is active in storage.**

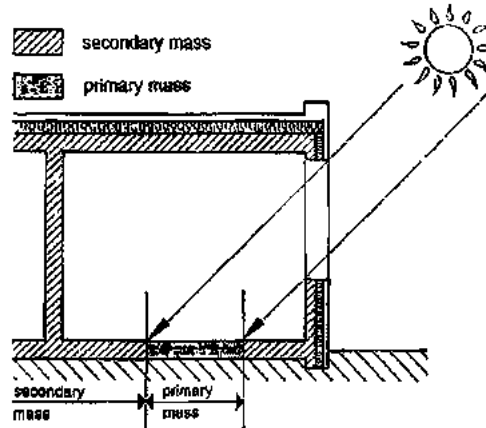
- **Internal materials:**

**The amount that can be used depends on the extent of the active heat storage capacity. For areas exposed to direct solar radiation (primary mass) this is 15-25 cm and for areas not exposed to direct solar radiation (secondary mass) this is 8-10 cm.**

**The primary mass is much more effective than the secondary mass with regard to active**



## heat storage capacity.



**Fig 3/34 Primary and secondary masses**

The time lag determines when maximum heat is emitted (see Chapter 2.4). According to the function of a building or room, the components can be designed to achieve the desired effect.

Storing heat over periods longer than a couple of days is only possible with special storage elements, e.g. large, well-insulated watertanks.

### Comparison of heat storage requirement

Hot-arid	Warm-humid	Temperate
A large thermal mass with high heat storage capacity is desired in	Because the narrow diurnal temperature range does not	A compromise between conflicting requirements is

<p>most cases in order to keep houses cool in daytime and to achieve a comfortable night temperature, despite severe outdoor temperatures.</p> <p>In periods or seasons when the outdoor night temperature does not fall below comfort level, the heat released by the building mass has to be expelled by ventilation.</p>	<p>usually fall below comfort level, heat storage capacity should be avoided, at least for rooms also used at night. For rooms used in daytime only a certain storage capacity can be an advantage. In this way the indoor temperature can be reduced by a few degrees.</p>	<p>necessary. Too little storage capacity results in overheating in summer, too great a storage capacity makes the building unheatable in winter.</p>
---	---	---

**The time between peak temperature being reached on the outer surface and the same on the inner surface is called the time lag. This is important where internal heat gain is desired later in the evening.**

**For passive heating, the building shell has ideally a time lag covering the hours between the greatest heat gain outside and the desired heat gain inside**

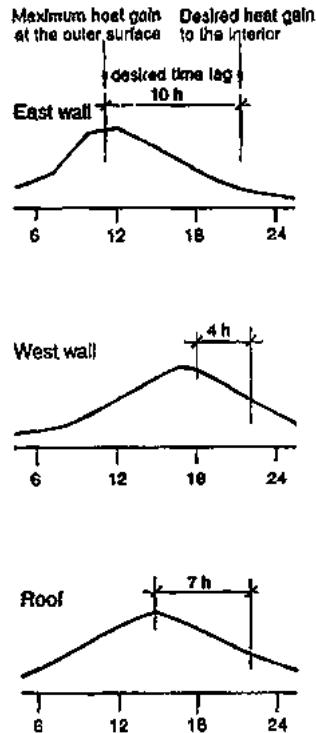
**Estimating the required time lag:**

**Depending on the orientation of a surface, the hours of maximum heat gain (radiation) varies. In addition, the time at which heat emission to the interior is desired or does not cause any disturbance, varies as well. As a consequence, the ideal time can also vary. See diagram (Fig 3/35)**

**Examples**

- **An office space that does not require any heat gain, would best be designed as a structure with a time lag which takes effect after office hours only.**

- A living or sleeping space should be designed with a time lag which takes effect when the outdoor temperature drops below comfort level.



**Fig 3/35 The outer surface temperature and the desired time lag**

**In cases where cooling during the daytime is desired, the principle can be reversed. The**

**desired time lag would be defined as the time between the period of maximum heat loss to the night sky and the period of desired internal cooling.**

**In areas where the outdoor temperature does not fall below the level of comfort or where the diurnal change is minimal, the time lag is not relevant. Here, reflective insulation, shading and ventilation are the main instruments for controlling the indoor climate.**

**Thermal insulation  
(see table in Appendix 5.1 )**

**In the case of a temperature difference, heat energy always travels from hot to cold. Thermal insulation reduces such heat transfer. As a consequence, it reduces daytime surplus heat entering a building, but prevents the building from cooling down at night. In general, this dual function makes insulation unsuitable for naturally-climatized buildings.**

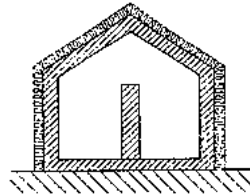
**In the theoretical case of a highly insulated structure with no heat storage capacity, the indoor temperature would always be exactly the same as the outdoor temperature, because the minimum ventilation which is always required would bring in the air which is at the outdoor temperature.**

**In some cases a partial thermal insulation is nevertheless appropriate; for example in roof structures where, due to solar radiation, extreme daytime heat occurs.**

**The thermal insulation capacity of a structure is indicated with the U-value (see Chapter 2.4).**

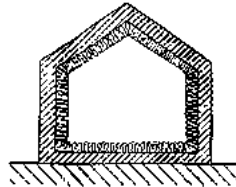
**Thermal insulation and storage mass**

**If thermal insulation is used in combination with heat storing materials, this storage mass must be on the inside, e.g. in a massive shell construction, or in the internal walls or floor**

**slabs.**

**Fig 3/36 Storage mass on the inside of the insulation is effective**

**If insulation separates the storage mass from the interior, its effect is lost.**



**Fig 3/37 Storage mass outside of the insulation it is not effective.**

**A building with thermal insulation and sufficient internal heat storage mass can be suitable, provided that a very reliable and efficient ventilation at night removes the daytime surplus heat.**

**Thermal insulation and active cooling or heating**

**In cases of active cooling or heating thermal insulation has clear advantages and is often indispensable. It reduces the heat load considerably.**

**To avoid damp condensation, care has to be taken in placing insulation in relation to the**

**damp-proof material (plastic, metal, aluminium foil etc.). In this case the damp-proof material has always to be on the warm side of the insulation.**

**Reflectivity, absorptivity and emissivity  
(see data in Appendix 5.1 )**

**Much of the heat received by a building is through radiation, mainly solar radiation. The treatment of the outer surface is therefore important.**

**The quantity of radiant heat a surface receives depends not only on the sun angle, but to a large extent on the properties of reflectivity and absorbance.**

**Heat emission at night is also important. It takes place only towards cooler surfaces, that is, mainly, towards the clear night sky. There is no radiant heat emission towards other buildings and surfaces that have the same surface temperature.**

**(see Chapter 2.4 )**

**Therefore, the main properties to be considered for constructions and materials are:**

- **Reflection of radiant heat**
  - **Absorption of radiant heat**
  - **Re-emission of stored heat**
- (see data in Appendix 5.1 )**

**Reflection of radiant heat**

**Where heat gain is not desired, a reflective surface, e.g. white or bright metallic, is appropriate. Lightweight constructions should always possess such surfaces. Dull surfaces such as older galvanized iron sheeting are poor in this respect.**

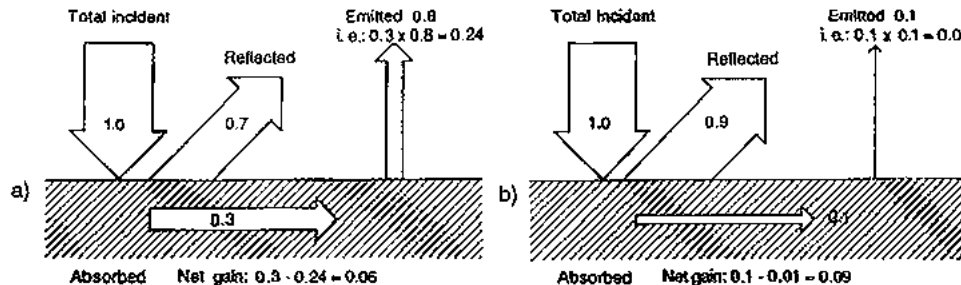
## Absorption of radiant heat

Where heat gain for nighttime is desired, absorbent surfaces, which are generally darker and non-shiny are preferred. Such surfaces should only be used for buildings with a high thermal capacity. Buildings with a low thermal capacity would immediately overheat.

Where radiant heat loss is possible, for example to the sky, a white surface allows less net gain. Where opposing surfaces are warm, there is no radiant loss, and aluminium is preferred.

## Re-emission of stored heat

Where a re-emission of stored heat to the environment and the sky at nighttime is desired, surfaces should preferably be of a porous nature. Plaster and brick surfaces are more efficient than metallic surfaces. The degree of brightness (color) is not of relevance.



**Fig 3/38 Reflection, absorption, emissivity of white metal surfaces (a) and bright aluminium (b) [ 8-]**

With regard to reflectivity, the property of the roof surface is of the greatest importance because it receives a far greater amount of radiant heat than any vertical surface, and can

**also re-emit more than other surfaces. Hence, it has to be carefully selected. If an absorbent surface is used, the time lag should usually be at least 8 hours. Lightweight roofs should have reflective surfaces combined with thermal insulation or a ventilated ceiling.**

**When selecting the building materials, their thermal properties should be analysed so that materials suitable to the local climatic conditions can be chosen. When considering exposure to solar radiation, the solar heatgain factor (SHF) is an important criterion to be taken into account, especially in the case of the roof. It is more important than the U-value.**

**Appendix 5.1 contains tables with the most important thermal properties of typical wall and roof constructions.**

### **Surface condensation**

**When the inner surface of the building shell cools down far below the indoor air temperature at night, then condensation may occur. This is often the case with single metal sheeting and can be countered by a properly ventilated double shell construction.**

### **Mould**

**A secondary problem with condensation may arise when the inside surfaces of a building remain cool and warm and relatively humid air enters. This may cause condensation and mould growth, which must be countered by additional ventilation.**

**Further information see [ 2, 4, 8, 10, 11, 162 ]**

**3.1.4.1 Foundations, basements and floors  
(also see Chapter 3.2.4.1, 3.3.4.1, 3.4.4.1)**



**Basements and floors generally have a large thermal storage capacity and can therefore act as a climate regulating element. It depends on the specific climatic conditions, whether these properties are an advantage or whether the rooms have to be insulated against it.**

Common building materials, properties and suitability	Solid floor, concrete, stone burnt clay bricks and tiles, earth	Good materials for heat storage; help to balance indoor temperature. Suitable for hot zones with large diurnal temperature differences. Less suitable for warm-humid climates except for daytime rooms.
	Multilayer floor with insulation materials	Suitable for upland climates.
	Single planking timber floor, ground detached	Suitable for warm-humid climate, for comfort at nighttime.

### **3.1.4.2 Walls**

**(also see Chapter 3.2.4.2, 3.3.4.2, 3.4.4.2)**

**Design:**

**Walls (exterior and interior) can have several functions:**

**Beside being a structural element, they provide protection from heat, precipitation, wind, dust and light and serve as a means of space definition and partition. The properties should therefore be selected according to the main functions of a wall.**

### **COMMON BUILDING MATERIALS FOR WALLS, PROPERTIES AND SUITABILITY**

## **SOLID WALLS EARTH, STONE, BRICK**

**Good materials in hot-arid zones, combined with few openings and light colored outer surface. Takes best advantages of time lag, with heat emission at night. In warm-humid zones only useful for daytime rooms.**

## **BURNT CLAY BRICKS**

**Good thermal resistance, depending on the porosity. Medium to high heat storage capacity, good humidity regulating property.**

## **UNBURNT CLAY BRICKS**

**Better thermal resistance and humidity regulating property than burnt bricks. Less resistant to mechanical stress. Needs protection from driving rain and rising moisture. Improved products with low cement content are somewhat less vulnerable.**

## **SOLID CONCRETE BLOCKS**

**Poor thermal resistance and high heat storage capacity.**

## **HOLLOW CONCRETE BLOCKS**

**Less heat storage capacity than solid blocks but improved insulation, thus better suited for temperate climate.**

## **FERROCEMENT**

**Has similar properties to concrete, but less thermal storage capacity due to the reduced thickness; suitable for warm-humid zones.**

## **TIMBER**

**Good thermal resistance, high heat storage capacity, good regulation of humidity.**

## **MATTING OF BAMBOO, GRASS, LEAVES**

**Good material in warm-humid zones, with no thermal storage capacity, not airtight and thus allowing proper ventilation.**

## **INSULATION MATERIALS**

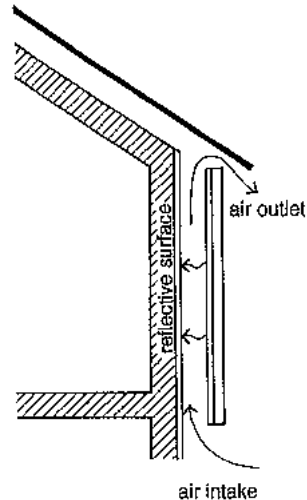
**Various natural and artificial materials are available and have to be selected carefully. They prevent not only heat gain, but also heat loss. The danger of overheating at night has to be considered as well.**

## **WHITE-WASHED SURFACES**

**Simple and low cost, yet effective method for making a surface highly reflective. The emission at night remains high.**

## **CAVITY WALLS**

**Has many advantages, especially in hot-arid zones. Reflective surface in the cavity (e.g. aluminium foil) reduces radiant heat transfer. Ventilation of the cavity takes the heat away and reduces conductive heat transmission to the interior.**

**Fig 3/39**

**Light weight walls, traditional matting, frame construction with thin infill panels**  
**Indoor and outdoor temperatures remain much the same, provided the walls are shaded.**  
**If unshaded, indoor temperature rises quickly above outdoor temperature.**  
**Suitable for warm-humid climate, taking full advantage of cooler night temperature.**  
**Suitable in hot-arid regions for rooms used at night only, where the outdoor temperature does not fall considerably below comfort level.**

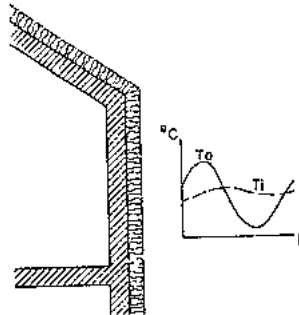
### **Heat insulated light weight wall**

**Mainly used for air conditioned rooms, especially if exposed to direct solar radiation.**

### **Multilayered construction**

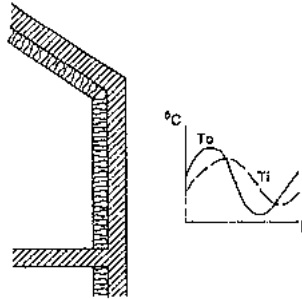
**The application of multilayered construction is in many cases an economic question. Where the resources are available, it can be used; however, a careful assessment of its thermal performance is needed.**

**Placing a lightweight insulating material on the outside of a massive wall or roof will give a time lag and decrement factor greater than that of the massive wall alone. On the other hand it prevents heat dissipation to the outside at night, thus making internal ventilation imperative.**



**Fig 3/40 Insulation outside: night ventilation is important**

**Placing insulation on the inside will result in an indoor climate performance similar to the one in a lightweight structure with a highly reflective outer skin, because the balancing effect of the thermal mass of the outer wall is cut off.**

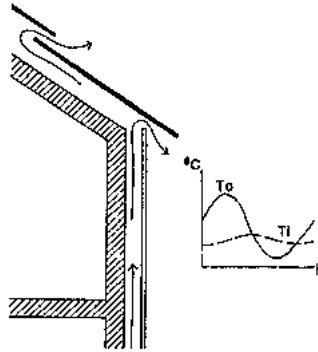


**Fig 3/41 Insulation inside: high indoor temperature during the daytime if not mechanically cooled**

**The time lag is thus minimal and the indoor temperature is always close to the outside temperature.**

**Such inside insulation can be appropriate in actively cooled or heated buildings.**

**A ventilated and reflective outer skin is an efficient, although expensive solution, to reduce radiant daytime heat. Heat dissipation at night is more efficient than with a structure using outside insulation.**



**Fig 3/42 Ventilated and reflective outer skin with heavy inner structure**

**One way of reducing the radiant heat transfer between the two skins is the use of a low emission surface on the inside of the outer skin (e.g. aluminium painted white on the outside but left bright on the inside) and a highly reflective surface on top of the ceiling. Bright aluminium foil can be used to advantage in both situations.**

### **3.1.4.3 Openings and windows**

**Design (also see Chapter 3.1.5.2, 3.2.4.3, 3.3.4.3, 3.4.4.3)**

#### **Design**

**The design of the openings is greatly influenced by the prevailing climate. In general it can be said that**

- in hot-arid zones, openings should be of minimal size or adjustable in size by shutters, and the view not directed towards the ground (glare) as far as considerations of natural lighting permits. The seasonal difference of the sun angle should be taken into account.**

**Airtight closing should be possible.**

- **in warm-humid zones, openings should be as large as possible, and the view directed to surrounding grass or trees, with the sky blocked by roof overhangs or sun breakers. Air circulation should not be blocked by vegetation. An airtight construction is not needed.**

**Outlet openings should be located at high levels, where hot air accumulates.**

**Bedroom windows are best placed at the height of the bed or pivoted to direct the airflow towards the sleeping body. Louvres are a suitable accessory to assist the channeling of airflow. (also see Chapter 3.1.5.2)**

**Common building material for windows, properties and suitability**

**Window glass:**

**A wide range of special heat-absorbing and heat-reflecting glass types is on the market, but they are generally only suitable for air-conditioned buildings. Most of them are limited in their effectiveness because either their own temperature is raised, which increases the heat convected and re-radiated into the internal space, or they tend to reduce light rather than heat. In addition, availability and costs have to be considered.**

**Sealed double-glazed window panes can only be used for air-conditioned buildings. They are expensive and difficult to replace. In naturally cooled buildings they have little advantages.**

#### **3.1.4.4 Roofs**

**(also see Chapter 3.2.4.4, 3.3.4.4, 3.4.4.4)**

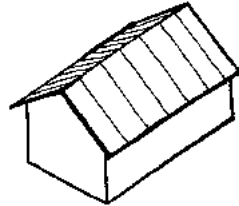
**Design**



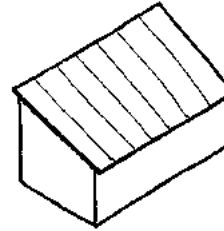
**The most important element is the roof because the strongest thermal impacts of heat loss and heat gain occur here. The roof is the part of the building receiving most of the solar radiation, and its shading is difficult. Therefore, this building part should be planned and constructed with special care. Naturally, this applies to single story buildings and to for the top floor of buildings only.**

**The thermal performance depends to a great extent on the shape of the roof and the construction of its skin, whereas the carrying structure has little influence.**

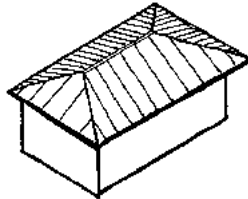
**The shape of the roof should be in accordance with precipitation, solar impact and utilisation pattern (pitched, flat, vaulted, etc.)**



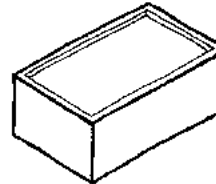
Double-pitched roof



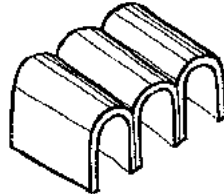
Mono-pitched roof



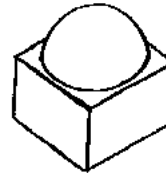
Hipped roof



Flat roof



Vault



Dome

**Fig 3/43 Basic roof types**

## **COMMON ROOFING MATERIALS, PROPERTIES AND SUITABILITY**

### **Earth**

**Good thermal insulation and emissivity, suitable in dry climates.**

### **BURNT CLAY TILES**

**A traditional material still very suitable today, with rather good thermal properties. Relatively heavy, requiring a strong support structure; medium heat storage capacity. Are permeable to air through the gaps between the tiles.**

### **CONCRETE TILES**

**Similar properties as clay tiles but somewhat reduced heat resistance.**

### **FIBRE CONCRETE (FCR) AND MICRO CONCRETE (MCR) TILES**

**Similar properties but lighter than concrete tiles, hence less heat storage capacity.**

### **ASBESTOS SHEET**

**Fairly good thermal performance, medium reflectivity. Disadvantages: low mechanical strength, asbestos fibre is harmful to health (carcinogenic).**

### **MONOLITHIC CONCRETE SLAB**

**Poor thermal resistance and high storage capacity. Due to the big mass relatively cool during the morning, but re-radiating the daytime heat to the interior in the evening and at night.**

### **NATURAL STONE (FLAG STONE, SLATE)**

**Thermal performance similar to concrete tiles depending on the thickness and the surface (brightness).**

## **ORGANIC, VEGETAL ROOFING MATERIALS BAMBOO, LEAVES, THATCH, WOODEN SHINGLES**

**Climatically suitable, but of relatively low durability. Applicable for semi-permanent and self-built houses.**

## **BITUMINOUS ROOFING**

**Problematic in the tropics, quick deterioration due to the intense solar radiation.**

**INSULATION MATERIALS see Chapter 3.1.4.2**

## **SINGLE SKIN CORRUGATED GALVANIZED IRON SHEETING (CGI)**

**One of the most widely used, simple constructions, of low weight allowing an economical support structure. Has no significant thermal resistance, aged sheeting has no significant reflectivity, reradiates the received solar radiation into the building creating intolerably high indoor temperatures during the daytime. Rapid cooling at night with the problem of condensation in humid climates. Low life-span, noisy during rain.**

## **ALUMINIUM SHEETING**

**A fairly expensive material but with good thermal reflectivity and long life span, preferable to galvanized iron sheeting. Reduces the heat load due to the low heat storage capacity and high reflectivity.**

## **CONSTRUCTION DETAILS**

### **THIN SINGLE SKIN ROOF**

**Solar heat transmittance and heat conductance is high.**

## **INSULATED ROOFS IN GENERAL**

**Prevent heat entering through the roof but also prevent heat escaping at night, thus their use has to be carefully considered.**

### **INSULATION ABOVE A MASSIVE ROOF**

**The time lag is four times longer than with insulation placed inside, but also prevents cooling at night.**

### **INSULATION BELOW A MASSIVE ROOF**

**Allows excessive heat storage, for which the insulation can hardly compensate. The slab exposed to the sun receives very high temperature differences that may be harmful to the structure.**

### **CONCRETE SLAB WITH SCREED AND FIBRE BOARD CEILING**

**Resistance to heat flow is insufficient. Only useful for rooms used in daytime, not in the evening and at night.**

### **DOUBLE SKIN ROOF WITH TWO LIGHT LAYERS**

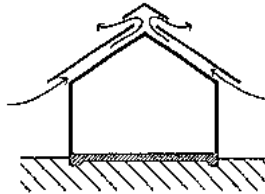
**The outer skin shades the inner layer and reflects as much solar radiation as possible. The accumulated heat between the two skins must be removed by ventilation. Suitable in warm-humid climate, reduces the heat load in daytime and allows quick cooling at night.**

### **DOUBLE SKIN ROOF WITH A LIGHT OUTER SKIN AND A HEAVY INNER LAYER WITH REFLECTIVE SURFACE**

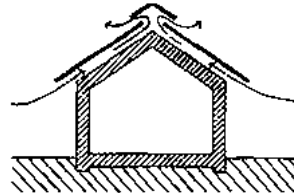
**Suitable for hot-arid zones, keeping the indoor night temperature at a higher level than**

**the outdoor temperature. A reflective surface in the cavity (e.g. aluminium foil) reduces the radiant heat transfer. Ventilation between the two layers must take the heat away. (see also Chapter 3.1.4.2). A separate roof and ceiling is the obvious solution for warm-humid climates. If for some reason it is used in hot-dry regions, the roof should be light and the ceiling massive. (also see Chapter 3.2.4.4 and 3.3.4.4)**

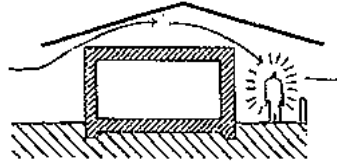
**Air which has passed through a double roof space and can reach the living zone (e.g. discharged towards a verandah) should be avoided, as this air will be much hotter than the normal outdoor air.**



**Fig. 3/44**



**Fig. 3/45**

**Fig. 3/46**

### **3.1.5 Special topics (Passive cooling and heating)**

**Principles for the design and construction of special devices for passive cooling and heating, such as shading, natural ventilation, evaporative cooling, energy storage and temperature exchange between day and night, are described in this section and under the separate chapters on climate.**

#### **3.1.5.1 Shading devices**

**A major part of the heat a building gains is through solar radiation. This radiation is experienced in the form of increased air temperature, radiant heat and glare. Adequate shading reduces these effects drastically.**

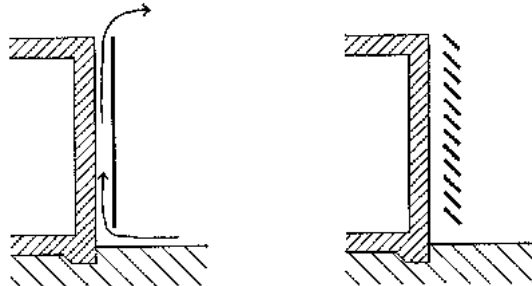
**In certain climates a limited radiant solar heat gain may be welcome. It is possible to allow for this by a differentiated shading concept.**

**The following considerations provide the basis for the shading concept:**

- At what time of the year and day is solar heat gain desired; when is it not ?**
- What is the geometry of the sun's path in relation to the building and its facades, and what is its change with the seasons ? (see Chapter 2.2 and Appendix 5.3 )**

- **What is the quality of solar radiation: is it strong or weak, direct or diffuse ?**

**Depending on the type of climate shading should cover openings either fully or partly. But under extreme conditions it should cover wall surfaces as well. This is possible with fins covering the entire wall or with double shell construction.**



**Fig 3/47 Shading of the entire wall surface**

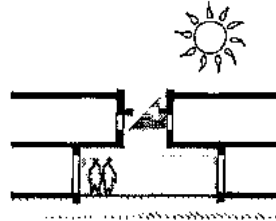
**Shading can be provided by means of building shape, double shell construction, shading devices as attached accessories, facade greenery and roof gardens.**

### **Building shape**

**Shade can be provided by the shape of the building itself; for instance, by cantilevered upper floors or arcades.**

**In hot arid climates, shading can also be provided by placing buildings closely together, where other factors (traffic, hygiene, daylight) allow it.**





**Fig 3/48 Shading by building shape**

### **Double shell construction**

**A double shell construction should have reflective properties protecting the building from direct and diffuse radiation. The outer skin should be placed fairly close to the facade and be properly ventilated. Such methods are suitable mainly for warm-humid climates.**

### **Shading devices as attached accessories**

**A common means of shading is the use of shading devices placed outside the facades. The sun's path is the main criterion for its design. Therefore, each facade has to be planned separately. (also see Chapter 3.1.3.3)**

**When designing a shading device, various factors beside the sun's path have to be considered. The shading effect depends not only on the geometrical shape and orientation of the fixtures, but also on the material used and on the surface treatment and color.**

**The ratio of influence can be estimated as follows :**

• geometry, shape, orientation	70%
• material properties	15%
• surface treatment. color	15%

## Efficiency

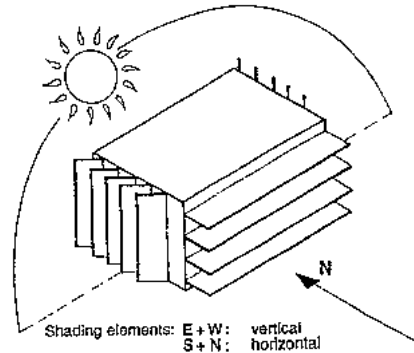
**The efficiency of different measures can be roughly estimated and compared with the following chart, indicating the transmitted radiation impact:**

• regular glass	1
• internal venetian blind, white	0.5
• internal venetian blind, dark	0.75
• external venetian blind, white	0.15
• continuous overhang on south side	0.25
• external movable louvres	0.15

## Geometry and form

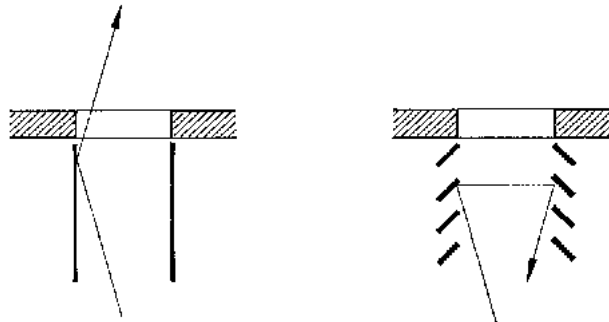
**In general, shading elements on east and west facades should be vertical, because the sun is low.**

**On south and north facades the shading elements should be horizontal. Here, shading can often be provided simply by roof overhangs.**



**Fig 3/49**

**The shape of the elements should prevent radiation being reflected directly through the openings.**



**Fig 3/50**

### **Types of shading devices**

**The variety of shading methods is large and the designer has the choice of many options.**

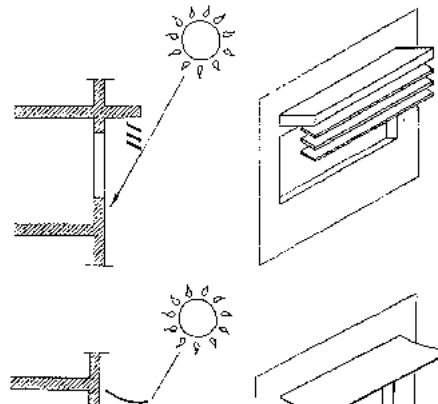
**When selecting the type of shading device, apart from shading, other factors should also be considered :**

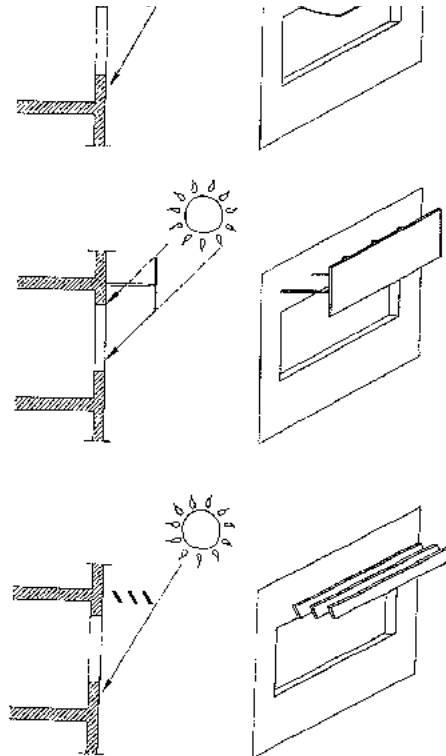
- **The airflow through the openings should be reduced the least possible, never stopped completely.**
- **The view should not be obstructed.**
- **Daylight should not be reduced too much.**

**Elements attached to the building are:**

**a) Horizontal screening .**

**This is very efficient against high midday sun, especially on north and south facades. It can take the form of a roof overhang, a slab projection and verandahs, or with fixed or adjustable louvres.**



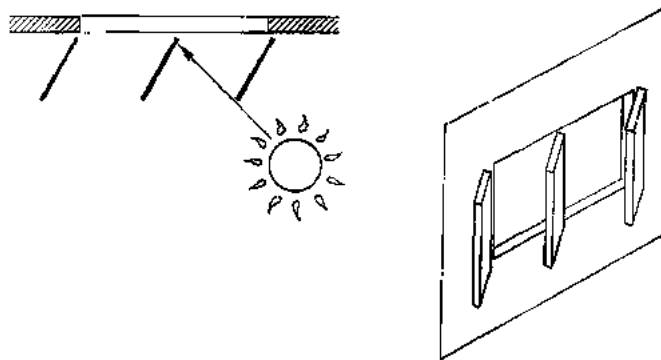


**Fig 3/51 Horizontal screening**

### **b) Vertical screening**

**Such elements are best against low sun, thus on east and west facades. Optimal efficiency can be obtained with movable elements. A simple form of vertical screening can also be**

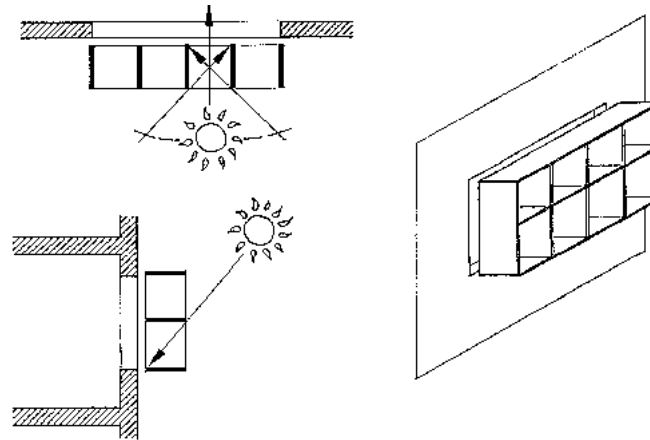
**achieved with window shutters and doors.**



**Fig 3/52 Vertical screening**

### **c) Egg-crate types**

**A combination of vertical and horizontal elements may be used where only horizontal or vertical protection alone would not provide shade. It may be required on east to southeast and on west to southwest oriented surfaces. It could be made of precast concrete or brick elements, timber or other similar material.**



**Fig 3/53 Egg-crate types**

#### **d) Screening, curtains**

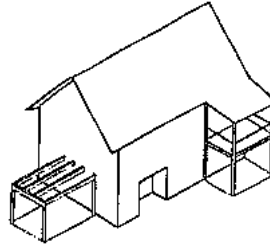
**Traditional wooden trellis-work (mashrabiya) or similar elements, e.g. bamboo screens, provide protection against sun as well as glare.**

**Curtains of any flexible material can easily be fixed in any door or window opening.**

#### **e) Pergolas, balconies, loggias, porches, arcades**

**A pergola can be made of bamboo or wooden components. The horizontal screening can be overgrown with creeping vegetation for better shading. Balconies and loggias as architectural elements can be helpful in providing shade.**

**When covering large horizontal areas, such elements are also a very efficient protection for roof surfaces.**

**Fig 3/54**

### **Materials for shading devices**

**Generally the use of materials with a low thermal capacity is recommended for shading devices near openings, thus ensuring that they cool quickly after sunset.**

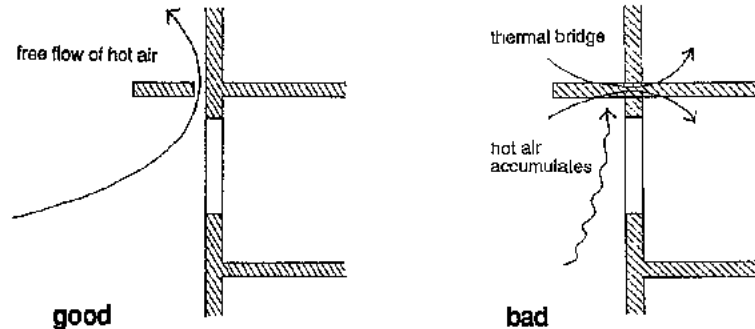
**Materials that do not overheat should be used.**

### **Guidelines for detail design**

- **Screening should generally be placed on the outside of a building. If inside the glass, it provides only protection against glare.**
- **Horizontal shading elements should be detached from the facade, so that rising warm air is not prevented from escaping. A gap of 10 to 20 cm should be maintained between the horizontal screen and the facade.**
- **Thermal bridges between the building structure and shading elements should be kept to a minimum. Shading elements, when exposed to intense solar radiation, heat up. Through massive connections to the building the heat can flow to the inside and cause a considerable heat gain in the interior. Therefore, the fixing points should be kept to the**



**minimum required for structural reasons.**



**Fig 3/55 Elimination of thermal bridges**

- **Adjustable shading devices can balance seasonal differences.**

### **Solar control glass**

**Solar control glass can reduce direct radiation but cannot offer complete protection. If the windows cannot be opened, air conditioning is unavoidable. Furthermore, such glass is expensive, its life span uncertain and it is difficult to replace.**

### **Facade greenery (for shading with trees see Chapter 3.1.2)**

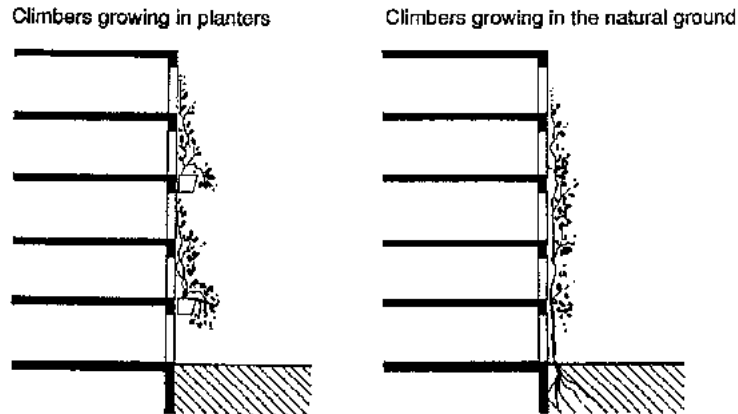
**A green cover on the facade shades the wall surface and thus reduces solar radiant heat gain. It also protects the walls from heavy winds and driving rain.**

**Facade greenery can be planted on the ground adjoining walls or, in higher buildings, in plant boxes on terraces or hung onto the facades.**

**To give protection from certain insects that may be attracted to the greenery, it is recommended that mosquito-screens are used in the openings.**

**It will often be necessary to water the plants, which may be a problem in areas with limited water supply.**

**Plants with aggressive roots should be used with care, as they may harm the structure.**



**Fig 3/56 Facade greenery: two possible approaches**

### **Roof gardens**

**Plantation on roofs which are flat or have a slight slope, has a strong regulating effect on the indoor temperature due to the heavy earth coverage and the shading effect:**

- **Solar radiant heat gain is drastically reduced**
- **The ceiling temperature is fairly even throughout day and night.**

- **The temperature of the roof slab also remains stable, and the thermal stress on the structure is reduced.**
- **Further advantages are the aesthetic values, the reduction of dust and the improvement of the microclimate.**

**The disadvantages of roof gardens, however, also have to be considered:**

- **A heavy load is added on the roof structure.**
- **It is not easy to achieve a reliable waterproofing of the roof.**
- **Heat emission at night is reduced.**
- **Clogging of drainage channels and outlets may occur.**
- **In dry regions the high water consumption may cause difficulties.**

**For roof gardens, the following plants are recommended:**

**For 10 cm thick soil cover:**

**Wedelia trilobata, Syngonium spinosa, Setcreasea putzpurea, Cythyla, Hemigraphis spec., Pandanus spinosa, Rhoec spec., Rhoec tricolor.**

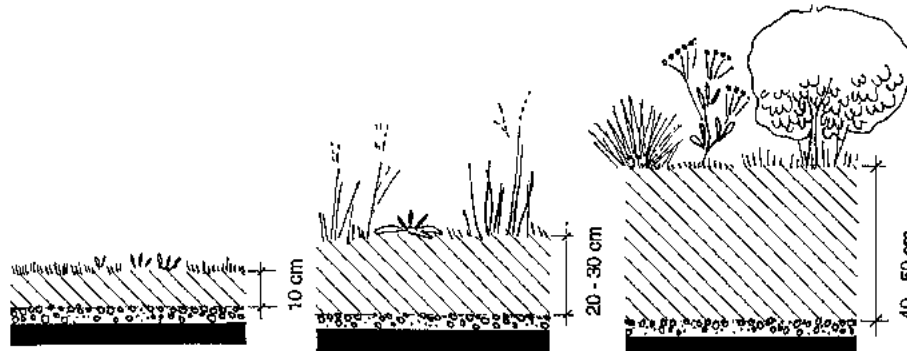
**For 20 - 30 cm thick soil cover:**

**Ipomoea Batatas, Ivora's, Sanchezia Nobilis, Stromanthis sanguinea, Strobilanthis dyerianus, Excocaris.**

**For 40 - 50 cm thick soil cover**

**Polyscia filicifolia, Hymenocallis spesiosa, Dieffenbachia marinne, Dieffenbachia tropic sun., Heliconia latispathia, Heliconia rostrata, Heliconia speciosa, Alpina purpurea, Alpina speciosa variegata, Alpina sanderae, Costus speciosus, Phaeomeria magnifica, Pandanus,**

**Akalyrha wilkesoniana, Cordiline speciosa, Wriqthia religiosa, Ravenala madagaskariensis.**



**Fig 3/57 Types of roof garden**

### 3.1.5.2 Natural ventilation

**Air movement is a major factor influencing indoor climate and should be considered when planning and constructing buildings. Similar to the sun's radiation, existing winds should also be incorporated in the design concept.**

**For planning purposes, it is important to distinguish between regular wind patterns and winds that occur only occasionally.**

**Occasional winds, such as in storms, have to be considered when designing the structure in order to guarantee sufficient strength. For the purpose of climatic design, only regular winds are relevant.**

### **Wind for cooling**

**Regular winds can be utilized for cooling. If the temperature of the circulating air is below the indoor temperature, then the cooling effect is obvious. But a breeze with a slightly higher temperature can also be felt as cool because it increases the perspiration of the skin. As soon as the temperature of the wind exceeds the temperature of the human body, such an effect is no longer possible.**

**To avoid discomfort caused by indoor ventilation, the speed of the air should not exceed a certain velocity. (see Chapter 2.3)**

### **Undesired cooling**

**In composite climates, wind can also cause undesired cooling when the outdoor air temperature is below the desired room temperature. In this case, the building should be built fairly airtight to minimize infiltration. Designing the surroundings with wind protection is also an effective measure to reduce such cooling.**

### **Sandy winds**

**Sand and dust driven by the wind can cause great problems, mainly in arid regions. Such winds can also cause erosion on facades and other exposed elements, requiring specially resistant building materials.**

**To prevent sand entering buildings and courtyards, suitable construction details and room arrangements are required.**

### **Air movement**

#### **Basic principles**

- **Hot air entering a building heats it up, cold air cools it down.**

- **Air circulation striking the human body provides evaporative cooling which at certain times and in certain circumstances is most welcome, at other times not.**

**As a consequence, the ventilation system of a building should be planned in order to optimize the indoor climate.**

**There are, however, limiting factors:**

- **Ventilation can only reduce temperatures higher than the outdoor temperature.**
- **The air circulation should not exceed a certain speed (ca. 1,5 m/s under warm-humid conditions) because this would create discomfort. (see Chapter 2.3.2)**
- **On the other hand, complete blocking of air ventilation is also not possible because a minimal air change is needed for reasons of hygiene and oxygen requirement.**
- **The removal of internal humidity too, demands a certain degree of ventilation because mould growth has to be avoided.**
- **In assembly areas (e.g. schools, meeting halls, etc) it is almost impossible to keep the internal air cooler than the external, other than for short periods. When the bodily heat output exceeds the rate of heat absorption by the building fabric, the air temperature increases. When it reaches the outside air temperature, further rises can be avoided by ample ventilation.**

### **Ample ventilation at night**

**When the stored heat is to be dissipated at night, ample ventilation is necessary. The indoor air stream at night should be directed so that it passes the hottest inside surfaces, which are likely to be the ceiling or the underside of the roof. The placement of openings,**

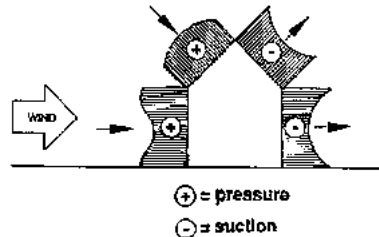
**louvres etc. should be designed accordingly.**

## **Types of air circulation**

**Basically, two types of air circulation can be distinguished:**

### **a) External winds**

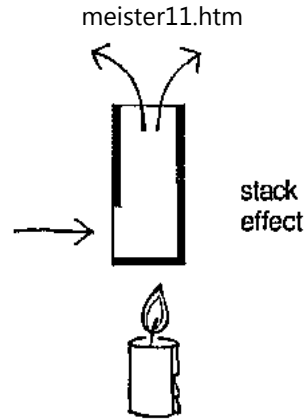
**Air circulation can be induced by external winds. They produce wind pressure on the building, positive on the windward side, negative on the leeward side.**



**Fig 3/58 Wind pressure distribution**

### **b) Thermic circulation**

**Air circulation can also be induced by thermic movement. Any material, including air, expands when heated. Warm air is lighter than cool air and rises. This, so-called "stack effect" can be used to increase ventilation where the breeze is not sufficient.**



**Fig 3/59 Principle of thermic effect**

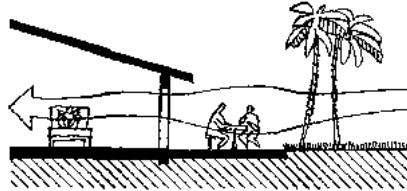
### **Design concept**

**When designing for optimal ventilation the following information is required:**

- **What is the pattern of existing winds (speed, direction, temperature) ?**
- **How do these wind characteristics change during the course of the day and with the seasons ?**
- **When is increased air circulation desired for cooling or heating, when is it not ?**
- **When air circulation is desired, in which room; and in which zone and at what level in the room ?**

**For instance, in bedrooms, particularly in warm-humid zones, the main airflow should be in that part of the bedroom where the beds are located and at a height a little above bed level.**





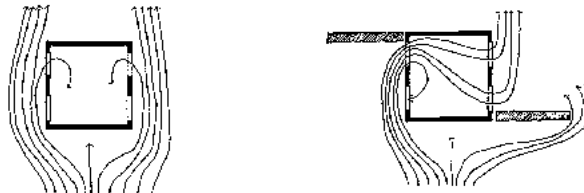
**Fig 3/60 In warm humid zones air movement at body level is desired**

### **Means of controlling ventilation**

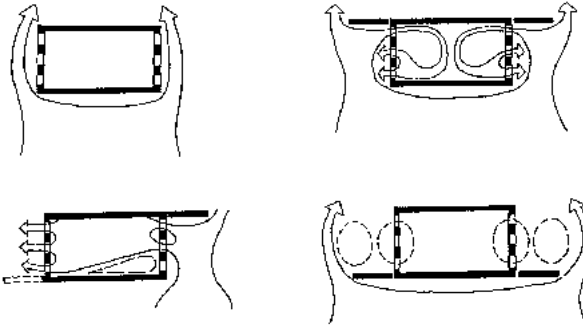
**To either benefit or to protect from cooling winds, the pattern of the airflow in a building can be influenced by**

- **measures outside the building and building shape**
- **measures relating to the building shell, openings, louvres, shutters, etc.,**
- **measures relating to the interior and special ventilation devices,**
- **devices that create a "stack effect" ventilation.**

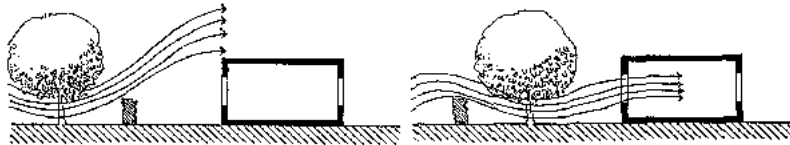
**There are many possibilities for directing and deflecting winds. Deflection of up to 90° is possible.**



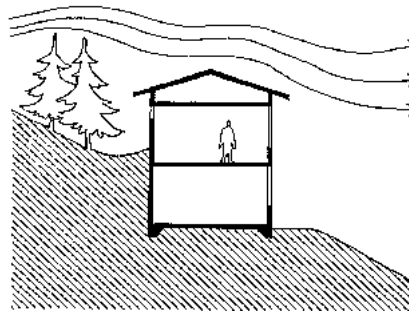
**Fig 3/61 Deflection by hedges**



**Fig 3/62 Deflection by parapet walls**

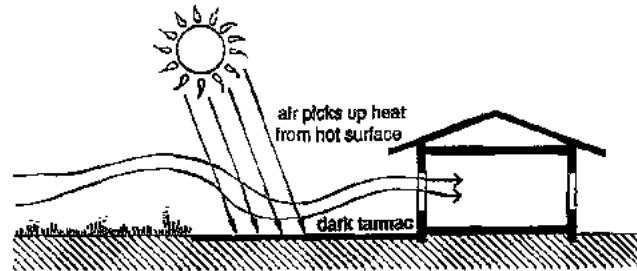


**Fig 3/63 Relation of trees to parapet wall**



**Fig 3/64 Protection from wind by vegetation and topography**

**In the hot seasons, before entering a building, wind should not pass over hot surfaces.**

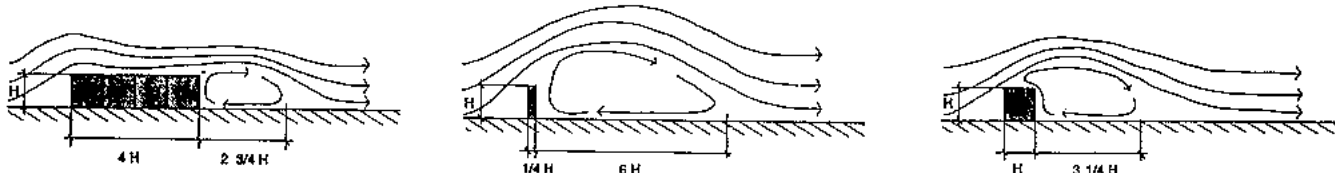


**Fig 3/65**

### **Influence of building shape on wind**

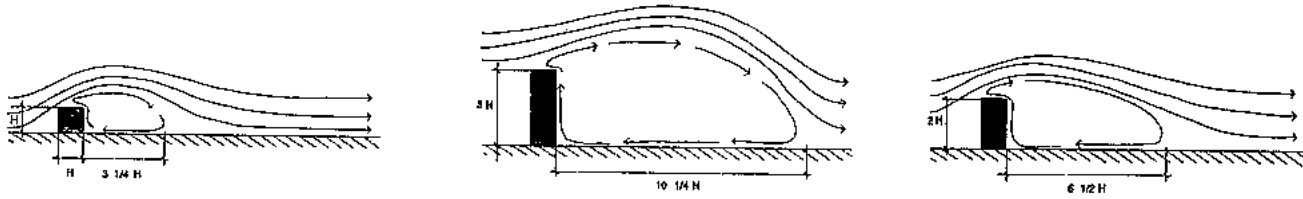
**Every building creates wind-protected areas and may deflect the wind direction. This may be important for neighbouring buildings. Some general examples illustrate this aerodynamic phenomenon:**

**The wider a building, the larger is the windshade behind it. [ 153 ]**



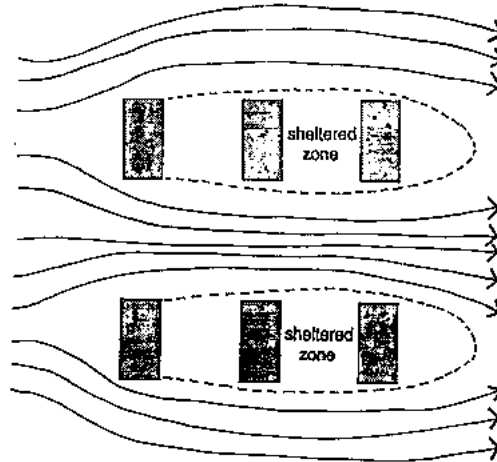
**Fig 3/66 Influence of building depth**

**The higher a building, the deeper is the windshade area behind it.**



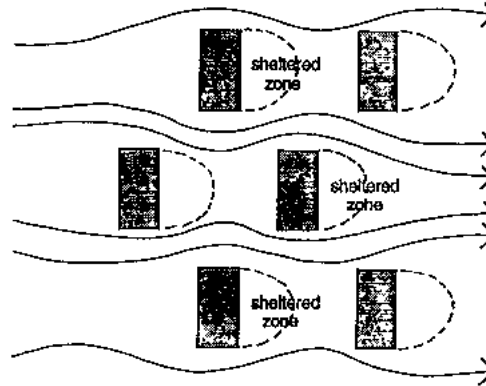
**Fig 3/67 Influence of building height**

**When grouping buildings in a row parallel to the main wind direction, a large distance between buildings is needed to guarantee proper ventilation.**



**Fig 3/68 Buildings grouped in a row**

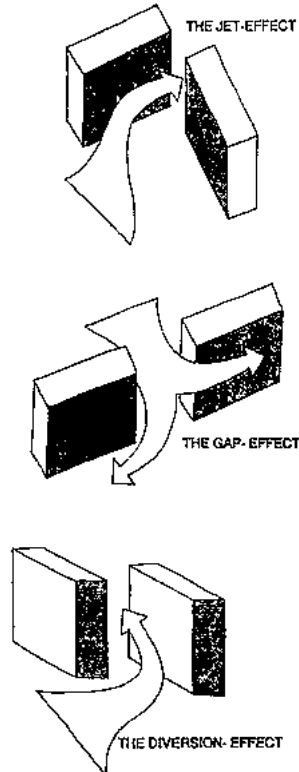
**When grouping buildings in a staggered pattern, the distance between buildings can be reduced.**



**Fig 3/69 Buildings grouped in a staggered pattern**

**The grouping of buildings also affects the airflow pattern. Typical examples are:**

- **The jet-effect, where a funnel situation causes accelerated wind speed through a narrow passage.**
- **The gap-effect, creating a dispersion of the airflow after a gate-like situation.**
- **The diversion-effect created by staggered buildings.**



**Fig 3/70 Typical effects on airflow pattern**

**Orientation of the roof**

**To keep roofs cool, they should be sloped towards the prevailing breeze and any**

obstructions which would prevent the airflow along the roof surfaces should be avoided. High solid continuous parapet walls around the roof would, for example, create a stagnant pool of hot air, and should, therefore, be avoided. [ 8 ]

#### d) Building shell design, openings and louvres

The size of the openings and their location influence the velocity of air circulation and its main route in the interior.

The larger the windows, the higher the indoor air speed; but this is true only when the inlet and outlet openings are increased simultaneously. When a room has unequal openings and the outlet is larger, then much higher maximum velocities and slightly higher average speeds are obtained.

In Fig 3/71 the air speed outside is taken as 100, the inside values are expressed as a percentage of this.

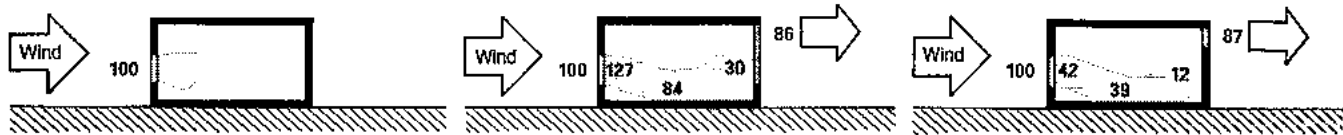


Fig 3/71 Influence of size of openings

A loggia opening leewards, with only small openings windwards, will have a steady airflow through the building because the airflow over and around it creates a low pressure within it, thus pulling in air in a steady stream through the small openings. Therefore, the greater the ratio of outlet area to inlet area, the greater the airflow through the building. [ 122 ]

## Placement of openings

The location of openings may create a deflection of the indoor air circulation. When the opening is placed asymmetrically in a facade, unequal pressure on both sides of the opening influence the airflow.

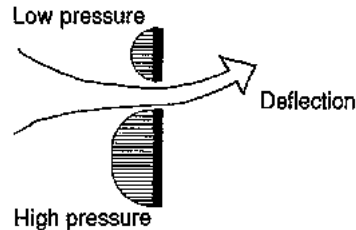


Fig 3/72 Pressure distribution by openings

This effect can be observed in the horizontal direction when a window is not centred in the plan.

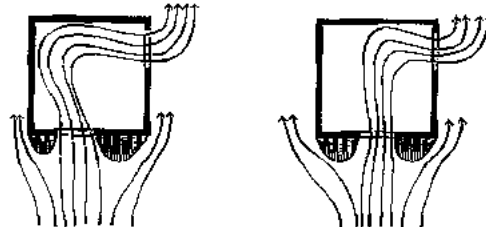
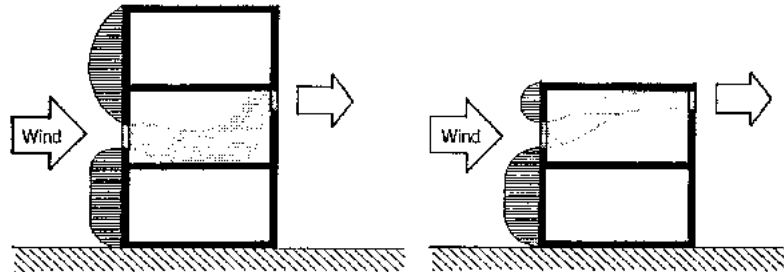


Fig 3/73 Deflection in the horizontal direction

The same is also true in the vertical direction. This is best illustrated when adding another floor on an existing building and thus changing the proportions of the facade.





**Fig 3/74 Deflection in the vertical direction**

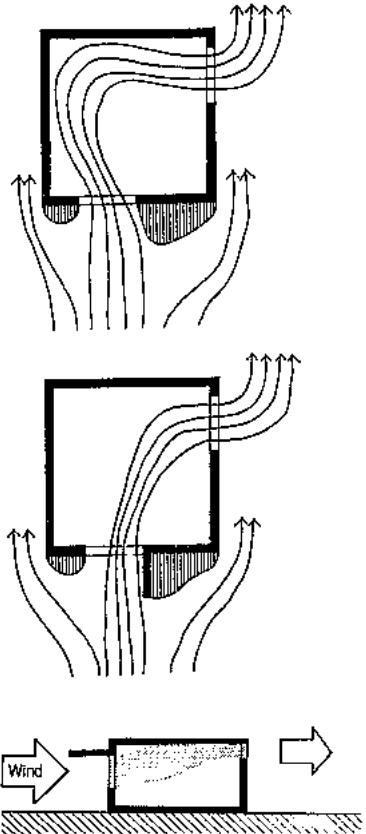
**Fins and projecting slabs also influence the pressure distribution on the facade and with it, too, the direction of the airflow inside the building. In this case, the airflow is influenced both in the horizontal as well as in the vertical direction.**

**A fin on one side of a window diverts the airflow**

**A canopy over a window directs the airflow upwards**

**A gap between it and the wall ensures a downward flow**

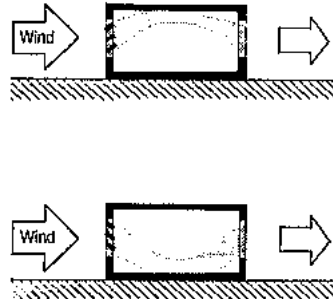
**This is further improved in the case of a louvred sunshade**



**Fig 3/75 Deflection by fins**

**Effect of louvres and their position.  
(also see Chapter 3.3.4.3)**

**Although the indoor airflow pattern is mainly influenced by the size and position of the openings, it can also be influenced and controlled by adjustable louvres. In this way, incoming air can be diverted to the desired level within the room.**



**Fig 3/76 Effect of louvres**

### **Double roof ventilation**

**If a double roof, or a separate roof and ceiling are used, the heat transfer from the outer building skin to the ceiling has to be considered. This will be partly radiant (approximately 80%) and partly conductive. As the roof is warmer than the ceiling, and hot air rises to the roof, there will be no convection currents. If the roof space is closed, the enclosed air may reach a very high temperature, thus increasing the conduction of heat.**

**This can be avoided by ample ventilation of the roof space. Ventilation will also reduce radiant heat transfer by lowering the temperature of the inside surface of the outer skin and thus reducing the temperature of the ceiling.**

**Attention must be paid to the design of the openings from this space and their orientation in relation to the prevailing breeze. Even if this breeze itself is warmer than is**

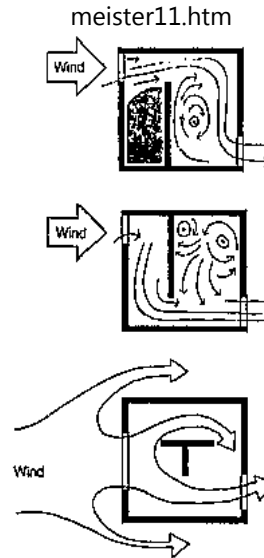
**comfortable, (it will, therefore, be excluded from the room itself), the roof temperature both on the outside and on the inside of the outer skin is likely to be much higher: the opening will thus still help in removing some of the heat.**

### **Cross-ventilation**

**To achieve a reliable air circulation, buildings must be designed for cross-ventilation.**

**Care must be taken not to impede such cross-ventilation with incorrectly designed interior partitions. When a room is divided by means of a partition - or when there are several rooms together with inlets and outlets separated by doors or halls - the air changes direction and speed as it passes through the room. This, in general, reduces air movement. By creating a turbulent, circulating movement of air within the room, however, an effective ventilation of more of the area may result.**

**Partitions arranged parallel to the airflow may divide this stream, but do not reduce the velocity.**



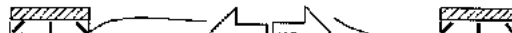
**Fig 3/77 Arrangement of partition walls affects air flow pattern**

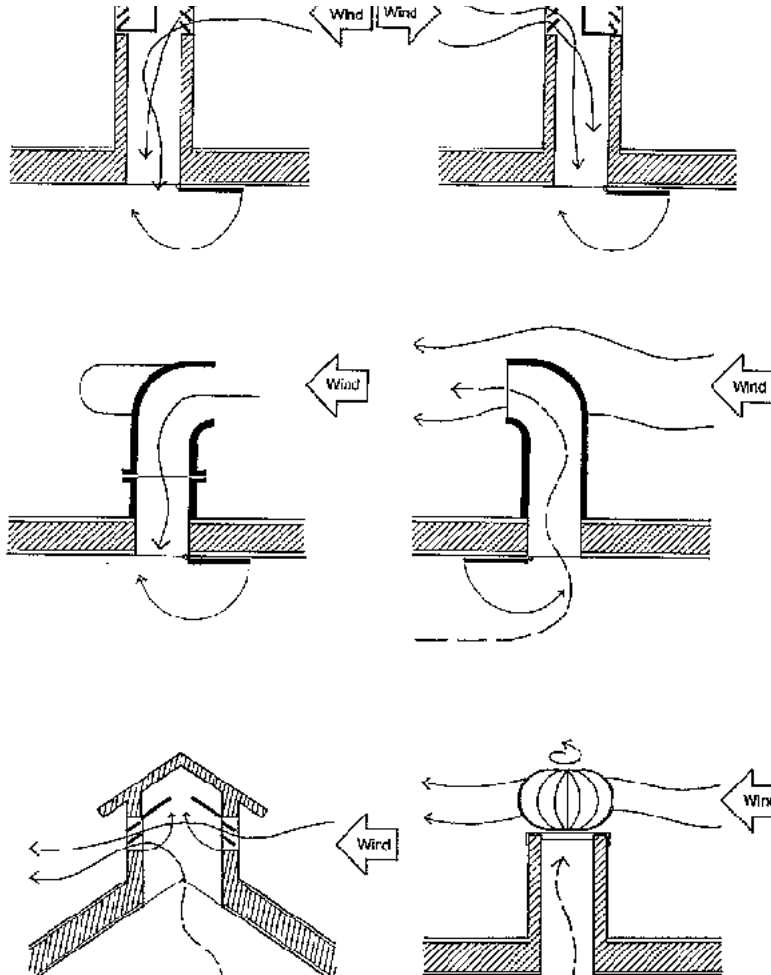
### **Electric fans(see Chapter 3.1.5.4)**

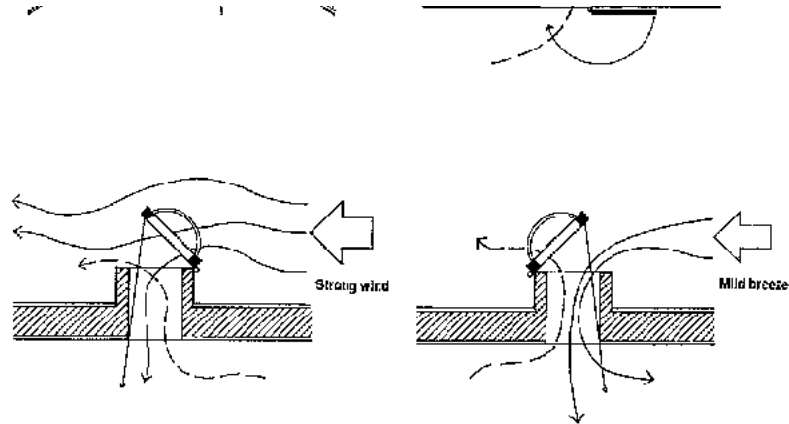
**Mounted electric ceiling or other types of fans may be used where there is little or no breeze, but these will normally only provide air movement and not induce the exchange of air.**

### **Device utilizing external wind**

**To benefit more efficiently from existing winds, various devices mounted on the roof can be used.**





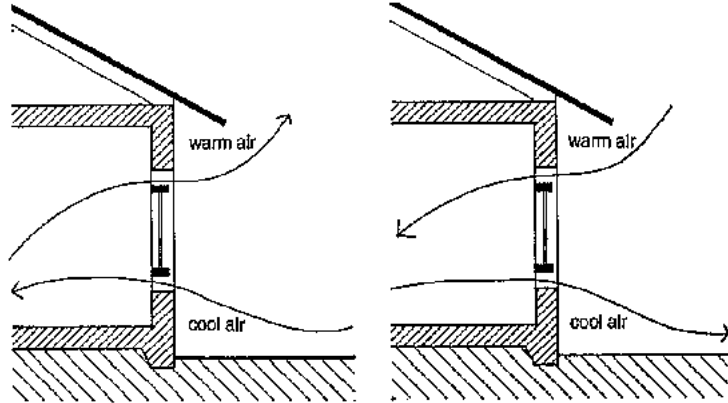


**Fig 3/78 Examples of devices using external winds**

### **Devices utilizing the "stack effect"**

**Often regular winds do not exist but there may be solar radiation and diurnal temperature fluctuations. These phenomena can create a "stack effect" that can be utilized to increase ventilation. (Also see [ 8 ] )**

**The "stack effect" can also be induced by placing openings near the floor and near the ceiling. It can be regulated by window shutters to obtain the desired heating or cooling effect.**

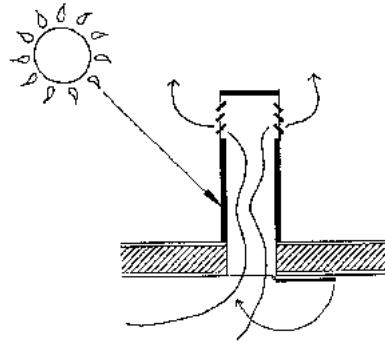


**Fig 3/79 Use of "stack effect"**

### **Solar chimneys and induction vents**

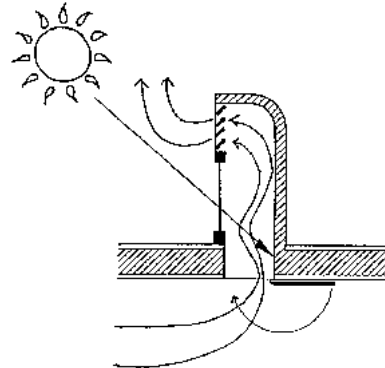
**Solar chimneys make use of solar heat to reinforce natural air convection. A black coated metal pipe chimney is heated by the sun's radiation and so is the air inside. The latter then rises taking the interior air up and out. This system is self-regulating, the hotter the day, the faster the air motion**





**Fig 3/80 Black coated pipe as solar chimney**

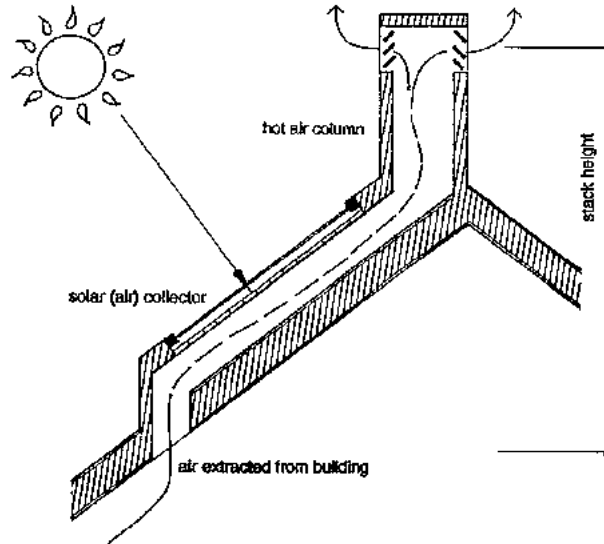
**A variation is the “glazed solar chimney”. Such chimneys, when facing west, are favourable for ventilation during the hot afternoon. If a thermal storage mass is added behind the glazing, the system will store heat and keep on expelling air after sunset.**



**Fig 3/81 Glazed solar chimney**

**Induction vents use “solar air ramps”, “windows with radiant barrier curtains”, or “solar mass walls”. Sunlight is trapped behind south or west facing glazing and the heated air rises and is allowed to escape to the outside. This causes the internal air to be pulled into the heated space and expelled.**

**Air taken from the shaded north side may be used to replace the expelled air inside the building.**

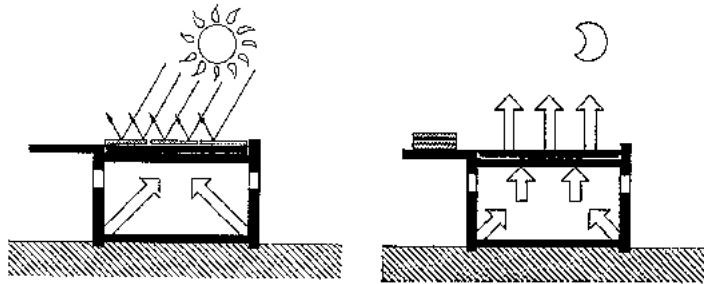


**Fig 3/82 A variation of solar chimney with “solar air ramp” [ 2 ]**

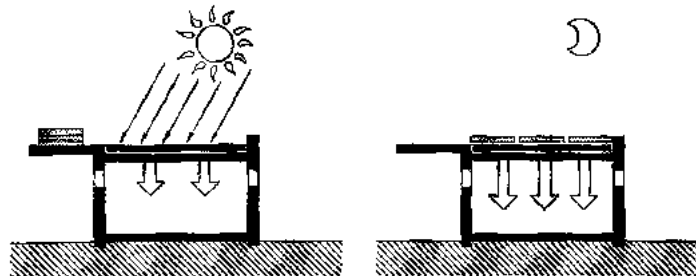
### **3.1.5.3 Passive cooling means (also see Chapter 3.2.5.3)**

### a) Roof ponds

**A water body covering the roof functions similarly to a soil cover, minimizing the diurnal temperature range. It is thus appropriate in climates with a diurnal average temperature within the comfort zone. It has the advantage that it can easily be removed during periods when this effect is not desired. Open roof ponds are difficult to maintain and require an absolutely watertight and costly roof construction. Shortage of water in arid zones is another disadvantage.**



**Fig 3/83a Roof pond cooling in summer**



### **Fig 3/83b Roof pond heating in winter**

**A special system works with a layer of bags (15-20 cm) containing water that are placed on the roof and are covered with movable insulating panels (5-10 cm), which appear to regulate the internal temperature at comfort level. In summer, these panels are closed during the day to insulate the bags from solar radiation and to allow heat to be drawn from inside, while at night the insulation is removed to allow the water to radiate heat to the night sky. In winter the process is reversed.**

**The system is good for cooling, since it faces the night sky, but does not have an ideal angle for collection of heat. However, it is a complicated and expensive solution which also requires the daily attention of the users. [e.g. 7, 10, 12, 136, 138 ]**

#### **b) Trombe walls and water walls**

**These systems are mainly suited for heating and thus dealt with in Chapter 3.4.5.3. Under certain circumstances they can also be used to induce cooling by ventilation (see Chapter 3.2.5.3)**

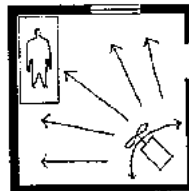
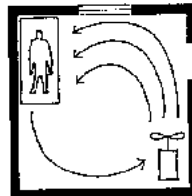
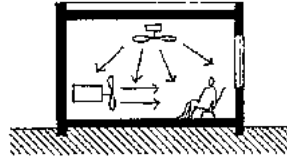
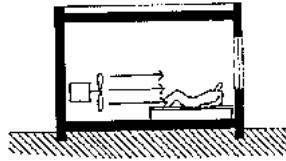
#### **3.1.5.4 Active cooling devices (also see Chapter 3.2.5.4)**

##### **a) Electric fans**

**A simple active device for the improvement of the indoor climate may be the use of electric fans. In most cases this widespread method can provide a sufficient means of evaporating perspiration and cool the skin at a fraction of the cost of air conditioning.**

**Fans can be used in various ways:**

- **Placed too closely to the body may be a health hazard, especially for the elderly.**
- **Remote or slow revolving overhead fans are recommended.**
- **Indirect and remote placing gives a steady mild flow and is safe for health.**
- **Pivoting fans produce a strong but intermittent flow, which may not suit everybody. [ 147 ]**

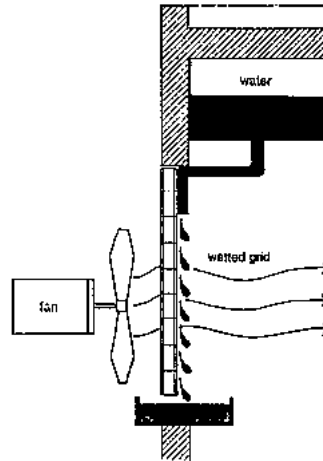


**Fig 3/84 Various ways of using an electric fan****b) Forced ventilation**

**Air circulation and air changing by electric ventilators is another possibility of cooling. Ventilators may be placed directly in the outer wall or may be combined with an air duct system.**

**c) Evaporative cooling  
(also see Chapter 3.2.5.1)**

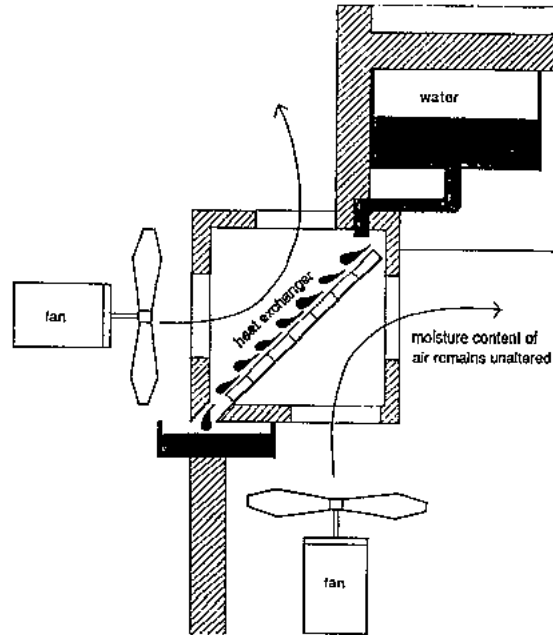
**Cooling can be achieved by humidification. The evaporation of water is a physical process which requires heat energy. This energy is taken from the air, and its temperature drops accordingly. Thus this phenomenon can be used for cooling. The possibilities of evaporative cooling depend on the potential of the air to absorb humidity. The drier the air, the greater is the cooling potential, because a greater amount of water can be evaporated. The method is thus best suited to hot-arid climate zones.**



**Fig. 3/85 Direct evaporative cooler**

**In some maritime, coastal areas and in warm-humid climates, this potential is small because of the high relative humidity. Here only indirect cooling using a heat exchanger is possible, and the efficiency is less.**





**Fig. 3/86 Indirect evaporative cooler**

#### **d) Air conditioning**

**Under extreme conditions, active devices in the form of air conditioners are often unavoidable because sufficient passive cooling is very difficult to achieve.**

**Air conditioning requires a fundamentally different concept of construction. Aspects of thermal insulation, vapour diffusion, double glazing etc. need to be considered; of less importance are heat storage and time lag. Thus, the decision has to be made right at the**

**beginning of planning and designing a building. However, many passive means such as orientation, shading, limited window surface, etc. are also beneficial for air conditioned buildings by drastically reducing energy consumption and running costs. [ 136 ]**

## **3.2 Design for hot-arid zones**

**The main points:**

- **Provide maximum shading of direct and reflected sun radiation in the hot season.**
- **Balance the extremes of summer and winter by movable parts.**
- **Provide ventilation by regulated air movement and small openings.**
- **Avoid large exposed exterior surfaces.**
- **Use reflective outer surfaces.**
- **Balance the extremes of day and night temperatures by adequate thermal storage mass**
- **Reduce internal heat production and conduction gain in hot seasons.**
- **Promote evaporation and heat loss by radiation.**
- **Increase air circulation in humid maritime regions.**

### **3.2.1 Climate and design in general (also see Chapter 3.1, General guidelines)**

#### **Climatic condition**

**The climate of hot-dry zones is in general characterized by high temperatures (40 - 50°C in summer), with sharp variations in both diurnal (day / night) and seasonal (summer-/ winter) temperatures; and precipitation (rainfall, snow) which is scarce, irregular and unreliable, but may nevertheless cause severe floods. Cold winds and dust/sandstorms prevail in winter. The solar radiation intensity is high and enhanced by the radiation reflected from the ground. The air humidity is low and this climate is generally healthier than those of warm-humid lands. Different climatic zones can be distinguished within**

**desert regions according to their specific geographical characteristics. Particular conditions in maritime desert regions mean that the high humidity causes definite discomfort in summer. On the other hand, the humidity tends to reduce diurnal variations and moderate temperatures. (also see Chapter 2.2)**

### **Design objectives and response**

**The main goal of climatic design, on a macro (settlement) and micro (building) level, is hence to reduce uncomfortable conditions created by extremes of heat and dryness. Buildings must be adapted to extreme summer / winter and day / night conditions to achieve a well balanced indoor climate. Not only cooling is needed; passive heating may also be needed in winter and during cold nights. Protection is required from the intense radiation from the sun, ground and surrounding buildings, from dust, sandstorms and insects (flies). Glare has to be reduced and dust penetration prevented. Settlements and buildings, therefore, have to be compact, providing shade and controllable ventilation.**

**In maritime desert regions, the high humidity requires more air circulation (ventilation) in summer. It is difficult to design buildings for this climate.**

### **General remarks**

**Hot-arid zones or desert regions with scarce vegetation and saline soils are distributed throughout the world. 15 percent of the world's population lives in arid zones; 1/3 of the world's land mass and 22% of all potential arable land lies in the arid zone. Most of the world's energy reserves (oil) are within or adjacent to these zones. [ 112 ]**

**In the last half century, technological changes have had a major impact on urban forms and housing throughout the world. The introduction of the car into the settlements has also drastically altered the traditional urban pattern of hot-arid regions. The new wide streets reduce the potential for shading. In addition, the great amount of heat-discharging**

**air conditioners and large paved surfaces have contributed to changes in the microclimate of urban situations. Moreover, a change in lifestyles and means of livelihood has occurred. Mud or adobe buildings, dark interior spaces (very few and small windows) and sleeping on the roof are probably no longer acceptable to society in general, but still reality for low income groups. In addition, the proper handling of climatization devices properly, and the limitations of passive means are problems which should not be neglected. (also see Chapter 3.1.1)**

### **3.2.2 Settlement Planning (also see Chapter 3.1.2)**

**The main points:**

- **Topography, to enhance the efficiency of passive means**
- **Orientation, to reduce the sun exposure in summer**
- **Air movement, to provide ample ventilation in summer and protect from winds in winter**
- **Form, to design compact settlements for mutual protection**
- **Hazards, to avoid dangerous sites**

#### **3.2.2.1 Topographical location of settlements (also see Chapter 3.1.2.1)**

**The positioning of settlements can help to take advantage of local features to improve the micro-climate with regard to comfort. Attention has to be paid to the topographical altitude, the geomorphology and the most suitable orientation regarding sun exposure and prevailing winds. Differentiation must be made between locations on top of hills, on slopes, in valleys, on flatlands and near water. (see Fig 3/1 to Fig 3/8)**

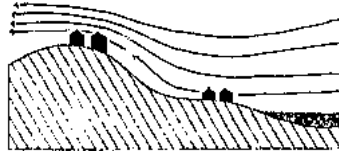
#### **Sun-orientation**

**Compact settlements should be located on shaded slopes (north-sloping) and at higher levels. The general preference for the orientation of slopes referring to sun exposure (on the northern hemisphere) is: 1st: north; 2nd: east; 3rd: south; 4th: west. This can vary in relation to the local conditions, topography, vegetation, sun angle and exposure time. e.g. sites on north / southeastern slopes are also acceptable. Near the equator, south slopes are preferred over east and west slope.**

**Depending on how much passive heating during night and cold seasons is required, south slopes can be advantageous. (also see Chapter 3.4)**

### **Wind orientation**

**Locations are preferred where the effect of cool airflow can be utilized and controlled. High altitudes and locations with evaporative possibilities are advantageous. Settlements have to be properly oriented regarding prevailing winds. Winds are more frequent and relatively cooler at higher elevations. Blowing over a water-body can result in a drop of a few degrees in the temperature of a wind. Wind can also be caused by specific direction and conditions in a valley.**

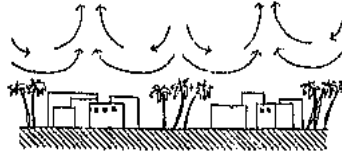


**Fig 3/87**

### **Location in flat regions**

**Compact settlements in flat areas have, in general, less natural features, such as hill sides, slopes, and rock formations which have to be integrated to improve the micro-climate.**

**Such settlements should include vegetation because the air is cooled while crossing green shaded areas. A draft is created through cooling the hot air in the shade and by the humidity of plants or water ponds, a phenomenon well known from traditional oasis settlements. (also see Chapter 3.1.2.3, 3.2.2.3)**



**Fig 3/88**

### **3.2.2.2 Hazards**

**(also see Chapter 3.1.2.2)**

#### **Sand and dust storms, sand dunes**

**The reduction of the effects of sand storms can be achieved through the location of settlements at higher elevations and landscaping cities with plants and water, which lead to less sand in the air. The open space pattern (network of streets and squares) has to be planned accordingly, e.g. an irregular pattern to break strong winds (see Chapter 3.2.2.3). Particular attention has to be paid to the moving direction of sand dunes, which can slowly bury houses and entire settlements.**

#### **Floods**

**In desert areas, the so-called wadis (dry valleys and rivers) can be very dangerous places because of their bad drainage and sudden inundation in case of heavy precipitations.**

#### **Landslides**

**Heavy precipitations can cause landslides both at the bottom of valleys and on slopes.**

## **Earthquakes**

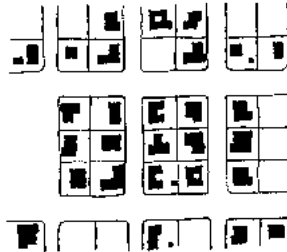
**Safe constructions can be in contradiction to traditional design or climatic construction requirements, particularly in the case of simple mud (adobe) or brick buildings.**

### **3.2.2.3 Urban forms and external spaces**

**The following are the main design objectives:**

- **Provide maximum shade in summer and adequate heat gain in winter.**
- **Minimize reflection (indirect solar radiation) in streets and open spaces.**
- **Moderate the effects of undesired winds.**
- **Plan narrow winding alleys and streets, which are shaded and relatively cool and break stormy winds, but allow through-ventilation and adequate natural lighting.**
- **Design suitable building forms.**
- **Plan close proximity of urban services and daily functions within walking distance; wide roads can thus be omitted or at least reduced.**
- **Avoid large open spaces within the city where hot air can collect during the day and which are conducive to duststorms.**
- **Provide ample shaded public spaces.**
- **Select light colors for every open space.**

- **Include green areas of plants around and within the settlement to provide shade and cool air and to stabilize the soil.**
- **Plant and cultivate xerophytes that require little or no water.**
- **Integrate water bodies, which evaporate and therefore reduce temperature.**

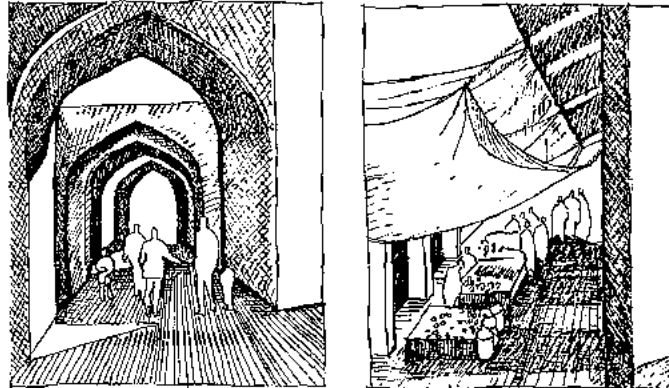


**Fig 3/89 Traditional and imported urban patterns**

**Minimal sun-exposure in summer and therefore compactness and shade are the main principals for building in hot-arid zones. Hence, compact planning for groups of buildings is required in order to give shade to each other and to provide a shaded network of**



**narrow streets and small spaces in between as patio-like areas. Arcades, colonnades, cantilevered buildings or building components, membranes and small enclosed courtyards are traditional responses to the climate; even larger public open spaces should be enclosed, inward looking and shaded for most of the day. Of equal importance is natural lighting and ventilation. Air circulation can be improved through wind channelling in shaded narrow streets in the direction of the main wind. The grouping of buildings and alleys or lanes should allow for proper ventilation or even increase the airflow. The location near a water source and the incorporation of vegetation is most important. [ 9 ]**



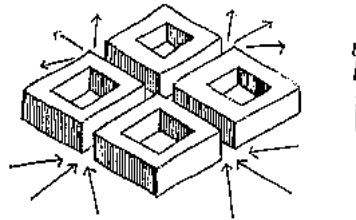
**Fig 3/90 Shady arcades**

### **Settlement patterns and street-networks (also see Chapter 3.1.2.3)**

**Urban forms are not only a result of physical and functional, but also of social and cultural factors and traditions in a region. There are different ways of properly designing an urban form in an arid region taking into account solar radiation and wind.**

**Some basic possibilities:****a) Grid diagonal to east-west axis**

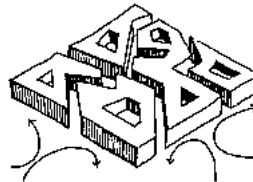
The grid pattern maximizes radiation throughout its straight streets, but by orienting the grid pattern diagonally to the east-west axis, the sun exposure and shade is better distributed on the streets; such a grid still supports the dynamic movement of air. More important, however, is the form of alleys and buildings. [ 5, 143 ]



**Fig 3/91 Grid diagonal to east-west axis**

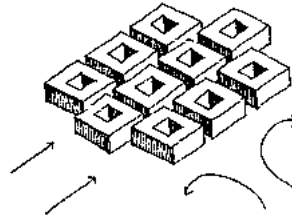
**b) Narrow, zigzagging alleys**

Winding or zigzagging narrow alleys receive minimum radiation, reduce the effect of stormy winds, establish shaded spaces throughout the day which provide a cool and comfortable microclimate and also stay relatively warm during cold nights and in winter.



**Fig 3/92 Zigzagging alleys****c) Blocked streets and alleys**

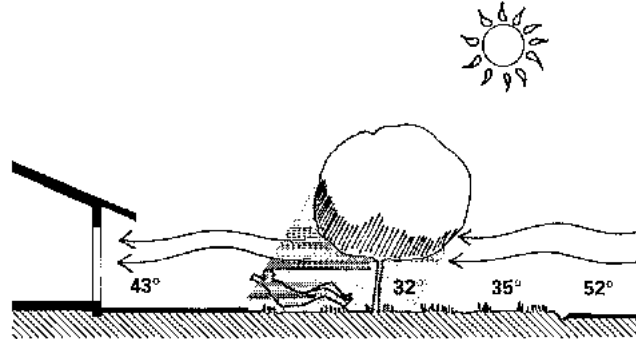
**Street orientation and housing patterns are significant and must be planned carefully. Straight and parallel streets open the city to wind ventilation. Storm effects can be reduced by blocking streets. Two-story buildings with closed patios open to the sky will maximize shade, minimize radiation, yet still retain ventilation and reduce the effects of stormy winds. Buildings should be attached (cluster) to reduce exposed surfaces.**

**Fig 3/93 Blocked streets****External space design****External space design(also see Chapter 3.1.2)**

**The town structure and the public spaces should thus counteract heat with a shaded and dense layout. There should be a close connection between public spaces and residential areas. Dwelling units or groups should create patio-like areas. Paved open spaces within a flat cityscape should be avoided or kept to a minimum size.**

**Most important is the design of the whole urban configuration, because the ratio of shaded space to space open to solar radiation affects air temperature significantly. The**

temperature in and around buildings can either be tempered or aggravated by the nature of the surrounding surface. The temperatures shown in Fig 3/94 were recorded in a hot-dry climate when the air temperature was 42°C [ 106 ]



**Fig 3/94 Temperatures of differently-treated surfaces**

#### **a) Street-scaping**

Particular attention has to be paid to the needs of the pedestrians, walkways and the scale of the environment. Half and full shade protection by arcades, membranes etc., and vegetation (trees) is desirable; exposed paved surfaces should be avoided; pools of water are beneficial.

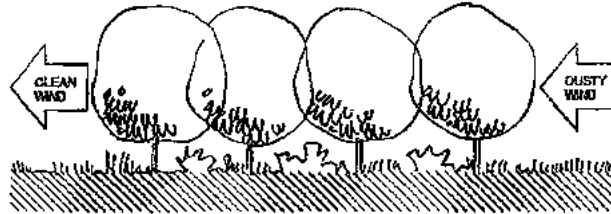
(also see Chapter 3.1.2.3 and 3.3.2.3)

#### **b) Landscaping with vegetation**

(also see Chapter 3.1.2.3)

Trees, hedges and plants in an urban context can have a dramatic effect on the microclimate and help to tie down sand and dust [ 1 ]. As vegetation is generally sparse,

**an oasis-like concentration of plant and grass-covered areas is desirable. Nevertheless, landscaping should not always imply the inclusion of very high water consuming lawns and grassed areas. Local desert plants as well as rock and stone garden as well as gravel coverage should also be considered as adequate design elements.**



**Fig 3/95 [ 124 ]**

### **c) Pattern of green areas**

**The vegetation in and around the city promotes and controls air movement. Apart from water areas, evaporation and cooling takes place only in green areas. Green areas located near and in a city will therefore improve the urban climate. The difference in temperature between green areas and built-up land causes minute air cycles and a horizontal exchange takes place. An arrangement of small parks and lanes could facilitate the ventilation of the town. The wind from the countryside is encouraged to penetrate as far as possible into the built-up area. [ 124. 134 ]**

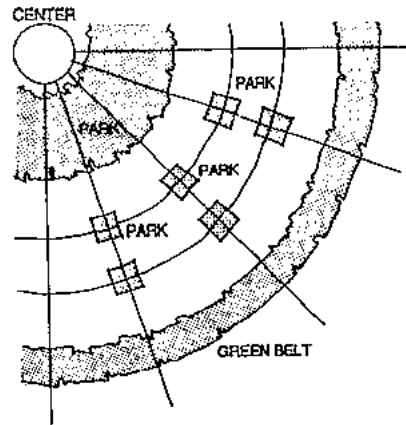


Fig 3/96

### 3.2.3. Building Design (also see Chapter 3.1.3)

The main points:

- Orientation and placement, to minimize sun exposure in summer.
- Form, compact to reduce surface areas of heat gain.
- Shade, for maximum sun protection in summer.
- Allow adequate heat gain in winter by movable shading devices.
- Ventilation, for regulation of air movement.

#### 3.2.3.1 Orientation of buildings (also see Chapter 3.1.3)

Proper orientation and location of buildings allow for sun and wind protection and

## **controlled wind channelling (airflow).**

### **Sun-orientation**

**The orientation of a building is influenced by the amount of solar radiation falling on different sides at different times. Buildings are best arranged in clusters for heat absorption, shading opportunities and protection from east and west exposures. Protection from solar radiation is particularly important during times of excessive heat when there can be a difference of as much as 3°C in air temperature in a building between the best and least favourable orientation. The larger building dimension should face north and south (generally, west orientation is the worst: high air temperature combined with strong solar radiation) [ 9 ]. The optimum orientation for any given location has to be determined in order to achieve the most satisfactory distribution of total heat gain and loss in all seasons. At high altitude enough heat gain for passive heating should be possible.**

**In general, the best orientation is: north-south with 25o south easterly direction [ 13, 161 ]. Attention should be paid to solar radiant heat reflected from the surroundings (topography, slopes, rocks) to the building.**

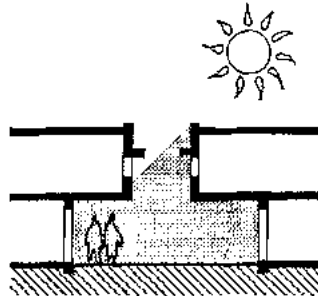
### **Wind-orientation**

**Main walls and windows should face the prevailing (cool) wind direction in order to allow maximum cross-ventilation of the rooms.**

#### **3.2.3.2 Shape and volume (also see Chapter 3.1.3.2)**

**The shape and volume of buildings should be compact, yet somewhat elongated along the east-west axis; (e.g. the optimum shape is 1:1.3), because large, compact building**

**volumes gain less heat. In general, the optimum shape is that which has a minimum heat gain in summer and the maximum heat gain in winter. Under winter conditions an elongated form is ideal; under summer conditions a square shape is better [ 9 ]. A compact "patio" house type is therefore preferable. Adjoining houses, row houses, and group arrangements (all continuous along the east-west axis), which tend to create a volumetric effect, are advantageous, as are high massive buildings [ 13 ]. Lithospheric arrangements (subterranean) are also applicable.**



**Fig. 3/97 Shading of buildings and building elements by cantilevered construction, arcades, loggias and high building parts.**

### **3.2.3.3 Type and form of buildings**

**Dense settlement patterns require a particular type of building consisting of compact structures and forms. Subterranean spaces are also adjusted to climatic stress. In hot-arid zones, external and internal living spaces have to be protected against solar radiation, glare, and hot, dusty winds. Compactness can be achieved by "carpet-planning" layouts with courtyard houses or cluster settlements of high buildings to create suitable patterns. Particular solutions may utilize underground (subterranean) buildings or caves. Some heat gain and storage in the winter season is desirable.**





**Fig 3/98**

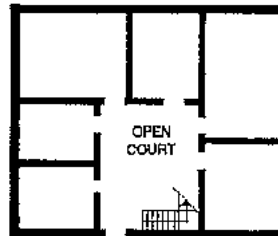
**The main objectives are:**

- **Compact and massive design, mainly inward-facing buildings.**
- **Minimize surface areas and openings exposed to the east and west sun and orient the building accordingly.**
- **Allow heat gain and storage in winter.**
- **Group buildings closely to each other. Especially east and west walls should be placed closely together for mutual shading.**
- **Create thermal barriers (non-habitable rooms, such as stores, toilets etc.) on the east and especially on the west side of the building.**
- **Promote ventilation and access to cooling winds.**
- **Provide sufficient natural lighting (no excessively deep rooms).**

- **Plan short internal circulation distances and avoid unnecessary stairs.**
- **Shade roofs, walls, openings and windows and outdoor spaces.**
- **Include small enclosed courtyards with arcades, colonnades for light and air and outside day-to-day activities. Courtyards provide shade, cool air pools, and protection from hot and dusty winds.**
- **Treat the external space as carefully as the building itself to reduce glare and reflected heat radiation.**

### **Courtyard design**

**It is difficult to meet all the different functional and climatic requirements. Regarding the volume, the "patio-house" is the most suitable form and can benefit in summer from the microclimatic effects of cool air pools that occur in courtyards. Although winter conditions in hot-arid regions would permit an elongated house design, the heat in summer is so severe that a compromise is required. The very old, traditional solution - particularly for flat land - is a compact, inward-looking building with an interior courtyard. This minimizes the solar radiation impact on the outside walls and provides a cool area within the building. It also meets other requirements such as safety, defense, privacy, lifestyle etc.**

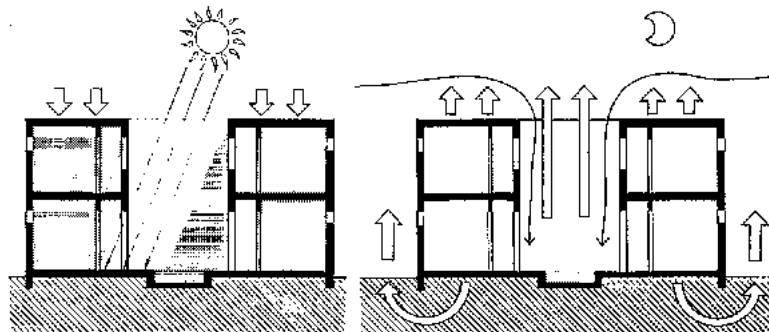


**Fig 3/99 Schematic plan of a typical Egyptian house built prior to 3000 BC.**

**In the typical oriental courtyard house, the covered terraces, which are usually on two or three sides of the courtyard, and the identical covered gallery on the first floor help to reduce the heat gained during the day and provide shaded areas. The correct ratio between the height and width of the courtyard should always allow for adequate shading, even when the summer sun is almost directly overhead. When the courtyard is provided with water and plants, it acts as a cooling source and modifies the microclimate accordingly.**

**In areas with cold nights or winters the court yard has to allow for adequate south exposure for passive heat gain and should be equipped with movable shading devices for the hot period.**

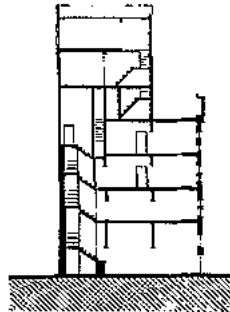
**However, the one or two storied courtyard building type cannot always fulfill today's functional and urban planning requirements, where high population density, economic land use, adequate car traffic, accessibility and suitable public transportation, etc. are required.**



### **Fig 3/100 Courtyard house with covered galleries and an internal pool for evaporation, day and night situation**

#### **Tall buildings**

**In certain regions, such as mountainous and coastal areas, (North Africa, Arabian Peninsula, etc.) high, compact buildings are the traditional solution, having also had an important defense purpose in the past. Cooler air from the lower floors is channeled through the building. High walls with integrated ventilation shafts are built at the back on the shady side. In maritime regions, large openings or bay windows for cross-ventilation are protected with wooden screens such as "Rowshans" or "Mashrabiya". (see Chapter 3.2.5.1)**



**Fig 3/101**

#### **Underground buildings**

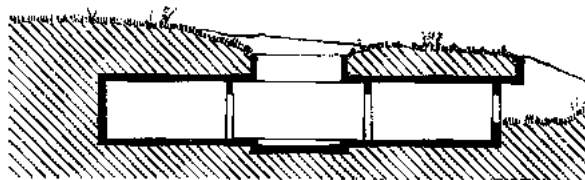
**Underground dwellings have been known for thousands of years. At a depth of about 2.5 m, the temperature of the earth is practically constant and remains close to the average yearly temperature. The indoor climate of structures built underground or covered with a**

**thick layer of soil benefits from the huge thermal mass of the adjacent ground and is thus not affected by hot days and chilly nights. Structures can be carved into suitable rock formations or may consist of a structural shell (even several floors underground), which is mainly concrete and covered by soil. (The provision of natural lighting might cause difficulties.)**

**Rules:**

- **Where the diurnal temperature range is wide, but the daily average is within the comfort zone, a soil cover is appropriate.**
- **Where the annual average temperature is within the comfort zone, structures built 2-3 m underground are suitable.**
- **High rooms (ceilings) are not necessary.**
- **Natural lighting must also be considered.**
- **Protection against surface water (flooding) may be required. Structures within the groundwater table should be avoided.**

**[ 5, 7, 9, 136 ]**



**Fig 3/102 Section through an underground dwelling**

## **Buildings in maritime, coastal regions**

**In certain regions, the high summer humidity in maritime areas makes designing buildings here extremely difficult. More ventilation is required at times and high thermal capacity structures are less effective. Tall buildings and building components with lightweight structures which utilize the breeze for rooms used in the daytime are good traditional solutions to reduce discomfort. The use of high thermal capacity structures, although still useful, will not be as effective as in other hot-dry regions. The coastal wind blowing off the sea during the day may be utilized to ameliorate thermal conditions. On the other hand, the nighttime wind carries hot inland desert air, possibly dust, towards the sea, which can be very unpleasant. Protection from this wind should be provided.**

**Perhaps the only solution is to provide alternative spaces: one with high thermal capacity walls and roof, for use at night, especially during the cooler part of the year; and one of lightweight construction, the roof providing shade only and the facades facing and opposite to the sea being left almost completely open. This is the best solution for daytime use, especially during the hottest part of the year.**

**It is in this climate that wind catchers, scoops and wind towers have their greatest benefit. [ 8, 9 ] (also see Chapter 3.1.3.3, 3.2.4.3, 3.2.5.2 and 3.4.3.3)**

**Table: The concept of alternative day and night space**

<b>Type of structure</b>	<b>Performance</b>	<b>Suitability</b>	
		<b>winter</b>	<b>summer</b>
Heavy structure	Cool in daytime	night	daytime
Light structure	Cool at night	daytime	night

**Room arrangements (also see Chapter 3.1.3.3. and 3.4.3.3)**

**The room layout depends on the building type. A courtyard design has certain advantages. Heat-producing areas should be separated from other areas of the house. Non-inhabitable spaces should be placed on the west side to check the sun's impact. Internal heat gain can be avoided by a functional layout.**

**Bedrooms should be on the east side, and outdoor or roof sleeping possibilities should be considered. Living rooms should be on the north or south side. The depth of interior spaces should allow for proper natural lighting. Nevertheless, modern floor plan requirements, multi-family housing (high density) and different values, such as access to a view, might be in contradiction to climatic design principles.**

#### **3.2.3.4 Immediate external space (also see Chapter 3.1.3.4)**

**The walls of houses and courtyards, cantilevered building parts and plants should provide shade to outdoor living areas. Half and full shade protection by arcades or loggias, membranes and trees is desirable; exposed paved surfaces should be avoided; pools of water are beneficial for cooling.**

#### **3.2.4 Building components (also see Chapter 3.1.4)**

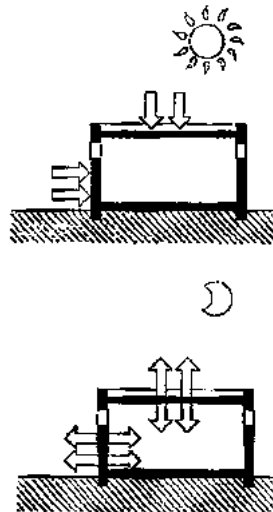
**The main points:**

- **Control of heat transfer through thermal storage and time lag by proper construction and materials**
- **Thermal insulation to reduce internal heat gain.**
- **Reflectivity and emissivity to re-radiate heat.**
- **Control of air movement**

## Building materials

The comfort of people inside the buildings depends largely on the thermal properties of the outer and inner walls and the roof. Depending on the function of the building components specific insulating and/or thermal storage qualities are required. (Basic explanations see Chapter 3.1.4)

Buildings in hot-arid zones are traditionally constructed with thick walls and roofs and with very small openings. An internal thermal storage capacity is very important to decrease the temperature variations and to make it possible to profit from an increased night ventilation by "storing the cool of the night until the day" during summer. The best materials are those that do not conduct heat.



**Fig 3/103 Heat flow in daytime and at night**



**Sun-dried earth brick is one of the poorest conductors of heat, partly because of its very low natural conductivity and partly because mud is structurally weak and necessitates thick walls. Yet thick mud bricks are not a perfect means of keeping cool; they retain heat for a long time. Therefore, it is important to calculate and plan the proper time lag. A big thermal mass can keep cool during the daytime and not be too cold at night. (see example Chapter 4.4) High heat capacity walls are essential. The traditional principle is to shelter behind very thick mud walls by day, and to sleep on the roof under a tent at night. [ 122 ]**

### **Construction concepts and details**

**The different building components require adequate design and material properties to act as a balanced system.**

- Thermal insulation is important to suppress surface temperature variations, but is only applicable in connection with adequate inner ventilation and cooling means or in combination with light structures (Insulation can also reduce necessary heat loss at night). Roof insulation is especially important in decreasing summer temperatures. The outside application of insulation is preferable because the structure and the construction materials are less exposed to thermal stress, and the storage capacity of a heavy structure material helps to balance the inner temperature. The additional needed skin for the building or roof must protect the insulation against damage by physical, mechanical forces, and should be of a hard material. The required insulation value depends on the sun exposure. (see Chapter 3.1.4)**
- Time lag properties of building parts and its materials should be used for energy storage and temperature exchange between day and night. Necessary time lags for internal heat balance are: Walls, east: 0 hours; south: 10 hours.; west: 10-hours.; north: 10 hours or no lag; roof: 12 hours [ 13 ] (also see Chapter 3.1.4)**
- Shading devices, such as a heavily ventilated double roof, and radiation reflection by a**

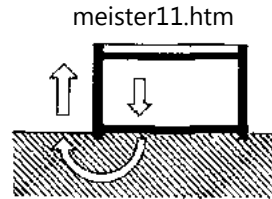
**white surface are necessary to decrease heat gain from solar radiation - mainly through the roof - during the hot period.**

- **External colors are required as a combination of high reflectivity of solar radiation and high emissivity of infrared radiation to the cool sky at night: white, non-shiny surfaces, avoid all dark colored surfaces. White paint has a high reflection ratio on sun exposed surfaces. Dark absorptive colors are usable where reflection towards the interior should be avoided (such as under eaves). Deep-set surfaces can be dark-colored for winter radiation absorption. Bright color contrasts should be in agreement with the general character of the region. [ 13 ]**

- **Internal colors, such as "cool" and bright colors can be used psychologically as a cooling contrast to intense outdoor heat and to distribute natural light for deep room arrangements.**

#### **3.2.4.1 Foundations, basements and floors (also see Chapter 3.1.4.1)**

**The ground is a valuable means of heat absorption; therefore the building should have maximum contact with the ground. Ground floors should be solid and built directly on to the ground or into the ground with heat absorbing materials (stone, adobe, earth, high density burnt clay or cement products) Ground floors should not be suspended and on no account be built on stilts. Flooring materials should be of high thermal conductance. The ground near the building should be shaded during the day, but fully exposed to the night sky, so that the emission of radiant heat is not obstructed. [ 8 ]**

**Fig 3/104**

### **3.2.4.2 Walls**

**(also see Chapter 3.1.4.2)**

**During the hot season, walls of daytime living areas should be made of heat-storing materials; walls of rooms for nighttime use should have a light heat capacity. East and west walls should preferably be shaded. High reflective qualities are desirable for both thermal and solar radiation. [-13 ]**

**In regions with a less extreme diurnal temperature range and where the night temperature does not fall below comfort zone, the internal walls and intermediate floors should have large thermal masses, whilst the outer walls and roof need a high resistive insulation and reflectivity [-8 ]. Double walls with insulation in between are a suitable solution. (multylayer construction, see Chapter 3.1.3)**

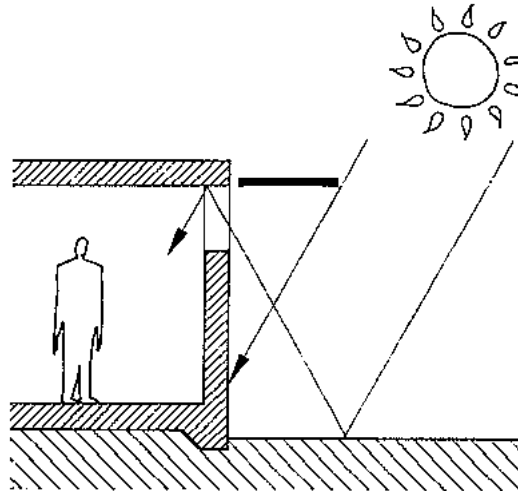
**In regions with large diurnal temperature ranges and night temperatures below comfort level, inner and outer walls and - especially in the absence of a ceiling - roofs should possess a large thermal capacity with an appropriate time lag to balance temperature variations. To achieve this they must be constructed of heavy materials. The use of exterior or interior insulation has to be considered carefully and its suitability depends on the particular requirements and technical possibilities.**

### **3.2.4.3 Openings and windows**

**(also see Chapter 3.1.4.3)**

**Openings and windows are necessary for natural lighting and ventilation, but heat gain in summer should be minimal. During the daytime, the absence of openings would be desirable, especially on the west side; or the openings should be as small as possible and be shielded from direct radiation and located high on the walls to protect from ground radiation [ 13 ]. At night, the openings should be large enough to provide adequate ventilation for the dissipation of heat emitted by the walls and the roof. Hence larger openings should be closed during the day with insulated shutters and opened at night. Such systems are not always reliable because they require the attendance and readiness of the inhabitants. Other considerations such as desired privacy and safety may prevent the correct use of a system with shutters.**

**Appropriate natural lighting is important. The depth of rooms and the size of windows have to be coordinated. Glare of direct natural lighting can also be avoided by the use of internally reflected light.**



**Fig 3/105 Indirect natural light**

### **Orientation and size of openings**

**Main openings should face north and south, but the latter should be shaded either by shading devices, roof overhangs or by deciduous trees. The size of the windows on the west and east sides should be minimized in order to reduce heat gains into the house in the early morning and late afternoon, or also be protected by particular shading devices. A moderate, south-facing glass area catches the solar radiation during the cold season, but should not be affected by direct radiation during the summer.**

### **Window glass (also see Chapter 3.1.4.3)**

**Generally, single glazing is sufficient. Insulating and special heat-absorbing and heat-reflecting glass is basically only suitable for air-conditioned buildings. Generally, single**

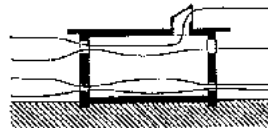
**glazing is sufficient. Tight closing joints and window profiles are important to prevent the penetration of hot air, sand, dust and insects.  
(also see Chapter 3.4.4.3)**

### **Placement of openings**

**Windows and other openings must be placed in suitable positions relation to the prevailing (cool) breeze to allow a natural airflow through the building, to achieve air movement across the body for evaporative cooling and air changes for driving out excess heat. An internal draft (cross-ventilation) can be channeled by louvres set in an upward position towards the ceiling or in a horizontal position towards the human body. Outlet openings should be located at a high level where hot air accumulates.**

**In buildings in coastal areas, openings for cross-ventilation should be equipped with movable shutters. Because of the hot land wind which occurs at night, openings facing the inland direction should be closable. [ 1 ] (also see Chapter 3.1.5.2)**

**For comfort, ventilation openings should be at the level of the occupants. High openings vent the hot air collecting near the ceiling and are most useful for convective cooling.**



**Fig 3/106 Placement of openings**

### **3.2.4.4 Roofs (also see Chapter 3.1.4.4)**

**Different forms of roofs are possible or can be traditionally applied, the latter mainly**

**determined by local materials and technical means. In hot-arid regions the vault, the dome and the flat roof are the traditional roof shapes. The common construction method of today, a 10 to 15 cm exposed concrete is the worst possible solution, because the inner surface temperature can reach up to 60°C, which remains till late in the evening.**

**As the roof is the most critical part, high solar reflectivity and emissivity for long-wave radiation are essential, as well as thermal insulation and/or adequate time lag. Outside application of insulation is preferable for reasons mentioned earlier, but needs an additional, robust skin which protects the insulation from damage.**

**The rounded form of a hemispherical vault (dome) has a larger surface area than its base. Solar radiation is thus diluted and re-radiation during the evenings is also greatly facilitated. [ 9 ]**



**Fig 3/107 Example of dome and vault structures**

**The flat roof is practical in areas where it seldom rains. It is also a good reflector and re-radiates heat efficiently, especially if it consists of a solid, white painted material. (see Chapter 3.1.5, 3.2.5.2, 3.2.5.3) [ 13 ] High solid parapet walls along the edge of the roof can on the one hand provide daytime shade and privacy, but can have the disadvantage of creating an undesired stagnant pool of hot air. The construction and exact placement of parapet walls should therefore be carefully examined. [ 8 ]**

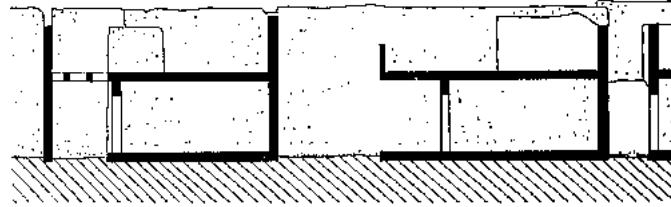


Fig 3/108

**A separate roof and ceiling are still today less common in hot-arid regions, whereas they are the obvious solution in warm-humid climates. This efficient, but expensive solution (pitched or flat ventilated double roof) contrasts with the traditional form of most desert buildings. However, the sloping roof with wall shading overhangs and a well-ventilated space between roof and ceiling appears to be an appropriate, contemporary solution. [ 147 ]**

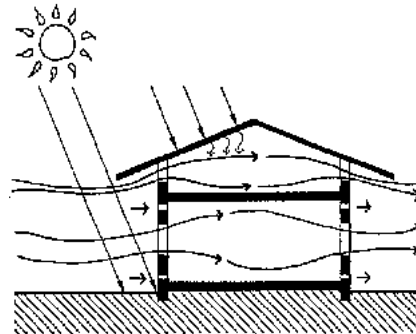
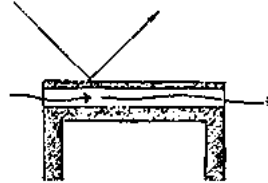


Fig 3/109

**If it is used, the material of the roof should be light and the ceiling material should be massive. The air enclosed in a double roof, or between the roof and ceiling, may reach a**

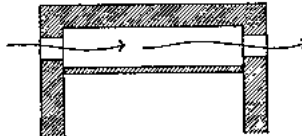


**very high temperature. This can be avoided by ample ventilation of the roof space by openings facing the prevailing breeze. In addition, roofs (slopes) should be orientated towards the prevailing breeze and any obstructions which would prevent the airflow next to the roof surfaces should be avoided.**



**Fig 3/110 Ventilated double roof with heavy ceiling**

**A somewhat less effective but also less expensive construction would be a simple ceiling with a ventilated roof space (also only common in warm-humid climate zones). A shaded, ventilated roof is applicable primarily over rooms used at night.**

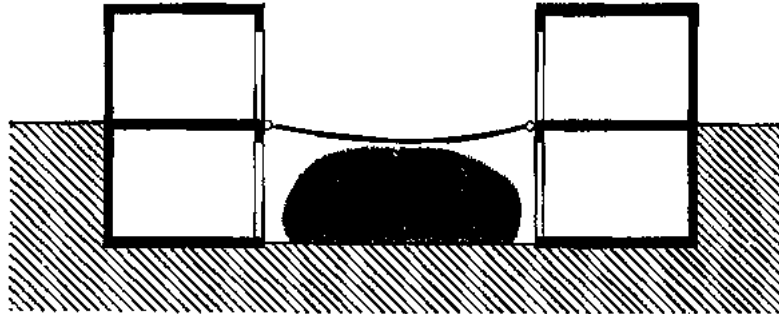


**Fig 3/111 Ventilated double roof with light ceiling**

**Sloped roofs could also provide cold airflow towards a courtyard. A membrane covering the courtyard in the daytime allows retention of cool air and provides shade, but needs attendance by the inhabitants.**

**The efficiency of the central courtyard is increased by stretching a curtain across the courtyard early in the morning during the summer months to trap the cool air. In the**

**evening, this is removed to maximize the night radiation potential. [ 106 ]**



**Fig 3/112**

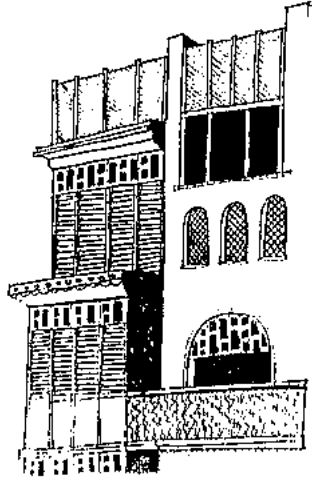
### **3.2.5 Special Topics**

#### **3.2.5.1 Shading devices (also see Chapter 3.1.5.1)**

**In hot-arid zones, shading of the direct sun's radiation and its reflection by surroundings is essential; diffuse radiation is less of a problem. Shading can be provided by different means, such as placing buildings closely together, the shape of the building itself (overhangs etc.), vegetation such as deciduous trees, or attached, special shading devices.**

**In hot maritime regions, the traditional "mashrabiyas" or "rowshans" are common. These projecting, screened (bay) windows or non-projecting screened windows consist mainly of wooden, shading screens over large openings and allow cross-ventilation as well as the passage of daylight while preserving family privacy. Some contain evaporative cooling means such as an earthenware water pot.**

**Similar devices can be designed by contemporary means (see Chapter 3.1.5.3).**



**Fig 3/113 Traditional screened windows (mashrabias and rowshans)**

### **3.2.5.2 Natural ventilation**

**(also see Chapter 3.1.5.2, 3.1.4.3 and 3.2.4.3)**

#### **Basic principles and concepts**

**Ventilation is essential and must be regulated to achieve the highest efficiency in keeping hot (and dusty) air out during the daytime, and cooling the thermal mass at night by air movement; if possible together with outside vegetation. Ventilation can only reduce temperatures higher than the outside air temperature. However, if the air is very dry, any breeze also helps to evaporate sweat and thus to cool the body. High rooms promote air circulation and increase the distance to a radiating ceiling. A low ventilation rate during**

**winter decreases the temperature variation and thus raises night temperatures. A high night ventilation rate in combination with an internal thermal storage capacity is preferable during summer.**

**During the daytime, openings should be closed and shaded and ventilation kept to the absolute minimum necessary for hygienic reasons. Openings should be placed according to the prevailing winds and allow cross-ventilation. Air intake openings should be located so that the coolest and most dust-free air is taken and, if necessary, the air can be conveyed to the points in the building where it is needed. Thus the cool conditions existing at dawn can be maintained inside the building for the longest possible period. Internal heat sources should, if possible, be isolated and separately ventilated.**

**Electric fans (ceiling mounted etc.) may be used where little or no air movement occurs. (see Chapter 3.1.5.3)**

**Windcatchers (also see Chapter 3.1.5.2)**

**Windcatchers are a significant feature in the traditional structures to ventilate and cool buildings in hot desert and hot, coastal regions. Wind pressure forces air down the wind catcher. Air circulation inside the building is achieved if there are openings on the opposite side allowing suction of inner air by lower pressure.**

**Depending to the region, they have a variety of forms, details and ways of functioning, and are known in the Middle East as "malqaf" and/or "badgir" [ 122, 149, 155 ]**

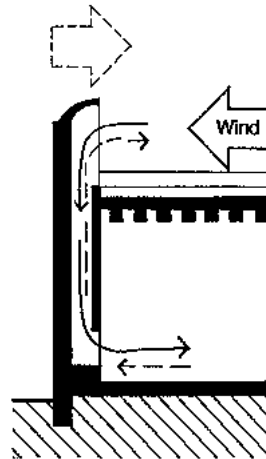
**a) Roof windcatcher**

**One kind of windcatcher (also called wind "chimney") is built onto the roof. In some places the catchers are unidirectional and orientated to catch favourable winds or are facing away from it to draw cool air from the court yard through rooms, and expel stale air**

**and smoke. By change of wind they are anticipated to reverse their function.**

**In other places pivoted scoops and multidirectional wind towers utilize winds from any direction. Generally, windtowers are square in plan and have four internal shafts.**

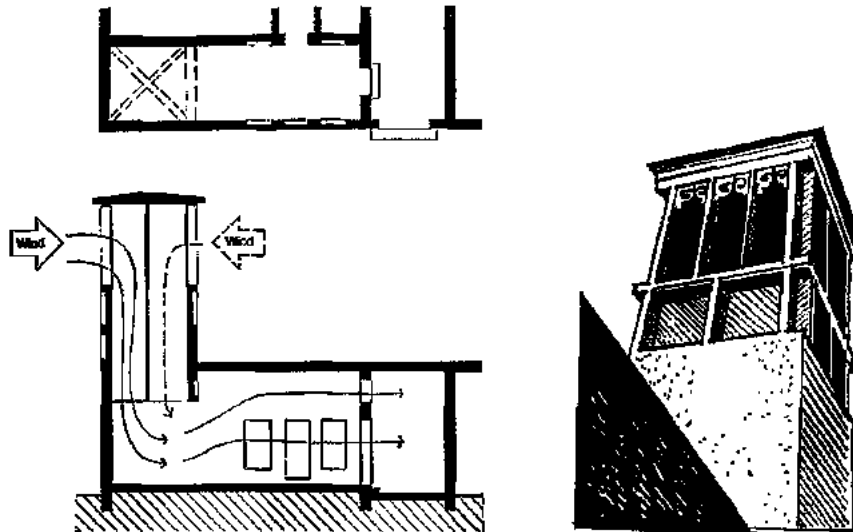
**The principle involved is to catch an unobstructed breeze at a high level and channel it to areas in the bottom parts of the building. The increased air-velocity supports perspiration and is thus cooling. The ducts are preferably built in a massive way to absorb the heat of the incoming air and not exposed to solar radiation (e.g. northern wall), to enhance efficiency. In addition they should be equipped with evaporative cooling means, such as porous water jugs, moist matting, wet charcoal etc., to achieve efficient cooling (also see Chapter 3.1.5.3).**



**Fig 3/114 Unidirectional roof windcatcher**

**The inlet of the catcher should have a shutter to regulate the air movement and to protect against too cold or too hot air and against sand. [ 9 ]**

**In the Middle East, wind catchers can provide sufficient ventilation and cooling during approximately six months of the year for comfortable inner climatic conditions of today's comfort requirements, without additional devices or the use of mechanical cooling or heating systems. [ 155-]**

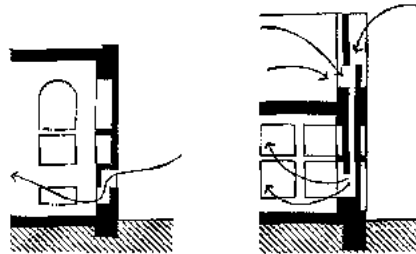


**Fig 3/115 Multi-directional roof windcatcher (-tower); plan, section and perspective view**

### **b) Mid-wall and parapet windcatchers**

**Structurally integrated wind catchers or scoops and air ducts are a special kind of vents**

and selective ventilators. A recessed, horizontal niche on the external wall, e.g. on the floor level and in the roof parapet, creates a slot between two vertical, structural posts. These mid-wall or parapet wind intakes or series of them may allow for enough cross-ventilation through the internal spaces in humid weather, while preserving visual privacy. Shutters are necessary to control the air movement. Vertical air shafts integrated into the wall provide air circulation within the building. [-155, 166-]



**Fig 3/116 Mid-wall and parapet windcatchers**

**Solar chimneys and induction vents(see chapter 3.1.5.2)**

These methods can also be applied in hot-arid regions.

### **Forced ventilation**

Electric ventilators or fans represent simple active devices. They may be placed directly in the outer wall or combined with an air duct system.

(also see Chapter 3.1.5.3)

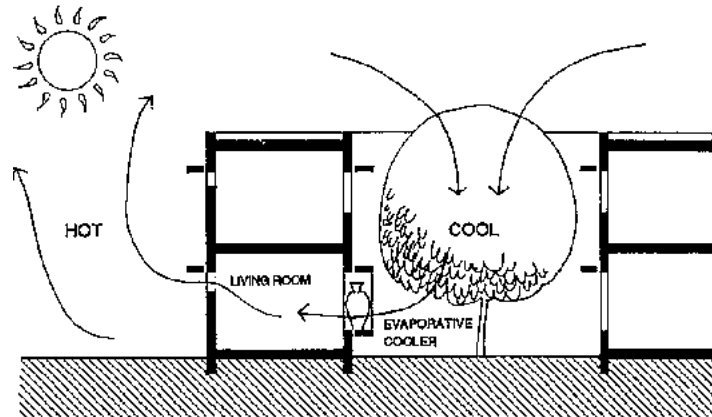
### **3.2.5.3 Passive cooling means**

(also see Chapter 3.1.5.3)

**Cooling means should be integrated into the general ventilation concept of a building.**

**Cooling can be achieved by the evaporation of water. The dryer the air, the greater is the cooling potential.**

**A courtyard house with a dry, hot yard and a cool yard with vegetation and a pool represents a good example of such a ventilation concept. A draft which passes through an evaporative cooler before entering the main rooms is created by the two yards.**

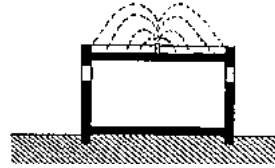


**Fig 3/117 Cooling system of a courtyard house**

### **External cooling**

**External cooling** External cooling through humidification can be achieved by keeping the surfaces of roofs and / or walls moist. (e.g. lawn sprinkler) The surface temperature can be reduced by up to 30°C. However, the water consumption is excessive.

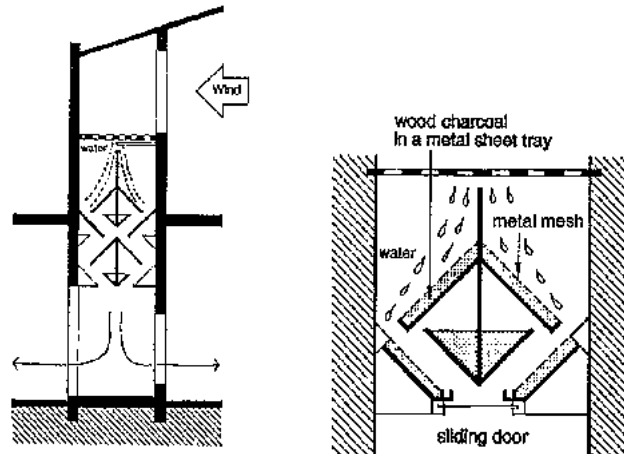




**Fig 3/118 Sprinklers on the roof**

### Evaporative coolers

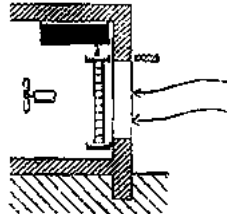
**Air cooling and humidification or simple air conditioning devices are important means of internal cooling. Warm and dry air passing over water is cooled by evaporating the water. Evaporative coolers have a limited effect and should only be used in relatively dry climates.**



**Fig 3/119 Evaporative cooler combined with a wind tower [-122 ]**

### a) Moist matting

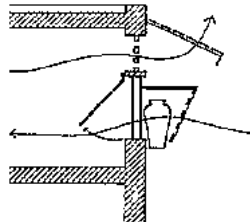
**An open weave matting of vegetable fibre (straw) is stretched on a wooden frame and is kept moist. The matting should be as fine as possible, placed in front of windows and in the path of the natural airflow. The natural airflow should not be reduced and can also be supported by a fan. The damp matting humidifies and cools the air as well as filters out the dust. [ 136 ]**



**Fig 3/120**

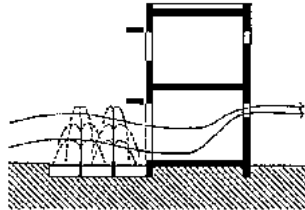
### b) Earthenware pots

**Another simple system entails the use of large, porous earthenware pots filled with water which seeps through the walls of the pot moistening the outside and, as it evaporates, cools the passing air. [ 9 ]**



**Fig 3/121****c) Wet charcoal and water pools**

**In wind catchers, beds of wet charcoal over which the air passes before entering the room, are sometimes used. The same principle can be applied by channelling breezes over pools or water sprays before they enter buildings. A spray pond is more effective than a still pool of the same size and has the additional advantage that the air is not only cooled, but also cleaned by binding the dust particles. Availability of water and maintenance aspects should not be neglected. [ 122 ]**

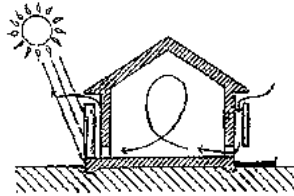
**Fig 3/122****Roof pond (also see Chapter 3.1.5.3)**

**A water body covering the roof functions similarly to a soil cover: it minimizes the diurnal temperature range. It is a technically demanding and expensive solution. It also requires the daily attention of the users and is not very suitable for hot-arid regions of the Third World.**

**Thermal walls and solar collectors (also see Chapter 3.1.5.3)**

**Solar walls are usually used to heat buildings and hence less suitable for hot-arid zones (see Chapter 3.4.5.3). They can, however, also be used as a cooling device.**

**A wall exposed to the sun can be built in the form of a solar collector and used to create a draft. The air warmed up by the solar collector creates a buoyancy which moves the air in the room. The air entering from there is cooled down by an absorber and perhaps additionally by an evaporative cooler.**



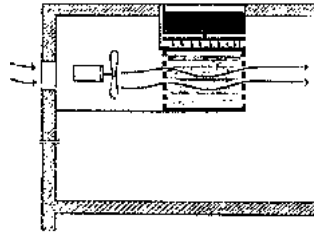
**Fig 3/123**

#### **3.2.5.4 Active devices (see Chapter 3.1.5.4)**

**Active devices, such as air conditioners, are often unavoidable and require a different building construction. Many passive means of climatization, however, are also beneficial in that they drastically reduce running costs. With the increased possibilities for using solar energy, active devices may become the means of the future.**

#### **Heating**

**In certain regions, particularly on higher altitudes, heating might be necessary in winter.  
(see Chapter 3.4.5.3)**



**Fig. 3/124**

### **3.3 Design for warm-humid zones**

#### **The main points**

- **Provide maximum ventilation and free air movement by large openings.**
- **Provide maximum shading of direct and diffuse solar radiation.**
- **Avoid heat storage.**
- **Use reflective outer surfaces.**
- **Use ventilated double roofs.**
- **Use vegetation to moderate the solar impact.**

#### **3.3.1 Climate and design in general (also see Chapter 3.1, General Guidelines)**

##### **Climatic conditions**

**The climate of warm-humid zones is characterized by high rainfall and high humidity. The temperature range is relatively high at around 30 - 35°C and is fairly even during the day and throughout the year. Due to minimal temperature differences, winds are light or even non-existent for longer periods. However, heavy precipitation and storms occur frequently.**

**(also see Chapter 2.2).**

### **Design objectives and response**

**The solar radiation is intense and to a great extent diffuse due to haze. It therefore demands generous shading devices. The haze may cause sky glare which can also be reduced by large shading devices.**

**Vegetation is rich and provides an excellent means of improving the climatic conditions. Its surface does not heat up and it provides efficient shading at low cost. However, it has to be arranged in a way that does not impede air circulation.**

**The principle of heat regulating measures by thermal mass and heat storage is not applicable for this climate, because the temperature difference between day and night is minimal. The designer is limited to measures which avoid heat absorption and heat storage. The use of low thermal mass, high reflective outer surfaces or double-skin structures are the result.**

**The indoor temperature can hardly be kept much below the outdoor temperature. However, by efficient design the indoor temperature can avoid exceeding the outdoor temperature and inner surfaces can remain relatively cool. Together with proper ventilation, comfortable conditions can be achieved in most cases.**

**Existing air movements should be utilized as much as possible to provide evaporative cooling and to avoid mould growth.**

### **3.3.2 Settlement Planning (also see Chapter 3.1.2)**

#### **The main points**

- **Topographical location with maximum air velocity and shade.**
- **Orientation to minimize sun radiation impact.**
- **Orientation to maximize natural ventilation by winds.**
- **Scattered pattern of buildings.**
- **Hazards, mainly floods and storms, to be considered.**

### **3.3.2.1 Topographical location of settlements**

#### **Sun orientation**

**Settlements should be placed preferably on southern or northern slopes, ideally facing away from the equator. The warm-humid climate zones are generally located near the equator. As a consequence, east and west slopes receive more radiation compared to north and south slopes and are, therefore, disadvantageous. (see Chapter 3.1.5 and 3.2.2.1)**

#### **Wind orientation**

**Ideal sites are windward slopes near the crest or near the beach, where regular winds exist. The ventilation effect of winds can be improved by effective arrangement of vegetation. (see Chapter 3.1.5.2 and 3.2.2.1).**

### **3.3.2.2 Hazards**

**Although the wind velocity is generally low, occasional storms (hurricanes) can occur. Therefore, a firm structure is required. Floods are common in lowland locations and have to be kept in mind.**

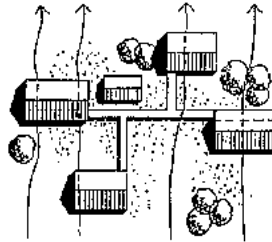
### **3.3.2.3 Urban forms and external space**

**An open settlement pattern is the appropriate response to the climate.**

**To provide sufficient air circulation, buildings should be scattered and have a low population density.**

**Buildings should be separated with large, free spaces between them. This allows airflow which provides ventilation for cooling and a hygienic environment.**

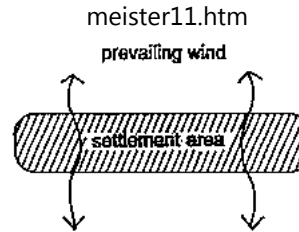
**On the other hand, the walking distance to public spaces should be minimal and the footpaths shaded.**



**Fig. 3/125**

**Groups of buildings should not be built in too compact a manner. Extended settlements, arranged in a line across the prevailing wind direction give low resistance to air movement and are, therefore, the ideal solution.**





**Fig 3/126**

**In cases where settlements consist of several rows of buildings, the houses should be staggered to avoid windshaded buildings in the downwind rows. (also see Chapter 3.1.5.2)**

### **Settlement pattern, street network**

**The settlement pattern should allow for a loose open street network.**

**External public spaces, streets, squares and footpaths should be protected from sun and rain.**

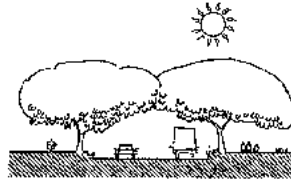
**Squares and passages should be covered, but cross-ventilation should not be impeded. Generous and well distributed areas of vegetation help to improve the microclimate.**

**Street spaces should be long and straight to facilitate air movement and lined by high, shade-providing trees.**

**Street space formed by trees  
(also see Chapter 3.1.2.3)**

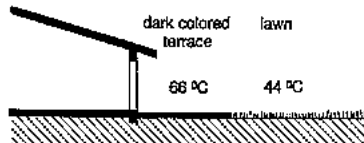
**Certain species of trees (e.g. rain trees) form an extraordinary outdoor space by creating a canopy effect. They should not be planted too far from each other, so that the crowns form**

**a wide hall-like space, creating a comfortable microclimate.**



**Fig 3/127 "Canopy effect" by trees**

**Landscaping with vegetation** An unshaded pavement exposed to the sun heats up and can reach very high temperatures. A vegetal cover of the ground, however, keeps it comparatively cool and contributes much to a cooler outdoor microclimate. (also see Fig 3/94 in Chapter 3.2.2.3)



**Fig 3/128**

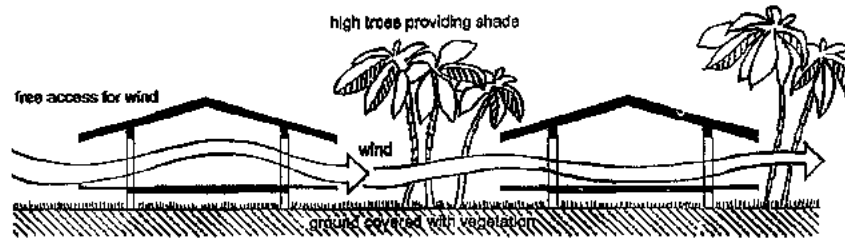
### **Landscaping with vegetation**

**An unshaded pavements should be avoided as far as possible and air should not be allowed to pass over such hot surfaces before reaching buildings.**

**High trees with wide, shading crowns provide significant protection from solar radiation and should be incorporated as much as possible into any landscape planning.**

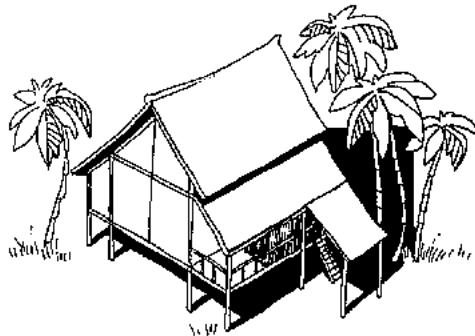
**High bushes, however, should be avoided near buildings because the space between the**

**ground vegetation and the high crowns of the trees should remain open, providing free access for the wind at the level of the living spaces.**



**Fig 3/129**

**In dense settlements it is difficult to provide privacy as well as allowing the free flow of air. Various systems of paling fences and screen walls have been devised consisting of louvred or overlapping timber boards or planks. They do not permit a direct view and allow breezes to penetrate, but reduce the air velocity quite substantially. A suitably spaced, scattered settlement pattern helps to avoid fences, yet provides privacy.**



## **Fig 3/130 Example of a Malay house**

### **3.3.3 Building design (also see Chapter 3.1.3)**

#### **The main points**

- **The main elevations and rooms should be placed facing north and south and towards the prevailing wind.**
- **The form should be spread out.**
- **Provide generous shade for direct and diffused radiation.**
- **Provide effective cross ventilation.**

#### **3.3.3.1 Orientation of buildings**

##### **Sun orientation**

**Shading of the east and west elevations is difficult because of the low sun, and may require special devices; whereas the south and north sides can easily be protected by an overhanging roof.**

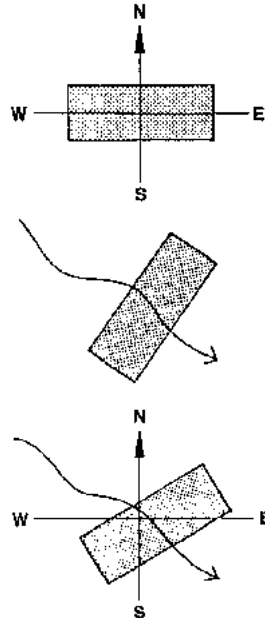
**Thus the best orientation for protection from the sun is along the east-west axis.**

##### **Wind orientation**

**Where a predominant wind direction can clearly be identified, long-shaped buildings should be arranged across this direction.**

## Compromise

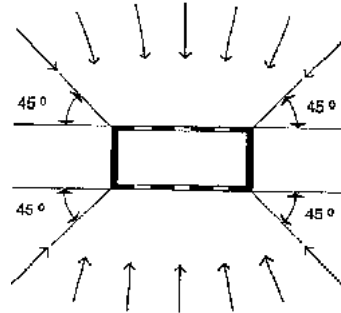
**Often the above two parameters are contradictory. In this case, a reasonable compromise should be made based on a detailed analysis of the specific situation, considering the possibilities for diverting the wind direction by means of vegetation and structural arrangements, such as parapet walls within the external adjoining space.**



**Fig 3/131 Optimization of the orientation**

**As a general rule, with low rise buildings, where the walls would not receive much**

**radiation, orientation according to the wind direction is more advisable. With high-rise buildings the opposite holds true and protection from sun radiation should be the decisive factor.**



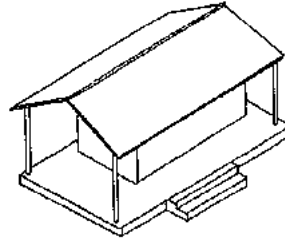
**Fig 3/132 Acceptable wind directions for the orientation that is best for sun**

### **3.3.3.2 Shape and volume**

**Forms with large surface areas are preferred to compact buildings. This favours ventilation and heat emission at nighttime.**

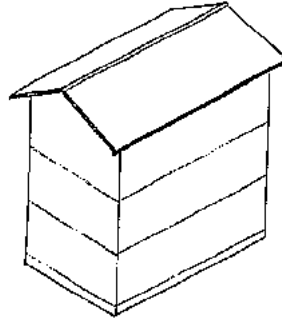
### **3.3.3.3 Type and form of buildings**

**The main goal is the reduction of direct heat gain by radiation through openings and of the internal surface temperature. The building should therefore be designed not only with protected openings, but also with protected walls. This task will be much easier if the building is kept low. In addition, the roof should extend far beyond the line of walls, with broad overhanging eaves and other means of shading.**



**Fig 3/133 Low building with wide overhanging roof**

**The height of the buildings should, in general, not exceed 3-storys. Higher buildings receive too much radiant heat and give wind obstruction to neighbouring buildings.**



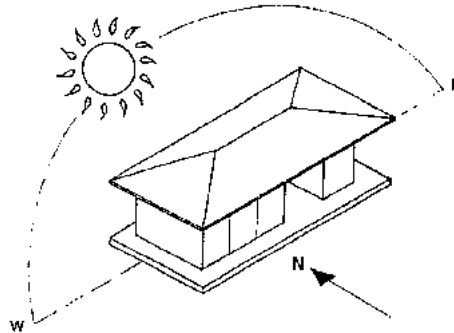
**Fig 3/134 Building height not exceeding 3 storys**

**Optimal shading**

**The intense diffuse solar radiation calls for buildings that have large overhanging roofs and wide shaded verandahs.**

**Row houses elongated along the east-west axis provide the best shading of the critical east and west walls.**

**These critical east and west walls are best protected if the house is covered with a hipped roof.**

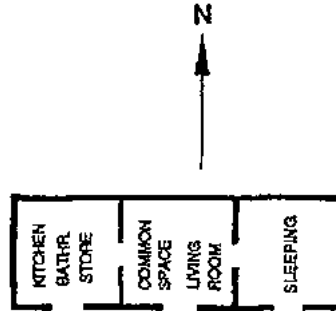


**Fig 3/135 Row house with hipped roof, elongated in E-W direction, provide the best shading**

### **Room arrangements**

**The arrangement of rooms depends on their function. Since the thermal load is related to the orientation, rooms on the east side are warm in the morning and, if not built with much thermal mass, cool down in the afternoon. Rooms on the west side are cooler in the morning and heat up in the afternoon. Rooms facing north and south remain relatively cool if provided with adequate shading. Thus, the rooms can be arranged according to their functions and according to the time of the day they are in use.**





**Fig 3/136 Room arrangement according to climatic preferences**

**It may not always be possible to arrange all the main rooms in an ideal manner. In this case, special care must be taken for the disadvantaged rooms.**

### **Bedrooms**

**Bedrooms can be adequately located on the east side, where it is coolest in the evening. Good cross-ventilation is especially important for these rooms because, at rest, the human body is more sensitive to climate. On the other hand, stores and other auxiliary spaces can be located on the west side.**

### **Kitchen**

**Provided the kitchen is mainly used during morning and midday hours, it can be located on the west side as well.**

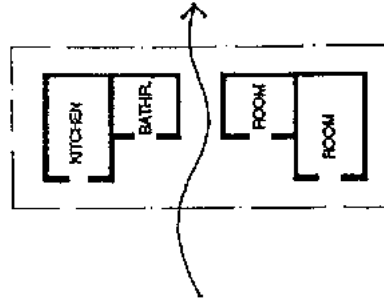
### **Main room**

**The main rooms which are in use most times of the day, such as living rooms, should not**

**be located on the east or west side.**

### **Rooms with internal heat load**

**Rooms where internal heat occurs, such as kitchens, should be detached from the main building, although they can be connected by a common roof.**



**Fig 3/137 Arrangement of detached kitchen and bathroom**

### **Wet rooms**

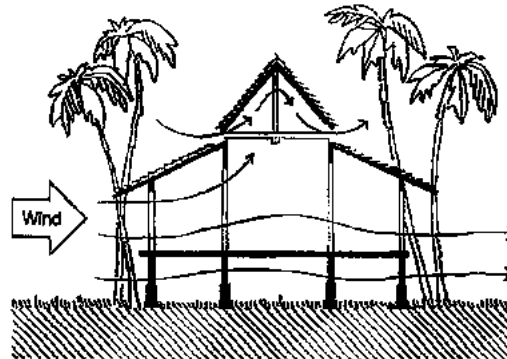
**Special attention should be given to the arrangement of rooms with a high humidity (bathrooms). Here a proper cross-ventilation is especially important to avoid mould growth.**

### **Cross-ventilation**

**The high humidity and warm temperatures require maximum ventilation, which leads to very open buildings. This is valid not only for the design of the elevations, but also for the floor plan.**

**Free passage of air for cross-ventilation through the interior is important. This can be achieved by large openings, not only in the outer walls but also in the internal partitions. An even more efficient solution is that of single-banked rooms with access from open verandahs or galleries.**

**The floor is preferably elevated above the ground to allow for a better ventilation. Houses are best built on stilts or at least on raised platforms.**



**Fig 3/138 The main elements: Shading trees, wide overhanging roof, raised floor, free flow of air through the building**

#### **3.3.3.4 Immediate external space**

**The same principles of maximum shading and maximum ventilation also apply to the design of the outdoor space. Tall shading trees and reduced ground vegetation are important elements.**

**(also see Chapter 3.1.3.4 and 3.3.2.3)**

### **3.3.4 Building components (also see Chapter 3.1.4)**

#### **The main points**

- **Heat storage and time lag should be minimal.**
- **Thermal insulation is not effective except on surfaces exposed to direct radiation.**
- **Materials should be permeable to air.**
- **Reflectivity and emissivity are important.**

**Due to the relatively narrow diurnal temperature fluctuation it is not possible to achieve much cooling by utilization of the thermodynamic properties of building components. The main goal is, on the one hand to store as little heat as possible in the structure in order to obtain the maximum benefit of the cooler night temperatures.**

**On the other hand, maximum ventilation throughout the day enables cooling by perspiration.**

**A third important point is the reduction of radiation and its reflection, by which is meant direct and diffuse solar radiation as well as radiation by the surface of heated-up parts of the building and the surroundings.**

#### **Heat storage and time lag**

**Constructions with a high thermal storage capacity and a long time lag are to be avoided. It would cause undesirable re-radiation of heat at night. Due to the high relative humidity, problems of condensation could also appear in the morning hours because the surfaces would be somewhat cooler than the air.**

**As an exception, in buildings used in the daytime only, a certain heat storage capacity may**

**be advantageous. Depending on the diurnal temperature differences, a reduction of the daytime indoor temperature by a few degrees may be possible. A relatively short time lag of some 5 hours may be adequate.**

### **Thermal insulation**

**Thermal insulation has very little effectiveness. Due to the free flow of air, the ambient air temperatures inside and outside the building are very much the same. Insulation may be justified only in places where sun radiation is received, e.g. for roofs and sun-exposed walls. The use of reflective materials and surfaces is, however, more important. These measures keep the temperature of the inner surface low. The same effect can be achieved with properly ventilated double skin constructions.**

### **Reflectivity and emissivity**

**High reflectivity and high emissivity are required properties for keeping the indoor temperature and the inner surface temperature low.**

**(Building materials, properties and suitability see Chapter 3.1.4)**

#### **3.3.4.1 Foundations, basements and floors (also see Chapter 3.1.4.1)**

**Direct contact with the ground does not necessarily provide cooling because the temperature of the shaded surface is about equal to the mean air temperature. A certain cooling may only be possible by conduction for barefooted persons or persons sitting on the floor.**

**As a consequence, it is better to raise the floor and ventilate the space underneath. The floor should be of low thermal capacity (e.g. timber floor with void). The advantages are better ventilation due to the elevated space and maximum benefit of the slightly lower**

**night temperature.**

#### **3.3.4.2 Walls**

**(also see Chapter 3.1.4.2)**

**Walls, both external and internal, should be as light as possible with a minimal heat storage capacity. These should obstruct the airflow as little as possible and should reflect radiation, at least in places where solar radiation strikes the surfaces.**

**The outer surface should be reflective, light colored.**

**Walls should be shaded as much as possible. If, however, exposed to the sun, they should be built in the form of a ventilated double leaf construction, the inner leaf having a reflective surface on its outer side and perhaps with thermal insulation.**

**Light and thin materials such as timber or, even better, bamboo matting are recommended. Other materials forming light panels can be used, together with a frame structure to take care of the structural requirements.**

**(also see Chapter 3.1.4.2)**

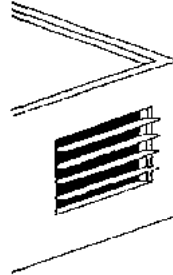
#### **3.3.4.3 Openings and windows**

**(also see Chapter 3.1.4.3)**

##### **Design and placement**

**In warm humid areas openings are important elements for the regulation of the indoor climate. They should be large and fully openable, with inlets of a similar size on both sides of the room allowing a proper cross-ventilation. Windows are preferably equipped with flexible louvres allowing a regulation of ventilation. Door shutters may also incorporate louvres or grills. Windows with fixed glass panes are of no advantage and should be**

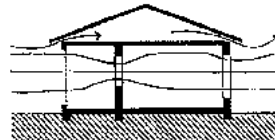
**avoided.**



**Fig 3/139 Window with glass louvres**

**To avoid direct solar radiation and glare, openings should be shaded by an overhanging roof, screens, lattices, grills etc.**

**All these measures have to be designed to give minimal resistance to the airflow. Mosquito-screens, which are essential in these regions, but reduce the airflow considerably, are therefore best installed away from windows, e.g. around the verandah or balcony.**



**Fig 3/140 Large openings and screened-in porches.**

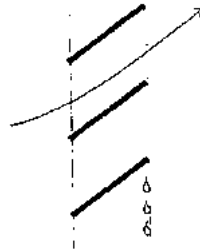
**Openings should be placed according to the prevailing breezes, so as to permit a natural airflow through the internal space. This airflow is most effective if concentrated at body**

**level.**

### **Louvre design**

**A difficult problem is the design of large openings which at the same time protect from driving rain.**

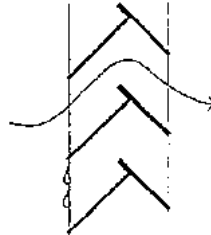
**Ordinary louvres direct the wind upwards above body level. Furthermore they are not safe against driving rain.**



**Fig 3/141 Ordinary louvres**

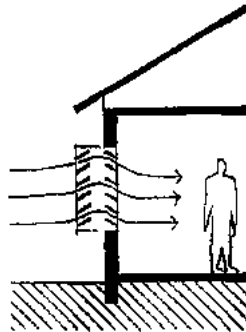
**Modified louvres keep the wind at lower level (living area) and provide protection from driving rain, but reduce the airflow to a certain extent.**





**Fig 3/142 Modified louvres**

**Another alternative is the use of a second set of louvres to direct the air down to the occupants.**



**Fig 3/143**

### **3.3.4.4 Roofs (also see Chapter 3.1.4.4)**

#### **Design**

**In warm-humid areas the roof is preferably pitched to allow heavy rains to run off.**

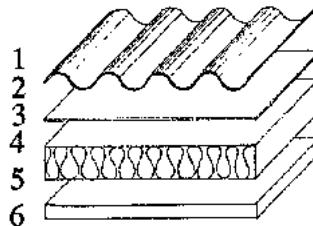
**Large overhangs protect the walls and openings from radiation and precipitation.**

### **Single leaf construction**

**The roof should be made of lightweight materials with a low thermal capacity and high reflectivity. Metallic and light colored surfaces have the best reflective capacity (see data in Appendix 5.1 ). Painting the surface in light colors, e.g. a yearly applied coat of whitewash, is an economical method to increase reflectivity. However, in most cases a single leaf construction will not satisfy the comfort requirements.**

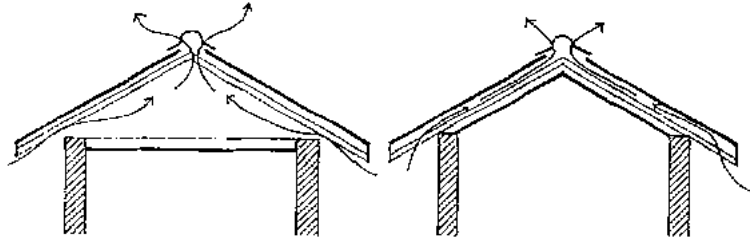
### **Ventilated double roof**

**A more efficient solution is the properly ventilated double roof. The inner layer (ceiling) may be well insulated and provided with a reflective upper surface. The inner surface of the ceiling should not exceed the air temperature by more than 4°C. This can be achieved by an insulation board with a U-value of about 1.5-W/m<sup>2</sup>. Where such materials are not available or cannot be afforded, even the cheapest kind of ceiling would provide a substantial improvement.**



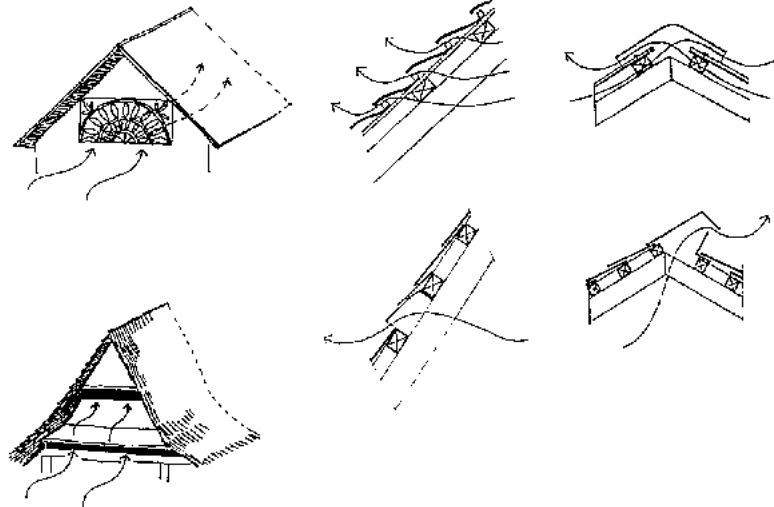
**Fig 3/144 Suitable double leaf construction**

**A simple example can illustrate this effect. In two identical houses, roofed with corrugated asbestos sheets and with an outdoor temperature of 22°C, a difference of 14°C in the ceiling surface temperatures was monitored. In the first case where there was no ceiling, the temperature was 48°C; in the second case where there was a paper ceiling lined with aluminium on the upper surface, the temperature was 34°C. [ 8 ]**



**Fig 3/145 Placement of ceiling horizontally or along the roof slope**

**Air which has passed through a double roof space should not be allowed to enter the living zone (e.g. discharged towards a verandah), as this air will be much hotter than the normal outdoor air. (also see Chapter 3.1.4.4)**



**Fig 3/146 Construction details showing enhanced ventilation of the roof space**

### **3.3.5 Special topics**

#### **3.3.5.1 Shading devices (also see Chapter 3.1.5.1)**

**Although the intensity of radiation is normally less than in hot-dry regions, it is nevertheless a significant source of heat, therefore its entry into the building should be prevented. In hot-dry climates the radiation is mostly directional and the shadow angles can be established with a high degree of accuracy. Here, due to the moisture in the air, much of the radiation is diffuse, coming from the whole of the sky.**

**Shading devices should therefore provide great coverage, obstructing most of the sky and**

**not just the sun. Furthermore, the openings should be far larger than in hot-dry climates. This is another reason why the shading devices should be much larger.**

### **Shadings with vegetation**

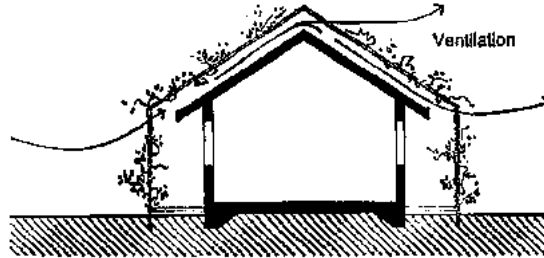
**The proper arrangement of vegetation, mainly of shade-providing trees, within the surrounding space is an important aspect for the improvement of the indoor climate. (see Chapter 3.3.2)**

**Another efficient solution is to grow a green cover over roofs and walls. This cover functions as a second skin which provides**

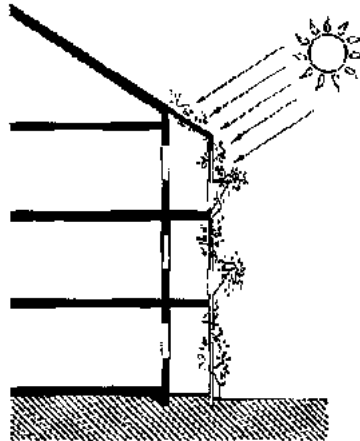
- **protection against solar radiant heat,**
- **cooling by a ventilated space between green cover and wall or roof,**
- **reduction of glare,**
- **reduction of noise, by sound absorption,**
- **reduction of dust, by filtering the air,**
- **stabilization of the microclimate,**
- **protection of the wall and roof surfaces from wind and driving rain,**
- **a regulating effect on humidity**

**A disadvantage may be a certain increase in unwanted insects. But since openings should in any case be protected by screens, this may not cause a problem.**

**Tile roofs and similar “soft” roofing materials may be destructed by certain plant species. In this case, the plants have to be selected carefully. Species with too aggressive root systems like certain Ficuses should be avoided. In dry locations plants should be selected which can acclimatize and stand dry spells.**



**Fig 3/147 Green cover on roofs and walls**



**Fig 3/148 Green cover on balconies of multistory buildings**

**3.3.5.2 Natural ventilation,  
(also see Chapter 3.1.5.2)**

## **Basic principles and concepts**

**Efficient air circulation is one of the few possibilities for natural climatization in warm-humid zones. Because of the minimal temperature differences it can hardly be utilized to cool down the building components, but cooling is felt through the increased perspiration of the human body. However, this effect is only felt if the air is not fully saturated with humidity.**

**The flow of air can be influenced by topographical features, by the orientation of the building and by the position of surrounding buildings and other obstructions. Such obstructions may be built intentionally to divert the wind in a desired direction (see Chapter 3.1.5.2).**

**In this climate there is a need for both a frequent change of air and for an air movement across the body surface.**

### **Air change**

**An exchange of air is also necessary because without it, both the temperature and the atmospheric humidity in the room will quickly increase above the values outside, due both to the heat and moisture output of human bodies and to various activities such as washing, cooking etc.**

### **Electric fans**

**A simple active device for the improvement of the indoor climate may be the use of electric fans (see Chapter 3.1.5.4)**

**3.3.5.3 Passive cooling means  
(also see Chapter 3.1.5.3 and 3.2.5.3)**

## **Evaporative coolers**

**The possibilities for evaporative cooling in humid regions are limited. The potential of the air to absorb humidity, and with it the potential for cooling is minor.**

**In island climates, however, where the peak temperature is combined with approximately 65% relative humidity, methods of evaporative cooling are possible, although the efficiency is less than that in hot-arid climates.**

**Here, only indirect cooling using a heat exchanger is possible because in humid areas the relative humidity of the indoor air must not be further increased. (also see Chapter 3.1.5.3)**

### **3.4 Design for temperate and upland zones**

**The main points:**

- **Keep a balance between conflicting requirements.**
- **Seek solar radiation gain in winter and provide shading in summer**
- **Provide wind protection in winter and proper ventilation in summer**
- **Construct "good-natured" houses, with moderate heat storage capacity.**
- **Use medium sized windows**

#### **3.4.1 Climate and design in general (also see Chapter 3.1, General guidelines)**

##### **Climatic conditions**

**The temperate and upland climate is characterized by three seasons. A hot and dry season, usually the longest period, is followed by a wet and warm season, the monsoon period. In**



**the third season, the winter time, depending on the altitude, temperatures can drop far below the comfort level, especially at night, whereas daytime temperatures are moderate and the solar radiation intense. (also see Chapter 2.2)**

### **Design objectives and response**

**This type of climate is the most complex one from the designer's point of view.**

**Buildings must satisfy conflicting needs of hot-dry and warm-humid periods. Rules given in the respective previous chapters are hence partly applicable also in the temperate zone. In addition, in the upland areas, the designer must consider the principles of heat conservation and solar heat gain, and sometimes active heating as well.**

**As a consequence, solutions are often a compromise between these conflicting needs. Where incompatible needs arise, a careful analysis of the length and relative severity of seasons is required to find a balanced design.**

### **"Good-natured" buildings**

**Buildings should be of "good-natured". They have to provide comfort in spite of climatic conditions which differ strongly with the seasons and in spite of sudden weather changes. They should not cool down too much during the cold nights and should not overheat during periods of strong radiant heat gain.**

**A moderate amount of thermal mass, together with moderately-sized openings and sufficient thermal insulation properties will provide acceptable conditions for the major part of the time.**

### **3.4.2 Settlement Planning (also see Chapter 3.1.2)**

## **The main points**

- **Topography, south sloping preferred.**
- **Orientation, so as to benefit from the winter sun.**
- **Protection from winter winds.**
- **Form, semi-compact.**
- **Hazards, floods, landslides and falling rocks must be considered.**

## **Basic considerations**

**With conflicting seasonal requirements, different solutions may be equally appropriate. The advantages and disadvantages should be weighed together, considering not the extreme, but the prevailing climatic conditions. Buildings can be arranged rather freely. Settlements should be semi-compact to provide mutual shelter from wind in the cold season but also to take advantage of the sun radiation.**

**Nevertheless, the prevailing breezes in humid and hot seasons should not be cut off and sufficient shade should be provided.**

### **3.4.2.1 Topographical location of settlements**

#### **Sun and wind orientation**

**In lowland regions settlements should be exposed to the wind and protected from the sun. In winter the opposite is required: Exposure to the sun and protection from the wind.**

**In upland regions, shelter against the wind and orientation for maximum solar radiation gain are required all the year round. Sites oriented south-southeast and located in the middle or the lower middle of a slope are preferred. Here solar gain is best. Excessive wind effects as well as cool air pools should be avoided. The layout of town structures**

should follow the same goal of sheltering against winds and utilizing the effects of the sun's heat.

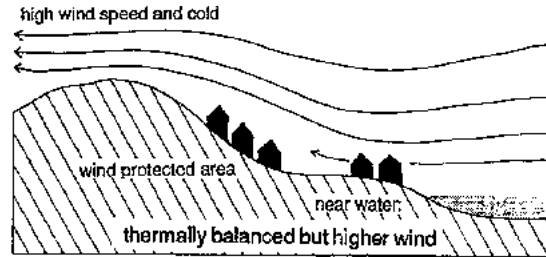


Fig 3/149

Especially in areas of intensive land use buildings should be located on south slopes, where the sun exposure is adequate.

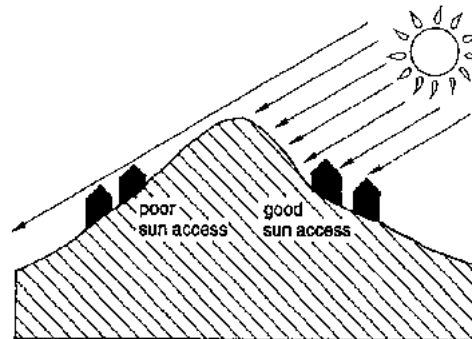
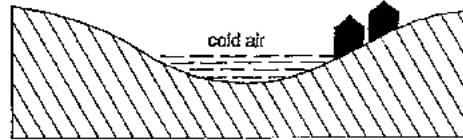


Fig 3/150

Depressions should be avoided because cold air accumulates there. Above the bottom of

**the valley the microclimate is more favourable.**



**Fig 3/151**

**Houses should be located behind a wind shield, but be assured of exposure to the sun. This shield can be formed by existing or newly planted vegetation, by other structures or by topography.**

**To achieve a desired ventilation effect by vegetation, see Chapter 3.1.5.2.**

### **Shading mountains**

**In upland areas, there are naturally often high surrounding mountains shading the building sites, especially during winter when the sun is low; on the other hand, the need for warmth is greatest. When selecting a site, therefore, the horizon of the surrounding mountains together with the sun's path should be studied carefully.**

### **3.4.2.2 Hazards**

**In this region, floods, storms and earthquakes often have to be considered, too. In mountainous regions, landslides and rockfalls require special attention.**

### **3.4.2.3 Urban forms and external space**

#### **Settlement pattern**

**Aspects of proper sun orientation and wind protection should already be considered while working out the basic pattern of a settlement. This pattern should be of a semi-compact type.**

**The plot dimensions should allow the positioning of a building with its wider side facing south and sufficient distance from the neighbouring buildings. Provision for row buildings along the east-west axis may also be favoured.**

### **Streets**

**Streets are best planned in the direction of summer winds, avoiding the direction of winter winds.**

### **Public external space design**

**The outdoor space - as in all warm regions - should be actively used. It should be planned to provide a well-balanced mix of open, sunny areas for the cold season and shaded, well-ventilated areas for the warm period.**

### **Deciduous plants**

**Open squares with groups of trees to provide shade are desirable. Planting of deciduous trees and pergolas with deciduous creepers are a possibility.**

### **Traditional examples**

**An analysis of traditional settlements provides valuable hints for appropriate solutions.**

**A good example is Bhumra, a village in the higher hilly region of West Nepal. This settlement also provides efficient wind protection and takes full advantage of the sun's radiation. Flat roofs are actively used as outdoor living and working spaces, where**

**favourable climatic conditions prevail during the daytime.**

### **3.4.3 Building design**

#### **The main points**

- **Orientation and room placement should be south facing.**
- **Form depends on precipitation pattern.**
- **Shade in summer and heat gain in winter is necessary.**
- **Ventilation must be controllable.**

#### **3.4.3.1 Orientation of buildings (also see Chapter 3.1.3.1)**

##### **Sun orientation**

**The orientation of the building greatly influences the solar heat gain; it should thus be carefully considered. Normally, buildings should have an elongated shape along the east-west axis. The southern front can easily be designed for proper utilization of the winter sun and for protection against the summer sun. Windows on the eastern side receive substantial heat during the morning, which may be highly appreciated in winter time. Usually, larger windows on the west side are to be avoided, as the solar heat gain through these would coincide with the highest air temperatures.**

**To achieve a proper sun penetration for natural lighting, solar heat gain and hygiene, the depth of the interior should not be excessive.**

##### **Wind orientation**

**Buildings should be arranged so that they benefit from summer winds because this season**

**is usually humid and a proper cross-ventilation is required for cooling and hygienic reasons (prevention of mould growth). Shelter should be provided from the winter winds.**

### **3.4.3.2 Shape and volume (also see Chapter 3.1.3.2)**

**Buildings are preferably rather compact. However, because of the conflicting climatic conditions, several solutions are possible, depending on local topographical conditions and functional requirements.**

#### **Requirements in upland regions**

**In upland areas, heating in winter becomes more important than cooling in summer. Hence, rather compact structures with minimal but proper sun-oriented exterior surfaces are desirable.**

**Buildings may be large and grouped close together. Row houses or adjoining buildings have the advantage of reduced heat loss.**

**Courtyard buildings with proper wind protection are a suitable solution.**

**The houses of Marpha, a village in the mountains of northern Nepal with a dry, cold and extremely windy climate, represent a good example.**



**Fig 3/153 Schematic layout of a house in Marpha, Nepal****3.4.3.3 Type and form of buildings  
(also see Chapter 3.1.3.3)****Room arrangements**

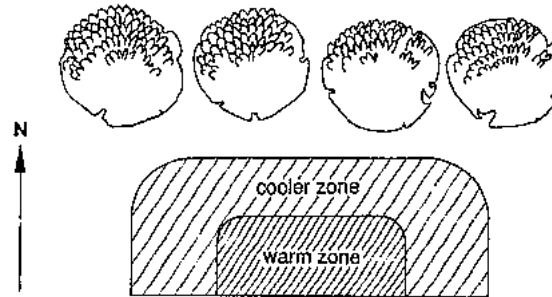
**A moderately compact internal room arrangement is of benefit for most of the year. Courtyard buildings are suitable, terraced buildings facing south may also be appropriate. In cooler areas, exposure of the main rooms to the winter sun is essential, whereas in warmer areas these rooms can also be placed north facing.**

**The concept of thermal zones**

**Heat losses can be efficiently reduced by dividing the house into zones with higher and lower heat demands, according to their functions. The zone with the higher heat demand, such as living rooms, is placed facing towards the sun (south). The zones with less heat requirements, e.g. sleeping areas, kitchen, stores, entrance etc., are arranged around the warm zone on the west, north and east side, providing protection against heat loss and wind. This zone functions as a thermal buffer. An external belt of vegetation or other adjoining buildings and parapet walls may provide additional protection.**

**This concept applies in the colder areas only.**





**Fig 3/154 Thermal zone layout for cold zones**

### **Ventilation in warm zones**

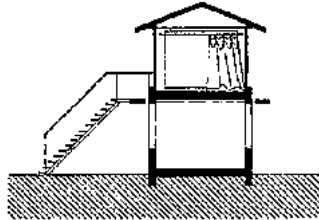
**In the warmer areas, humidity can cause problems during the monsoon period, Hence, arrangements for a proper cross-ventilation are necessary. The separation of humidity-producing areas such as kitchen and bathrooms from the rest of the building is recommended.**

### **Building components for different seasons**

**In this type of climate, it would seem reasonable, to conceive one part of the building for the cold period and another one for the warm period.**

**One solution would be a building type which is also useful in hot-dry and maritime areas, consisting of a ground floor with massive walls and an upper floor of a light structure . The ground floor would be relatively cool in the daytime and relatively warm at night. The light structure on the upper floor would perform the opposite way. As a consequence, in the winter time the inhabitants would use the upper floor in the daytime and the ground floor at night. In the summer time the pattern would be reversed.**

**(see Chapter 3.2.3.3)**



**Fig 3/155**

**It would even be possible to use different sites in different climatic regions - a warm one in winter and a cool one in summer - and to migrate from one place to the other.**

### **Economic limitation**

**In reality, however, for both economical and organizational reasons, such day and night rooms or summer and winter houses are often not feasible, and a building or room has to be designed to serve all year round. The large range of thermal conditions requires the utilization of radiation and wind effects, as well as protection from them. Hence, the arrangements have to play a dual role.**

### **3.4.3.4 Immediate external space (also see Chapter 3.1.3.4)**

**The outdoor space should also be designed as a compromise with ventilation and shade in summer, and wind protection and solar radiation gain in winter. The vegetation should be planned accordingly, to provide partly sunny and partly shaded spaces. Deciduous trees are an excellent medium with which to achieve this goal.**

**(also see Chapter 3.1.3.4)**

### **3.4.4 Building components (also see Chapter 3.1.4)**

#### **The main points**

- **Medium heat storage capacity and time lag is required.**
- **Thermal insulation is needed in upland areas.**
- **Reflectivity and emissivity is less important.**

#### **Thermal storage and time lag**

**Heat accumulated during the daytime should be stored by an adequate thermal capacity of the walls, ceilings and floors to balance the temperature. A properly dimensioned thermal mass means that rooms do not overheat during days with high temperature and high solar radiation gain, and do not cool out too much at night, or even during the following cooler day.**

**The retention of nighttime low temperatures is desirable in the hot-dry season. In the cold season the retention in the evening of heat gained during the daytime is desirable. Both can be achieved with a solid floor, wall and roof structure with a time lag of some 9 to 12 hours. This thermal capacity is preferably provided by internal walls, floors and roof, permitting the outer walls to be used more freely for large openings which will help to meet the requirements of the warm-humid period.**

**If the thermal mass of the west wall is used for balancing the night temperature, its time lag should be about 6 hours, as it gains heat in the afternoon hours only.**

**A too excessive thermal mass should be avoided. This is especially important in upland areas. A large thermal mass would make the space almost unheatable during the evening hours of the cold season. The time lag should not exceed 8 hours, which is equivalent to**

**the time lag of a concrete wall of 20 cm thickness.**

**If thermal insulation is used, it should be placed on the outside of walls and roof, so that the beneficial effect of the thermal storage capacity is not reduced.**

### **Thermal insulation**

**In upland areas, conductive and radiant heat losses should be minimized. As a consequence, the use of thermal insulation material may be appropriate.**

### **Airtightness**

**At least as important is, however, an airtight construction. Thermal insulation is only effective in a building with no or very little air leakage.**

**As a rule of thumb, in upland areas, a well insulated and relatively airtight building requires about 1-kWh heat storage capacity per 1-m<sup>2</sup> of south facing glazed area.**

### **Reflectivity and emissivity**

**In cool upland regions it is important that during the daytime radiant heat is absorbed in the building shell and radiant heat loss at night is minimized.**

**As a consequence, the outer surfaces should possess absorption capacity but low emissivity.**

**Absorbant surfaces are generally darker and non-shiny. Such surfaces should, however, only be used for buildings with a high thermal capacity. Low thermal capacity buildings would immediately overheat.**

#### **3.4.4.1 Foundation, basement and floors**

**(also see Chapter 3.1.4.1)**

**The floor may be in direct contact to the ground, with medium insulation and thermal storage capacity. In upland regions, materials with low thermal transmission properties are suitable (e.g. timber). In addition, thermal insulation may be required. Floor areas receiving direct solar radiation should possess absorption properties and a heat storage capacity.**

#### **3.4.4.2 Walls**

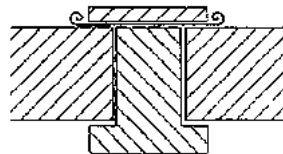
**(also see Chapter 3.1.4.2)**

**The cooler the climate, the better the thermal insulation and air-tightness of the outer walls should be.**

**A medium heat storage capacity of internal and outer walls is appropriate to avoid overheating in the daytime and keep the night temperature at comfort level.**

**Surfaces should generally have medium colors. In warmer regions a bright surface with higher reflectivity is appropriate. Absorptive, dark surfaces are possible in recessed areas, where the summer sun does not reach.**

**In upland regions joints between construction elements should be well-sealed against air penetration. The application of a wallpaper to the inner surface is efficient in this respect.**



**Fig 3/156**

### **3.4.4.3 Openings and windows (also see Chapter 3.1.4.3)**

#### **Size and placement**

**Windows should be of medium size with openings on opposite walls for proper cross-ventilation during the humid period.**

**On the west and north side windows should be small. As a rule of thumb, the total window area should not exceed 25% of the floor area.**

**In upland areas, as many windows as possible should be located on the south side of the building to utilize the heating effect of solar radiation. However, the glazed area should not exceed 50% of the south elevation because of extensive heat loss at night.**

**Excessive glazing can lead to overheating. This can be counteracted by**

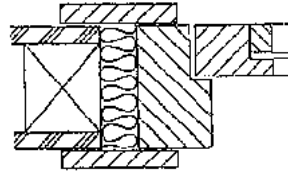
- **the provision of adequate shading,**
- **the provision of ventilation,**
- **sufficient heat storage capacity.**

**Windows should be equipped with tightly closing glazed panels, which provide protection against heat loss during the cold season and also against flow of heat and dusty air during the dry and hot season.**

#### **Construction details for windows**

##### **a) Joints**

**The joints between the window frames and the adjoining walls are an often neglected detail. They should be airtight and, therefore, carefully sealed.**



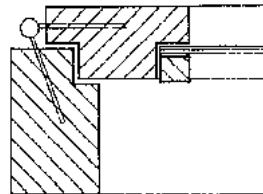
**Fig 3/157 Airtight joints**

### **b) Double glazing**

**Double glazed leaves could be an advantage. However, it is not easy to build them to function properly, because the space between the two glazed panels needs to be accessible for cleaning.**

### **c) Air-tightness**

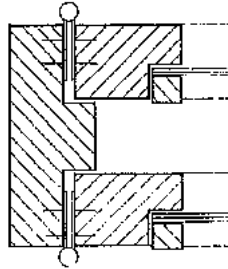
**More important than double glazing is good workmanship, particularly with regard to the grooves. To achieve air-tightness is the most crucial point, because the loss of warm air through the grooves usually accounts for much more than the loss of heat by conduction through window panes. Double-groove window panels could bring a considerable improvement, suitable hinges, however, are often not available.**



**Fig 3/158 Double groove window**

#### **d) Double leaves**

**Another possible improvement, which utilizes conventional hinges, is the use of double leaves, one opening to the outside and the other to the inside. The technique is simple, but has the disadvantage that the application of mosquito screens is almost impossible.**



**Fig 3/159 Double leaf window**

#### **e) Solid shutters**

**Instead of a second glazed leave a solid timber panel can also be used. This would provide a better heat insulating effect for cold nights as well as for hot daytime conditions.**

#### **f) Curtains**

**For additional thermal insulation at night heavy drapes closing rather tightly against the window frame can also be used.**

#### **g) Insulated shutters**

**A very efficient, but rather expensive solution is the use of insulated internal shutters, placed inside or outside of the window leaves.**



## **h) Timber quality**

**For the construction of windows and doors it is very important to use well-seasoned timber. Only then will panels remain straight and airtight.**

### **3.4.4.4 Roofs (also see Chapter 3.1.4.4)**

#### **Waterproofing**

**The roof should protect the building from precipitation and therefore be carefully waterproofed.**

#### **Thermal insulation**

**The roof should provide protection against heat gain in summer and heat loss in winter. The roof should, therefore, have thermal insulation properties.**

#### **Reflectivity**

**Usually a multilayer construction is required. The reflectivity and emissivity of the outer surface is then of minor importance.**

#### **Heat storage**

**The construction should have a medium heat storage capacity to balance temperature fluctuations between the daytime and evening hours, and also in case of sudden weather changes. This storage mass must be situated inside the insulation layer.**

#### **Airtightness**

**In upland regions the construction should be airtight, the joints between construction elements requiring special care.**

### **3.4.5 Special topics**

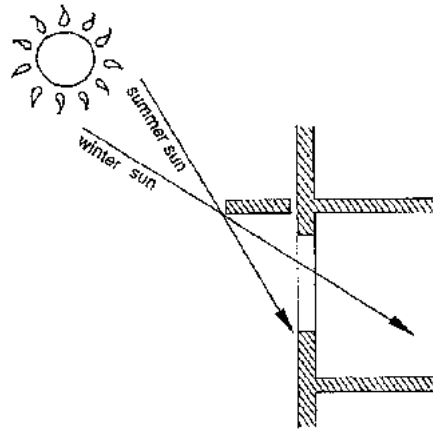
#### **3.4.5.1 Shading devices (also see Chapter 3.1.5.1)**

##### **Design**

**In the hot period, windows must be protected from solar radiation and glare. In the cold season, however, solar heat gain through openings is desired. Hence, shading devices should be movable, which involves a somewhat complicated mechanism and also the attendance of the inhabitants. (see example in Chapter 4.9)**

**An other possibility is a well-balanced design aiming at an optimal direct solar gain in winter and good shading in summer. (see example in Chapter 4.6)**

**A careful climatic analysis will provide an assessment, at what time direct gain is desirable and when not. To determine the shape and size of appropriate shading devices, design aids as described in Chapter 2.2.1 are given.**



**Fig 3/160 Solar angle consideration**

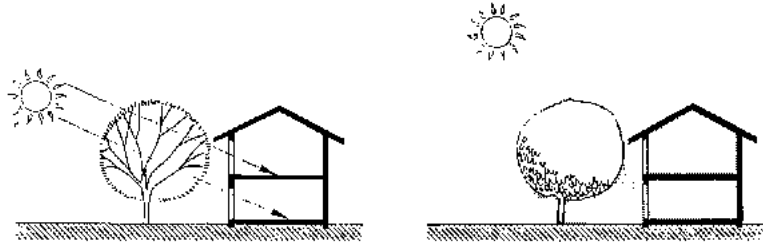
### **Shading of walls**

**Walls do not need extra shading devices in this type of climate, provided they possess reasonably good insulation and reflective properties.**

**(Form of building, roof overhangs etc. see Chapter 3.4.3.3)**

### **Vegetation**

**Deciduous trees are suitable for shading purposes. Such shading trees are best located on the east and west side of a building. Vegetation which is too dense and too close to the building should be avoided because of dampness effect.**



**Fig 3/161 Deciduous trees provide access to winter sun but protect against summer sun**

**Vegetation cover on facades(also see Chapter 3.3.2.3 )**

**A green cover on outer walls and roof has many advantages:**

- **It protects the walls against driving rain.**
- **The wind velocity on the surface is reduced and with it the cooling-off period.**
- **Glare is eliminated**

**(also see Chapter 3.3.5.1)**

**In winter time, a dense green coverage can be a disadvantage because desired the solar heat gain may be reduced. By using deciduous plants this effect can be avoided.**

### **3.4.5.2 Natural ventilation**

**(also see Chapter 3.1.5.2)**

#### **Relation to winds**

**Protection against cold winter winds should be balanced by proper ventilation during hot and humid periods. Therefore, regulated air movement is a primary requirement. This can be achieved by well planned openings with shutters.**

## **Ventilation openings**

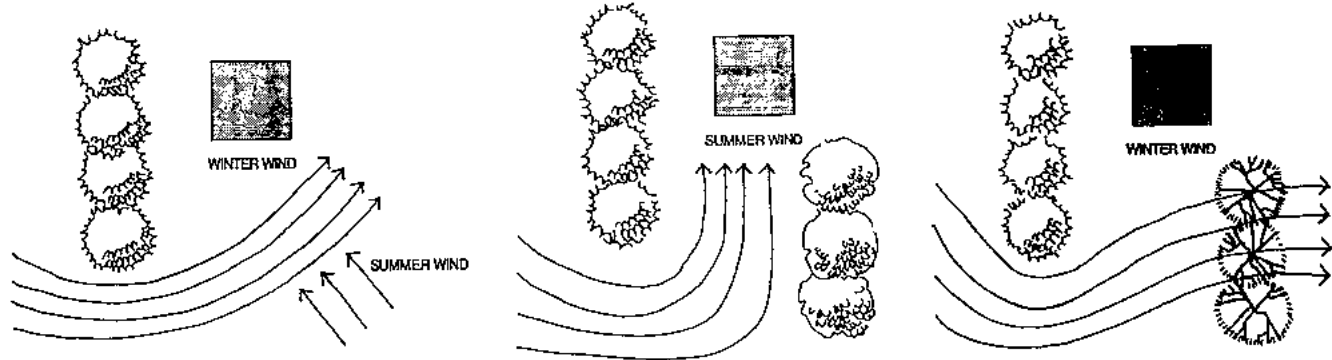
**Preferably, special openings for ventilation should be provided. Two small openings, one at a high level and one at a low level, or ventilating stacks may be solutions (see Chapter 3.1.4). The disadvantage of such special arrangements lies in the fact that they are often neglected by the inhabitants, with the result that warm or cold air enters the room at undesired times.**

**The warmer the climate and the higher the humidity, the more important is it to provide cross-ventilation.**

## **Vegetation**

**To counteract the winter wind direction, evergreen windbreakers are desirable. However, trees should not block the prevailing summer breezes. Evergreen trees are best for wind protection, whereas deciduous trees are suitable for shading purposes.**

**The way plants can be arranged to achieve the desired ventilation effect is described in detail in Chapter 3.1.5.2.**



**Fig 3/162 Regulation of ventilation by evergreens and deciduous bushes**

### 3.4.5.3 Passive heating

**This section deals only with heating. Cooling methods are described in Chapter 3.1.5.3 and 3.2.5.3.**

#### **Elements of passive solar heating**

**The possibilities of space heating by means of passive solar radiation have been excessively dealt with in the technical literature of recent years, but the main principles have been known for a long time. Traditional buildings often include a fine synthesis of a balanced use of solar energy. The advantages are obvious: the consumption of firewood or other fuels can be reduced, which, in these days, is extremely important ecologically.**

**The basic idea was formulated by Socrates, who designed a concept with three elements:**

- **Capturing as much winter sun as possible**
- **Keeping out solar radiation in summer time**
- **Using a thermal buffer zone towards the north**

1. Summer sun
2. Winter sun
3. Covered verandah
4. Living room
5. Storeroom as thermal buffer zone
6. Insulated wall towards the north

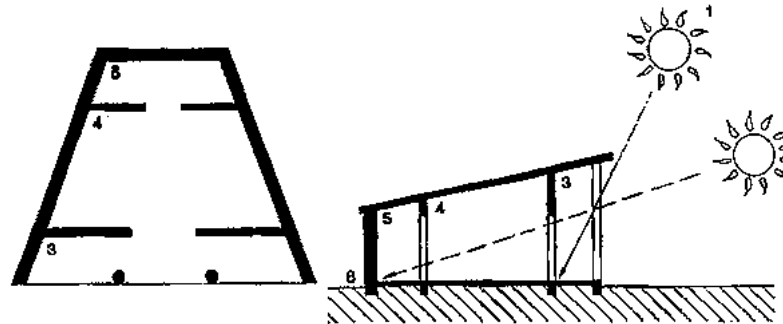


Fig 3/163 The concept designed by Socrates

### Green effect

The function of the solar gain process using glazed surfaces is based on the "greenhouse effect". This means that solar radiation can easily pass through glass. When it strikes an absorptive surface behind the glass, it is converted into longwave heat radiation which cannot pass directly through the glass anymore. As a result the materials behind the glass heat up.

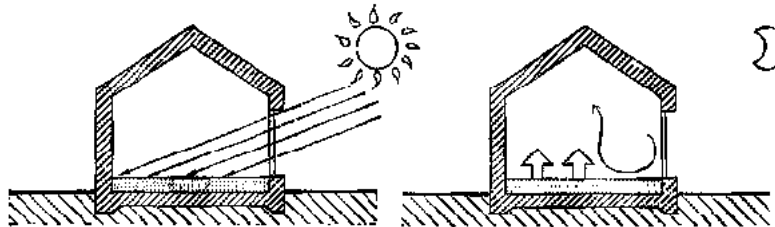
### Passive solar systems

**Three main principles used for passive solar gain can be distinguished: direct solar gain, indirect solar gain and attached green house.**

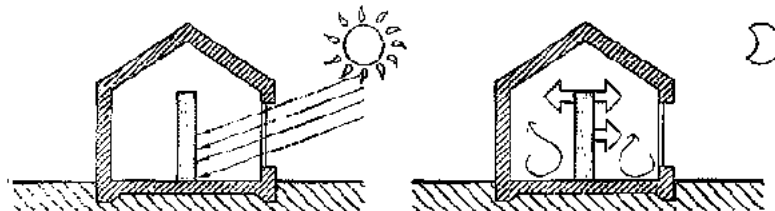
### **Passive solar gain**

**The sun's rays enter through the windows into the rooms which are required to be heated and the heat is stored in the walls, floors and ceilings.**

**Using direct solar energy in a building requires that the majority of windows are located on the south elevation. The sun's rays enter the building through the windows and strike the floors, walls and objects in the rooms, where the greatest part is absorbed and converted into heat.**

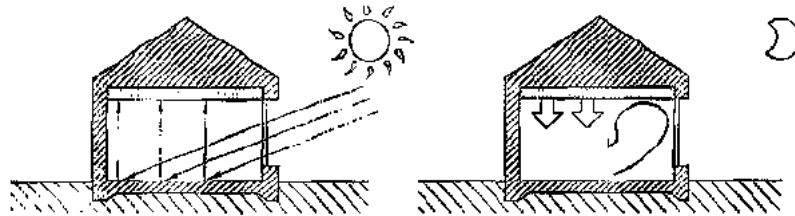


**Fig 3/164 The floor as collector and heat storage mass**





**Fig 3/165 Internal walls as collector and heat storage mass**



**Fig 3/166 The ceiling as collector and heat storage mass**

### Storage capacity

In order to retain the heat and to avoid overheating of the rooms in daytime heat storage capacity is needed. This implies that the major part of the materials used in the inside of the building (inside the thermal insulation) must have good heat absorption and heat storage properties.

### Indirect solar gain

The sun's rays are captured by various kinds of solar collectors, where the accumulated heat can be transferred to the room in a controlled way.

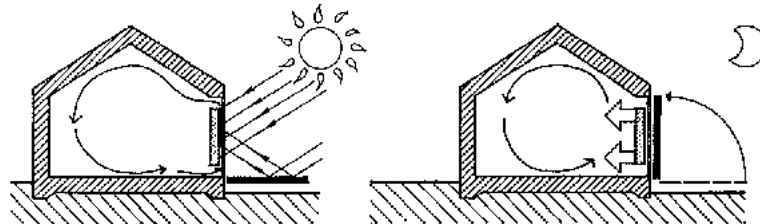
Commonly known systems are:

#### a) Trombe wall

A massive wall with a dark surface is placed behind a glazed surface. It absorbs the sun's rays and conducts the heat slowly through the wall to the inside of the building. From here the heat is transferred to the rooms both by radiation and by convection.

**Adobe and burned clay bricks are the materials with the best properties for trombe wall constructions.**

**A disadvantage of the trombe wall is that it covers a great part of the south facing elevation and thus prevents the provision of windows on this side.**

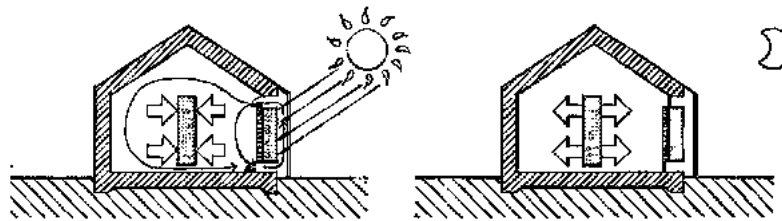


**Fig 3/167 Trombe wall with insulated shutter on the outside**

### **b) Solar wall**

**The solar wall consists of highly absorptive, light materials between a glazed surface and heat insulation. Solar radiant heat is collected. This is then emitted to the air between the glasspane and the surface of the collector, which transfers the heat to the rooms.**

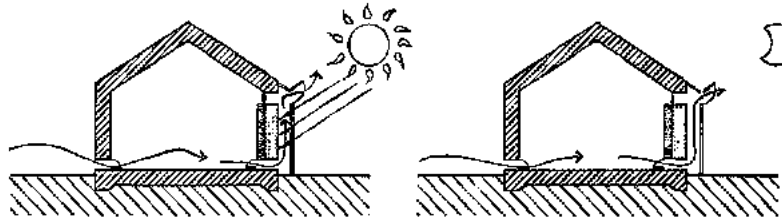
**Solar walls can be constructed of corrugated, matt black painted metal sheeting or other building materials which heat up quickly and which are resistant to high temperatures. They can be incorporated into the building elevation, but they can also be arranged in a detached way. In order to prevent the heat from escaping to the outside, the glazed window walls in front of the solar walls have to be constructed in a well sealed way. The system is also known as air-loop heating. (see example in Chapter 4.9)**



**Fig 3/168 Solar wall as an air heating device with internal storage mass**

**During the warm period of the year, solar walls can be used as a cooling device, creating increased ventilation.**

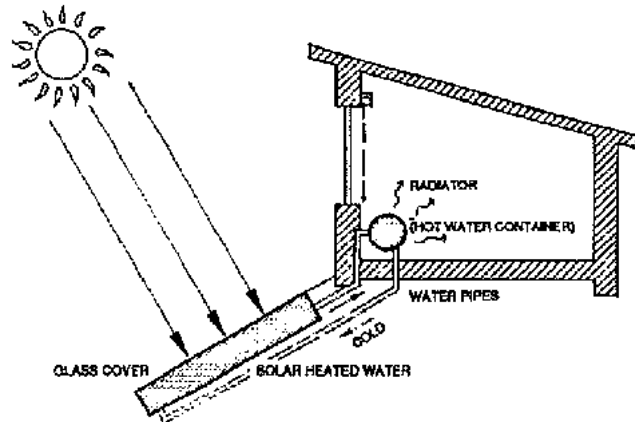
**(also see 3.2.5.3)**



**Fig 3/169 Solar wall as cooling device**

### **c) Solar collector**

**Solar collectors using water as a heat transmitting medium are the most efficient ones. The system also offers more flexibility in the design because water can easily be transported to the desired place in a controlled manner. However, the technology requires more expertise and skill than the construction of thermal walls. At high altitudes, there is a danger of freezing.**



**Fig 3/170 Solar collector as detached device**

**As a rough rule of thumb, in upland regions where the temperature varies approximately between 0°C and 10°C, the solar collector surface should be about 1/3rd of the heated floor area, provided the building is moderately well constructed. (Example of space heating by a solar collector see Chapter 4.6)**

### **Danger of freezing**

**In mountainous regions, with temperatures far below freezing point, the use of water as a heat transmitting medium is not possible. An anti-freezing agent would be required, but in many cases its availability and use cannot be guaranteed. Here, systems using air as a transmitting medium are appropriate. However, such systems are less efficient.**

### **Collector at low level**

**For them to operate in a purely passive way, all these water and air-loop systems, also**

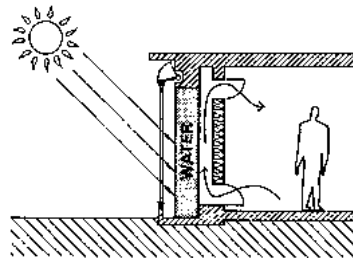
**called thermo-syphons, require placing the collector at a lower level than the heat outlet, for them to operate in a purely passive way. The reason is that a heated medium expands and is thus lighter than a cooler one. It therefore rises, which is the basic principle of any such system.**

### **Collector at high level**

**If, for certain reasons, the collector is located above the heat outlet, an active element is required to transport the heat to the desired place. Such elements would be circulation pumps or fans. These systems are more complex in terms of construction, as well as in terms of operation. They are more expensive and also depend on a second energy source, usually electricity.**

#### **d) Water wall (see Chapter 3.1)**

**Instead of masonry the wall consists of a metal tank filled with water. Compared to the trombe wall this system conducts heat much more rapidly because the wall has far less thermal lag and the water convects during heating. The great heat capacity of water permits for rather thin walls.**



**Fig 3/171**

**e) Roof pond  
(see Chapter 3.1)**

**Water walls and roof ponds could be suitable, but are technically demanding.**

**f) Heat gain through an attached greenhouse**

**A greenhouse is built onto the south wall of a house and functions as a solar collector. During the day excess heat is transferred by convection into the house, where it is stored in the floor, walls or ceiling, or in a special heat storage element. The greenhouse can also be combined with the principles of a trombe or solar wall.**

**The floor of a greenhouse as heat storage**

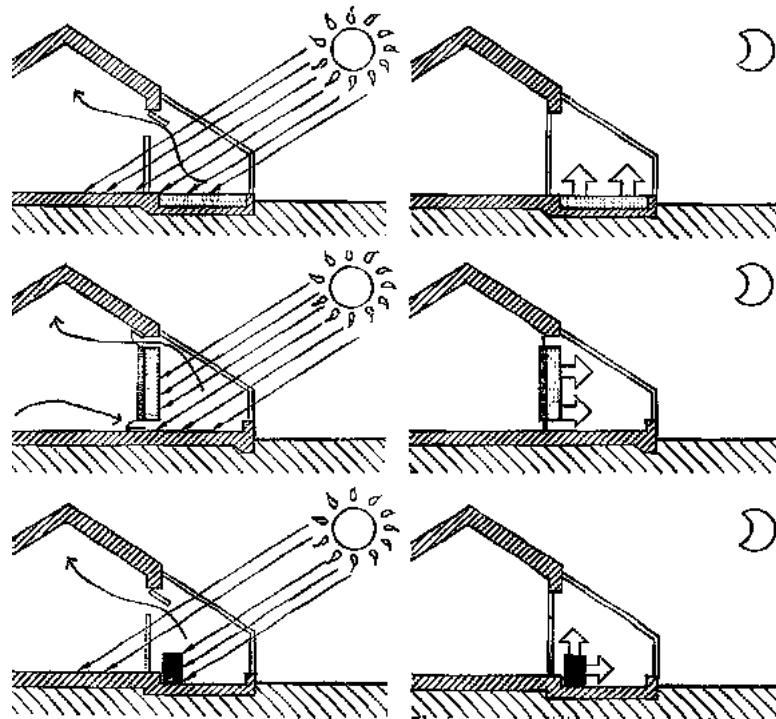
**The main advantage of the greenhouse is the attractive additional room it offers, which can be used as living space during cold but sunny hours, and as a place to raise vegetables and flowers as well.**

**To avoid overheating of the greenhouse, movable shading devices, preferably placed on the outside, have to be considered. Large ventilation openings are usually also required.**

**The walls of the greenhouse as heat storage area**

**If a greenhouse is used during the cold season when there is no sunshine, it can easily become a source of heat loss rather than heat gain. This is also the case during cool nights if it is not properly closed off from the rest of the building.**

**Free standing heat storage in greenhouse**

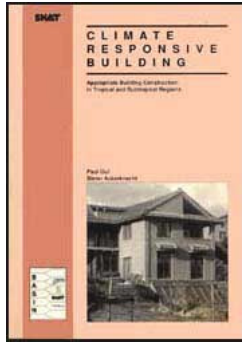


**Fig 3/172 Solar gain by attached greenhouse shown during day and night function**



[Home](#) > [ar.cn.de.en.es.fr.id.it.ph.po.ru.sw](#)

**Climate Responsive Building - Appropriate Building Construction in**



## Tropical and Subtropical Regions (SKAT, 1993, 324 p.)

- ➔ □ **4. Case studies**
  - 📄 **4.0 Preliminary remarks**
  - 📄 **4.1 Experiment in Ghardaia, Algeria**
  - 📄 **4.2 Simulation in Ghardaia, Algeria**
  - 📄 **4.3 Buildings in Shanti Nagar, Orissa, India**
  - 📄 **4.4 Experiments in Cairo, Egypt**
  - 📄 **4.5 Buildings in the Dominican Republic**
  - 📄 **4.6 Buildings in Kathmandu, Nepal**
  - 📄 **4.7 Buildings in New Delhi, India**
  - 📄 **4.8 Movable louvres for a school in Kathmandu, Nepal**
  - 📄 **4.9 Mountain hut in Langtang National Park, Nepal**

### Climate Responsive Building - Appropriate Building Construction in Tropical and Subtropical Regions (SKAT, 1993, 324 p.)

#### 4. Case studies

##### 4.0 Preliminary remarks

##### The main points:

- **The selection of examples is restricted to those that give interesting information and where the data are secured**
- **The indoor and outdoor air temperature is monitored simultaneously by the use of dry bulb thermometers**



- **The surface temperature is monitored in a few cases. The results are therefore sometimes less significant than expected, but nevertheless clearly illustrate the tendency.**

### **General topic**

**In this chapter the thermal performance of various buildings in different climatic zones is compared, based on the indoor air temperature, which was recorded by extensive monitoring.**

**The building examples represent mainly built houses whose performance is monitored during their daily use, rather than abstract models or theoretical configurations. The complex situation of a house in use is therefore incorporated.**

### **Assessment of performance**

**The study of these examples helps to assess the influence of construction systems on the indoor climate in quantitative terms. It provides a good idea in which range the indoor climate can be influenced. It also shows that climate control, in a purely passive way, has limits. Miracles cannot be expected: clear advantages however can be achieved.**

### **Selection of examples**

**The aim was not to include as many examples as possible, but two criteria were used as a guide in the selection:**

- **Only examples with reliable and validated data were used.**
- **Only examples giving clear information, allowing conclusions to be made, were used.**

### **Focus on air temperature**

**It was not an easy task to achieve reliable recording of the indoor climate in remote**

**locations and in different climatic zones. The study was, therefore, in general, restricted to the air temperature only.**

**Often the air temperature does not show a very drastic difference in the performance of the system, although the difference is felt acutely by the occupants. This is due to the fact that other factors also play a significant role. To gain a comprehensive comparison, surface temperatures, air humidity and air circulation would have to be considered as well, which would require a wider and more scientific framework to the research program, which was not the purpose of this study.**

**The recording of the air temperature only, however, gives a clear picture of the tendency and it has to be kept in mind that the real differences are larger than the results would suggest.**

### **List of examples and main focus**

**In this chapter the following examples and construction systems are studied and compared:**

#### **1. Hot-arid zone**

**Experiment in Ghardaia, showing the influence of night ventilation.**

#### **2. Hot-arid zone**

**Computer-simulations in Ghardaia, demonstrating the influence of many variables separately.**

#### **3. Hot-arid zone**

**Buildings in Orissa, comparing the performance of fibre concrete tiles (FCR) in single and**

**double layers, of clay tiles, and of buildings with differing storage mass.**

#### **4. Hot-arid zone**

**Experiment in Cairo, comparing a well-designed mud structure with a concrete structure of very poor design.**

#### **5. Hot-arid zone**

**Buildings in the Dominican Republic, comparing four different roofing alternatives: corrugated iron sheeting, palm leaves, micro-concrete tiles (MCR) and a brick vault.**

#### **6. Temperate zone**

**Buildings in Kathmandu: houses of good quality, making proper use of the sun's radiation, compared to poorly designed "concrete box" type houses. Also the effect of a passive solar floor heating system is described.**

#### **7. Temperate zone**

**Buildings in New Delhi, India; well-designed mud structures compared to well-designed conventional concrete/brick structures; and comparing fibre concrete roofing (FCR) and asbestos roofing.**

#### **8. Temperate zone**

**A possible solution for a movable louvre system, which can be manufactured in local workshops without sophisticated equipment.**

#### **9. Upland**

**Mountain hut in Langtang National Park, Nepal: a rather sophisticated trial with a solar wall in a difficult and remote situation, under high-alpine conditions.**

**No example in warm-humid zone**

**In the warm humid zone the air temperature is rather even throughout the day and throughout the seasons. The indoor air temperature thus hardly fluctuates at all. The main objective of adapted construction is to improve the climate by proper air circulation and its influence is, therefore, difficult to assess. Recording the indoor temperature provides little information. This is the main reason why this zone is not represented by an example.**

#### **4.1 Experiment in Ghardaia, Algeria**

**The main points:**

- **With controlled ventilation (night ventilation only) full advantage can be taken of the lower night temperatures.**
- **The ventilation during nighttime has only a minor effect on the daytime temperature.**
- **The gypsum construction keeps the temperature at a very even level.**

**Source: Research project by Lund University, (LCHS) and CNERIB, Algeria, carried out by Hans Rosenlund and Djamel Ouahrani. [ 101, 157 ]**

##### **4.1.1 Geographical location and climatic characteristics**

**Ghardaia lies in an extremely hot and arid region in the desert of Algeria, 600 km from the coast, at an altitude of 500 m above sea level and a latitude of 31.5o North.**

**The climate is hot and dry in the summer with temperatures variation between a maximum**

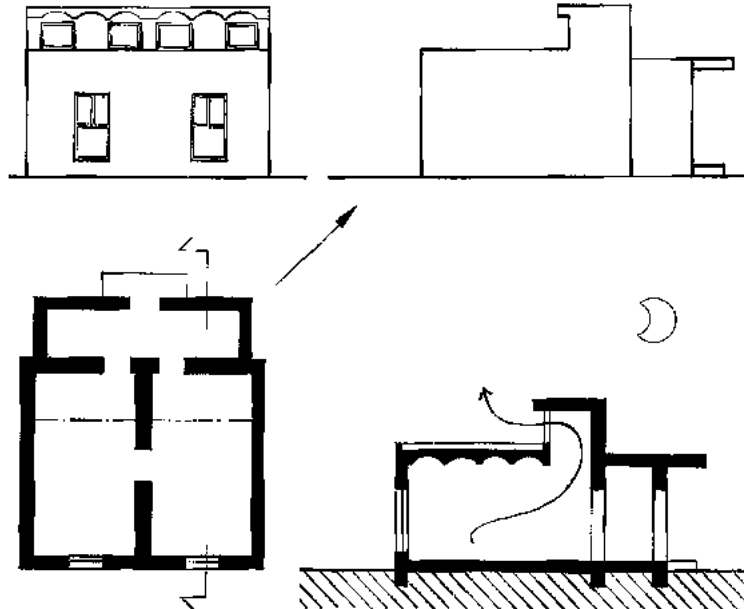
**of around 45°C and a minimum of 20°C, thus giving a large diurnal temperature swing. Winter temperatures vary between a maximum of 24°C and a minimum of 0°C. Solar radiation is intense throughout the year with a maximum of 700 W in winter and 1000 W in summer, measured on the horizontal surface.**

#### **4.1.2 The project**

**In 1981, an experimental building was erected in Ghardaia. The purpose of the building was to measure the influence of different parameters on the indoor climate. The building contains two identical rooms, where one room can be manipulated while the other is kept as reference. A series of tests was conducted.**

**The building has walls of gypsum blocks, 40 cm thick; a roof of gypsum mini-vaults, 8 cm thick, resting on concrete beams and covered with 5 cm thick concrete plaster; and a concrete floor resting on the ground.**

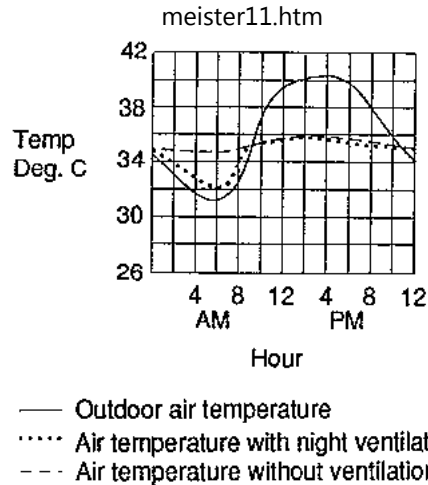
**A characteristic feature of the building is the ventilation box consisting of a raised roof with an upper window.**



**Fig 4/1 Plan, section and elevation of the experimental building**

#### **4.1.3 Influence of night ventilation**

**One experiment was to monitor the influence of night ventilation. In the reference room the window and roof ventilator were kept closed, whereas in the experimental room they were opened during nighttime. The effect of the night ventilation is clearly seen as a remarkable drop in temperature when the window was open. During the night the indoor temperature approaches the outdoor one. This means that the number of air changes per hour is important.**

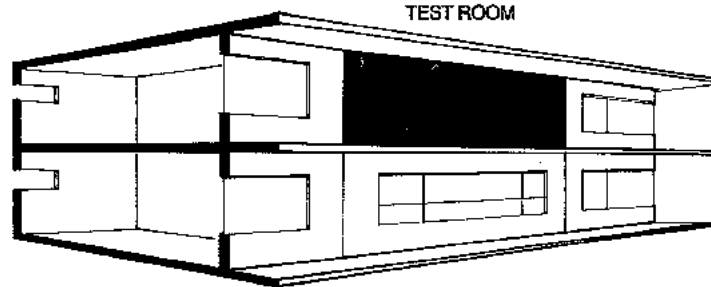


**Fig 4/2 Influence of increased night ventilation, measured air temperatures in the middle of the rooms**

#### 4.1.4 Performance of gypsum

During the daytime the temperatures in both rooms vary only slightly, which means that with this type of construction the cool of the night can hardly be maintained during the next day. The temperature is remarkably even throughout the day. This can be explained by the properties of the massive gypsum construction, which has medium thermal storage capacity but rather good thermal insulation value. Therefore, the exchange of heat between the air and the surface is small and, when the windows are closed, the indoor temperature is even. This structure performs in a similar way to the mud house documented in chapter 4.4.

#### 4.2 Simulation in Ghardaia, Algeria



**Figure**

**The main points:**

- **Daytime overheating can be eliminated by internal storage mass**
- **Reflective outer surface color reduces the indoor temperature.**
- **The cooling effect of continuous ventilation depends on the structure (heavy or light) and the outdoor temperature.**
- **A reduction of the ventilation rate during the day is only advantageous in the case of a heavy structure (with high thermal capacity).**
- **Thermal insulation decreases the indoor temperature in the hot season and increases it in the cold season. This is especially the case for surface temperature.**
- **The influence of the window size is higher in the case of a light structure than in the case of a heavy structure.**
- **The influence of double glazed window panes is negligible.**



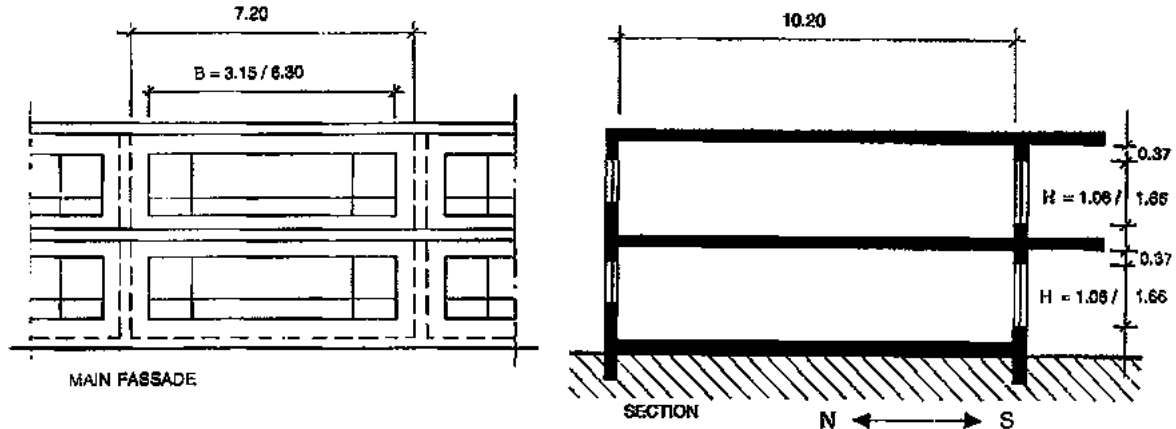
**Source: Parametric study by Lund University, (LCHS) and CNERIB, Algeria, carried out by Hans Rosenlund.[ 156 ]**

#### **4.2.1 The simulation configuration**

**The geographical location and climatic characteristics have already been described in chapter 4.1.1**

**In this example a model building has been simulated by a computer program, where the influence of various parameters on the indoor temperatures were examined. The project was carried out within the framework of the research cooperation "Building in Hot and Arid Climates" between Lund University, Sweden (LCHS) and Center National d'Etudes et de Recherches Integres du Batiment (CNERIB), Algeria. The principal researcher was Mr. Hans Rosenlund. The simulation program used was JULOTTA (Kilblad 1986).**

**The building model chosen for this study is a two story row house. The performance of the upper floor of the middle section of the house is calculated, with a width of 7.2 m and a depth of 10.2 m. The main facade can be varied with respect to window size and the depth of the horizontal projecting roof slab above the windows.**



**Fig 4/3 Section and facade of the two story house**

### The basic types

Two basic types of structures are examined: a heavy one and a light one.

The light structure consists of outer walls and roof of light, insulated timber and mineral wool 54 mm thick ( $U\text{-value} = 0.83 \text{ W/m}^2\text{K}$ ), with negligible internal thermal storage capacity. The window covers an area of  $5.23 \text{ m}^2$ .

The heavy structure, which acts as a thermal storage with a capacity equal to  $100 \text{ m}^3$  of 200 mm concrete, consists of heavy outer walls and roof of 200 mm concrete ( $U\text{-value} = 3.0\text{-W/m}^2\text{K}$ ). The window measures  $3.34 \text{ m}^2$ .

In both cases, no roof overhang above the windows, and an air change of 1.1 per hour is calculated.

**The absorptivity of the outside of the walls and roof is 80% ( $a = 0.8$ ) for the case in Chapter 4.2.2; for the cases in Chapter 4.2.4 - 4.2.7 the absorptivity is 20% ( $a = 0.2$ ).**

**The internal heat load assumed is about 400 W at nighttime between 6 pm and 8 am, and 200 W during daytime.**

### **The variable parameters**

**Based on the calculation of the thermal performance of the basic types, a number of variables have been introduced and their influence on the thermal performance calculated:**

- a) Influence of internal storage capacity**
- b) Influence of outer color of walls and roof (reflectivity)**
- c) Influence of continuous ventilation**
- d) Influence of reduced ventilation during daytime**
- e) Influence of thermal insulation on air temperature**
- f) Influence of thermal insulation on ceiling surface temperature**
- g) Influence of number of window panes**

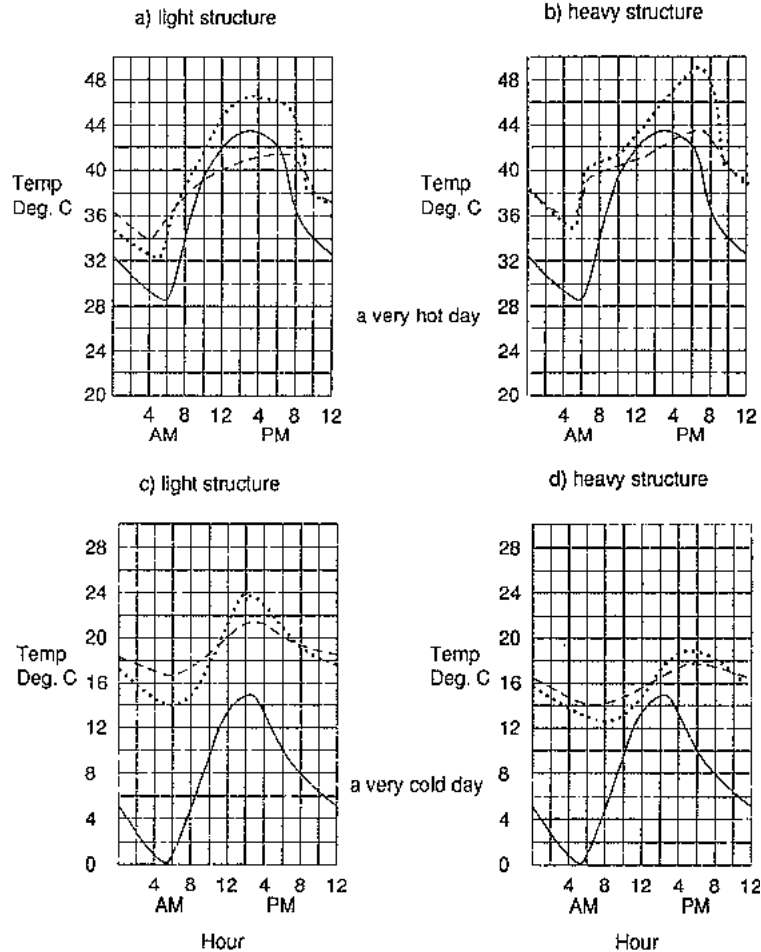
### **Restrictions and purpose of the study**

**The main results of this parametric study which are summarized hereafter, give a somewhat theoretical picture. In reality the indoor climate is always influenced by a combination of these factors as well as other factors. Simply adding the various influences of the parameters is not possible. Also, the human factor is not considered, i.e. the unreliability of controlled ventilation, which depends on the active participation of the inhabitants. Furthermore, the JULOTTA-program does not sufficiently incorporate the influence of radiation to the night sky, thus giving slightly too high indoor temperatures. The results therefore do not represent real indoor temperature figures.**

**It also has to be kept in mind that the building chosen represents a “general model” which is not adapted to the climatic conditions of Ghardaia at all.**

**However, the results can be used to judge the importance of the different parameters and to estimate their effects, positive or negative, strong or weak.**

#### **4.2.2 Influence of internal thermal storage capacity**



**Fig 4/4****Results of 4.2.2**

**As Fig 4/4 a) and b) show, on a hot day the maximum temperature can be significantly reduced with the help of the thermal mass of the whole structure. The internal thermal storage mass is cooled down during the night by an increased ventilation (10 air change per hour). Thus, during the day, when the ventilation rate is lower (1.1 air change per hour), the internal mass maintains a lower indoor temperature. The increased internal mass, however, means a slightly higher night temperature.**

**An interesting comparison between the heavy and the light structure house is that, in the former, the time lag of the heavy outer walls causes the temperature to rise to a maximum of 43.5°C as late as at 6 pm. In the light structure house, with internal mass, the maximum temperature is lower, 40.9°C, and occurs earlier, at 3 pm. The high altitude of the sun makes the difference in window size less important, while the effect of roof insulation in the light structure house is obvious.**

**The negative effect of the non-insulated concrete roof in the heavy structure is clearly seen in the case without internal heat storage mass, with a temperature rising up to 49°C towards evening and only dropping then, due to the increased ventilation that starts at 9 pm.**

**Fig 4/4 c) and d) show that on a cold day an internal mass decreases the variation in temperature while the average temperature remains the same. This phenomenon is more pronounced in the light structure house, being more affected by the solar radiation through the bigger windows.**

**The relatively high average indoor temperatures are a consequence of the assumed internal load, the low air change rate and the solar heat radiation gain. Moreover, the**

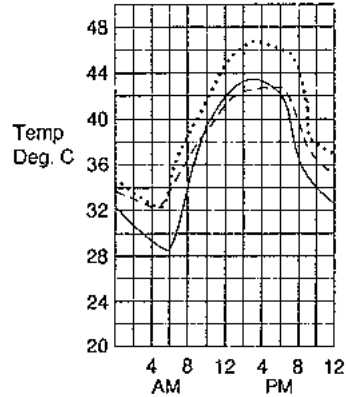
**result is slightly falsified because of the radiation losses to the night sky that are not sufficiently considered in the calculation program.**

### **Conclusion**

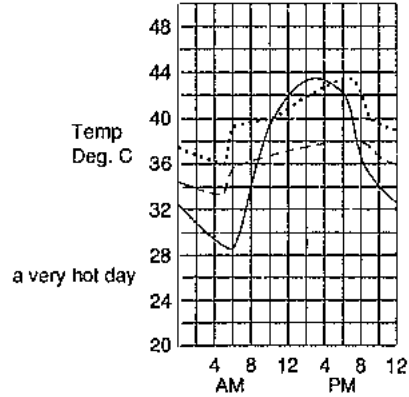
**As a consequence, the internal thermal storage capacity of the building, not being exposed to solar radiation, is an important means of increasing winter night temperatures and decreasing maximum temperatures during the hot season.**

#### **4.2.3 Influence of outer color of walls and roof**

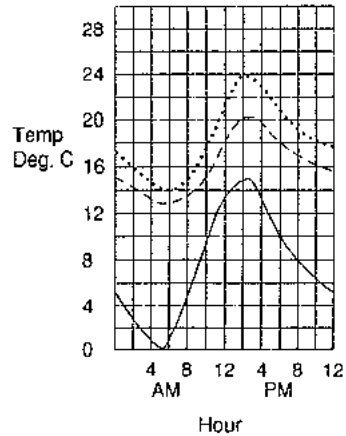
a) light structure



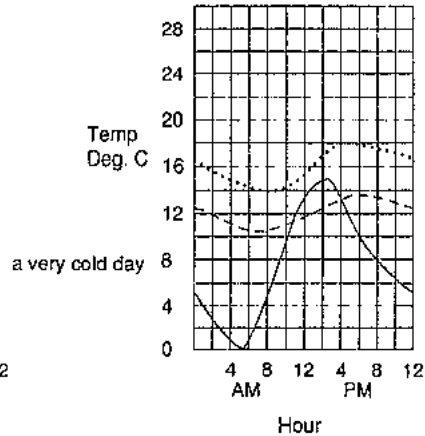
b) heavy structure



c) light structure



d) heavy structure

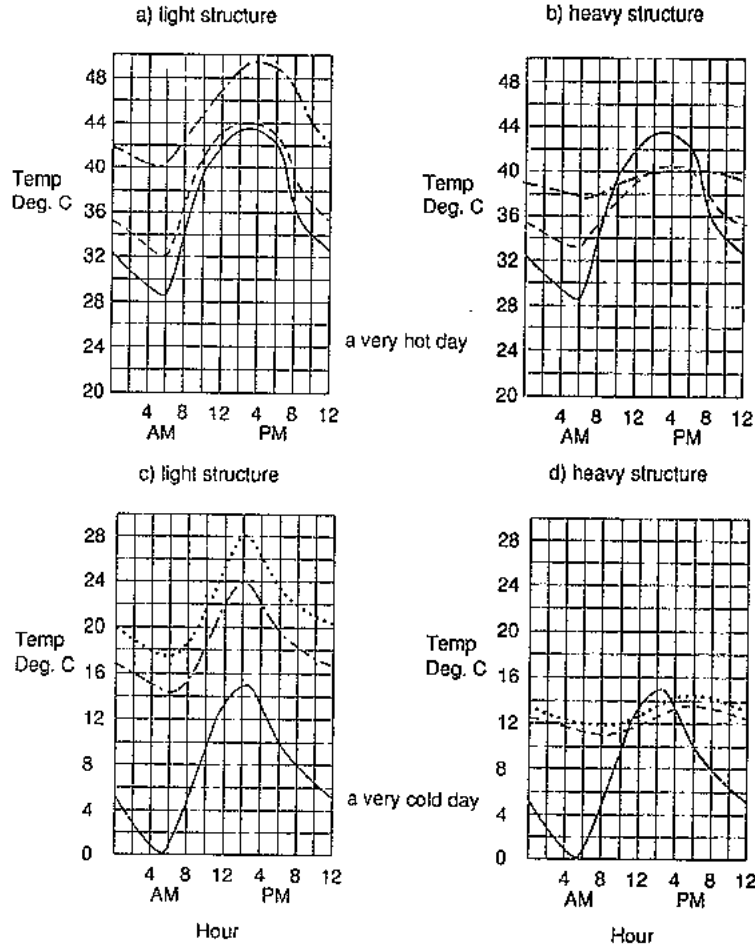




**Fig 4/5**

**A lower absorptivity - or a higher reflectivity - results in generally significantly lower indoor temperature, both in the heavy and light structure houses. The heavy structure house also has clearly lower night temperatures due to decreased heat storage of solar radiation in the outer walls and roof. For the same reason the variation between day and night temperature's is smaller.**

**4.2.4 Influence of continuous ventilation**



**Fig 4/6****Conclusion for 4.2.4**

**Fig 4/6 a) and b) show that an increased continuous ventilation causes the indoor temperature to approach the outer one. This means - in the heavy structure house - a decreased night temperature, while the maximum temperature, being lower than the outdoor one, increases with the increased ventilation rate. The light structure house, with low thermal storage capacity, generally has lower indoor temperatures with the increased ventilation rate, due to the fact that the indoor temperature exceeds the outdoor one at all hours.**

**During winter, the indoor temperature can be increased by a decrease in ventilation rate.**

**4.2.5 Influence of reduced ventilation during the daytime**

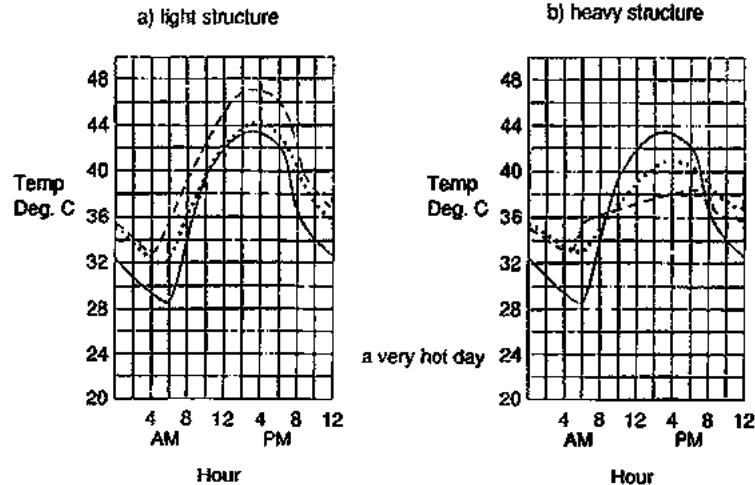


Fig 4/7

### Conclusion for 4.2.5

Fig 4/7 displays the difference between a permanent ventilation of 10 air changes per hour and a ventilation reduced to 1.1 ach during the daytime. In the heavy structure house, the day temperature decreases with reduced day ventilation. In the light structure the opposite is the case.

As a consequence, reduced day ventilation is only advantageous in heavy structures. In other words, the advantage of storage mass is only fully exploited if combined with reduced ventilation in daytime.

The case of a very cold day with the same variation in ventilation rates is not relevant.

## **4.2.6 Influence of thermal insulation on air temperature**

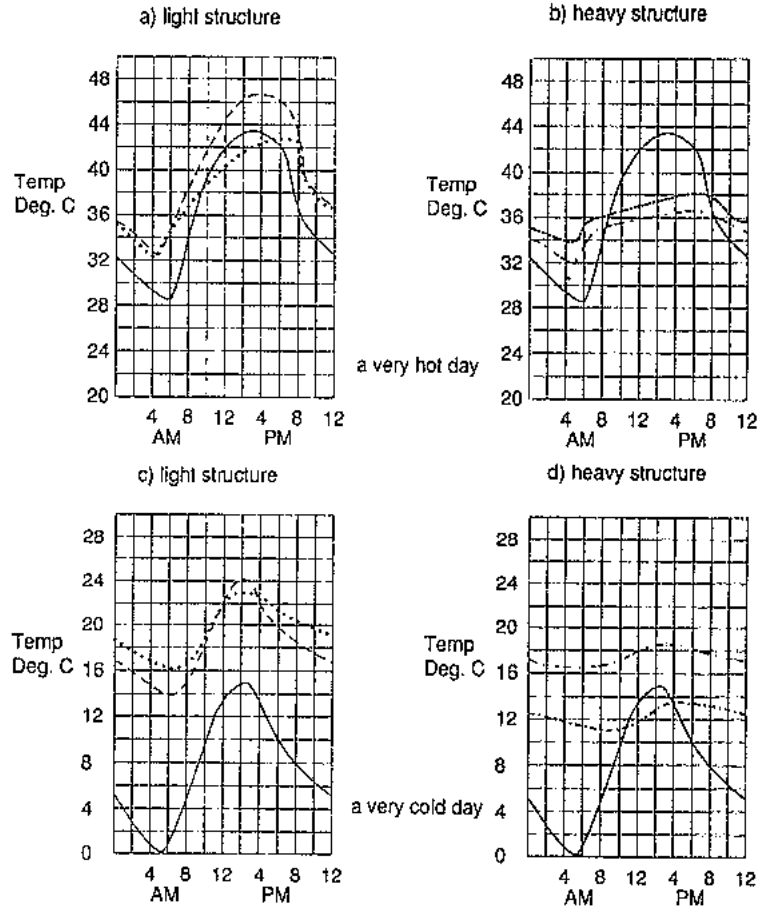


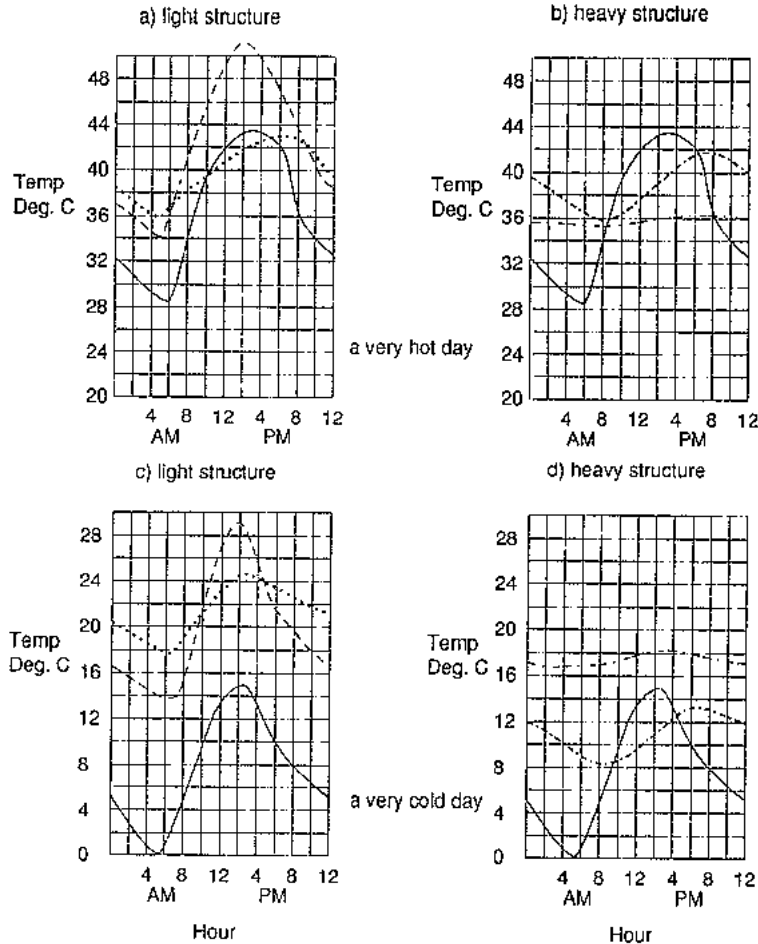
Fig 4/8

### **Conclusion for 4.2.6**

**Fig 4/8 a) and b) show the importance of roof insulation especially during the hot period when the solar radiation effect is at its greatest. Both structures - the heavy and the light one - perform better with increased insulation, but the light structure house has higher temperatures and a wider range. The heavy house has lower night temperatures with increased insulation due to "internalization" of mass which makes it more efficient in combination with night ventilation.**

**In the cold season, the heavy structure house has generally higher temperatures due to increased insulation, while the light one has lower maximum, but higher minimum temperatures.**

### **4.2.7 Influence of thermal insulation on ceiling surface temperature**





**Fig 4/9****Conclusion for 4.2.7**

**During the hot season, the ceiling temperatures are equally decreased by roof insulation. The heavy roof has an almost constant temperature around 36°C. Without insulation the surface temperature of the heavy roof rises up to 42°C. This is a rather modest value, due to an assumed high reflectivity ( $a = 0.2$ ). A normal grey concrete surface exposed to solar radiation would result in an inner surface temperature far above 50°C. The light structure case shows much higher maximum values due to the absence of mass.**

**During the cold season, the ceiling surface of the heavy structure house generally has higher and more even temperatures with increased insulation, while the light house has higher minimum, but lower maximum temperatures.**

**4.2.8 Influence of size of south facing windows**

**Comparing the cases of windows measuring 3.2 m<sup>2</sup> and 10.4 m<sup>2</sup> respectively, the indoor temperatures differ during the cold season. In the case of the heavy structure, a larger window results in an increased air temperature of 2 - 4°C. In the case of the light structure the increase is up to 6°C.**

**During the hot season the differences are negligible. The reason for this is that the direct radiation hardly reaches the window area and for small angles of incidence, most of the radiation is reflected. Furthermore, the portion of diffuse radiation in this climate is very low in July.**

**4.2.9 Influence of number of window panes**

**If the effect of double glazing is also calculated; a double glass sealed with 12 mm air**

**space between the panes is studied. In both cases of the heavy as well as the light structure house, the influence of the double glazing is less than 0.4°C and can be neglected. This applies to both winter and summer. The only remarkable difference lies in the inner surface temperature of the window.**

**Where indoor and outdoor temperatures are similar, the main heat transfer through windows is by radiation which is only marginally affected by a second pane.**

#### **4.2.10 Concluding recommendations**

- **A high internal thermal storage capacity is essential to decrease temperature variations and to profit from an increased night ventilation.**
- **A white outer surface or a heavily ventilated double roof construction is necessary to prevent the solar radiation penetrating the building structure, especially the roof, during the summer when the angle of the sun is high.**
- **Southern windows of moderate size receive a great deal of the solar radiation during the cold period, while during summer they are rarely exposed to direct radiation. However, during spring and fall, when temperatures are still high and the angle of the sun is less, the quantity of solar radiation through windows can be considerably higher and needs to be considered, e.g. additional shading devices would be needed.**
- **The ventilation rate should be kept as low as possible during the winter period. However, due to hygienic reasons, the ventilation rate must not be too low. Another problem which could occur is condensation, especially in the case of structures with a relatively low internal surface temperature in combination with rooms with a high rate of added vapour such as kitchens.**
- **During summer nights the ventilation should be increased as much as possible by**

**catching the wind or using stack effects. In the daytime, when the outdoor temperature exceeds the indoor one, the ventilation rate should be kept to a minimum. The internal mass thus retains the cool of the night until daytime.**

- **A good roof insulation is preferable to protect the building from the intense direct solar radiation during summer. The effect of wall insulation is, however, negligible in the hot period, as long as the house has a significant internal storage capacity. Insulation of east and west wall can be considered.**
- **In the winter an external insulation is very efficient in raising indoor temperatures to acceptable levels. The outer walls could even be of a lightweight and well insulated construction if the building has a considerable mass.**
- **However, insulation is normally scarcely available and/or expensive. Efforts should be made to develop local insulating building materials in desert regions.**

### **4.3 Buildings in Shanti Nagar, Orissa, India**

**The main points:**

- **Unprotected southern walls lead to overheating.**
- **FCR (Fibre Concrete Tiles) and clay tiles perform similarly.**
- **Double layer of tiles has no significant influence on the indoor air temperature, but certainly on the surface temperature which is not monitored.**
- **Buildings with a high storage mass are clearly warmer at nighttime, but not much cooler in daytime because of the high ventilation rate.**

**Source: AMG India International Leprosy Rehabilitation Centre, Shanti Nagar**

## Monitoring of performance: H.U. Lobsiger

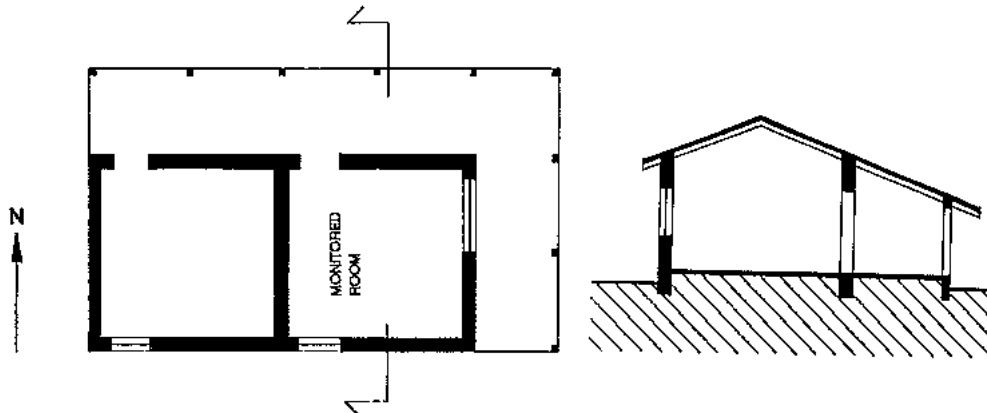
### 4.3.1 Geographical location and climatic characteristics

Shanti Nagar lies in a hot and arid region in India, 220 km from the coast, at an altitude of 400-m above sea level and a latitude of 20° North.

The climate is hot and dry in the summer season (March to June) with temperature variations between a maximum of around 50°C and a minimum of 20 - 30°C, thus a large diurnal temperature swing. Winter (November - February) temperatures vary between a maximum of 20 - 30°C and a minimum of 4 - 10°C. Measurements were taken in March 1990, when the outdoor temperature varied between 21°C at night and 35°C in daytime.

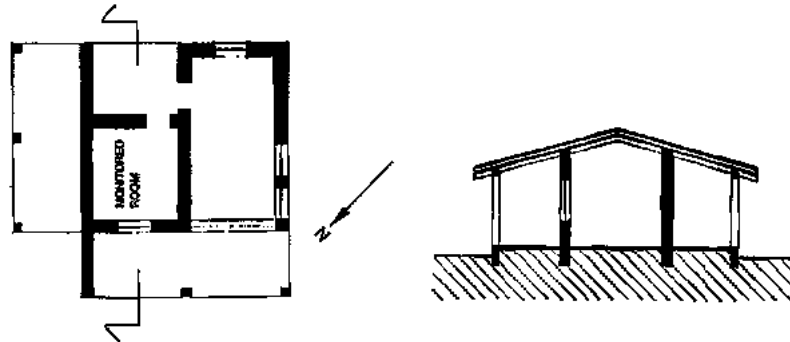
### 4.3.2 The monitored buildings

The four houses that were compared are all residential buildings of single story structures.

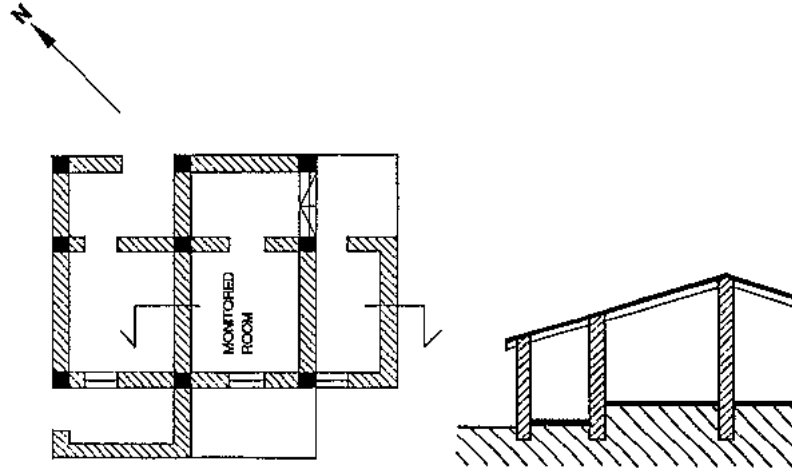


**Fig 4/10 House 1**

- **Ratio window to floor area: 30%**
- **Walls: Brick, white plastered on outside, 30 cm; little sun protection on the southern side.**
- **Roof: Clay tiles**
- **Ventilation: Good**
- **Floor: Mud**

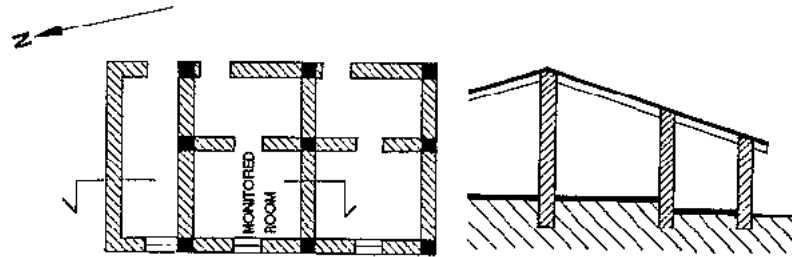
**Fig 4/11**

- **Ratio window to floor area: 28%**
- **Walls: Brick, white plastered on outside, 40 cm.**
- **Roof: Double FCR sheet with 8 cm ventilation space (FCR = Fibre Concrete Roofing, 10 mm thick).**
- **Ventilation: Poor to moderate**
- **Floor: Mud**



**Fig 4/12 House 3**

- **Ratio window to floor area: 16%**
- **Walls: Brick pillar structure with clay infill, 40 cm; outside color brown.**
- **Roof: Single FCR sheet**
- **Ventilation: Moderate**
- **Floor: Mud**



**Fig 4/13 House 4**

- **Ratio window to floor area: 21%**
- **Walls: Brick pillar structure with clay infill, 40 cm; outside color brown, large storage mass.**
- **Roof: Single FCR sheet, alternatively clay tiles**
- **Ventilation: Moderate**
- **Floor: Mud**

#### **4.3.3 Climatic performance and conclusions**

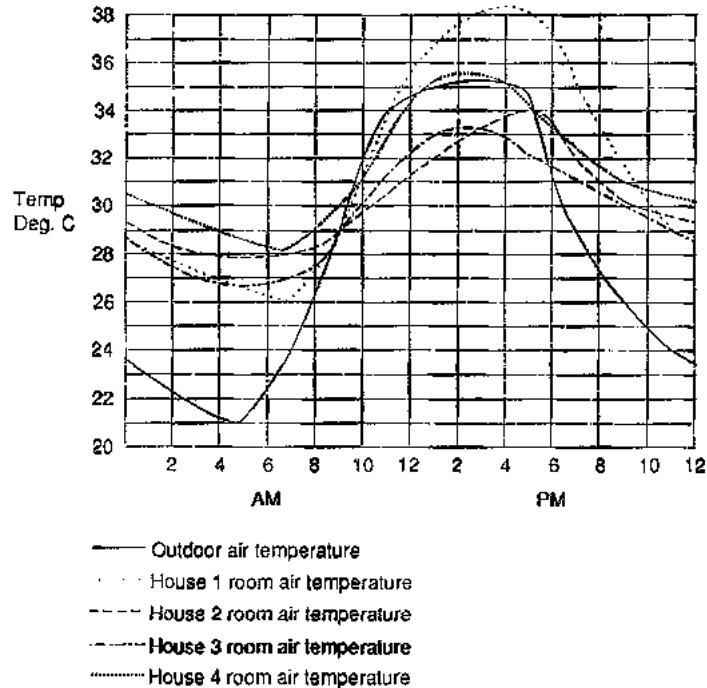


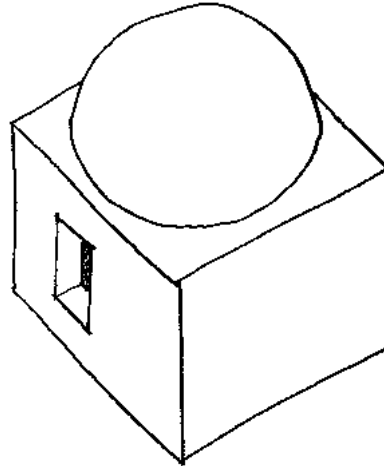
Fig 4/14

- During the daytime, house 1 is clearly hotter than all the others, up to 6°C. This is mainly due to the unprotected southern wall and window with very little roof overhang. The reduced thermal storage capacity and insulation of the outer walls (thinner walls) are also contributing factors.
- No difference could be observed between FCR roofing and clay tile roofing.



- **Although no clear difference between double FCR sheeting and single sheeting could be observed, there is a clear advantage with double sheeting because of the lower inner surface temperature. This was not measured, but observation by the inhabitants supports it. Moreover, recent research works at the CECAT in Habana, Cuba, have shown, that in such a case the inner surface temperature of a ventilated double sheeting construction is lower by approximately 8°C.**
- **At night all houses perform similarly and have a temperature about 6°C higher than the outside temperature. This is due to the relatively high thermal storage capacity. House 1 with the least storage capacity is slightly cooler. With increased night ventilation it might be possible to decrease night temperatures.**
- **Houses with mud-walls are clearly superior in the daytime compared to brick structures because of the larger storage mass and also because they are less ventilated. The performance at night could be further improved by increased ventilation, but the inhabitants are not concerned because they sleep outdoors.**

#### **4.4 Experiments in Cairo, Egypt**



**Figure**

**The main points:**

- **A concrete structure of extremely poor design is compared to a well-designed mud structure.**
- **In contrast to the mud structure, the performance of the concrete structure is drastically different, being very hot in daytime and cold at night.**
- **The difference is obvious both for the air temperature and for the surface temperature.**

**Source: Research group under the leadership of John Norton, Development Workshop, Lauzerte, France**

**4.4.1 The project**

**Cairo lies in a maritime desert region. It is only a few metres above sea level and at a latitude of 30° North.**

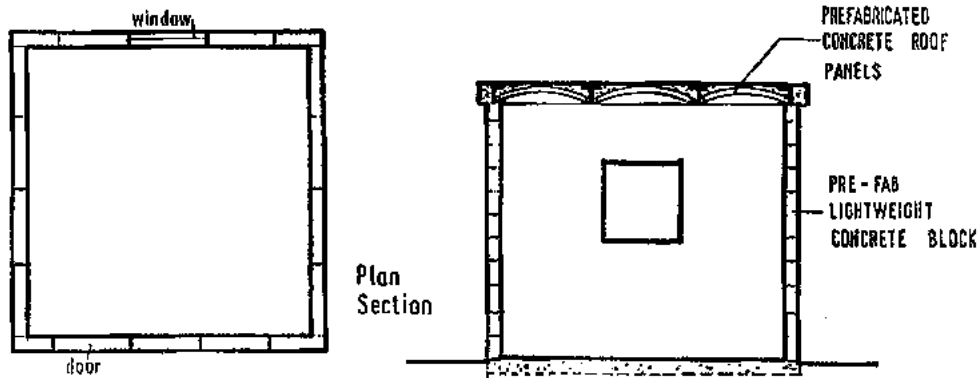
**In the 1970s, several experimental rooms were constructed at the Building Research Center in Cairo to test prototype building solutions for poor rural areas in developing countries. Among the rooms built was one of mud brick vault and dome construction and another of prefabricated concrete slab construction, illustrating the contradictory proposals for rural development. One proposed a reinstatement of traditional modes of construction and the other an importation of ideas and materials from outside.**

**The mud brick structure was built by Professor Hassan Fahty, who used similar design features in many of his projects.**

**The researchers undertook comparative measurements of the thermal performance of these buildings. The tests were done at the end of March, thus the extreme temperatures of the climate in Cairo were not recorded. However, the results illustrate clearly the different performances of the two test rooms. Since each test room was built in an open space by itself, and each is oriented in the same direction, they can be considered to be affected by the same climatic factors and thus directly comparable.**

#### **4.4.2 The experimental buildings and test configuration**

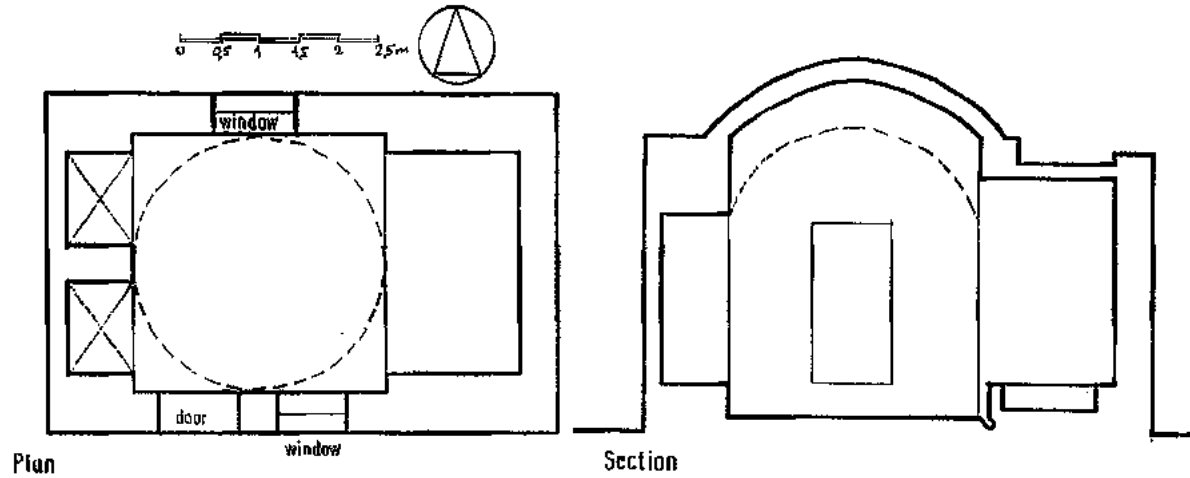
**The prefabricated concrete test room consists of light weight concrete block walls 15 cm thick and a roof made of reinforced concrete with a prefabricated roof panel system.**



**Fig 4/15 Prefabricated concrete test room**

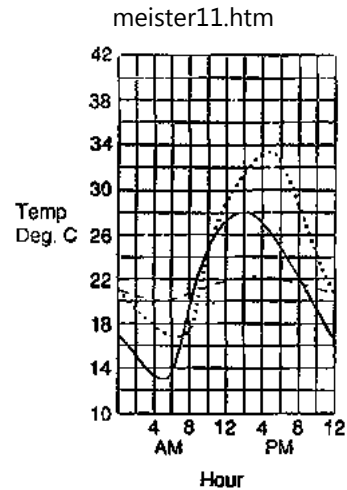
**The mud brick room consists of a lime stone foundation, walls of sun dried mud bricks 50 cm thick and a roof with a dome and vault shape made of the same material.**

**The first step in the recorded experiment was to close the doors and windows of the two test rooms. The house stayed closed for at least 24 hours to allow the air temperature in the rooms to stabilize and not be constantly renewed by air movement and wind. In this way the influence of heat transfer through the shell could be studied in an undisturbed manner.**



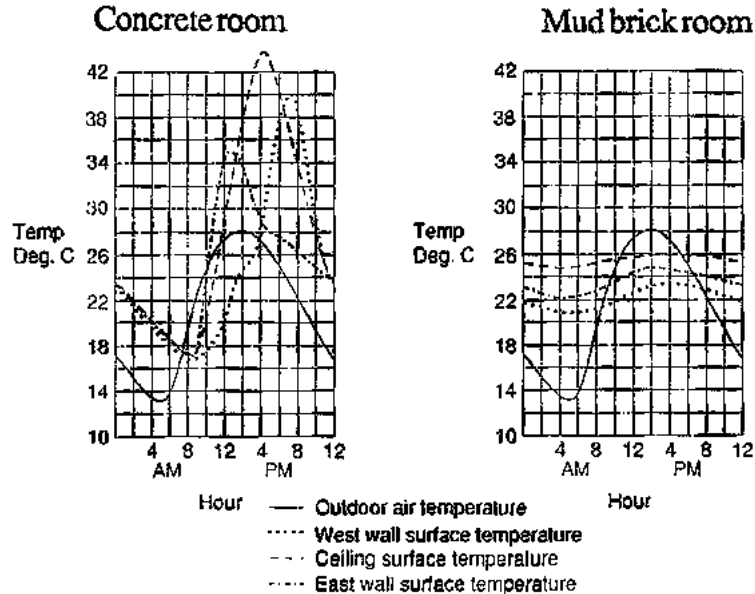
**Fig 4/16 Sun dried mud brick vault and dome test room**

### **4.4.3 Climatic performance**



— Outdoor air temperature  
..... concrete room air temperature  
- - - Mud brick room air temperature

**Fig 4/17 Air temperature**



**Fig 4/18 Inside surface temperatures at concrete room (left) and mud brick room (right),**

#### **4.4.4 Conclusions**

**The tests show an impressive difference in the performance of the concrete structure and the mud structure. Whereas the temperature in the mud structure fluctuates by a few degrees only, in the case of the concrete structure the temperature varies between extremely high and very low. In practice, the difference may be somewhat less because air changes would increase the fluctuation of the temperature in the mud room; however, a clear difference would still remain.**

**As well as the air temperature the surface temperatures of the walls and the ceiling have to be noted. The temperatures on the outer surface (not shown in the graphs) are similar in both cases, but the temperatures on the inner surface are as drastically different as the air temperatures. This is an important factor because radiant heat from inner surfaces adds considerably to the comfort level. Furthermore it demonstrates the effect of the high thermal resistance (U-value) of the mud wall.**

**This example illustrates that a heavy structure with thermal properties similar to the mud room tends to have indoor temperatures close to the average outdoor temperature. As a consequence, such a room would need daytime ventilation during the cold period and nighttime ventilation during the hot period. In this way, an all year round acceptable indoor climate could be provided.**

**The lightweight structure, on the other hand, can hardly be regulated by ventilation because its storage capacity is not sufficient to store the heat surplus of hot days until nighttime in winter, and to keep the cool of the night until daytime in the summer. Such a structure would, however, be suitable as a temporary room, to be used alternatively at nighttime during the hot period and in daytime during the cold period.**

**The concrete structure monitored here is, of course, of extremely poor design. It cannot be concluded that modern structures in general would perform the same way. As seen in Example 4.7, a modern structure can also perform similarly to a mud structure, if it is well designed and sufficiently insulated.**

#### **4.5 Buildings in the Dominican Republic**

**The main points:**

- **The corrugated iron sheet roof is extremely hot in the daytime.**



- **Palm leaf roofs and MCR roofs perform similarly.**
- **The vault roof is warm in the morning, evening and night, and similar to MCR and palm leaf roofs in the daytime.**
- **The measured differences are smaller than subjectively perceived, probably because the variation of the surface temperatures are higher.**

**Source: Grupo Sofonias, Kurt Rhyner-Pozak and Martin Melendez**

#### **4.5.1 Geographical location and climatic characteristics**

**The monitored houses are in the south of the Dominican Republic (Province of San Juan) where the climate is semi-arid with hot and strong winds.**

**The diurnal temperature range is extremely wide. In the hot season the temperature rises up to 50°C and drops at night to about 20 to 30°C, in the cool season it fluctuates between 30 to 35°C in the daytime and around 20°C at night.**

#### **4.5.2 The monitored buildings**

**The indoor air temperatures in four different houses were monitored**

**House A : Palm leaves**

**A simple hut which is typical for the poor segment of the population, with walls wooden of wickerwork plastered with mud and a roof of palm leaves. The wind blows rather freely through the house.**

**House B : CGI**

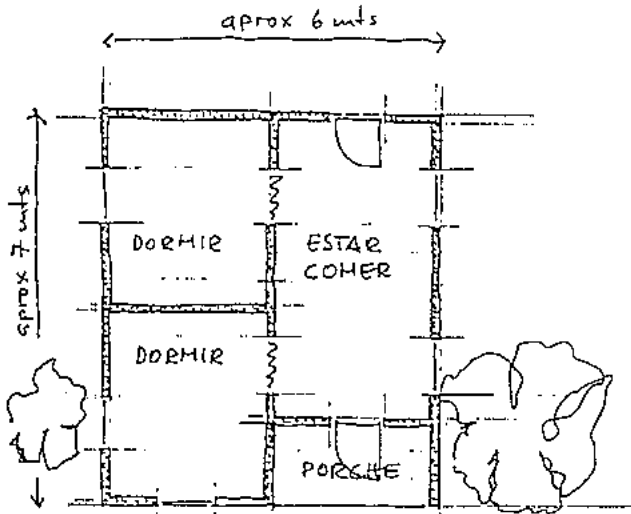
**A house with walls of wooden boards and roofed with corrugated galvanized iron sheeting. The wind blows rather freely through the house.**

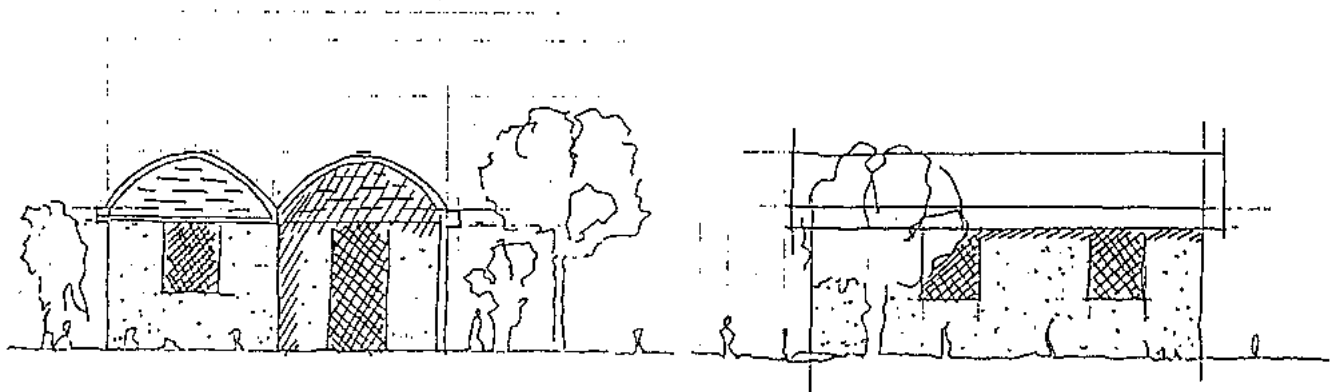
### **House C : Vault**

**The "Sofonias Project House" consisting of massive walls of stone or brick masonry with a 8 cm thick vault roof made of bricks**

### **House D : MCR**

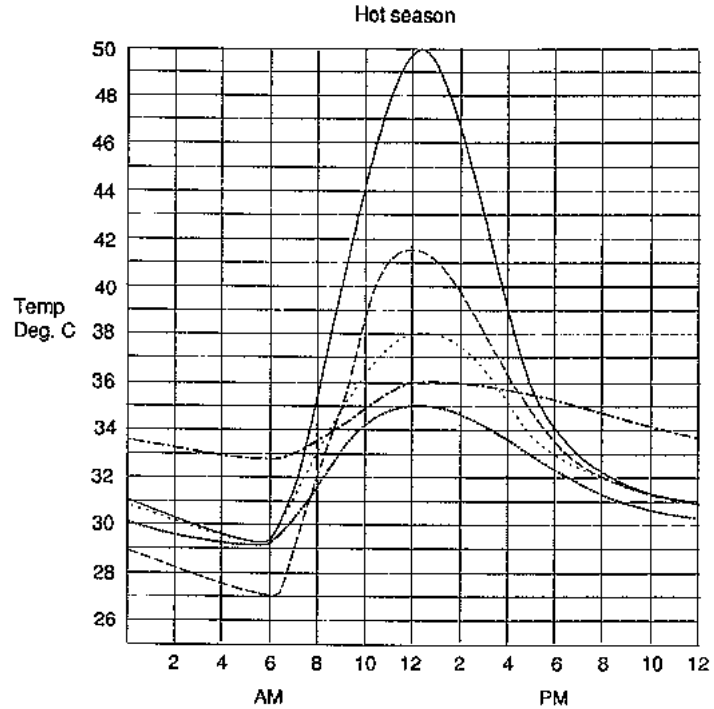
**A house with masonry walls roofed with micro-concrete tiles.**





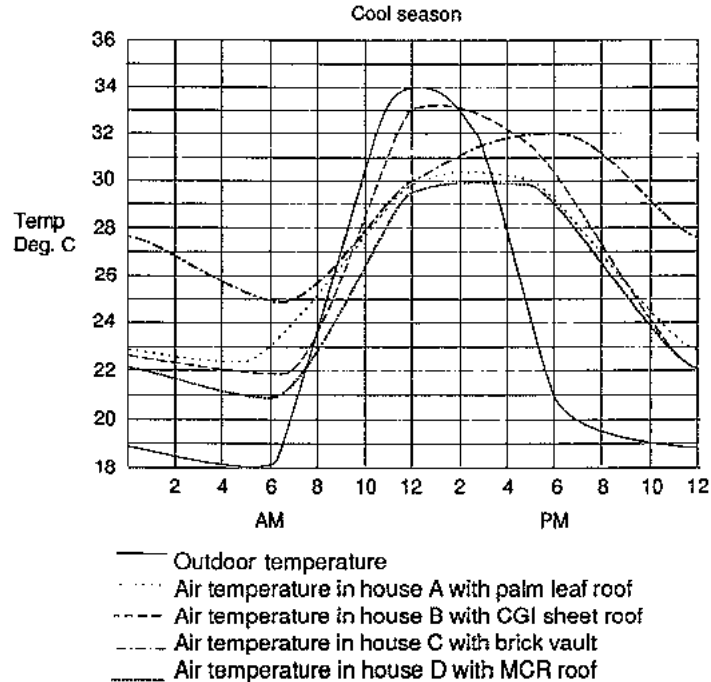
**Fig 4/19 Plan and front elevation of house C**

### **4.5.3 Climatic performance**



**Fig 4/20 Performance in the hot season**

**Cool season**



**Fig 4/21 Performance in the cool season**

#### 4.5.4 Conclusions

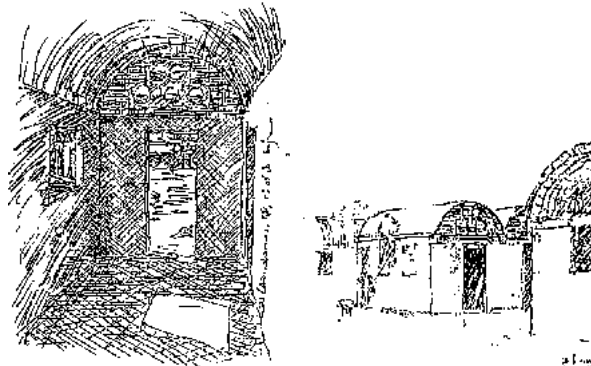
**This section illustrates clearly the influence of different roofing materials.**

**It is not surprising that the metal roof performs worst, being clearly the hottest in the daytime and the coldest at night.**

**The difference between the other three materials appears not to be very significant. Palm leaf and MCR roofs are very similar. The palm leaf roof is slightly warmer, most probably because of the generally poor quality of the building.**

**The brick vault roof keeps the house much warmer at night, and the time lag in the evening is clearly seen. In daytime it performs similarly to the palm leaf and MCR roof, although subjective feelings would suggest that it is cooler in daytime. The reason might be that the surface temperature of the vault is lower.**

**The diurnal temperature swing in the vault house is smallest, but still much larger than in the examples in Chapter 4.1 and 4.4. This can be explained by the rather thin brick structure of 8 cm .**



**Fig 4/22 House C, perspective view**

## **4.6 Buildings in Kathmandu, Nepal**

### **The main points:**

- **In buildings with adequate storage mass, insulation and control of solar radiation, the temperature is acceptable in summer and winter, except for cold nights where an additional heating source is required. This is in sharp contrast to poorly-designed buildings.**
- **A well-designed building is up to 7°C cooler in summer than the poorly-designed “concrete box”.**
- **A floor heating system with passive solar collectors - the collectors measuring 1/3rd of the floor area - increases the temperature in winter by 10°C.**

**Source: Paul Gut**

#### **4.6.1 Geographical location and climatic characteristics**

**Kathmandu lies at an altitude of 1350 m and a latitude of 28°-North. It is situated in a wide valley of about 20 km circumference, surrounded by hills reaching up to 3000 m height.**

**The climate is characterized by three main seasons:**

- **In winter-time temperatures are relatively low, ranging between 0°C at night and 15 to 20°C in the daytime. Sometimes light frost appears over clear nights. The cold air lake phenomenon, which is typical for a valley location like Kathmandu, keeps temperatures between December and February uncomfortably low. However, the frequent and strong solar radiation, which is common during this season, improves the situation and provides an excellent opportunity for passive solar room conditioning.**
- **The pre-monsoon season is hot and dusty, mainly in May and the first half of June. Temperatures rise up to 35°C in daytime and drop to around 20°C at night. The solar**

**radiation is often intense, and protection is required. During this season dusty storms are frequent.**

**• During the monsoon season temperatures hardly reach 30°C and the diurnal differences are less. Periods of pouring rain and heavy clouds alternate with periods of clear sky and glaring sunshine. The humidity is high and proper ventilation is required.**

### **Design response**

**Considering the climatic conditions which change drastically with the seasons, the design concept of a building should respond to these differences.**

### **Cold season requirements**

**Passive solar heat gain is welcome during the cold season. The main rooms and the large windows should be south oriented. To provide an acceptable indoor climate in winter, buildings usually require active heating as well, unless they are very well designed and equipped with special passive solar heating devices. The heat storage capacity should be moderate, not too excessive; otherwise the space becomes non-heatable. Airtight construction is another important aspect; it is more important than the thermal insulation properties. Inner surfaces should not be highly conductive which would result in low surface temperature and uncomfortably high conductive heat losses from the human body when in contact.**

### **Hot season requirements**

**During the hot season protection against solar radiation is necessary. Windows should be shaded and a proper cross-ventilation should allow accumulated heat to escape in the evening. Here again, a moderate heat storage capacity is appropriate, keeping the daytime indoor temperature at tolerable levels.**



**Special care is required in the design of the roof. Its inner surface should not heat up too much and it should not store much heat. The worst solution is the plain concrete roof slab, which is a common solution these days. It heats up to extreme temperatures and makes living conditions during the evening unbearable.**

**During the monsoon period the most important factor is cross-ventilation**

#### **4.6.2 The monitored buildings**

**To illustrate the effect that different design features have on the indoor climate, two different buildings have been evaluated under winter conditions (building A and B).**

**In the summer season the performance of two additional buildings has also been recorded. (buildings A, B, C and D).**

##### **Building A**

**A modern residential house, located on a southern slope with mainly south-oriented rooms. The main windows also face south and are partly protected by overhangs from the summer sun. The walls consist of 35 cm thick solid brick masonry; fair-faced outside and inside, with lime white wash on the inside. The floors are made of timber beams supporting brick vaults, covered with clay flooring tiles. The roof is pitched, covered with clay tiles and with timber panelling inside.**

**The windows are made of specially well seasoned timber (timber from a dismantled old building) and are built with double grooves for air tightness, equipped with imported fittings.**

**An interesting feature is the solar floor heating system in the living room which works entirely passively as a thermo-syphon, even without a regulatory mechanism. The system**

is described in more detail at the end of this chapter.

(Mana Niwas, Arch: P. Gut, built in 1980)

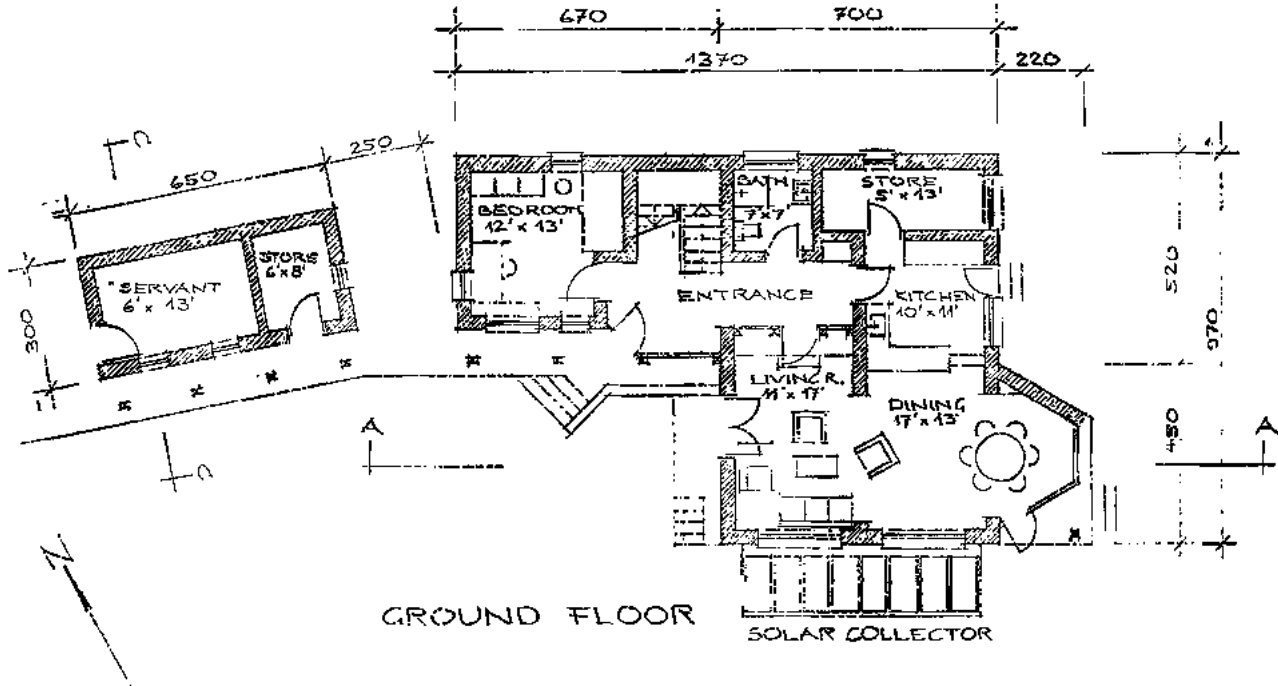


Fig 4/23 Building A

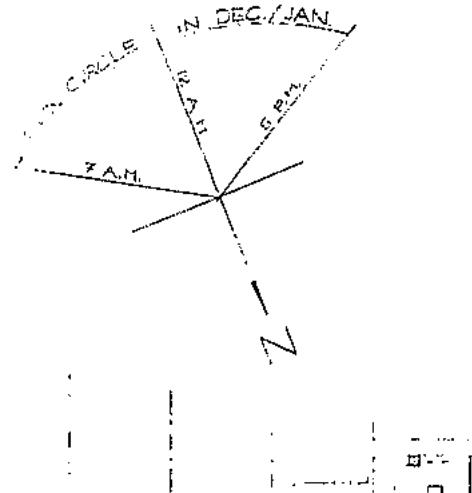
Building B

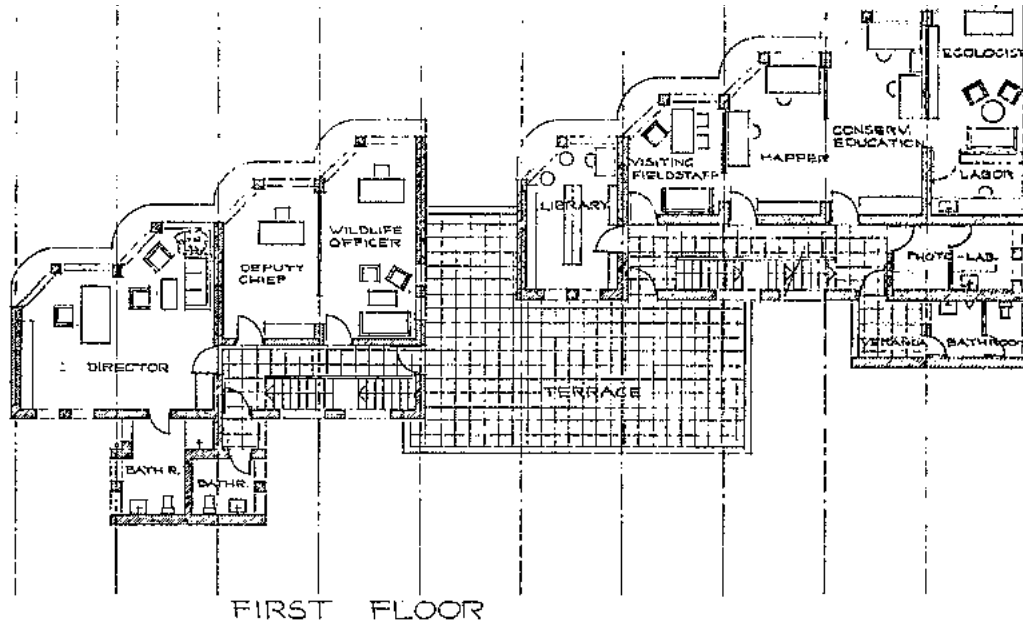
**This is an office building, hence only the thermal performance in daytime is of relevance. Of special importance is a increased temperature during the winter mornings, when most buildings are freezing cold and non-heatable, thus it becomes extremely difficult to work in.**

**As a consequence, all offices are located on the main front which is oriented south-south-east. This elevation is designed in such a way that all windows receive winter sun, from sunrise to sunset. During summer an overhanging curved slab shades the windows entirely. Deciduous trees in front of the building help to control the effects of the sun.**

**The walls consist of 35 cm solid brickwork, the floor slabs are of concrete and the flat roof is additionally covered with a 5 to 10 cm thick screeding and clay tiles.**

**(National Parks Department Headquarter Building, Arch: P. Gut, built in 1981)**





**Fig 4/24 Building B**

### **Building D**

**This old palace with small windows and massive, 70 cm thick brick walls. Floors are of timber structure with a thick layer of mud covered with clay tiles. The room monitored is south facing.**

### **Building D**

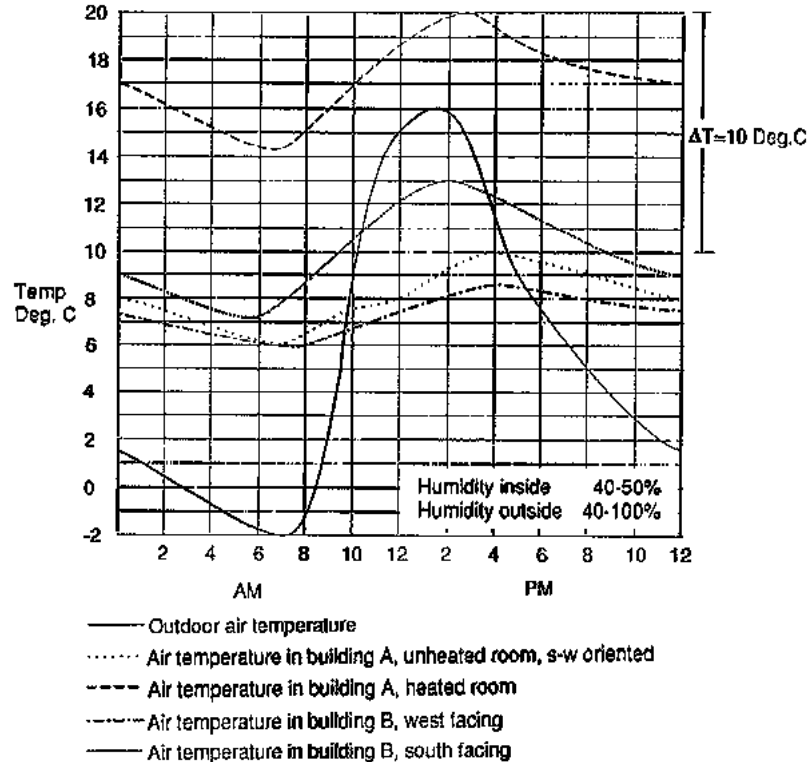
**This building is a modern bungalow of "international concrete box" type. The walls are of**

**35 cm brick masonry, the windows are rather large with only minimal protection from the summer sun. The roof slab is of 12 cm plain concrete without any cover. Climatic considerations were not applied.**

**This type of building is the most common solution for modern development in Kathmandu, as well as in many other places in the developing world.**

#### **4.6.3 Climatic performance and conclusions**

**Summer:**



**Fig 4/25 Climatic performance in early June, the hottest period of the year**

**The outside temperature varies between 19 and 34°C, hence the average temperature more-or-less lies within the comfort zone.**

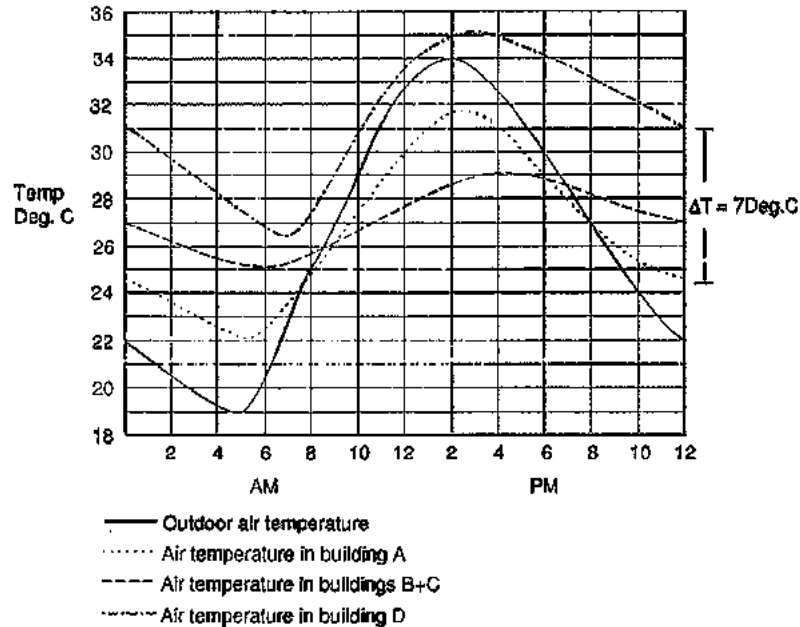
**The buildings B and C show the most even temperature swing, slightly above the average**

**temperature. This is due to the consistent shading of the windows in the case of building B and due to the excessive heat storage capacity of building C.**

**Building A shows somewhat higher daytime temperatures because of windows facing east and west which are less protected against solar radiation. These windows, on the other hand, allow for a better ventilation at nighttime, resulting in more comfortable conditions during the night.**

**Clearly worse is the performance of building D. Due to poor protection of the windows against solar radiation, and mainly due to the non-insulated flat concrete roof, temperatures constantly lie above the outside temperature and above comfort level. Characteristically, the temperature remains high during the evening, the greatest difference, compared to building A, reaches 7°C at midnight. In addition to the high air temperature the high surface temperature of the concrete ceiling has to be considered, which is not expressed in the diagram. The inner surface of such concrete roofs reaches temperatures up to 50 or 60°C, resulting in unbearable indoor climatic conditions due to radiant heat.**

**Winter**



**Fig 4/26 Climatic performance in January, the coldest period of the year**

Whereas the outdoor temperature varies between  $-2^{\circ}\text{C}$  and  $16^{\circ}\text{C}$ , the temperature in an unheated, west facing room in house A is rather even, at the uncomfortable low level of 6 to  $10^{\circ}\text{C}$ .

During the day the temperature of house B lies at about  $5^{\circ}\text{C}$  above this level due to the consequent utilization of direct solar heat gain through the windows. The temperature during working hours for an office building is still low but bearable, due to the direct solar radiation in the rooms.



**The living room of house A, which is equipped with a solar floor heating system, performs well with temperatures about 10°C higher, thus lying within the comfort zone. The surface temperature of the floor, which varies between 20 and 28°C, is a further contribution to the comfortable climate.**

#### **4.6.4 The solar space heating system**

**House A is equipped with a passive floor heating system. It heats the main living room during the unpleasantly cool winter months. The system consists of a flat water heating solar collector situated in front of the room at a lower level. It works entirely passively on a thermosyphonic basis, without a pump and even without regulating instruments. As experiences over 10 years have shown, the system works extremely reliably and gives no problems with regard to maintenance.**

**The total collector surface measures 9 m<sup>2</sup>, that is 28% of the floor area of the heated room. In January the total solar energy received by the collector amounts to about 5 kWh/m<sup>2</sup> per day with a peak of 900 W/m<sup>2</sup>.**

**The collector is divided into 8 elements, each working independently with a separate steel pipe loop laid in the floor of the room. These 8 loops, although covering the entire floor area, are short and thus guarantee a reliable circulation of heated water. The only mechanical parts of the system are the three-way valves which are necessary to switch from winter to summer operation. Each of the 8 collector elements can be individually controlled; thus a fine regulation of the system is possible.**

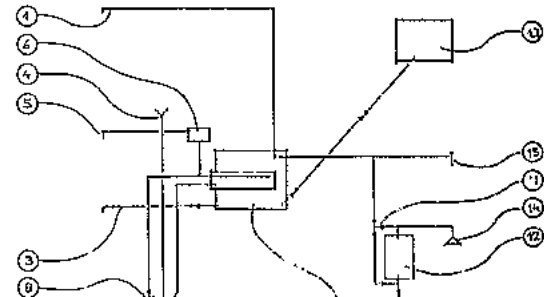
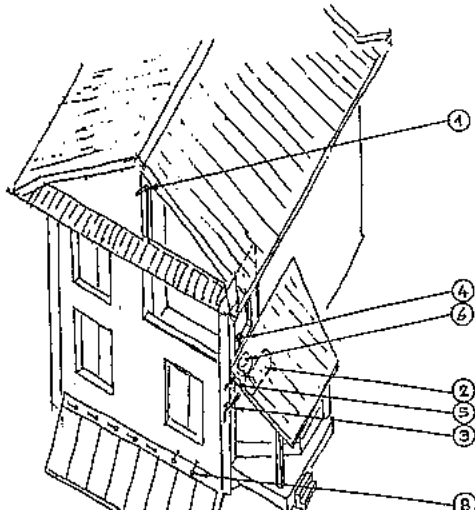
**During the warm seasons the collected heat is diverted by these valves to a boiler which is equipped with a heat exchanger, providing pre-heated water to the electric drinking water boiler.**

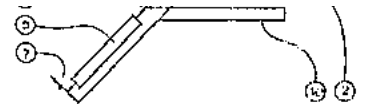
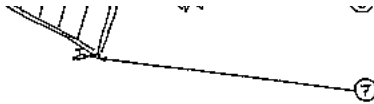
**Except for the three-way valves, all parts of the system are produced in a local workshop.**

**This suggests a low technological level resulting in a probably somewhat lower efficiency, compensated by the dimensioning of the collector surface. On the other hand, this has kept costs down to a reasonable level.**

**The adjoining structural elements are also of local manufacture, without imported insulation materials. The floor structure consists of a layer of boulders covered by a 40 cm thick layer of brick waste collected from the construction site. On top of this the heating pipes were laid in sand and carefully levelled to avoid backslope. Clay flooring tiles laid in a concrete screed form the floor finish.**

**This structure provides a moderate heat insulation and a large thermal mass resulting in a very inert thermal performance. Overheating of the room and also of the floor surface is avoided. The floor surface temperature never rises above 30°C.**





- |    |  |     |                                      |
|----|--|-----|--------------------------------------|
| 1. | Vent pipe solar boiler                                 | 9.  | Solar panel                          |
| 2. | Solar boiler with heat exchanger, 200 l.               | 10. | Heating coil in floor of living room |
| 3. | Drain solar boiler                                     | 11. | Regulating valve to electric boiler  |
| 4. | Vent pipe and refill neck of solar system              | 12. | Electric boiler                      |
| 5. | Overflow of solar system                               | 13. | Overhead tank, 2500 l.               |
| 6. | Expansion tank solar system, 20 l.                     | 14. | Hot water points in bathrooms        |
| 7. | Drain solar system                                     | 15. | Hot water tap in kitchen             |
| 8. | Regulating valve solar system (winter/summer function) |     |                                      |

**Fig 4/27 The solar space heating system**

## 4.7 Buildings in New Delhi, India

### The main points:

- A well-designed mud structure with arches, domes etc. performs similarly to a well-designed and insulated modern concrete/brick structure.
- Asbestos sheet roofing and fibre concrete roofing are hot in daytime and cool at night. In winter they are clearly too cool. Additional insulation would be appropriate.

**Source: Development Alternatives, New Delhi, monitoring by Dr.-Arun Kumar, Vaidyanathan Geeta, Sanjay Prakash**

### 4.7.1 Geographical location and climatic characteristics

**New Delhi is located on the plain at an altitude of 200 m above sea level and a latitude of 28° North.**

**The climate is characterized by a hot and dry season in early summer determined by hot winds from the Thar desert in Rajasthan, with temperatures between a mean maximum of 32°C and 43°C and a mean minimum of 21°C to 27°C. In winter the cold, northern winds from the Himalayans dominate the climate. The temperature fluctuates between 20°C - 27°C in daytime and 4°C - 10°C at night. In between these two extremes there is a period of moderate temperatures. This includes the monsoon period during which the humidity is very high and most of the precipitation falls.**

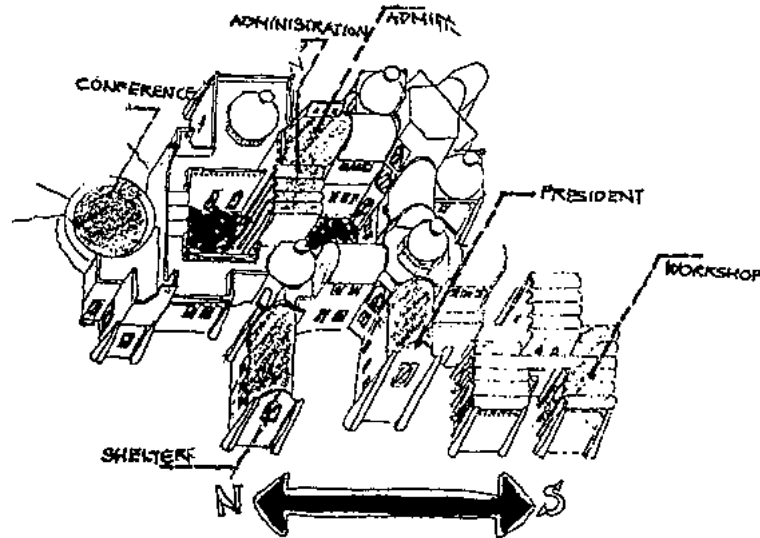
#### **4.7.2 The monitored buildings**

**During the two climatically extreme seasons several building systems were monitored.**

##### **Building A**

###### **Earth construction**

**Various rooms of the headquarter building of "Development Alternatives" have been examined. The complex is located in the vicinity of a green belt in the Institutional Area of southern Delhi. The overall character of the building is determined by its strong roof forms which are a result of the materials used, mainly unburnt earth in the form of adobe and stabilized soil blocks. Many different systems have been applied in the building such as domes, vaults and also flat roofs. The walls are made of soil blocks laid in mud mortar, 23 to 35 cm thick. Floors are made using various options: sandstone slabs on concrete beams, prefabricated concrete jack arches or concrete slabs. Window openings are relatively small, just sufficient for natural lighting. They are arranged to allow a proper cross-ventilation. (Description of the building project see [ 160 ] )**

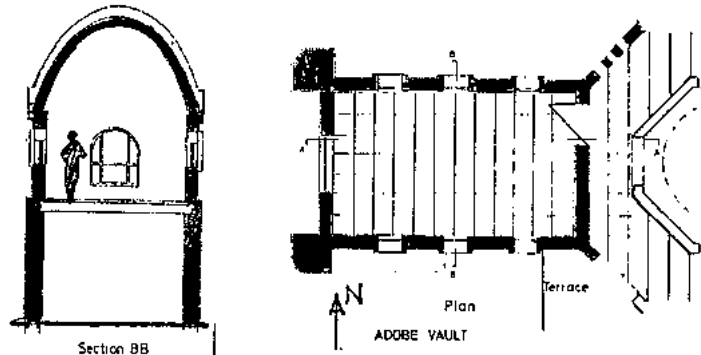


**Fig 4/28 General view**

**By comparing the thermal performance, two rooms give interesting results:**

### **Room A1**

**A room with a Nubian vault made with adobe blocks of 12-cm thickness, rendered on the inside with a lime-based plaster of a natural brown color and on the outside with a regular 15 mm cement plaster over a chicken wire mesh as a waterproofing membrane. The room is exposed to the outside on three sides, the side walls face north and south. The outer shell is painted white and contributes to the solar radiation reflectance.**

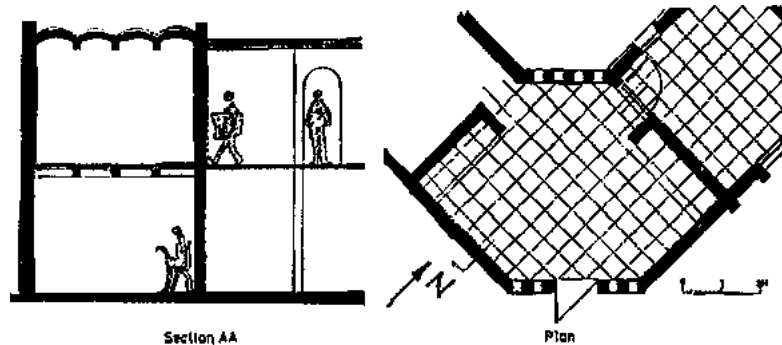


**Fig 4/29 The Nubian vault, room-A1**

## Room A2

**A room with a roof made of jack arches of 12 cm thick stabilized soil blocks. The arches rest on concrete beams and are covered with 10 cm lime and brick bat concrete, followed by a coat of marble dust in lime water and then a nominal layer of cement-based plaster. Further waterproofing has been achieved using a bitumen based compound. The outer shell has been painted white.**

**Only a small portion of the walls is exposed to the outside, on the S-W side and on the S-E side.**



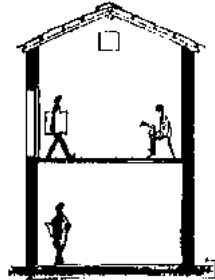
**Fig 4/30 Jack arch, room A2**

## **Building B**

### **Fibre Concrete Roofing (FCR) / Corrugated Asbestos Cement roofing (ACC)**

**The Micro Model Unit of the Indian Institute of Technology was also selected for this study. It is located in a fairly low density area with a lot of open space. The monitored room is oriented along the east-west axis and is exposed on three sides to the weather. The structure consists of a load bearing frame made of burnt brick with soil block infill, 23 cm thick, rendered with mud plaster. The windows are fairly large, because the room is used as an architectural studio which requires good natural lighting. The roof consist of a timber structure covered with 8 mm thick Fibre Concrete Tiles. There is no ceiling. The floor slab is of concrete.**

**A similar structure with a corrugated asbestos cement roofing was also monitored. However, the performance was similar to that of FCR.**



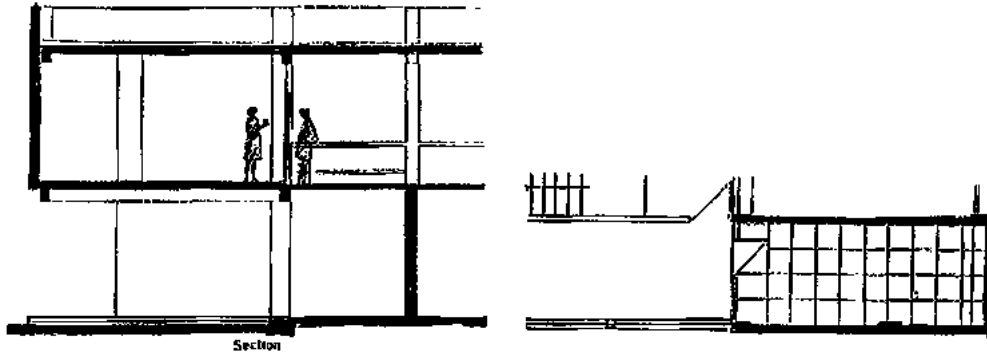
**Fig 4/31 Building B**

### **Building C**

**This is a conventional concrete and brick structure with flat roof. The building accommodates the Working Women's Hostel "Prabhatar" and is located in a residential area. It consists of a concrete slab and frame structure with 23 cm thick brick walls, Fare faced on the outside and cement plastered on the inside. The room selected is located on the top floor with the east and north walls exposed, while the south side opens onto a corridor. The west wall is shared by an adjoining room.**

**The roof is a flat concrete slab, 10 cm thick, with a waterproofing 20 cm thick, including the base concrete and brick tile finish. The window opens towards the corridor on the south side which is open at each end. The space below the test room is an open passage.**

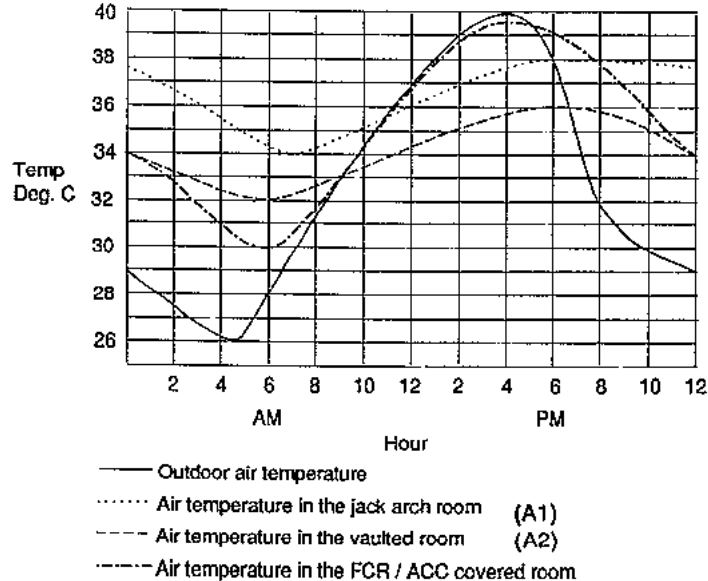




**Fig 4/32 Building C**

### **4.7.3 Climatic performance and conclusions**

Summer:



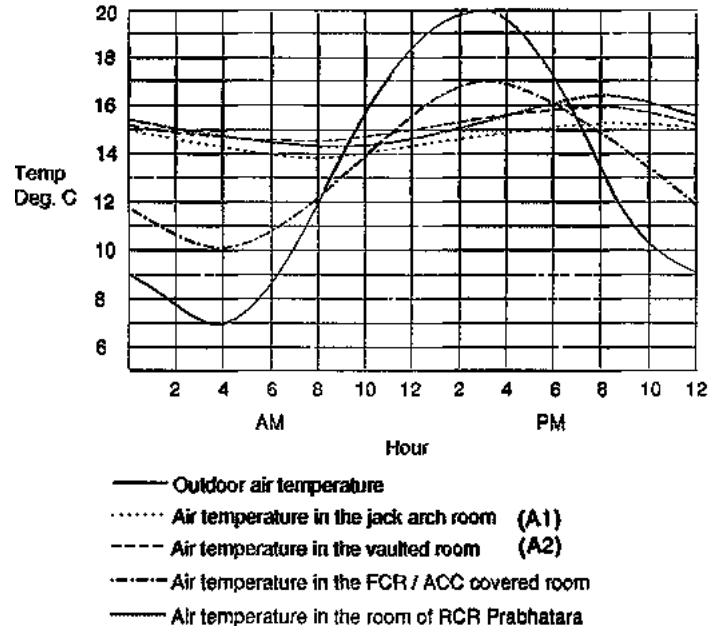
**Fig 4/33 Performance in summer**

## Conclusions

- **The indoor temperatures are generally very high compared to the performance monitored in the Dominican Republic (4.1.5). This can be attributed to the fact that while the Dominican Republic is a coastal area, New Delhi is land-locked and there is no appreciable cool night breeze flowing from the sea, as would be the case in coastal areas.**

- The light roof (FCR / ACC) becomes hot in the daytime and cools down at night (damping effect 0.7) compared to heavy structures (damping effect 0.3). The daytime temperature is similar to the outdoor temperature.
- The jack arch room is generally hotter than the vault room, probably because the former is a more enclosed room. The ratio of surface area to volume being smaller for the Jack arch roofed room, the heat loss at night is less, resulting in the room being hotter.

Winter



## **Fig 4/34 Performance in winter**

### **Conclusions**

- **A well constructed conventional building (Prabhatara) performs similarly to the earth construction with vault or jack arch.**
- **Heavy structures have almost no temperature variance between day and night.**
- **Light roofs become slightly warmer in the daytime, but much cooler at night.**

### **Surface temperature**

**During this study, some isolated recordings of the surface temperatures have also been carried out. These could not be included in the presentation because they are not comprehensive enough. However, in addition to its importance with regard to thermal comfort, it has been clearly shown that surface temperature readings would provide more reliable information about the qualities of a wall or roof system because the air temperature and its time lag is heavily influenced by the variables of door and window openings.**

### **4.8 Movable louvres for a school in Kathmandu, Nepal**

#### **Design: P. Gut**

**The climatic conditions in Kathmandu (see Chapter 4.6) with warm summers and cool but sunny winters suggest itself, to improve the indoor climate by simple means of solar radiation control.**

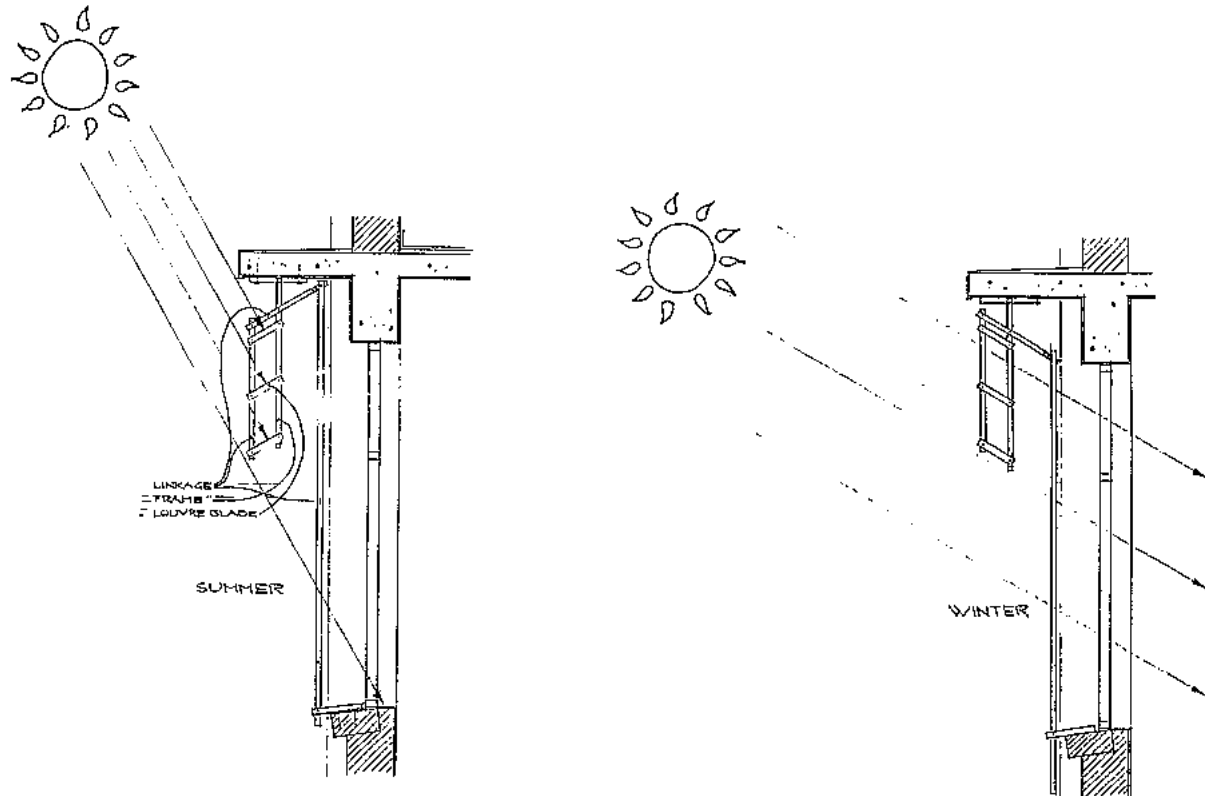
**For this purpose, a simple system of movable metal louvres has ben designed in such a way, that local mechanical workshops can easily manufacture it, thus expensive, imported**

**parts are not required.**

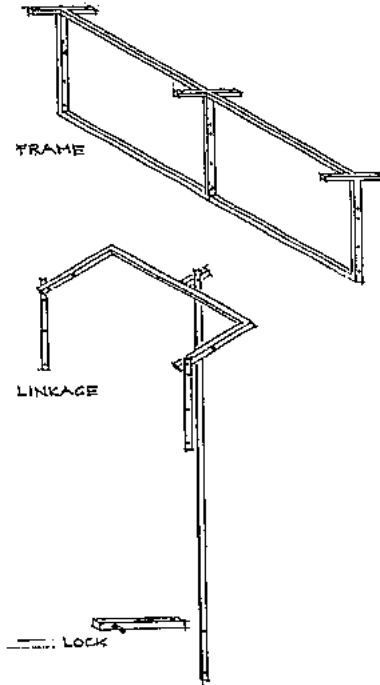
**The louvres can be operated through the open window by simply shifting a metal bar linkage. The louvres can be arrested in two positions, for summer and winter. The winter position allows to enter the solar radiation unhindered, whereas the summer position shades the window completely.**

**Because the climate in Kathmandu is regular, it is assumed, that the louvres have not to be moved often, but not much more than once in spring and once in fall.**

**So far, the performance of this system could not be monitored, because the buildings are (in 1992) still under construction.**



**Fig 4/35 Summer and winter position**



**Fig 4/36 Mounting support, isometric view**

## **4.9 Mountain hut in Langtang National Park, Nepal**

**The main points:**

**In spite of its sophisticated design the building does not fully fulfill expectations, because:**

- the system of heating air by a passive solar collector is not efficient enough;
- the users are generally careless about heat conservation and do not close doors.

This house was built in 1979, at an altitude of 4000-m. The southern elevation is fully glazed, consisting of 1/3rd windows and of 2/3rd solar collectors as a solar wall for space heating. Because of the severe climate at this altitude (below zero) the collectors were designed as air heaters.

Other climatic design features were also applied:

- Curved south front for wind protection
- Buffer zones on east and west side
- built-in to the slope on the north side

Experience has shown that the concept was not fully successful:

- The human factor was not sufficiently considered; for instance the outer doors were never closed.
- Mice had blocked the air-ducts with rice which they collect and store in the inaccessible parts of the ducts.
- The efficiency of air-heating compared to water-heating systems is low.







