

Compressed Earth Block - Volume I. Manual of production (GTZ, 1995, 104 p.)



(introduction...)



Acknowledgements



Preface



Introduction

Historical background

Advantages of ceps

Key questions

Production

Production lines

The material

Principle CEB characteristics

Launching production

The development of the material

Earth - An architectural tradition



Soil

Soil for building purposes

























Properties























Typical soils









Behaviour of soils in the presence of water

Hydrous states of a soil

Prospecting

-  **Identification: Laboratory tests**
-  **Identification: Field tests**
-  **Stabilization**
 -  **General considerations**
 -  **Different ways of stabilizing and stabilizers**
 -  **Cement stabilization**
 -  **Lime stabilization**
 -  **Calculating how much stabilizer to use**
-  **Equipment**
 -  **Selection criteria**
 -  **Products**
 -  **Uses**
 -  **Choosing a press**
 -  **Choosing soil preparation equipment**
-  **Production layout**
 -  **Definition of the production line**
 -  **Types of equipment**
 -  **Manufacturing means**
 -  **Types of production line**
 -  **Investments**
 -  **Semi-mechanized brickworks**
 -  **Semi-mechanized brickworks with mobile presses**
 -  **Fully mechanized brickworks**
-  **Production**
 - 









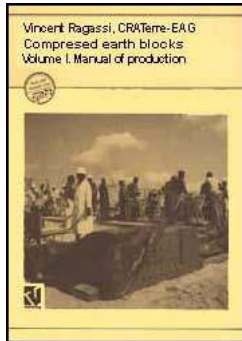



-  **Soil extraction**
-  **Transport**
-  **Stocking raw materials**
-  **Manual preparation**
-  **Motorized preparation**
-  **Measuring out**
-  **Mixing**
-  **Compressing the blocks**
-  **Curing and drying**
- Final pre-production operations**
 -  **'Running in' production period**
 -  **Production tests**
 -  **Interpreting results and tolerances**
 -  **Training production staff**
- Quality controls**
 -  **(introduction...)**
 -  **Controlling raw materials**
 -  **Manufacturing controls**
 -  **Product control**
 -  **Organizational and equipment control**
 -  **How to carry out control operations**
- Production management and economics**
 -  **Management**
 -  **Calculating costs**
 -  **Marketing**
-

-  **Maximization of stabilizer quantity**
-  **Block-breaking apparatus for use in brickworks**
-  **Flat wheelbarrows**
-  **Screen and measuring box**
-  **Equipment for site tests**
-  **Small laboratory equipment**
-  **Examples of record sheet**
-  **Bibliography**



[Home](#) > [ar.cn.de.en.es.fr.id.it.ph.po.ru.sw](#)



-  **Compressed Earth Block - Volume I. Manual of production (GTZ, 1995, 104 p.)**
-  ***(introduction...)***
-  **Acknowledgements**
-  **Preface**
-  **Introduction**
-  **Soil**
-  **Stabilization**
-  **Equipment**
-  **Production layout**
-  **Production**
-  **Final pre-production operations**
-  **Quality controls**



**Production management and economics
Annexes**



Bibliography

Vincent Rigassi, CRATerre-EAG

Volume I. Manual of production

A Publication of the Deutsches Zentrum fr Entwicklungstechnologien - GATE in: Deutsche Gesellschaft fr Technische Zusammenarbeit (GTZ) GmbH in coordination with BASIN - 1985



[Home](#) > [ar.cn.de.en.es.fr.id.it.ph.po.ru.sw](#)

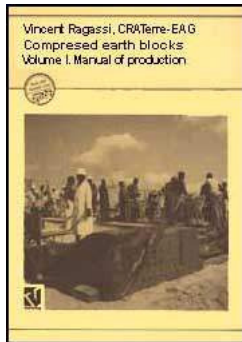

Compressed Earth Block - Volume I. Manual of production (GTZ, 1995, 104 p.)



Final pre-production operations



"Running in" production period



Production tests



Interpreting results and tolerances



Training production staff

Compressed Earth Block - Volume I. Manual of production (GTZ, 1995, 104 p.)

Final pre-production operations

"Running in" production period

GENERAL OBSERVATIONS

During the setting up stage of the project, various estimates of quantities, methods, etc. may have been made. Products' performance requirements and consumption of materials, and thus their production cost, will therefore have been able to be evaluated. At the actual start-up of production, all these estimates will have to be finalized and examples of the material will have to be produced by manufacturing various blocks and evaluating the results, both in terms of their performance and their cost. Adjustments are made with the help of various tests and analyses carried out specifically at this stage, which enable first the quality standard values (or tolerances) to be set and then regular manufacturing checks to be carried out, taking account of the context and the means of production of the unit.

PRODUCT QUALITY

Quality is an important notion which is defined in relation to the needs of the end-user. Criteria used to assess quality vary greatly and will depend on the context. It is most important to identify them if possible during the setting up stage of the project (market survey, etc.) but at all events before the start-up of production. They should subsequently be reconsidered, as they may change.

Blocks are not always put to identical use. Blocks which are not going to be exposed to water, for example, do not necessarily need to be stabilized; buildings of one or several storeys height will not have the same block strength requirements; rendered blocks will not inevitably have to have a smooth finish, etc.

Quality can be defined in sum as the capacity to produce blocks to the standard which has been set in the light of their future use, no better, and no worse.

Each use will have a corresponding class of block: the primary objective is to produce the best possible blocks at the best possible price, which means satisfying both the end-user (the blocks he needs, at a price he can afford) as well as the producer (meeting his clients' requirements at a production cost which leaves him a profit margin).

QUALITY CONTROL

The objective of control procedures is both to know the performance levels of the blocks and to manage production costs. To know how the blocks perform, objective control procedures and tests, enabling one to measure quality indicators, need to be defined. The value of these tests will depend not on how complex they are, but on how rigorously they are carried out, however simple they may be.

Once this procedure has been defined, acceptable tolerances for the various measures must be decided. The higher the quality requirement, the lower the tolerance. This notion of tolerance is important, as during production, tests are no longer needed to give quantifiable results, but only to confirm the acceptability of the product or not. This has the advantage of being simple and cheap, whereas when precise quantifiable results are required, expensive and sophisticated equipment, often not within the means of most brickworks, is usually needed.

CONTROL PROCEDURES

There are several levels of control:

The first, product control (the blocks), allows the final result of the production unit to be evaluated. This deals mainly with the blocks' performances and little with production costs.

The second, manufacturing control, evaluates the resources and methods used for each

operation. It enables one to find out if all the quantities and manual actions are correct and can detect the causes of any potential defects in the blocks before they are produced.

The third, organisational control, is essentially concerned with production costs. It enables labour outputs to be assessed and indications of the quality of the blocks to be given, if the resources available prove insufficient.

For each of these levels of control, procedures which suit the skills and resources of the brickworks have to be decided upon.

First product control is carried out until the blocks achieve the required standard. The manufacturing methods due to which this standard has been achieved are then checked to make sure that they are operational and can be reproduced, and target results for each operation are then set. Finally, the resources made available for each operation are checked to ensure that they guarantee optimum financial viability.

PRODUCT CONTROL

Once quality standards have been set, a way of measuring them must be found. The main parameters to examine are: dimensions, weight, appearance (smooth, rough, brittle etc.), water-resistance (immersion, capillary absorption, sprinkling, etc.).

MANUFACTURING CONTROL

The quality of the materials and the methods being used are checked to ensure that they enable the blocks required to be produced (analysis of constituent ingredients, quantities and proportions used, time taken, measurements of size, weighing out, temperature, humidity, visual observation, etc.)

ORGANISATIONAL CONTROL

Gaps between initial estimates and actual results are assessed. If the gap is too wide, corrective action will need to be taken, reviewing all the possible responses and justifying the choices made.

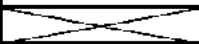
PERFORMANCE CLASSES	DRY COMPRESSIVE STRENGTH (MPa)	WET COMPRESSIVE STRENGTH (MPa)
A	2 to 3	
1	2 to 4	1 to 2
2	4 to 6	2 to 3

AN EXAMPLE OF THE CLASSIFICATION OF MECHANICAL PERFORMANCES

These figures are indicative only. For actual figures, it is important to distinguish between minimum and average strength values. Test procedures should be described or refer to a norm (e.g. Belgian norms NBN B/24/201 etc.)

Production tests

GENERAL OBSERVATIONS

The product must first be developed in the light of the materials and the equipment available. If the scale of the project and the means at its disposal permit, various laboratory analyses can be carried out (particle size analysis by sedimentation, Atterberg limits, Proctor test, chemical and mineralogical analyses, etc.) Clearly, it is rarely possible to carry out all of these analyses, either because they are very expensive, or because not all laboratories are sufficiently well-equipped. Very satisfactory results can, however, be obtained by using production tests the empirical nature of which can be limited by certain field tests and by ensuring that they are fairly rigourously carried out. Common laboratory analyses, such as particle size analysis by sedimentation and Atterberg limits, can also be useful. During production testing, blocks must be produced following all processing operations. At this stage, economic viability is not relevant, and the time taken will be the

time needed to carry out each operation best (see chapter on PRODUCTION); only the quantity and quality of the constituent ingredients will vary.

ANALYSIS OF THE CONSTITUENTS

Testing methods for soil analysis have been detailed in the chapter on SOIL. Field tests relating to water, sand or gravel will be detailed in the chapter on QUALITY CONTROL.

Acceptability will depend on results, but in the first instance the objective is to know the exact nature of the material in order to be able to observe any variation in quality between deliveries.

SOIL

If several soils which seem suitable are available, several blocks (10 to 20) will have to be produced and then examined in a wet and a dry state before making a final choice.

MODIFYING THE PARTICLE SIZE DISTRIBUTION

Soil with a high stone or gravel content: if the soil contains too many coarse particles, but the fine particles are evenly graded, passing it through a 10 mm or a 20 mm sieve will be enough to obtain a good soil.

Soil with a high clay content: if the soil has too many fines, it will need coarser grains to be added, sand and/or gravel, or even another soil containing mainly sand and gravel but very little clay. Clay can also be washed out, but the procedure is a fairly delicate one.

























Procedure: whether a particle fraction has been removed by screening or added by mixing, the procedure for determining the proportions is almost identical. First a rough estimate of the proportions is found, e.g. by using the jar test. Then several series of blocks are

manufactured using different proportions, and finally the proportions resulting in the best blocks are retained.

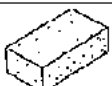
Testing: approximately 20 blocks are made for each differing proportion, making sure that the moisture content is at the optimum (using the drop test). The freshly moulded blocks are examined: if they are cracked when the moisture content is optimum, the proportions used are rejected. Blocks which are in good condition when freshly moulded are allowed 2 to 3 days of wet curing and one day's drying. At that point, the proportions resulting in the best blocks are retained.

EXAMPLE OF PARTICLE SIZE CORRECTION OF SOIL USING SAND

Assuming : total volume of mixed material = 120 l of soil:sand + 8 l of cement (10 kg), 5% stabilizer,
1 wheelbarrow = 30 l, 1 bucket = 12 l. => 120 l = 1 wheelbarrow + 6 buckets

WHEELBARROW OF SOIL	BUCKET OF SOIL	BUCKET OF SAND	CEMENT (10 kg)	DRY BLOCK	OBSERVATIONS
	+ 	+ 	+ 	= 	BAD BLOCK very smooth very large cracks not brittle very difficult to break
	+ 	+ 	+ 	= 	BAD BLOCK very smooth large cracks not brittle very difficult to break
	+ 	+ 	+ 	= 	BAD BLOCK very smooth small cracks not very brittle difficult to break
	+ 	+ 	+ 	= 	GOOD BLOCK smooth no cracks not very brittle difficult to break
	+ 	+ 	+ 	= 	BAD BLOCK fairly rough no cracks brittle easy to break

FIGURE**TESTING FOR THE AMOUNT OF STABILIZER AND FOR CURING TIMES**

Proceed as for particle size modification, gradually increasing the quantity used and the length of the curing time, and then examine the dry blocks in order to determine the results which are the closest to those required.

Economic considerations should not be neglected. The cost of cement can, for example, represent up to 50%, generally 20 to 40%, of the total cost of production. The amounts of cement used generally fluctuate between 4 and 10% (see sketch below). Approximately 20 blocks are produced for each different amount used, and for each sample of ± 20 blocks, i.e. for each amount used, 6 or 7 blocks are given, for example, 3 days wet curing + 11 days drying out; 6 or 7 more blocks: 5 days wet curing + 9 days drying out; and the final 6 or 7 blocks, 7 days wet curing + 7 days drying out (see sketch below).

The dry blocks are then examined (for appearance, weight, measurements, breaking point, immersion etc.), see chapter on QUALITY CONTROLS).

The lowest amounts and shortest curing/ drying times giving the results required at the lowest production cost will be retained.

CHECKING THE OPTIMUM MOISTURE CONTENT (OMC)

This means carrying out a static Proctor test, where compaction takes place in a press. The objective is to find out the amount of moisture giving the highest density, or in other words the heaviest blocks.

Once again, successive tests are carried out, with the drop test giving a rough approximation of the OMC. A first mix close to the OMC is then produced, assuming, for

example, that 7 litres of water will be needed for 60 litres of dry material (soil, cement, sand, etc.) Some ten blocks are produced using this amount of water and these are then all weighed to obtain an average weight.

A second mix is prepared, but this time, with for example, 1 litre more water, i.e. 8 litres for 60 litres of dry material. All the blocks are again weighed. If the average weight is higher than the preceding average, the operation is repeated, adding more water until the average weight falls. If the average weight of the second mix blocks is lower than that of the first, a third mix using less water than the first is prepared, e.g. 6 litres instead of 7, until the average weight falls.

MEASURING MOISTURE CONTENT

To determine the exact percentage moisture content for each mix prepared, take a small quantity of the wet mix, weigh it, dry it out (in a kiln, on a stove, in the sun, etc.) and weigh it when dry. The moisture content is calculated as follows:

$$= \frac{\text{wet weight} - \text{dry weight}}{\text{wet weight}} \times 100$$

Note

Knowing the quantity (in litres) and the OMC (%) is useful, but as these are calculated using dry soil, they can differ widely for moist soil (due to climate, rain etc.) Soil is in fact almost never completely dry in most "normal" ambient conditions.

Compressed Earth Block - Volume I. M...
OPTIMUM MOISTURE CONTENT TEST

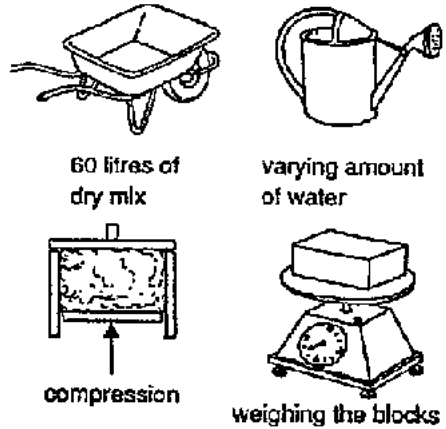

FIGURE

CEMENT PROPORTION TEST	
soil (sand,if appl.)	cement
 120 litres +	1/8 sack = 6.25 kg = 4 % 1/5 sack = 10.00 kg = 6 % 1/4 sack = 12.50 kg = 8 % 1/3 sack = 16.70 kg = 10 %

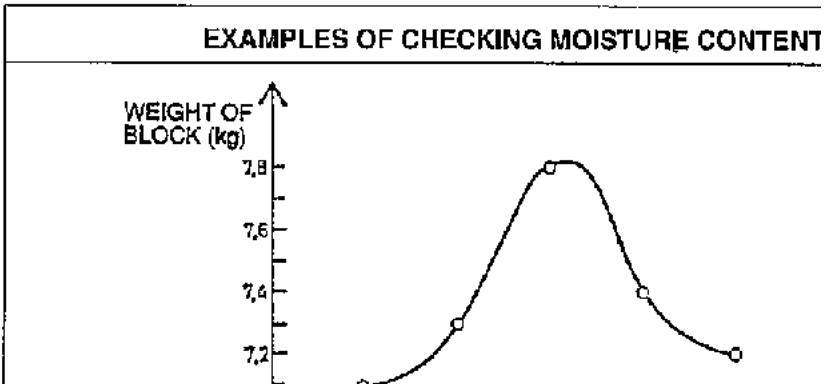

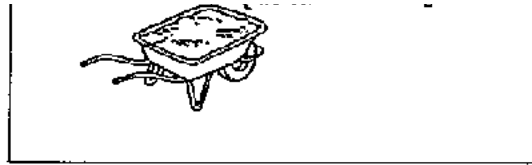

CURING TIME TEST

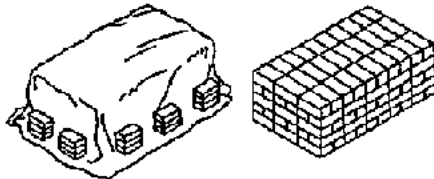

WET CURING

- 1) 3 days
- 2) 5 days
- 3) 7 days

DRY CURING

- + 11 days
- + 9 days
- + 7 days

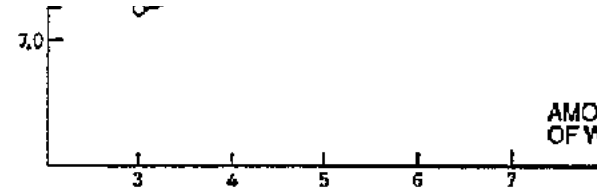

The optimum quantity of water is 5 litres

	AMOUNT OF WATER (in litres)	AVI OF
1st mix (60 l soil)	3	
2nd mix	4	
3rd mix	5	
4th mix	6	
5th mix	7	

FIGURE

Interpreting results and tolerances

TESTING

The various procedures are detailed in the chapters on **SOIL** and **QUALITY CONTROLS** as

well as on the previous pages. The importance of tests must not be overlooked; it is thanks to them that the best blocks can be produced at the lowest cost. It is also due to them that the credibility of building with earth will increase and thus encourage the emergence of new markets for this building material.

INTERPRETATION

The principle of all production tests is to use a structured step-by-step approach to arrive at the best results. This is certainly empirical, requires not very much equipment and undeniably gives good results.

In interpreting results, one must consider first the performances required but also current production, checking that the resources, methods and personnel being used during the running-in period are realistic and economically viable.

Economic aspects must not be overlooked when deciding on manufacturing procedures. Results can vary very widely depending on whether labour cash, or on the contrary materials and mechanization costs are high.

In choosing a soil, for example, it is important to know if transporting a very good soil requiring no modification and no preparation works out cheaper than using an average soil, extracted on site, but which requires preparing and modifying to achieve the same results. One must also bear in mind that modifying a soil by repeatedly adding measured quantities of material needs to be controlled by a skilled person and that any losses due to inaccurate measuring out also need to be evaluated.

Mechanizing preparation and mixing operations can often enable the rate of stabilization to be reduced, provided that it is well done.

As can be seen, a good analysis of the overall context is crucial before making final

decisions. It can sometimes be preferable to start out with a simple brickworks in line with the skills and financial resources available, rather than find oneself out of one's depth in the management of a complex brickworks.

TOLERANCE LEVELS

Raw materials

- Soil: tests should give results which are positive or close to recommendations so that any modifications which are necessary are not too difficult.**
- Sand or gravel: these are used to correct soils with a high clay content. They must therefore not contain too much clay. Generally, they cost more than soil and therefore should be used as little as possible. It can sometimes work out cheaper to use small quantities of clean (river) sand than large quantities of sand with a high clay content.**
- Cement: ordinary Portland Cement (CPA 250 or possibly 350) or the equivalent is highly suitable. Care must be taken that it is not past its usable date, nor damp.**
- Lime: excellent results are obtained with non-hydraulic slaked lime (or quicklime). The degree of impurity varies greatly, and therefore several tests for the amount to be used will need to be carried out.**

Checking measuring container volumes

Knowing the volumes of the measuring containers used (wheelbarrows, buckets, etc.) is crucial for controlling costs and quality. Volume precision should be in the order of + 5%, i.e. a margin of error of i 3 litres for a 60 litre capacity wheelbarrow, or + 0.5 litre for a 10 litre capacity bucket. An error of 1 kg of cement per 120 litre mix can represent an

additional cost of 2 to 5% of the total cost price.

Particle size distribution modifications

Sand (or gravel) is generally more expensive than soil, making it very important to calculate the correct proportion needed accurately. An error of 1/2 a bucket of sand, for example, for a proportion of 30% sand can represent an additional cost of 2 to 5% of the total cost price, i.e. approximately \$5 to 10 per thousand standard blocks.

Amount of stabilizer to be used

As cement costs often account for 20 to 50% of the cost price, a difference of 1% in the rate of stabilization can have an approximate effect of 4 to 8% on the cost price, i.e. \$10 to 20 per thousand blocks. One can check that the correct amount is being used by calculating the quantity of cement required for the manufacture of a given number of blocks. For example, for 6% cement, one 50 kg sack should be enough for 115 to 120 blocks (the calculation should be done using dry densities). Approximately + 4% tolerance is acceptable.

Curing and drying time

The duration of the wet curing and drying out periods is crucial to the ultimate quality of the blocks. A drop in quality due to poor wet curing for cement or lime stabilized blocks can lead to the need for a sometimes significantly higher rate of stabilization.

On the other hand, a prolonged wet curing stage demands large covered areas and storage areas. Accurately determining the curing time needed will ensure a balance between these two constraints (see chapter on STABILIZATION).

Optimum moisture content for moulding

A 1 to 2% error in the moisture content can lead to a drop of 10 to 50% in the dry density of the blocks.

The same operator should always be responsible for measuring out and adding water so that he can rapidly gain sufficient experience to determine the OMC.

Duration of mechanical mixing

Mixing for too long will slow down the rhythm of production, allow lumps to form and cause the machines to wear; mixing for too short a time will give an uneven mix. The optimum duration is generally 1 to 2 minutes for each mix (dry and wet) i.e. 3 to 4 minutes in total. Blocks can be produced after mixing times of 3 to 5 minutes and examined when dry (for appearance, strength, internal texture, etc.).

Compression

Once the amounts used have been checked, the way the press is being filled and the rate of compression are checked by counting how many blocks are obtained for each mix; the number should not vary by more than 5%. The moulds and the regularity with which they are filled can be checked by examining the dimensions and the parallelism of the blocks. Deviations should not exceed 2 to 3 mm. Variations in the direction of compression (height) may be due to irregular filling.

Appearance

Cracks are not acceptable on faces to be exposed to water. On other faces, they should not exceed 1 mm in width or depth or 10 mm in length and there should be no more than 3 on each face.

Lamination (due to too much clay or too high a moisture content) is not acceptable.

Chipped corners should not exceed 10 mm. Holes or scratches should not exceed 1% of the surface area for smooth blocks, but can be as high as 10-15% of the surface area for rough blocks.

Training production staff

GENERAL OBSERVATIONS

The production of compressed earth blocks does not require very high skills. But good initial training will enable good productivity to be achieved, whilst at the same time maintaining good product quality. CEBs are not a traditional building material. This is an important distinction: adobe blocks, for example, require too wet a mix for CEBs; fired bricks, too high a clay content.

Training should cover manual proficiency, quality standards, work coordination, safety regulations, and maintenance of equipment and of infrastructure. Essentially it will take the form of practical exercises and demonstrations.

QUALITY STANDARDS (see chapter on QUALITY CONTROLS)

Quality control procedures are crucial for obtaining quality products. If they are to be efficient, these procedures must have the commitment of the staff who must understand their importance. This means encouraging them to take pride in their work, so that each of them can feel involved in the final product. Control procedures which suit the context and the size of the production unit should be set up.

Exaggerating the effect of each standard and then offering an explanation is generally an effective way of proceeding.

Soil quality

Blocks are made using extremes of soil type (too much clay, too much sand, etc.) and the results examined.

Moisture content for compression

Blocks are produced too dry, too wet and finally with the correct moisture content.

Mixing

Blocks are made using untreated barely mixed soil, and then with a well mixed and prepared soil.

Amounts of stabilizers used

Blocks produced using different amounts of stabilizers are broken.

Retention time

The delay between mixing and compression is made to vary.

Compression

Blocks are first made from a badly filled mould and then from a correctly filled one.

Curing

Blocks correctly cured are compared with others which have been exposed to direct sun and wind immediately after removal from the mould.

For all these exercises, once the blocks have been produced, tests enabling the operation to be controlled are introduced. One should also try to illustrate the effect which badly

carried out operations have on cost price by using telling images such as the number of blocks produced for each sack of cement, placing an empty sack in front of the corresponding pile of blocks, etc.

MANUAL PROFICIENCY (see chapter on PRODUCTION)

Manual proficiency will come with practice but explaining a few "tips" can speed up the learning process. Dangerous or tiring work positions must also be avoided.

It is also important that all the members of the team should have been trained for each task. This enables them to stand in for each other but above all to appreciate the difficulties of each task and not to blame each other unjustly.

At the same time some flexibility should be allowed initially so that each worker can gradually find the job which suits him best.

WORK COORDINATION

Each worker must realize that the production of a block is a series of interdependent operations and that everyone has therefore some shared responsibility for the final result. Here too examples of poor coordination can help understanding, but initial recruiting, remuneration principles, whether the management style is participatory or not, also play a part. The organigramme of production and responsibility must be carefully drawn up and reassessed.

SAFETY

There is always a danger of accidents occurring even with minimal equipment (crushed hands, the compression lever springing back, screened soil being projected, etc.). For each task, a list of potential accidents should be drawn up and simulated, and safety rules

decided on in the light of these.

MAINTENANCE OF EQUIPMENT AND OF INFRASTRUCTURE

The degree of maintenance will directly influence the products and therefore indirectly the financial return. Each person is therefore involved and should be capable of carrying out routine maintenance with the necessary means. Adjustments or more delicate repairs on the other hand should be carried out only by designated skilled staff.







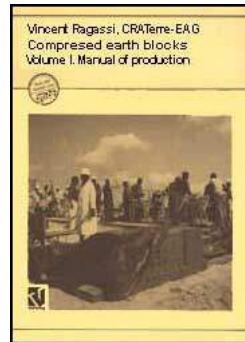

For the first few weeks, great attention must be paid to the staff and there should be no hesitation in devoting the time needed for each member of staff to understand exactly what he has to do.



[Home](#) > [ar](#) [cn](#) [de](#) [en](#) [es](#) [fr](#) [id](#) [it](#) [ph](#) [po](#) [ru](#) [sw](#)



Compressed Earth Block - Volume I. Manual of production (GTZ, 1995, 104 p.)

-   **Quality controls**
 -  ***(introduction...)***
 -  **Controlling raw materials**
 -  **Manufacturing controls**
 -  **Product control**
 -  **Organizational and equipment control**
 -  **How to carry out control operations**

Compressed Earth Block - Volume I. Manual of production (GTZ, 1995, 104 p.)

Quality controls

Controlling raw materials

GENERAL OBSERVATIONS

The objective of production controls is to check that production conforms to set objectives. This does not necessarily mean obtaining a precise measurement, but rather checking that the end result is correct due to comparisons with levels set during the running-in production phase (for tolerances, see chapter on FINAL PRE-PRODUCTION OPERATIONS).

RAW MATERIALS

Soil

As soils will have been identified and selected beforehand, it is only necessary to check that a delivery of soil is more or less identical to the soil originally selected. The cigar test can be used, checking that the length of the cigar obtained with the tested soil does not differ from the measurements obtained with the original soil.

The jar test can also be carried out, checking that the proportions of different soil fractions are similar, by using identical containers and placing the original soil alongside the tested sample.

Water

The presence of salts in the water is to be avoided, particularly if the blocks are stabilized with cement or lime. Check that the water is clear and that it is not salty. Let it evaporate

completely and check for any deposits. These could include organic matter, which are acceptable only in very small quantities, or salt crystals which are totally unacceptable (see sketch).



Sand or gravel

These are used as additives to lower the proportion of fines, and must therefore be checked to ensure that they do not contain too much clay, using the jar test. If the water above the sand and gravel is cloudy, this suggests the presence of clay, which should not exceed 10 to 15%. The evenness of the particle size distribution can be checked at the same time by comparing the sample tested with a standard sample.

Cement

Cement must be checked to ensure that it has not started to react on contact with moisture. A little cement is sieved using a 1 or 2 mm mesh; if tiny balls of cement which cannot be crushed between the thumb and forefinger are left behind, then the cement is bad. If the delivery cannot be refused, it may still be possible to use the cement by passing it through a 0.5 mm sieve and then mixing it with 50% good quality cement.

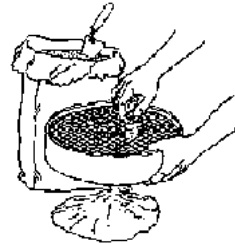

CEMENT TEST

FIGURE

The strength of the cement can also be checked. Make a mortar using a 1:3 mix of cement sand and mould it into short bars. Wrap up the bars and the moulds in a plastic bag.

24 hours later, remove the bars from the moulds and allow them to cure, either submerged in water, or in a hermetically sealed package. Subject a bar to a tensile force after 24 hours, and another after 28 days: they should withstand minimum 100 g and 500 g respectively (see below).

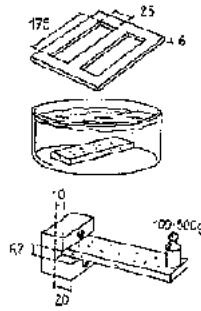
**FIGURE**

Hydrated lime

Lime should not be too impure. It can be tested in exactly the same way as cement by comparing the sample bars with control bars made from lime of known impurity. For large-scale projects, it is advisable to obtain the professional opinion of a technician

Manufacturing controls

PROCESSING OPERATIONS

Soil preparation

Proceed as described before for controlling raw materials, i.e. using the cigar or the jar test and comparing results with those of control samples.

Measuring out

This is controlled by weighing or counting, allowing a tolerance of $\pm 5\%$:

- the number of blocks obtained per mix;**
- the number of mixes made per sack of cement used;**
- the number of blocks obtained per sack of cement used.**

The accuracy of the counting can be checked by cross-referencing the various results (see below).

Mixing

- Manual mixing: count the number of times the pile is turned. This should be at least twice for each mix (dry and wet).**

- **Mechanical mixing: check the time taken for dry mixing and wet mixing 3 to 5 times: the tolerance is 5 to 10%.**
- **Dry mix: Visual examination of the evenness of the mix (texture, colour).**
- **Wet mix: Check that the moisture content is at the optimum using the drop test:**
 1. **take a fistful of moist material and shape it into a ball in the hand;**
 2. **drop the ball from a height of -1 m onto a hard surface;**
 3. **observe the result: if the ball has completely disintegrated, the mix is too dry; if it has broken up into 4 or 5 pieces, the moisture content is right; if it has flattened out without breaking, or broken into 2 pieces, the mix is too wet.**

Retention time (see above)

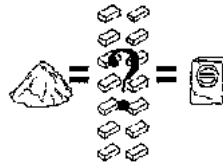

FIGURE

Time the delay between mixing and compression. For cement stabilization, this should not exceed 5 to 10 minutes. For lime, the delay should be no less than 2 hours and preferably 8 to 16 hours.

Compression

Check the freshly moulded block for:

- weight, which should not differ from the optimum weight by more than 5 to 10%;
- appearance (tolerance criteria are detailed on p. 74);
- dimensions, and also any deviation from right angles: these should not vary by more than 1 to 3 mm. Measurements should be taken using a ruler and a mason's set-square (see below).

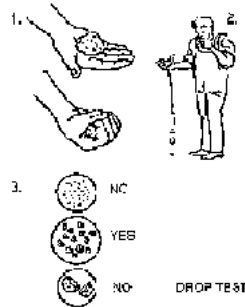

FIGURE

An orthogonal gauge can also be made from wood or metal and used to measure dimensions and parallelism at the same time, with small nicks at the ends showing acceptable tolerances (see below).

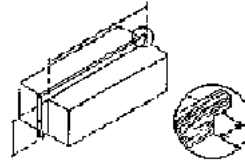
**FIGURE**

The strength of the block can be checked with a pocket penetrometer. Carry out at least 5 tests on each side; tolerances will be set according to the performance levels to be attained (see below).

Curing

Examine the quality of wet curing, notably check for condensation (drops of water) (see below) on the inside the tarpaulin or polythene sheets.

The moisture content of blocks while they are curing can also be measured, and compared to their moisture content when freshly moulded. The moisture content of the block during curing should not vary by more than 1 or 2% from the moisture content on compaction.

Product control

GENERAL OBSERVATIONS

The minimum number of blocks tested is approximately 5, but this will depend on productivity. Time taken to carry out control procedures should not interrupt the normal working of the brickworks. Tests must therefore be listed in order of importance and made to suit the availability of the person responsible for carrying them out, so that the most important ones (weight, dimensions, breaking point) can be regularly carried out. Blocks should be checked during curing and without fail after regular curing periods for results to

be comparable.

WEIGHT, APPEARANCE, DIMENSIONS AND PARALLELISM

Tests and tolerances are identical to those previously described. At this stage the object is to check for any changes in the blocks compared with their state when freshly moulded: a variation in moisture content can be observed in the block's lower weight, and shrinkage in smaller dimensions or in the appearance of cracks. During wet curing, the moisture content should not fall by more than 1 or 2%, i.e. a lowering in weight of approximately 150 to 200 grams maximum for a standard block. Shrinkage should not be more than 1%. For the acceptability of cracks, see chapter on FINAL PRE-PRODUCTION OPERATIONS.

RUPTURE TEST

This test enables one to find the bending strength of the block and by extrapolation its compressive strength. This is an important criterion as it is the one which is most commonly used for most materials. The test is carried out using a site block-breaking apparatus (see below and annexes). This gives a satisfactory estimate of bending strength.

The block is placed on its lower face, compression side downwards, perpendicularly across two tubes laid 20 cm apart. A third tube is placed across the middle of the upper face, parallel to the first two, and a plate attached to it is loaded with blocks or sacks of cement at a rate of approximately 250 kg/minute. Bending strength (of) is calculated from the load required to break the block as follows:

$$\rho_f = \frac{1.5 \times L \times D}{w \times h^2}$$

D = the distance between the two tubes in cm (here 20 cm)

L = the load in kg (including the loading plate)

w = the width of the block in cm

h = the height of the block in cm

k is the coefficient used for hollow blocks, for full blocks k = 1.

This formula is used only for measuring the strength of the block, but a minimum acceptable load can also be set. For example, the tested block should withstand a load of 15 blocks to be acceptable.

The compressive strength (ρ_C) can be deduced by multiplying (ρ_f) by a factor K which will depend on the nature of the soil; this is often between 5 and 8 but must be determined more precisely by laboratory tests for bending and compressive strengths.

$$\rho_C = K \times \rho_f$$

This test gives a good general idea of the performance of the block.

INTERNAL TEXTURE

Examine the internal texture of the broken blocks. Different soil fractions should be evenly distributed. If they are not, generally as a result of poor mixing, there will be concentrations of gravel or of coarse sand, or stained or lumpy areas. In all cases, such blocks should be rejected.

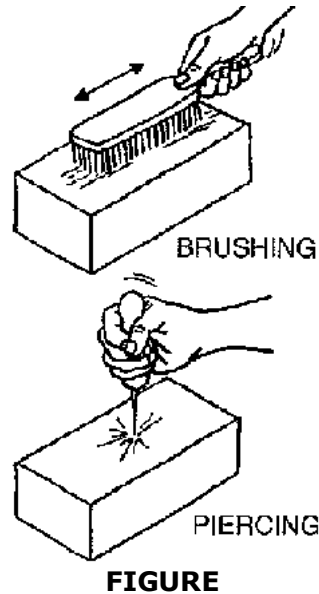
**FIGURE**

BRUSHING AND PIERCING

Each broken block is divided up into two samples, one kept as a control and the other used for testing. A styles is jabbed into the block faces. For brushing, a metal brush is applied to two or three sides, using equal force and an equal number of backwards and forwards movements.

These tests give an idea of the surface strength of the blocks. Acceptability limits will be set according to the intended use of the blocks and whether they will be exposed to abrasion and knocks.

IMMERSION

Use the half blocks which have been subjected to brushing and piercing in order to obtain a worst case result.

The half-blocks are completely immersed in water for 6 hours, then allowed to dry for 42 hours, giving a 48 hour total dry-wet cycle. The cycles can be repeated several times. Immersion can be replaced by fine sprinkling using a spray head (see photo below).

LABELLING THE BLOCKS

When the blocks have passed all the tests, they must be labelled. The date of manufacture should be specified, as well as any classification of the block. Writing should be easy to read, even during wet curing where the labels will also appear on the outside of the tarpaulins.

Organizational and equipment control

ORGANIZATIONAL CONTROL

This is to check if the best organizational methods are being used, checking if staff are correctly allocated around the production site and their skills being correctly used, and that they have the tools they require.

For each task, targets should be set based on the equipment available, on the results obtained during the running-in period of production, etc. These target figures - for outputs, numbers employed, quantities of materials consumed - are then compared with actual results. If shortfalls between targets and results are too great, the reasons for these must be analyzed, once the original target estimates have been double-checked.

For each operation, one should ask oneself:

- if it is really necessary (why?);
- if those carrying it out have the right skills (who by?);
- if the resources and methods used are adequate (how?);
- if the layout is right (where?);
- if the operation is permanent or temporary (when?) (see top right).

Before answering each question, run through all the possible responses and the reasons for them. The same approach can be used to check the cost price by quantifying each element (wages, investments, running costs, etc.)

EQUIPMENT CONTROL

It is crucial to know the state of machines in order to be able to maintain them (cleaning, oiling, replacing parts, setting etc.) at-convenient moments and also to be able to spot the causes of possible breakdowns and alert the manufacturer. Technical incidents can be due to defects in the machine, but are most often due to poor work practices, bad settings or insufficient maintenance.

All maintenance tasks should be listed (number of oiling points, levels or settings, etc.) and their frequency set (replacing disposable parts every so many blocks, complete cleaning every so many days, etc.) (see table on the right).

Frequencies specified by the manufacturer should be checked as they can vary depending on the context.

All repairs should be described and filed in order to be able to analyze them and to take avoiding action in the future.

OPERATIONAL ANALYSIS

	WHY ?	WHO BY ?	HOW ?	WHERE ?	WHEN ?
Description of current configuration					
Alternatives					
Direct consequences					
Repercussions on other operations					
Measurement					

FIGURE

OPERATION	METHOD	RESOURCES		UNIT	OBJECTIVE	RESULT	SHORTFALL		REMARKS
	Description	Human	Material				QTY	%	
Extraction				m ³					
Preparation				m ³					
Mixing				m ³					
Compression				blocks					
Curing				m ²					
Transport				blocks					

FIGURE

EQUIPMENT MAINTENANCE RECORD

Sheet n°

Enterprise	Machine type	First used	
NORMAL MAINTENANCE			Remarks
total production	complete oiling date	Dismantling/cleaning date	remarks

FIGURE

REPAIRS			Responsible
DATE	AGE OF MACHINE N° BLOCKS PRODUCED	NATURE OF BREAKDOWN	DESCRIPTION OF REPAIR (ADJUSTMENTS, MECHANISM, WEAR AND TEAR)
Remarks			

FIGURE

How to carry out control operations

"RESPONSIBILITY TREE" (see below)

It is crucial to know set levels of responsibility for each person involved in control procedures.

- **The head of the brickworks analyses results and makes decisions on fundamental changes.**
- **The team leader or supervisor carries out tests, collects data and takes decisions on minor adjustments.**
- **The labour force quantify operations (counting etc.) and strive to carry them out in the way which has been decided upon.**

FREQUENCY

Each control procedure or check should be carried out at a given rate of frequency depending on the level of the analysis and the way the brickworks operates (see table on the right).

CONTROL TOOLS

Wherever possible, operations should be quantified (numbers of blocks and amounts of raw materials, number of mixes, transport operations, etc.).

Counting should be done by the operators (the labour force), and recorded and checked by the team leader or supervisor. Blackboards are the best way of counting during production. Figures are then copied down onto control cards which are then analysed and classified on data sheets. Each of these support documents corresponds to given levels of responsibility and frequency.

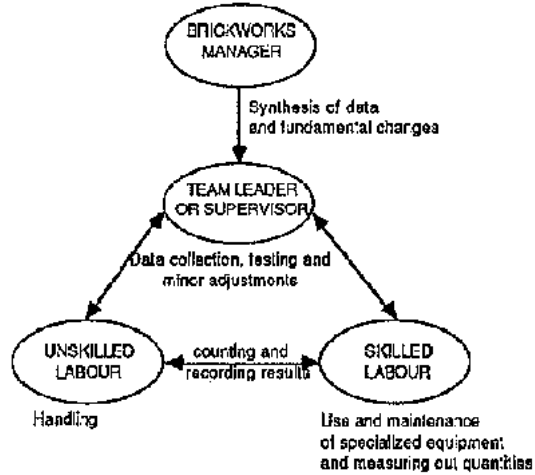

FIGURE

AIC		USE	FREQUENCY			WHO DOES IT ?			WHO READS THEM ?						
			daily	weekly	monthly	workers	team leader or supervisor	blockwork manager	workers	team leader or supervisor	blockwork manager	internal control staff	external control staff	client	
		BLACK BOARDS	•			•			•	•					
RECORD SHEETS		CHECKING	Daily check	•			•			•		•	•		
			Production		•		•			•	•	•	•	•	appr.
			Blocks		•		•			•	•	•	•	•	appr.
			Organization		•		•			•	•	•	•	•	appr.
			Equipment	•	•		•			•	•	•	•		
		RECORDING	Amounts consumed			•		•			•	•			
			Production			•		•			•	•			
			Quality label			•		•			•	•		•	
			Outputs			•		•	•						
			Outgoings/receipts			•		•			•				

FIGURE

[Home](#) > [ar](#).[cn](#).[de](#).[en](#).[es](#).[fr](#).[id](#).[it](#).[ph](#).[po](#).[ru](#).[sw](#)

 **Compressed Earth Block - Volume I. Manual of production (GTZ, 1995, 104 p.)**

  **Production management and economics**

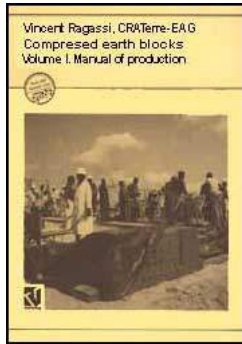

Management
Calculating costs
Marketing

Compressed Earth Block - Volume I. Manual of production (GTZ, 1995, 104 p.)

Production management and economics

Management

GENERAL OBSERVATIONS

Management is indispensable to improve and achieve the smooth working of the production unit. It enables one to take decisions in the light of the analysis of data collected in the course of various control and recording operations. It concerns above all stocks and cash flow, but also user satisfaction and therefore marketing.

STOCK MANAGEMENT

Raw materials

Stocks represent tied up capital. The extent to which capital is tied up will depend on the nature and length of the manufacturing cycle, notably the duration of the curing stage,

which should be as short as possible, without being detrimental to the quality of the blocks.

For example, choosing lime as a stabilizer can prove less viable than cement, even if it costs less, since it demands a minimum curing time of 56 days instead of 28 days for cement. The time lapse between each delivery of raw materials should be examined. If it is too long, large quantities will have to be purchased in advance, causing capital to be tied up for a long time. If on the other hand it is too short, even a slight delay could result in out-of-stocks, bringing the brickworks to a standstill; reserve stocks are needed to avoid this occurring. In addition, purchasing in large quantities often allows discounts on unit prices.

One must find and set a balance between these different constraints by carefully observing supplies, consumption and stock levels, which should be inventoried at least once a month to check on any shortfalls (inaccurate records, wrong amounts of material used, losses, theft etc.).

Equipment and tools

The state of equipment and tools should be known to avoid the risk of production being forced to close. Merely a broken shovel handle can be enough to halt the brickworks. A sufficiently large, but not excessive, stock of tools and spare parts should be allowed for. A monthly inventory is also crucial.

Blocks ready for use

To avoid capital being tied up in stocks for too long, blocks should be moved on (building site or direct sales) as soon as possible after curing. This must be studied before starting production. If blocks are intended for direct sales, it is useful to have stocks of blocks ready for use and available for immediate sale, but one must be aware that this represents

a capital cost. This approach can be considered if there is sufficient capital and if client demand requires it, as it can be an additional selling point. A production unit working purely on firm orders is the ideal solution from the point of view of stock control, but this is possible only with small production units, where amortisations and the cost of not producing are low. Otherwise a major marketing effort is crucial to maintain a certain sales or site stability.

CASH FLOW MANAGEMENT

Money needed for production (purchase of raw materials, equipment, power, wages, etc.) will only be reimbursed when blocks are paid for, whether they are sold as such or put into use in buildings. This money that has to be <advanced> is known as a cash flow provision, a stock of available money which may therefore incur charges (e.g. loans). To reduce charges, the most accurate estimate possible of the amount needed for a given period (week or maybe month) must be made and the degree of flexibility must be evaluated: fixed dates for payments and receipts or not.

In most cases, this means negotiating with various contacts (suppliers, banks, clients, the state...). The outcome will often depend on the economic and technical viability of the production unit and the quality of the relationships it has with outside partners.

USER SATISFACTION

Three factors are critical: availability, quality and price.

- Availability will depend on the delay between ordering and taking delivery of the blocks. Too long a delay may put off the users and make them turn to other materials. But, as we have seen, a very short delay implies the financial capacity to hold large stocks of blocks. The best solution is to foster loyal clients, but diversification of activities can also provide a solution. For example, a producer

who is also a builder, can broaden his market and one activity may be able to make up for slack periods in the other.

- Quality, as we have seen, is determined by the users' needs which must be known and constantly re-evaluated for an optimum solution.

Users must also be reassured and have the reliability and performance of the products demonstrated to them. For example, thanks to the stamp of an approved quality control organisation, but also with the help of the reputation of the brickworks.

- Price is also a determining factor. It should be fixed in the light of the local market and suited to the price the buyer is prepared to pay. Either the profit margin can be reduced, which may be good marketing policy - by selling cheaper, one sells more. Or one can try to reduce production costs, which presupposes that the working of the brickworks is being constantly analyzed, by examining the cost of raw materials, of labour, amortisations, and charges. This sometimes means redesigning manufacturing methods, the nature of the organisation, equipment, cash flow etc.

Improving productivity is often the best way to reduce production costs and can often be achieved through better working conditions (shelter from direct sun and dust, safety, adequate wages or profit sharing, etc.).

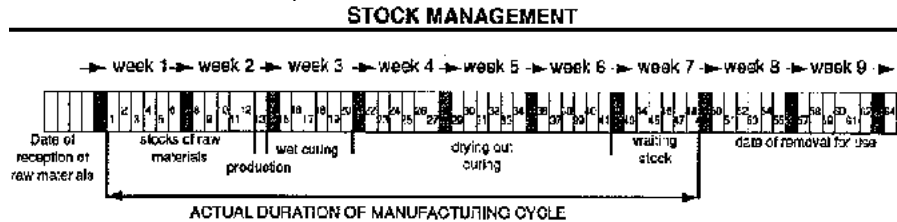
**FIGURE**

Calculating costs

PRODUCTION COSTS

Calculating production costs is vital; it should be done at the setting-up stage of the project and periodically checked. Costs include the production unit's fixed and variable costs.

Fixed costs are independent of productivity, but are linked to the unit production configuration. They include:

- **Financial charges (interests on loans):** these are linked to initial investments (preparatory market and feasibility surveys, land or production site purchase, equipment purchase, cash flow provision for initial expenses: stocks, wages, equipment.)
- **Amortisation:** This should enable initial investments to be recouped. It is calculated on the expected life or the loan reimbursement term of the production unit which may be 3, 5 to 10 years.
- **Management costs:** these include salaries, social security contributions and

supplies which are independent of production.

- **Administrative costs, which include state and local taxes.**
- **Infrastructure costs, including rents, insurance, repairs.**

Variable costs are linked to productivity but independent of the nature of the production line and include:

- **the production labour-force (wages, social security contributions, etc.);**
- **raw materials (soil, sand, cement, water, etc.) and power;**
- **equipment and services linked to production (tools, works and transportation);**
- **possibly taxes on the products (VAT, etc.).**

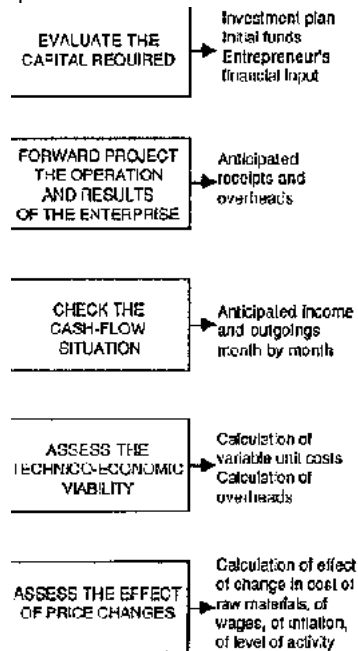
**FIGURE****UNIT COST**

For a given production figure, fixed and variable costs are added together and the total divided by the number of blocks produced, giving the unit cost. This enables the price of the blocks to be set at a sensible level, by adding a profit margin to the unit cost.

SENSITIVITY ANALYSIS

It is useful to calculate the effect of changes in costs (fixed or variable) or in productivity on the unit cost. This prevents one being caught unaware if costs increase or if productivity falls. It can also give one a good idea on the best manufacturing method, organisation and amount of materials to use with regards to variations in unit cost.

SENSITIVITY STUDY AND UNIT COST

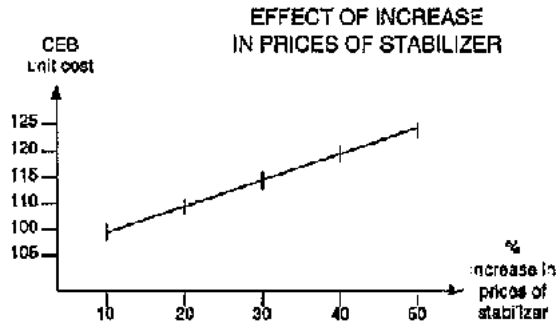

FIGURE

The above curve illustrates the reduction in unit production costs with increased productivity. The costs of raw materials and stabilizer remain identical: 1 currency unit per block gives 1000 currency units per 1000 blocks, as proportions stay the same. Labour and overheads per block, however, fall as productivity increases. Overheads (interest payments, rent, taxes) and salaries (if these are independent of productivity) will stay the same whether any blocks are being produced or not. For example, if overheads and salaries are 1000 currency units per day, the cost per block will be 1000 currency units if only one block is produced, but 1 currency unit if 1000 blocks are produced. Experience shows, however, that from a certain point onwards, the cost of production per block

hardly falls at all and it is this optimum level of production which should ideally be achieved.

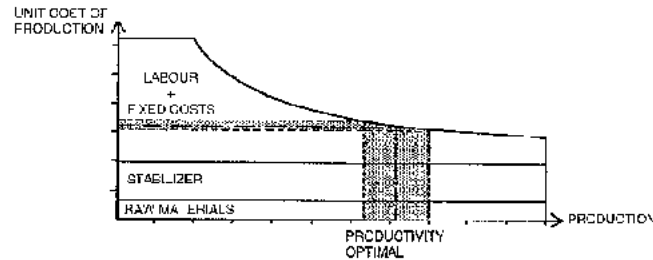

FIGURE

Marketing

GENERAL OBSERVATIONS

The marketing and dissemination of CEBs will grow on account of user satisfaction.

This means actively seeking to inform and watching for changes in the market, but also helping with the design and the construction of CEB buildings, as well as supporting efforts to make the material better known to the public.

INFORMATION

CEBs are often poorly understood. Potential users must therefore be informed not only about sales related aspects (costs, delivery times,) but also about their building potential (performances, thermal comfort, low cost, appearance). Ordinary supporting materials (leaflets, technical data sheets, video-cassettes, various media etc.) can be used. But to begin with the best approach is generally through demonstration by puffing up buildings

illustrating the particular use of CEBs and their building merits. These first physical examples are often crucial, as the public will tend to associate CEBs with buildings it has seen. They must therefore illustrate as clearly as possible the potential and limitations of the material, and at the same time give an indication that they can aspire to the people's needs.

ADVICE AND ASSISTANCE

Generally, it is not enough to produce good blocks, one must also ensure that they are correctly used according to specific working practices. If the producer is also the builder, this is less of a problem to the extent that he has the right skills. When blocks are sold directly, the producer may be in a position to advise or assist his clients on construction. Otherwise, the latter may reject the material and give it a bad name, which will reflect poorly on the producer. He should be able to help with design and execution, either through links with architects, engineers and entrepreneurs whom he can recommend to his clients, or by having technical documents (manuals, master plans,) available, perhaps linked to training courses locally or regionally.

RECOGNITION OF CEBs

The building sector is not all easily convinced by the appearance of a new material. It needs to be reassured by demonstration of the material's reliability and the professional competence of producers using it. Putting up demonstration buildings is an eloquent statement, but will often have to be complemented by putting quality control procedures into place through official organisations, which may lead to relevant enterprises being qualified and the preparation of necessary standards documents.

For a producer or builder, recognition of CEBs can have many advantages: opening up public markets, favourable credit rates, grants, partnerships, etc. For official services, the advantages are also certain: reduced imports, job creation, training specialized labour,

cheap building solutions, cultural continuity, etc.





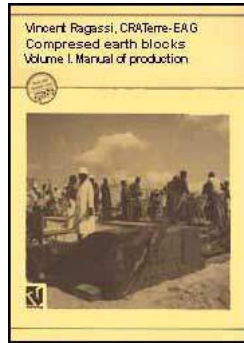



[Home](#) > [ar](#).[cn](#).[de](#).[en](#).[es](#).[fr](#).[id](#).[it](#).[ph](#).[po](#).[ru](#).[sw](#)



 **Compressed Earth Block - Volume I. Manual of production (GTZ, 1995, 104 p.)**

➔  **Annexes**

-  **Calculation of stabilizer quantity**
-  **Block-breaking apparatus for use in brickworks**
-  **Flat wheelbarrows**
-  **Screen and measuring box**
-  **Equipment for site tests**
-  **Small laboratory equipment**
-  **Examples of record sheet**

Compressed Earth Block - Volume I. Manual of production (GTZ, 1995, 104 p.)

Annexes

Calculation of stabilizer quantity

EXAMPLES OF CALCULATIONS (see page 35 for details of methods, formulae and notes.)

EARTH-CEMENT MIX

Given: ρ_C : 1250 (kg/m³); ρ_E 1300 (kg/m³)

C required: 6 %; containers: 60 l capacity wheelbarrows and 12 l capacity buckets.

Method 1

The weight of the cement is obtained, the volume of earth and the rate of stabilization having been decided: Vol.E = 2 wheelbarrow loads = 0.12 m³.

$$W_c = \frac{1300 \times 0.12 \times 6}{100} = 9.36 \text{ kg} \quad (\text{formula 3})$$

The weight of the cement is rounded up to 10 kg (1/5 of a sack) to make it easier to measure out.

$$C = \frac{10 \times 100}{1300 \times 0.12} = 6.4\% \quad (\text{formula 5})$$

Method 2

The volume of earth is obtained, the weight of the cement - 10 kg (1/5 of a sack) - having been decided.

$$\text{Vol}_E = \frac{10 \times 100}{1300 \times 6} = 0.128 \text{ m}^3 \quad (\text{formula 4})$$

The volume is rounded down to 2 wheelbarrow loads of earth = 0.12 m³, which gives the same results as method 1 above using formula 5. The actual proportion used is therefore 6.4 %.

EARTH + SAND (OR GRAVEL) + CEMENT MIX

Given: ρ_C : 1250 (kg/m³); ρ_E : 1350 (kg/m³)

ρ_S : 1450 (kg/m³); $\rho_E = 80 \%$, $S = 20 \%$

C required: 5 %; containers = 60 l capacity wheelbarrows and 12 l capacity buckets. 1 wheelbarrow load = 5 bucket loads.

Method 1

The weight of the cement is obtained, the volumes of earth and sand and the rate of stabilization having been decided.

Vol._E = 1 wheelbarrow load + 3 bucket loads = 96 l capacity = 0.096 m³

Vol._S = 2 bucket loads = 24 l capacity = 0.024 m³

the total is Vol._E + Vol._S = 2 wheelbarrow loads = 0.12 m³.

$$W_c = \frac{[(1350 \times 0.096) + (1450 \times 0.024)] \times 5}{100} = 8.22 \text{ kg (formula 6)}$$

The weight of the cement is rounded up to 8.33 kg (1/6 of a sack).

$$C = \frac{8.33 \times 100}{(1350 \times 0.096) + (1450 \times 0.024)} = 5.07\% \text{ (formula 9)}$$

The percentages of earth and sand are rechecked.

$$E = \frac{1350 \times 0.096}{(1350 \times 0.096) + (1450 \times 0.024)} = 78.8\% \text{ (formula 10)}$$

$$S = \frac{1450 \times 0.024}{(1350 \times 0.096) + (1450 \times 0.024)} = 21.2\% \text{ (formula 11)}$$

Method 2

The volumes of earth and sand are obtained, the weight and the percentages of the

cement, the earth, and the sand (or gravel) having been decided.

W_C = 10 kg (1/5 of a sack), C = 5 %, E ≈ 80 %, S = 20 %

$$\text{Vol. } E = \frac{10 \times 80}{1350 \times 5} = 0.1185 \text{ m}^3 \text{ (formula 7)}$$

$$\text{Vol. } S = \frac{10 \times 20}{1450 \times 5} = 0.0276 \text{ m}^3 \text{ (formula 8)}$$

Vol. E = 0.12 m³ (2 wheelbarrow loads); Vol. S = 0.024 m³ 2 buckets loads

$$C = \frac{10 \times 100}{(1350 \times 0.12) + (1450 \times 0.024)} = 5.08\% \text{ (formula 9)}$$

The percentages of earth and sand are rechecked.

$$E = \frac{1350 \times 0.12}{(1350 \times 0.12) + (1450 \times 0.024)} = 82.3\% \text{ (formula 10)}$$

$$S = \frac{1450 \times 0.024}{(1350 \times 0.12) + (1450 \times 0.024)} = 17.7\% \text{ (formula 11)}$$

CALCULATION OF QUANTITIES USING WET MATERIALS

Cement must be kept dry or it will not work. The other materials (earth, sand, etc.) on the other hand are rarely dry, whether in the quarry or when stocked at the brickworks. For this reason we give below formulae which can be used to calculate quantities using wet materials. Their moisture content must, however, be known (fpr how to measure moisture content) and it must be remembered that dry and wet materials will vary greatly in looseness, which means that the volume of a dry material can be very different from its volume when wet and this must be observed.

The methods of calculation are the same as those explained on p. 35 and the formulae have been give the same numbers, followed by bis.

KEY

ρ_{WE} : density of wet earth (kg/m^3)

ρ_{WS} : density of wet sand (kg/m^3)

Vol. W_E : volume of wet earth (m^3)

Vol. W_S : volume of wet sand (m^3)

W_E : moisture content of wet earth (%)

W_S : moisture content of wet sand (%)

FORMULAE

$$\text{Formula 3 bis } W_C = \frac{\rho_{WE} \times \text{Vol.}_E \times C}{100 \times W_E}$$

$$\text{Formula 4 bis } \text{Vol.}_E = \frac{W_C \times (100 + W_E)}{\rho_{WE} \times C}$$

$$\text{Formula 5 bis } C = \frac{W_C \times (100 \times W_E)}{\text{Vol.}_E \times \rho_{WE}}$$

$$\text{Formula 6 bis } W_C = \frac{[(\rho_{WE} \times \text{Vol.}_{WE}) - (\rho_{WS} \times \text{Vol.}_{WS})] \times C \times 100}{(100)^2 \times (W_E \times E) + (W_S \times S)}$$

$$\text{Formula 9 bis } C = \frac{W_C \times [(100)^2 + (W_E \times E) + (W_S \times S)]}{[(\rho_{WE} \times \text{Vol.}_{WE}) - (\rho_{WS} \times \text{Vol.}_{WS})] \times 100}$$

Block-breaking apparatus for use in brickworks

BLOCK-BREAKING APPARATUS FOR USE IN BRICKWORKS

For how to use this apparatus and calculate strengths, see **PRODUCT CONTROL**

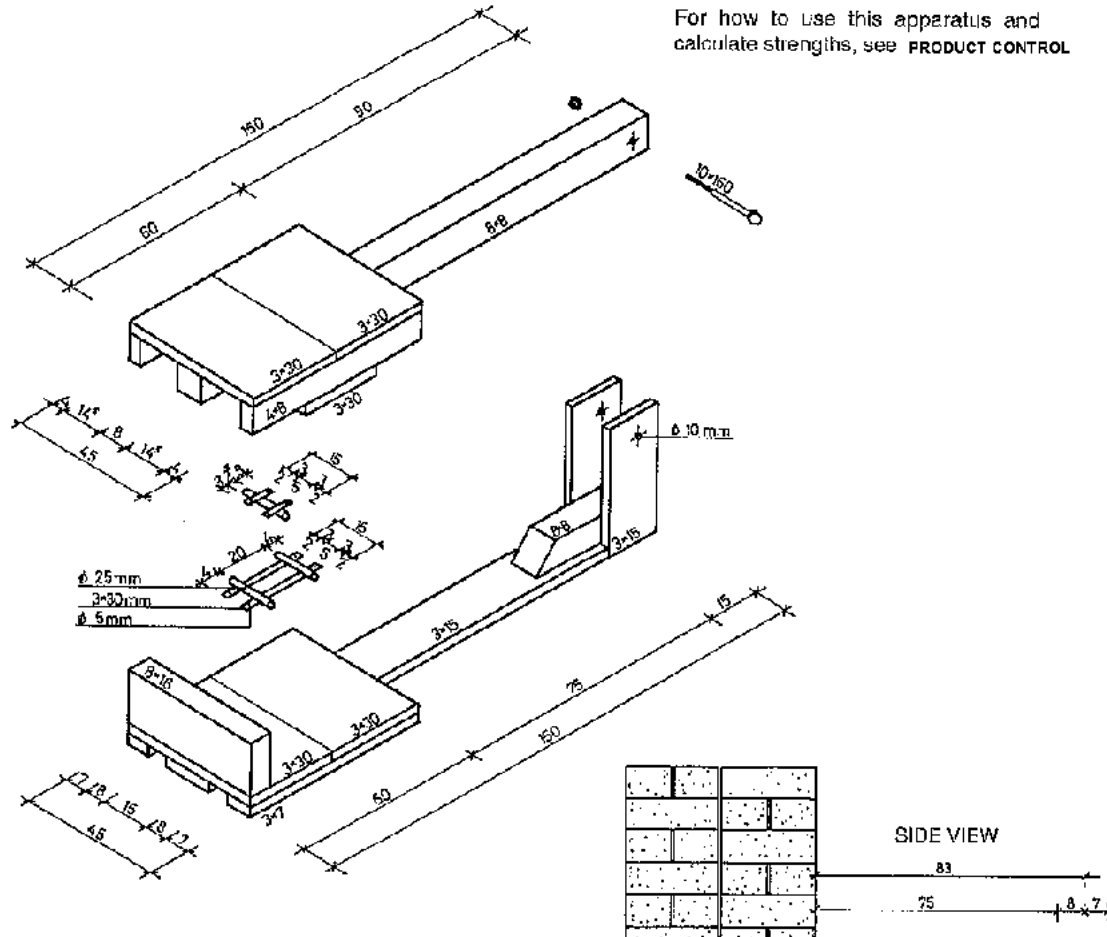

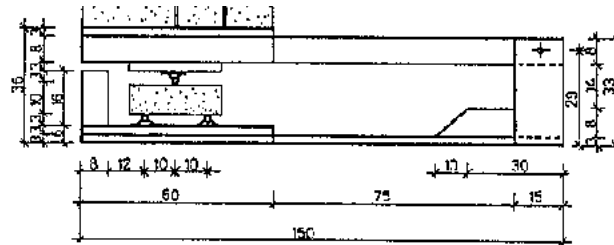

For how to use this apparatus and calculate strength see above.

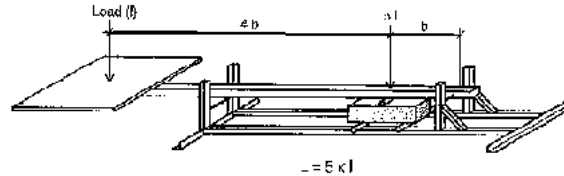

This kind of block-breaking apparatus enables one to test for high strengths, as the pressure applied to the block is equal to five times the load. It should preferably be made out of metal, so that it is sufficiently robust but less bulky.

Flat wheelbarrows

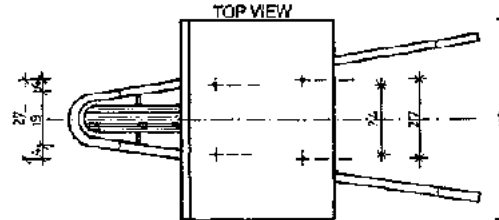
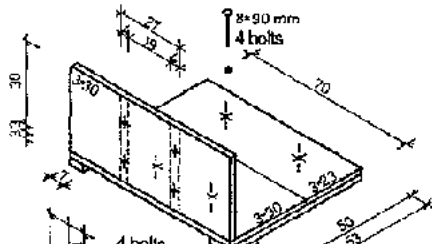

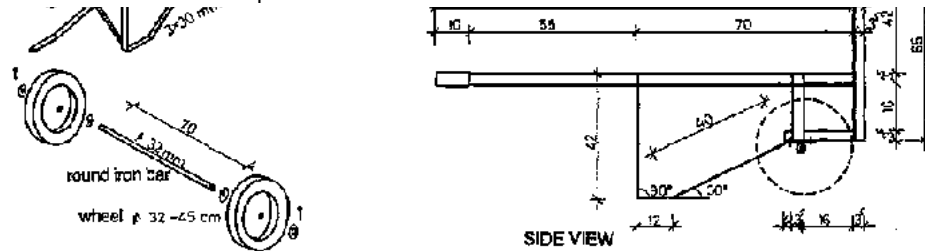

FIGURE

Screen and measuring box

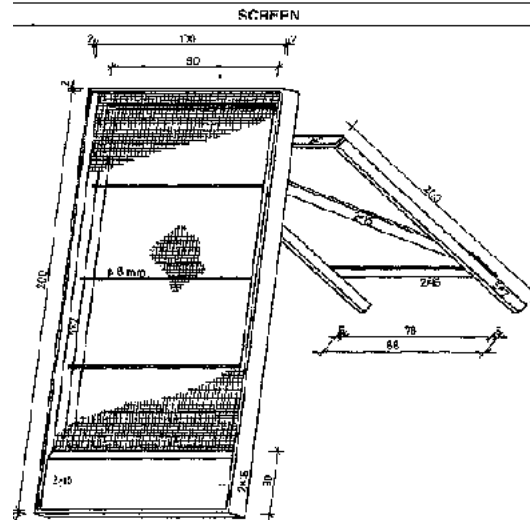

FIGURE

Overall height = 1 × 3 m. (including stand)

usable surface area of screen = 1.5 m²

grid size = 1.00 × 1.75 m

mesh size = variable depending on use = 5, 10, 15 or 20 mm.

Note: the stand is not nailed to the screen so that it can be tilted at different angles

MEASURING BOX (FOR CEMENT, SAND...)

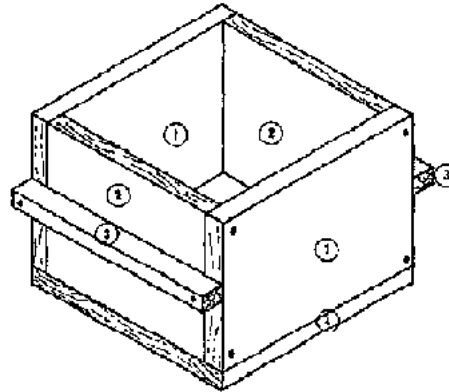

Note : exact dimensions have to be calculated according to the amount of stabilizer used.

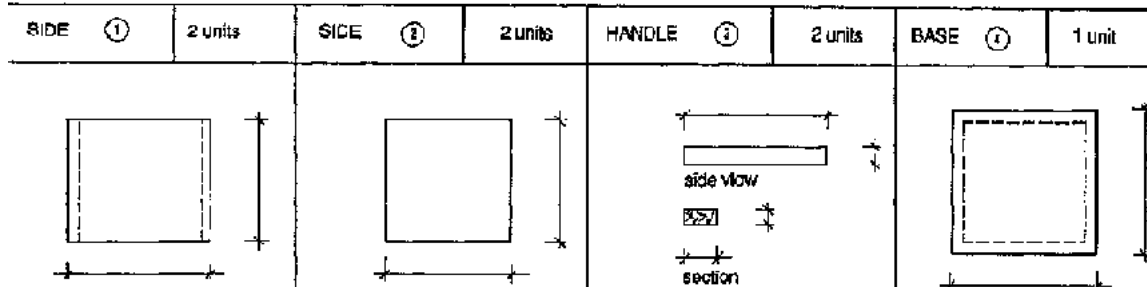

FIGURE

Equipment for site tests

EQUIPMENT LIST

- 2 or 3 small containers

- **folding or retracting measuring tape**
- **5 or 6 transparent cylindrical jars of ≈ 11 capacity**
- **1 to 2 mm mesh sieve**
- **a source of heat (gas, electricity, kiln) + pan or dish**
- **watch or stop-watch**
- **graduated container (bucket, test-tube etc.)**
- **scales (approx. 10 kg capacity and accurate to + 10 to 100g)**
- **mason's set-square**
- **pocket penetrometer**
- **site block-breaking apparatus**
- **bradawl or styles**
- **metal brush**
- **trough min. $l \times w \times h = 50 \times 35 \times 15$ cm**

USE

- **soil (touch test, cigar test, etc.)**
- **cigar test or checking blocks**
- **quick sedimentation test (for soil, sand, gravel)**
- **checking cement or soil preparation, cigar test**
- **measuring moisture content or salinity**
- **mixing and retention time**
- **checking capacities of measuring out containers**
- **moisture content, blocks, capacities, dry density**
- **parallelism of blocks**
- **compaction of blocks**
- **rupture test**
- **piercing blocks**
- **brushing blocks**

- immersion and capillary absorption of blocks

Small laboratory equipment

Note: all the equipment listed for site tests is also needed. Only additional equipment is listed here.

EQUIPMENT

- 5 × 20 mm ϕ sieves with 2, 1, 0.4, 0.2, and 0.1 mm meshes
- 1 rubber pestle and mortar
- 1 Casagrande apparatus
- 1 roll of pH indicator paper
- 1 hand-press for strength tests (optional)
- 2 metal troughs 30 × 30 × 8 cm
- 2 fine brushes for sieving
- 200 ml pipette
- 1 kiln or oven
- 1 pair of scales or dynamometer (1 to 2 kg capacity, accuracy \pm 1g)
- 1 pair of 20 kg capacity scales, accuracy \pm 10 to 50 g
- 20 to 30 small sample containers (aluminium or plastic)
- 1 stop-watch or accurate watch
- 1 small spade
- 1 flexible, 150 mm spatula
- 1 knife
- 1 × 140 mm o funnel
- 1 × 25 ml graduated tube
- 1 × 51 carboy

- **1 hydrometer, 1 thermometer**
- **3 to 6 × 1 l test-tubes**
- **1 × 30 × 30 cm sheet of glass**

USE

- **Particle size analysis**
- **Sedimentation analysis**
- **Atterberg limits**
- **Acidity**
- **Bending and compressive strengths**

Examples of record sheet

The following pages show the record sheets which form the "memory" of the production unit, and thus make it easier to manage, both in terms of quantity and quality. They were designed for use in a particular context and are not necessarily suitable for all production units. They are given here as examples and are shown in order of importance. Control sheets should be completed weekly or twice weekly. Record sheets and quality control sheets should be completed monthly and enable all the data collected in the follow-up and control sheets to be summarized.

The daily check sheet (see below) summarizes the daily activity of the production unit and enables all the critical data to be recorded (amounts used, personnel, equipment, production, disbursements).

The manufacturing control record sheet (see below) is used to check the quality of the ingredients and of the manufacturing procedures for each processing operation.

The product block control record sheet (see below) is used for a final check of the products obtained after processing, i.e. the compressed earth blocks.

The production and quantities consumed record sheets (see below) record inputs and outputs, as well as stocks in hand, and highlight any shortfalls (due to theft or loss).

The output record sheet (see below) enable one to measure the efficiency and regularity of the production unit and to observe rapidly any malfunctioning in the means of production or in its organization.

The quality control sheet (see below) summarizes internal checks (recorded on control sheets) as well as any external laboratory checks carried out.

The summary of outgoings sheet (see below) provides a monthly audit of all expenses linked to production (ingredients, running costs, etc.) and thus a quick check of the variable production cost.

The summary of receipts sheet (see below) provides a monthly audit of income and a quick check of the production unit's profits, by comparing outgoings and income.

The presenting the CEB production unit sheet (see below) provides an overall description of the unit (its statutes, infrastructure, means of production, targets, etc.); it records the history of the unit and tends to be aimed at an external audience (financial backers, clients, etc.).

DAILY CHECK SHEET				
PROJECT	LOCATION	ENTREPRISE	DATE	SHEET N°
Person filling in this sheet ? NAME :		Q U A N T I T Y	No. of hours worked	

Compressed Earth Block - Volume I. M...

Signature	HEAD leader	SKILLED workers	UNSKILLED workers		
-----------	-------------	-----------------	-------------------	--	--

PRODUCTION	TYPE 1 23.5 x 14 x 8	TYPE	TYPE	TYPES OF ACTIVITY OF THE ENTERPRISE	
Target				No activity	
Produced				Block manufacture	
Broken blocks				Removing blocks after curing	
				Preparing mortar	
				Other	

QUANTITIES CONSUMED			OUTGOINGS					REMARKS				
	UNIT	QUANTITY	MATERIAL	U	UC	QTY	TOT.	MATERIAL	U	UC	QTY	TOT.
CEMENT	Amounts		Cement					Polythene				
	Sacks			Sand						Soil		
SAND	Bucket l											
	Soil	Wheelbarrow										
MIXING	U											
ELECTR.	KW											

	MACHINE CHECK						REMARKS					
	GRINDER			WIXER			PRESS					
	YES	NO	COMMENTS	YES	NO	COMMENTS	YES	NO	COMMENTS			
STOPPAGE												
PART REPLACEMENT												
OILING												
CLEANING												

SPECIAL NOTE State of soil, weather, incident	TRANSPORT TO SITE			
	Type of block taken			
	Quantity taken			

FIGURE

MANUFACTURING CONTROL RECORD SHEET									
PROJECT			ENTERPRISE			DATE		SHEET N°	
LOCATION									

SOIL PREPARATION			INTENDED CLASSIFICATION		QUANTITIES			data source - daily check sheet		
STANDARD			YES	TEST USED		BASIC REFERENCES				
			NO			1 mix = blocks		1 sack cement = mixes		1 sack cement = blocks
DESCRIPTION					ACTIONS TAKEN					
					1 mix blocks (average of 3 results)		1 sack cement = mixes		1 sack cement = blocks	

DRY MIX			GOOD	BAD	WET MIX			GOOD	BAD	RETENTION TIME	MAXIMUM TIME			
MIXING TIME			VISUAL EVENNESS		MIXING TIME			WATER CONTENT (drop test)						
T1	T2	T3	YES	NO	T1	T2	T3	GOOD	BAD	I1	I2	I3		
Average			Remarks		Average			Remarks		Average				
										Remarks				

WEIGHT (type)					
APPEARANCE					
MEASUREMENTS					
PARALLELISM					
PIERCING					
BRUSHING					

RUPTURE TESTS		Average acceptable load av. $l = \dots\dots\dots$	Minimum bending strength $\sigma_f \text{ min} = \dots\dots\dots$	Compressive strength $\sigma_c \text{ min} = \dots\dots\dots$	$l ; w ; h$ (see tested block dimensions) $K = \dots ; D = 20 \text{ cm}$	NOTES
Number of blocks (n)						
Load l = weight of (No. blocks + loading plate)						
Bending strength $\sigma_f = \frac{1.5 \times l \times D}{x \times h^2}$						
Compressive strength $\sigma_c = K \times \sigma_f$						

INTERNAL TEXTURE OF BROKEN BLOCKS					NOTES
GOOD					
AVERAGE					

POOR						
IMMERSION TEST - 6 hours immersion and 42 hours drying				NOTES		
GOOD						
AVERAGE						
POOR						

FIGURE

RECORD OF PRODUCTION		PROJECT				LOCATION				ENTERPRISE				DATE				SHEET NO			
Type	Date	PRODUCTION				REMOVAL FROM STOCK				STOCK											
		DAILY				CUMULATIVE				DAILY				CUMULATIVE							
		I	II	III	IV	I	II	III	IV	I	II	III	IV	I	II	III	IV				
Daily	1																				
over	2																				
	3																				
	4																				
	5																				
	6																				
	7																				
	8																				
	9																				
	10																				
	11																				
	12																				
	13																				
	14																				
	15																				
	16																				
	17																				
	18																				
	19																				
	20																				
	21																				
	22																				
	23																				
	24																				
	25																				
	26																				
	27																				
	28																				
	29																				
	30																				

OUTPUT RECORD SHEET				SHEET N°
PROJECT	LOCATION	ENTERPRISE	DATE	
TYPES OF BLOCKS L x w x h				

D	STOCK OF SOIL			TRANSPORT			SUPPORTING GRINDING			TRANSPORT			MIXING					COMPRESSION				CURING STAGE 1			CURING STAGE 2			
	P	T	m ³	P	T	m ³	P	T	m ³	P	T	m ³	P	T	W	D	TE	P	T	TB	No.	P	T	No.	P	T	No.	
1																												
2																												
3																												
4																												
5																												
6																												
7																												
8																												
9																												
10																												
11																												
12																												
13																												
14																												
15																												
16																												
17																												
18																												

Compressed Earth Block - Volume I. M...

		Ground soil		 mixes/1 sack cement
		Screened soil			
		Cement			
MIX Note :		BLOCKS ON REMOVAL FROM MOULD Note :			
Dry mix duration : min		WEIGHT	APPEARANCE	DIMENSIONS	PARALLELISM
Wet mix duration : min					
Waiting time : min					
Moisture content : % l/l mix		AVERAGE OF BLOCKS			
CURING Note :					
Wet curing : days		Relative humidity : %		Internal temperature : °C	
Dry curing : days				External temperature : °C	
BLOCK CONTROL			Remarks :		
number of controls carried out per month :		curing time : 7 d		14 d	21 d
..... standards	 sub-standard		No. of blocks checked : ...	
BLOCKS DURING CURE Note :					
Field test					
Number of days curing	weigh.	dimensions	density	tensile strength	compressive strength
Number of blocks tested :					
LABORATORY TESTS :			Remarks :		
number of controls carried out per month :		curing time : 7 d		14 d	21 d
..... standards	 sub-standard		No. of blocks checked : ...	
number of days curing	Wet compressive strength Mpa	Dry compressive strength Mpa	Tensile strength Mpa	Absorption capacity or immersion	Capillary absorption capacity

FIGURE

SUMMARY OF OUTGOINGS					SHEET N°
PROJECT	LOCATION	ENTERPRISE	MONTH		
SALARIES (including national insurance %)					
Administration	Contract	Specialized workers	Non specialized workers		
					SUB TOTAL
					TOTAL (1)
MATERIALS					
Soil	Sand	Cement	Water	Electricity	
					SUB TOTAL
					TOTAL (2)
TOOLS					
Tarpaulin sheets	Diesel/oil	Shovels/picks			
					SUB TOTAL
					TOTAL (3)
MAINTENANCE					
Equipment	Premises/site production				
					SUB TOTAL
					TOTAL (4)
FIXED COSTS					

Compressed Earth Block - Volume I. M...

Interest charges	Depreciation Amortisation	Rentals	Insurances		
					SUB TOTAL
					TOTAL (5)
TRANSPORT					
Soil	Sand	Current			
					SUB TOTAL
					TOTAL (6)
TOTAL OUTGOINGS		TOTAL BLOCKS PRODUCED		DIRECT PRODUCTION COST	
(1) + (2) + (3) + (4) - (5) + (6)		Equivalent type I (4/4)		TOTAL (I) = currency unit/block	
TOTAL (I) :		TOTAL (II) :		TOTAL (II) :	

FIGURE

SUMMARY OF RECEIPTS

				SHEET N°
PROJECT	LOCATION	ENTERPRISE	MONTH	

SUB-TOTAL FOR THIS SHEET		Total receipts :
		Total outgoings :
TOTAL		PROFIT :
		... % taxes :

FIGURE

PRESENTING THE CEB PRODUCTION UNIT

Founded in : NATURE: private : CAPITAL :
 Address : state
 NGO

 Person responsible :

PRODUCTION EQUIPMENT			
PULVERIZERS			
No.			
type			
date of purchase			
SCREENS			
No.			
type			
date of purchase or manufacture			
MIXERS			
No.			
type			
date of purchase			
PRESSES			
No.			
type			
date of purchase			

INFRASTRUCTURE	
Offices m ² :	Store-room m ² :
Covered area m ² :	Flat area : stock of soil m ³ :
	stock of bricks m ² :
<input type="checkbox"/> WATER	<input type="checkbox"/> public supply
<input type="checkbox"/> stock	ELECTR CITY ID 220 V <input type="checkbox"/> 380 V
m ² :	

PERSONNEL CHART					
Administration	No. pers.	Production	S/W	USW	Other
Head		Control			
Marketing service		Extraction			
Quality control		Transport 1			
Secretariat		Preparation			
Accounting		Transport 2			
		Mixing			
TOTAL		Transport 3			
Auxiliary	No. pers.	Compression			
Diver		Transport 4			
Keeper		Curing			
Store-keeper		Transport 5			
		TOTAL			
TOTAL		Maintenance			

PRODUCTION TARGET
Daily :
Monthly :
Yearly :

PRODUCTION TARGET	
<input type="checkbox"/> URBAN	<input type="checkbox"/> PRIVATE
<input type="checkbox"/> RURA	<input type="checkbox"/> PUB. IC
	<input type="checkbox"/> NGO
MONTHLY INCOME	
<input type="checkbox"/> low cost	from to
<input type="checkbox"/> medium	from to
<input type="checkbox"/> high cost	from to







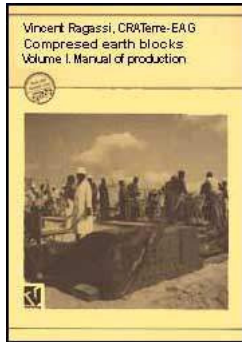

TYPE AND QUALITY RANGE OF PRODUCT MANUFACTURED					
Type					
Name					
Size l x w x h					
Special features (full, hollow, rect.)					
Stabilizer					
Rate of stabilization					
Intended use (load bearing, infill, drainage)					
Density kg/m ³					
Wet compressive strength					
Dry compressive strength					







FIGURE

[Home](#) > [ar.cn.de.en.es.fr.id.it.ph.po.ru.sw](#)



 **Compressed Earth Block - Volume I. Manual of production (GTZ, 1995, 104 p.)**

-  **(introduction...)**
-  **Acknowledgements**
-  **Preface**
-  **Introduction**
-  **Soil**
-  **Stabilization**
-  **Equipment**
-  **Production layout**

-  **Production**
-  **Final pre-production operations**
-  **Quality controls**
-  **Production management and economics**
-  **Annexes**
-  **Bibliography**

Bibliography

DOCUMENTS on compressed earth blocks

A manual of Soil Block Construction. Jagadish K.S.; Venkatarama Reddy, B.V., Alternative Building Series-1, Centre for Application of Science and Technology for Rural Areas (ASTRA), Indian Institute of Science, Bangalore, India, 1981.

Compressed Earth Blocks: Manual of Design and Construction. CRAT erre-EAG, MISEREOR, Aus der Arbeit von GATE, Deutsche Gesellschaft für Technische Zusammenarbeit (GTZ) GmbH, Eschborn, Germany, 1993.

Compressed earth blocks: production equipment. CRATerre (Houben H.; Rigassi V.; Gamier Ph.). CRATerre-EAG, Villefontaine, France, CDI-Centre for the Development of Industry, Brussels, Belgium, 1994.

Product Information: Soil Blocks Presses, Mukerji K., CRATerre-EAG, Aus der Arbeit von GATE, Deutsche Gesellschaft für Technische Zusammenarbeit (GTZ) GmbH, Eschborn, Germany, 1988.

Product Information: Soil Preparation Equipment, Mukerji K., Worner H., CRATerre-EAG, Aus der Arbeit von GATE, Deutsche Gesellschaft für Technische Zusammenarbeit (GTZ) GmbH, Eschborn, Germany, 1991.

Product Information: Stabilizers and Mortars, CRATerre-EAG, Mukerli K., Aus der Arbeit von GATE, Deutsche Gesellschaft für Technische Zusammenarbeit (GTZ) GmbH, Eschborn, Germany, 1993.

Raw earth construction: the French equipment. CRATerre-EAG (Houben H.; Verney P.E.), ENTPE (Olivier M.; Mesbah A.), CRATerre-EAG, Villefontaine, France, 1987.

Small Scale Manufacture of Stabilized Soil Bricks. Smith R.G.; Webb D.T.J., Technical Memorandum N° 1 2, International Labour Office, Geneva, Switzerland, 1987.

Stabilized Soil Blocks for Building. Lunt M.G.; Overseas Building Note N°. 184, Building Research Establishment, Garston, 1980.

The Basics of Compressed Earth Blocks. CRATerre-EAG, Aus der Arbeit von GATE, Deutsche Gesellschaft für Technische Zusammenarbeit (GTZ) GmbH, Eschborn, Germany, 1991.

OTHER USEFUL DOCUMENTS

Building with Earth. CRATerre-EAG (Doat P.; Hays A.; Houben H.; Matuk S.; Vitoux F.), The Mud Village Society, New Delhi, India, 1990.

Building with Earth, A Handbook. Norton J., IT Publications, London, United Kingdom, 1986.

Earth Building Materials and Techniques: Select Bibliography. CRATerre-EAG, Aus der Arbeit von GATE, Deutsche Gesellschaft für Technische Zusammenarbeit (GTZ) GmbH, Eschborn, Germany, 1991.

Earth Construction. A comprehensive guide. CRATerre-EAG (Houben H.; Guillaud H.), IT

Publications, London, United Kingdom, 1993.

Earth Construction Technology (4 volumes). a) Manual on Basic Principles of Earth Application; b) Manual on Production of Rammed Earth, Adobe and Compressed Soil Block; c) Manual on Design and Construction Techniques; d) Manual on Surface Protection, UNCHS-Habitat, Nairobi, Kenya, 1986.

An Advisory Service on Earth Building

The Earth Building Advisory Service (EAS) is one part of an advisory and information service on building materials and construction technologies known as BASIN (Building Advisory Service and Information Network) which is operated jointly by four European Institutions (GATE, ITDG, SKAT and CRATerre-EAG).

EAS is provided by CRATerre-EAG (International Centre for Earth Construction - School of Architecture of Grenoble) which has extensive experience in the production and use of earthen building materials.

EAS is building up a comprehensive database on documents, technologies, equipment, institutions and consultants as well as on projects and programmes related to earth building. This database is used to provide an enquiry service to interested parties world-wide and to provide the basis for a series of technical guides and publications.

Within the BASIN framework, CRATerre-EAG runs specific training courses on building with earth. EAS also undertakes research and development programs in the field of building materials and their application. This activity includes project monitoring and evaluation.

For further information, please contact:

CRATerre-EAG

Earth Building Advisory Service (EAS)

Maison Levrat

Parc Fallavier

BP 53

F-38092 Villefontaine Cedex

France

Tel. (33) 74 95 43 91

Fax (33) 74 95 64 21

Telex 308 658 F



[Home](#) > [ar](#).[cn](#).[de](#).[en](#).[es](#).[fr](#).[id](#).[it](#).[ph](#).[po](#).[ru](#).[sw](#)

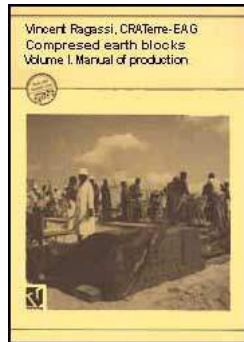

 **Compressed Earth Block - Volume I. Manual of production (GTZ, 1995, 104 p.)**



(introduction...)



Acknowledgements



Preface



Introduction



Soil



Stabilization



Equipment



Production layout



Production



Final pre-production operations

	Quality controls
	Production management and economics
	Annexes
	Bibliography

Acknowledgements

Deutsches Zentrum fr Entwicklungstechnologien - GATE

Deutsches Zentrum fr Entwicklungstechnologien - GATE - stands for German Appropriate Technology Exchange. It was founded in 1978 as a special division of the Deutsche Gesellschaft fr Technische Zusammenarbeit (GTZ) GmbH. GATE is a centre for the dissemination and promotion of appropriate technologies for developing countries. GATE defines "Appropriate technologies" as those which are suitable and acceptable in the light of economic, social and cultural criteria. They should contribute to socio-economic development whilst ensuring optimal utilization of resources and minimal detriment to the environment. Depending on the case at hand a traditional, intermediate or highly-developed can be the "appropriate" one. GATE focusses its work on the key areas:

- Dissemination of Appropriate Technologies: Collecting, processing and disseminating information on technologies appropriate to the needs of the developing countries: ascertaining the technological requirements of Third World countries: support in the form of personnel, material and equipment to promote the development and adaptation of technologies for developing countries.

- Environmental Protection. The growing importance of ecology and environmental protection require better coordination and harmonization of projects. In order to tackle these tasks more effectively, a coordination center was set up within GATE in 1985.

GATE has entered into cooperation agreements with a number of technology centres in

Third World countries.

GATE offers a free information service on appropriate technologies for all public and private development institutions in developing countries, dealing with the development, adaptation, introduction and application of technologies.

Deutsche Gesellschaft für Technische Zusammenarbeit (GTZ) GmbH

The government-owned GTZ operates in the field of Technical Cooperation. 2200 German experts are working together with partners from about 100 countries of Africa, Asia and Latin America in projects covering practically every sector of agriculture, forestry, economic development, social services and institutional and material infrastructure. - The GTZ is commissioned to do this work both by the Government of the Federal Republic of Germany and by other government or semi-government authorities.

The GTZ activities encompass:

- appraisal, technical planning, control and supervision of technical cooperation projects commissioned by the Government of the Federal Republic or by other authorities**
- providing an advisory service to other agencies also working on development projects**
- the recruitment, selection, briefing, assignment, administration of expert personnel and their welfare and technical backstopping during their period of assignment**
- provision of materials and equipment for projects, planning work, selection, purchasing and shipment to the developing countries**
- management of all financial obligations to the partner-country.**

Deutsches Zentrum für Entwicklungstechnologien - GATE

**in: Deutsche Gesellschaft für Technische Zusammenarbeit (GTZ) GmbH
P. O. Box 5180
D-65726 Eschborn
Federal Republic of Germany
Tel.: (06196) 79-0
Telex: 41523-0 gtz d
Fax: (06196) 797352**

Scientific supervision: Patrice Doat, teaching architect; Hubert Guillaud, research architect; Hugo Houben, research engineer

Author: Vincent Rigassi, architect

Additional assistance: Pascal Odul, engineer architect; Thierry Joffroy, architect; Alexandre Douline, senior technician; Serge Mani, architect; Sbastien d'Ornano, engineer; Philippe Garnier, architect; Francois Vitoux, teaching architect

Illustrations: Nicolas Schweizer, illustrator; Elena Ochoa, architect; Patrick Idelman, draughtsman

Documentation: Marie-France Ruault

Format: Rgine Rivire; Christle Chauvin

Publishing coordination: Titane Galer

English Translation: Claire Norton

© Photographs

CRATTerre-EAG: Dario Angulo, Patrice Doat, Sbastien d'Ornano, Hubert, Hugo Guillaud, Hugo Houben, Thierry Joffroy, Serge Mani, Pascal Odul, Vincent Rigassi

With the following exceptions: photograph 1 FOTOMEDIA Ltd India, photograph 5 : Pierrot; photographs 1 and 2; Bruno Pignal; photograph 3: Christian Lignon; photograph 4: Philippe Romagnolo

© Drawings: CRATerre-EAG

Die Deutsche Bibiothek - CIP-Einheitsaufnahme

Compressed earth blocks:

A publication of Deutsches Zentrum fr Entwicklungstechnologien - GATE, a division of the Deutsche Gesellschaft fr Technische Zusammenarbeit (GTZ) GmbH in coordination with the Building Advisory Service and Information

Network - BASIN/ (Engl. Transl.: Claire Norton). - Braunschweig: Vieweg.

NE: Norton, Claire (bers.); Deutsches Zentrum fr Entwicklungstechnologien <Eschborn> Vol 1. Manual of production / Vincent Rigassi. (III.: Nicolas Schweizer; Patrick Idelman). - 1995

ISBN 3-528-02079-2





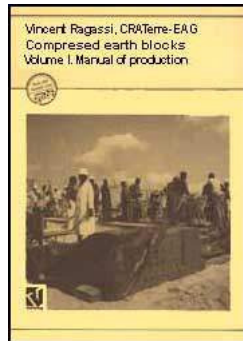

NE: Rigassi, Vincent









[Home](#) > [ar.cn.de.en.es.fr.id.it.ph.po.ru.sw](#)



Compressed Earth Block - Volume I. Manual of production (GTZ, 1995, 104 p.)

-  *(introduction...)*
-  Acknowledgements
-  Preface
-  Introduction
-  Soil
-  Stabilization
-  Equipment

-  **Production layout**
-  **Production**
-  **Final pre-production operations**
-  **Quality controls**
-  **Production management and economics**
-  **Annexes**
-  **Bibliography**

Preface

Since the early 1950s, much attention has been focussed on the importance of access to housing for low-income populations, notably by undertaking research into building materials and techniques which aim to make the best possible use of local resources, both material and cultural. In 1976, the Human Settlements conference in Vancouver gave new impetus to this approach, condemning the transposition of Western building techniques for low-cost housing, and recommending the design of technologies suited to climatic, social and cultural contexts, the gradual reduction of imports of products and services linked to construction, and the drawing up of norms and regulations which covered the basic needs of end-users whilst taking account of their economic possibilities.

In December 1988, the General Assembly of the United Nations proclaimed their "Global Strategy for Housing to the year 2000". The target - guaranteed access to decent and durable housing for all by the year 2000, by relying on a vast formal and informal private sector (a sector far more efficient in producing housing), in other words by taking account of the often ignored wealth of existing human resources, now recognised beyond doubt, particularly with regard to social dynamics and building cultures.

This book is the fruit of the work of a team whose objectives are totally consistent with this approach. It is intended to be a means towards this end, a tool to arouse, stimulate,

and consolidate confidence in current and future applications. It should be read as the state of the art of current, technical know-how, acquired thanks to the efforts of many, often pioneering, practitioners working towards this goal.

The work attempts mainly to illustrate both general means of production and actual physical techniques, as well as their economic implications. It aims more to be an aid to decision-making than to provide an answer to problems; problems which will necessarily have more than one possible solution and which require an understanding of the interaction between a building material and its use in construction.

CEB technology offers an alternative kind of building construction: accessible, high quality and over the last fifty years increasingly sanctioned from a scientific, technical, social and cultural point of view. The Compressed Earth Block is one of those rare "modern materials" which has sufficient production flexibility to enable it to be integrated into both formal and informal sectors of activity, from "cottage" industry to full-scale industrial plants.

This book has been made possible thanks to the active collaboration which our team has developed over the past few years with GATE-GTZ (German Technical Cooperation) in the field of the dissemination of suitable building materials and techniques, through training and pilot architectural applications. Our particular thanks are due to Mrs Hannah Schreckenbach, of this same organisation, for her support with the publication of the book, as well as for her confidence in its authors. We also wish to extend our thanks to all the individuals active in the field - architects, entrepreneurs, builders, block manufacturers - whose work has given rise to built examples using compressed earth blocks, thus reinforcing confidence in the potential usefulness and quality of this technology. May their example inspire yet more practitioners to follow in their footsteps and to continue to share, as they do today, their knowledge and experience.



[Home](#) > [ar.cn.de.en.es.fr.id.it.ph.po.ru.sw](#)

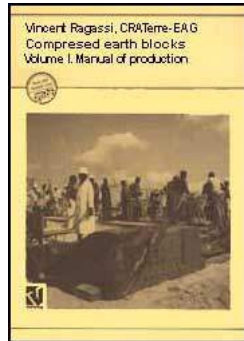

Compressed Earth Block - Volume I. Manual of production (GTZ, 1995, 104 p.)



Introduction



Historical background



Advantages of ceps



Key questions



Production



Production lines



The material



Principle CEB characteristics



Launching production



The development of the material



Earth - An architectural tradition

Compressed Earth Block - Volume I. Manual of production (GTZ, 1995, 104 p.)

Introduction

Historical background

The compressed earth block is the modern descendent of the moulded earth block, more commonly known as the adobe block. The idea of compacting earth to improve the quality

and performance of moulded earth blocks is, however, far from new, and it was with wooden tamps that the first compressed earth blocks were produced. This process is still used in some parts of the world. The first machines for compressing earth probably date from the 18th century. In France, Francois Cointeraux, inventor and fervent advocate of "new pise" (rammed earth) designed the "crecise", a device derived from a wine-press. But it was not until the beginning of the 20th century that the first mechanical presses, using heavy lids forced down into moulds, were designed. Some examples of this kind of press were even motor-driven. The fired brick industry went on to use static compression presses in which the earth is compressed between two converging plates. But the turning point in the use of presses and in the way in which compressed earth blocks were used for building and architectural purposes came only with effect from 1952, following the invention of the famous little CINVA-RAM press, designed by engineer Raul Ramirez at the CINVA centre in Bogota, Columbia. This was to be used throughout the world. With the '70s and '80s there appeared a new generation of manual, mechanical and motor-driven presses, leading to the emergence today of a genuine market for the production and application of the compressed earth block.

A HIGHLY DEVELOPED TECHNOLOGY

Since its emergence in the '50s, compressed earth block (CEB) production technology and its application in building has continued to progress and to prove its scientific as well as its technical worth.

Research centres, industrialists, entrepreneurs and builders have developed a very sophisticated body of knowledge, making this technology the equal today of competing construction technologies. CEB production meets scientific requirements for product quality control, from identification, selection and extraction of the earth used, to quality assessment of the finished block, thanks to procedures and tests on the materials which are now standardised. This scientific body of knowledge ensures the quality of the

material. Simultaneously, the accumulated experience of builders working on a very large number of sites has also enabled architectural design principles and working practices to emerge and today these form practical points of reference for architects and entrepreneurs, as well as for contractors.

ROLE IN DEVELOPMENT

The setting up of compressed earth block production units, whether on a small-scale or at industrial level, in rural or urban contexts, is linked to the creation of employment generating activities at each production stage, from earth extraction in quarries to building work itself. The use of the material for social housing programmes, for educational, cultural or medical facilities, and for administrative buildings, helps to develop societies' economies and well-being. CEB production forms part of development strategies for the public and the private sector which underline the need for training and new enterprise and thus contributes to economic and social development. This was the case in the context of a programme on the island of Mayotte, in the Comoros archipelago, for the construction of housing and public buildings, a programme today regarded as an international reference. The use of CEBs which followed the setting up of an island production industry proved to be pivotal in Mayotte's development, founded on a building economy generating employment and local added value in monetary, economic and social terms.

SOCIAL ACCEPTANCE

CEBs represent a considerable improvement over traditional earth building techniques. When guaranteed by quality control, CEB products can very easily bear comparison with other materials such as the sand-cement block or the fired brick. Hence the allegiance it inspires amongst decision-makers, builders and end-users alike.

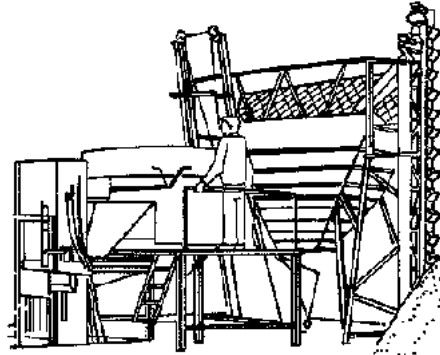

1980-1990, industrial units

THE FUTURE OF CEBS

CEB technology has made great progress thanks to scientific research, to experimentation, and to architectural achievements which form the basis of a wide range of technical documents and academic and professional courses. A major effort is now being devoted to the question of norms and this should help to confer ultimate legitimacy upon the technique in the coming years.

Advantages of ceps

The CEB technique has several advantages which deserve mention:

- The production of the material, using mechanical presses varying in design and operation, marks a real improvement over traditional methods of producing earth blocks, whether adobe or hand-compacted, particularly in the consistency of quality of the products obtained. This quality furthers the social acceptance of a renewal of building with earth.**

- **Compressed earth block production is generally linked to the setting up of quality control procedures which can meet requirements for building products standards, or even norms, notably for use in urban contexts.**
- **In contexts where the building tradition already relies heavily on the use of small masonry elements (fired bricks, stone, sand-cement blocks), the compressed earth block is very easily assimilated and forms an additional technological resource serving the socioeconomic development of the building sector.**
- **Policy-makers, investors and entrepreneurs find the flexibility of mode of production of the compressed earth block, whether in the rural or the urban context, small-scale or industrial, a convincing argument.**
- **Architects and the inhabitants of buildings erected in this material are drawn to the architectural quality of well-designed and well-executed compressed earth block buildings.**

TECHNICAL PERFORMANCE

Compacting the soil using a press improves the quality of the material. Builders appreciate the regular shape and sharp edges of the compressed earth block. The higher density obtained thanks to compaction significantly increases the compressive strength of the blocks, as well as their resistance to erosion and to damage from water.

FLEXIBILITY OF USAGE

The wide range of presses and production units available on the current market makes the material very flexible to use. With production ranging from small-scale to medium and large-scale semi-industrial or industrial, CEBs can be used in rural and urban contexts and can meet very widely differing needs, means and objectives.

STANDARDS AND MODELS

Compressed earth blocks are of standard sizes and meet quality requirements which are suitable for carrying out large housing or infrastructure programmes, based on the design of architectural models. These standard block sizes and shapes, as well as the architectural models, can be defined before the programme begins, at the design stage, with great flexibility.

HIGHLY PRACTICAL NATURE OF THE TECHNOLOGY

The common dimensions of CEBs lend themselves to great flexibility of use in various building solutions, as load-bearing masonry or as in-fill. CEBs can also be used for arches, vaults and domes, as well as for jack-arch floors.

GENUINE ARCHITECTURAL MERIT

Very fine masonry work, equal to fired brick building traditions, can be realised thanks to the high quality of compressed earth blocks. The architectural application of CEBs can range from social housing to luxury homes and prestigious public buildings. Since the '50s, the experience of architects and builders has been considerably enriched by widely differing architectural realisations in all areas of application. Experimentation has to a large extent given way to technological and architectural expertise and has enabled CEB technology to evolve to the point where today it can be considered the equal of other construction technologies using small masonry elements.

AN ALTERNATIVE TO IMPORTATION

Whilst meeting the same requirements as other present-day building materials, the CEB also presents a technological alternative to imported materials, the use of which is often justified because of the need for standardisation. CEBs have the advantage of being

produced locally, whilst still meeting this need.

SOME CONSTRAINTS

The quality of CEBs depends on good soil selection and preparation and on the correct choice of production material. Architectural use of the material must take account of specific design and application guidelines which must be applied by both architects and builders. This means that professional skills must be ensured by suitable training. From an economical point of view, CEBs can sometimes fail to be competitive with other local materials. A technical-economic survey will enable the feasibility of the technology to be determined in each application context.

Key questions

When considering embarking on the production or application of compressed earth blocks, particular attention must be paid to various points as follows:

- mastering a new production technique,**
- mastering new building principles,**
- ensuring that the production process is well organised and managed,**
- marketing a building material.**

In order to start out without taking unnecessary risks and to check that one has planned sufficiently, one should begin by asking oneself the following questions:

RESOURCES

- Do you have information on the suitability of the local soils for use in the manufacture of CEBs?**

- **Do you already have a building programme and of what size? How many CEBs does that represent (using 33 blocks per m²)?**
- **If it is intended to sell the blocks, have you already gathered together data on demand for building materials in your region? Do you have favourable indications as far as the attitude of the population towards CEBs is concerned?**
- **Do you have information on the availability and costs of stabilizers?**

SKILLS

- **Are you aware that producing good blocks is not enough and that you must also ensure that they are correctly used to obtain strong buildings?**
- **Do you know building entrepreneurs who have a thorough understanding of the basic design and application principles for CEB buildings?**
- **Do you know where to find technical and training support?**

MANAGEMENT/FINANCING

- **Have you collected information on the various kind of equipment available and have you started to compare them?**
- **Do you have experience in management and accounting?**
- **Are you aware that a project of this kind cannot succeed overnight and that it will be some time before your efforts are rewarded?**

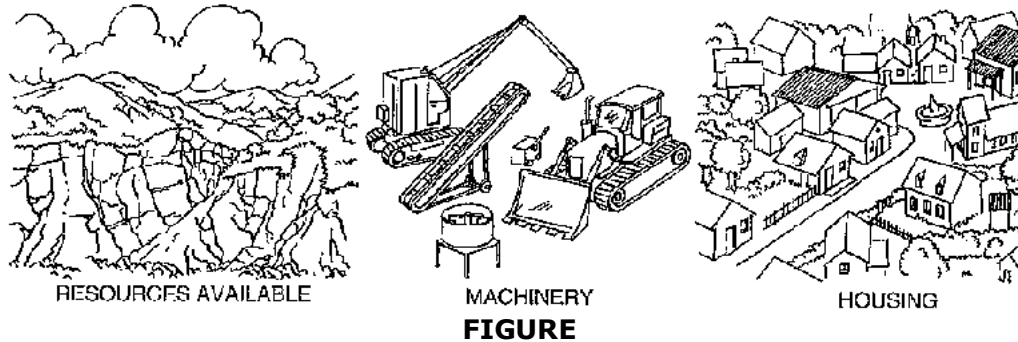

Production

GENERAL INTRODUCTION

The production of compressed earth blocks can be regarded as similar to that of fired earth blocks produced by compaction, except that there is no firing stage. Production will be differently organized, depending on whether it takes place in the context of small, "cottage industry" units (or brickworks), or in the context of a semi-industrial or industrial unit. Production, drying and stocking areas will also vary depending on the methods of production selected and the production conditions dictated by the climatic, social, technical and economic environment.

No production period or season is particularly favourable or unfavourable, providing that measures are taken in wet or hot seasons (if any) to protect production areas or areas used for stocking.

Generally speaking, as far as production rates are concerned, these will depend largely on the way production is organised and on the type of equipment used.

PRODUCTION CYCLES

Here we describe a cement or lime-stabilizer compressed earth blocks production corresponding to a small-scale production organisation, using all kinds of presses with the exception of industrialized production units.

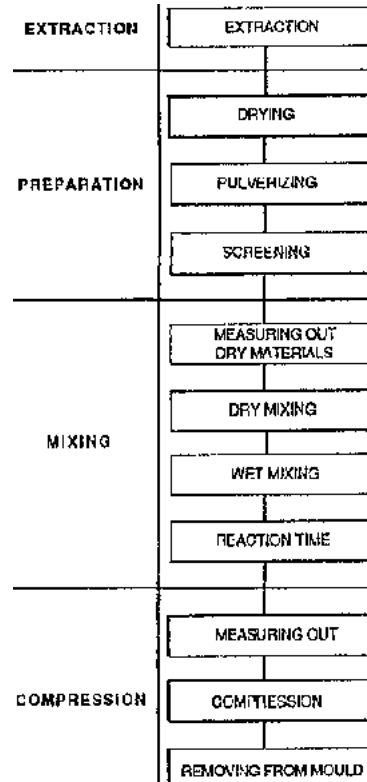

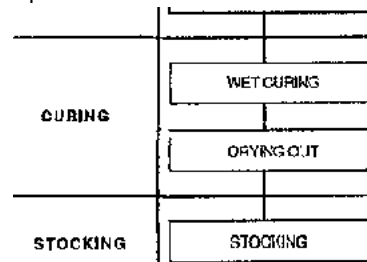
**FIGURE**

- **EXTRACTION** from the quarry or pit.
- **DRYING** by spreading in thin layers or passing through a hot-air cyclone.
- **PULVERIZING** to break up lumps of clay.
- **SCREENING** to eliminate undesirable elements after general preparation.
- **MEASURING OUT** the dry soil by weight or by volume with a view to mixing it with water and/or with stabilizer.
- **DRY MIXING** to maximize the effectiveness of a stabilizer in powder form.
- **WET Mixing** to add water by spraying after adequate dry mixing, or directly in the form of a liquid stabilizer.
- **REACTION** during variable hold-back time depending on the nature of the stabilizer; very short for cement, longer for lime.
- **MEASURING OUT** the amount of mixed material for optimum block density.

- **COMPRESSION of the mixed material.**
- **REMOVING the block from the mould.**
- **WET CURING, the length of time depending on the climate and the nature of the stabilizer.**
- **DRYING OUT which should enable the quality required to be achieved.**
- **STOCKING of the products ready for use.**

PRESSES

In compressed earth block production, the presses are used to compact the particles, thus increasing density.

Manual presses

Only the compression and ejection of the block are carried out by the manually operated machine.

Theoretical output: 300 to 1 500.

Motor-driven presses

Only the compression and ejection of the block are carried out by the motor-driven machine.

Theoretical output: 1 000 to 5 000.

Mobile production units

Production units which are easy to transport and where in addition to the compression and ejection of the block, preparation of the material and/or the removal of the products are motorized and sometimes automatic.

Theoretical output: 1 500 to 4 000.

Fixed production units

Products units which can be transported only with difficulty and where, in addition to the compression and ejection of the block, preparation of the material and/or the removal of the products are motorized and sometimes automatic.

Theoretical output: 2 000 to 10 000 and more.

PULVERIZERS

Lumps of soil must be broken up to obtain a homogeneous mix of the constituents.

Grinder

This can also fragment stones or excessively large gravel and thus even out the particle size distribution.

Crusher

This breaks up only the particles which are bound together by clays and is therefore better suited to fine soils.

SCREENS

Screening is indispensable either when the texture is incorrect (excessively large

constituents or too much organic material) or when pulverizing is inadequate.

MIXERS

Mixing is particularly important for the ultimate quality of the product. A homogeneous mix is indispensable. One should preferably proceed first with dry mixing. For an even distribution of moisture, water should either be sprinkled on, or added in the form of steam.

Production lines

TYPES

Various types of production lines can be installed depending on the way the individual pieces of equipment are assembled together. These can be differentiated using the following main criteria: productivity, investment and the quality of the labour-force employed. The table below shows typical examples ranging from a small manual unit to an industrial unit, with medium-scale production units (types 2 to 5) being of most relevance.

TYPES OF PRODUCTION LINE ACCORDING TO EQUIPMENT USED

TYPES	TYPE 1 manual	TYPE 2 1/4 motorized	TYPE 3 1/2 motorized	TYPE 4 3/4 motorized	TYPE 5 motorized	TYPE 6 automated
Specific pieces of equipment	1 manual press	2 manual presses 1 mixer (250 l)	2 manual presses 1 mixer (250 l) 1 crusher/screen*	1 motorized press 1 mixer (250 l) 1 crusher/screen*	1 motorized press 1 mixer (250 l) 1 crusher/screen* mechanized transport **	1 automated unit automated transport
Production/day 29,5x14x9 blocks	600-1 000	1 200-1 500	1 200-1 500	1 500-2 000	1 500-2 500	5 000-6 000
Labour	9-10	11-13	10-12	9-11	8-10	8-10
Production area						
Total (in m ²)	380	630	630	805	2 330	4 900
Secure space	10	15	15	15	25	100
Covered space	30	100	100	55	50	300
Open air space	340	515	515	735	2 225	4 500
Investment in equipment (\$)	2 300	10 000	14 500	23 000	46 000	83 000
Infrastructure (excl. land) (\$)	2 250	4 150	4 150	4 500	10 000	38 000
TOTAL	4 250	14 150	18 650	27 500	56 000	121 000

FIGURE

*** Type of soil and type of machine used for its preparation:**













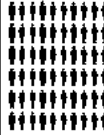
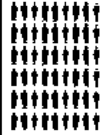
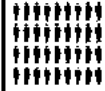

- high proportion of gravel with clay lumps -> grinder
- high proportion of fines with clay lumps -> crusher
- high proportion of stones and gravel with no clay lumps -> screen

**** Mechanized transport:**

- conveyor belt, dosage system, hopper, pallet transporter or fork-lift truck (see table of types of equipment).

N.B. All prices are given only as indications and to allow broad comparison. For more details, consult the manufactures and GATE's Product Information sheets. The productivity rates quoted are calculated assumption of normal usage of the machines, but can vary significantly.

SUGGESTED PRODUCTIVITY/LABOUR/INVESTMENT RATIOS

To produce ≈ 8 000 blocks in one day with production unit	TYPE 1	TYPE 2	TYPE 3	TYPE 4	TYPE 5	TYPE 6
Requires : ... production lines	8 lines 	5 lines 	5 lines 	4 lines 	3 lines 	1 line 
i.e. a labour input of	86 men 	60 men 	30 men 	40 men 	27 men 	9 men 
and fixed capital/day (assuming a 3 years amortisation period) of	150 \$/day 	275 \$/day 	300 \$/day 	425 \$/day 	650 \$/day 	465 \$/day 

FIGURE

Comment

The ratio of type 1 to type 6 is approximately nine to one as far as the number of lines of production and of workers are concerned. The capital invested sheds light on the table (next fig: Changes in productivity according to the level of investment) with type 5 requiring a major investment, i.e. more fixed capital than type 6, and this for virtually the same productivity as type 4.

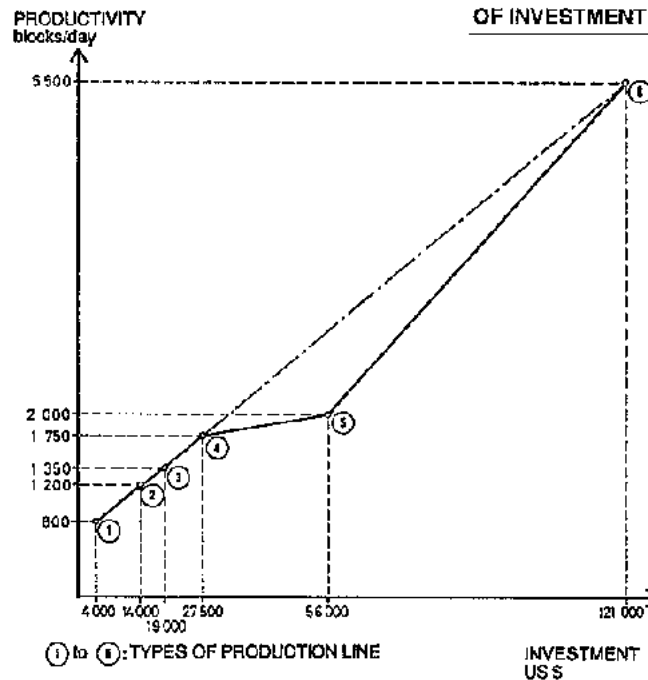
CHANGES IN PRODUCTIVITY ACCORDING TO THE LEVEL**FIGURE****Comment**

As can be seen, productivity stagnates whereas the investment required increases significantly between production lines 4 and 5, i.e. with effect from the mechanization of

the transport systems (daily production in the order of 2000 blocks measuring 29.5 × 14 × 9 cm)

Given the nature of the equipment currently available, it seems vital to move on mechanized transport only in conjunction with higher (type 6) productivity if the investment is to be viable (see picture above: suggested productivity/labour/investment ratios for fixed capital assets)

SUGGESTED AMOUNTS CONSUMED

Production/day Blocks 23.5 x 14 x 9 cm		Type 1 600-1 000	Types 2 - 3 1 200-1 500	Type 4 1 500-2 000	Type 5 1 500-2 500	Type 6 5 000-6 000
EXTRACTION	Untreated soil/day (m ³)	4.2	8	12	15	40
	Untreated soil/month (m ³)	89	180	265	330	900
	Number of cores 4 to 5 m ³	21	40	59	74	200
	Surface area dug for deep extraction 1.5 m/month (m ²)	65	125	180	225	610
STABILIZER	Assuming 6 % stabilizat on kg/day	300	600	750	900	2 500
	Tons/month	6.3	13	16.5	19.5	54
WATER	Litres/day	475	950	1 250	1 460	4 000
	m ³ /month	10.5	21	27.5	32.5	98.5

FIGURE**Comment**

The consumption of raw materials between the various work stations must be calculated

in the light of the projected target productivity. High consumptions will require:

- sufficient natural resources (large soil deposits)**
- a large cash flow provision to cover the purchase of materials, overheads and wages, particularly at the start of production.**

The figures given on the left are approximate indications only and should be accurately calculated for each given context. They do, however, provide a base for an initial evaluation.

The material

Compressed earth blocks are small masonry elements, parallelepiped in shape, but the common dimensions of which differ from those of hand-moulded earth blocks or of fired bricks and vary depending on the type of specially developed press and mould used.

For masonry constructions, solid blocks are most commonly used.

For this reason, compressed earth block production has typically used block dimensions consistent with a unit weight in the order of 6 to 8 kg and with the possibility of building walls 15, 30 or 45 cm thick. The most common (or nominal) work dimensions in use today are 29.5 × 14 × 9 cm (l × w × h), which gives a material which is very easy to handle and very flexible in its use for many configurations of wall and roof building systems (jack-arch floors, vaults and domes) and of arched openings.

There are 4 main families of blocks:

Solid blocks

These are mainly prismatic in shape. They fulfil very widely differing functions.

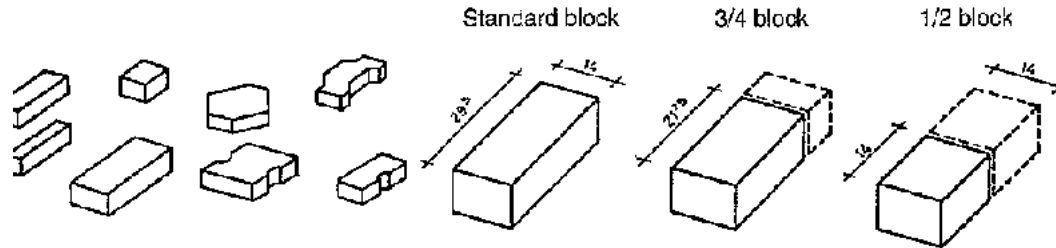

FIGURE (Standard block; $\frac{3}{4}$ block; $\frac{1}{2}$ block)

Hollow blocks

Generally the voids of hollow blocks account for a total of 5 to 10%, and up to 30% using sophisticated techniques. Voids can improve the adherence of the mortar and reduce the weight of the block. Certain hollow blocks can be used to build ring-beams (lost formwork).

Perforated blocks

These are light but require fairly sophisticated moulds and greater compressive force. They are suitable for reinforced masonry (in earthquake areas).

Interlocking blocks

These can be assembled without mortar, but they require sophisticated moulds and high compressive force. They are often used for non-loadbearing structures.

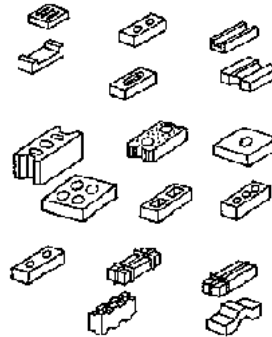

FIGURE

6 MAIN USE OF CEBS

INTENDED USE		BLOCKS REQUIRED
normal load-bearing masonry		
infill masonry		
	- ventilation	

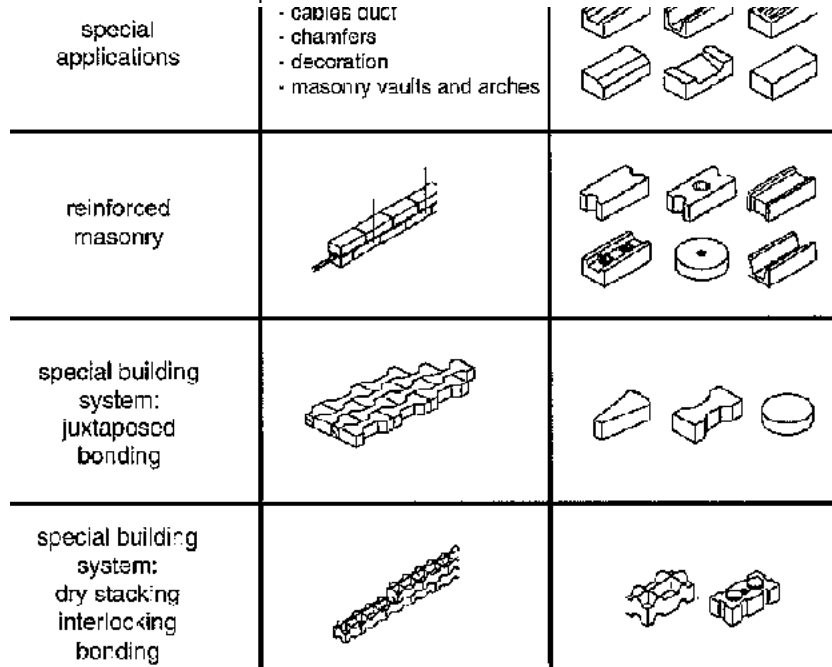



FIGURE

Principle CEB characteristics

Comparisons between the characteristics and performances of the compressed earth block and those of other classic masonry materials, should not be restricted solely to taking account of their compressive strength or differences in production costs. The issue is a more complex one and any comparison should rather be based on a wide register of parameters, including: the shape and dimensions of the material, its appearance (surface,

texture, attractiveness,) as well as a full range of measures of performance, such as - indeed - dry and wet compressive strength, but also thermal insulation, apparent density, and durability. But over and above this aspects linked to the production and use of the material highlight all the complexity of such comparisons by taking account of such factors as the nature of the soil deposits supplying the raw material, the means by which this raw material is processed into a building material, the energy involved in this processing or production, the nature of the material when considered as a building component or element, and its state in the finished building, taking account of questions of durability and maintenance. This "intelligent" way of comparing materials with each other, over and above scientific considerations intended to compare materials in laboratory conditions, takes account of the architectural and practical application of materials. In the same way, cost comparisons should not be made between equal volumes of materials, but by comparing the m² of habitable surface area built using various materials, each of them with their own design requirements.

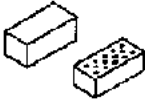
COMPARISON BETWEEN CEBs AND OTHER MASONRY MATERIALS

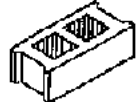
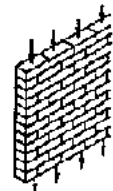
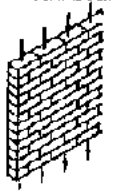
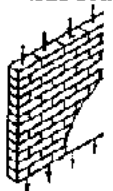
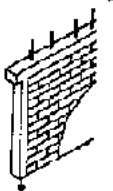
Characteristics	Unit	CEB	F rec bricks	Adobas	Concrete blocks
SHAPE AND SIZE					
Type					
l x w x h	cm	29.5 x 14 x 9	22 x 10.5 x 6.5	40 x 20 x 10	40 x 20 x 15
APPEARANCE - Surface - Visual aspect		smooth medium to good	rough to smooth good to excellent	irregular poor	rough average
PERFORMANCES - Wet compressive strength - Reversible thermal dilation - Thermal insulation - Density Durability	Mpa % W/m°C kg/m³	1 to 4 0.02 to 0.2 0.81 to 1.04 1 700 to 2 200 low to very good	0.5 to 6 0 to 0.02 0.7 to 1.3 1 400 to 2 400 low to excellent	0 to 5 - 0.4 to 0.8 1 200 to 1 700 poor	0.7 to 5 0.02 to 0.05 1.0 to 1.7 1 700 to 2 200 low to very good
USE IN MASONRY		load-bearing  without render	load-bearing  without render	load-bearing  with render	infill  with render

FIGURE**GENERAL SPECIFICATIONS (given as for a standard block)**

Tolerance on dimensions

- **length: +1, -3 mm,**
- **width: +1, -2 mm,**
- **height: +2, -1 mm.**

Roughness of external sides

- **External faces of the block which are to be rendered or faces which will not be visible within the masonry should preferably have a rough finish.**
- **External faces of the block which are not to be rendered should have a smooth finish.**

Pitting, holes, punctures, scratches

- **For rough finish faces, these should not exceed 15% of the surface.**
- **For smooth finish faces, these should not exceed 1% of the surface.**

Density

- **Dry: minimum: 1,700 kg/m³ or 6.319 kg/block; recommended: 2,000 kg/m³ or 7.434 kg/block.**
- **Freshly moulded: minimum: 1,870 kg/m³ or 6.950 kg/block; recommended: 2,200 kg/m³ or 8.177 kg/block.**

Surface flatness

- **Sides: any deviation should not exceed 1 mm.**
- **Compression surfaces: any deviation should not exceed 3 mm.**

Edge straightness

- **Any deviation should not exceed 2 mm.**
- **Some roughness of the edges is tolerated, as long as it is due to turning out and not due to faulty manipulation.**

Obliqueness of surfaces

- **The external faces, shape and size tolerances must be respected.**
- **The internal faces of voids must be oblique and should have no acute angles.**

Launching production

- 1. First check on the local availability of sufficient suitable soil and on how easy it is to organize its extraction.**
- 2. Once a soil supply has been established, a feasibility study should be carried out to prepare the project. This feasibility study should comprise a technical study including an analysis of the local soils, a description of the best production methods in the local context, a description of the equipment needed and where it would be available, and a study of production costs. A market survey should complement the technical study, including figures about the demand for building materials and the opportunities for using CEBs, the size and shape of the product and the maximum price for the CEB to be more attractive than other building materials.**
- 3. Local building regulations, and if they allow the use of CEBs, must be checked, as must requirements about technical performance.**
- 4. Securing the capital to cover the investment required and the first few months' expenditure is the next step before preparing the production area.**

- 5. Ordering the equipment can be done simultaneously with the preparation of the production area and the construction of the few buildings necessary: storerooms, office, etc.**
- 6. A training course on production and workshop management must be carried out by an experienced organization during the installation of the production equipment. Production tests can then be undertaken.**
- 7. As soon as the results of the production tests on the production process are available, commercial production can start. Quality control procedures must be set up as soon as commercial production is underway.**
- 8. Before or as soon as production starts, the entrepreneur or the manager must become suitably qualified in marketing, accounting and production monitoring.**
- 9. The manager or a qualified technician must check how the CEBs are used and give technical advice if anything goes wrong.**
- 10. During the first months, a producer would be wise to keep in touch with one or more competent associates from whom he can get technical or marketing advice.**

ENTERPRISE PROJECT

CEB production is not merely a technical activity. It is first and foremost an enterprise project. An enterprise can be defined as a human, material and financial investment. To set up an enterprise project is to mobilize all of these. This means that the entrepreneur must above all be able to convince the professional colleagues who are to provide financial and technical support. It is therefore very important to have a clear statement of the entrepreneur's project before embarking on the actual start-up of the project.

START-UP OF THE PROJECT

Once the preliminary phase is complete, the following phase, the start-up of the project, can begin. This consists in reviewing all the ways and means which will be used to achieve the production and marketing of the volume of blocks determined during the previous phase. This means drawing up first a technical dossier and then a financial dossier covering each aspect of the enterprise project.

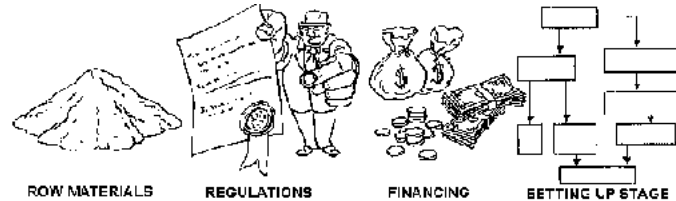

FIGURE

PARAMETERS

When setting-up a brickworks, a certain number of factors have to be taken into consideration at various stages of production. The table below presents in simplified form a list of the factors which should not be neglected.

Setting-up of the brickworks

- Land costs (distinguish between purchase and rent, and state duration).
- Infrastructure costs.
- Building costs.
- Miscellaneous expenses.

Preparation of the material

- **Extraction, loading and transportation of the earth (running costs of the quarry).**
- **Unloading and screening the earth.**
- **Loading, transporting and unloading the reject material after screening.**
- **Measuring out and mixing in the various elements making up the material (soil/sand/stabilizer/water).**

Block production

- **Loading the press and compressing the blocks.**
- **Transportation and storage of the blocks.**
- **Delivery of the blocks on site.**

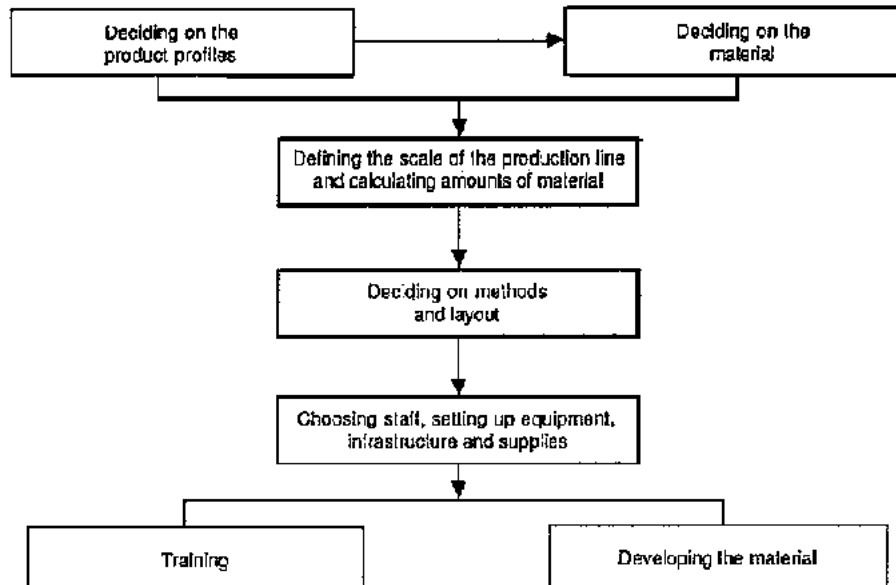

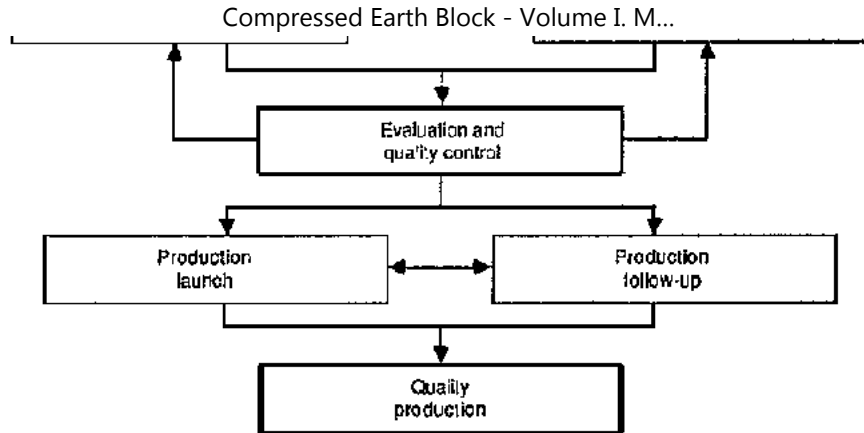

FIGURE

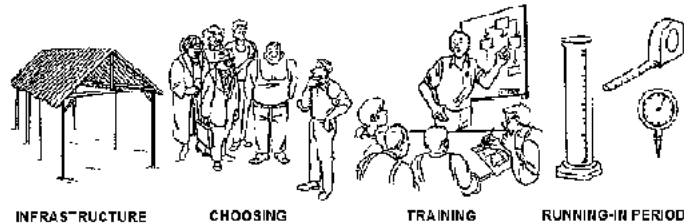

INFRASTRUCTURE

CHOOSING

TRAINING

RUNNING-IN PERIOD

FIGURE

The development of the material

ECONOMICS

Improved housing is part of any development strategy. One must therefore consider the effect of this on the local economy. These effects are reflected both in reduced imports and in the setting up of small businesses, resulting in the creation of jobs and in increased

skills.

In more global terms, one should also bear in mind the reduction in energy consumed, as well as the emergence of a contemporary role, following on in a continuous building tradition.

NORMS AND QUALITY STANDARDS

Very often technical documents which have been devised for other materials are applied to building with earth and this places CEBs at an unfair disadvantage. Reference texts suited to this particular building method are therefore of prime importance. The definition of norms aims at promoting quality standards and opening up the market to clients who will have greater confidence thanks to the credibility of the producers and the viability of the materials.

FLEXIBILITY

One of the characteristics of CEB production is the degree of flexibility in conditions for creating production units. The possibility of investing in stages, both in terms of equipment and technical capacity (training, skills) makes it very easy to adapt to a given context by modifying the approach selected in the light of market needs and constraints.

PARTNERSHIP

National development strategies often make it easier to find the capital for setting up small production units than for large building materials factories. For this reason, the efforts of small businesses are more and more supported by national or international institutions, notably by promoting partnerships with technical organisations or equipment manufacturers. Such partnerships can provide assistance not only with the production process, but also with preparatory studies, with marketing, and with the financial and

technical management of production units.

INFORMATION

Ensuring that the product, its performance and potential are well understood is of vital importance. There are several ways of approaching this: the products must be described, and their cost and uses or performance, endorsed by technical organisations, clearly stated. One should also be able to point out buildings which have been erected using CEBs and seek opportunities to use CEBs in such a way as to be able to demonstrate a real improvement in existing housing.

DIVERSIFICATION

There must be a readiness to consider new production methods as well as the production of new products, both compressed earth products and other building elements suited to the particular design requirements of CEBs. This means keeping in touch with users and partners in order to keep abreast of needs and techniques and to be able to offer useful services (suggestions for technical production and implementation, production and building costs, etc.).

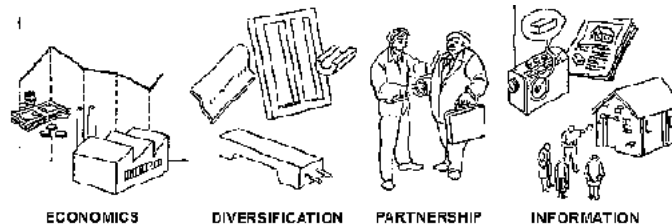

FIGURE

Earth - An architectural tradition

A VERY ANCIENT BUILDING TRADITION

The distant origins of the compressed earth block technique can be traced back thousands of years to the moulded sun-dried earth brick, better known by the name of "adobe". The sun-dried earth brick marks historical stages in the evolution of the human race. Linked to the emergence of an architectural tradition and urban settlements which laid the foundations for the urban revolution, with sun-dried earth bricks came social and economic organisation, the production of building materials and the use of these for building. This use, which was to radiate further and further afield, liberated man from rudimentary materials and techniques of limited architectural potential. The way was now open for a durable and monumental form of architecture, in Mesopotamia (present-day Iraq), in the Indus valley (India), along the banks of the Huanghe (China) and the Nile (Egypt), the main cradles of civilisation.

AN INEVITABLE HISTORICAL PROGRESSION

The recent progression towards the compressed earth block is a logical extension of the benefits of the industrial revolution which brought the significant development of the fired brick. With the need to improve the quality of materials and the durability of buildings, linked to better productivity, came compaction. CEB press technology is inherited directly from the ceramics or calcium silicate industries. The need to save energy and notably that used for firing in times of shortage (after the second world war, and later during the petrol crisis), accelerated the development of the compressed earth block and encouraged a broadening of its architectural application in regions faced by high energy costs.

THE CONTEMPORARY ROLE OF COMPRESSED EARTH BLOCKS

In Mayotte, an island in the Comoros, for example, a large programme for the construction of several thousand homes and public buildings (schools, offices etc.), launched over ten years ago has proved beyond doubt not only the contemporary role of the CEB, but also its

architectural merit. Demonstrating this contemporary role means putting it into practice, developing a market for business skills, spreading a genuine building and architectural culture, evidenced by skills, and ensuring the social and economic secondary benefits for the population, thus furthering the development of societies.





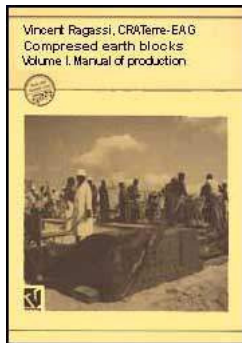





[Home](#) > [ar.cn.de.en.es.fr.id.it.ph.po.ru.sw](#)



Compressed Earth Block - Volume I. Manual of production (GTZ, 1995, 104 p.)

Soil

-  **Soil for building purposes**
-  **Properties**
-  **Typical soils**
-  **Behaviour of soils in the presence of water**
-  **Hydrous states of a soil**
-  **Prospecting**
-  **Identification: Laboratory tests**
-  **Identification: Field tests**

Compressed Earth Block - Volume I. Manual of production (GTZ, 1995, 104 p.)

Soil

Soil for building purposes

GENERAL OBSERVATIONS

At the surface of the solid part of the planet's crust (land), soil forms a layer of loose material, varying in thickness, which supports living creatures and their structures and plant life.

Soil is formed from bed-rock as a result of very long processes of weathering and the very complex manner in which particles migrate. These result in an infinite number of types of soil, with infinite variations in characteristics.

Topsoil or agricultural soil, which contains a high proportion of organic matter, forms a layer above the bed-rock, which may be more or less weathered. When the upper layers of earth are made up of loose material and contain little organic matter, they can be used for building.

COMPOSITION

Soils are made up of varying proportions of four types of material: gravels, sands, silts and clays. Each of these behaves in a characteristic way: thus, for example, when exposed to variations in humidity, some will change in volume, others will not.

The first two of these types of material are stable, the other two unstable. This notion of stability, i.e. the ability to withstand alternate humidity and dryness without its properties changing, is of fundamental importance in a building material.

a) Gravels are made up of pieces of rock of varying hardness, the size of which ranges between approximately 2 and 20 mm. They form a stable constituent of the soil. Their mechanical properties undergo no detectable change in the presence of water.

b) Sands are made up of mineral particles, the size of which ranges between approximately 0,06 and 2 mm. Also stable constituents of the soil, they lack cohesion when dry, but have a very high degree of internal friction, i.e. very great mechanical

resistance to movement between the particles which make them up. When moistened, however, they display apparent cohesion as a result of the surface tension of the water occupying the voids between the particles.

c) Silts are made up of particles the size of which range between approximately 0.002 (2 μ) and 0,06 mm; they have little cohesion when dry.

As their resistance to movement is generally lower than that of sands, they display cohesion when wet; when exposed to different levels of humidity they swell and shrink, changing perceptibly in volume.

Gravels, sands, and to a lesser extent silts, are therefore characterized by their stability in the presence of water. When dry, they have little to no cohesion and therefore they cannot be used on their own as the principle materials of a building.

d) Clays, which form the finest fraction of soils (less than 2 μ), have completely different characteristics than those of the other particle types. They consist mainly of microscopic clay mineral particles, including - amongst others - kaolinites, illites and montmorillonites. Clay particles are coated in a film of absorbed water and because they are so minute they are very light in weight compared with the surface tension forces occurring in the film of absorbed water. Thus volume forces are low relative to surface forces.

The film of absorbed water which adheres strongly to the clay-layers, links the micro-particles of the soil together, and it is this which gives clay its cohesion and most of its mechanical strength. This can be eliminated only by very advanced dessication. Clay lends soil its cohesion, acting as a kind of natural binding agent between the coarser particles which form its skeleton.

Unlike sands and gravels, however, clays are unstable and are very sensitive to variations in humidity. They are greatly attracted to water and as their moisture content rises, the

films of absorbed water become thicker and the total apparent volume of the clay increases. Conversely, during the shrinkage which occurs as they dry out, cracks can appear in the clay mass, reducing its strength. When next exposed to moisture, these cracks form channels through which water can penetrate to the heart of the material. It is this "swelling-shrinkage" characteristic, i.e. variations in volume of clayey soils according to their moisture content, which has to be contended with!

What has been said so far applies to moisture contents below the "liquid limit" and at which clay has cohesion. With high moisture contents, clays "liquify" and lose all cohesion.

EXPLOITATION

Usable layers or deposits of soil are rarely found at the surface of the ground (except in arid areas), because here soils contain too much organic matter. The depth of this organic topsoil rarely exceeds 1 to 2 metres. On the other hand usable soil is rarely found at great depths, where there are too many stones, or even solid rock. The depth or height of usable layers of soil varies greatly, from a few centimetres to several metres.

Properties

GENERAL OBSERVATIONS

Soil properties change from one soil to another depending on the nature of the particle fractions making them up and the complex way in which these mix together. It is often the dominant particle fraction of a soil which characterizes its fundamental properties and dictates its behaviour.

One can distinguish on the one hand between chemical properties, which are linked to the presence of salts, oxides and sulphates, and on the other between physical properties,

which are numerous, and which include colour, structural stability, adhesion, apparent dry density, moisture content, porosity or the proportion of voids, absorption capacity, capillary potential and range, permeability, linear shrinkage, dry strength and many more. Understanding its chemical and physical properties enables one to define the quality and performance of a soil for building purposes.

At the same time, it is not always necessary to have an exhaustive knowledge of the chemical and physical properties of a soil. What is important, however, is to have a thorough grasp of three fundamental properties, which are:

- the texture or particle size distribution of the soil, i.e. the quantity of stones, gravels, sands, silts and clays present, expressed in percentage terms;**
- the plasticity of the soil or the ease with which it can be shaped;**
- the compressibility of the soil, or the extent to which voids, and therefore its porosity, can be reduced to a minimum.**

TEXTURE OR PARTICLE SIZE DISTRIBUTION

This is measured by particle size analysis for the coarse fraction (gravels, sand, silts) and by sedimentation analysis for the fine fraction (clays).

Gravels and sands give the material its strength, whilst clays bind it together; silts fulfil a less clear intermediate function.

When we define an optimum curve, we are attempting to make best use of the qualities of the various types of materials making up the soil.

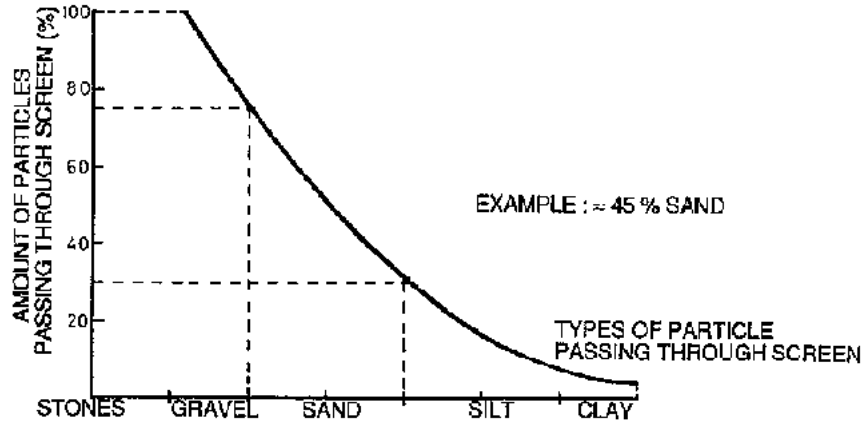

FIGURE

PLASTICITY

Plasticity defines the extent to which a soil can be distorted without any significant elastic reaction, typically cracking or crumbling, occurring.

The plasticity of a soil, as well as the limits between different states of consistency, are defined by measuring the "Atterberg limits".

These are carried out on the fine fraction of the soil (particle size diameter superior to 0.4 mm). The amount of water, expressed in percentage terms, corresponding to the point at which the material passes from a plastic to a liquid state is known as the Liquid limit (LL). The point at which it passes from a plastic to a solid state, is known as the Plastic limit (PL). At LL, the soil begins to display some resistance to shearing. At PL, the soil ceases to be plastic and becomes crumbly. The plasticity Index (PI), which is equal to $LL - PL$, determines the extent of the plastic behaviour of the soil. Combining LL and PL defines the

sensitivity of the soil to variations in humidity. The plastic properties of a soil can be shown on a plasticity diagramme.

The following are examples for certain soils:

- sandy: PI from 1 to 10; LL from 0 to 30
- silty: PI from 5 to 25; LL from 20 to 50
- clayey: PI > 20; LL > 40

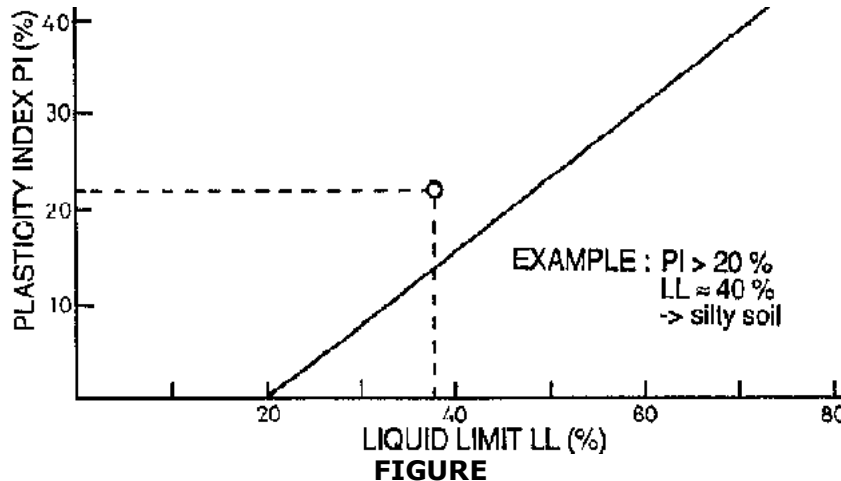

COMPRESSIBILITY

The compressibility of a soil defines its maximum capacity to be compressed for a given amount of compaction energy and at a given moisture content (the optimum moisture content or OMC). When a force is applied to a quantity of soil, the material is compressed

and the proportion of voids decreases. The more the density of a soil can be increased, the lower its porosity will be and the more difficult it will be for water to penetrate. This property results from the tighter overlapping of the particles which lowers the risk of the structure being modified in the presence of water.

The moisture content must be high enough to lubricate the particles and enable them to move around in such a way as to occupy as little space as possible. At the same time the moisture content must not be too high, or the voids would be full of water, and therefore impossible to compress.

The compressibility of a soil is measured by the "Proctor test". It can be shown on a compressibility diagramme, showing the relationship between the optimum moisture content and the optimum dry density, for a given amount of compaction energy.

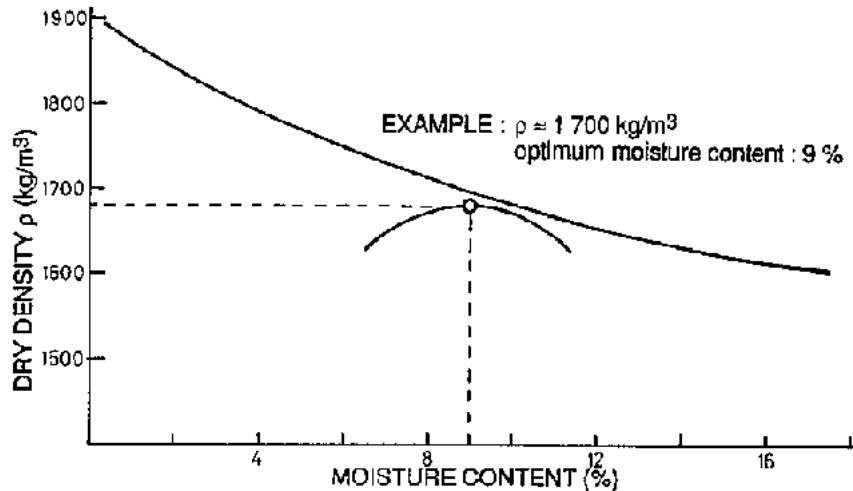

FIGURE**Typical soils****SOIL MECHANICS**

As we have already seen, soil is made up of inert materials (gravels, sands, silts) and active materials (clays). The former act like a skeleton and the latter like a binding agent, much the same as a cement does. The structure of a soil is thus comparable to that of concrete with a different binding agent. The proportion in which each type of material is present will determine the behaviour and properties of different soils.

The following curve gives an approximate indication of the types of soil which are recommended for the manufacture of compressed earth blocks. As can be seen, the proportions of each type of material can vary considerably depending on the qualities of each, which differ quite widely, particularly for clays. Knowing the proportions of each, as shown on a particle size distribution curve, is an important indicator but is rarely enough for soil selection purposes.

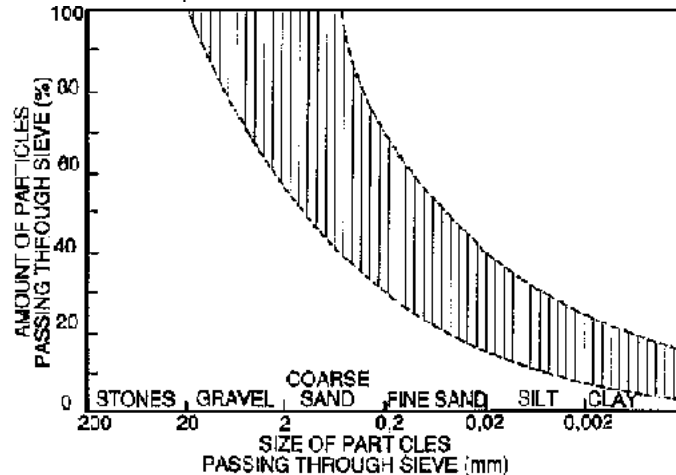
**FIGURE****PROPORTIONS OF VARIOUS KINDS OF MATERIAL****Gravels: 0-40%****Sands: 25-80%****Silts: 10-25%****Clays: 8-30%**

It is generally accepted that many soils which fall outside the recommended areas can still give acceptable results in practice. On the other hand, soils which do conform will in most cases give good results. The shaded areas are guidelines for the user and not specifications to be rigidly applied.

TYPICAL SOILS

Texture influences the properties of a soil since each fraction of particles has its own particular characteristics and these can define that of the soil if it is present in sufficient quantities. A proportion of 8% clay is enough to lend cohesion and plasticity to the soil. 40 to 50% clay fines gives a soil with the properties of a clay.

Proportions can vary greatly, resulting in a virtually infinite number of types of soil. One can distinguish, however, between four main types of soil texture.

Each of these types is described by reference to the interpretations of field tests.

Gravelly soil

Description: very rough texture, not sticky, little cohesion (the "cigar" formed by hand with such soil breaks at a short length and "biscuits" of soil crumble easy), little or no shrinkage.

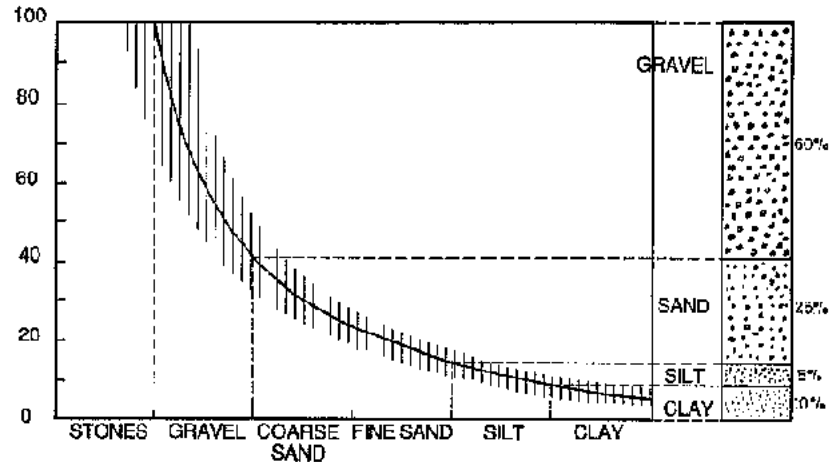

FIGURE**Sandy soil**

Description: gritty texture, not sticky, little cohesion (the "cigar" breaks at a short length and "biscuits" of soil crumble easily), little or no shrinkage.

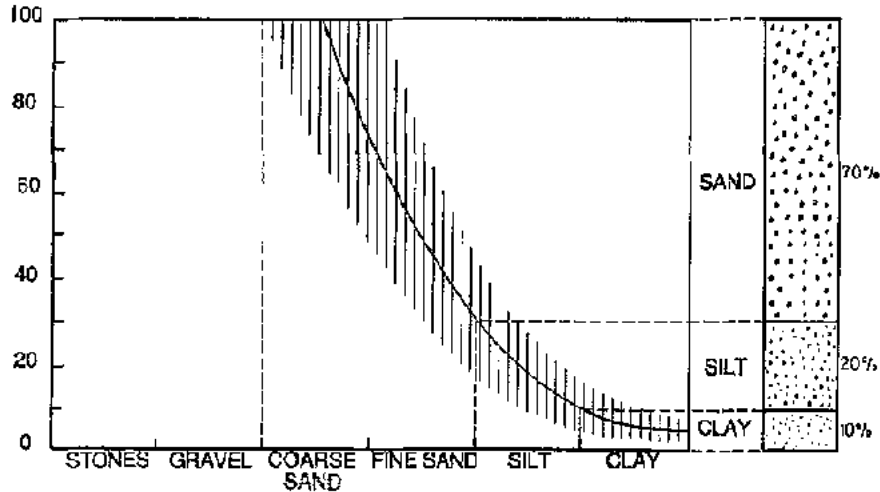
**FIGURE****Silty soil**

Description: smooth texture, sticky, cohesive (the "cigar" breaks at a long length and "biscuits" of soil are difficult to break up), fairly significant shrinkage.

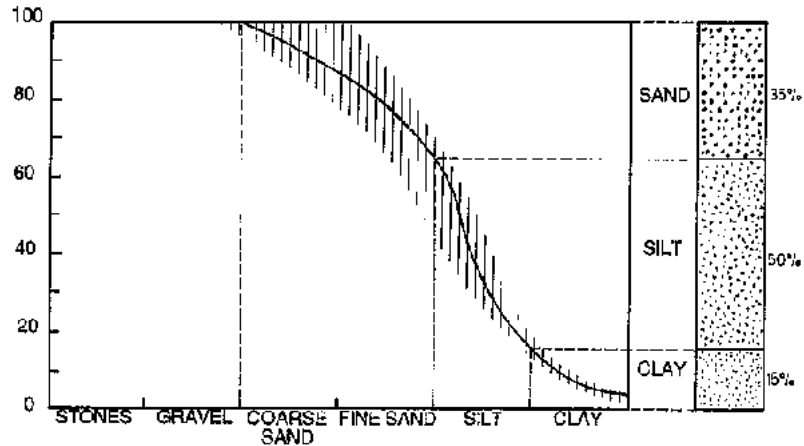
**FIGURE**

Clayey soil

Description: very smooth texture, very sticky, highly cohesive (the "cigar" breaks at a very long length and "biscuits" of soil are very difficult to break up), significant shrinkage.

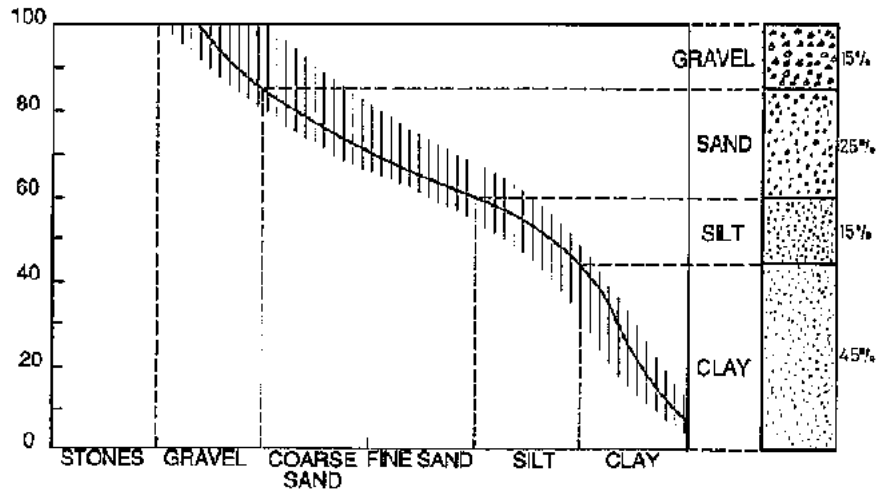

FIGURE

Behaviour of soils in the presence of water

Moistening a soil accentuates its reactions and properties. Water has the effect of introducing mechanical forces due to phenomena of capillarity. The finer the particle size, the greater these tensile forces will be and the more absorption will occur.

In the case of clays (active materials), electrostatic forces also intervene and these lend the material great cohesion and plasticity, plasticity being the capacity to change shape without breaking.

Wetting a soil enables one to determine its absorption capacity, as well as its cohesion and its plasticity. Thus typical soils will each behave in a particular way.

Observing samples which have been molded and allowed to dry can also be useful. Samples made from gravelly, sandy and silty soils will have lost all cohesion, whereas those made from a clayey soil will have retained great cohesion, but they may also have cracked during shrinkage.

Hydrous states of a soil

A soil will react very differently depending on the amount of water it has absorbed. One can differentiate between four broad hydrous states: dry, moist, plastic and liquid. Each hydrous state has a corresponding application. These will be dependent on a number of factors linked not only to the nature of the soil and the building system used, but also to the broader context (whether the region is arid or not, traditions, skills, etc.)

Prospecting

PRELIMINARY INVESTIGATION

Existing data should preferably be gathered before starting work on site. These might include maps or descriptions emanating from geological, pedological, topographical, or agronomical surveys or from roadworks.

It is often very useful to question the people living in the area: they may be able to supply conclusive information, particularly if earth is being used for building in the locality, suggesting that there are usable deposits.

Earth for building very often lies below a layer of organic soil; it is therefore important not to embark upon uncontrolled sampling and to remember that organic soil, which is unusable for building, is often the sole means of subsistence of the farmers in the area.

TAKING SAMPLES

Samples can be taken from bore holes or open trenches, but most commonly from a combination of the two, complementing each other. One might also be able to locate existing road cuttings, escarpments, etc. Samples should be taken from homogenous layers; depending on the scale of the project, these can be chosen "by eye" or by using a statistical sampling system.

The sample size and weight will depend on the number of tests to be carried out. in principle 1 to 2 kg is enough for field testing. To test for compressibility (using the Proctor test), 6 to 10 kg will be needed, and to make a standard block (measuring 29.5 × 14 × 9 cm) approximately 10 kg will be needed.

The sample taken must be representative. Different soils should not be mixed together and rather than trying to create an "average" soil, a greater number of samples should be taken. Samples should be labelled and given an identification card listing any data which might help to pinpoint the soil (where the sample was taken and by whom, the use to which it is put, etc.).

PROSPECTING EQUIPMENT

Digging equipment can be manual (spades, pick-axes, trowels, drills, etc.) or mechanized (boring machines).

Some drilling tools enable one only to dig out the soil, but others simultaneously extract cylindrical core samples. Sometimes a small pick (as used for geological purposes) or a penknife can suffice for surface sampling.

Warning: containers must be sturdy enough not to split. Canvas or plastic can be used to preserve the original moisture level of the sample. In all cases, an easily accessible and robust label must be used to enable samples to be identified.

Identification: Laboratory tests**GRAIN SIZE DISTRIBUTION**

This test consists in filtering the soil through a series of standard mesh sieves placed one above the other in decreasing order (i.e. the finest mesh at the bottom) and in determining the proportion of matter left in each sieve.

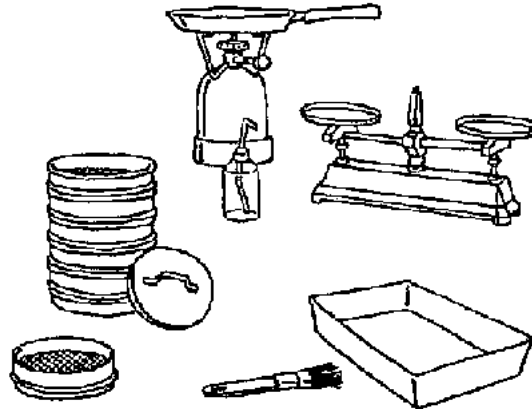

Equipment for grain size distribution

FIGURE**SEDIMENTATION ANALYSIS**

The grain size distribution analysis obtained by passing the sample through sieves is incomplete. It may suffice for most roadworks applications, but is insufficient for the purposes of building with earth, which requires analysis of the texture of fines of a diameter inferior to 0.08 mm. This requires sedimentation analysis which exploits the

different speeds at which particles of soil suspended in water will settle. The coarsest will settle first and the finest last. Variations in density are measured at regular intervals and at a given height (density diminishes as the liquid clears). The speed at which the particles settle depending on their size enables one to calculate the proportions of the various sizes of particles.

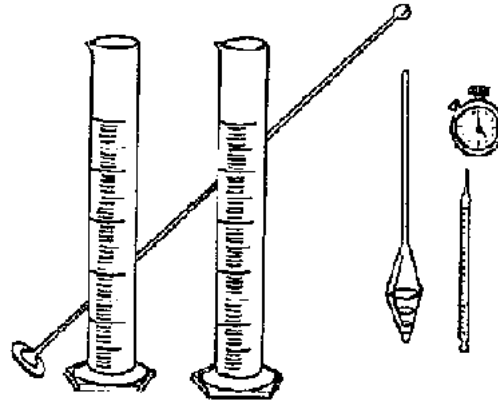

Equipment for sedimentation analysis

FIGURE

ATTERBERG LIMITS

A soil can have various states of consistency: liquid, plastic or solid. A Swedish researcher named Atterberg defined these various hydrous states and the boundaries separating them as limits and indices, expressed as percentages by weight of the moisture content. Five limits can be measured:

- the liquid limit,

- the plastic limit,
- the shrinkage limit,
- the absorption limit,
- the adhesion limit.

The first two of these are the most important; the other three, although of interest, are rarely used. Atterberg limits are determined using the "fine mortar" fraction of the soil, i.e. that which passes through a 0.4 mm mesh sieve, as this portion, which constitutes the "mortar" for the coarser particle, is the portion that might be affected by water, modifying its consistency.

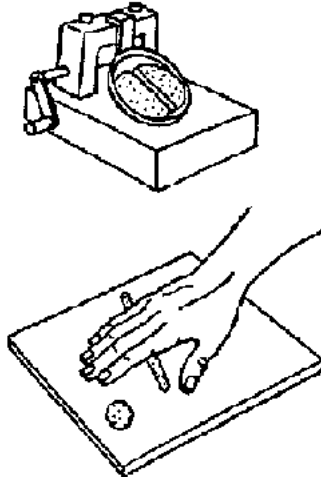

Equipment for Atterberg limits

FIGURE

PROCTOR TEST

For efficient soil compaction, the compaction process must be carried out on a material the moisture content of which lubricates the particles, thus enabling them to move around in such a way as to take up as little space as possible.

If the moisture content is too high the soil may swell and the pressure of the compacting machine will be dissipated by the water trapped between particles. If, on the other hand, the moisture content is too low, the particles will be insufficiently lubricated and it will not be possible to compact the soil to its minimum volume.

The Optimum Moisture Content (OMC) at which maximum dry density is obtained is determined by the Proctor test (after the American entrepreneur who perfected it). The results are recorded on a diagramme showing the dry density (ρ_d), expressed in kg/m^3 , on the axis, and the moisture content (MC), expressed in percentage by weight, on the abscissa. The three principal variables which affect the maximum dry density obtainable are the texture of the material, its hydrous state and the compaction energy used.

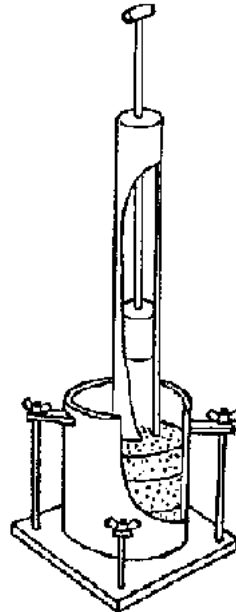

Equipment for Proctor test

FIGURE

CHEMICAL ANALYSIS

The presence of organic matter and soluble salts is harmful. Chemical analysis can be:

- quantitative, i.e. detecting the presence of substances and quantifying them (by filtration or using a spectrometer). This type of analysis requires sophisticated equipment, which makes it very expensive;**

- **qualitative, i.e. detecting only the presence of substances without attempting to quantify them. The presence of organic matter, sulphates and chlorides is often checked using this far simpler and cheaper form of analysis.**

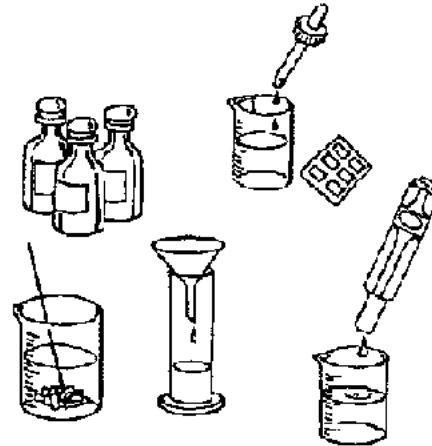

Equipment for chemical analysis

FIGURE

Identification: Field tests

TOUCH/SMELL/WASHING

Procedure

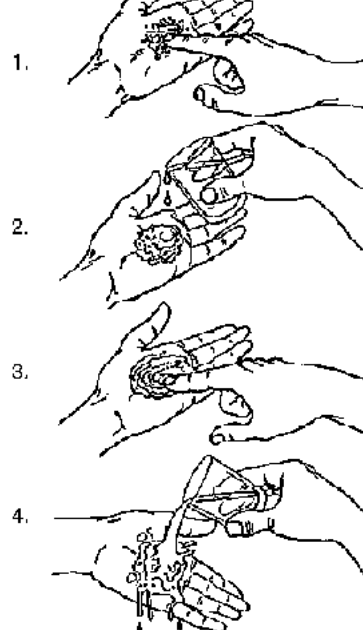

TOUCH/SMELL/WASHING

Method

- 1. Take a small quantity of dry soil and rub it in the palm of the hand feeling its texture.**
- 2. Moisten the soil; if it begins to give off a musty smell, it contains organic material.**
- 3. Gently rub the moistened soil, again feeling its texture.**
- 4. Gently wash the soil off the palm of the hand, noting how sticky it is.**

Interpretation Texture:

A soil which feels coarse when dry will feel smooth when moistened if it contains lumps of clay. Sand on the other hand will feel gritty, as will to a lesser extent silt.

Washing:

- if the soil is not sticky and washes off easily, it has a high gravel and/or sand content;
- if the soil is sticky and difficult to wash off, it has a high silt content;
- if the soil is very sticky and very difficult to wash off (leaving traces of colour), it has a high clay content.

Procedure

- 1.
- 2.

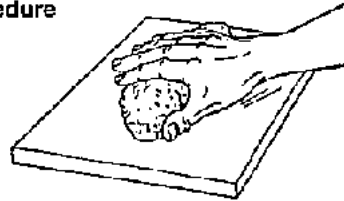

- 4.



- 5.
- 6.

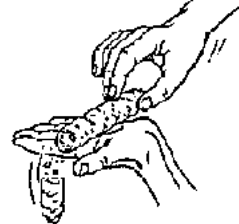

CIGAR TEST

Method

- 1. Remove all gravel from the sample.**
- 2. Moisten and knead it well until a smooth paste is obtained.**
- 3. Leave to stand for 30 minutes, or more if possible, to allow it to become very smooth.**

4. Roll between the hands into a cigar shape 3 cm in diameter.

5. Place the «cigar» across the palm of the hand and push it gently forward with the other hand.

6. Measure the length of the piece which breaks off.

7. Repeat several times.

This test enables one to observe the cohesion of the soil and thus above all the quantity and quality of the clays present.

Interpretation

Average the lengths measured:

- less than 5 cm: the soil contains too much sand,
- more than 15 cm: the soil contains too much clay,
- between 5 and 15 cm: the soil is good.

2.

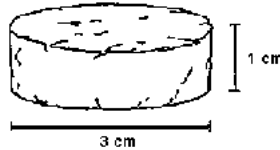

4.

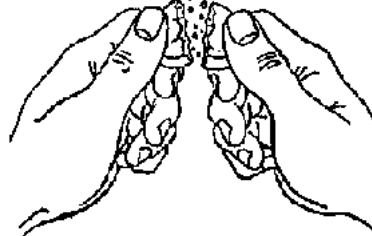

BISCUIT TEST

Method

- 1. Proceed as with the cigar test, by removing all gravel and kneading the sample well until a smooth paste is obtained.**
- 2. Mould it into flat biscuit-shaped discs approximately 3 cm in diameter and 1 cm thick.**
- 3. Leave to dry and observe any signs of shrinkage (away from the sides of the mould and/or any cracking).**
- 4. Break the "biscuit" noting how hard it is.**

Interpretation

Shrinkage:

If the biscuit is cracked or if there is a clear gap between the dried sample and the sides of the mould, the soil contains too much clay.

Breaking:

- **very hard to break; breaks with an audible crack: the soil has a high clay content;**
- **brittle, but breaks fairly easily and can be crumbled between the thumb and forefinger: a good, sandy-clayey soil;**
- **breaks readily and is easily reduced to powder: the soil has a high sand or silt content.**

Procedure

1.



2.

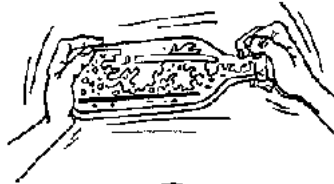

3.



SEDIMENTATION ON JAR TEST

Method

- 1. Take a transparent cylindrical jar or bottle of at least 1/2 litre capacity and fill it with approximately 1/4 soil and 3/4 water.**
- 2. Seal the top using your hand and shake well.**

3. Leave to stand for at least 30 minutes and observe the sedimentation layers.

Interpretation

Coarse material (gravels) will be deposited on the bottom, followed by sands, then silts, with clays at the top.

The depth of each layer gives an indication of the proportions of each type of material. These proportions are only approximate: the layer of gravel, which contains many voids, will seem relatively "deep" compared to that of clay, which will have very few voids. Nevertheless, the test shows if the soil has a reasonable distribution of all types of material or if on the contrary it contains too much of one type.





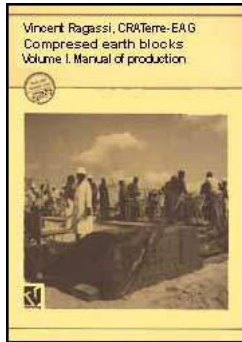

[Home](#) > [ar](#) [cn](#) [de](#) [en](#) [es](#) [fr](#) [id](#) [it](#) [ph](#) [po](#) [ru](#) [sw](#)



Compressed Earth Block - Volume I. Manual of production (GTZ, 1995, 104 p.)

Stabilization

-  **General considerations**
-  **Different ways of stabilizing and stabilizers**
-  **Cement stabilization**
-  **Lime stabilization**
-  **Calculating how much stabilizer to use**

Compressed Earth Block - Volume I. Manual of production (GTZ, 1995, 104 p.)

Stabilization

General considerations

DEFINITION

Stabilizing a soil is to lend it properties which are irreversible in the face of physical constraints. A great many parameters intervene, depending as much on the design of the building, on the quality of the materials used, on economic aspects of the project, or on issues of durability. For stabilization to be successful, the process used must be compatible with these various imperatives.

NATURE OF THE PROBLEM

When building with earth, one is confronted with two basic options.

- The type of soil available on site dictates the building system.**
- The building system, having been predetermined, dictates the use of a particular type of soil.**

In the first instance, architecture, in other words the design, takes account of the site context and determines the building systems which will ensure the durability of the buildings; architectural choices act as a "stabilizer". This is the first approach to be preferred and used.

In the second instance, it is the manufacturing technique, often alien to the site, which ensures the durability of the materials used, more or less independently of the building systems; the process and the addition of material(s) act as a «stabilizer».

In this chapter, we deal with the second instance, i.e. the improvement of the soil by

adding stabilizers (materials). Every kind of soil, however, has a corresponding suitable stabilizer.

There are more than a hundred products in use today for stabilization. These stabilizers can be used both in the body of the walls and in their outer "skin": in renders, for example. Stabilization has been practiced for a very long time, but despite this, it is still not an exact science and to date no "miracle" stabilizer is known among the multitude of products available, some of which should not even be considered, either because of their inefficiency, or because they are prohibitively expensive.

OBJECTIVES

Only two characteristics of the soil itself can be treated: its structure and its texture.

There are three ways of treating the structure and the texture of a soil:

- reducing the volume of voids between the particles, i.e. affecting its porosity;**
- blocking up the voids which can't be eliminated, i.e. affecting its permeability;**
- improving the links binding the particles together, i.e. affecting its mechanical strength.**

The main objectives being pursued are:

- obtaining better mechanical performances: increasing dry and wet compressive strength;**
- reducing porosity and variations in volume: swelling and shrinking with moisture content variations;**
- improving the ability to withstand weathering by wind and rain: reducing surface**

abrasion and increasing waterproofing.**PROCESSES**

There are three stabilization processes:

- **Mechanical stabilization: the properties of the soil are modified by treating its structure: compaction of the soil modifies its density, its mechanical strength and its compressibility, its permeability and its porosity.**
- **Physical stabilization: the properties of a soil can be modified by treating its texture: a controlled mix of the various particle fractions.**
- **Chemical stabilization: Other materials or chemical products are added to the soil and modify its properties.**

WHEN TO STABILIZE?

There is a tendency at present to stabilize systematically, but stabilization is not obligatory. One can manage very well without and build with earth well without stabilizing. Builders' achievements are there to prove it. Stabilization can entail a significant additional cost: between 30 and 50% of the cost price of the material.

- **Do not stabilize material which is not going to be exposed to water: protected walls, rendered walls, internal walls, good design following the logic of earth as a building material.**
- **Do stabilize when the material is going to be exposed: bad design, failing to take account of the fundamental principles of building with earth, or location constraints: a damp site, or walls exposed to driving rain, for example.**

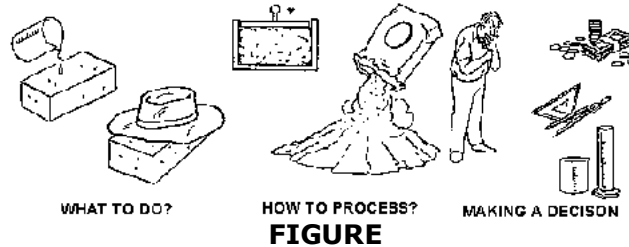

Different ways of stabilizing and stabilizers

INCREASING DENSITY

There are two ways of increasing density:

- Either subjecting the soil to mechanical manipulation in order to force out as much air as possible, by kneading or compressing the soil. The texture of the soil does not change, but its structure does as the particles are redistributed. The soil is not just compressed in its original state: it is first broken up to make it more uniform, and then compressed.

- Or filling as many voids as possible with other particles. For this second approach, the texture must be perfect: the void left between each group of particles is filled by another group of particles. Here the texture is being directly treated.

REINFORCING

In this instance a soil is reinforced by the addition, generally speaking, of fibres of organic origin (straw), animal origin (hair, wool), mineral or synthetic origin (synthetic fibres). This approach creates a network of omni-directional fibres which improves notably tensile

and shearing strengths and also helps to reduce shrinkage.

CEMENTATION

A strong, inert, three-dimensional matrix is introduced into the soil. This causes consolidation by cementation (i.e. the formation of a "skeleton") which coats the particles and resists movement within the material. Portland cement is the principal example of this kind of stabilizer, or certain glues or resins. The main consolidation reactions occur within the stabilizer itself and between the stabilizer and the sandy fraction of the soil. Secondary reactions, however, can be observed between the stabilizer and the clay fraction. Clay affects the efficiency of the stabilizer and can modify the mechanical behaviour of the material.

BONDING

In this instance, the inert matrix introduced into the soil includes clays. Two mechanisms giving the same results are known:

- An inert matrix is formed by the clays: the negative and positive charges of the plate-like clay particles, or their chemical composition, are used to bind them together through the intermediary of a stabilizer, which acts as a binding agent or a catalyst in this binding effect. Certain chemical stabilizers work in this way, including certain acids, polymers, flocculants, etc.**
- An inert matrix is formed with the clays. A stabilizer reacts with the clay and precipitates a new, insoluble, inert material: a kind of cement. This is a pozzolanic reaction, notably as obtained with lime.**

This slow reaction depends essentially on the quantity and quality of the clay present.

WATER-PROOFING

This way of stabilizing helps to reduce water erosion and the swelling and shrinkage occurring as a result of repeated alternate wet-dry cycles. There are two known ways of water-proofing:

- All voids, pores, cracks and crazing are filled with a material which is not water-sensitive. Bitumen is an example of one of the products which works best in this way. This method of stabilization is particularly well-suited to sandy soils which display good volume stability and which are little affected by water. It can also be used for silty and clayey soils which demand more stabilizer because their specific surface area is greater.**
- A material which expands and seals off access to pores as soon as it comes into the slightest contact with water is dispersed throughout the soil. One example of such a material is bentonite.**

WATER DISPERSAL

In this instance, the state of the interstitial water is modified and the sensitivity of the plate-like clay particles to water is reduced. This process uses chemical products (calcium chloride, acids' quaternary amines or resins) or ion exchange helps to eliminate as much absorption and adsorption of water as possible.

STABILIZERS

Sands and gravels: these are added when the soil is not usable in its natural state, often because it contains too much clay. By correcting its texture, they increase its density.

Fibres: adding these to reinforce the soil is very common in traditional adobes but







incompatible with the CEB compression process as they render the mix too elastic.

Bitumen: this has a water-proofing effect but needs to be mixed in evenly, which demands a process using a great deal of water, similar to adobes.

Resins and chemical products: these often combine several methods of stabilizing. Their efficiency in most cases depends on very specific soils and procedures and their use should be carefully considered beforehand. Their availability is often erratic and their cost generally high and variable and these factors should be taken into account.

Cement and lime: cement has a cementation effect whereas lime has a bonding effect. These two stabilizers will be considered in more detail below.

Compressed Earth Block - Volume I. M...
WAYS OF STABILIZING TREATED SOILS

MEANS	PRINCIPLE	SYMBOL
INCREASING DENSITY	CREATING A DENSE ENVIRONMENT WHICH BLOCKS PORES AND CAPILLARY CHANNELS	
REINFORCING	CREATING AN OMNI-DIRECTIONAL REINFORCEMENT WHICH REDUCES MOVEMENT	
CEMENTATION	CREATING AN INERT MATRIX WHICH RESISTS ALL MOVEMENT	
BONDING	FORMING STABLE CHEMICAL LINKS BETWEEN THE CLAY CRYSTALS	
WATER-PROOFING	COATING THE SOIL PARTICLES IN AN IMPERMEABLE LAYER AND BLOCKING PORES AND CHANNELS	
WATER-DISPERSAL	MAXIMUM ELIMINATION OF WATER ABSORPTION AND ADSORPTION	

FIGURE

Cement stabilization

GENERAL OBSERVATIONS

Cement is probably one of the best stabilizers for CEBs. Adding cement before compaction improves the characteristics of the material, and particularly its resistance to water, thanks to the irreversible nature of the links it creates between the largest particles. Cement mainly affects sands and gravels, as in concrete or in a sand-cement mortar. This means that it is not necessary, and indeed it may be harmful, to use soils which have too high a clay content (> 20%). Its use does not require too much water which corresponds to the humid compression state of CEBs.

EFFICIENCY AND HOW MUCH TO USE

In general, at least 5 to 6% cement will be needed to obtain satisfactory results. Compressive strength is highly dependent on the amount used. With low proportions (2-3%) certain soils perform less well than when left unstabilized.

Given similar local conditions, there may be no guarantee that a CEB will use less cement than a cement block.

EFFICIENCY PARAMETERS

Soil

Best results are obtained with sandy soils.

Lateritic soils

The presence of iron oxides allows stabilization to occur efficiently with little cement, as a result of pozzolanic reactions or hardening effects.

Organic matter

The presence of organic matter is risky.

Water

Water containing salts must in all cases be avoided.

Sulphates

These are very harmful, especially calcium sulphate (anhydride and gypsum).

EFFECTS

On the stabilized material

Using a high proportion of cement, quite apart from economic considerations, cannot improve a poor soil. The plasticity index should be fairly weak (max pl: 15 to 20%), illustrating the efficiency of cement with relatively sandy soils.

Variations in size: cement-stabilization reduces the extent of shrinkage and swelling.

HOW TO PROCEED FOR CEMENT STABILIZATION

Note: Ways and means of processing are dealt with in detail in the chapter on PRODUCTION.

Preparation

An even mix is crucial. Lumps or sods of clay are therefore to be avoided. Care must be taken during screening with no prior preparation as apart from stones and gravel, there is a risk of also removing lumps of clay and thereby modifying the properties of the soil. To prevent lumps reforming after disintegration, the soil should be kept dry.

Mixing

Even with a well-prepared soil, the cement must be mixed in as thoroughly as possible, otherwise, as it is generally used in low proportions (4 to 8%), it will not be evenly distributed. Mixing should be done in two stages: dry and wet mixing. The cement will begin to act on contact with water, which is why water should be added to the dry mix at the last moment before compaction in order to keep the time before it is used (retention time) to a minimum, as this greatly affects the quality of the blocks (see below). The moisture content of the mix will be slightly drier than the OMC for sandy soils and slightly wetter for soils containing too much clay.

Curing

Cement stabilized blocks must be kept in a humid environment for at least 7 days. The surface of the blocks must not be allowed to dry out too quickly, as this causes shrinkage cracks. The blocks must be sheltered from direct sun and wind and kept in conditions of relative humidity (RH) approaching 100% by covering them with waterproof plastic sheets. After 28 days there will be no further significant increase in the strength of the cement. High temperatures will increase the strength obtained and temperature can be raised using black plastic sheeting.

Examples: compared with 14 days' curing at 100% relative humidity, blocks cured for 7 days at 100% RH and 7 days at 95% RH blocks will achieve 25% less strength. Blocks cured for 7 days at 40°C will be 1.5 to 2 times stronger than blocks cured for 7 days at 20°C

Drying

After curing, water must be allowed to evaporate and the clay fraction to shrink. To prevent shrinkage occurring too quickly, exposure to wind and direct sun must be

reduced. Drying out will take approximately 14 days.

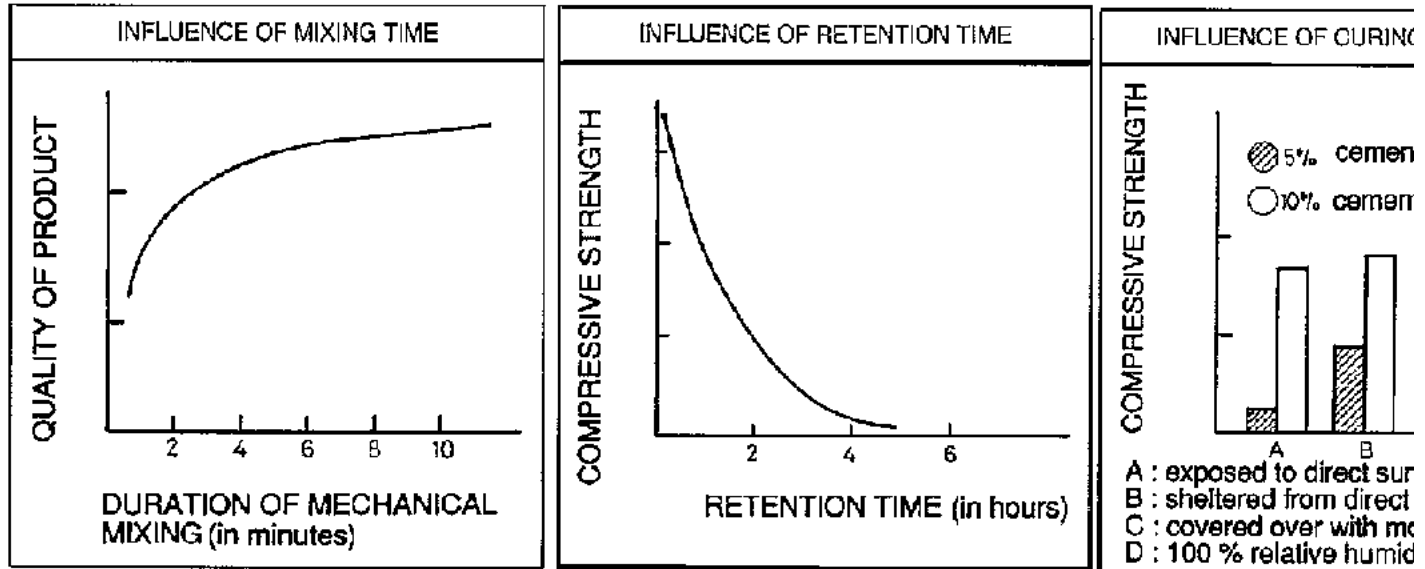

FIGURE

Lime stabilization

GENERAL OBSERVATIONS

Stabilizing soil with non-hydraulic lime (quicklime or slaked lime) is commonly used for roadworks, although mainly for temporary roads. Lime stabilization has the advantage of reacting in a very positive way with clayey soils with a relatively high moisture content, which is often the case for site access roads, for example. Lime will above all form links

with the clays present, and hardly at all with the sands. The use of this stabilizer is therefore on the whole not recommended for the manufacture of CEBs, which requires fairly low moisture contents and soils with a relatively high sand content. It should be considered only if cement stabilization is impossible. Results with lime are better than with bitumen or than with resins etc. Hydraulic limes, which more closely resemble cement, are not considered here.

EFFICIENCY AND HOW MUCH TO USE

Adding 2 to 3% lime immediately provokes a lowering of the plasticity of the soil and fragments lumps. For ordinary stabilization purposes, the amounts generally used range from 6 to 12%, i.e. equivalent to the amounts of cement used, but it should be noted that in the case of lime, there is an optimum quantity to be used for each type of soil.

EFFICIENCY PARAMETERS

Soil

Best results are obtained with clayey soils (20 to 40% and even 70%).

Organic matter

This slightly reduces the stabilizing effects, but lime can be capable of neutralizing some of the organic matter present.

Sulphates

These are harmful and to be avoided.

EFFECTS

Plasticity

The soil becomes less plastic, but given its use in association with clayey soils with plasticity indices of 18 to 30%, the soil-lime mix remains sufficiently plastic.

Compressibility

Dry density falls and the OMC rises, which means that the Proctor curve flattens out and moves to the right, indicating reduced sensitivity to water.

Compressive strength

This will be highly dependent on the amounts used and will tend to increase over time.

Variations in size

Because lime creates links with clays, it reduces swelling and shrinkage.

HOW TO PROCEED FOR LIME STABILIZATION**Preparation**

This is an important stage and must be carefully carried out. The more finely the clay has been broken down, the more actively the lime will be able to attack it. This can prove to be a difficult operation, as clay displays great cohesion.

Too wet a soil can be dried and fragmented using quicklime. Stabilization will work efficiently if at least 50% of the clay lumps are ground down to a diameter below 5 mm.

Mixing

This must be very carefully done to ensure that the soil and the lime are thoroughly mixed. With very plastic soils, a two-stage process can be used, at one or two days' interval, enabling the lime to break down lumps of soil; at the same time, this two-stage approach can reduce the effect of the lime on strength.

Retention time

If one proceeds with the material wet, the mix can be left to react after mixing. At least two hours must be allowed, and preferably 8 to 16 hours. Higher strengths will be obtained. If one proceeds with the material in a plastic state, the lime-soil mix (whether quicklime or slaked lime) should be left to react for several weeks. This is particularly the case for renders which become progressively smoother and more sticky.

Compression

Dry density is very sensitive to the way compaction is carried out, particularly when high amounts of lime are used. The exothermic reaction provoked by the quicklime consumes nearly 1% of the moisture content per % of added quicklime. The moisture content will therefore need to be corrected to make it close to the OMC.

Curing and drying

An increase in compressive strength can be observed as the curing time is prolonged. This phenomenon extends for several weeks and persists for many months. Complete curing takes six months, but the blocks are usable after 56 days (theoretically).

Curing conditions for lime are identical to those for cement, i.e. a hot, humid environment. Wet curing prevents the evaporation of untrapped water from within the blocks which is vital for the lime-clay reactions to occur.

Curing in the sun under plastic sheeting raises temperatures and relative humidity.

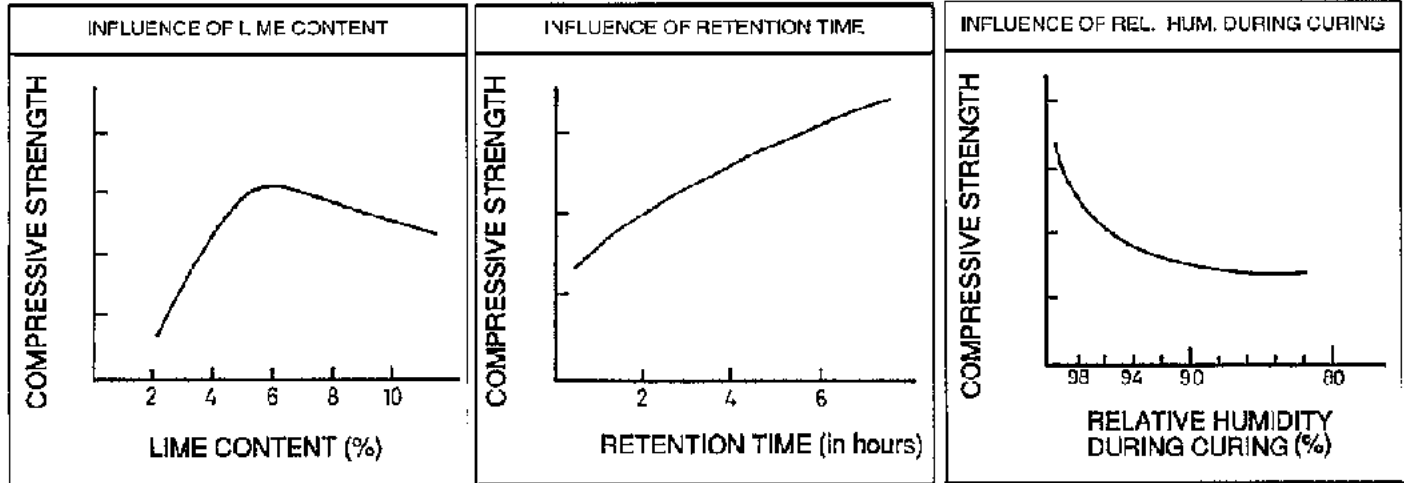

FIGURE

Calculating how much stabilizer to use

PRINCIPLES (see examples of calculations)

Stabilization calculations always refer to the weight of dry materials. The proportions of stabilizer used corresponds to the percentage by weight of the stabilizer compared with the weight of the earth (including any sand or gravel which may have been added).

As it is difficult to weigh accurately on site, weight is converted into volume.

For this, the density of the material when loose and dry (ρ) being used in the mix must be

known (see formula 1). Once (ρ) is known, it is very easy to convert quantities into volumes of loose, dry material (see formula 2).

$$\text{Formula 1. Dry density } \rho(\text{kg/m}^3) = \frac{\text{weight}(\text{kg})}{\text{volume}(\text{m}^3)}$$

$$\text{Formula 2. Volume } (\text{m}^3) = \frac{\text{weight}(\text{kg})}{\rho(\text{kg/m}^3)}$$

CALCULATION OF THE DENSITY OF MATERIAL WHEN LOOSE AND DRY

Dry the sample (of earth, sand, etc.) and weigh 1 litre of this sample. If you do not have accurate scales (± 10 g), then weigh out a larger amount (5 or 10 litres...), in order to reduce the degree of innacuracy. The results in grams/litre are equivalent to those of kg/m^3 (see formula 1).

AMOUNT OF EARTH, SAND AND GRAVEL

Containers of known capacity must be available (e.g. wheelbarrow ≈ 60 l capacity, buckets between 10 and 15 l capacity) to allow precise calculations. The amounts required will be multiples of these container capacities.

KEY

ρ_C : dry density of sack of cement (kg/m^3)

ρ_E : dry density of dry earth (kg/m^3)

ρ_S : dry density of sand (kg/m^3)

W_C : weight of cement (kg)

W_E : weight of earth (ka)

W_S : weight of sand (kg)

Vol_S : volume of dry sand (m^3)

Vol_E : volume of dry earth (m^3)

C: percentage of cement = degree of stabilization (%)

E: percentage of earth (%)

S: percentage of sand (%)

METHOD OF CALCULATION FOR AN EARTH/CEMENT MIX

Method 1

The weight of the cement is obtained by determining the volume of earth and the degree of stabilization (the percentage of cement used), (see formula 3).

Formula 3.
$$W_C = \frac{\rho_E \times V_E \times C}{100}$$

Method 2

The volume of earth is obtained by determining the weight and the percentage of cement used (see formula 4).

Formula 4.
$$Vol_E = \frac{W_C \times 100}{\rho_E \times C}$$

Results must be rounded off to make volumes equivalent to multiples of container capacities, and then the percentage of cement recalculated using these values (see formula 5).

Formula 5.
$$C = \frac{W_c \times 100}{Vol_e \times \rho_e}$$

METHOD OF CALCULATION FOR AN EARTH, SAND (OR GRAVEL) AND CEMENT MIX

Method 1

The weight of the cement is obtained by determining the volumes of earth and sand (or gravel) and the degree of stabilization (see formula 6).

Formula 6.
$$W_c = \frac{[(\rho_e \times Vol_e) + (\rho_s \times Vol_s)] \times C}{100}$$

Method 2

The volume of earth and the volume of sand (or gravel) are obtained by determining the weight and percentage of cement and the percentages of earth and sand (see formulae 7 and 8).

Formula 7.
$$Vol_e = \frac{W_c \times E}{\rho_e \times C}$$

Formula 8.
$$Vol_s = \frac{W_c \times S}{\rho_s \times C}$$

The volumes of earth and sand (or gravel) must be rounded up or down to the nearest whole site measuring out volume and the rate of stabilization then recalculated (see formula 9).

Formula 9.
$$C = \frac{W_c \times 100}{(\rho_e \times Vol_e) + (\rho_s \times Vol_s)}$$

The percentages of earth and of sand (or gravel) can then be precisely recalculated.

Formula 10.
$$E = \frac{\rho_E \times Vol_E}{(\rho_E \times Vol_E) + (\rho_S \times Vol_S)}$$

Formula 11.
$$S = \frac{\rho_E \times Vol_S}{(\rho_E \times Vol_E) + (\rho_S \times Vol_S)}$$



[Home](#) > [ar](#) [cn](#) [de](#) [en](#) [es](#) [fr](#) [id](#) [it](#) [ph](#) [po](#) [ru](#) [sw](#)

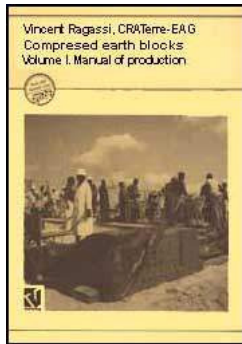

 **Compressed Earth Block - Volume I. Manual of production (GTZ, 1995, 104 p.)**



Equipment



Selection criteria



Products



Uses



Choosing a press



Choosing soil preparation equipment

Compressed Earth Block - Volume I. Manual of production (GTZ, 1995, 104 p.)

Equipment

Selection criteria

GENERAL CONSIDERATIONS

There is a wide choice of machinery and equipment available. The quality of the equipment used is important, but the quality of the soil remains of paramount importance.

GENERAL CRITERIA

Design

The ways in which pieces of equipment can be physically located will influence productivity. This includes, for example, their adaptability, their capacity to be combined together and the extent to which they are integrated into a production line. Working conditions should also be taken into account.

Safety measures must be considered, for example, protection against projected material, marking out dangerous areas, installing fuses or emergency switches for disabling automatic machinery.

Maintenance is indispensable, but should not be excessive. Sophisticated machines will allow high productivity, but if time spent on maintenance is too high, output will fall. Spare parts which wear out quickly should be readily available (in terms of cost and delivery) or easily repairable locally.

Manufacturer

It is important to find out how much experience the manufacturer has in international business and whether he has a distribution network, as this can have a major impact on supply times (of machines and parts) as well as on maintenance, if problems occur.

Manufacturers should be in a position to allow visits to their production unit and to provide the names and addresses of brickworks where their equipment is being used, as recommendations of their products, but also to encourage exchanges of experience between different users.

Conditions of sale

- Prices: The price indications given in catalogues or in proforma invoices should be carefully studied. Prices may be quoted in three different ways: EXW (Ex Works): the machine as it leaves the factory, excluding packing and transport; FOB (free on board), which includes packing, transport and insurance until the order leaves the country of origin (the seller), and to which must be added transport and insurance costs as far as the country of destination; and CIF (cost, insurance and freight), which covers all costs as far as the country of destination, with the exception of local taxes. FOB or CIF prices can sometimes be artificially raised to compensate for discounts given on ex-factory prices.

- Expenses: Banking charges (such as letters of credit, exchange or transfer commissions) and charges incurred by intermediaries must be taken into account and it should be clearly stated whether responsibility for these lies with the seller or the buyer. A letter of credit accepted by the seller, who then has to submit an invoice, will cost approximately 5% of the CIF price. In addition, a letter of credit taken out by the buyer will cost him approximately 5 to 7%. Letters of credit for "sensitive" countries can cost up to 14%. Any intermediaries used to transfer a letter of credit from the buyer to the seller will ask for a minimum of 10 to 12%. They will also require a commission of at least 15%. All this can add up to over 25 to 30 % of the CIF price.

- Contracts: it is advisable to include a penalty clause for delivery delays. In the case of an after-sales service contract, repair and maintenance times must be stipulated. A detailed manual including parts specifications and a maintenance plan, and stating which operations need to be carried out and at what intervals, must be provided.

CONSTRAINTS

Budget available

A low budget will considerably restrict the choices available.

Productivity

This depends on market projections. It may be more advantageous to allow for extensions than to start out too big.

Power supply

Power supply availability may be more of a problem than cost.

Power supply

Power supply availability may be a greater obstacle than its cost.

Maintenance

If no qualified staff or no parts are available, machines which are simple to maintain should be selected.

SPECIFIC CRITERIA

Preparation equipment

These are not necessarily indispensable, but they will greatly improve the quality of the end-products. Their purchase may be viable, for example, if they enable one to lower the amount of stabilizer used. The type of soil will be the determining factor in choosing preparation equipment (such as grinders, crusher, screens), but will be less so for the type of mixer chosen.

Presses

Productivity and the size of the production unit will be determined by the presses used. The following are particularly important: the implications of the market survey (on productivity and on product type), the budget available and the production team (cost and degree of specialization of the labour-force).

Technical criteria are addressed below.

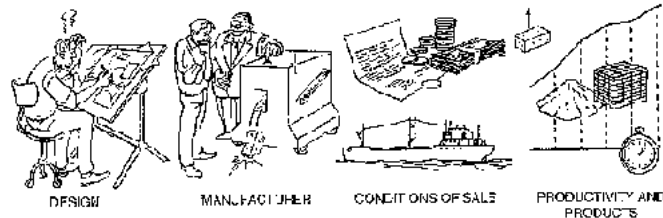

FIGURE

Products

MOULDS AND PRODUCTS

The variety of possible shapes of CEBs is illustrated in the table below.

In principle, they are produced using a specific mould for each shape, but it is also possible to integrate frogs into a mould to modify the way the force is applied (see chapter on PRODUCTION: special block moulds).

A wide variety will require interchangeable moulds, which is not always possible on all machines.









PRODUCT DIVERSIFICATION

It is certainly an advantage to produce several types of block, providing one has a use for them. Diversification should be based on a thorough understanding of the context (the market, the building systems, peoples) needs, etc.).

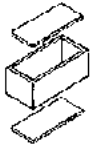
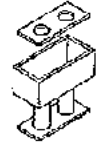
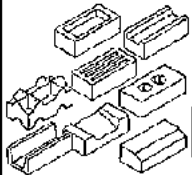
DECIDING ON SHAPES AND SIZES

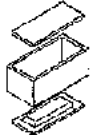
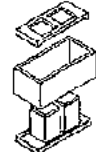
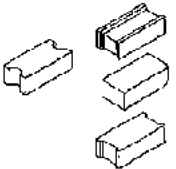
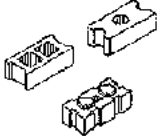
The dimensions of a block are determined by :

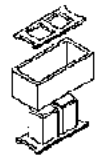
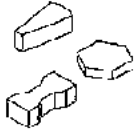
- Its weight: it should be easy to handle, (max 10 kg).**
- The compressive force which will be applied: if the height of the block is too great, compression will not be evenly applied.**
- Bonding patterns: the ratios of length (1) to width (w) are determined by the bonding pattern to be used (headers and/ or stretchers, plus the thickness of the joint). In order to avoid having to cut blocks, it is useful to have sub-multiples of the standard blocks, (e.g. 3/4 or 1/2 blocks). For partially hollow blocks, in addition to these constraints, the building systems to be used will be the determining factor.**

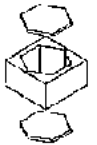
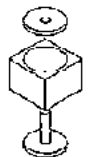
		THE 8 TYPES OF CEB		THE 8 TYPES OF MOUND	
		FULL	PERFORATED	FULL	PERFORATED
RECTANGULAR	SIMPLE				
	WITH HORIZONTAL INTENDED OR RAISED PROFILE				
	WITH HORIZONTAL AND VERTICAL INTENDED OR RAISED PROFILE				
NON-RECTANGULAR					

FIGURE

Uses

DIFFERENT USES

It is important to understand the various possible building systems before launching a production.

Loadbearing and reinforced masonry

This most commonly requires full standard blocks, which are laid according to classic bonding patterns, and which have the following dimensions:

length (l) = 29.5 cm;

width (w) = 14 cm; height (h) = 9 cm.

For correct bonding, it is useful to have blocks varying in length. Thus 3/4 blocks, l = 21.75 cm, and 1/2 blocks, l = 14cm, are in common use. The width of the block may also vary to obtain wall thicknesses ranging between 14 and 29.5 cm.

Differences in volume can also be introduced: horizontal channels to allow for cables or rods in the walls, or sometimes vertical channels (perforations) to lighten the blocks and/or to allow for cables or vertical reinforcement, e.g. in earthquake regions. The reduced strengths which perforations entail and the fact that they will be partially or totally filled with mortar which will generally have to be more highly stabilized than the blocks, giving a possible higher global stabilization cost (of blocks + mortar), should not be overlooked.



Chamfered blocks (with a straight or rounded edge), can also be useful, as they prevent wearing at the corners of walls.

Infill masonry

Conditions of use are more or less identical to those of loadbearing masonry, apart from the fact that much lower strengths can be used, since the blocks are not loadbearing. In this case, using hollow blocks (with vertical perforations) can be advantageous.

Special applications

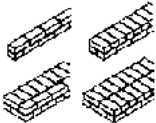
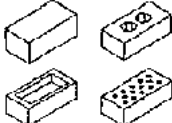
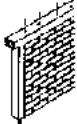
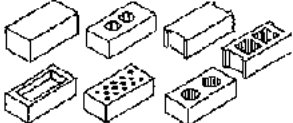
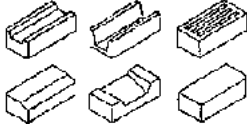
Blocks can be used for facing floors and walls, for decoration, for claustra work, for interlocking building systems, etc. These are, however, fairly unusual building systems and require preliminary market and technical surveys.

	INTENDED USE	BLOCKS REQUIRED
NORMAL LOAD- BEARING MASONRY		
INFILL MASONRY		
SPECIAL APPLICATIONS	<ul style="list-style-type: none"> - Ventilation - Cable duct - Chanters - Decoration - Masonry vaults and arches - Tie beam 	
		

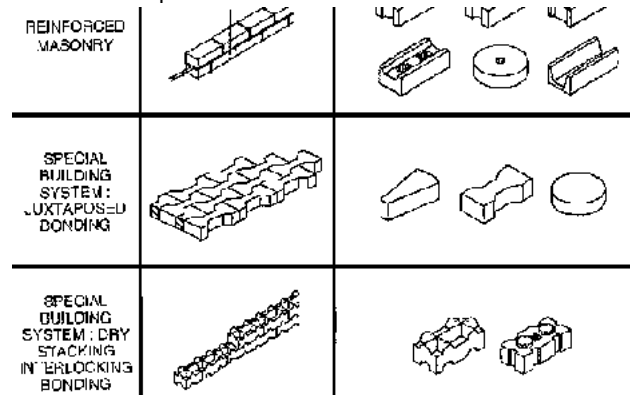
**FIGURE**

FACTORS TO TAKE INTO ACCOUNT

Once the main building systems have been determined, which main types of block will have to be made?

As a general rule, the following approximate order of priorities will apply: various sizes to facilitate bonding patterns, horizontal voids (to allow for cables or ring beams), vertical voids (indispensable in earthquake regions), and finally non-rectangular blocks, the manufacture of which will depend more heavily on commercial than on building criteria.

Horizontal voids are easy to produce using frogs without having to change the moulds. Frogs can also be used to change the size of the block, but here changing moulds is preferable. For vertical voids, special moulds have to be used.

When choosing a press, these considerations will enable one to decide on whether other

moulds will need to be used or not, i.e. the degree of interchangeability required.

Choosing a press

TECHNICAL CRITERIA

Power supply

Manually operated presses will rely on the strength and endurance of the operator and this is why differences in the quality of products can often be observed over several hours.

Motorised presses significantly reduce irregular quality and allow higher forces to be applied. The motor should be easily accessible. For production units where the motor is used to power several interdependent work stations, accessibility and repairs often pose a problem.

Transmission systems exist in a number of forms, but fall into two main groups: mechanical systems and hydraulic systems. Mechanical system machines are in general fairly simple, but also rather heavy, unless special alloys, which have the disadvantage of being rare in some areas, are used. Hydraulic systems are vulnerable to environmental factors (dust and temperature). Under certain difficult conditions, the hydraulic fluid has to be changed frequently (once a month) and machines which are fitted with cooling systems require skilful maintenance.

Moulds

These have to be able to withstand strong forces for long periods and therefore have to be very robust. Mould interchangeability is a bonus if it is easy and simple. With presses equipped with several moulds (e.g. rotating tables), changing moulds is more difficult and arduous.

Products

Double compression applied simultaneously to 2 opposite sides has certain advantages: the least well compressed part of the block will be in the central area of the block rather than on the more critical external edge. Blocks of up to nearly 20 cm in height can be produced.

The ejection of the block from the mould, which is generally in the same direction as the compression, should not put any undue pressure on the still fragile blocks.

Dimensions: if the blocks are too small, the walls will take too long to build; if they are too large, their weight will make them difficult to handle.

The most common size (29.5 × 14 × 9 cm) is a good compromise between these two extremes.

The regular appearance of the block will depend above all on the quality of the soil used.

Productivity

Theoretical production cycles (as quoted by manufacturers) fail to take account of the many factors which are independent of the capacity of the machines (pauses, organisation of the labour-force, etc.)

Actual productivity often works out at nearly half of theoretical productivity. For manual presses, the theoretical cycle (filling, compressing, removing the block) takes between 30 and 60 seconds. For motorized presses, it takes approximately 15 seconds. For automated units, even in the best circumstances, it will never take less than 5 to 7 seconds.

Working conditions

There are bound to be three operations linked to the use of a press: filling, compressing, and removing the block. Whatever mechanism is used (manual or motorized) care must be taken to ensure easy access and well-located work stations for each of these.

Using a manual press is tiring and must be made as easy as possible (e.g. using a long lever arm).

Risks increase when a motor is introduced, so particular attention must be paid to safety measures (protective grills, ensuring manual operations are carried out at some distance from pistons, using circuit-breakers, etc.).

TYPES OF PRESS	WEIGHT	PRODUCTIVITY 28.5x14x9cm blocks per day
MANUAL light	50 to 150 kg	300 to 600
MANUAL heavy	150 to 250 kg	700 to 1 500
	700	1 000

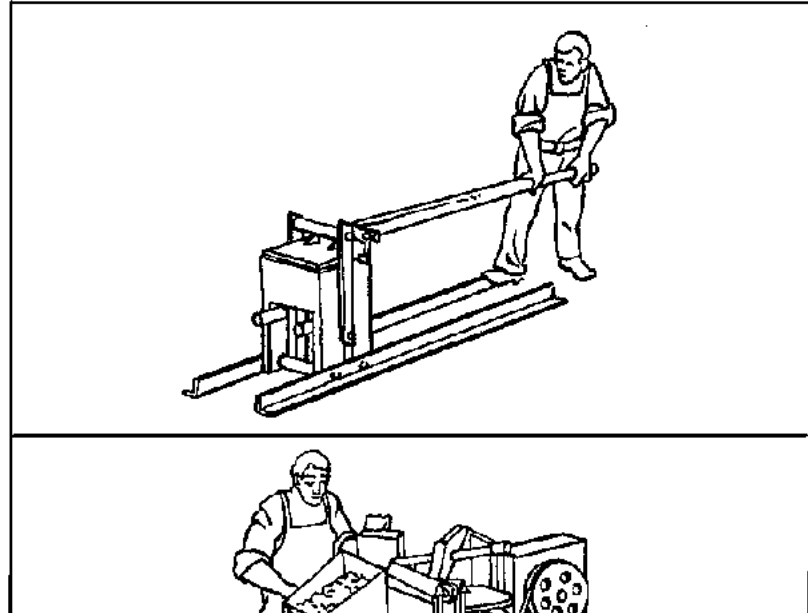

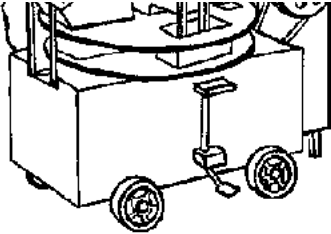
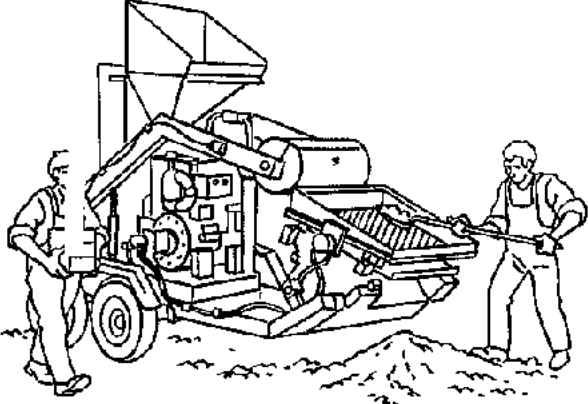
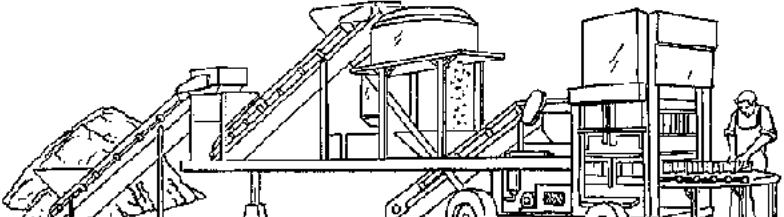
<p>MOTORIZED</p>	<p>1 000 to 2 000 kg</p>	<p>1 000 to 5 000</p>	
<p>MOBILE UNIT</p>	<p>1 500 to 6 000 kg</p>	<p>1 500 to 4 000</p>	
<p>FIXED UNIT</p>	<p>2 000 to 30 000 kg</p>	<p>2 000 to 10 000</p>	

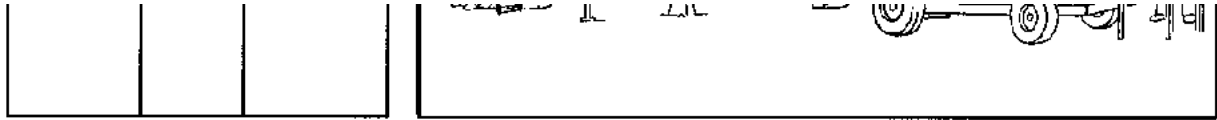
**FIGURE**

Choosing soil preparation equipment

PULVERIZERS

These should enable one to obtain an earth where at least 50% of the particles held together by clay (lumps or nodules) will be less than 5 mm in diameter.

There are two main kinds of pulverizers:

- Blade grinders or cutters consisting of steel blades oscillating around an axis, which in turn rotates around a central, main axis.**
- Crushers which consist of two "treadmills" turning close to one another in opposite directions.**

Grinders will break up not only lumps of earth, but also gravel and small stones, making them closer in particle size to sand. They work well with gravelly, or even stony, soils.

Crushers are more suited to finer soils, which contain no gravel or stones, and where it is mostly lumps of clay which need to be broken down.

Technical criteria

All pulverizers enable one to prepare dry soil but only rarely do they perform well with wet soils which require high speed impact. The choice here will be dictated by the kind of

soil and the climatic conditions.

For less efficient pulverizers, it can be useful to place a screen which removes the coarsest particles as they are ejected. The height of the feeding hopper should not be too great to allow easy loading. The height at which the soil is ejected can also usefully be set in such a way as to allow a wheelbarrow to be filled directly.

Apart from for fixed units, the machine must be easy to move around (on wheels) as stocks of untreated or pre-prepared soil vary, so that ejection of earth from the machine is not hampered.

The pulverization system used should be easy to clean, as it can become coated in wet, compacted soil.

Delicate parts should be protected from dust.

SCREENS

Screening is indispensable if the pulverization is imperfect or with soils which contain too many large stones, but no lumps of clay. Diameters vary between 5 and 20 mm depending on the earth and the type of blocks to be produced (e.g. thin-sided, hollow blocks, etc.).

The system which gives the least rejected material should be chosen.

There are two main types of screen (not counting fixed manual sieves):

Rotating screens: a cylindrical grate or cylinder made of extended metal rotates around a horizontal, mechanically or manually driven axis.

Vibrating screens: these are motor-driven and consist of one or several superimposed grates in an almost horizontal position.

Technical criteria

Cylindrical grate screens have the advantage of being robust, but are generally more expensive and difficult to replace than screens fitted with extended metal. Replacing the screen grid itself must be easy. They should be designed in such a way as to allow direct filling of a wheelbarrow or a conveyor belt. For non-integrated units, wheels making them easier to transport can also be useful.

MIXERS

The extent to which materials are evenly mixed is fundamental to the quality of the finished block. Ordinary cement mixers are not suitable, as earth is highly cohesive when wet. Unlike concrete, earth forms lumps of compacted matter which cannot subsequently be compressed.

Some agricultural machinery such as motor cultivators, can be suitable. Here we consider more specifically designed equipment:

Planetary mixers: blades are fixed to a vertical shaft which turns inside a tank.

Linear mixers: a series of blades fixed to a shaft in the form of helical screws which turns inside a horizontal or vertical cylindrical tank. This system is more complex and more cumbersome.

Horizontal shaft mixers: here a series of blades are fixed to a horizontal shaft which turns within a cylindrical tank. The principle is similar to that of the linear system, but without the material being gradually pushed along.

Technical criteria

Earth which is mixed when wet is cohesive and requires more motor-power than concrete.

The shape of the mixer-blades should be examined to ensure that they penetrate well into the mix causing as little abrasion as possible, but moving it along as much as possible. Earth is highly abrasive, particularly when lateritic. The movement of the blades should on no account produce lumps of compacted material in the form of balls of earth. Usable capacities quoted are often calculated for concrete and should be adjusted downwards for earth. Operational capacity is generally about half of the volume of the tank.

Filling access should be easy and it should be possible to empty out into a wheelbarrow.

The tank should be equipped with a protective grill.



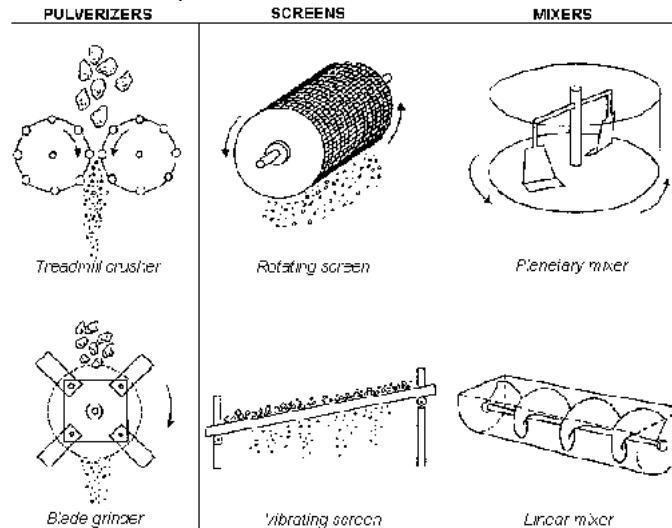

If the mixer is equipped with a sprinkling system, water will be added in a fine spray.



FIGURE

[Home](#) > [ar](#) [cn](#) [de](#) [en](#) [es](#) [fr](#) [id](#) [it](#) [ph](#) [po](#) [ru](#) [sw](#)

 **Compressed Earth Block - Volume I. Manual of production (GTZ, 1995, 104 p.)**

- ➔  **Production layout**
 -  **Definition of the production line**
 -  **Types of equipment**
 -  **Manufacturing means**

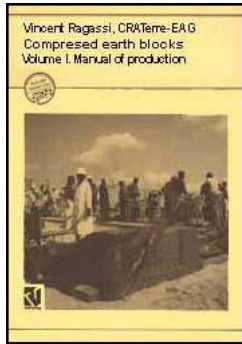

Types of production line Investments

- Semi-mechanized brickworks**
- Semi-mechanized brickworks with mobile presses**
- Fully mechanized brickworks**

Compressed Earth Block - Volume I. Manual of production (GTZ, 1995, 104 p.)

Production layout

Definition of the production line

PRODUCTION SITE

Production requires quite a lot of space, because of the different stock requirements (raw materials and blocks). Depending on the type of project, production will be carried out either directly on site or in a workshop which is not directly linked to the site, and this needs to be decided at the outset. The choice will be influenced by parameters which include the duration and volume of production, and transport distances, which should be kept to a minimum.

Access to the site must be good for supplies and for removing stocks of blocks. The site should preferably have a water supply and electricity if motorized equipment is being used.

PRODUCTION CYCLE

All the operations which the manufacture of the blocks requires must be defined. The need for various processing operations should be evaluated in context. There will be no need to allow for drying out the earth in a very dry region for example, nor to screen it if the earth naturally has a good grain size distribution.

Any intermediate operations which take up space and manpower then have to be assessed - transporting, stocking, removing the blocks. Once this has been done, the quality standards of the products have to be defined in order to decide on the target objectives to be reached at each stage of processing, based on general and local technical data. Thus the influence of each operation on the ultimate quality of the product can be assessed.

SCALE OF THE OPERATION

Target productivity must first be set in the light of product demand. High productivity is not necessary if the rate of demand for the blocks is low, as this will only lead to the storage area becoming congested.

Low productivity is harmful if demand for the blocks is high. There is a risk that blocks will be put into use without having had the complete curing time which is indispensable. If CEBs run out of stock, either site work will stop, or there is a risk that the client will change the supplier.

Once the productivity target has been set, calculating consumption is easy. This in turn defines the sizes of the various storage areas needed.

METHODS AND MEANS OF PRODUCTION

Once the broad principles have been determined, each work station must be refined in

more detail. It should be possible to apply a precise output figure for each. This means comparing the options and working out what each implies in terms of labour. There may, for example, be a choice between a labour-intensive operation using simple equipment, or sophisticated equipment requiring very little labour. For example, in one hour a bulldozer and one person can do what it would take forty people two days to do without machines. This therefore defines the equipment, the materials, and the labour-force required.

ORGANIGRAMME AND ORGANISATION

The methods and means of production are determined by allocating tasks between the various work-stations, thus setting the ideal output of each and the general coordination of the inputs and outputs of each operation. To avoid having to close down production because of a fall in output of one work station, buffer stocks should be allowed between each. These absorb variations in rhythm between various work stations and should not be excessive. This enables one to work out the surface area required for each work station.

INFRASTRUCTURE

The manufacturing line needs to have the benefit of a certain environment to be operational. The scale of these various arrangements will vary with the type of unit and with productivity, but should be flexible enough to allow for growth without too many additions.

In dry, warm areas, measures will have to be taken to protect workers from the sun and from dust.

Built areas

A depot to store tools and raw materials, including any stabilizer used, will be needed. It may also be necessary to provide sanitary and cloakroom facilities for staff, an office for

administrative tasks and a laboratory for quality control testing.

Sheltered areas

Certain operations will need to be protected from direct sun and/or from rain: earth preparation and mixing, compression and initial curing. A small structure of posts roofed over with straw, canvas, tiles etc. and a hard, flat ground surface will be required.

Flat surfaces

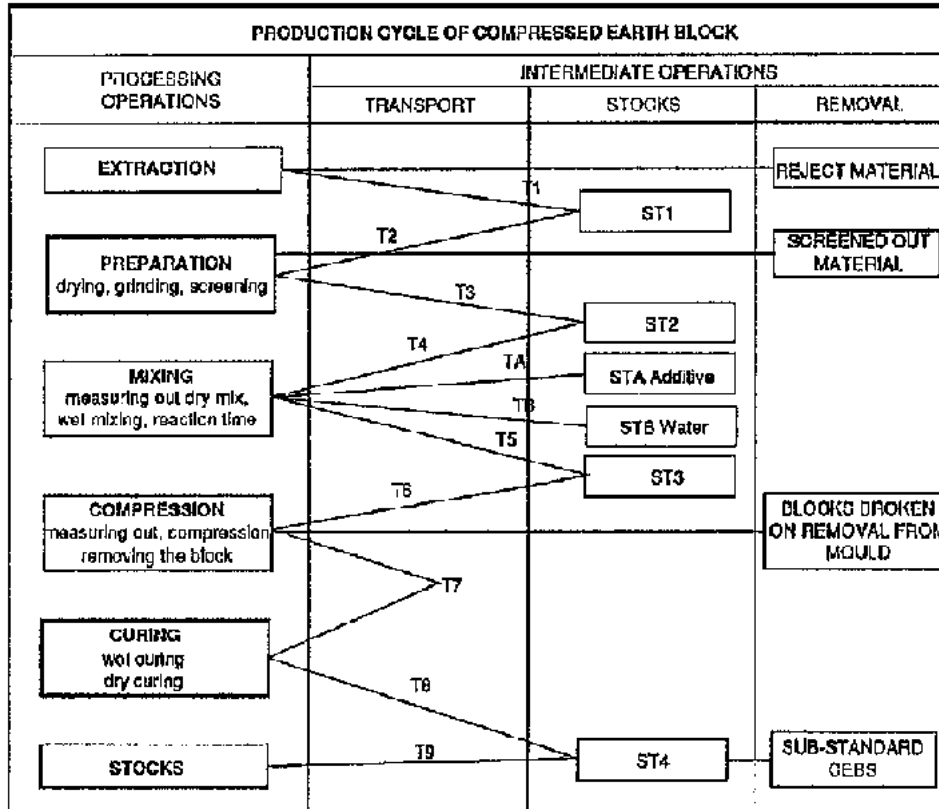

Blocks need not necessarily be stocked under a roof as such: canvas can suffice. A hard, flat ground surface (such as rammed stabilized earth or a concrete slabs) is, however, essential for the piles of blocks to be stable.



FIGURE

Types of equipment

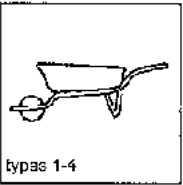
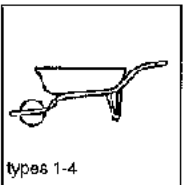
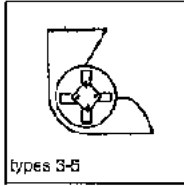
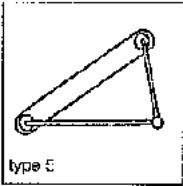
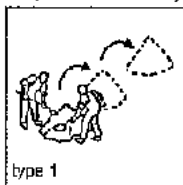
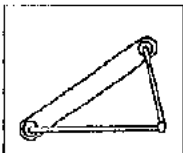
The following table is intended to help define the production line. It allows accounting considerations between the various possible approaches and equipment to be defined and at the same time gives an idea of the scale of investment each represents. Prices given are indicative, as are output figures, to which we return in more detail in the chapter on PRODUCTION. Reading the table from top to bottom gives an idea of the different means available for each operation. From left to right, the table illustrates the various possible production lines, providing that there is sufficient consistency between the levels of investment and of output for each work station. The high degree of flexibility in terms of growth of a CEB production unit is also apparent.

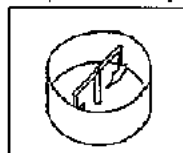
TRANSPORT	PREPARATION	TRANSPORT	MIXING
	<p>MANUAL PREPARATION investment 100 \$ output 3-5 m³/man day</p>  <p>types 1-4</p>	<p>WHEELBARRROW investment 30 \$ output: 11 m³/man day</p>  <p>types 1-4</p>	
<p>WHEELBARRROW investment 30 \$ output 11 m³/man day</p>  <p>types 1-4</p>	<p>CRUISER GRINDER investment 4000-6000 \$ output 25-40 m³/day</p>  <p>types 3-5</p>	<p>CONVEYOR BELT investment 4000 \$ output 40-60 m³/day</p>  <p>type 5</p>	<p>MANUAL MIXING investment 30 \$ output 1.5 m³/man day</p>  <p>type 1</p>
<p>CONVEYOR BELT investment 4000 \$ output 40-60 m³/day</p> 	<p>SCREEN investment 5000-10000 \$ output 30-40 m³/day</p> 	<p>CONVEYOR BELT WITH HOPPER investment : 8000 \$ output 30-40 m³/day</p> 	<p>PLANETARY MIXER investment 5000-6000 \$ output : 5-50 m³/day</p> 

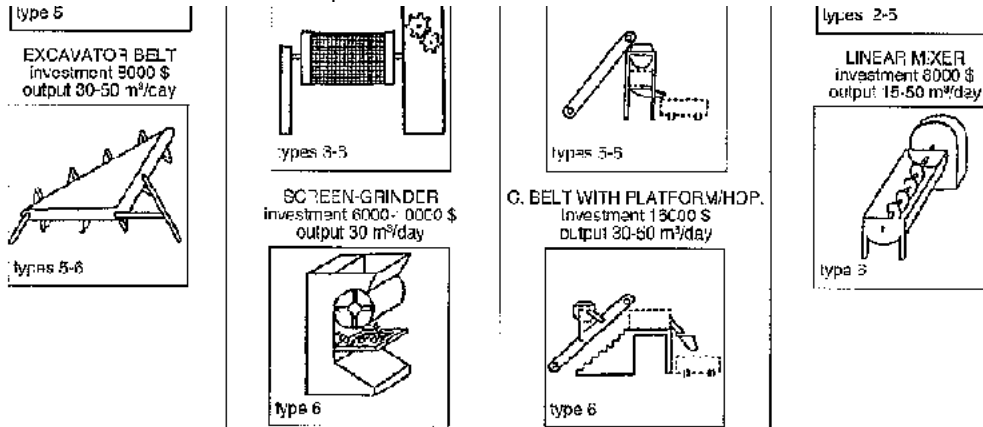

FIGURE

Manufacturing means

Note

Output figures reflect the normal use potential of equipment, but are purely indicative, as are the prices quoted. The organization and the staffing of the production unit, however, will be of paramount importance in determining outputs.

TRANSPORT	COMPRESSION	TRANSPORT	CURING
	<p>MANUA. PRESS investment 200-500 \$ output 3-4 m³/day 300-600 blocks</p> 	<p>FLAT BOTTOM WHEELBARROW investment 50 \$ output 6 m³/day 800-1000 blocks</p>	<p>PLASTIC SHEETING Investment 150 \$ output 300-600/day</p>

WHEELBARROW
Investment: 30 \$
output: 1 m³/man day

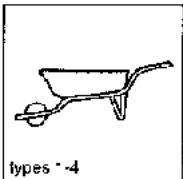

MEASURING HOPPER
Investment: 1000 \$
output: 15-40 m³/day

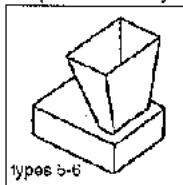

types 1-3

MANUAL PRESS
Investment: 1500-2000 \$
output: 5-8 m³/day
700-1500 blocks

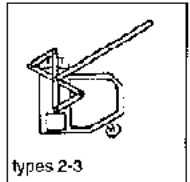

types 2-3

MOTORIZED PRESS
Investment: 12000 \$
output: 11-13 m³/day
1500-2000 blocks

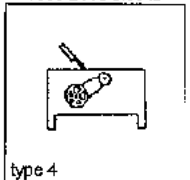

type 4

MOTORIZED PRESS
Investment: 15000 \$
output: 12-16 m³/day
1500-2000 blocks

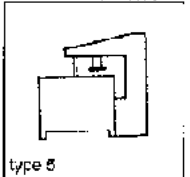

type 5

MOTORIZED PRESS
Investment: 20000 \$
output: 40 m³/day
5000-6000 blocks

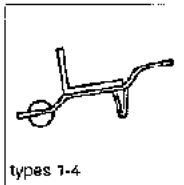
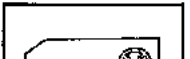

FLAT BOTTOM WHEELBARROWS
Investment: 100 \$
output: 12 m³/day
1600-2000 blocks

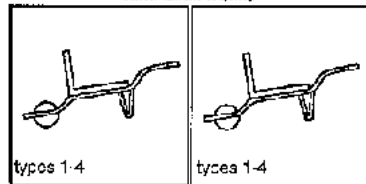

types 1-4

types 1-4

FALLT ROLLEY
Investment: 750 \$
output: 40 m³/day
5000-6000 blocks

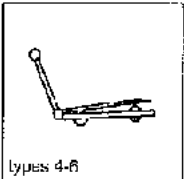

types 4-6

FORK-LIFT TRUCK
Investment: 17000 \$
output: 40 m³/day
5000-6000 blocks

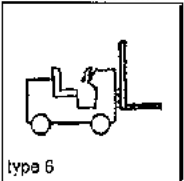

type 6

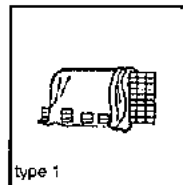

type 1

PLASTIC SHEETING
Investment: 250 \$
output: 1000-1500/day

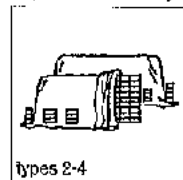

types 2-4

PLASTIC SHEETING
Investment: 600 \$
output: 500-2500/day

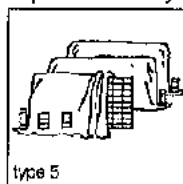

type 5

TARPAULIN
Investment: 1500 \$
output: 5000-6000/day

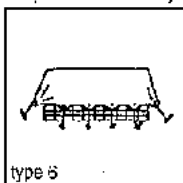

type 6

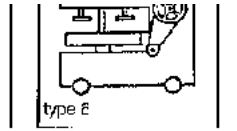

FIGURE

Types of production line

This table illustrates the various types of production unit presented in the INTRODUCTION chapter. Other types are possible but the range shown here follows progressive increases in productivity, investment and mechanization.

These increases will be dictated by the need to improve product quality from types 1 to 3, and then to improve productivity through greater mechanization from types 4 to 6. The table lists only equipment specifically for CEB production. For intermediate transportation, see the tables on the preceding pages.

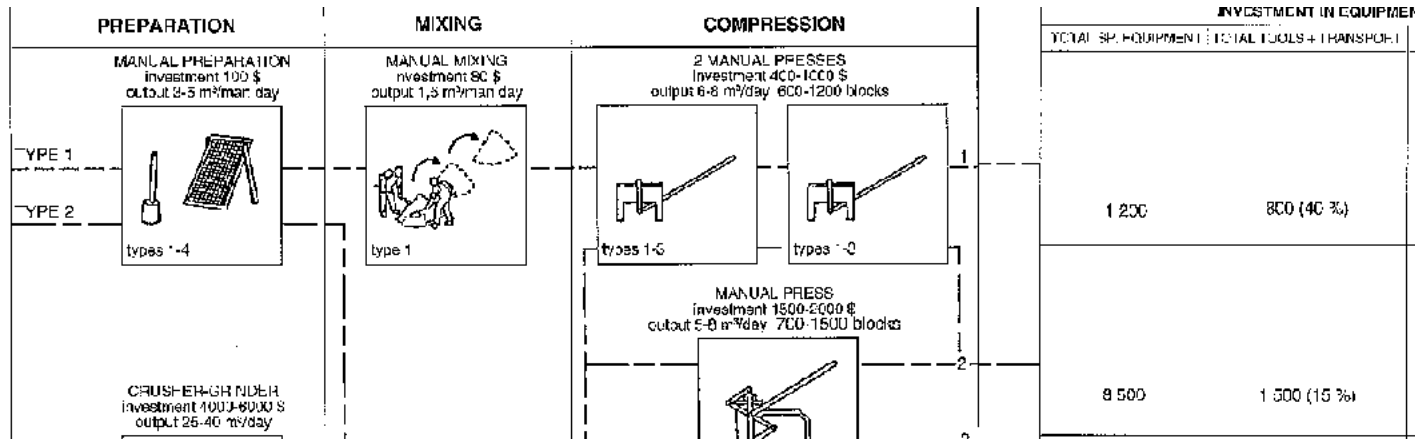

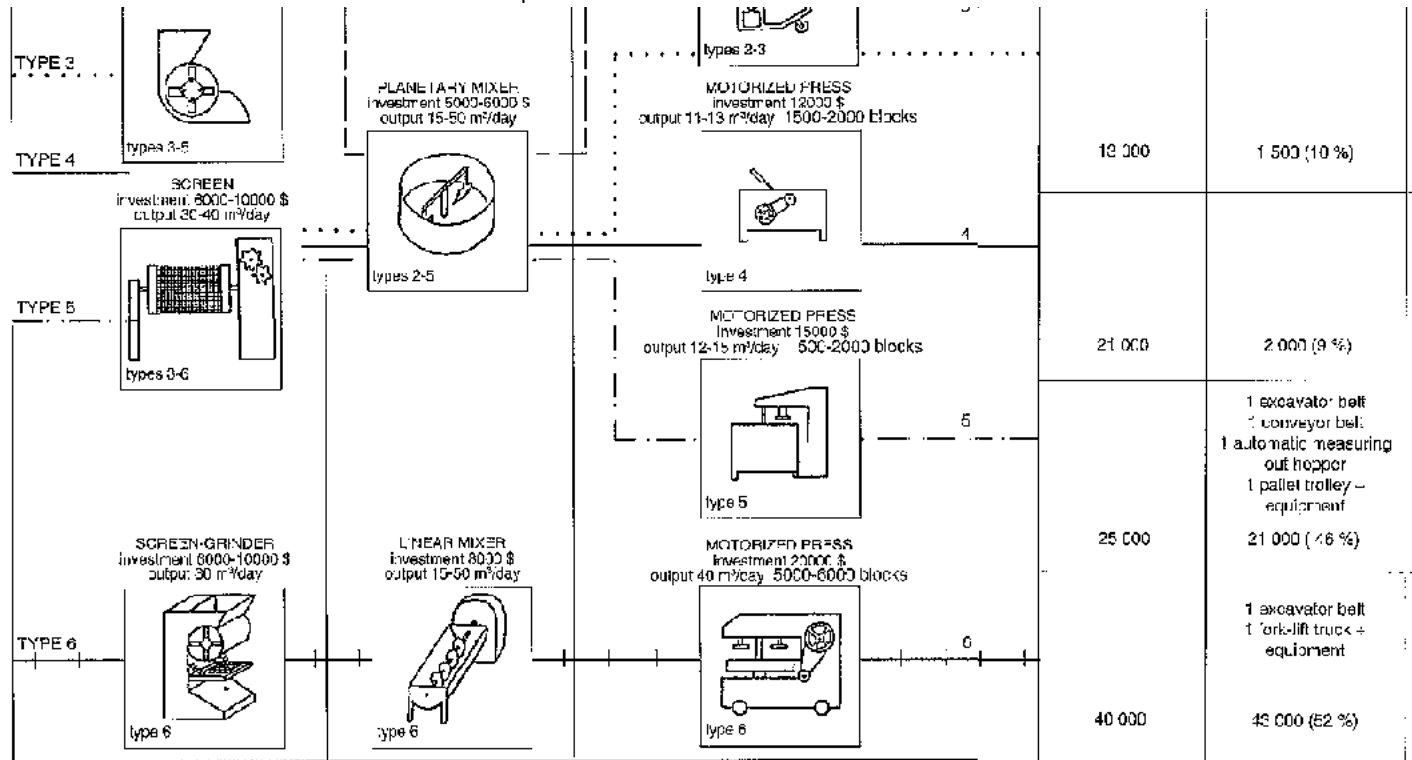

FIGURE

Investments

A production unit does not begin and end with the acquisition of a press.

Detailed comments on investments are given in the INTRODUCTION chapter. Here, however, investment is shown in terms of particular pieces of equipment or tools. The relationship between one and the other deserves careful attention, particularly for type 5 where there is a very high investment in equipment because of the mechanization of all transport. It is also clear that purchasing processing equipment alone does not constitute setting up a brickworks: investment in tools and transport ranges between 9 and 52% of the total equipment investment, which is in the order of 80% of the total investment. The remaining 20% consist in investment in infrastructure, not counting the cost of land for the production site.

Semi-mechanized brickworks

ASSUMPTIONS	TASKS	SURFACE AREA (incl. space for moving around)
TYPE OF PRODUCTION LINE (see p. 9) types 3 or 4	Stock of soil	75 m ² (≈ 10000 blocks)
	Stock of sand	20 m ²
	Stock of cement	10 m ² (6 tons)
PRODUCTIVITY 1400-2000 BLOCKS/DAY (29.5 x 14 x 9 cm) 7000 to 12000 blocks/week.	Stocking tools	1.5 m ²
	Stocking water	3 m ² (1400 l)
DAILY QUANTITIES CONSUMED : 10 to 12 m ³ of soil 0.75 ton of cement (6 %) 1200 to 1300 litres of water	Screening	15 m ²
	Grinding	15 à 20 m ²
	Mixing	17 m ²
	Compression	17 m ²
INFRASTRUCTURE		
COVERED PAVED AREA : 120 m ²	1st cure (2 days)	50 m ²
HARD, FLAT AREA : 380 m ²	2nd cure (13 days) + drying out (13 days)	325 m ²
TOTAL	Usable surface area	552 m ²
	Total surface area	644 m ²

FIGURE

TASK	PERSONNEL	TOOLS				EQUIPMENT
	CONTROLLER : 1	SHOVELS	WHEEL - BARROW	FLAT	TARPAULIN OR POLYTHENE	
Screening	2	2	2			2 fixed screens
Grinding	1	1	1			1 motorized grinc
Mixing	2	1	1			1 planetary mixe
Compression	Press operator loader stacker = 6	2	1			2 manual presse
1st cure	1			approx. 1	3,6 x 5 x 4 =75 m ²	
2nd cure + drying out	2			2	5,8 x 23 =157 m ²	
TOTAL	15 people	6	5		232 m ²	

FIGURE

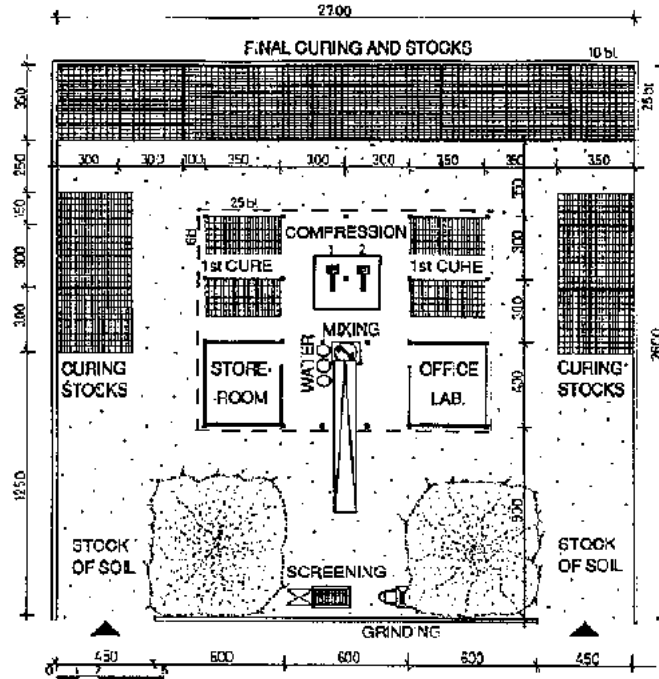

FIGURE

General remarks

Here, our intention is mainly to show a type of layout and its infrastructure; from that point onwards, there is great flexibility in the type of machines chosen, depending on the investment potential.

This plan can be adapted to suit a manual workshop (preparing and mixing the earth, and

compressing and transporting the blocks by hand) with 2 or 3 manually operated presses (type 2), but also a brickworks where preparation, mixing, compressing and transportation are mechanized, such as for types 4 and 5, provided daily production does not exceed 2 000 blocks, in which case larger areas will need to be set aside for stocks.

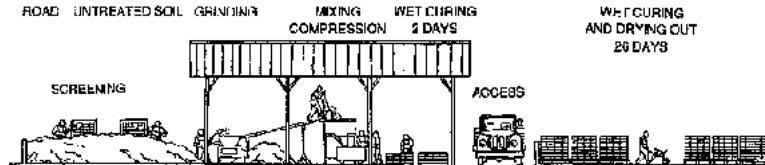

FIGURE

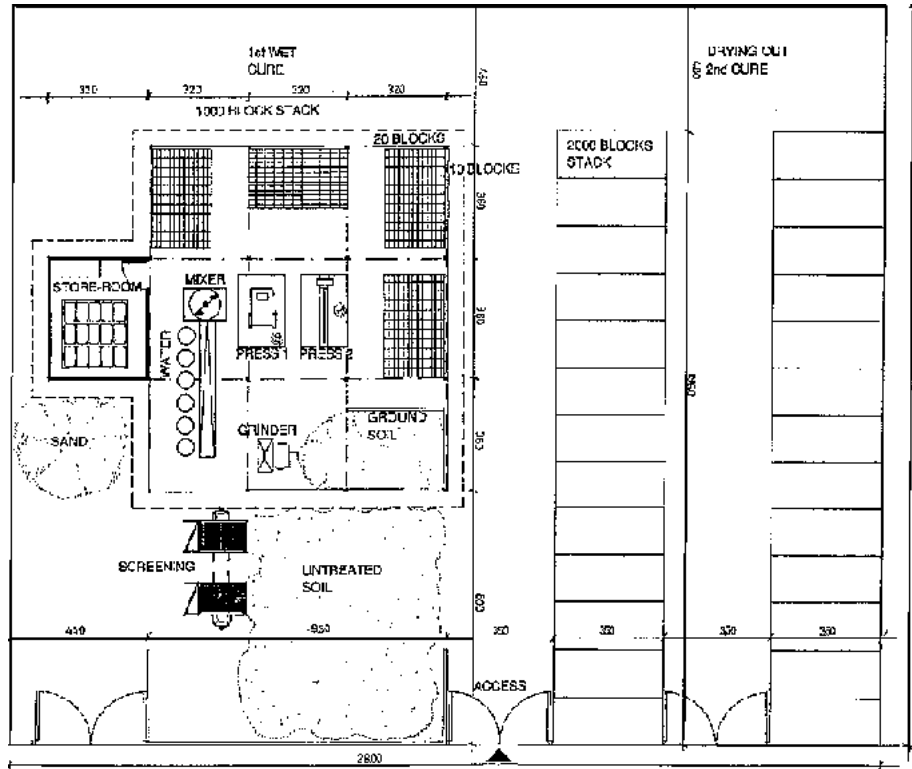

FIGURE

Semi-mechanized brickworks with mobile presses

ASSUMPTIONS	INFRASTRUCTURE	EQUIPMENT
TYPE OF PRODUCTION LINE (see p. 9) Type B	Covered area : 36 m ² Hard, flat area : 410 m ² Flat area : 650 m ²	1 treadmill crusher 1 screen 1 planetary mixer (250 l) 2 manual presses
PRODUCTIVITY : 1200 to 1400 blocks/day 6000 to 8500 blocks/week (29.5 x 14 x 9 cm blocks)	stock of soil : 225 m ³ stock of blocks : 355 m ³	2 - 4 wheelbarrows 10 - 15 buckets 1 flat bottom wheelbarrow
DAILY QUANTITIES CONSUMED 9 to 10 m ³ of soil (13 to 18 m ³ /day) 0.5 to 0.6 tons of cement (6 %) 1000 to 1000 l of water	PERSONNEL 13 to 14 people	7 - 8 shovels Curing of blocks : wrapped in polythene sheets and covered with woven mat

FIGURE

Comments

The brickworks shown below is one which is in operation in N'djamena (Chad) and which is mainly geared to the sale of blocks, and therefore to irregular demand, which explains the large size of the areas set aside for stocking soil and blocks.

The presses used (Terstaram, etc.) are easy to move around, relatively light and equipped with wheels. Using them in different places reduces the distance blocks need to be transported to the curing area and risk damage. On the other hand, this approach requires more transportation of the soil-cement mix.

The shelters for the presses are made from steel tubes with a canvas covering: they have to be light-weight/in order to be easily moved around.

This type of layout can also be used for manual operations, preparation and mixing (type 2).



FIGURE

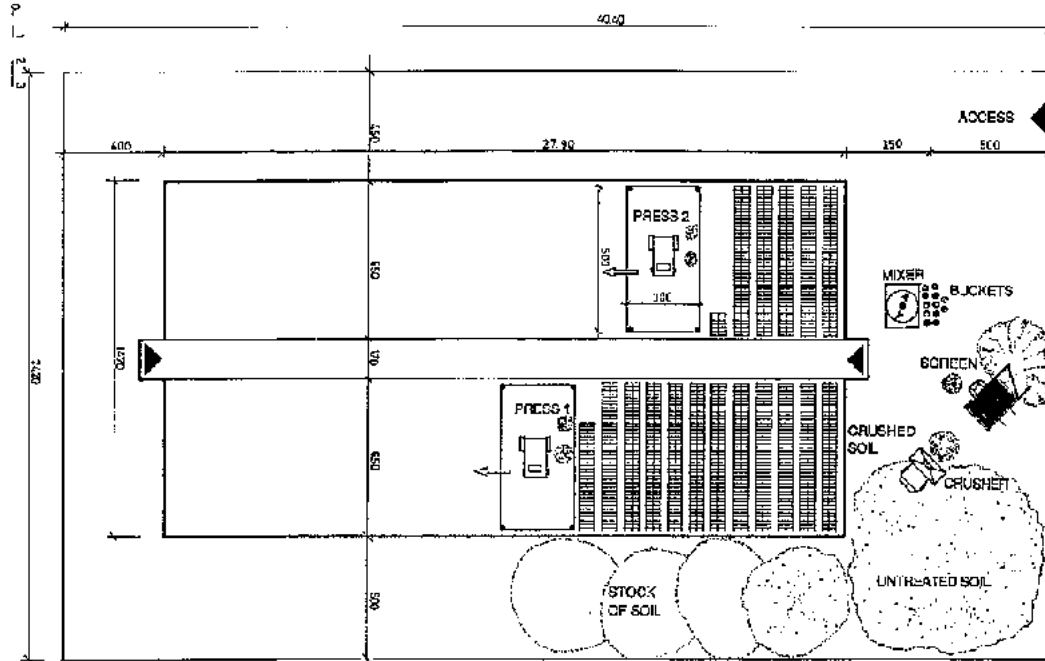

FIGURE

Fully mechanized brickworks

ASSUMPTIONS	INFRASTRUCTURE	EQUIPMENT
TYPE OF PRODUCT ON LINE (see p. 9) Type 5	Covered area: 30 m ² Paved area: 100 m ² Total area: 550 m ²	1 excavator belt (7 m) 1 conveyor belt (6 m) 1 electric screen-grinder
PRODUCTIVITY: 1 500 - 2 500 blocks/day 7 500 - 15 000 blocks/week (29.5 x 14 x 8 cm blocks)	Stock of soil: 150 m ³ Stock of blocks: 65 m ³ Possible extension: 175 m ²	1 soil-cement measuring out system 1 planetary mixer 520 l 1 side valve hopper
DAILY QUANTITIES CONSUMED: 11 to 18 m ³ of soil (20 to 30 m ³ /day) 0.6 to 1 tons of cement (0.5%) 1 500 to 2 000 l of water	PERSONNEL 5 to 6 workers	1 motorized press 1 roller bat (2 m) 1 outlet trolley

FIGURE

Comments

The brickworks shown is below one which is in operation in Thoronet (France). It is located close to the site for which it was intended, but is also open for external sales of blocks. Demand for its blocks is therefore regular and high, which explains why the areas set aside for stocking blocks is fairly limited. This type of brickworks mainly suits situations where the cost of labour is high and where maintenance staff are highly skilled.

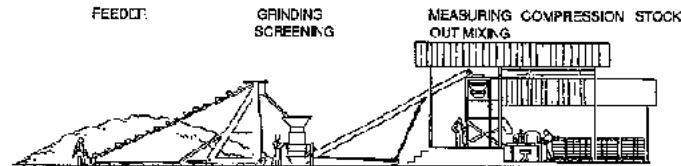

FIGURE

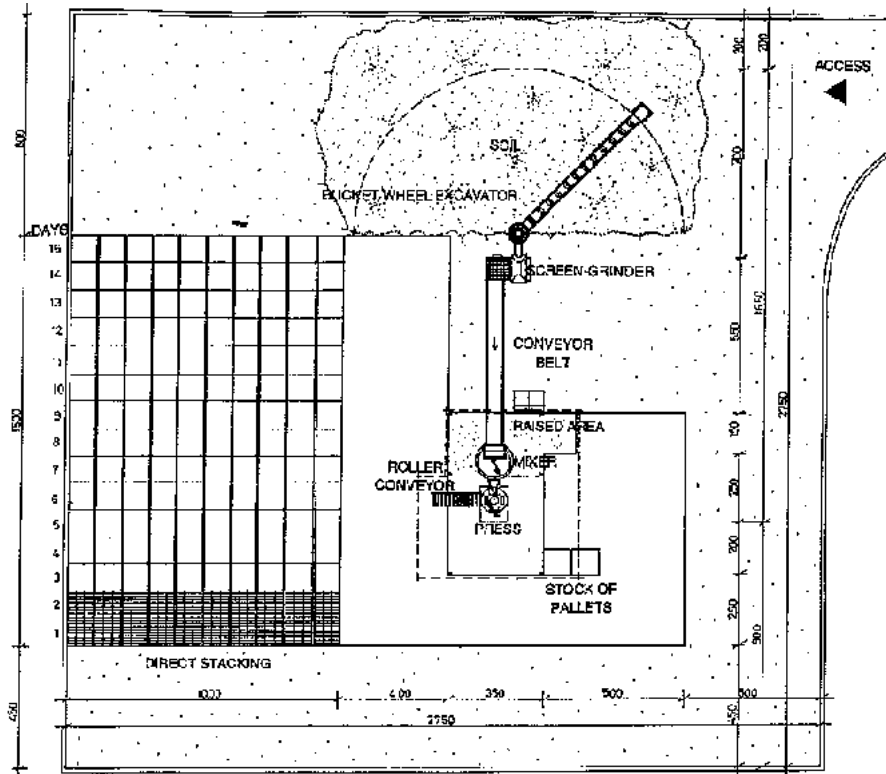

FIGURE

Home > [ar.cn.de.en.es.fr.id.it.ph.po.ru.sw](#)

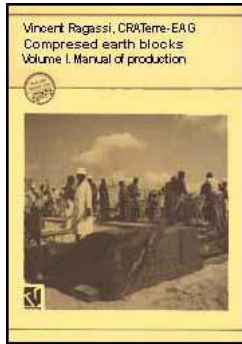

 **Compressed Earth Block - Volume I. Manual of production (GTZ, 1995, 104 p.)**



Production



Soil extraction



Transport



Stocking raw materials



Manual preparation



Motorized preparation



Measuring out



Mixing



Compressing the blocks



Curing and drying

Compressed Earth Block - Volume I. Manual of production (GTZ, 1995, 104 p.)

Production

Soil extraction

GENERAL OBSERVATIONS

When deciding on how to extract the soil, several points must be taken into account. Is the extraction site on the production site itself or not? How much soil is needed and how can you avoid the risk of the soil type changing during extraction? Is the location accessible or will additional work be necessary? Is there any danger during extraction of causing a landslide? Will large holes be left behind, in which case dealing with these (by filling, levelling, landscaping etc.) needs to be allowed for.

HOW TO EXTRACT THE SOIL

For manual extraction, simple tools will suffice (shovels, picks, wheelbarrows). For mechanized extraction, a great deal of public works equipment is available, but is very expensive to purchase. The economic aspect will need to be precisely evaluated, both in terms of direct cost and the broader side-effects of the choice made. For the same cost, extraction time will differ greatly between manual and mechanized operations, as will the potential for creating jobs.

Depending on the site layout, certain pieces of equipment will be more suitable than others. A shallow, but wide quarry, for example, will need "raking machines" (such as dumper trucks, excavators, a bulldozer, scraper, agricultural tractor, etc.) If the quarry is deep' but narrow, machines such as mechanical diggers or loader-diggers for vertical digging will be more suitable. For more detailed information, there are numerous documents relating to public works to be consulted.

**Shovels and picks**

Output: ordinary ground, 8.2 m³/day/ man with 10 men digging and 15 pushing wheelbarrows; very compact ground, 0.8 m³/day/man with 10 men digging, 5 pushing wheelbarrows, and 20 using picks

**Agricultural tractor**

Outputs with one man on very soft ground, 80 m³/hour; on compact, scarified ground, 30 m³/hour.

**Excavator**

Output for ordinary to firm ground: 4 to 8 m³/hour (smallest model).

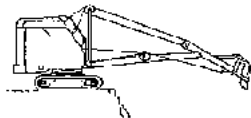
**Rear action mechanical digger**

Output equivalent to that of a drag-line, approximately 100 m³/hour, but enables one to dig vertically and to very compact ground.

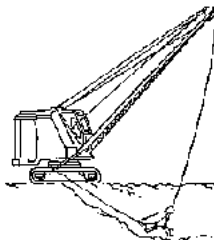
**Mechanical digger with drag-line:**

Output with one man, compact ground: 100 m³/hour. Enables one to dig at a depth of approximately 2 metres.

**Bulldozer**

Output with one man, compact ground: 100 m³/hour.

**Loader-digger**

With one man: output for good terrain and using a 1000 litre bucket, approximately 26 m³/hour.

FIGURE**Transport****INTERMEDIATE OPERATIONS**

This chapter deals essentially with processing operations specific to CEB production. Intermediate operations will, however, require transport and space, and these have to be taken into consideration for the brickworks to be efficiently run.

The data and outputs given below are indicative of the form of transport which will be best suited to each brickworks, from the simplest to the most sophisticated. Stocking materials and products will be addressed further on. It is difficult to give even approximate indications of the waste material excavated as this will be highly dependent on the context (the type of soil, the production location, proportions of materials used etc.). In general, it is fairly easy to find uses for waste, which includes rubble, rejects of screening, broken or sub-standard blocks, etc. It can be used for infilling, land drains, low temporary walls, etc. Recycling waste will take up part of the labour input and this should be checked to ensure that it is viable.

LOADING		TRANSPORT					TOTAL OUTPUT (loading + transport)			
EQUIPMENT	OUTPUT	EQUIPMENT	SPEED	CAPACITY	TRANSPORT DISTANCE	OUTPUT	LOADING METHOD	OUTPUT		
shovel (1 per person)	9 to 13 m ³ /day/man Depending on the hardness of the soil	Conveyor	9 km/h	0.08 m ³	4 m	60 to 60 m ³ /day	shovel or digger	10 to 45 m ³ /dm depending on the digger		
			4 km/h	0.2 m ³	6 m	100 to 110 m ³ /day	shovel or digger	10 to 25 m ³ /dm depending on the digger		
		Wheelbarrow	2 km/h	0.06 m ³	10 m	60 m ³ /day	shovel	9.6 m ³ /dm		
					50 m	18 m ³ /day	shovel	6 m ³ /dm		
		Cart	3 km/h	0.4 m ³	100 m	70 m ³ /day	shovel	9.6 m ³ /dm		
					500 m	15 m ³ /day	shovel	8.5 m ³ /dm		
		8 ton lorry (1 in all)				5 m ³	5 km	170 m ³ /day	shovel loader-digger	10.5 m ³ /dm 50 to 130 m ³ /dm depending on the digger
							10 km	90 m ³ /day	shovel	10 m ³ /dm
Loader-digger (250 l bucket)	70 m ³ /day						loader-digger	40 to 70 m ³ /dm depending on the digger		
750 l bucket (1 in all)	260 m ³ /day									

FIGURE

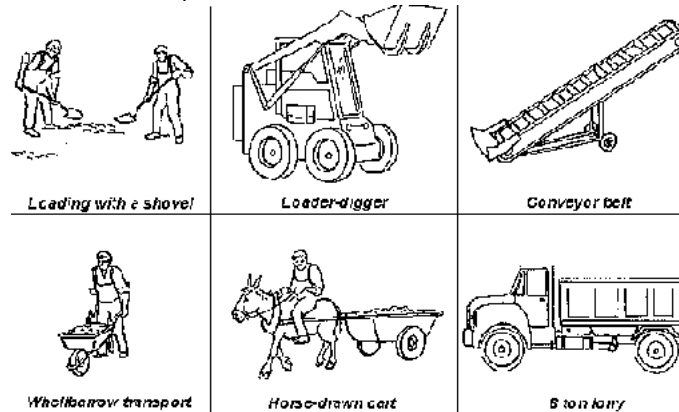
**FIGURE**

Stocking raw materials

SOIL AND SAND

Both of these are generally stocked in bulk, but they can also be kept in storage bays if space is limited and to avoid them flowing and mixing together.

Keeping stocks in piles

The contents of a 5 m³ lorry will take up 9.5 m² on the ground, or approximately 1.7 m² per m³ soil or sand (taking account of settling).

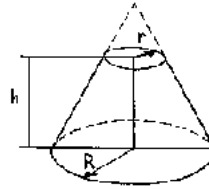

$$\text{Volume} = \left(\frac{R+r}{2} \right)^2 \cdot h$$

FIGURE**Keeping stocks in storage bays**

The sides must be strong enough to contain the soil.

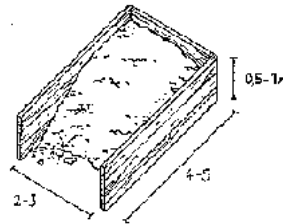
**FIGURE****WATER**

Water is often stocked in 200 litre barrels. These are easy to find, cheap, and transportable. They can, for example, be placed under a roof gutter to catch rainwater.

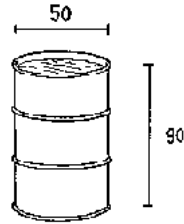
**FIGURE****Storage tank**

A water tank with sides strong enough to resist the pressure of the water can also be built from CEBs with a waterproof render.

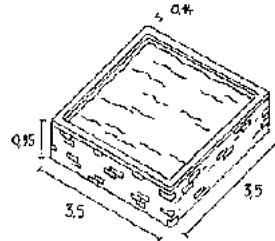
**FIGURE****CEMENT AND LIME**

Both of these are generally supplied in sacks, particularly cement. Here we use a "standard" 50 kg (= 42 l) sack of cement as a base.

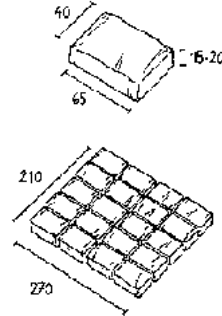
**FIGURE**

The sacks should preferably be stocked in a secure area and protected from humidity, i.e. raised above the ground and kept away from walls to prevent the cement from absorbing humidity and to avoid destabilizing the walls (see sketch below).

Temporary external storage areas, protected by tarpaulin or plastic sheets, can also be used (as shown below).

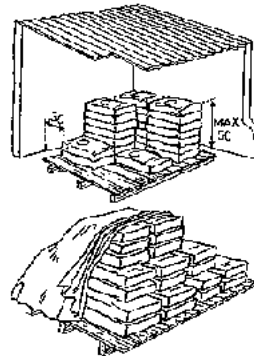

FIGURE**SPACE NEEDED FOR STOCKS ACCORDING TO SCALE OF PRODUCTION**

BLOCKS 29,5 x 14 x 9 cm	SOIL (heaped)	SAND (heaped)	WATER (vats/in litres)	CEMENT (piles 9 sacks)
for 100 blocks	0.7 m ²	0.2 m ²	0.3 m ³ /100 l	0.08 m ²
for 1 000 blocks	7 m ²	2 m ²	1.5 m ³ /1 000 l	0.25 m ²
for 10 000 blocks	70 m ²	20 m ²	15 m ³ /10 000 l	2.6 m ²

FIGURE**Manual preparation****GENERAL OBSERVATIONS**

Soil preparation operations will play a crucial part in the ultimate quality of the blocks. These operations can sometimes make it possible to use soils which are unusable in their natural state, because they can include modifying the grain size distribution. Bearing in mind that extraction and transportation costs are generally high, this can allow useful economies to be made.

As we have seen in the chapters on STABILIZATION and EQUIPMENT, preparation is virtually indispensable for stabilized blocks in order to ensure an even distribution of the stabilizer, which will not work efficiently if the soil is sticking together. Even for non-stabilized blocks, any sods or tiny lumps of soil will prevent even compression and will

then become weak spots inside the blocks. Preparation also enables any grain size distribution defects to be rectified. Grinding, for example, can fragment gravel, thus turning it into coarse sand; screening can remove a soil fraction such as stone or gravel which may be present in too great a quantity.

PULVERIZATION

The object here is to either break up lumps which are held together by clay (crushing) or to fragment stones and gravel (grinding). Applying fairly high pressure is sufficient for crushing, whereas grinding demands a hard impact.

SCREENING

In general, this is done to remove the particles which are too coarse. Mesh sizes typically go from 10 mm for presses which are sensitive to compression, to 20-25 mm for less sensitive presses, because of their higher compression force ($F > 10$ MPa).

TECHNIQUE	OUTPUT	INFRASTRUCTURE	EQUIPMENT
Manual crushing	1 to 2 m ³ /day/man	Sheltered, well-ventilated area 5 to 10 m ²	1 tamp or pestle/person 1 wheelbarrow and 1 shovel
Manually driven percussion crusher	3 to 4 m ³ /day/man with minimum 2 workers	Sheltered well-ventilated area 5 to 10 m ²	1 crusher 1 wheelbarrow and 1 shovel
Fixed screen manually loaded	2 to 4 m ³ /day/man depending on the humidity of the soil	Sheltered, well-ventilated area 15 to 25 m ² (inc. 20% stock, waste and space for moving around)	1 shovel/person 1 wheelbarrow and 1 screen
Suspended fixed screen	4 to 5 m ³ /day/man with minimum 2 workers	As for fixed screen	1 shovel/person 1 wheelbarrow and 1 screen

FIGURE

MANUAL TECHNIQUES

Crushing can be carried out manually by breaking up the lumps of soil with a pestle or

tamp. This process is cheap from the point of view of equipment, but it is also slow and painstaking. There are some simple manually-driven mechanisms using backwards and forwards motion or cranking handles. These can only crush the soil and have fairly low outputs relative to their cost.

Grinding by hand, although it does exist traditionally, is in practice very laborious, except for very small quantities.

Screening by hand, on the other hand, is very common. A wire-mesh fixed to a frame is either held at a slant by rigid supports, or suspended almost horizontally from a superstructure. The screen can therefore be shaken backwards and forwards, which increases output. Provided the soil is very dry, there are also hand-operated rotating screens with fairly good outputs, but which are quite expensive.

Crushing by hand

The soil is spread out and any lumps are broken up preferably on a hard surface.



FIGURE

Fixed manual screen

The soil is thrown onto the screen, which is fixed at an angle of about 50°. The angle can be modified, to allow more or less material to passing through.



FIGURE

Manual pendulum crusher

The crusher can be combined with a sieve so that all the processing operations are carried out at once. Not to be used with soils with too high a gravel content.



FIGURE

Suspended screen

The screen is at a slight angle to allow waste material to be removed and has a backwards and forwards motion.



FIGURE**Motorized preparation****GENERAL OBSERVATIONS (see chapter on EQUIPMENT)**

Equipment specifically for preparing soil has not existed for very long; previously, preparation equipment was developed for the concrete industry or for agricultural purposes where conditions are different. For concrete, the material is reconstituted starting from pure, isolated ingredients (gravel and sand), whereas for CEB production, a product is obtained from a composite material (soil), where an ingredient has sometimes to be added or removed.

Agriculture is concerned with organic matter which is not as abrasive as soil. Agricultural equipment will therefore need to be slightly modified to avoid its getting very rapidly worn.

TECHNIQUE	OUTPUT	INFRASTRUCTURE	EQUIPMENT
Treadmill crusher	15 to 40 m ³ /day with 1 to 2 workers	Sheltered and well-ventilated area total 10 to 15 m ² with loading ramp 15 to 25 m ²	1 crusher, 1 to 2 shovels, 1 to 2 wheelbarrows
Blade grinder	30 to 50 m ³ /day with 1 to 2 workers	Sheltered and well-ventilated area total 10 to 15 m ² with loading ramp 15 to 25 m ²	1 grinder, 1 to 2 shovels, 1 to 2 wheelbarrows
Mechanical rotating screen	20 to 40 m ³ /day with 1 to 2 workers	Flat sheltered area 20 to 30 m ²	1 rotating screen, 2 shovels, 1 to 2 wheelbarrows
Vibrating screen	40 to 70 m ³ /day with 1 to 2 workers	Flat sheltered area 20 to 30 m ²	1 rotating screen, 2 shovels, 1 to 2 wheelbarrows
Fixed screen with mechanical loader	40 to 50 m ³ /day with 1 operator and 1 helper	Flat area incl. moving arc and 100 to 200 m ² stock areas only are sheltered	1 mechanical front-loader, 1 shovel, 1 reinforced screen 2 x 2 m

FIGURE**CRUSHING**

Manual crushing is painstaking and moreover does not grind down the material. Mechanizing this process is therefore advantageous, particularly as a great deal of equipment specifically for soil is beginning to come onto the market.

"Tread-mill" crushers are suitable for fine soils with no stones or coarse gravel. They can only break up the lumps which are held together by clay and will not fragment any solid particles. This means that the grain size distribution of the soil is not modified. This type of machinery is suitable for treating dry soil, but can work with a soil the moisture content of which is close to the moisture content for compression limit (10 to 15%), in which case, it could also be used as a mixer.

Blade grinders are suitable for all soil types, even stony ones, since the hammers or cutters will split stones. This means that grinders do modify the grain size distribution of the soil, by increasing its fine graves and coarse sand content and eliminating stones and coarse gravel. The horse-power, apart from its impact on output, affects the extent to which the material will be broken down. Grinders work badly with wet soil which forms a crust inside the machine, blocking the feeding hopper and causing the hammers to wear more quickly. If necessary, the soil will have to be dried or at the very least the inside of the machine will need to be cleaned out very frequently. Nevertheless, this type of pulverizer is one of the most efficient.

SCREENING

The mechanical screens currently available, whether vibrating or rotating, are rarely specific to CEB production. They often allow several grids to be used in combination in order to break the material down into various grain size fractions, which is rarely useful for CEBs, where at most only one or sometimes two grain sizes need to be isolated. Outputs are generally high and apply to large production units.

Mechanically-driven rotating screens can be relevant to medium to large sized units.

Vibrating screens are heavy and very high in energy consumption. They are relevant only to large production units.

Fixed screens loaded from loader-diggers can be an advantageous solution. The screens are simple and cheap. They can be made locally in craft workshops. The loader-digger, although relatively expensive, can be used at various stages in the production process (i.e. extraction, transport, pallet loading, etc.) Similarly, agricultural tractors equipped with forward buckets can be used.

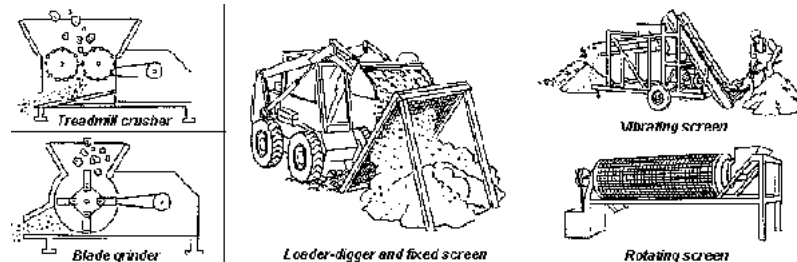

FIGURE

Measuring out

GENERAL OBSERVATIONS

As we have already seen in the chapter on STABILIZATION, ensuring that the correct amounts of different materials are used is crucial, both for the quality of the product and for controlling production costs. Here we are not concerned with calculating quantities (which is covered in the chapters on SOIL and BLOCK-MAKING), but with how they are measured out, which can be either by weight or by volume of material.

MEASURING OUT BY WEIGHT

The amounts to be used are calculated as dry weights, but measuring out in the brickworks must take account of the moisture content, which is difficult to check in the case of materials such as sand, gravel, or earth. As the moisture content of cement, however, is insignificant, it can be measured out by weight without any danger of error. The scales used must be accurate to within 10 to 50 g depending on the quantities being weighed. The smaller the quantities, the more accurate the scales will need to be.

The operation must be carried out reliably (from the point of view of the operator and the scales), as well as efficiently (actions should be easy and quick), failing which there is no advantage to be gained from measuring out by weight. This approach has the advantage of measuring out material in a way which is precise and easily adjustable. For large production units, cement can be measured out by an automatic balance system (scales), identical to those used in concrete factories.

MEASURING OUT BY VOLUME

This is the most common and the simplest method. It has the disadvantage of being a little unprecise, depending on how wet and how loose the material is. This imprecision can be compensated for, however, by quality controls and by an experienced operator. Above all, measuring out containers of known capacity must be available.

There are two options:

- When using existing equipment (buckets, wheelbarrows, etc.), check the volumes with a relatively precise instrument (e.g. graduated bucket). These volumes are measured at the startup of production and will be used as the basis of calculations of quantities to be used. During production, volumes must be regularly checked to make sure that they have not changed (because of dents or different buckets or wheelbarrows being used, etc.).**

- Making measuring out containers (boxes for materials such as soil, gravel or sand) of the desired volumes, i.e. probably 30 to 60 l capacity. If the box is too small, the same operation will have to be repeated too many times, and if it is too big, it will be too heavy. If mixing is done by hand, boxes with no base can be used, so the contents do not have to be lifted up. These should not exceed 100 to 150 l capacity. If a box is made for measuring out cement, its capacity will be approximately 5 to 10 litres. For large production units, measuring out can be done using feeding hoppers combined with a measuring out slide valve of precisely fixed capacity.

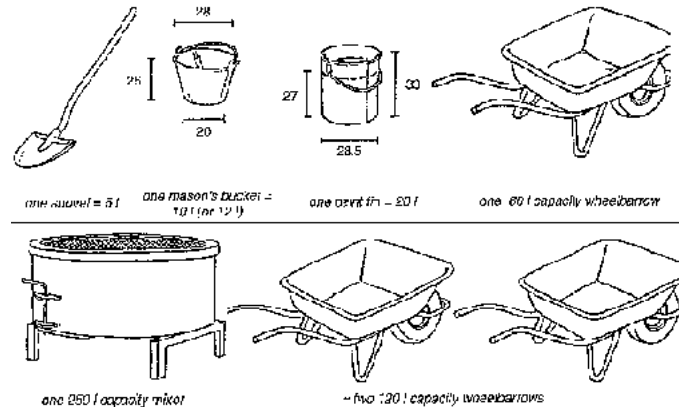

FIGURE

MEASURING OUT EARTH, SAND AND GRAVEL

For all these materials, the usual quantities range from about ten to about a hundred litres. The most suitable way of measuring out is generally by volume (using a bucket, a

wheelbarrow, a measuring box etc.). After filling the measuring container, the surface must be levelled out using a straight edge (the handle of a shovel for example) to scrape it level with the top of the sides of the container.

MEASURING OUT WATER

It is difficult to calculate beforehand the precise volume of water which will be needed to reach the optimum moisture content for compaction, as this will depend on the natural moisture content of the various materials (soil, sand, etc.) which varies greatly. The operator must determine the optimum quantity of water using simple tests (e.g. the drop test, see QUALITY CONTROL) and by experience.

MEASURING OUT CEMENT

The usual quantities will fluctuate between 5 and 15 kg. If measuring out is by weight, all that is needed are fairly precise scales. If a measuring box made to correspond to the volume required for a given degree of stabilization is being used, the surface should be scraped level with the sides without pressing the cement down. Actions should be as repetitive as possible so that the same amount is measured out each time. If measuring out is done by dividing up a full sack, e.g. 1/2, 1/3, 1/4, 1/5 of a sack, the contents of the sack should be divided up at in one go between the correct number of containers (usually buckets). Thus to obtain 1/3 of a sack, 3 buckets are needed for 1/4. 4 buckets, etc.

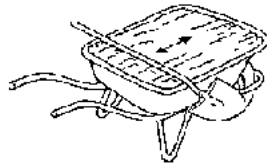

Leveling and scraping off surplus from a wheelbarrow with a shovel

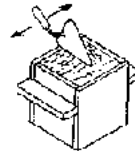

Scraping off surplus from a measuring box with a trowel



Dividing up cement into 4 equal quantities

FIGURE**TABLE OF SUGGESTED AMOUNTS OF CEMENT TO USE**Soil density : 1 300 kg/m³, cement density : 1 250 kg/m³**WARNING :** the figures in this table do not apply to different densities.

% cement by dry weight	Finished kg/m ² of cement	Units of soil for 1 unit of cement	No. of wheelbarrow cece of soil per bag of cement	Examples of amounts used for bitokwork
4	75	24	16	1/8 sack cement = 31 = 6.25 kg for 2 wheelbarrow loads of soil
5	115	18	11	1/5 sack cement = 81 = 10 kg for 2 wheelbarrow loads of soil (5.4 % cement)
8	150	12	8	1/2 sack cement = 101 = 12.6 kg for 2 wheelbarrow loads of soil
10	190	9 1/2	6 1/2	1/2 sack = 13.5 l = 16.87 kg for 2 wheelbarrow loads of soil (10.7 % cement)
12	225	8	5 1/2	1/5 sack + 1/8 sack = 81 + 6.87 l = 14.87 l = 18.39 kg for 2 wheelbarrow loads

FIGURE**DETERMINING THE APPARENT DRY DENSITY OF A MATERIAL**

A satisfactory result can be obtained by knowing the weight of a litre of dry material. The figures obtained will be in kg/dm³ or in tons/ m³. This requires scales accurate to within 10 to 15 grams, a container for measuring out exactly 1 litre and a way of drying out the material: a drying kiln or oven, or a gas-burner and pan (maximum temperature: 105°C). The material can also be spread out thinly and left to dry in the sun. The result should be accurate to within 50 g/dm³.

Mixing**GENERAL OBSERVATIONS (see also the chapters on SOIL, STABILIZATION and**

EQUIPMENT)

Mixing and preparation are important operations in the manufacture of a block. Obtaining a mix with the optimum moisture content for compaction is crucial to the quality of the product; for example, a 2% difference in moisture content can reduce the density of the block by nearly 100 kg/m³. The cement should be evenly distributed for its effect to be equal throughout the mix. The more homogenous the mix, the more the degree of stabilization can be reduced, i.e. lowering costs without affecting quality. Mixing should be done first dry, if dry materials (cement, sand, gravel) have to be added to the soil, followed by wet mixing, spraying the water on gradually. If water is added too quickly, it will be difficult to mix the dry and wet parts together. This applies both to stabilized and unstabilized blocks.



Pour out the dry materials (earth, sand, gravel, cement).



Begin mixing by turning the soil on the ground using a shovel.



Turn the pile of soil a second time, always digging a vertical trench for the soil to flow into.



Moisten the mix using a watering can.



Turn the pile cross more and continue to pour it's soil onto the top of the pile so that it flows down.

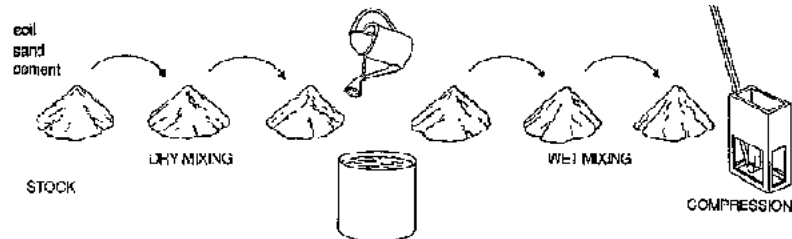

Turn the pile of wet soil a second time, continuing to water if necessary.

HAND MIXING**USING MANUAL MIXING TO MOVE THE MATERIAL ALONG****MANUAL TECHNIQUE**

The best way to proceed is to turn the pile over at least two or three times for the dry mix, and then a further two or three times gradually adding water. It is important to make sure that the shovel scrapes along the ground and picks up soil from the very bottom of the pile, at the same time making a vertical slope down which the soil from the top can flow and thus be mixed in. Soil should be poured from the first pile onto the top of the second pile, also to make it flow down. No more than 1/3 of a sack of cement should be mixed in at a time (see illustration on).

LAYOUT

Turning the soil can be exploited as a way of transporting the soil towards the press. This means locating stocks of dry material 6 or 8 metres from the press end the wafer stocks or supply halfway between the two, i.e. 3 or 4 metres from the stocks of material and the press. This approach ensures that the piles are well turned the required number of times (see sketch on p. 64).

MECHANIZED TECHNIQUES

The principles and objectives of mechanical mixing are identical to those of manual mixing, i.e. it is important to begin with dry mixing for 2 or 3 minutes for materials such as soil, sand, gravel, cement etc. and then to moisten the mix evenly by sprinkling (with a watering can), very fine spraying or vaporising the water. Wet mixing also takes 2 to 3 minutes.

The mixer can be filled using either buckets or measuring boxes which have to be emptied by hand, or using a sloping ramp for wheelbarrow access, or - for large production units - through measuring hoppers.

The formation of lumps of soil during mixing (generally wet mixing) must be avoided as these are difficult to compress. Lumps can form if the moisture content is too high and/or if the mixing time is too long, or again if an inappropriate system of blade-mixing is used. Checking the optimum moisture content (OMC) is crucial. For soils with a high clay content, the moisture content should be slightly higher than the OMC. For sandy soils, it will be slightly lower than the OMC.

TECHNIQUE	OUTPUT	INFRASTRUCTURE	EQUIPMENT
Manual mixing	2 to 3 m ³ /day with 2 workers	Sheltered area, hard and flat, of: 15 to 20 m ² for linear displacement of heap 5 m ² minimum for fixed heap	2 shovels, 1 sprinkler, 1 wheelbarrow and 10 cement 2 to 5 m chairs or measuring box
Manual mixing	Average time for mixing (filling, mixing, emptying): 5 to 8 minutes -> 7.5 to 12 mix./h 2 to 4 workers	Sheltered area Mixer area : 2 m ² Space for moving around : 6 x 6 10 m ² Ramp: 6 to 8 m ² , maximum angle 20 to 25 % Total : 10 to 20 m ² depending on filling method	1 mixer, 1 to 2 shovels or spatulas for cleaning Manual filling of 250 l mixer: 12 buckets, 1 to 2 wheelbarrows, 2 shovels, 1 sprinkler. Filling from ramp: 2 buckets, 2 to 3 wheelbarrows, 2 to 3 shovels, 1 sprinkler
250 l planetary mixer (125 l usable capacity)	7 to 11 m ³ /day		
500 l planetary mixer (250 l usable capacity)	15 to 24 m ³ /day		Mechanized filling : 1 conveyor belt, 1 measuring out system, 1 measuring out hopper

FIGURE

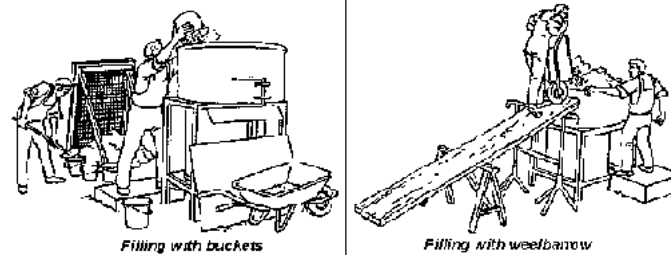

FIGURE

Compressing the blocks

GENERAL OBSERVATIONS (see chapter on EQUIPMENT)

Compression is of course the key operation in the manufacture of CEBs. Nevertheless, the quality of the product will depend heavily on what "goes into" the press (the type of soil and all the preliminary operations: preparation, mixing, retention time, etc.) as well as the way in which the products are going to be treated when they come out of the press (curing, storage, transportation, etc.) The various types and qualities of presses available obviously have some impact, but they are not necessarily crucial to the final result, the CEB.

The outputs suggested below are purely indicative and can vary enormously with different operators.

FILLING

Generally, moulds are designed to be completely filled with the mixed material. The soil therefore has to be scraped level with the sides of the mould. But with certain soils, the mould must not be completely filled, and in these cases the operator can often work "by

eye", or he may be helped by some system for measuring out (a measuring box, a graduated bucket, etc.) There are also automatic mould levelling systems, (using brushes, a roller, a leveller etc.), generally fitted to rotating table presses. Some presses are equipped with an adjustable measuring system, either using sliding valves or tipping boxes. Such systems may be manual or mechanically-driven. If filling takes place from conveyor belts or hoppers connected to the mixer, such adjustable automatic measuring systems are indispensable. When the operator has access to the mould before compression takes place, he should preferably check on the content of the mould and, for example, top up or remove some material (if necessary) or press the soil down into each corner of the mould with his fingers (particularly for low pressure presses), and if necessary remove any stones, lumps or clods of soil (see illustrations below).

COMPRESSING THE BLOCK

If the press is fitted with a lid, it must be correctly positioned and soil must not get trapped in the angle between the mould and the lid as this can cause the lid to be displaced or the compression system to jam.

Some lids also precompress the soil in which case it is not so important to clean off the top of the mould. On the other hand, this type of lid has to be slammed down quite forcefully, taking care that no operator still has his hand in the way.

For manual presses, the force which has to be applied to the compression lever will depend on how much soil there is in the mould. This force should be neither too high nor too low. In the former case the operator will rapidly tire or the machine will be broken and in the latter, the block will be insufficiently compressed.

For motorized presses, the compression force remains uniform. It is therefore impossible to check during compression if the mould has been correctly filled.

TYPE OF PRESS	PRICE RANGE	THEORETICAL OUTPUT (29.5 x 14 x 6 cm blocks)	INFRASTRUCTURE	EQUIPMENT
Manual with low theoretical output	200 to 500 \$	300 to 600 blocks/day with 2 workers (no compression)	Sheltered area, hard and flat, approx. 7 m ²	1 shovel, 1 pair of gloves + cleaning tools (brushes, scrapes, etc.)
Manual with high theoretical output	1 500 to 2 000 \$	700 to 1 500 blocks/day with 3 workers	Sheltered area, hard and flat, approx. 8 to 10 m ²	+ maintenance tools (oil, grease, keys, etc.)
Mobile unit:	25 000 to 80 000 \$	1 000 to 4 000 blocks/day with 2 to 3 workers	Flat area, sheltered if possible 25 to 45 m ²	As above but with more maintenance tools
Motorized with average theoretical output	11 000 to 16 000 \$	1 000 to 2 000 blocks/day with 2 to 3 workers	Sheltered area, hard and flat, approx. 10 to 15 m ²	
Motorized with high theoretical output	20 000 to 80 000 \$	5 000 to 6 000 blocks/day with 3 workers	Sheltered area, hard and flat, approx. 15 to 25 m ²	

FIGURE

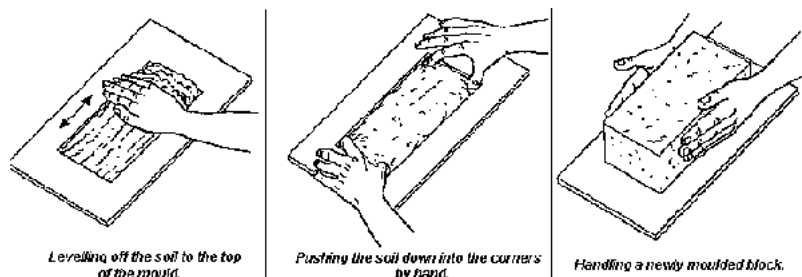

FIGURE

REMOVING THE BLOCK FROM THE MOULD

With simple presses, the same piston both compresses and ejects the block. With more sophisticated presses, there will often be a second piston specifically for ejecting the block. This has the advantage of greater productivity, but the disadvantage of a higher risk of breakdowns or mechanical problems.

Once the block has been ejected, it must be picked up carefully as it is still fragile. The

surface area of contact between the block and the hands should be as large as possible to keep pressure on the block to a minimum. The edges, which are fragile, should not be touched (see sketch on).

For large production units, the block will be ejected onto a moving belt, but here too it will often be picked up by hand at the end of the line. There are block pincers which reduce the risk of damaging the newly moulded block and which also enable one person to carry two blocks at a time.

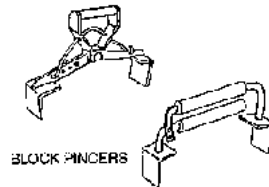

USE OF SPECIAL BLOCKS

Special blocks, as we have seen, have a frog or a perforation allowing one to incorporate structural, or non-structural elements into the walls. They can also serve to make the blocks lighter and to reduce the amount of material used. Depending on the building system, however, the frogs or perforations may be filled with mortar. As the mix used for the mortar will be 1.5 times more stabilized than for the blocks, this could lead to additional costs for cement. Frogs and perforations are also used for decorative purposes (claustra work, etc.).

SPECIAL BLOCKS AND WAYS OF MAKING THEM

The way special blocks are made will depend on the press. If it has interchangeable moulds it will be relatively easy to add all the possible variations. If, on the other hand, there is no possibility of changing moulds, it will nearly always be possible to insert a frog

of the required shape.

Where volumes are modified, in the same direction as the movement of the piston (generally vertical), the shape of the latter should enable the piston to slightly penetrate the mould, which will therefore be perforated.

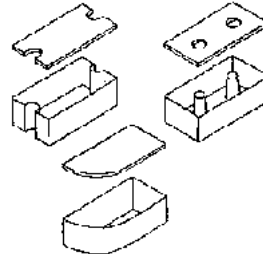

MOULDS AND PISTONS

If the shape of the piston cannot be changed, vertical frogs which do not go the full height of the block can be used and then the superfluous part can be broken through by hand, although this has the disadvantage of leaving an irregularly broken surface.

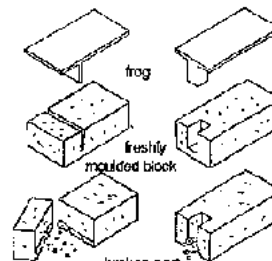

FIGURE

If the change in volume is perpendicular to the movement of the piston (i.e. a horizontal

frog), there will be no difficulty in inserting a frog with good results.

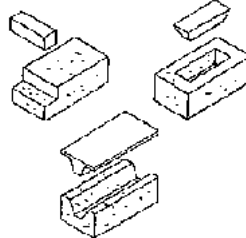

HORIZONTAL VOIDS

MAKING A FROG

Frogs should be strong (from solid wood, solid metal shapes, etc.). They are placed either right inside the mould, or attached to the lid or compression plate, or fixed to a piece of sheet iron placed between the lid and the soil. The sheet iron serves as a guideline and enables frogs to be quickly and precisely located. The sheet iron and the frogs have to conform to the dimensions of the mould, with a little to spare. For example, for a block measuring $29.5 \times 14 \times 9$ cm, the piece of sheet iron will measure 29.1×13.6 and be 1 to 2 mm thick.

MEASURING OUT TO FILL THE MOULD

The mould no longer contains only loose, mixed (compressible) material, but also a compact (non-compressible) foreign body. This means that the compression ratio has to be reduced. This can be done either by adjusting the machine, or by reducing the volume of loose earth being put into the mould.

Some system for measuring out (a graduated bucket, a measuring box, etc.) will save time.

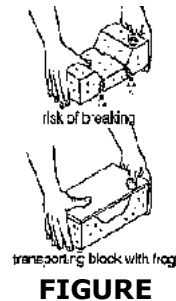
**FIGURE**

TRANSPORTING SPECIAL BLOCKS

The frog or perforation lowers the strength of the block, particularly when it has just been moulded. To prevent weak blocks from breaking, they should be transported with the frog, which should be removed only when the blocks have been stacked for curing. At least two of each of the same shaped frogs will therefore be needed, or production will be slowed down. For strong blocks, these precautions are not necessary (see illustration above).

Curing and drying

GENERAL OBSERVATIONS

Curing conditions and principles have been reviewed in the chapter on **STABILIZATION**. They greatly influence the final quality of the block. Briefly, for very slightly stabilized blocks (< 3 to 4 %), drying should not be allowed to take place too quickly, as this would cause shrinkage cracks. Unstabilized blocks should also be sheltered from direct sun and wind, but not kept in a humid environment. For cement (or lime) stabilized blocks, the presence of water within the block is crucial for the stabilizer to attain its maximum strength. High temperatures will also help in this respect. Not only do the blocks have to be sheltered from direct sun and wind, but they also have to be kept in a hot, humid

environment with the help of tarpaulins or heat-absorbent (black, for example) plastic sheets, which can be sealed off as hermetically as possible. The duration of this humid, hot curing stage will also depend on the climate, but should be not less than 7, and if possible 14, days.

The differences between curing, drying and final storage lie in the way these are carried out, but not necessarily in the way the blocks are placed, unless they are too fragile when newly moulded. For cement-stabilization, complete curing takes 28 days. For lime-stabilization theoretically it takes 6 months (but the blocks can be put into use after maximum 2 months).

SEPARATE STACKING (FOR CURING, DRYING, STORAGE)

If the freshly moulded blocks are fragile, they cannot be stacked very high. A specific area will have to be set aside for wet curing close to the press (3 to 5 m) to reduce handling distance which can damage the blocks. The blocks can be handled after 2 days' curing. The curing areas therefore need to be able to hold the equivalent of 2 days' production.

The first day's blocks will be stacked on half of the area and the second day's on the other half. On the morning of the third day, the first day's blocks are removed to the area set aside for drying in order to make room for stacking the third day's blocks. Similarly, on the morning of the fourth day, the second day's block's are removed, and so on.

Special care must be taken when stacking special blocks which can have serious weak spots.

DIRECT STACKING

If the blocks are strong enough as they come out of the press, they can support being stacked 10 to 15 high. This type of stacking will require transporting straight from the

mould over a greater distance than for separate stacking (10 to 50 m). If the ground is very flat, they can be transported using flat wheelbarrows or on pallets.

TIGHTLY PACKED ON THE GROUND

The ground must be flat and hard or the stacks will not be straight. The blocks are placed either on their lower face, or on their side. For fragile blocks, with separate stacking, blocks should not be stacked more than 5 or 6 high. If they are strong enough, and stacked directly, they can be piled 10 to 15 high. Crisscrossing the blocks between each layer has the advantage of keeping them straight, but may cause depressions which can break the blocks. Small, finger-wide spaces can be left between the piles, which avoids having to slide them together and risk damaging them.

ON LATHS

Placing blocks on laths is used only for blocks which are very fragile when freshly moulded. Laths create spaces between the layers, so that a hand can be slipped between them without spoiling the blocks. The other advantage is the possibility of achieving good stacking even on a ground surface which is not very smooth or flat. The blocks are placed on their sides 3 to 6 high. Disadvantages are that this takes up a large area and uses up a great deal of wood (for the laths).

ON PALLETS

This type of transportation has the advantage of being very easy. Machinery for lifting pallets (pallet transporters, cranes, etc.) can take loads of up to 1.5 tonnes, or the weight of 200 blocks, and piles approximately 5 blocks high. Forklift trucks can take heavier loads.

SPREAD OUT ON THE GROUND

This kind of stacking is suitable only for unstabilized blocks. The blocks are directly stacked on their sides, with spaces between them to allow air circulation, 2 blocks taking up the width of 3. To steady the piles, blocks are crisscrossed but there is no risk of their breaking since the load is reduced.

TYPE OF STOCKAGE	BLOCK LAYOUT	SURFACE AREA FOR 1000 BLOCKS (incl. moving around space)
Seperate stacking (blocks stacked 4 to 5 high)	Closely placked, flat	15 to 18 m ² (wheelbarrow access)
	Closely packed, on sides	12 to 15 m ² (wheelbarrow access)
	On laths	25 to 30 m ² (wheelbarrow access)
Direct stacking (blocks stacked 10 to 17 high)	Closely placked, flat	8 to 10 m ² (wheelbarrow access)
	Closely packed, on sides	9 to 10 m ² (wheelbarrow access)
	On pallets on their sides (blocks stacked 5 high)	15 to 20 m ² (pallet trolley access)
	On pallets flat	15 to 25 m ² (fork-lift truck access)
	With spaced between	12 to 15 m ² (wheelbarrow access)

MEANS OF TRANSPORT	ACCESS CORRIDOR WIDTHS	
Flat bottom wheelbarrow	1 to 1.5 m	Transp Transp 1 000 b
Pallet trolley	3 m	Transp with 2 p
4 ton fork lift truck	5 to 6 m	Transp with d.f
Lorry	3 to 4 m	Transp unloadi Distanc

FIGURE

STOCK MANAGEMENT

Whichever way the blocks are laid out, it is important to be able to count them easily. It should also be easy to find their date of manufacture in order to be able to check on the duration of the curing stages.

Stacks can correspond either to a day's production or to a number which is a convenient multiple (e.g. 500 or 1,000 blocks). The choice will be determined by the space limitations of the production site and the rate of demand for the blocks. In general, stacks equivalent to one day's production take up more space than stacks of a convenient number. But if demand for the blocks is high, they must be usable as soon as the curing stage is over, in which case, stacking by day's production is preferable.

Note: data refers to 29.5 × 14 × 9 cm blocks.

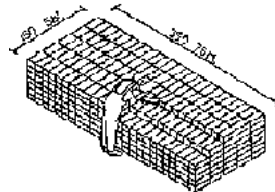

Tightly packed blocks, placed on their lower face

Separate and direct stacking

Ground surface area: 5.25 m² - 125 blocks per layer.

First stage curing: 500 blocks stacks, 38 cm. high, i.e. 4 blocks high, tarpaulin covered area 4m².

Second stage curing: 2000 block stacks, 1.52 cm high, i.e. 16 blocks high, tarpaulin covered area 17m².

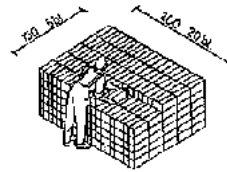

Tightly packed blocks, placed on their sides

Separate and direct stacking

Ground surface area: 3 m² - 100 blocks per layer.

First stage curing: 500 blocks stacks, 0.7 m. high, i.e. 5 blocks high, tarpaulin covered area 11m².

Second stage curing: 1000 block stacks, 1.4 cm high, i.e. 10 blocks high, tarpaulin covered area 16m².

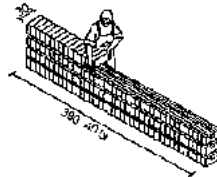

Blocks on laths, placed on their sides

Separate stacking (fragile blocks)

Ground surface area: 1.1 m² - 40 blocks per layer.

First stage curing (only): 200 blocks stacks, 0.86 m. high, i.e. 5 blocks plus lath, tarpaulin covered area 9.5 m², 38 m. of 4 × 4 laths

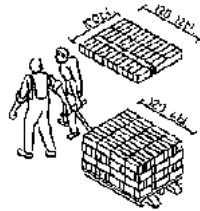

Blocks on pallets, placed on their sides

Direct stacking

Ground surface area: 1.2 m² - 40 blocks per layer.

First stage curing: 200 blocks stacks, 0.85 m. high, i.e. 5 blocks high + pallet, tarpaulin covered area 6.6 m².

The pallets must be strong and easy to slide onto the transporter.

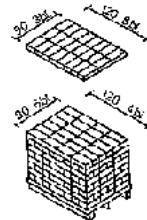

Blocks on pallets, placed on their lower faces

Direct stacking using a 3-ton fork-lift truck

Ground surface area: 1.2 m² - 24 blocks per layer (7th layer only 16 blocks).

400 blocks stacks (3 tons), 0.75 m. high, i.e. 17 blocks high + pallet, tarpaulin covered

area 11 m².

The pallets must be strong and easy to slide onto the transporter.

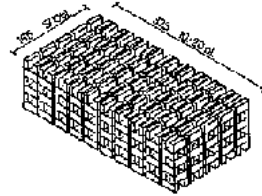

Widely spaced blocks, placed on their sides

Direct stacking, unstabilized blocks

Ground surface area: 5.4 m² - 100 blocks per layer.

1000 blocks stacks, 0.4 m. high, i.e. 10 blocks high, tarpaulin or mat covered area (to provide shelter from direct sun and wind) 10 m² (1.7 × 6 m).

