

Dynamically-compacted cement stabilised  
soil blocks for low-cost walling

By

David Edward Montgomery

Submitted for the degree of

Doctor of Philosophy in Engineering

University of Warwick, School of Engineering

January 2002

## Dedication

Sometimes at the beginning of a publication one finds a dedication to a certain person or member of the family who has been an influence in the author's life either in general or specifically in generating the work in question. There is one person in my life that immediately springs to mind that is worthy of such a dedication. Furthermore, my experience with this person is not unique as millions of others have found him to be a great inspiration, comfort, guide and friend. "What's his name?" you may be asking yourself and, "Why haven't I heard of this incredibly influential person?" You most probably have but you have never accepted him as such, or welcomed him into your heart and life. Well, now you have an opportunity to do just that. Please read on.

For years the name Jesus was just an everyday swearword to me. The historical individual did not mean anything to me and religion seemed hypocritical, oppressive and irrelevant to modern life. However, during my late teens I was given opportunities to live life to the full and experience many different things. Yet I still seemed unsatisfied and kept searching for something else. I was invited to a Christian gathering at university where I heard about the love of God and Jesus being God's only Son sent into the world to die for the sins of the world. I was told about an individual who had the power to forgive sins and transform lives. He also wanted to forgive my sins and change me into a child of God. That night I welcomed Jesus Christ into my heart and life and accepted Him as my saviour. Jesus suddenly became a real living person in my life and through the Bible He has helped and guided me through life. Trusting in Him was the best thing I ever did, and I cannot recommend Him more highly to anyone. Man has gone a long way away from God, but He still loves us and commands us to return to Him for forgiveness, reconciliation with Himself and rich blessings in this life and throughout eternity. The Lord Jesus Christ is still searching for people willing to trust Him in simple faith, will you be one of those people today? Please ponder the verses below and thank you for taking the time to read this.

David E. Montgomery

*"For God so loved the world, that he gave his only begotten Son, that whosoever believes in him should not perish, but have everlasting life."* John 3:16.

*"For the Son of man is come to seek and to save that which was lost."* Luke 19:10

*"And the times of this ignorance God winked at; but now commands all men every where to repent."* Acts 17:30

*"For whosoever shall call upon the name of the Lord shall be saved."* Romans 10:13

*"For by grace are ye saved through faith; and that not of yourselves: it is the gift of God: not of works, lest any man should boast."* Ephesians 2:8,9.

*"Jesus saith unto him, I am the way, the truth, and the life: no man cometh unto the Father, but by me."* John 14:6.

## Table of Contents

---

<b>DEDICATION</b> .....	<b>2</b>
<b>TABLE OF CONTENTS</b> .....	<b>3</b>
<b>LIST OF FIGURES</b> .....	<b>6</b>
<b>LIST OF TABLES</b> .....	<b>7</b>
<b>ACKNOWLEDGEMENTS</b> .....	<b>8</b>
<b>DECLARATION</b> .....	<b>8</b>
<b>SUMMARY</b> .....	<b>9</b>
<b>ABBREVIATIONS</b> .....	<b>10</b>
<b>GLOSSARY OF TERMS USED</b> .....	<b>10</b>
<b>1 INTRODUCTION</b> .....	<b>12</b>
1.1 JUSTIFICATION FOR THIS WORK .....	12
1.2 SOME NOTES ON THIS THESIS.....	14
<b>2 LITERATURE REVIEW</b> .....	<b>16</b>
2.1 AN INTRODUCTION TO BRICK AND BLOCK MANUFACTURE.....	16
2.1.1 <i>Existing processes described</i> .....	17
2.1.2 <i>Processes analysed for sustainability</i> .....	23
2.2 RAW MATERIAL SELECTION AND CHARACTERISTICS .....	27
2.2.1 <i>Properties and analysis of soil</i> .....	28
2.2.2 <i>Basics of cement usage</i> .....	31
2.3 SOIL STABILISATION .....	34
2.3.1 <i>Cement addition</i> .....	35
2.3.2 <i>Compaction of material</i> .....	37
2.3.3 <i>Current role of stabilisation and its possible extension</i> .....	40
2.4 DYNAMIC COMPACTION RESEARCH.....	44
2.4.1 <i>Conceptual Research</i> .....	45
2.4.2 <i>Compaction optimisation of confined soil samples</i> .....	48
2.4.3 <i>Application of impact to block compaction</i> .....	52
2.5 CHAPTER SUMMARY .....	54
<b>3 PRELIMINARY EXPERIMENTS WITH STABILISED SOIL</b> .....	<b>57</b>
3.1 SUMMARY OF INPUT VARIABLES AND OUTPUT MEASURES .....	57
3.1.1 <i>Input variables</i> .....	59
3.1.2 <i>Output measures</i> .....	63
3.2 EXPERIMENTS EMPLOYING FULL-SIZE BLOCKS OF SOIL-A .....	65
3.2.1 <i>The effects of moisture on strength</i> .....	65
3.2.2 <i>Moisture content effects on penetration resistance</i> .....	67
3.3 EXPERIMENTS EMPLOYING SMALL CYLINDERS OF SOIL-B.....	70
3.3.1 <i>Pressure density relationship</i> .....	71
3.3.2 <i>Assessment of de-moulding forces</i> .....	75
3.3.3 <i>Strength variation in cylindrical samples</i> .....	77

3.4	BLOCK CHARACTERISTICS THAT HELP TO REDUCE CONSTRUCTION COSTS.....	80
3.4.1	<i>Material reduction</i> .....	80
3.4.2	<i>Tall thin blocks</i> .....	82
3.4.3	<i>Cement rich skin</i> .....	84
3.4.4	<i>Summary of cost reduction methods</i> .....	85
3.5	CHAPTER SUMMARY .....	87
<b>4</b>	<b>DYNAMIC COMPACTION OF STABILISED SOIL .....</b>	<b>89</b>
4.1	EXPERIMENTAL DESIGN.....	89
4.1.1	<i>Sample size selection</i> .....	89
4.1.2	<i>Primary measure of performance is P.D.D.</i> .....	93
4.2	VARIABLES OF DYNAMIC COMPACTION .....	95
4.2.1	<i>Indirect and direct impact</i> .....	97
4.2.2	<i>Foundational effects</i> .....	98
4.2.3	<i>Delay between impacts</i> .....	99
4.2.4	<i>Mould wall thickness</i> .....	101
4.3	SMALL CYLINDER PRODUCTION VIA DYNAMIC COMPACTION .....	103
4.3.1	<i>Energy and momentum transfer</i> .....	104
4.3.2	<i>Strength vs. density</i> .....	106
4.4	FULL-SIZE BLOCK PRODUCTION VIA DYNAMIC COMPACTION .....	108
4.4.1	<i>Compaction curve for dynamic compaction</i> .....	108
4.4.2	<i>Different moisture contents</i> .....	110
4.4.3	<i>Block characteristics</i> .....	113
4.4.4	<i>Block variants</i> .....	117
4.5	COMPARISON OF DYNAMIC AND QUASI-STATIC CONSOLIDATION .....	121
4.5.1	<i>Achieved density for same energy transfer</i> .....	121
4.5.2	<i>Ejection force</i> .....	123
4.5.3	<i>Machine cost and complexity</i> .....	124
4.5.4	<i>Other beneficial block characteristics</i> .....	125
4.6	CHAPTER SUMMARY .....	126
<b>5</b>	<b>IMPACT MECHANISM.....</b>	<b>129</b>
5.1	MODELS OF COMPACTION .....	129
5.1.1	<i>Force distribution during compaction, .....</i>	130
5.1.2	<i>Particle-particle interaction</i> .....	133
5.1.3	<i>Air/water dismissal</i> .....	135
5.1.4	<i>Theoretical models for impactor trajectory during impact</i> .....	137
5.2	EXPERIMENTAL MEASUREMENT OF IMPACT .....	140
5.2.1	<i>Impactor position, velocity and acceleration</i> .....	143
5.2.2	<i>Changing material properties during compaction</i> .....	149
5.2.3	<i>Maximum acceleration experienced by impactor</i> .....	152
5.2.4	<i>Losses in the system</i> .....	153
5.2.5	<i>Assessment of forces for machine design</i> .....	156
<b>6</b>	<b>MACHINE DESIGN AND DEVELOPMENT .....</b>	<b>159</b>
6.1	APPROACH TO A PRODUCTION MACHINE .....	159
6.1.1	<i>Design for ease of manufacture</i> .....	160
6.1.2	<i>Design for ease of use</i> .....	161
6.1.3	<i>Confirming the block specifications</i> .....	162
6.2	INTERFACING DYNAMIC COMPACTION WITH MACHINE DESIGN .....	163
6.2.1	<i>Optimisation of energy transfer</i> .....	163
6.2.2	<i>Improved impactor constraint</i> .....	166
6.2.3	<i>Ergonomics and productivity</i> .....	168
6.3	DESIGN OF THE MOULD .....	169
6.3.1	<i>Confirming mould stiffness and strength calculations</i> .....	170
6.3.2	<i>Further mould design developments</i> .....	172
6.4	PROTOTYPE MODEL EXPLORATION AND DESIGN SELECTION .....	177
6.5	PRODUCTION GUIDELINES .....	183
6.5.1	<i>Machine foundation selection</i> .....	184

6.5.2	<i>Block production instructions</i> .....	185
<b>7</b>	<b>TECHNOLOGICAL DISSEMINATION AND FIELD TRIALS</b> .....	<b>187</b>
7.1	OVERSEAS COLLABORATION .....	187
7.2	EXPERIENCE WITH MACHINE .....	189
7.3	MACHINE ASSESSMENT AND BLOCK ANALYSIS .....	192
7.3.1	<i>The testing procedure</i> .....	192
7.3.2	<i>Initial machine comparison</i> .....	194
7.3.3	<i>Further block production and testing</i> .....	196
7.4	DISSEMINATION OVERVIEW .....	202
<b>8</b>	<b>COMMERCIALISATION AND FEASIBILITY STUDY OF IMPACTED BLOCKS</b> .....	<b>205</b>
8.1	MACHINE ANALYSIS AND COMPARISON .....	205
8.2	MATERIAL ANALYSIS FOR PERFORMANCE .....	208
8.3	FEASIBILITY STUDY .....	211
<b>9</b>	<b>CONCLUSIONS AND RECOMMENDATIONS</b> .....	<b>213</b>
9.1	ACCEPTABILITY AND POTENTIAL OF CSSB .....	213
9.2	PERFORMANCE OF DYNAMIC COMPACTION .....	215
9.3	ANALYSIS OF IMPACT COMPACTION .....	218
9.4	FEASIBILITY STUDY OF DYNAMICALLY COMPACTED CSSB .....	221
	<b>BIBLIOGRAPHY</b> .....	<b>224</b>
	<b>APPENDICES</b> .....	<b>232</b>
	APPENDIX A - ANALYSIS AND PRODUCTION OF SOILS USED .....	232
	APPENDIX B - PHOTOGRAPHS .....	235
	APPENDIX C - TEST RIG DESIGN.....	239
	APPENDIX D - MACHINE DRAWINGS .....	241
	APPENDIX E - MATERIAL CALCULATIONS – CEMENT MINIMISATION .....	251
	APPENDIX F - NUMERICAL RESULTS OF SMALL SCALE TESTS .....	257
	APPENDIX G - NUMERICAL RESULTS OF FULL SIZE BLOCKS.....	263
	APPENDIX H - FIELD TRIAL RESULTS.....	265
	APPENDIX I - INDENTATION TESTER DESIGN .....	280

---

## List of Figures

FIGURE 2.1 – AERATED CONCRETE BLOCKS.....	18
FIGURE 2.2 – CLAMP FIRED BRICKS .....	21
FIGURE 2.3 – COMPRESSED AND STABILISED SOIL BLOCKS (CSSB) .....	22
FIGURE 2.4 – INTERLOCKING CSSB.....	22
FIGURE 2.5 – CHARACTERISTICS OF CSSB EXPANSION.....	30
FIGURE 2.6 – SKETCH OF CRYSTALLINE CEMENT GROWTH IN SANDCRETE .....	32
FIGURE 2.7 – FLOW CHART OF THE CEMENT HARDENING PROCESS .....	32
FIGURE 2.8 – COMPRESSIVE STRENGTH OF CONCRETE WITH DIFFERENT WATER-CEMENT RATIOS.....	33
FIGURE 2.9 – UNCONFINED, SEMI-CONFINED AND CONFINED COMPACTION .....	37
FIGURE 2.10 – DIAGRAM OF PARTICLE INTIMACY AROUND THE O.M.C. ....	38
FIGURE 2.11 – O.M.C. FOR SOIL AT DIFFERENT COMPACTION ENERGIES.....	38
FIGURE 2.12 – RELATIONSHIP BETWEEN CEMENT CONTENT, COMPRESSION PRESSURE AND 7-DAY WET COMPRESSION STRENGTH.....	39
FIGURE 2.13 – RELATIONSHIP BETWEEN BULK DENSITY AND 7-DAY WET COMPRESSION STRENGTH FOR DIFFERENT CEMENT CONTENTS.....	39
FIGURE 2.14 – CSSB PRODUCTION YARD SHOWING POOR CURING PRACTICE .....	41
FIGURE 2.15 – COMPARISON OF MACHINE COST AND CEMENT REQUIREMENT .....	43
FIGURE 2.16 – CIVIL ENGINEERING COMPACTION EQUIPMENT USING IMPACT .....	46
FIGURE 3.1 – STRENGTH, BULK DENSITY AND P.D.D. VARIATION WITH MOISTURE CONTENT .....	66
FIGURE 3.2 – STRENGTH AGAINST P.D.D. FOR FULL-SIZE BLOCKS .....	67
FIGURE 3.3 – PENETROMETER SITES ON A FINISHED BLOCK .....	68
FIGURE 3.4 – P.D.D. AND PENETRATION RESISTANCE VARIATION WITH MOISTURE CONTENT. ....	69
FIGURE 3.5 – PRESSURE DENSITY RELATIONSHIP FOR SOIL-B.....	72
FIGURE 3.6 – RESULTS OF COMPRESSION TESTS ON SOIL-B AT 6% M.C. ....	73
FIGURE 3.7 – STRENGTH DENSITY RELATIONSHIP FOR SOIL-B AT 6% M.C.....	74
FIGURE 3.8 – INTER-RELATIONSHIPS OF PRESSURE AND WATER CONTENT WITH OUTPUTS .....	74
FIGURE 3.9 – EJECTION FORCE ANALYSIS FOR DIFFERENT COMPRESSION FORCES .....	76
FIGURE 3.10 – STATISTICAL TEST FOR DIFFERENCE BETWEEN TWO DATA SETS .....	78
FIGURE 3.11 – REVISED INTER-RELATIONSHIPS BETWEEN PRESSURE AND WATER WITH OUTPUTS .....	87
FIGURE 4.1 – SIX BLOCK HEIGHT MEASURING POINTS .....	94
FIGURE 4.2 – ANALYSIS OF DIRECT AND INDIRECT COMPACTION .....	98
FIGURE 4.3 – MOULD WALL THICKNESS EXPERIMENT RESULTS .....	102
FIGURE 4.4 – ENERGY DENSITY RELATIONSHIP FOR SMALL CYLINDERS OF SOIL-B .....	104
FIGURE 4.5 – OPTIMISATION OF MOMENTUM TRANSFER FOR SMALL CYLINDERS .....	105
FIGURE 4.6 – DENSITY STRENGTH RELATIONSHIP FOR DYNAMICALLY COMPACTED CYLINDERS .....	107
FIGURE 4.7 – 95% CONFIDENCE LINES FOR DENSITY/STRENGTH RELATIONSHIP FOR CYLINDERS .....	107
FIGURE 4.8 – COMPACTION CURVES FOR BLOCKS AT 6% MOISTURE.....	109
FIGURE 4.9 – COMPACTION CURVES OF BLOCKS AT DIFFERENT MOISTURE CONTENTS .....	111
FIGURE 4.10 – COMPACTION CURVES FOR DIFFERENT IMPACTORS.....	112
FIGURE 4.11 – STRENGTH RESULTS FOR DYNAMICALLY COMPACTED BLOCKS .....	114
FIGURE 4.12 – 95% CONFIDENCE LINES FOR DENSITY/STRENGTH RELATIONSHIP FOR SOIL-B .....	114
FIGURE 4.13 – HEIGHT VARIATION OF DYNAMICALLY COMPACTED BLOCKS .....	116
FIGURE 4.14 – INDENTATION RESULTS FROM TESTS ON CURED BLOCKS .....	117
FIGURE 4.15 – SKETCH OF INDENTATION RESULTS ON FLANGES OF HOLLOW BLOCKS .....	119
FIGURE 4.16 – COMPARISON OF ENERGY TRANSFER FOR SMALL CYLINDER PRODUCTION .....	122
FIGURE 4.17 – COMPARING EJECTION FORCE FOR DYNAMIC AND QUASI-STATIC COMPACTION .....	123
FIGURE 5.1 – COMPRESSION WAVE PROPAGATION DURING COMPACTION .....	131
FIGURE 5.2 – THEORETICAL DISPLACEMENT ANALYSIS OF IMPACTOR.....	139
FIGURE 5.3 – DIAGRAM OF SENSOR POSITION FOR IMPACTOR ANALYSIS .....	142
FIGURE 5.4 – SIGNAL TRACES FROM ROTARY TRANSDUCER AND ACCELEROMETER DURING IMPACT ...	144
FIGURE 5.5 – GRAPHICAL REPRESENTATION OF IMPACTOR DISPLACEMENT .....	145
FIGURE 5.6 – CLOSE UP OF IMPACT POINT .....	146
FIGURE 5.7 – IMPACTOR POSITION ANALYSIS FOR COMPLETE BLOCK PRODUCTION .....	148
FIGURE 5.8 – HYSTERESIS EFFECTS ON COMPRESSION OF FULL-SIZE BLOCKS.....	155
FIGURE 6.1 – IMPACTOR CONSTRAINT DIAGRAM.....	167

FIGURE 6.2 – MOULD DEFLECTION UNDER 1MPA PRESSURE .....	172
FIGURE 6.3 – PLAN VIEW OF THE TWO-PART MOULD DESIGN.....	173
FIGURE 6.4 – PHOTOGRAPH OF THE FINISHED FRONT HALF OF THE MOULD .....	173
FIGURE 6.5 – PROPOSED MOULD DESIGN FOR IMPROVED BLOCK REMOVAL SHOWN IN END ELEVATION.....	175
FIGURE 6.6A – CAD MODEL OF THE MOULD .....	182
FIGURE 6.6B – CAD MODEL OF THE FINAL DESIGN .....	182
FIGURE 6.6C – CAD MODEL OF THE MOULD SAFETY MECHANISM .....	183
FIGURE 7.1 – TAPERED MOULD DESIGN WITH EJECTION MECHANISM (PLAN VIEW) .....	191
FIGURE 7.2 – MODIFIED LIFTING MECHANISM FOR THE IMPACTOR .....	191
FIGURE 7.3 – INITIAL RESULTS FOR COMPARING BLOCK MACHINES .....	195
FIGURE 7.4 – OMC ANALYSIS OF TWO MACHINES .....	196
FIGURE 8.1 – RE ASSESSMENT OF CSSB MACHINES USING RECENT DATA.....	208
FIGURE 8.2 – BLOCK STRENGTH USING DIFFERENT MACHINES AND CEMENT CONTENTS .....	209

## List of Tables

TABLE 2.1 – COMPARISON OF DIFFERENT WALLING MATERIALS .....	25
TABLE 2.2 – CEMENT TO SOIL RATIO FOR DIFFERENT SOILS OF KNOWN LINEAR SHRINKAGE .....	36
TABLE 2.3 – SUMMARY OF RESULTS OF DYNAMIC COMPACTION CONDUCTED IN 1997 .....	52
TABLE 2.4 – ANALYSIS OF FORCES FROM DYNAMIC COMPACTION CONDUCTED IN 1997.....	53
TABLE 3.1 – PENETROMETER RESULTS FROM BREPAK BLOCKS .....	69
TABLE 3.2 – SUMMARY OF DATA FOR COMPRESSED SMALL CYLINDERS AT DIFFERENT PRESSURES .....	75
TABLE 3.3A – P.D.D. VARIATION IN CYLINDRICAL SAMPLES COMPRESSED TO 10MPA .....	79
TABLE 3.3B – 7-DAY W.C.S. VARIATION IN CYLINDRICAL SAMPLES COMPRESSED TO 10MPA.....	79
TABLE 3.3C – EJECTION FORCE VARIATION IN CYLINDRICAL SAMPLES COMPRESSED TO 10MPA.....	79
TABLE 3.4 – ASSESSING THE FAILURE FORCE FOR DIFFERENT BLOCKS.....	84
TABLE 3.5 – THEORETICAL COMPARISON OF DIFFERENT CSSB VARIANTS .....	86
TABLE 4.1A – P.D.D. VARIATION IN DYNAMICALLY COMPACTED CYLINDRICAL SAMPLES .....	90
TABLE 4.1B – 7-DAY W.C.S. VARIATION IN DYNAMICALLY COMPACTED CYLINDRICAL SAMPLES.....	91
TABLE 4.1C – EJECTION FORCE VARIATION IN DYNAMICALLY COMPACTED CYLINDRICAL SAMPLES .....	91
TABLE 4.2 – VARIATION IN P.D.D. FOR FULL-SIZE BLOCKS .....	93
TABLE 4.3 – STATISTICAL VARIATION IN FULL-SIZE BLOCK PRODUCTION.....	101
TABLE 4.4 – CHARACTERISTICS OF HOLLOW BLOCKS .....	118
TABLE 5.1 – EXTRAPOLATION OF COMPACTION FORCES .....	157
TABLE 6.1 – SMALL CYLINDER PRODUCTION USING CONSTANT ENERGY TRANSFER .....	164
TABLE 6.2 – SHEAR FRICTION STRESS SUMMARY FOR DIFFERENT COMPRESSION MACHINES.....	176
TABLE 6.3 – SUMMARY OF FEATURES OF DIFFERENT PROTOTYPE MODELS .....	180
TABLE 7.1 – DENSITY AND INDENTATION RESULTS OF BLOCK IMPACTERRE BLOCKS .....	197
TABLE 7.2 – DENSITY AND INDENTATION RESULTS OF HYDRAFORM BLOCKS .....	198
TABLE 7.3 – STRENGTH ANALYSIS OF BLOCKS PRODUCED BY DIFFERENT MACHINES.....	200
TABLE 8.1 – MACHINE COMPARISON .....	206
TABLE 8.2 – COMPARISON OF CSSB WALLING MATERIAL FROM DIFFERENT MACHINES .....	210
TABLE 8.3 – PROJECTED COSTS OF WALLING FOR MACHINES DURING LIFETIME.....	211

## **Acknowledgements**

My sincerest and deepest thanks goes to my supervisor Dr. Terry Thomas, without whose unending support and guidance I would not have completed this work.

The academic and technical staff at the University of Warwick have been a great help in this research and their skills and commitment have helped to make the project forthcoming and successful.

I would also wish to thank my late mother, Elizabeth, who has been an inspiration and a challenge particularly with respect to her writing skills that were executed with a high degree of professionalism and creativity. Thanks also goes to my wife Rachel for her patience and longsuffering throughout the progress of the PhD.

## **Declaration**

I, David E. Montgomery, hereby declare that this thesis reports previously unpublished work that I have personally done during the three-year PhD programme at the University of Warwick.



## Summary

This document contains the detailed results and conclusions of work carried out during a PhD to investigate the process, production and performance of dynamically compacted cement-stabilised soil blocks suitable for sustainable low-cost building. An earlier project carried out by the author demonstrated that full-size blocks could be manufactured by dynamic compaction. It was hoped that this technique could be applied to the self-evident need for low-cost housing in the humid tropics. The apparent advantages of this process, over quasi-static compression (slow steady squeezing), have led to further investigation into the critical factors influencing the production of such building units.

Initial tests on small cylindrical samples produced by both quasi-static compression and dynamic compaction provided a means of comparison and helped to develop relationships between dominant variables. These tests showed that the moisture content of the compact was a critical variable, influencing its consolidation and its final cured strength. Optimisation studies were undertaken to determine acceptable parameters for impactor mass, drop height and number of applied blows. These chosen parameters were then extrapolated to full-size block production with the necessary adjustments for practicality and cost. Full-size block production using the Test Rig indicated similar relationships as those discovered at the smaller scale, including the more effective consolidation offered by dynamic compaction. From this experience a production prototype was designed and disseminated to a collaborator in India for further trials and feasibility studies. These trials demonstrated that dynamic compaction could produce blocks with a 7-day wet compressive strength of between 3-5MPa with only 5% cement. Feasibility studies there indicate dynamic compaction offers potential savings of 40% compared with local high-tech CSSB manufacture.

The dynamic compaction mechanism was more closely analysed to determine the forces delivered during the impact blow. These were found to be fraction (30kN) of the force delivered by an equivalent hydraulic press (400kN). This results in less complex and less expensive machine manufacture that is amenable to local manufacture and maintenance. Furthermore, dynamic compaction presents an economically viable and sustainable alternative to other methods of block manufacture.

## Abbreviations

- BS:** British Standard  
**CEB:** Compressed Earth Block  
**C. of V.:** Coefficient of Variation (estimate of population unless otherwise stated)  
**CSSB:** Cement Stabilised Soil Block  
**M.C.:** Moisture Content  
**O.M.C.:** Optimum Moisture Content  
**P.D.D.:** Projected Dry Density  
**Pop'n:** Population  
**S.T.P.:** Standard Temperature and Pressure  
**S.D.:** Standard Deviation (estimate of population unless otherwise stated)  
**W.C.S.:** Wet Compressive Strength

## Glossary of terms used

- Aggregate:** Pieces of crushed stone, gravel, etc. used in making concrete.  
**Block:** A larger type of brick not necessarily made of fired clay, but stabilised in some way, sometimes with central cores removed to reduce the weight.  
**Brick:** An object (usually of fired clay) used in construction, usually of rectangular shape, whose largest dimension does not exceed 300mm.  
**Bulk Density:** Density calculated including any moisture present in the material.  
**Cement:** Ordinary Portland Cement (OPC).  
**Clay:** The finest of the particles found in soil, usually of less than 0.002mm in size and possesses significant cohesive properties.  
**Concrete:** The finished form of a mixture of cement, sand, aggregate and water.  
**Dynamic Compaction:** A process that densifies soil by applying a series of impact blows to it.  
**Fines:** General category of silts and clays.  
**Frog:** A tapered addition to a block mould to create a void in the finished block.  
**Gravel:** A mixture of rock particles ranging from 2mm to 60 mm in diameter.  
**Green:** Describing the state of material containing cement and water before it reaches the critical time, after which further plastic deformation hinders the final set strength.  
**Green Density:** The density calculated immediately after ejection prior to any curing, drying or soaking.  
**Green Strength:** The strength of a material immediately after forming and before any drying or curing has taken place.  
**Impactor:** Solid object of known mass that is repeatedly dropped onto the surface of the soil within a mould.  
**Mortar:** The sand/cement mix used to join block courses.  
**Projected Dry Density:** The calculated density at ejection assuming no moisture is present in the formed sample, only solid matter.  
**Permeability:** Describing a material that permits a liquid or gaseous substance to travel through the material.

**Porosity:** A measure of the void volume as a percentage of the total material volume.

**Render:** The sand/cement mix used to cover and protect walling.

**Sand:** A mixture of rock particles ranging from 0.06mm to 2 mm in diameter.

**Silt:** Moderately fine particles of rock from 0.002mm to 0.06mm in size.

**Soil:** Material found on the surface of the earth not bigger than 20mm in size, not including rocks and boulders and predominantly non-organic. If soil is to be used for building material it must not contain any organic material and it can be a natural selection of particles or a mixture of different soils to attain a more suitable particle distribution.

**Stabilised soil:** Soil which has been stabilised (treated to improve structural characteristics) by using one or more of the following stabilisation techniques: mechanical, chemical and physical.

## **1 Introduction**

This is a short chapter that briefly outlines the motivation for this work, and explains why research in this area is of interest to us. This is done by broadly outlining the problem of housing shortage specifically in developing countries. The final section outlines the structure of this thesis and informs the reader of certain conventions used throughout.

### ***1.1 Justification for this work***

There is a self-evident need for adequate and durable housing, especially in the urban and peri-urban areas of developing countries. The poor are most adversely affected by this housing shortage. Assuming land availability and planning permission for further development, the need is to deliver more durable housing at lower cost.

The cost of a dwelling can be split into a number of separate areas as follows:

1. Initial land survey
2. Land preparation on paper – division into plots with access, (needs approval)
3. Physical preparation of ground – clearing vegetation, debris, boulders, etc.
4. Installation of services (optional) – water, sewerage, electricity and telephone
5. Purchase of the plot – cost direct to the homebuilder
6. House erection – foundations and walling (entailing materials and labour)
7. Roofing – spanning beams and roof material
8. Openings – windows and doors with fittings

9. Services – connection up to services if available, (optional, may require approval)

Items 6 to 8 constitute the most significant part of the total cost of the dwelling. Furthermore, the walling constitutes the most significant part of the physical structure, 60% according to (Agevi, 1999). From this it makes sense to concentrate work on low-cost walling. Research recently conducted at Warwick University has indicated that dynamic compaction may provide a method of improving the performance of stabilised soil blocks for walling and at reduced cost.

A further motivation for research into stabilised soil blocks is their environmental sustainability. Cement Stabilised Soil Blocks (CSSB) use low quantities of cement, locally available soil and have a low energy requirement. Currently popular alternatives such as clamp fired brick and concrete blocks do not have these advantages. Environmentally unsustainable practices are also sometimes used in their production such as burning firewood and dredging river sand, (Agevi, 1999), (Mbumbia et al., 2000).

Earth construction is very successful in arid areas, but significant stabilisation is required for adequate performance in humid areas. Unfortunately poor production practises of CSSB have resulted in a chequered history and a limited following (International Labour Office, 1987). Research conducted at Warwick by Kerali indicated that a six-fold increase in wet compressive strength could be achieved using improved curing regimes for CSSB, (Kerali, 2001). With good production control CSSB can perform quite adequately, but further improvements in material performance will help to outweigh sloppy production practices.

CSSB block presses have been designed and used for self-build initiatives in the past, for example, the Cinva-Ram (manual block press) and the Brepak (hydraulically assisted block press). These presses require high quantities of cement for adequate performance or are too expensive and complex for local production and maintenance. A less expensive and less complex machine would be more amenable to local production and small-scale capital investment. These are the areas where CSSB production technology needs to be taken and dynamic compaction shows promise.

## ***1.2 Some notes on this thesis***

This thesis is designed to report the academic findings from the research carried out during this Ph.D. project. Its function is also to present the information to an examining body for assessment for awarding the degree of Doctor of Philosophy to the author. The thesis has been written to reflect the chronological order of events with a minimum of forward and backward referencing of the different chapters.

The thesis is divided up into 9 chapters and each chapter contains a number of sections and further subsections. These three hierarchical levels are identified by numbers and break down the majority of the text into manageable portions. A further fourth level identified by bold italics is not numbered. Most chapters finish with a chapter summary.

After this introduction comes the literature review in chapter 2. Experimentation on quasi-static and dynamic compaction is described in chapters 3 and 4. The analysis of dynamic compaction is then reported in chapter 5. Chapter 6 was a difficult chapter to fit in chronologically, as it includes design analysis used in the production of the Test Rig. This was used to gain the data presented in chapters 4 and 5. However, this also includes the design suggestions and modifications for the Production Prototype. Chapter 7 details the overseas collaboration and technological dissemination of the Production Prototype, comparing the new machine with existing machines. An economic analysis and feasibility study for the Production Prototype is presented in Chapter 8. Finally chapter 9 summarises the conclusions made throughout the thesis and makes recommendations for further research to be conducted.

Data is presented in three different formats in this thesis. Graphs are used to show trends and to highlight possible relationships. Tables are used to present statistical analysis of the data collected. These two formats appear in the body of the text as close to their point of reference as possible, but not necessarily on the same page. Raw numerical data is recorded in the appendix for cross-referencing if necessary.

## **2 Literature review**

Our having stated the need for low-cost housing in the previous chapter, this chapter of the thesis provides the background to the subject of interest. It will outline some of the existing practices and methodology for brick and block manufacture and analyse them for sustainability. Having established the potential contenders, a summary of raw material selection and characteristics will be given. Existing techniques of stabilisation will be reviewed and suggestions made for areas of possible improvement. Finally the previous research conducted on dynamic compaction will be outlined identifying the gaps in understanding and scope for further research.

### ***2.1 An introduction to brick and block manufacture***

Many different materials are used around the world for walling. Where quarried stone and timber are not readily available, earth is the most common material used. Earthen architecture has been used for centuries in many different parts of the world. (Houben & Guillaud, 1994) states: “Thirty percent of the world’s population, or nearly 1,500,000,000 human beings, live in a home of unbaked earth.” Accounts from the Bible (Exodus 1:11-14, 5:6,7) indicate that around 1500BC earth mixed with straw was a typical building material. Earlier accounts from the Bible (Genesis 11:3) also speak of burning bricks and using slime as mortar. Archaeological evidence in very dry areas have also shown that earth building was a highly popular material for



dwelling construction. Earth is still used today in many parts of the world where access to other forms of building material is restricted by location or by cost.

Each building material has its own advantages and disadvantages. Some of the problems with existing materials are their poor use of environmental resources, poor quality control of the finished product and consequently a significant variation in durability. The long-term sustainability of some methods is being questioned in many places. Other alternatives are being sought after that are environmentally sustainable whilst also being of a suitable strength and durability for use in humid areas.

### **2.1.1 Existing processes described**

Within this thesis it is not necessary to provide an exhaustive list of building materials as previous authors have already done this, (Houben & Guillaud, 1994), (Stulz & Mukerji, 1993). Instead the focus will be on some of the more popular methods of providing walling at tolerable cost. Hollow and aerated concrete blocks, clamp and kiln fired brick and compressed and stabilised soil blocks (hereafter CSSB) are the five main building materials chosen for consideration. These have been selected because they are well known, have been adequately assessed for performance and have appropriate standards for evaluation. Aerated concrete is considered an advanced material and is included here for comparative purposes as its performance and characteristics are highly desirable for low-cost building.

***Aerated concrete blocks*** – Aerated concrete is a light form of concrete (density around 500kg/m<sup>3</sup>) that uses coal ash from power stations and omits the use of coarse

aggregate. A cement rich mixture has a foaming agent applied to it before the material is pumped or can be cast into suitable moulds (Craig, 1997). It has been developed into a high performance building material and is currently marketed as aerated concrete blocks or “Aircrete” (Thermalite, 2001). Although these blocks are not considered suitable for heavy load-bearing conditions, (over 7MPa), they are wholly adequate for low-rise structures such as typical homes. Other features such as high wall area per block, low thermal conductivity, easily shaped by hand tools and low moisture penetration make this a highly attractive material.

Figure 2.1 – Aerated concrete blocks



The above photographs show the structure of aircrete, its ease of handling and the high dimensional accuracy required for thin mortar joints. The textured surface of the blocks help to bond the render to the block, (if render is desired as it is not necessary on external walling).

***Hollow concrete blocks*** – These are relatively expensive due to their need for graded sand and large amounts of cement (12-17% by weight). If manufactured properly they can have very high strength and good durability. Significant cost and weight reduction is achieved by removing material from the central region of the block. Machinery for

production requires a vibrating table to settle the cement mix into the mould. Sometimes, instead, a heavy hinged lid slammed a couple of times or low pressures are applied to compress the material.

Good dimensional accuracy means that these blocks can be laid on a 10mm mortar joint. However, due to the voids in the block, mortar falls down these holes and is wasted. (In calculating the required mortar it has been assumed that the mortar actually used is closer to that needed for the surface area of the entire top surface of the block rather than just the edges where a joint is made with the neighbouring block.) These blocks are sometimes rendered for aesthetic reasons, which we will omit from any calculations for the time being.

***Kiln-fired brick*** – Over the centuries the process of burning clay to make brick has become more and more automated, sophisticated and complex, but not necessarily more cost effective, particularly in developing countries. (Parry, 1979) very eloquently and persuasively describes two methods of brick production in terms of cost and shows quite clearly that where labour costs are low, kiln-fired brick production would be economically unsuitable. Kiln-fired brick production requires a high capital investment and a significant amount of infrastructure to support production. Brick production must be located near to high quality clay deposits (often unavailable locally), staff needs to be more highly skilled, spares and servicing is highly specialised and energy requirements are considerable. Production output is very high, typically 10,000 - 30,000 bricks per day and needs to be continuous if to achieve high efficiency and to achieve the greatest return on investment. Modern kilns efficiently

recycle heat, giving a modest energy consumption per brick (3MJ) (International Labour Office, 1990).

The characteristics of such kiln-fired bricks are highly desirable as the material has a high wet-compressive strength and does not deteriorate rapidly over time even in the harshest of climates (Hanson, 2001). The material is pleasing to the eye and is sought after as an attractive material for home building.

***Clamp-fired brick*** – Can be inexpensive in monetary terms because the raw materials can usually be dug from the ground fairly locally and the energy required firing the brick could come from collected firewood. Clamp fired bricks are of a lower quality than kiln-fired bricks and can tolerate the use of smaller and poorer sources of clay deposits. Forming the blocks requires a wooden or metal mould and after forming they are laid out to dry. After drying they are stacked into a clamp where fires are burnt inside (Parry, 1979), (International Labour Office, 1990). These fires raise the temperature of the blocks to the point where the particles bond together (Stulz & Mukerji, 1993). Thorough burning is necessary to fire all the blocks properly and this takes several days to achieve and uses approximately 16MJ of energy per brick.

The finished blocks can be quite badly misshapen and this requires a thick layer of mortar between the blocks, sometimes as thick as 20mm. Furthermore, if the blocks are poorly fired then in order to achieve adequate durability they may need to be rendered as well. Fired blocks are usually considered attractive and so they are not generally rendered unless necessary.

Figure 2.2 – Clamp fired bricks

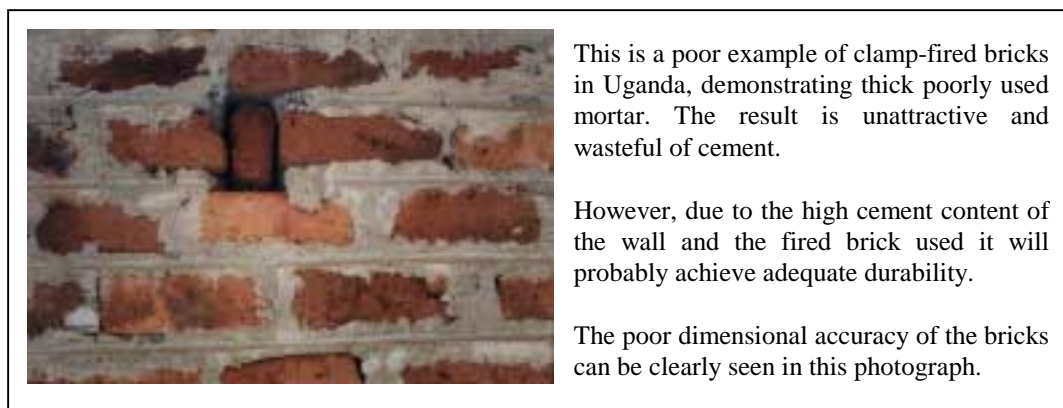

***Compressed and Stabilised Soil Blocks*** – These blocks use the same parent material as plain earth blocks but offer the significant advantage of wet compressive strength. Improved strength and stability in wet climates is generally achieved by a combination of two methods of stabilisation. One method is to compact the soil by applying some mechanical effort to reduce the voids in the material. Increasing the density of the material gives it a higher compressive strength and also reduces the potential for ingress of moisture into the block (Houben & Guillaud, 1989), (Norton, 1997). CSSB are further stabilised with the addition of a chemical stabiliser that helps to bind the particles together. Cement or lime are expensive additives but are generally available and although the practice of adding them to soil is reasonably popular the results can be disappointing unless it is done carefully (International Labour Office, 1987).

CSSB can be compacted using low or high-pressures or dynamically compacted via impact (Houben & Guillaud, 1994). The greater the level of compaction the greater the compressive strength of the block and the more effective any added stabiliser becomes, (Gooding, 1993). CSSB compacted to higher densities are also usually more

dimensionally consistent and therefore can be laid using a thinner mortar layer of around 10 – 15mm. Some CSSB need to be rendered or waterproofed in order to enhance their protection from the elements (Yogananda, 1999), but this can usually be avoided with higher levels of compaction and or higher quantities of stabiliser. Making a hollow CSSB can be done by straight-through perforations or deep and shallow frogs (Houben & Guillaud, 1989), (Centre for the Development of Industry, 1998). Each of these reduces the material volume present and therefore reduces the stabiliser quantity necessary for each block.

Figure 2.3 – Compressed and stabilised soil blocks (CSSB)

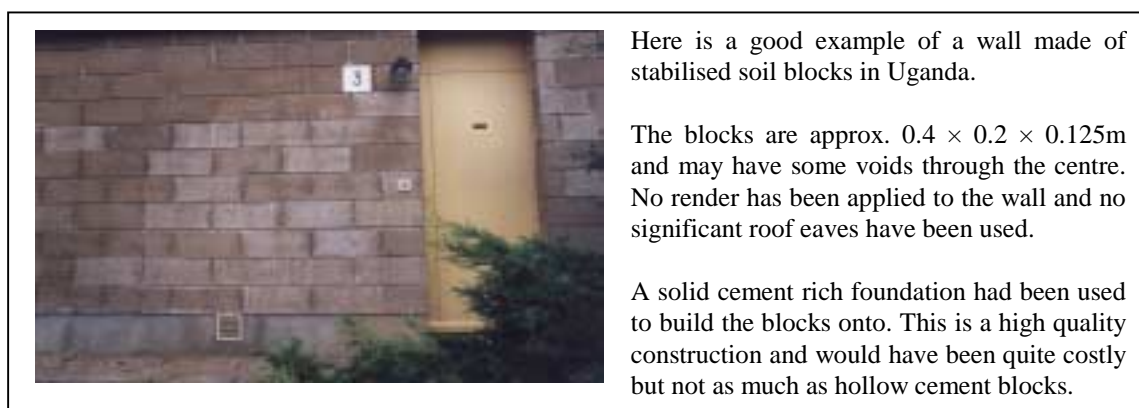
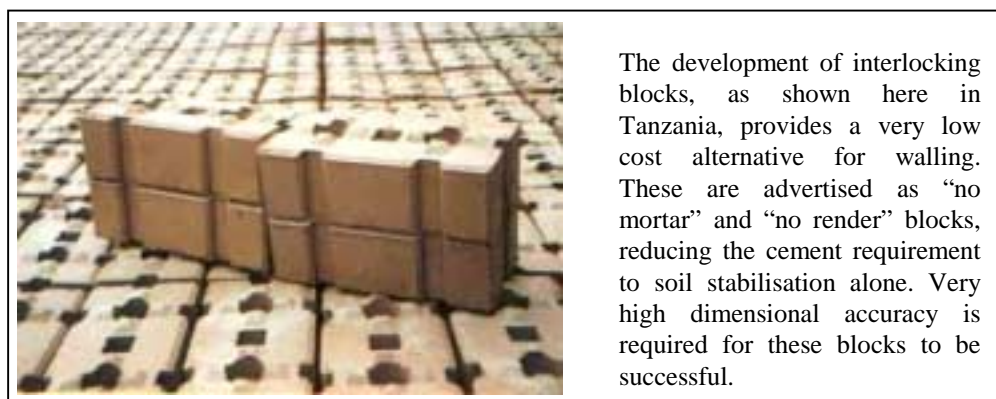

Figure 2.4 – Interlocking CSSB



### **2.1.2 Processes analysed for sustainability**

Some of the materials listed in the previous subsection require different methods of construction in order to produce satisfactory walling. These differences will be assessed and compared for the production of one square meter of wall. Some for example require more mortar between block courses to compensate for the irregularities of the block shape. The issue of durability is only qualitatively explored in the texts and no quantitative results for the durability of these materials has been found. Durability is typically defined in the range of “poor” to “excellent” (Houben & Guillaud, 1994), (International Labour Office, 1987). This could have something to do with the absence of suitable accelerated or short-term tests to indicate potential durability or as a relative measure between different materials.

Throughout the assessment of these materials it is assumed that they are able to perform the basic function of a finished wall, (i.e. support its own weight and the weight of any structures above it for a long period of time withstanding environmental attack). Whilst aesthetics play a part in material selection, it will be considered small by comparison to the material performance and cost and will therefore be ignored.

Possibly one of the most striking differences between these different types of walling units is their width. Some hollow concrete blocks are 250mm (10”) wide whilst the clay fired brick is usually only 103mm (4”) wide. A wider block is more stable and can be used to build taller walls with a high slenderness ratio, (width/height). A single-skin brick (103mm thick) wall is not considered to be stable enough except for

in-fill walling between columns and beams or for relatively small structures. In our analysis of single-skin brick construction we have included a buttress pillar of two bricks at 1-metre centres, which increases the brick and material requirement by almost 25%. It is more common to make a single-skin block wall of closer to 150mm (6") thick and this practice has been extended to two storey construction successfully.

We have chosen to assess the walling materials described in the previous section according to the four following measures:

- Primary energy consumption for production and delivery in MJ per m<sup>2</sup> walling
- Cement usage in kg per m<sup>2</sup> walling
- Ranking for suitability for small-scale ('local') production
- Ranking for suitability for on-site production using mainly on-site materials

The table and associated notes below is a summary of a spreadsheet used to make the calculations for comparison of the selected materials. The raw data for this comparison can be found in Appendix E.

It is important to notice that the different materials each has a wide variety of different characteristics and the table below does not attempt to normalise these characteristics in any way. For example the wet compressive strength of the hollow cement block will be several times larger than the low-density CSSB and this is not really indicated from the energy and cement cost. The table does however generally give the real costs of each type of walling.



Table 2.1 – Comparison of different walling materials

Material	Dimensions ( $l \times b \times h$ )	Note	Energy	Cement	Suitability for production	
					'Locally'	On-site
	Mm		MJ/m <sup>2</sup>	kg/m <sup>2</sup>	Ranking (1 = best)	
High-density CSSB	290 × 140 × 90	1	290	18.7	2	1
Low-density CSSB	290 × 140 × 90	2	420	34.1	1	1
Brick ( kiln-fired)	215 × 105 × 65	3	430	8.1	2	3
Brick (clamp-fired)	215 × 105 × 65	4	1340	11.4	1	2
Hollow Cement block (N)	300 × 150 × 200	5	430	27.0	1	2
Hollow Cement block (F)	300 × 150 × 200	6	590	27.0	1	2
Aerated-cement block	440 × 140 × 215	7	230	12.4	2	3

Notes

0. All cement is assumed to have been transported 100km.
1. High-density (2000kg/m<sup>3</sup>) solid blocks manufactured on-site from local soil/cement mix (5% cement), laid with 10 mm of soil/cement mortar (20% cement) and no render.
2. Low-density (1700kg/m<sup>3</sup>) solid blocks manufactured on-site from local soil/cement mix (10% cement), laid with 15 mm of soil/cement mortar (20% cement) and 15mm render.
3. Kiln-fired brick (3000MJ/1000 bricks) laid with 10 mm of sand/cement mortar (20% cement) and no render, double brick buttress column at 1m centres.
4. Clamp-fired brick (16000MJ/1000 bricks) laid with 15 mm of soil/cement mortar (20% cement) and no render, wall has double brick buttress column at 1m centres.
5. Hollow (50% voids) cement blocks made from 10% cement mixed with gravel and sand from nearby source, with a 10mm mortar joint, (sand/cement, 4:1 ratio).
6. Hollow (50% voids) cement blocks made from 15% cement mixed with gravel and sand transported from 50km away, with a 10mm mortar joint, (sand/cement, 4:1 ratio).
7. High-tech aeration process using coal ash mixed with cement (15%) to make a very light (480kg/m<sup>3</sup>) material. Laid with a 3mm mortar joint using cement rich paste (50% cement). Blocks transported 50km.

There is increasing evidence that local production of hollow concrete blocks and clamp-fired bricks use unsustainable resources. The practices of using river sand for the former (Shan & Meegoda, 1998) and firewood as fuel for the latter (Mbumbia et al., 2000) are environmentally unacceptable, and in any case likely to face rising prices driven by increasing scarcity. Consequently the only small-scale method of block

manufacture left deals entirely with the stabilisation of locally available un-graded soil.

Of the materials listed above, only three use less than our assumed target of 15kg of cement per m<sup>2</sup> of walling; two of them are unsuitable for local production and the third has an extravagant energy requirement. High-density CSSB is the only material that uses but a modest amount of cement ( $\approx 18\text{kg/m}^2$ ), has a low energy requirement and is suitable for local and on-site production. The question that now needs to be answered is whether or not methods exist that may further reduce the cement requirement of high-density CSSB to less than 15kg per m<sup>2</sup> of walling.

If we want to concentrate on the field of CSSB block production for its environmental and sustainability advantages, we still need to make significant improvements on performance whilst reducing the cost. It has generally been noted that CSSB walling that is un-rendered and unprotected does not perform satisfactorily over time in the humid tropics. Consequently improved levels of stabilisation are required without a significant increase in cost. This could be done via a combination of improved material compaction and improved stabiliser effectiveness. As the chemical stabiliser is the most expensive ingredient in the block then its quantity should be reduced to the lowest level possible for achieving the necessary strength and durability.

There are a number of options for the chemical stabilisation used. Additives such as cement can be used to make a high-cement but thin-walled block, or a very low-cement mix throughout a very dense solid soil block or as a surface render over compressed soil without any cement present. Mortarless construction is a very

attractive proposition and would be quite compatible with in-wall curing of very-low-cement homogenous blocks. Also the production technique employed for producing very-low-cement blocks is quite straightforward and permits immediate stacking after moulding making it more attractive than thin walled blocks that require more careful handling and curing.

Applying render over raw soil doesn't yield satisfactory results in the long term, as the render permits moisture migration to the soil behind and swelling and shrinking can cause render cracking and failure. This may be improved with higher levels of compaction that resist moisture migration better. The costs of a high-cement render over a soil wall are still higher than a very-low-cement block and would be a costly maintenance requirement if the wall had to be re-rendered. Consequently the very low-cement solid block has been selected as a prime candidate for further research and improvement.

## ***2.2 Raw material selection and characteristics***

Soil is readily available over the vast proportion of the landmass on the planet and hence it is not surprising that it has been widely used for dwelling construction. This section of the thesis will briefly summarise the existing knowledge of soil selection for making CSSB. Wide ranges of soil are suitable for this building material and their defining characteristics will be outlined below. The use of cement as a chemical additive is also very common in CSSB manufacture. The use and understanding of cement is widespread and it's application to soil had received much attention in recent

years. Adding cement to soil is very different to adding it to aggregates and the requirements and characteristics of such a union will be described in the following subsections.

### **2.2.1 Properties and analysis of soil**

Soil is found deposited on the surface of the earth and can consist of many different types. The variation in the soils present at the surface can be attributed to a series of natural effects working on the area over time (Craig, 1997) (Houben & Guillaud, 1994). On the very surface of the soil one typically finds material with a large amount of organic compounds present. This is unsuitable for block manufacture and can usually be distinguished by a musty smell especially on heating (Norton, 1997) (Wolfs-kill et al., 1965). Material underneath this organic layer is much better as it usually contains a cross section of particle sizes and includes a proportion of small soil particles called “fines”. These are usually defined as particles passing a 63 $\mu$ m mesh and consist of silt and clay. Clay is necessary in block production because it aids the workability of the mixture, increasing levels of consolidation and improving green strength, (International Labour Office, 1987). Larger particles “sands” found in soil can generally be assessed as minerals that are silicas, silicates or limestones. As well as the solid rock particles and fragments, soil will have a proportion of water and air that fill the gaps between adjoining particles in the soil. This gives natural soil a non-homogenous and porous nature.

Systems for identifying some major characteristics have been developed to define different ranges of soil characteristics. The most common of these is the size

distribution of the soil particles. (Houben & Guillaud, 1989) lists the physical characteristics that can define a sample of soil, including: colour, shape, apparent bulk density, specific bulk density, size or texture, moisture content, porosity or voids ratio, permeability, effective surface area, adhesion, specific heat capacity, dry strength and linear contraction. Chemical properties are also sometimes of interest particularly when a chemical additive is used. These chemical properties include the composition, mineral content, metallic oxides, pH levels and sulphates in the soil (Craig, 1997).

With so many different characteristics that one could discover about a sample of soil, it would be foolhardy to try and discover them all in every situation that soil is to be used for making CSSB. Only a small number of characteristics are of real relevance to the scientist testing the soil. The chemical composition of the soil is of little importance once the absence of unstable compounds and organic matter has been established. The physical properties are of greater interest for making CSSB as these will help to determine its ease of mixing, forming, de-moulding, porosity, permeability, shrinkage, dry strength and apparent bulk density.

Controlling or monitoring the clay fraction is important in making CSSBs. Too much clay results in unacceptably high expansion upon wetting, requiring excessive amounts of cement to combat this. Too little clay causes low adhesion between particles and hence causes high breakage rates on de-moulding of the CSSB. An optimum fines content for making CSSB was suggested by the United Nations to be about 25% of which more than 10% is clay, (Gooding, 1993). A more useful range of particle sizes suitable for building with earth is given in (Norton, 1997) as follows:

Sand/fine gravel	40 - 75%
Silt	10 - 30%
Clay	15 - 30%

From the literature it is unclear how much a change of say  $\pm 5\%$  to the clay content will have on the overall performance of the CSSB. Controlling the moisture content in the mixture is also important, but generally the texts use a simple drop test to determine an acceptable range. The accuracy of this test is fairly low and what effect the possible variation in the moisture has on the finished product is not clear.

The detrimental characteristic of expansion and contraction of a CSSB can only occur if three characteristics are present: “Clays” and “Porosity & Permeability” and “Moisture differential”. If any one of those is absent then expansion and contraction will not occur, (ignoring thermal expansion and contraction). See diagram below.

Figure 2.5 – Characteristics of CSSB expansion

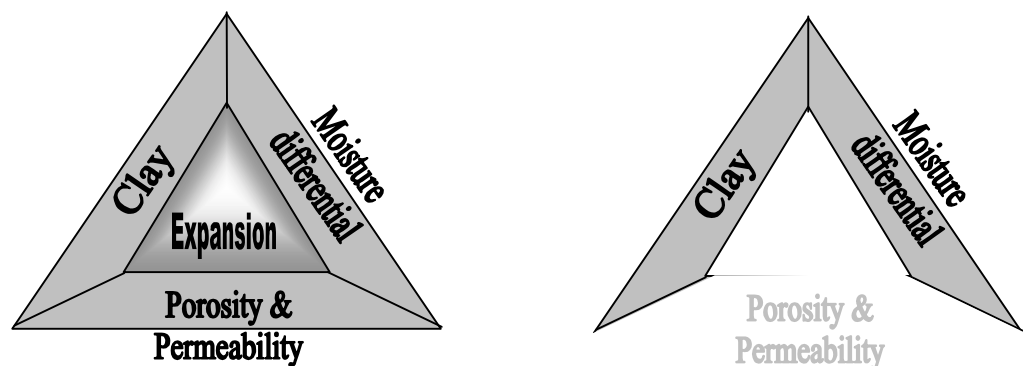

We need clay to be present in CSSB and it is impossible in humid climates to avoid moisture differentials so the only characteristics that we can seek to remove or reduce are the porosity and permeability.

### **2.2.2 Basics of cement usage**

As a stabilising material cement is well researched, well understood and its properties clearly defined, (Akroyd, 1962), (Popovics, 1998), (United Nations, 1972). Portland cement is readily available in most urban areas, and usually available in semi-urban areas, as it is one of the major components for any building construction. Earlier studies have shown that cement is a suitable stabiliser for use with soil in the production of CSSB, (International Labour Office, 1987).

Cement is mainly composed of Lime (CaO) and Silica (SiO<sub>2</sub>) which react with each other and the other components in the mix when water is added. This reaction forms combinations of Tri-calcium silicate and Di-calcium silicate referred to as C<sub>3</sub>S and C<sub>2</sub>S in the cement literature, (Akroyd, 1962), (Lea, 1970), (Neville, 1995). The chemical reaction eventually generates a matrix of interlocking crystals that cover any inert filler (i.e. aggregates) and provide a high compressive strength and stability.

The diagram on the following page attempts to illustrate how these crystals actually give the material strength. The basic mechanism is friction of point contacts between the particles taking place at a microscopic level. The duration of time for this reaction to take place is not precisely defined. There is however the definition of the “critical time” after which further working of the mix causes breaking of the crystals that have

formed but before the total matrix has gained strength. The flow chart that follows shows the reaction and their effect with respect to time.

Figure 2.6 – Sketch of crystalline cement growth in sandcrete

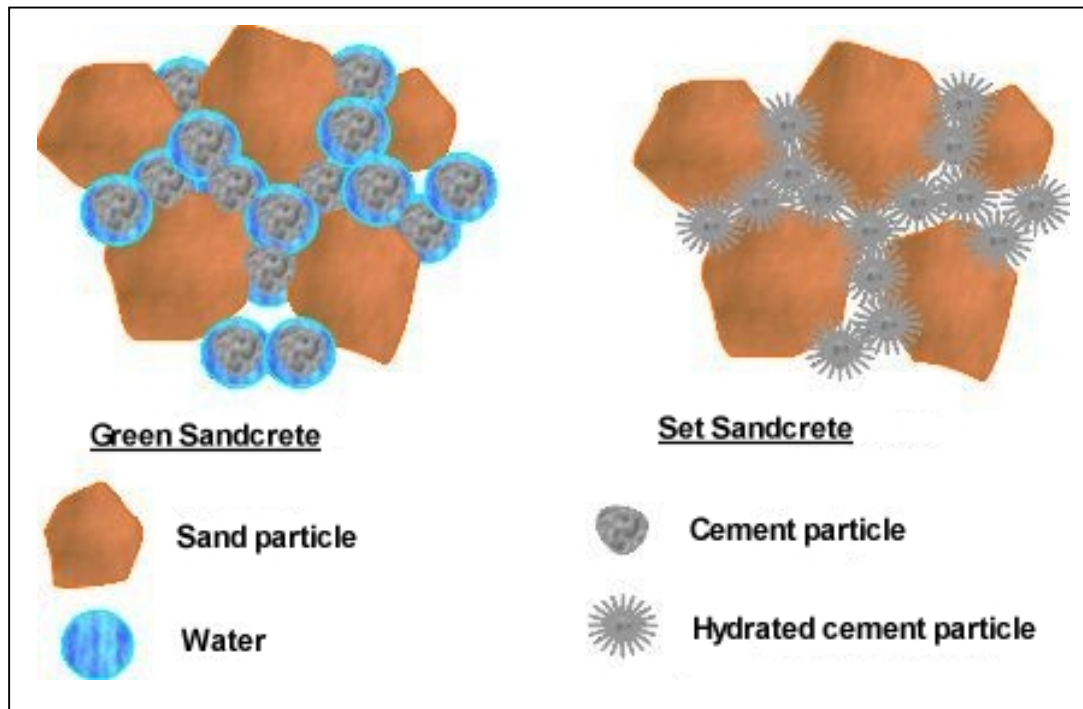
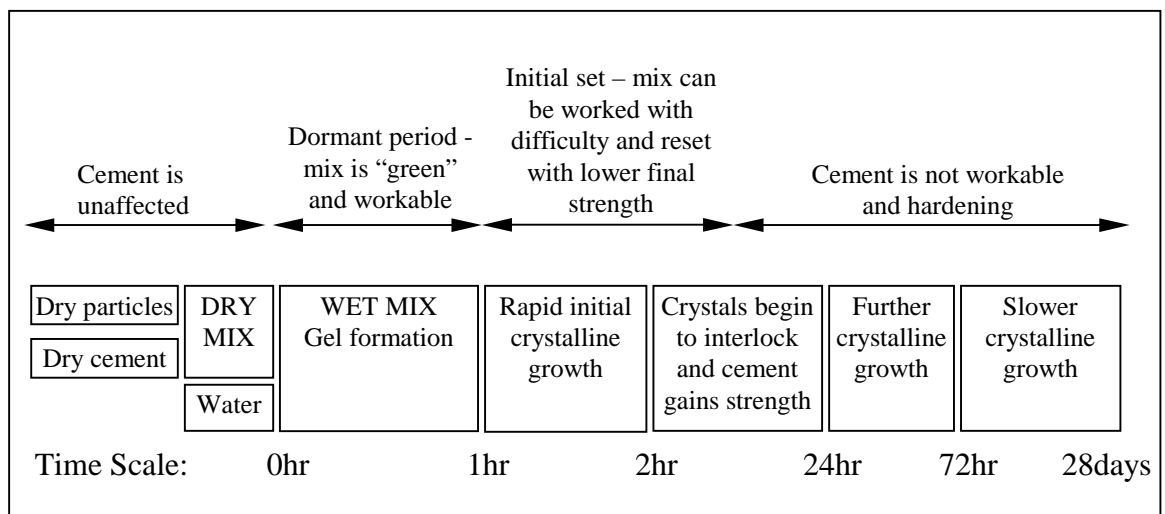

Figure 2.7 – Flow chart of the cement hardening process





Cement is usually mixed with an aggregate to form concrete. The aggregate is usually inert filler that makes up the bulk of the material and the cement coats the aggregate in the gaps (Teychenne et al., 1988). The concrete industry has recognised that the achieved strength of concrete is highly dependent on the quantity of voids present in the mixture before curing. (Akroyd, 1962) suggests that the presence of 5% air voids will reduce the strength of a concrete mix by 33% and 8% voids by 50% compared to a sample with 0% voids present. To aid the particle intimacy, different aggregate grades are mixed together giving a spectrum of particle sizes that reduces the quantity of air voids in the material.

The water used to mix the concrete plays an important role both in placing the material and in achieving strength. The quantity of water used is typically calculated using an appropriate “water-cement ratio”. The minimum water/cement volume ratio is between 0.22 and 0.25 (Akroyd, 1962), for adequate cement hydration, but this is generally increased to the order of between 0.5 and 0.8 for normal mixes, (Lea, 1970).

Figure 2.8 – Compressive strength of concrete with different water-cement ratios

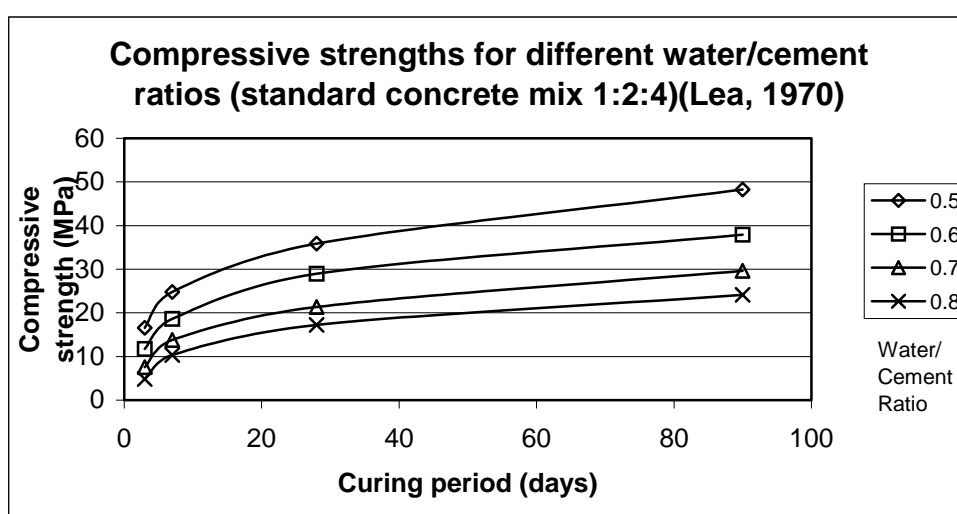

Very low water-cement ratios yield a highly unworkable mixture and more water has to be added to form the mixture into the desired shape. Additional water is called the “free-water” content and is calculated from the slump or Vebe time test. This water does not form part of the chemical reaction and will eventually evaporate from the concrete leaving voids of air throughout the material (Neville, 1995). In order to keep the free-water as low as possible concrete can be compacted or vibrated to aid workability and consolidation.

### **2.3 Soil stabilisation**

The methods of making earthen structures more durable fit into primary and secondary categories. Primary methods stabilise the raw material making it more durable, and subsequently any structure made from it, whilst secondary methods provide protection from the elements rather than enhancing the material properties. Soil stabilisation improves the characteristics of the soil so that it can tolerate greater loading and perform better when it is exposed to the elements. Stabilisation usually involves work of some kind to be done to the soil, and this section will briefly describe some of the methods of soil stabilisation that have been used.

Raw earth can be stabilised in a number of different ways. (Houben & Guillaud, 1994) suggests that there are six different mechanisms for soil stabilisation, namely: raising density, reinforcement, linking, binding, waterproofing and water repellent treatment. The two most common techniques used in block manufacture are binding (with

chemical additives such as cement or lime) and raising density (by some method of compaction). In this section the guidelines of cement addition to soil will be summarised, the methods of soil compaction will be explored and the current role of stabilisation will be outlined with a view to further possible enhancements.

### **2.3.1 Cement addition**

By now we have a better understanding of the way cement bonds with itself and other particles in making concrete. We also know some of the important guidelines that need to be followed when making successful mixes of concrete. Furthermore, many of these guidelines and principles should be followed when mixing cement with soil.

The quantity of cement that is required for adequate stabilisation depends on several criteria, namely; the required compressive strength, soil type, environmental conditions and levels of quality control. Cement can very easily be wasted if it is not utilised in the correct manner and significant cement reduction can be attained through good production management and quality control. Controlling the moisture content, level of compaction and the curing regime will play a big part in getting the most from the added cement.

For relatively quick analysis of soil characteristics for cement stabilisation the CSSB literature suggest the use of a linear shrinkage mould, (Houben & Guillaud, 1994), (Norton, 1997), (International Labour Office, 1987), (Rigassi, 1995). Soil is mixed with water to its liquid limit and then left to dry out in a mould with dimensions  $40 \times 40 \times 600$ mm. The linear shrinkage is measured and the quantity of cement required to

adequately stabilise the soil is calculated. The following table is taken from (International Labour Office, 1987), recommending the cement to soil ratio for different soils of known linear shrinkage.

Table 2.2 – Cement to soil ratio for different soils of known linear shrinkage

Measured Shrinkage (mm)	Cement to soil ratio
Under 15	1:18 parts (5.56%)
15 – 30	1:16 parts (6.25%)
30 – 45	1:14 parts (7.14%)
45 – 60	1:12 parts (8.33%)

The volumetric shrinkage of a CSSB will depend on the fraction of clay present and the moisture content of the mix. If the moisture content is low then the shrinkage will also be low when it dries out. This is harmonious with the recommended low water-cement ratio for maximising the cement strength. However, on subsequent wetting the forces exerted by the expansive clay particles must be restrained by the cement matrix in the CSSB. So the cement requirement will also depend on the degree of wetting that the CSSB will experience, hence the environmental conditions.

As mentioned earlier the degree of wetting depends on the ability for moisture to migrate in and out of the material, dependent on the porosity and permeability. Methods of reducing the migration of water to the clay fraction can therefore also provide a method of reducing the cement required for adequate stabilisation. This technique is more commonly referred to as compaction or consolidation and will be main focus of the next sub-section.

### 2.3.2 Compaction of material

Within the civil engineering industry there are several methods of compaction that are used in ground stabilisation that use methods of static, vibration and dynamic blows to compact soil (Parsons, 1992). Block compaction uses similar methods and similar technology only on a smaller scale and typically compaction takes place in a confined space rather than in unconfined open areas (Houben & Guillaud, 1989), (Norton, 1997). Block compaction has predominantly used vibration or slow steady squeezing (quasi-static) compaction to achieve the desired levels of soil consolidation. Until very recently the dynamic element used in block manufacture has been limited to the compression piston coming into contact with the surface of the soil at some speed followed by static pressure being applied to the material (Houben et al., 1994).

The following three figures demonstrate the different types of compaction, the particle intimacy around the O.M.C. (as found in (Head, 1980)), and the relationship between moisture content and achieved density for different compaction energies.

Figure 2.9 – Unconfined, semi-confined and confined compaction

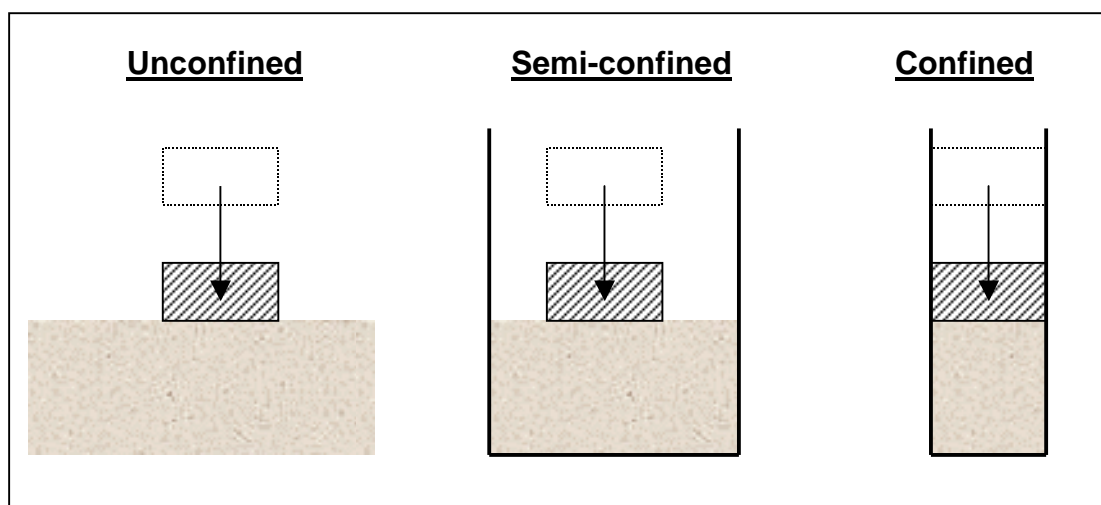

Figure 2.10 – Diagram of particle intimacy around the O.M.C.

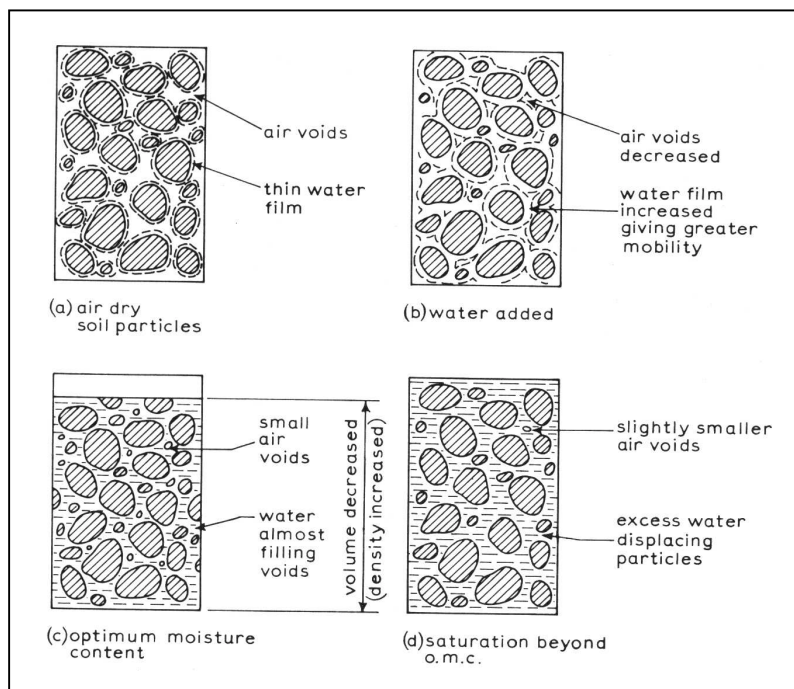
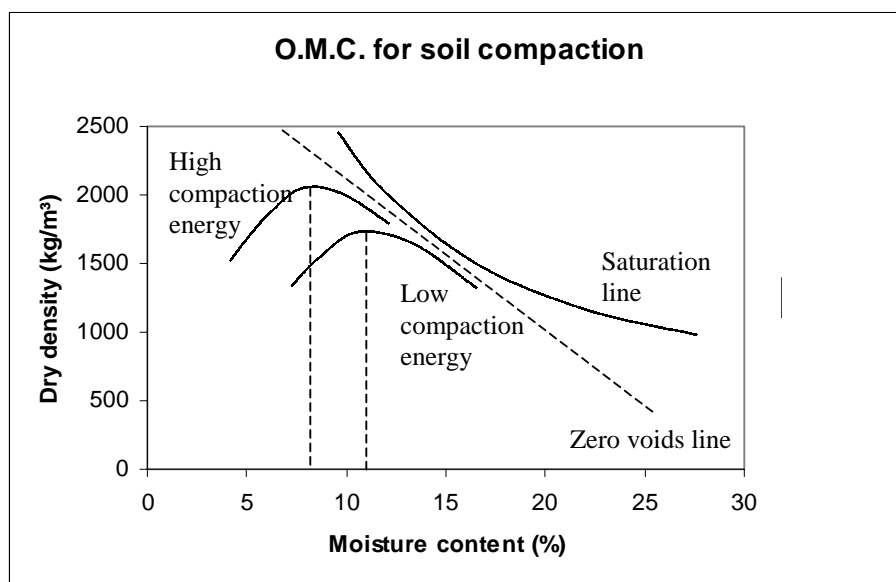

Figure 2.11 – O.M.C. for soil at different compaction energies



Improved levels of compaction have a significant effect on the compressive strength of the sample and on the effectiveness of the cement stabiliser added. The following

two graphs are presenting data collected by (Gooding, 1993) to indicate the relationships between cement content, compaction energy (defined in MPa pressure) and the resulting bulk density and subsequent 7-day wet compressive strength.

Figure 2.12 – Relationship between cement content, compression pressure and 7-day wet compressive strength

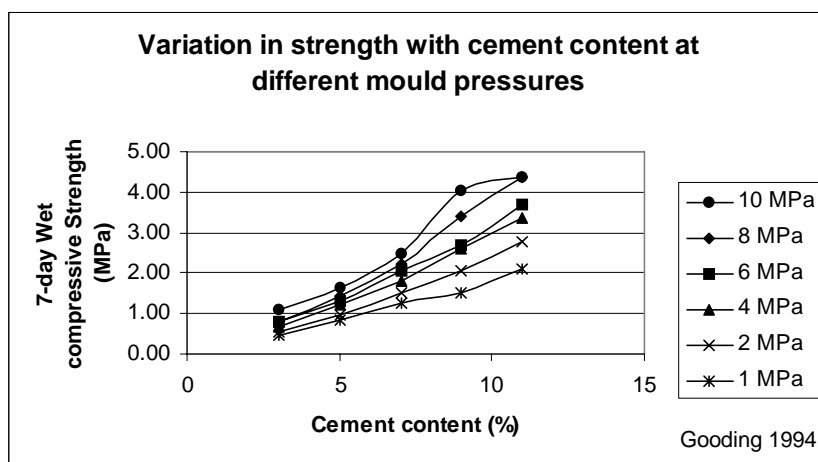
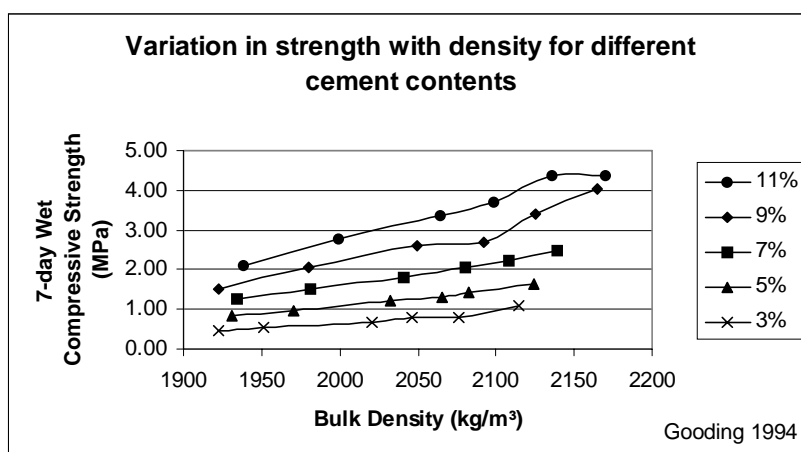

Figure 2.13 – Relationship between bulk density and 7-day wet compressive strength for different cement contents



The above data clearly shows the significant advantages that increased compaction offers. If a CSSB could be compacted to a higher density, then for the same ultimate

strength the cement content could be reduced. The trade off is an increased energy cost for a reduction in chemical additives. Another thing that is apparent is the possible miss match of moisture contents desired for optimum compaction for a given energy and optimum moisture content for cement curing. This issue of what is the most appropriate moisture content to be used for a given compaction energy needs to be resolved.

### **2.3.3 Current role of stabilisation and its possible extension**

It is usually the poor or underprivileged that need and build low-cost housing and this has an effect on the processes used to make the building material. Minimising material cost and machine requirements are typically more important than reducing labour costs. Consequently it is not uncommon to find block manufacturers using cheap machinery and minimising the stabiliser content. The photograph below shows some of the poor applications of cement to stabilise soil blocks in what seems to be a well-organised production yard. This illustrates the need for better understanding of the processes at work in soil stabilisation and improved quality control throughout the process of production. Significant savings in cement or much higher quality blocks could be attained if these were put in place. Furthermore, there is little way of knowing the performance of a finished CSSB without conducting crushing tests so the purchaser has to trust the seller as to the quality of the blocks being sold.



Figure 2.14 – CSSB production yard showing poor curing practice

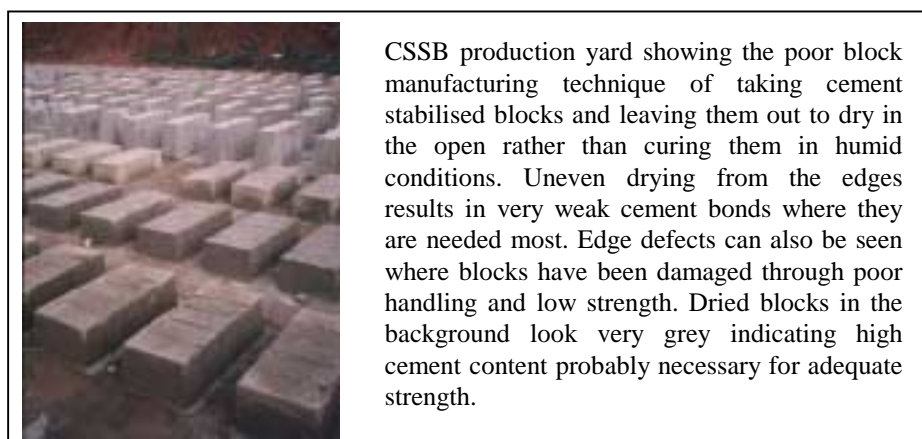

Apart from improving the understanding of cement use and implementing better quality control in production there are advancements that can be made in the production technology as well. A study conducted by (Gooding & Thomas, 1995), as part of an Overseas Development Agency report, calculated that using more expensive high-pressure compression machinery to make blocks was not as economically attractive as adding more cement and using a low-pressure machine for the estimated life of each machine.

Terms used for different moulding pressures as described in (Houben & Guillaud, 1994):

Very low pressure	1 – 2	MPa
Low pressure	2 – 4	MPa
Average pressure	4 – 6	MPa
High pressure	6 – 10	MPa
Hyperpressure	10 – 20	MPa
Megapressure	20 – 40	MPa

Improvements in methods of compaction would greatly improve the characteristics of the finished CSSB, both immediate green strength and long term strength as well as reducing the porosity and permeability of the material. It could also facilitate in the

further cost reduction of the material making the CSSB building material available to a wider group of people and more attractive and desirable for dwelling construction. From the graph shown in Figure 2.12 an increase in moulding pressure from 2 MPa to 10 MPa can double the wet compressive strength. Alternatively such an increase in pressure could successfully reduce the cement content from 11% to 7% without a significant loss in wet compressive strength. However, the argument that increasing the applied pressure can enable one to reduce the cement content without any loss in overall performance is not as attractive as it sounds. The high-pressure compaction ensures that more material is required for a block of given size and whilst some savings can be made in expensive additives such as cement the increased density offsets this advantage slightly.

The graph below is a combination of interpreted data from (Gooding, 1993) and (Houben et al., 1994), (who compiled a CSSB machine catalogue with specifications and approximate prices). The graph shows the relative machine cost compared with the approximate cement usage per cubic metre of walling material. Gooding calculated the relationship between cement content, applied pressure and wet compressive strength. From this data it was possible to suggest the required amount of cement to achieve a certain block performance. This block performance has been taken as a 7-day W.C.S. of 2MPa and using the projected *density* that the CSSB press could achieve a cement requirement was calculated. It clearly shows the area of where a machine is necessary to fill the low-machine cost and low-cement usage area. Data points in the upper region of the graph represent machines that use low-pressure lever systems whilst points in the lower region include machines with a hydraulic compression mechanism delivering high-pressure. Motorisation does not necessarily

procure greater applied pressure but usually results in higher machine cost and faster rates of production.

Figure 2.15 – Comparison of machine cost and cement requirement

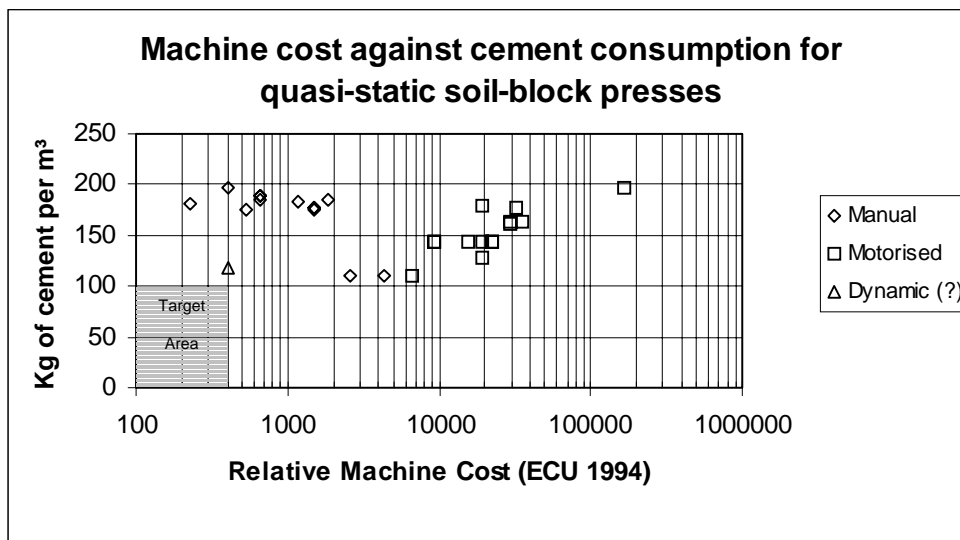

From this graph it can also be shown where dynamic compaction could feature and that it may be able to provide the low-cost and low-cement block machine that is currently unavailable. Research into dynamic compaction is in its infancy, but significant discoveries have already been made. The next section of this chapter will describe the research conducted to date and to identify gaps where further investigation is required.

From the above it is now possible to summarise some of the different aspects of compaction that we would like to see improved or included in stabilised soil block manufacture.

- Higher density blocks exhibit greater strength and increase the effectiveness of any chemical stabiliser added to the block.

- Reduced porosity and permeability of the material hindering the ingress of water and slowing the rate of deterioration in humid conditions.
- Increased green strength to reduce breakages during early handling and to enable stacking immediately after forming.
- Compaction achieved via a mechanism that is easy to manufacture and to maintain using tolerable levels of materials, equipment and skills.

It is hoped that dynamic compaction may be able to deliver on some of these criteria and the following section will give details of experiments carried out to determine the potential of full-size dynamically compacted blocks for use in the humid tropics.

#### **2.4 *Dynamic compaction research***

It has been found that the information on dynamic compaction of stabilised soil blocks is very scarce. Up till now the author is only aware of two pieces of work that cover this topic, and only one of which he has been able to access. There are however, other publications that deal with the subject of soil compaction using impact, both from a theoretical and practical viewpoint. This section will review the conceptual research on impact compaction carried out by the Transport Research Laboratory identifying both theoretical models proposed and experimental results of significance. Following this an overview of the optimisation experiments conducted by Gooding will be presented identifying areas of further research required. Finally the application of impact compaction to soil blocks as carried out by Montgomery (the author) will be reviewed.

### 2.4.1 Conceptual Research

The majority of the research into dynamic compaction of soils has been conducted by the civil engineering industry with a view to improving soil consolidation, (both efficiency and depth) for subsequent placement of a structure. Road compaction is one of the areas that has particularly focused on this technique with the application of vibrating rollers and vibrating sheep's foot rollers, (Parsons, 1992), (Ingles & Metcalf, 1972), (Hausmann, 1990). These techniques do not really apply to the confined soil compaction that would be experienced with CSSB manufacture by impact. However, research has also been conducted on dropping weight compactors, vibro-tampers, power rammers and single and multi-weight dropping machines, (Parsons, 1992). Such research is of greater interest despite the compaction taking place in the unconfined rather than confined state.

The figure below contains photographs of some of the “impact” compacting equipment available in the civil engineering industry. Each deliver a known quantity of energy over a known surface area and would be given an “energy transfer per unit area” rating of between 4.3 – 120kJ/m<sup>2</sup> depending on the model and settings of compactor.

Figure 2.16 – Civil engineering compaction equipment using impact

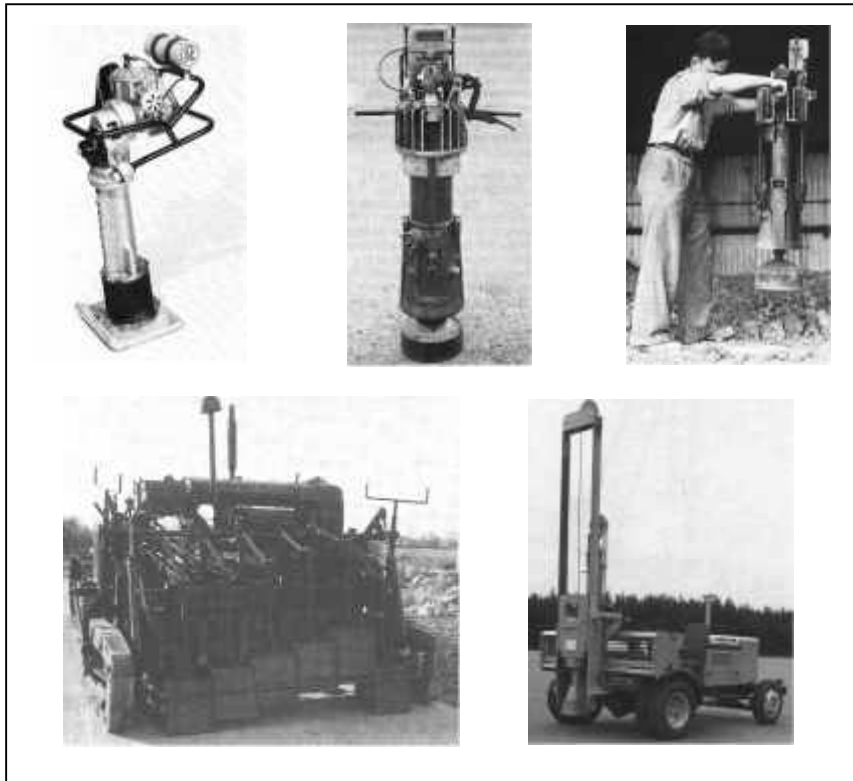

Theoretical and experimental analysis of the impact method was also conducted to try and determine the most effective machine for ground compaction and to improve the understanding of impact compaction. A test rig was developed and tests were conducted on a variety of soils by dropping a known mass through a known height and comparing the compaction with the 2.5 kg standard compaction test for the same soil. Measurement of the impact pressures experienced by the soil was also carried out using piezoelectric gauges buried at 150mm and 300mm beneath the surface.

Parsons discovered that for an approximately constant energy transfer per blow a smaller mass lifter to a higher height delivered a higher pressure than a larger mass lifted from a smaller height. Furthermore the pressure experienced at 300mm below the surface was approximately half the pressure experienced at 150mm below the

surface. This suggests a linear decay in pressure from the surface to some point beneath the surface dependent on the energy transferred in the blow and soil characteristics. The application of more than one blow demonstrated that higher degrees of compaction could be attained for the same optimum moisture content as used in the 2.5kg standard compaction test.

Theoretical analysis of the compaction of the soil by impact included mechanical characteristics of the soil (plastic deformation on impact), the impactor velocity, mass and impactor surface area. From these a theoretical pressure applied to the soil could be calculated. The main variable of interest in this analysis is the dynamic modulus of deformation, which can only be found by measuring the deformation of the soil after an impact has been delivered. The analysis suggests that this variable will be constant for the type and moisture content of the soil. Whilst this may be true for soil in the unconfined state it almost certainly is not the case with soil confined in a mould.

Another text (Scott & Pearce, 1975) suggested that impact compaction can be modelled as a highly damped spring with characteristics that depend on the Young's Modulus, Dilation Velocity, Poisson's Ratio, and Elastic Limit of the soil. They give an equation that links these characteristics to the rate of deceleration of a moving mass in order to model the stress and movement at the impact surface for an unconfined mass of soil. They investigate the effect of unsaturated and saturated soils monitoring the elastic properties, surface deflection and stress concentrations. They also suggest a model for a one-dimensional situation that may be analogous to dynamic compaction within a constrained mould. However the assumptions made for the development of

the model are not clear so application to the specific case of dynamic compaction of soil blocks has not been possible.

Throughout the texts that deal with soil consolidation there seems to be a lack of explanation or understanding of what is actually happening during compaction. Each text can describe the characteristics before and after the consolidation has taken place but they don't attempt to explain the process. Soil is a complex material and consolidation takes place at the microscopic level of particle placement and interface with other particles. This is a very difficult area to model, but it would be beneficial to discover some of the prevalent mechanisms that occur during compaction whether by impact or otherwise.

#### **2.4.2 Compaction optimisation of confined soil samples**

Research in the previous sub-section concentrated on the compaction of un-confined soils. This sub-section covers in some depth the research conducted by (Gooding, 1993). It is the sole text that has put forward a systematic approach to determining the most effective method of compacting soil confined in a mould. It has also been helpful in experimental design for this Ph.D. and it's summary helps to explain some of the parameters selected for dynamic compaction of CSSB. Although Gooding thoroughly investigated the dynamic compacting process, he did not stabilise any of the dynamically compacted samples with cement. The characteristics and effectiveness of the combined processes was not looked into.



Before dynamic compaction was investigated, he looked into the process of quasi-static compaction (i.e. slow-squeezing). His research included varying the cement content, the applied pressure, mould taper, double and single sided compaction, pressure cycling and mould wall roughness, (some of these results have already been shown in earlier sections). Throughout his tests he used a fabricated soil called '*soil-A*' with a constant moisture content of 8%. His analysis of *soil-A* is included in Appendix A.

A relationship between compression pressure, 7-day wet compressive strength and cement content was developed and a model suggested estimating the wet compressive strength of a sample with known cement content and applied pressure. This model was based on actual experimental results taken from tests carried out using a range of pressures and cement contents. A small cylindrical mould specified in BS1924 was used for all of these tests. All the cylinders had their wet compressive strength tested after seven-day curing and subsequent soaking for 16 hours.

Gooding investigated the efficiency of impact compaction using *soil-A* without any cement present. The compressive strength had to be estimated from the achieved density compared with compressed samples. The wet compressive strength of dynamically compacted soil samples could not be measured, as the compacted samples would break apart when immersed in water. Each sample received the same energy but by different impact arrangements and the achieved density was recorded. Density was calculated by measuring the final cylinder height ( $\pm 0.05\text{mm}$ ) and mass ( $\pm 0.1\text{g}$ ) on ejection from the mould. Each cylinder received a constant 279 J/kg and the mass of each cylinder was kept at around 1.66 kg. Other factors such as the

number of blows and impactor momentum were varied to find any optimum parameters for this technique.

Each sample received one of 1, 2, 4, 8, 16, 32 or 64 blows. The optimum number of blows (number that yielded the greatest density) was found to be at 16 blows, but it was also noted that only a 3-4% reduction in compaction efficiency occurred when this was varied from 8 to 32 blows for each of the different masses.

Different momentum transfer was also explored for the same energy transfer. Smaller impactor masses were lifted higher and larger impactor masses were dropped from a lower height. Three different masses were used in the experiments on the samples (23.35kg, 35.00kg and 46.80kg) and it was noted that the bigger masses dropping at slower speeds were more effective. Yet, the 23.35kg mass and the 35.00kg mass were only 0.4% and 0.2% less efficient respectively at the 16 blow configuration than the 46.80kg mass.

It was discovered that the method of dynamic compaction was more effective in consolidation than quasi-static compression for the same total energy transfer into the material. The selection of 279J/kg was taken from the energy required to quasi-statically compress *soil-A* to 9.7MPa. It was possible to achieve the same density through impact compaction with the application of only 25-50% of the energy necessary with quasi-static compression.

The experiments conducted by Gooding to optimise dynamic compaction for the same energy transfer is very interesting and helpful for machine design, but it does not

indicate the levels of compaction that could be possible with additional energy. Nor does it indicate the best method of applying a certain amount of energy if a limited number of blows are to be applied. Are earlier blows more effective than latter ones? Does the impact energy need to increase as material becomes more compacted? The research also does not include the very necessary ingredient of compaction with cement present. Impact compaction of cement is not practised in the concrete industry, so the combination of these two elements needs to be experimentally assessed.

The only example of buildings made from dynamically compacted material was surveyed by Gooding as part of a survey of CSSB structures in several countries (Gooding & Thomas, 1995). He compares them with other structures in the area, constructed using similar appropriate techniques, with some interesting observations. The building made from dynamically compacted low-cement (6%) material, using a manual impact machine, had been standing for 10 years and was still in excellent condition. Other buildings in the same area made from CSSB that had been made using expensive motorised compression machinery and 9% cement were already deteriorating after only two years. Block production costs using the dynamic machine were 25% and 40% less than “sandcrete” and cement blocks respectively and were almost half the cost of CSSB made using the motorised compression machines. Such significant savings in cost and improvements in performance certainly warrant further investigation.

### 2.4.3 Application of impact to block compaction

As part of an undergraduate degree programme the author undertook a project labelled “Design and realisation of a test rig to research the production of full size dynamically compacted soil-cement blocks”(Montgomery, 1997). This project was completed in 1997 and achieved the following results. A full-size dynamic compaction test rig was designed and manufactured. The design chosen was suited to the level of technology available in developing countries. Several blocks were produced and their densities and surface penetration resistance was measured. Two blocks were stabilised using cement, but these were not used in the experimentation as they were only intended to be demonstrator blocks.

The theoretical formulae suggested in (Parsons, 1992) were applied to the results attained during the dynamic compaction of full-sized blocks in 1997. The table below shows the increase in energy that was delivered by the impactor as the soil block was compacted. It also indicates the total transfer of energy into the block after a certain number of blows.

Table 2.3 – Summary of results of dynamic compaction conducted in 1997

Impactor stroke (m)	0.1364	0.1571	0.1661	0.1748	0.1814	0.1866	0.1913
Energy(J) / blow		55.5	58.7	61.7	64.0	65.9	67.5
Energy increase		7.3	3.2	3.1	2.3	1.9	1.6
Energy transferred after blows (J)	0 blows	1 blow	2 blows	4 blows	8 blows	16 blows	32 blows
	0	55.5	104	221	468	980	2035

Between the initial resting-place of the impactor and the resting-place after one blow there is a distance of  $(0.1571 - 0.1364) = 0.0207\text{m}$ . This is the deformation of the soil

during impact. The velocity of the impactor prior to impact can be assumed to be

$$V = \sqrt{2gh} = \sqrt{2 \times 9.81 \times 0.1364} = 1.64 \text{ m/s ...etc.}$$

Below is a table with the rest of the calculations for multiple blows during a compaction cycle using the above formulae.

Table 2.4 – Analysis of forces from dynamic compaction conducted in 1997

	<b>1 blow</b>	<b>2 blows</b>	<b>(3 blows)</b>	<b>(4 blows)</b>	<b>(8 blows)</b>	<b>(16 blows)</b>	<b>(32 blows)</b>
<b>Velocity prior to final impact (m/s)</b>	1.64	1.76	1.81	1.83	1.88	1.91	1.94
<b>Stopping distance (m)</b>	0.0207	0.0090	0.0043	0.0044	0.0016	0.0006	0.0003
<b>Mean deceleration (m/s<sup>2</sup>)</b>	64.6	171	375	384	1070	2800	6380
<b>Calculated stopping time (s)</b>	0.025	0.010	0.005	0.005	0.0018	0.0007	0.0003
<b>Pressure generated (MPa)</b>	0.057	0.152	0.332	0.341	0.948	2.488	5.656
<b>Dynamic modulus of deformation</b>	2.8E+6	1.7E+7	7.6E+7	7.8E+7	5.7E+8	3.8E+09	1.9E+10
<b>Mean force in tonnes (final impact)</b>	0.233	0.616	1.35	1.38	3.85	10.1	23.0

Note: The velocities and stopping distances for the blow numbers in brackets have been linearly estimated from compaction data for multiple blows. These figures are probably accurate to  $\pm 10\%$  and can only show the continued trend.

Two things are immediately obvious from the table of results above. Firstly, the dramatic increase in force that is applied during impact between the first blow and much later ones. Secondly, the dynamic modulus of deformation for a soil compacted in a confined manner increases as it becomes compacted. Therefore the characteristics and behaviour of the soil will change during the compaction process. This will make accurate modelling the compaction significantly more difficult than an unconfined soil with a constant dynamic modulus of deformation.

Gooding quasi-statically compressed a block to 9.7MPa and noted that it achieved a bulk density of 2038kg/m<sup>3</sup>. This compaction pressure equated to a transfer of 279J/kg. By comparison, Montgomery dynamically compacted a full size block to a bulk density of 2040kg/m<sup>3</sup> by applying 32 blows to it from a 36kg impactor. This block received a total of 2035J from the falling impactor. For a 10kg block this equates to approximately 204J/kg, some 26% less energy required than the quasi-statically compressed block, which is a significant saving. This research indicated that the savings in energy that Gooding had found could be extrapolated onto full size blocks and therefore warranted further research.

Montgomery also did not stabilise any of the full size dynamically compacted blocks as these were trials to test the feasibility of full size compaction. Consequently there are not any known characteristics of the produced blocks apart from a handful of penetrometer tests done on the freshly de-moulded blocks. These give little indication of the core strength and only sought to establish the level of uniformity of density throughout the block.

## **2.5 Chapter summary**

The assessment of different building materials at the beginning of the chapter helps to focus on the more appropriate materials that can be employed in developing countries. For environmental reasons clamp-fired brick and 'sandcrete' blocks not sustainable in the long term. Aerated cement blocks and kiln-fired blocks are large-scale industrial processes that require high levels of technology and are unsuitable for local block

manufacturing techniques. The only remaining material with any immediate promise is the compressed and stabilised soil block, which has a reasonable following in areas where the soil is suitable and fired-brick is scarce. However, this material is still inferior in performance to more advanced materials and needs to be improved to gain greater acceptance.

The potential for appropriate technology to help in this area has been seen already with the development of manual block presses in the 1950's (Cinva-Ram block press). It is hoped that technology may have a further role to play in improving the block manufacturing techniques still further. The project will be directed to provide a sustainable solution that is technologically appropriate and provides a significant improvement over existing processes.

An attractive option for cost reduction is the evidence that the cement content can be reduced if the material density is increased. However, current technologies that deliver increased material density are prohibitively expensive and are not economically attractive. There is evidence that an alternative method of compaction through the application of a dynamic blow may provide high levels of densification without the prohibitive machine complexity and cost. Earlier research into this area has indicated that not only is dynamic compaction a possibility for soil block production but also potentially is more energy efficient in compaction than quasi-static compression.

To date there has been very little experimentation into the application of a dynamic blow to compact a soil block. If the method does indeed have significant advantages over the more expensive hydraulically assisted high-pressure quasi-static compression

then this warrants further research into this area. Research will require the designing and development of a suitable experimental rig with a view to low levels of complexity and cost if it is to be transferred for use in developing countries. The academic understanding of dynamic compaction also seems to be highly limited and any research into this area should seek to explain some of the dominant mechanisms at work during the impact blow. This will require the close analysis of the impact blow and possible model generation to describe the actions taking place within the material throughout the compaction process.



### **3 Preliminary experiments with stabilised soil**

The previous two chapters identified the growing need for low-cost housing and the potential for dynamic compaction of CSSB to provide a low-cost environmentally sustainable alternative to existing walling materials. This chapter now focuses on the findings of early experiments conducted to improve the understanding of quasi-statically compressed stabilised soil and the processes involved in its production. Throughout these experiments several independent variables have been selectively altered and the effect on one or several dependent variables has been noted. These findings have aided the process of parameter selection for later tests to be conducted on *dynamic* compaction of stabilised soil, dealt with in the following chapter.

These preliminary experiments were conducted for several reasons. Firstly to reduce the large number of independent variables to a manageable number. Secondly to identify main relationships not covered in the literature. Thirdly to select (for those independent variables not held constant) what experimental values to use. And fourthly to assess experimental variability and hence select suitable sample sizes.

#### **3.1 Summary of input variables and output measures**

Many parameters can be varied in the production of stabilised soil. Careful experimental design will therefore be needed to minimise the number of experiments to assess key characteristics and relationships. For the moment we will omit mentioning the variables associated with dynamic compaction as they feature in the

next chapter. The ranges of input variables, as shown below, were largely determined by practical constraints.

- Moisture content – taken as a percentage of solid material (range 2-10%)
- Compression pressure – usually recorded in MPa (range 4-20MPa)
- Mould wall thickness (range 0.5-32mm)
- Size and shape of sample (tall and short cylinders and blocks)

Other input variables kept constant except where explicitly stated otherwise are:

- Soil type – including particle size distribution (soil-B)
- Cement content (5% by weight)
- Mould wall surface finish (machined to approximately IT10)
- Delay before compaction (5-10min)
- Curing period and conditions (100% humidity for 7 days)
- Ambient temperature and humidity (20°C and 35% relative humidity)

The output measures used to monitor the process are as follows:

- De-moulding force
- Projected Dry Density (P.D.D.)
- Wet Compressive Strength (W.C.S.)
- Non-destructive tests

These output measures give the basis for determining any trends from the results and will be used to identify the relationships between variables of interest.

### 3.1.1 Input variables

From the literature review there seems to be a number of relationships that need clarifying. For example, what is really happening with the water in the compacted sample? How does the quantity of water present at compaction affect the consolidation combined with the cement curing to achieve strength? Varying the water content during the tests may help us to determine what are the dominant mechanisms in action.

***Moisture Content (M.C.)*** – The previous chapter mentioned the problem of selecting the moisture content. The soil literature suggests one thing and the concrete literature another. The only solution is to explore different moisture contents to see what effects they have on both the achieved density and the final strength. Previous experiments using *Soil-A* investigated a range of moisture contents up to 10% (at which the samples became unmanageable). Consequently the moisture content used during the experiments ranged from 2 to 10%. 6% was deemed a good compromise between the different factors in achieving density and necessary strength, and was used as a normal value. Selected values for moisture content 2, 3, 4, 5, 6, 7, 8, 9 and 10%.

***Compression pressure*** – This can vary from very-low-pressure 1MPa to hyperpressure 20MPa. The majority of experiments employed 10MPa, but other pressures were looked at to discover trends within the material. Selected values for pressure 4, 6, 8, 10, 12 and 20MPa.

***Mould-wall thickness*** – The relative stiffness of the mould wall to restrain the pressures applied might have some effect on the degree of possible consolidation for a given energy transfer or pressure applied. The effect that this has on the compaction characteristics has not been explored previously. The mould wall thickness is of greater importance with dynamic compaction. It is believed that the forces applied to the mould walls during compaction are smaller and of much shorter duration than those occurring during quasi-static compression. Moulds from 0.5mm up to 32mm thick were used. Clearly the extra cost for much thicker moulds is a significant consideration and using the thinner moulds is much more attractive. Selected values for mould wall thickness 0.5, 2, 8 and 32mm.

***Size and shape*** – For research purposes it is inconvenient and expensive to manufacture full-size blocks to check each variable and characteristic. Indeed, previous dynamic compaction research had been carried out on 100mm diameter cylinders as opposed to blocks for this very reason. Similarly, after a few initial experiments on full-size blocks (290 × 140 × 90 mm), most experiments were conducted on small short cylinders (Ø54.4mm, approximately 45mm high). These cylinders were easier to manufacture, cure and test, than the full-size blocks that would also be produced later in the research. Extrapolation of findings from small cylinders to full-size blocks is not straightforward, however the *ranking* of properties at one scale is likely to be the same as the ranking at a different scale.

Unless specifically stated the input variables below have been kept constant throughout the experiments. The selection of those constant values is discussed each in turn:

**Soil type** – In the field this can vary considerably and it is known that some soils are more suitable than others for the production of CSSB. In the previous research conducted by Gooding a suitable soil was mixed from builders sand and kaolin clay. Some of this original soil (*Soil-A*) was still available in small quantities and consequently was used for a few initial experiments. Later on in the research a different soil using similar ingredients had to be mixed and this was called soil-B and was used for the remainder of the experiments. The analysis of Soil-A and B can be found in Appendix A.

**Cement content** – Cement is usually the dominant cost in CSSB production, so the reduction of its quantity is very desirable. The relationship between cement content and compressive strength has been well researched in the past so it is not necessary to investigate it further here. How much cement is necessary depends on three factors, the clay content of the soil used, the degree of compaction during moulding and the required wet compressive strength of the finished block. Previous stabilised soil research (Rigassi, 1995) has indicated that cement contents below 2 or 3% will not actually enhance the wet compressive strength or improve stabilisation. Consequently 5% by weight has been selected as the smallest amount of cement practical to employ for CSSB and has been used in the vast majority of the experiments.

**Mould surface finish** – Throughout the tests the moulds had a machined surface finish to an approximate tolerance grade of IT10.

***Delay before compaction*** – As soon as moisture is added to the dry soil/cement mixture the cement reacts chemically with the water. Any delay between adding the water and the material compaction should therefore be kept as short as possible. For research purposes any variation in the delay period between mixing and compaction should be minimised as this might have an effect on final properties. Typically the compaction occurs between 5-10 minutes after mixing of water into the mix. The order of production within a batch may also have an effect on the final sample characteristics and while this is not large it is a factor that requires addressing. Indeed it would be useful to know whether a significant loss-of-strength penalty is incurred when a period as long as say 20 minutes elapses between mixing a batch and making the final sample.

***Curing period*** – The vast majority of the tests conducted on stabilised soil had the soil curing for 6 days in a 100% humidity environment (samples placed in sealed bags containing water-saturated air). This was then followed by soaking for a further 24hours giving a total curing time of 7 days. This was a suitable period as many texts gave data for cement properties at 7 days and enabled reasonably quick feedback of results from tests.

***Ambient temperature and humidity*** – The experiments have been carried out under laboratory conditions, typically at 20°C and with a low relative humidity.

### 3.1.2 Output measures

The list below describes the set of different measures used for assessing the finished material after stabilisation and consolidation. Each measure was not carried out on every experiment, as this was often either impractical or impossible. For example the wet compressive strength of a compacted sample cannot be found if the sample has no cement. These measures have been the key method of identifying any relationships between input variables.

- De-moulding force – measured using the compression rig
- Projected Dry Density – calculated from measured bulk density
- Wet Compressive Strength – measured using the compression rig
- Non-destructive tests – penetration resistance and indentation size

*De-moulding force* – After compacting a CSSB in a mould it must be successfully removed from the mould without damage. The majority of small tests done using a compression machine involved a straight-sided mould and the compacted sample was pushed up from the bottom. Where possible, this ejection force was measured.

*Projected Dry Density (P.D.D.)* – The *dry density* is calculated from the dry mass of the solids divided by the volume of the material. Since we know the dry mass of the material prior to mixing and compaction we can calculate the P.D.D. of the material upon ejection. The P.D.D. gives an indication of the level of consolidation that has occurred irrespective of the water present in the sample. The bulk density measure includes the mass of the water in the density calculation and therefore yields a higher

value for density that can be misleading, especially where different moisture contents have been investigated. (Dry densities between 1900 and 2000 kg/m<sup>3</sup> are considered to be excellent for CSSB manufacture (Houben & Guillaud, 1989), (International Labour Office, 1987)).

***Wet Compressive Strength*** – Existing low-cement CSSB manufactured by low-pressure compaction have compressive strengths adequate for the majority of low-rise structures *provided that* water penetration is kept to a low level. However, when saturation of such CSSB has occurred it has often proved to be too harsh for the material to withstand whilst maintaining a load: surface flaking (spalling) or even collapse has followed. Wet compressive strength is measured by placing a cured and water-saturated sample between the jaws of a compression machine. Then slowly applying a force to the sample recording the maximum force sustained. Wet compressive strengths of over 2MPa are considered to be excellent for CSSB (Houben & Guillaud, 1989).

***Non-destructive tests*** – Some of the samples produced had tests performed on them to indicate characteristics such as the ‘green’ strength of the material. These tests were also conducted to try and develop surrogates for determining characteristics that could only be found otherwise by destroying the sample. A penetration test was used to determine the green strength of a formed block. This involves pushing a rod a specified distance into the surface of the block and recording the force required (usually done using a penetrometer). The green strength of the block will not depend on its cement content, as the cement particles will not have had time to hydrate and add any strength to the material. Another test, the indentation test, was also developed



specifically for the stabilised soil material as the penetrometer test proved unsuccessful in many circumstances. This test was developed towards the end of the research so unfortunately the number of tests conducted is relatively small.

### **3.2 Experiments employing full-size blocks of Soil-A**

A number of full-size blocks were produced early on in the project using *Soil-A* (the predecessor to *soil-B*) to learn about the interaction of variables using the quasi-static compression technique. A Brepak earth block press was available for block production that could deliver pressures of up to 10MPa and this was used to compress blocks with different moisture contents to 10MPa.

#### **3.2.1 The effects of moisture on strength**

The data included in Appendix G shows the measured results from 12 stabilised blocks that were produced using the Bre-pak machine using *soil-A* at four different moisture contents (4, 5, 6, 7% by weight) and a constant compression pressure of 10MPa. Due to an error in the mix calculation the cement content was 5.2% instead of the intended 5% which is a small error considering the variability of the material as a whole. The processing time for the production of each block was approximately 15 minutes to include dry and wet mixing of the material, compression and ejection.

Figure 3.1 below shows the variation in the 7-day W.C.S., the bulk density and the P.D.D. with moisture content. Increasing the moisture content from 4% to 7% delivers over 100% increase in strength yet only a 4% increase in bulk density and less than

1% increase in P.D.D. These results would seem to suggest that a higher water/cement ratio is in fact not as deleterious as originally anticipated. In fact the contrary seems to be the case.

Figure 3.1 – Strength, bulk density and P.D.D. variation with moisture content

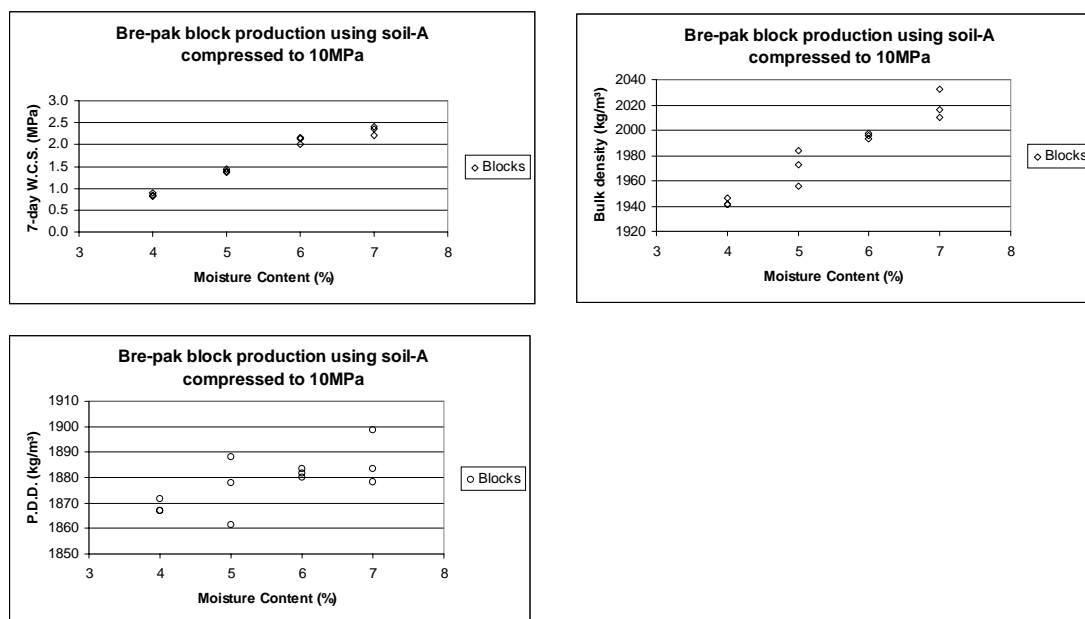

The graph indicates that there may be optimum moisture content for *strength*, as it would appear that the graph is levelling off above 7%. This could correspond to the optimum moisture content for *density* as described in the soil literature, but the shape of the graphs showing density do not confirm that this is the case. However, we can see that the increase in strength is in some way connected to the increase in density. Comparing strength and density on the same graph (shown in Figure 3.2) demonstrates the possible relationship that exists between the two output measures. Unfortunately, there is quite a bit of spread in the data presented and this makes it difficult to see any relationship clearly.

Figure 3.2 – Strength against P.D.D. for full-size blocks

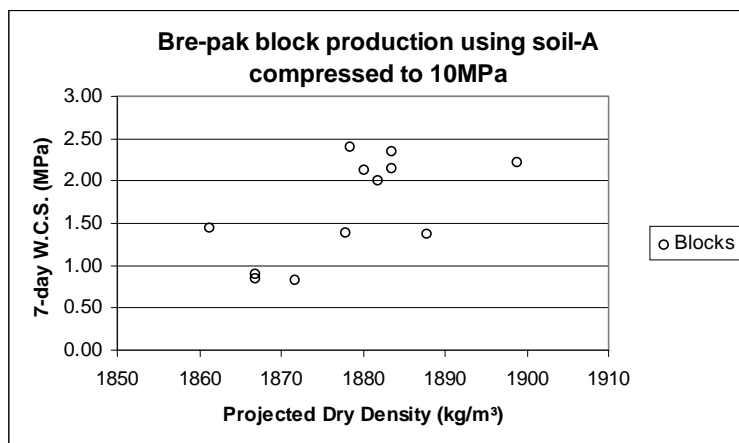

We believe that a denser material has a greater compressive strength, but we cannot conclude that 1% increase in P.D.D. alone can result in 100% increase in W.C.S. The extra water seems to be enhancing the strength of the material, a phenomenon that contradicts the cement literature. It is possible that additional water is permitting a better curing of the cement. However, when considering that the water/cement ratios for 4% and 7% moisture are about 0.8 and 1.4 respectively, these values are much higher than the recommended guidelines for concrete manufacture. Clearly the water content of the mix has a major effect on subsequent block properties.

### 3.2.2 Moisture content effects on penetration resistance

The results discussed in the previous subsection suggest that pushing the water content even higher than 7% would be advantageous to final strength. However blocks with a very high water content have so little green strength that they become unmanageable. The excessive quantity of water does not permit sufficient cohesion between particles and the blocks regularly break during ejection and subsequent handling. Consequently a compromise has to be made. CSSB texts mention the

problem of handling but fail to give any guidelines for production except by using trial and error. To address this question of green strength another set of seven blocks made from *soil-A* were produced in the Brepak machine. *soil-A* was used without cement, compressed to 10MPa and with a range of moisture contents from 2% to 8.7%. Immediately upon demoulding, a soil penetrometer was used to measure the penetration resistance up to a maximum pressure of 0.45MPa. Penetration sites were chosen on the surfaces of the block to determine if there was significant variation in surface strength in different portions of the block. Figure 3.3 below illustrates the penetrometer sites used.

Figure 3.3 – Penetrometer sites on a finished block

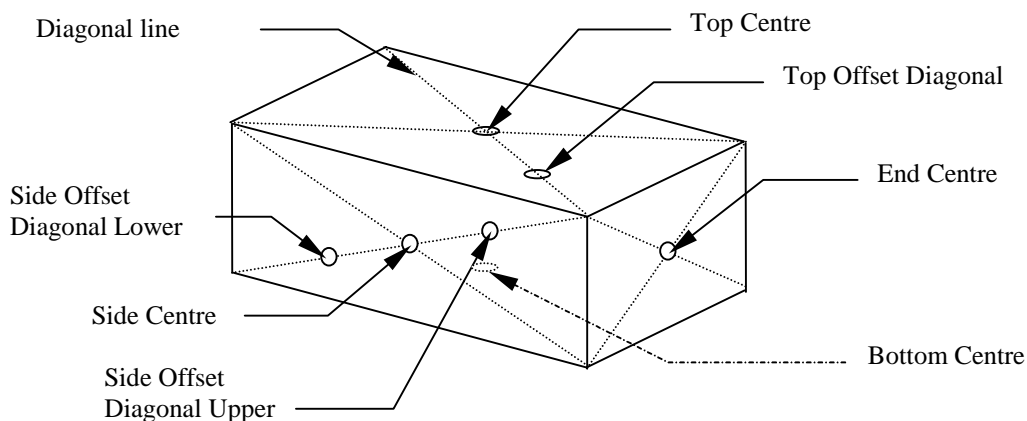

Some of the blocks with very low moisture content were impossible to penetrate successfully, whilst blocks with higher moisture permitted easy penetration. The data for these blocks is presented in Appendix G and a summary of the data is shown below in Table 3.1.

Table 3.1 – Penetrometer results from Brepak blocks

Moisture Content	%	2.0	3.1	4.2	5.3	6.4	7.5	8.7
Projected Dry Density	kg/m <sup>3</sup>	1831	1833	1831	1841	1851	1841	1863
Bulk Density	kg/m <sup>3</sup>	1857	1878	1896	1926	1958	1968	2013
Penetrometer Pressure (P <sub>p</sub> ) Average	MPa	N/A	N/A	N/A	0.43	0.28	0.22	0.18
(P <sub>p</sub> ) Standard Deviation	MPa	N/A	N/A	N/A	0.02	0.04	0.03	0.03
(P <sub>p</sub> ) Coefficient of variation	%	N/A	N/A	N/A	4.8	14.2	12.1	15.3

Note: N/A represents a reading that was off the scale of the penetrometer, (i.e. > 0.45MPa).

This data has been represented graphically in Figure 3.4 below concentrating on the effect of moisture on P.D.D. and penetration resistance. The relationship of increasing P.D.D. with moisture content that eluded us in the earlier experiment can be more clearly seen here, probably because the experiments covers a wider range of moisture contents. It is interesting to see that the penetrometer average plotted against the moisture content demonstrates that higher moisture levels yield lower penetration resistance and hence lower green strength. The fall in green strength, despite rise in P.D.D., suggests that the dominant mechanism controlling the green strength is the cohesion between particles and the amount of water that surrounds them rather than particle intimacy.

Figure 3.4 – P.D.D. and penetration resistance variation with moisture content.

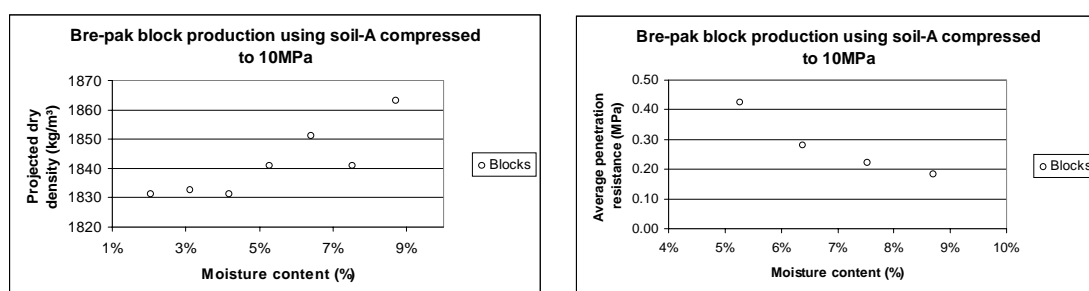

Both of the sets of results investigated so far have demonstrated that there is some relationship between density and strength. As the density is an easily measurable quantity and can be calculated immediately after block manufacture it is an attractive measure both for research purposes and for quality control in block production. As the production thus far has concentrated on the production of blocks at a single compaction pressure and therefore constant energy transfer there is little variation in the achieved density. In order to suggest a strength density relationship it is necessary to explore a wider range of densities and corresponding strengths. Exploration of this is not very practical using either the Brepak machine or full-size blocks due to the problems with the machine and the high material cost of making lots of blocks. Consequently a smaller scale test needs to be applied for further analysis of this phenomenon.

### **3.3 *Experiments employing small cylinders of soil-B***

Further tests were conducted at a different scale and with a slightly different material, but greater consistency could be assured with the new material and the smaller scale permitted much faster sample production. This scale of production also offered greater control and reliability than with the Brepak block press. Small cylinder production commenced with the development of a set of cylindrical moulds with different wall thickness including 0.5, 2, 8, and 32mm. All of the moulds had an internal diameter of 54.4mm and produced samples around 45mm high with a dry soil mass of 200g ( $\pm 0.5$ g). This was selected as a suitably small quantity that could be dumped into the mould without the need for tamping. Also, 200g was a round number for easier

calculation of water mass to achieve desired M.C. Furthermore a sample of this size could also be easily manufactured by dynamic compaction using a similar rig and the same moulds, as the next chapter will explain more fully.

A new soil had to be developed at this stage to accommodate the future tests that were to take place on small scale as well as full-size blocks. This material consisted of builder's sand and kaolin clay and was supposed to be similar to the original soil-A. The sand material was oven dried to 105°C and sieved down to 5mm prior to mixing with the kaolin in the ratio of four parts sand to one part kaolin. As the majority of the tests conducted required stabilisation, cement (5% by weight of the total mix) was also added to the dry mix.

### **3.3.1 Pressure density relationship**

Three separate investigations were carried out to determine the relationship between applied pressure and achieved density. The development of this relationship specific to soil-B was necessary in order to assess the effectiveness of dynamic compaction against a suitable standard. As dynamic tests were also going to be conducted at small scale this relationship would provide a good means of comparison between the two different compaction techniques. The first investigation involved the compression of three samples at three different moisture contents, 6, 8, 10%, and monitoring the density within the mould during the compression cycle up to 20MPa. The second investigation produced compression curves for three sets of three samples at 6% M.C. soil-B compressed to 8, 10 and 12MPa. The third investigation produced five sets of three samples at each of the following pressures 4, 6, 8, 10 and 12MPa and

subsequently cured and crushed them to discover their compressive strengths. The data for all three investigations can be found in Appendix F.

The figure below shows a summary of the results of the first and second investigation measuring the P.D.D of the samples during the compression cycle. The left hand graph clearly shows that the further increase in moisture content to 10% increases the level of compaction achieved above 8% and 6% levels, which is consistent with the relationship suggested by the soil literature. It also indicates the elasticity of the material when the compression pressure is reduced to zero. Each curve represents the average of three sets of samples taken for each moisture content. On the right side is the graph showing the data from the second investigation displaying the compression curves for 8, 10, 12MPa and their respective elastic restitution for the single moisture content of 6%.

Figure 3.5 – Pressure density relationship for soil-B

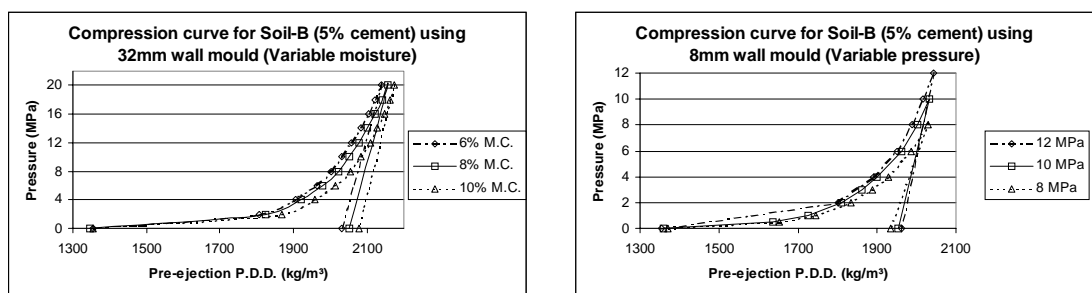

From these graphs we see that the P.D.D. that can be achieved by 10MPa pressure will be around 1950kg/m<sup>3</sup> for the 6% M.C. condition. This will be taken as the target for the dynamic compaction tests to confirm the potential of dynamic compaction providing the necessary degree of consolidation. The moisture content of 6% was



selected for these tests, as it seemed to be a good compromise between final strength and green strength that could be used on the full-size tests later.

Figure 3.6 below displays the data for the third set of samples produced under different compression pressures. Each point represents the average of three points of data and this most easily demonstrates the general trend of increasing pressure leading to increased P.D.D. and subsequent 7-day W.C.S. It was noticed that the variation within the batches was quite high and this led to questions regarding moisture loss or decreased workability over time in each batch.

Figure 3.6 – Results of compression tests on soil-B at 6% M.C.

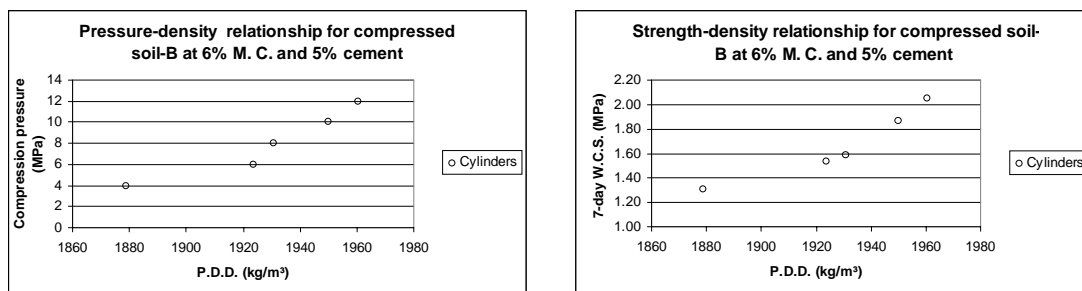

It has been hinted at already that there may be some connection between the achieved density and the 7-day wet compressive strength. The data collected from the third investigation can be presented to demonstrate this phenomenon. Unfortunately the variation in the strength is quite high for each P.D.D., which indicates that if a relationship is developed between strength and P.D.D. it might not be very accurate. Statistical analysis of the variation is required to provide a relationship with any degree of certainty. The figure below shows the general trend that increasing the density has a significant increase in the strength. It indicates that a 5% increase in

density yields an increase in strength of approximately 50%. Such a relationship would suggest any small increase in density would be greatly advantageous.

Figure 3.7 – Strength density relationship for soil-B at 6% M.C.

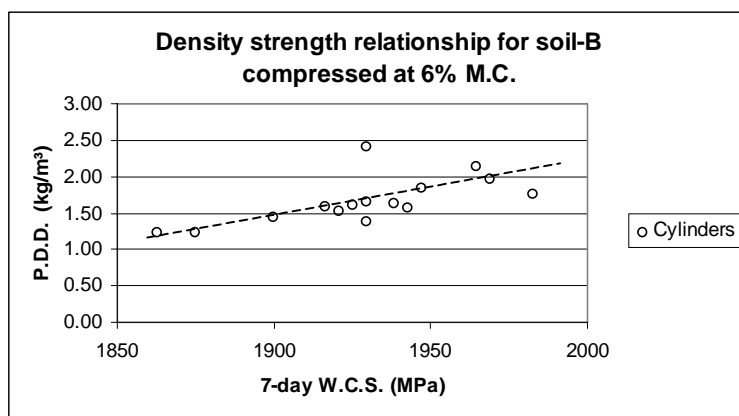

The figure below diagrammatically represents some of the inter-relationships that can now be suggested from the experiments conducted.

Figure 3.8 – Inter-relationships of pressure and water content with outputs

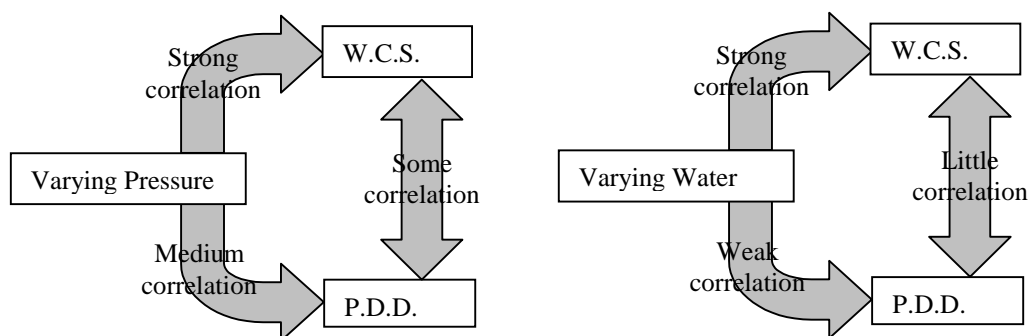

### 3.3.2 Assessment of de-moulding forces

The third investigation above also provided the opportunity to investigate the forces required ejecting different density samples from a mould. Analysis of de-moulding forces has been omitted from all of the CSSB texts and is investigated here to help with machine design. The forces necessary to eject a full-size block from a mould are often of significant magnitude to warrant a separate ejection mechanism and these tests will indicate possible forces necessary. The small size of these cylinders will have a significant effect on the magnitude of the ejection force compared to a full-size block, but it is hoped that the relative size of the forces for different levels of compression will be representative. This study may also indicate whether or not any difference in the de-moulding force exists between quasi-statically compressed samples and dynamically compacted samples. Data from these squeezed cylinders will be used later with data from impacted cylinders.

The table below is a summary of the data from the third investigation described in the previous subsection. Three samples were produced at each pressure and the averages of the values are shown. Full results can be found in Appendix F.

Table 3.2 – Summary of data for compressed small cylinders at different pressures

Pressure	MPa	4	6	8	10	12
Energy Transfer	J	54	70	83	97	111
Ejection force	kN	0.5	0.5	1.1	1.1	1.2
Ejected height	mm	45.8	44.7	44.6	44.1	43.9
Bulk Density	kg/m <sup>3</sup>	1992	2039	2047	2067	2078
P.D.D.	kg/m <sup>3</sup>	1879	1924	1931	1950	1960
7-day W.C.S.	MPa	1.31	1.53	1.59	1.87	2.05

The graphical view of the variation in ejection force with compression pressure can be seen in the figure below. It demonstrates that ejection force is roughly proportional to moulding pressures. It should be noted that many of the data points are overlapping each other in the graph, hence less than 15 points are visible. If we assume that the ejection force is a function of both the compression pressure and the mould wall area in contact with the sample, then we may be able to suggest a formula to determine the ejection force required for full-size blocks.

Figure 3.9 – Ejection force analysis for different compression forces

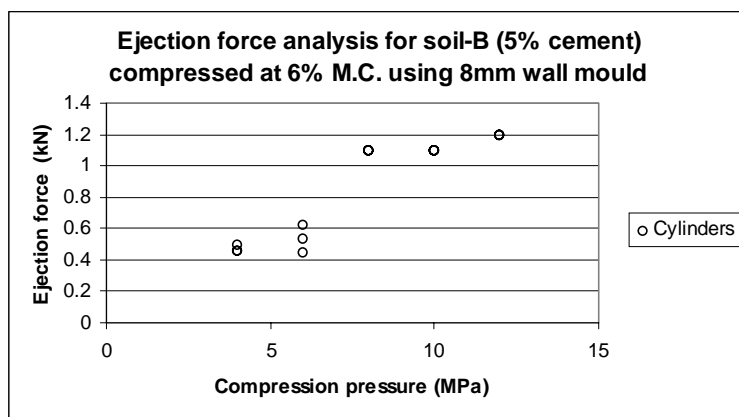

The mould wall area for a small cylinder is  $0.0076\text{m}^2$ . This equates to an ejection shear stress (force per unit area of mould wall area) of approximately  $145\text{kPa}$ . A standard block is  $0.29 \times 0.14 \times 0.09\text{m}$  and hence has a mould wall area of  $0.0774\text{m}^2$ . This yields a *projected* ejection force of  $12.5\text{kN}$  for a full size block with 6% M.C. compressed to  $10\text{MPa}$ . The actual (measured) ejection force for a block compacted to  $9.7\text{MPa}$  using soil-B at 6% M.C. was between  $15\text{-}20\text{kN}$ . These results are of the same order of magnitude and will be useful for machine design.

### 3.3.3 Strength variation in cylindrical samples

In order to accurately assess interrelationships between variables we need to know the inherent variability of the material in use. Earlier experiments indicated significant variation in the ejected densities of the cylinders produced using quasi-static compression. This density variation has an effect on the wet compressive strength of the material. We do not know what the variation in the strength within the material is for different samples all compressed to similar densities. To discover the actual variation in the material strength and to discover if there is a statistically significant difference between the first of the batch and the third in the batch a further set of small cylinders were produced.

A total of 18 samples were all produced by compressing soil-B with 6% M.C. to 10MPa. The batch size was three, and each of the first, second and third within each batch were averaged together investigating the Projected Dry Density, 7-day Wet Compressive Strength and Ejection Force. If a large difference exists between the first and the third in the batch, a statistical test can be applied to these results to determine whether or not the results could have come from the same data set. If the test shows that they do not come from the same data set then it can be assumed that there is a significant difference in the two sets of data. The diagram below illustrates the statistical theory of this test.

Figure 3.10 – Statistical test for difference between two data sets

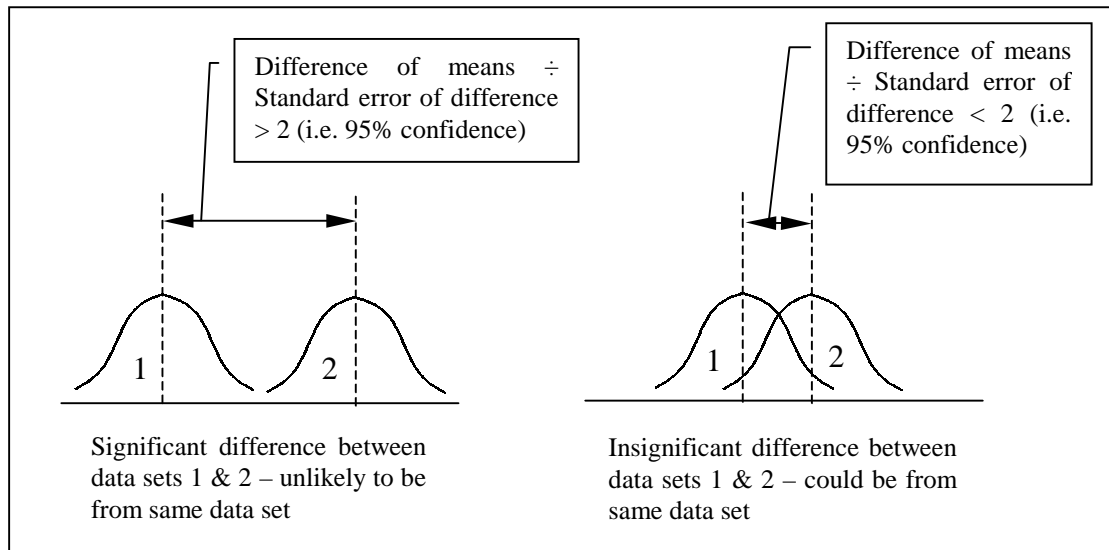

The data presented in Appendix F has been analysed below in Table 3.3a, b and c using the standard error of difference test. The test used deems that a significant difference between sets of data exists if the difference between the two sample means is greater than 2 times the standard error of difference (giving a 95% level of confidence for a normal distribution).

Knowing that strength is highly sensitive to changes in density it is not surprising to find that the coefficient of variation of strength is an order of magnitude larger than the coefficient of variation for density. The data also highlights the large variation that is experienced in the ejection force required to eject compressed samples from the mould. This will partly explain the difference between the extrapolated ejection force from small cylinders and the measured ejection force for full-size blocks.

Table 3.3a – P.D.D. variation in cylindrical samples compressed to 10MPa

Order in batch	Units	First	Second	Third
Average of P.D.D. of samples (a)	kg/m <sup>3</sup>	1950	1938	1934
Estimate of population S.D. from samples	kg/m <sup>3</sup>	9	13	8
Coefficient of variation	%	0.4	0.7	0.4
Standard error of (a)	kg/m <sup>3</sup>	3.5	5.2	3.4

Difference of means (1st & 3rd)	kg/m <sup>3</sup>	15.3
Standard error of difference (1st & 3rd)	kg/m <sup>3</sup>	4.9
DoM/ SED	kg/m <sup>3</sup>	3.1
Significance (Normal distribution)	%	99.8

Sample  
size  
n = 6 (×3)

Table 3.3b – 7-day W.C.S. variation in cylindrical samples compressed to 10MPa

Order in batch	Units	First	Second	Third
Average of 7-day W.C.S. of samples (a)	MPa	1.76	1.61	1.63
Estimate of population S.D. from samples	MPa	0.09	0.13	0.11
Coefficient of variation	%	5.3	7.8	7.0
Standard error of (a)	MPa	0.04	0.05	0.05

Difference of means (1st & 3rd)	MPa	0.14
Standard error of difference (1st & 3rd)	MPa	0.06
DoM/ SED	MPa	2.27
Significance (Normal distribution)	%	97.7

Sample  
size  
n = 6 (×3)

Table 3.3c – Ejection Force variation in cylindrical samples compressed to 10MPa

Order in batch	Units	First	Second	Third
Average of Ejection force of samples (a)	kN	0.95	1.07	1.13
Estimate of population S.D. from samples	kN	0.18	0.14	0.09
Coefficient of variation	%	18.9	13.4	8.0
Standard error of (a)	kN	0.07	0.06	0.04

Difference of means (1st & 3rd)	kN	0.18
Standard error of difference (1st & 3rd)	kN	0.08
DoM/ SED	kN	2.17
Significance (Normal distribution)	%	97.0

Sample  
size  
n = 6 (×3)

These results give us the needed information about the inherent variability of the material. Density variation is of the order of 1% throughout a batch, whilst strength variation is around 10%. This demonstrates adequate control of the production process and gives us confidence in making assertions with data sets that differ significantly more than experienced here. A more worrying trend in the above data is every

characteristic of interest has a significant difference between the First and Third members of each batch. This clearly suggests that something out of our control is happening to the sample during the 5-10 minutes between the first and the third sample in the batch. Despite the small variation in these characteristics of interest, a larger variation would be more typical during a normal production regime. Whilst a variation of 1% on density during these strict laboratory tests is tolerable if this were to increase to say 5% in the field, a then a much more significant variation of around 50% of strength would result. For further laboratory tests a sample set of three should be sufficient for determining the characteristics of a sample with selected parameters.

### ***3.4 Block characteristics that help to reduce construction costs***

In the interests of reducing walling costs, a number of techniques have been assessed particularly with a view to incorporation into block manufacture using dynamic compaction. These subsections detail several methods of cost reduction available to the block manufacturer, some of which can also save costs in wall construction. Our desire is to find a method, or combination of methods, that significantly reduce the total cost of the building unit, which we hope to apply to the production of blocks made via dynamic compaction.

#### **3.4.1 Material reduction**

The raw material used in producing a block has a cost associated with it, both in terms of the actual material used and any associated transportation costs. Reducing the raw material will reduce the cost of the block, and placing indentations or perforations in a



block can be an effective way of achieving this. In order to remove significant amounts of material from the centre regions of a block there must be sufficient block width to accommodate the voids left behind. Also the minimum material thickness needs to be carefully chosen so that the material does not become too weak to support the necessary loads. The drawback to including any perforations or voids in a block is that it increases the mould complexity and reduces the ease of block manufacture, particularly block ejection.

According to the graph in Figure 2.12, a sample with 10% cement and compressed to 4MPa has a wet compressive strength of 3MPa. A standard block with dimensions  $0.29 \times 0.14 \times 0.09\text{m}$  and an approximate bulk density of  $2060\text{kg/m}^3$  would have a cement mass of around 0.7kg. If the compaction pressure was increased to 10MPa, then cement content could drop to 8% and still achieve the same 3MPa compressive strength. The block now has a bulk density of  $2160\text{kg/m}^3$  and would have cement mass of around 0.58kg present in it. A 150% increase in pressure results in only an 18% drop in cement content. This has already been shown to be a false economy in quasi-static compression because this extra moulding pressure seriously increases the machine cost and complexity.

If half of the material present in the block is removed then the cement mass would naturally drop to 0.28kg per block which is less than half the amount required for the block compressed to 4MPa. This material removal could be achieved by the inclusion of voids in the material, an already popular technique. The higher density of the material would yield sufficient strength for forming and handling and whilst the absolute load that the block could sustain would be less, the compressive strength

would still be within the required limits. This option would not be possible with blocks of lower densities, as they would not be strong enough to have such large voids placed in them and still be strong enough for forming and handling.

### **3.4.2 Tall thin blocks**

The ratio of a block's height to width is its' slenderness ratio (height/width), (Norton, 1997), (Keable, 1996). For most blocks this slenderness ratio is not more than 1 but with some more advanced materials it can be as high as 2. If the height of the block is large then this will reduce the number of blocks necessary to fill the same area of walling. In order to maximise the use of the material therefore we want to have a high slenderness ratio and a large surface area of the external face of the block. Requiring fewer blocks per square meter of walling also reduces the amount of mortar required between block courses. Increasing the slenderness ratio reduces the volume of material required per square meter of walling, whilst only increasing the block height makes reductions in the quantity of mortar that is required. Increased slenderness may be more difficult to achieve with CSSB than increasing the block height, so for the moment we will concentrate on this alone.

Throughout this project we wish to reduce the cement consumption of the walling as much as possible. It is possible to calculate the projected cement requirements of different walling strategies using blocks of different characteristics. One of the characteristics that can be adjusted in this study is the block height. This increases the amount of cement required in the material, mortar and render per block, but actually decreases the overall cement requirement per square metre. Although the decrease was

quite small, if also applied to blocks with less cement in the material, laid with thinner mortar and without any render then significant combined savings can be made.

The application of tall thin blocks presents an issue of stability that needs to be considered. We can compare different walling materials and their structural modes of failure to consider the implications of tall thin blocks for walling. If house walls 'fail', it is usually by surface erosion, by overturning or by internal material changes like swelling. To prevent erosion we require adequate surface properties such as hardness or wet compressive strength that are unaffected by whether or not the building blocks are hollow. To prevent overturning we look first to architectural measures such as providing adequate foundations, connecting perpendicular walls or constraining the outward thrusts from the roof. However the block properties also affect a wall's ability to resist horizontal forces applied to its top. Increasing both block mean density ( $\rho$ ) and wall thickness (Block width  $b$ ) are beneficial.

Although there are various overturning failure modes, almost all have a force threshold determined by  $\rho b^2$ . For example the formation of a hinge at the wall bottom (assuming the mortar has no tensile strength) occurs when  $F = \rho g b^2 / 2$  where  $F$  is the outward force per unit length of a wall. The table shown below compares different materials by this criteria. Note: employing hollow blocks instead of solid ones lowers  $F$  because it lowers the mean block density  $\rho$ .

Table 3.4 – Assessing the failure force for different blocks

Material	Wall Thickness (b)	Mean Density ( $\rho$ )	Failure Force (F)
	m	kg/m <sup>3</sup>	N/m
Single skin brick	0.105	1350	74
Double skin brick	0.220	1350	327
Solid cement block	0.150	2200	248
Hollow (50%) cement block	0.150	1100	124
Foamed cement block	0.140	480	47
Low-density solid CSSB	0.140	1700	167
High-density solid CSSB	0.140	2000	196
High-density hollow (30%) CSSB	0.140	1400	137

The above table illustrates why double skin brick and solid cement blocks are most favourable for taller structures as they have the highest failure force. For the purposes of low-rise dwellings this is not necessary and consequently a lower failure force can be accommodated. High-density solid CSSB is a good contender in terms of failure force, but if the walling material were made even thinner then it may not be quite so appropriate.

### 3.4.3 Cement rich skin

As an alternative to reducing the cement content of the block to low quantities, it may be possible to concentrate the cement in the area where it is needed most, i.e. the exterior surface. This cement rich layer would effectively be acting as a built in layer of render protecting the less stable material behind it from the elements. For example instead of having 5% cement throughout the block one could put 10% cement in the first 20mm and have the rest of the block stabilised with only 3% cement. Providing that the cement rich layer did not suffer from de-lamination from the rest of the block,

this could reduce the cement demand for each block. Catastrophic de-lamination is reduced because the block contains cement and the courses of blocks are joined with a cement based mortar.

The production of such blocks with this cement rich layer greatly increases the complexity of the block production and construction process. A clear means of identification would be necessary to indicate which face of the block was cement rich, and furthermore the staff erecting the structure would need to be trained to lay the blocks in the correct manner. Homogenous blocks would also be necessary for the corners and any exposed edges, adding another type of building material to the construction. The calculations carried out on this type of construction shows that the saving in cement is only a modest 13%.

#### **3.4.4 Summary of cost reduction methods**

The table below summarises the different possible variants that can be accomplished with the CSSB and how each one performs with reference to the unmodified CSSB. By combining several of these variants into a single block the material can theoretically achieve a tolerable cement requirement, (less than 15kg/m<sup>2</sup>), without excessive energy consumption. The tall, hollow, interlocking block as described below even uses less cement than the clamp fired bricks assessed in Table 2.1. As this is one of the more common and more wasteful methods of making satisfactory building materials, this confirms that this variant of CSSB is a real contender. The raw data for this comparison can be found in Appendix E.

Table 3.5 – Theoretical comparison of different CSSB variants

Material	Dimensions ( $l \times b \times h$ )	Note	Energy	Cement	Suitability for production	
					'Locally'	On-site
High-density CSSB	Mm		MJ/m <sup>2</sup>	kg/m <sup>2</sup>	Ranking (1 = best)	
Normal	290 × 140 × 90	1	290	18.7	2	1
Hollow	290 × 140 × 90	2	220	15.1	2	1
Cement-rich skin	290 × 140 × 90	3	270	16.3	1	2
Interlocking	297 × 140 × 97	4	270	15.4	2	1
Tall	290 × 140 × 90	5	280	17.6	2	1
Rendered	290 × 140 × 140	6	300	19.3	2	1
Tall, Hollow, Interlocking	297 × 140 × 147	7	190	11.0	2	1

Notes

1. High-density (2000kg/m<sup>3</sup>) solid blocks manufactured on-site from local soil/cement mix (5% cement), laid with 10 mm of soil/cement mortar (20% cement) and no render, (Cement transported 100km).
2. As 1. but with 30% material remove from the block core.
3. As 1. but with 10% cement in first 20mm of exterior block surface and 3% in the body of the block.
4. As 1. but constructed with thin mortar only 3mm thick.
5. As 1. but with increased block height to 140mm to reduce mortar per square metre.
6. As 1. but with 15mm render on a block with only 3% cement in the body of the block.
7. As 1. but with a combination of tall, hollow and interlocking arrangements.

Apart from the improvements that can be offered by increased material compaction, there are modifications that can be made to the shape and size of the CSSB to minimise material costs. The addition of perforations in the block could reduce the material cost by as much as 30%. Furthermore the improvement of dimensional tolerances of the block could promote the use of thinner mortar between block courses. The application of taller blocks would also reduce the number of courses that need mortaring. A combination of these block features has indicated significant saving in cement and shows the most promise for providing lower-cost walling.

### 3.5 Chapter summary

Throughout this chapter experiments on stabilised soil have been conducted to assist the understanding of CSSB characteristics and production. The variables that exist in the process have been identified and possible relationships that may exist between variables and output measures of interest have been suggested. Experimentation had indicated that the moisture content of the sample has a large effect on the achieved density but also on the achieved strength. The strength seems to be directly related to the density achieved for given moisture content. The general trend that an increase in density of 10% yields a 100% increase in strength has been suggested.

Figure 3.11 – Revised inter-relationships between pressure and water with outputs

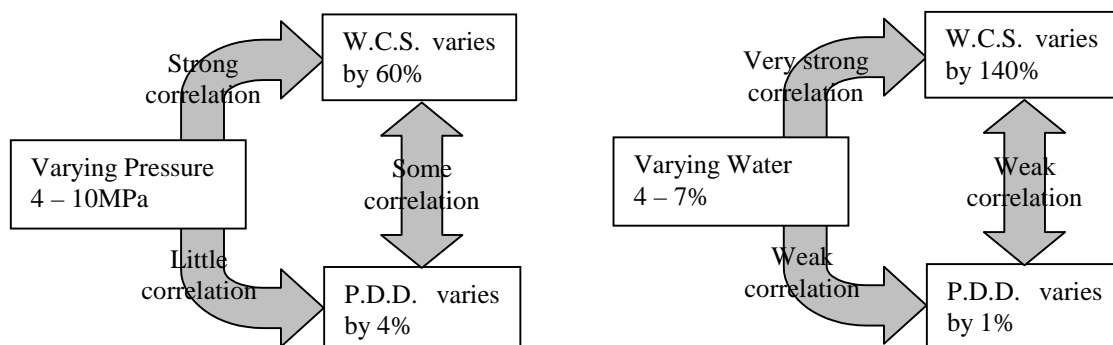

Investigations on small cylinders have given an improved understanding of the pressure-density relationship, which will be very useful for comparative tests on dynamic compaction. The aim during future tests will be to achieve a projected dry density of at least 1950kg/m<sup>3</sup> as this is representative of compression to 10MPa. These tests have also indicated the ejection forces required to de-mould a sample and that it is roughly related to the compaction pressure and mould wall area. It will be interesting to see if the process of dynamic compaction yields significantly different values for the ejection force at similar achieved sample densities.

A more concerning discovery has been the significant variation in the achieved density and strength of samples produced in the same batch a short time apart. The variation in density is only around 1% but this in turn results in a 10% variation in strength. It would be excellent if variation during regular block manufacture could be kept as low as this; however, this is highly unlikely because of the more strict production methods used during research. It does indicate that for the sample size selected, the variation achieved is on the lower limit of practical significance and therefore the sample size of three is acceptable for future tests. The reason for this variation has yet to be determined; it may be linked again to moisture, as it seems unlikely that the cement would be providing any resistance to the consolidation process after such a short period of time. For research purposes full-size block production typically has a batch size of 1 block per batch so this problem should not plague later tests, but it will need to be considered during future batch tests and for block production generally.

After conducting the experiments described in this chapter we feel more confident about working with the soil in question. We have gained a better understanding of its performance under compression and its characteristics at different achieved densities. Armed with this knowledge we can now proceed to investigate the application of *dynamic* compaction and assess its performance against quasi-static.



## **4 Dynamic compaction of stabilised soil**

The experiments described in the previous chapter concentrated on tests using stabilised soil. These tests have enhanced our understanding of how soil (specifically soil-B) behaves during constrained consolidation. This chapter extends the investigation to include dynamic compaction of this soil, initially as small cylinders and then as full-size blocks. This will be a lengthy chapter, as the majority of the experimental results from the Ph.D. will be presented here. After briefly discussing the reasons for selected methods of experimental practice and outlining some new variables of specific interest to dynamic compaction, the relationships that exist within dynamic compaction will be presented and explored. This will then be followed by results taken from full-size tests and finally a comparison of the dynamic compaction process with the quasi-static compression process will be made.

### ***4.1 Experimental design***

#### **4.1.1 Sample size selection**

The experiment conducted earlier on small cylinders, quasi-statically compressing them to 10MPa (described in subsection 3.3.3), indicates that for a sample set of six (the first member of a batch of three taken from six separate batches) the coefficient of variation is around 0.5% of the density. This variation in turn results in a variation of 5% in strength, which is a tolerable variability for experimental purposes. It demonstrates quite a high degree of repeatability within the material and the process

of production used. The variability test will need to be repeated for the new production method of dynamic compaction of both small cylinders and full-size blocks to confirm a similar variation. As discussed below, the variation was similar and a sample size of three was selected for small cylinder production. The sample size necessary for full-size block production will be examined experimentally as well.

The variability of the dynamic compaction process for small cylinders was investigated by making 18 cylinders of soil-B stabilised with 5% cement. Each cylinder received 16 blows from a 5kg impactor being dropped from 0.2m. The cylinders were produced with a batch size of three and the respective first, second and third members of each batch formed 3 samples each of six members. The ejection force was measured, the P.D.D. of each cylinder was calculated upon ejection and the 7-day wet compressive strength was measured for each cylinder. The results in the tables 4.1a, b and c below show the variation experienced with this method of production for three output measures.

Table 4.1a – P.D.D. variation in dynamically compacted cylindrical samples

Order in batch	Units	First	Second	Third
Average of P.D.D. of samples (a)	kg/m <sup>3</sup>	2022	2010	1998
Estimate of population S.D. from samples	kg/m <sup>3</sup>	9	5	5
Coefficient of variation	%	0.5	0.3	0.2
Standard error of (a)	kg/m <sup>3</sup>	3.80	2.10	1.95

Difference of means (1st & 3rd)	kg/m <sup>3</sup>	23.50		
Standard error of difference (1st & 3rd)	kg/m <sup>3</sup>	4.28		
DoM/ SED	kg/m <sup>3</sup>	5.49		
Significance (Normal distribution)	%	>99.9%		

Sample size  
n = 6 (×3)

Conclusion: There is a statistically significant drop in density of 1.1% between the First and Third members of each batch.

Table 4.1b – 7-day W.C.S. variation in dynamically compacted cylindrical samples

Order in batch	Units	First	Second	Third
Average of 7-day W.C.S. of samples (a)	MPa	2.38	2.23	2.12
Estimate of population S.D. from samples	MPa	0.14	0.15	0.18
Coefficient of variation	%	6.1	6.5	8.3
Standard error of (a)	MPa	0.06	0.06	0.07

Difference of means (1st & 3rd)	MPa	0.25
Standard error of difference (1st & 3rd)	MPa	0.09
DoM/ SED	MPa	2.72
Significance (Normal distribution)	%	99.3

Sample  
size  
n = 6 (×3)

Conclusion: There is a statistically significant drop in W.C.S. of 11% between the First and Third members of each batch.

Table 4.1c – Ejection force variation in dynamically compacted cylindrical samples

Order in batch	Units	First	Second	Third
Average of Ejection force of samples (a)	kN	1.33	1.35	1.36
Estimate of population S.D. from samples	kN	0.15	0.10	0.12
Coefficient of variation	%	11.6	7.4	9.0
Standard error of (a)	kN	0.06	0.04	0.05

Difference of means (1st & 3rd)	kN	0.03
Standard error of difference (1st & 3rd)	kN	0.08
DoM/ SED	kN	0.34
Significance (Normal distribution)	%	26.6

Sample  
size  
n = 6 (×3)

Conclusion: There is no statistically significant difference in ejection force between the First and Third members of each batch.

From the results above it is now possible to suggest that the process of dynamic compaction does not add any further variation to the P.D.D. or the 7-day W.C.S. of small cylinders than did the quasi-static compression process. A variation of about 1% in density across the batch still exists and approximately 10% variation in 7-day

W.C.S. still applies. Greater comparison between the dynamic compaction method and the quasi-static method will be done later in this chapter.

For practical reasons we wished to make several ( $n$ ) specimens from each batch. Increasing  $n$  will reduce the variance of the sample mean about the population mean, which is good. Unfortunately it will also introduce a bias. If we choose a sample size of  $n$ , we reduce the Coefficient of variation of our estimate of the population mean by a factor of  $\sqrt{n}$ , which is good. Unfortunately to get  $n$  samples from a single batch entails the passage of time, so that the last member of the batch has a longer time delay before compaction than the first member. This variation in production time will therefore introduce a new source of variation in P.D.D. We hoped that 3 would be a sufficient sample size  $n$ . From the table above we see that:

- (a) with  $n = 3$ , the Coefficient of variation is  $< 0.5 \div \sqrt{3} = 0.3\%$ .
- (b) with  $n = 3$ , due to increased production time, the average will be biased downwards by typically 0.5%, (varying with the speed of production)

Such a small variation is at the lower limit of practical significance and consequently we can continue to use a sample size of three,  $n = 3$ .

This analysis confirms that using a sample size of three would be acceptable experimental design for investigation of small cylindrical samples, but no assumptions can be made with full-size blocks as yet. In order to check the variability of producing full-size blocks, a set of five blocks was produced by dropping a 36.8kg impactor approximately 300mm onto the surface of soil-B (0% cement). Only eight blows were applied during the production of each block, resulting in a relatively low P.D.D. The results in the table below show the average of the measured block height and the

calculated P.D.D. for five blocks. It clearly indicates that the variation of the process of dynamic compaction is still of the order of 0.5%. As these blocks were not made with cement it is not possible to determine the variation of the 7-day W.C.S., but this is assumed to have the same relationship with density as seen before.

Table 4.2 – Variation in P.D.D. for full-size blocks

Block Number	No. of blows	Block Height mm	Block P.D.D. kg/m <sup>3</sup>
1	8	113.4	1738
2	8	112.7	1748
3	8	113.6	1735
4	8	112.6	1750
5	8	112.2	1756
Standard Deviation			9
Coefficient of variation			0.5%
Coefficient of variation of mean of 3			0.3%

From these tests it is now possible to say with greater assurance that the inherent variation of the consolidation of soil-B results in a variation of less than 1% of P.D.D. and less than 10% of 7-day wet compressive strength. Consequently experimentation can now begin to look for characteristics within dynamic compaction that yield changes in results greater than normal variation. These changes will give indications to relationships between input variables and help to improve our understanding of the process.

#### **4.1.2 Primary measure of performance is P.D.D.**

In the majority of the tests presented in the following sections, the Projected Dry Density (P.D.D.) has been used as a primary measure of performance to monitor sample and block production. This measure has already been indicated as a suitable

measure for compaction and possible strength prediction. The P.D.D. of the compacted material is used to monitor the relative levels of compaction between samples or blocks produced using different production variables. This immediate measure has been very useful in determining the dominant variables without having to wait for feedback data from the wet compressive strength test.

It should be noted at this time that the method of measuring the samples needs to take into account the possible variation in the shape of the sample. Dynamically compacted small cylinders typically exhibited a small slope on their top surface. The cylinder diameter remained constant throughout the tests but the height had to be averaged from the highest and lowest point on the cylinder circumference. The variation in height was usually only between  $\pm 0.3 - \pm 0.6\text{mm}$ , but this is significant in a such a small sample. Full-size blocks exhibited this same phenomenon and consequently the block height had to be measured at six points on the surface of the block.

Figure 4.1 – Six block height measuring points

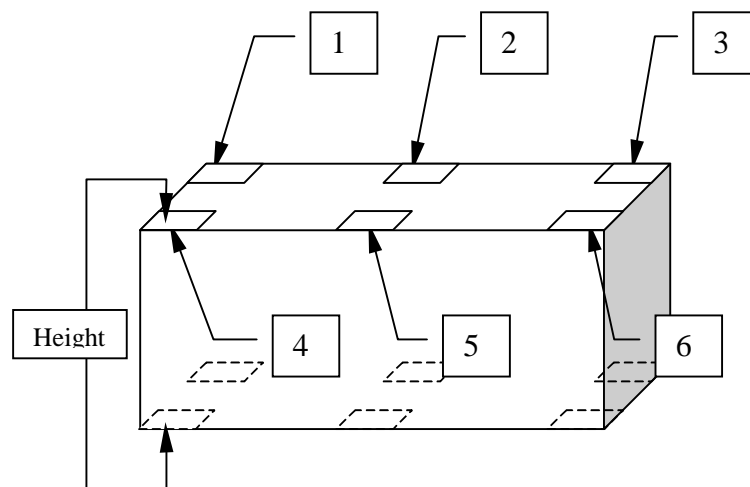

## **4.2 Variables of dynamic compaction**

The process of dynamic compaction presents not only new challenges in the method of application but also new variables that will need to be assessed for significance and subsequently optimised. The impactor mass, drop height and number of blows have all been investigated before but these parameters need to be extended to cover both small cylinder and full-size block production.

**Impactor mass** – Previous research conducted on dynamic compaction of soil indicated that a larger impactor mass was generally better than a smaller one. The limitations therefore imposed on the impactor design are ones of practicality, safety and cost. For the small cylinder production the following range of impactor masses were used: 2.5kg, 5kg and 10kg. However for full-size block production a range of larger impactor masses was used during the tests including 36.8kg, 46.8kg and 60.0kg.

**Drop height** – Apart from the practical limitations and safety issues of lifting a large heavy mass through a large height, there is evidence to suggest that a large drop height is undesirable for confined soil compaction (see subsection 2.4.2.) This was seen with samples produced by the application of one or two blows with high momentum. The effect of this high momentum transfer apparently resulted in a shock wave rebounding off the foundation and shattering the sample. It was suggested (Montgomery, 1997) that impactor velocities of over 2m/s should be avoided for this reason. Consequently the drop height was initially set to 200mm, but this was later increased up to 400mm (equivalent to 2.8m/s) without any adverse effects being noted.

*Number of blows* – After the imposed limitations of impactor mass and drop height, the number of necessary blows comes down to a trade-off between energy transfer and production time. Energy transfer is necessary to achieve the required consolidation, but the application of a large number of blows is time consuming. Previous research indicated that an optimum was between 8 and 32 blows. It was hoped that after initial trials at large numbers of blows a bit of balancing between drop height and the impactor mass this number could be reduced to less than 16.

From the variables listed above it is possible to state one further variable that is of interest to us, energy transfer. Calculation of the energy transfer using dynamic compaction is a trivial exercise involving the impactor mass, drop height and the number of blows. The total energy transferred into a sample takes the form of the

following: 
$$E_T = mg \sum_{i=1}^n h_i \quad (1)$$

Where  $m$  is the impactor mass,  $g$  is the universal gravitational constant (9.81),  $h_i$  is the drop height for the  $i^{\text{th}}$  blow and  $n$  is the number of blows applied. If the point from which the mass is dropped is fixed relative to the foundations then the actual distance the impactor falls will be dependent on the blow number. Later blows will have a larger drop height than earlier blows, because of the significant consolidation that is achieved. This variation in the drop height will be considered and included in calculations where appropriate and experimentally possible.

The following subsections deal with some more interesting and significant aspects of dynamic compaction that would be of great interest to the machine designer. Aspects such as direct and indirect impact, mould wall thickness and soundness of the machine



foundation have been explored and reported here. These are other variables to the production process that are kept constant once their significance has been determined and a suitable parameter selected.

#### **4.2.1 Indirect and direct impact**

It would simplify machine design if a billet could be placed between a falling impactor and the block it is compacting ('indirect' blows). However, early on in the Ph.D. it was noted that there is a noticeable difference between samples compacted through direct and indirect blows. Experiments conducted on small cylinders indicated that the use of an intermediary billet of steel (mass of 2.5kg) between the sample surface and the falling impactor yielded significantly lower levels of compaction. Data from two sets of experiments is presented below in Figure 4.2. It clearly shows that indirect compaction produces much less compaction for the same energy transfer. All the samples were compacted using a 2.5kg impactor falling through either 0.2m (direct) or 0.26m (indirect) onto 200g samples with 6% moisture. Either 8, 16 or 32 blows were applied and the total energy transfer was calculated and converted to energy per unit mass. The graph indicates that the two methods of compaction differ by almost 10% on density, constituting a practically significant difference between the two methods. These results suggest that up to 50% of the strength could be lost if indirect compaction was chosen.

Figure 4.2 – Analysis of direct and indirect compaction

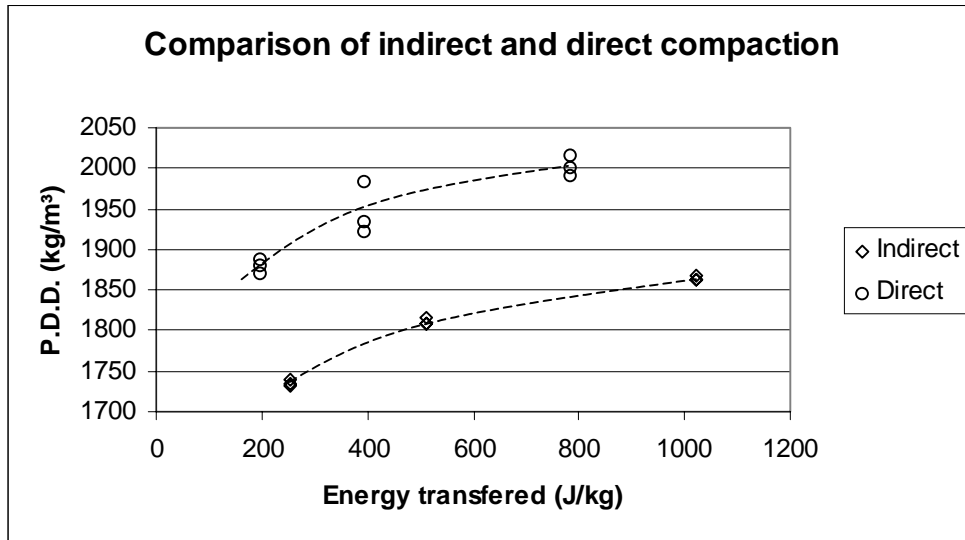

The numerical results for the above experiments can be found in Appendix F. From these results it was concluded that the additional complexities of direct impact compaction were justifiable given the significant improvement in achieved consolidation. Consequently all future experiments were conducted using the direct impact method.

#### 4.2.2 Foundational effects

The process of dynamic compaction relies on the availability of a firm surface onto which compaction can occur. The firmness of the foundation affects the effectiveness of the dynamic blow applied simply by virtue of energy dissipation. A firmer foundation will not yield as much under a dynamic blow and will therefore permit greater compaction energy to be transferred into the sample. A single experiment was conducted to determine the penalty of soft foundations on the block density. Softer foundations were produced by having the full-size block mould placed on top of a 20mm steel plate separated from the 100 tonne strong floor by washers in each corner.

The firmer foundation was achieved by applying a layer of dental paste between the mould and the strong floor to ensure maximum surface area for contact and therefore greatest strength.

It was no surprise that the block compacted on the soft foundation performed worse than the block compacted on the firm foundation. The significance of the stiffness of the foundation was high, but not as high as expected. Two samples compacted with a 46.8kg impactor falling through approximately 200mm for 24 blows yielded densities of 1739 and 1811kg/m<sup>3</sup> for the soft and firm foundation respectively. This represents a variation of about 4% suggesting that the different foundations have a significant effect on the level of consolidation. It was assumed that larger drop heights would further reduce the potential density and consequently the firm foundation was selected as the best option for experimental research.

#### **4.2.3 Delay between impacts**

Another variable that dynamic compaction offers is the duration between consecutive blows applied to the sample. As yet it is not fully known what exactly is happening during material consolidation and even less is known about impact compaction mechanisms. This gap in our understanding led us to conduct a test to determine whether or not a time delay between consecutive blows has a significant effect on the level of consolidation achieved. The experiment would also help to explain some of the dominant mechanisms acting during impact compaction.

The variability within such an experiment was deemed to be higher than normal and consequently to have a greater confidence in the achieved data five blocks were made for each arrangement as opposed to one or three. The first arrangement involved dropping a 36.8kg impactor through 300mm directly onto the surface of the material at the rate of one blow per minute to give a total of eight blows. The second arrangement applied the same type of blow only with the blow rate set to one blow every two seconds. It was hoped that the thirty-fold reduction in compaction time would indicate if any difference existed between the two samples above and beyond the inherent variation of the samples themselves. In order to ensure that any cementitious action did not interfere with the experiment soil-B was used without any cement.

Although the densities of the blocks are quite low it is interesting to see that this time delay has an effect on the level of compaction achieved. Blocks produced fast yielded densities between 1735 and 1756kg/m<sup>3</sup>, whilst blocks with the 1 minute delay produced blocks with densities between 1764 and 1769kg/m<sup>3</sup>. Not only are the densities higher but they are also in a smaller range, indicating a higher degree of repeatability.

In order to prove the significance of these results a series of statistical tests were performed on the data. A summary of these tests and their results are shown in the table below.

Table 4.3 – Statistical variation in full-size block production

Blow Type	Number of samples	Average of dry density	S.D. of dry Density	Coeff of Variation of density	Standard Error
2sec/blow	5	1745	9	0.52%	4.05
1min/blow	5	1766	2	0.12%	0.92

Applying the Standard error difference test to this data yields a Difference of Means  $\div$  Standard error difference = 5.00 which equates to a statistical significance of near unity. Whether or not the process of delaying the time between blows has a practically significant effect on the density achieved is a different matter. The improvement yielded from delaying compaction only equates to an increase of 1.2% in the density achieved. A variation of  $\pm 0.5\%$  can be considered to be unimportant which suggests that this finding would only just be considered important and therefore incorporated into production. However, the requirement of a delay between impacts would increase production time to unacceptable levels and consequently fast compaction has been used throughout the experiments. This data suggests a further mechanism is at work during dynamic compaction and indicates what might be happening during the impact blow. This area will be discussed in more depth in chapter 5.

#### **4.2.4 Mould wall thickness**

The thickness of the walls of the mould needed for dynamic compaction is of greater concern to the machine designer than to the block producer. Clearly the use of thinner moulds is financially attractive, as they require less material for production and easier methods for mould fabrication. In order to determine if there exists any difference between different mould wall thickness a set of different moulds was created for some tests.

A set of twelve samples was produced by indirect dynamic compaction. The intermediary billet was the same mass as the impactor to try and maximise the momentum transfer. This was done mainly for practical reasons, as it would have been very difficult to ensure an accurate enough free fall for an impactor to go into a mould with 0.5mm wall thickness. The sacrifice made in achievable density is a tolerable quantity for this type of test. The samples were produced with a 2.5kg impactor falling through 0.26m delivering approximately 6.4J per blow. A total of 32 blows were applied to each sample and the projected dry density achieved during compaction was in the region of 2000-2055kg/m<sup>3</sup>. The graph in the figure below shows the density achieved by the samples relative to the thickness of the mould wall. It is encouraging to see that the very thick walls of 32mm do not provide the highest levels of compaction. It is also good that the other three moulds used are clustered together at the higher density indicating a low sensitivity over the range of smaller mould walls.

Figure 4.3 – Mould wall thickness experiment results

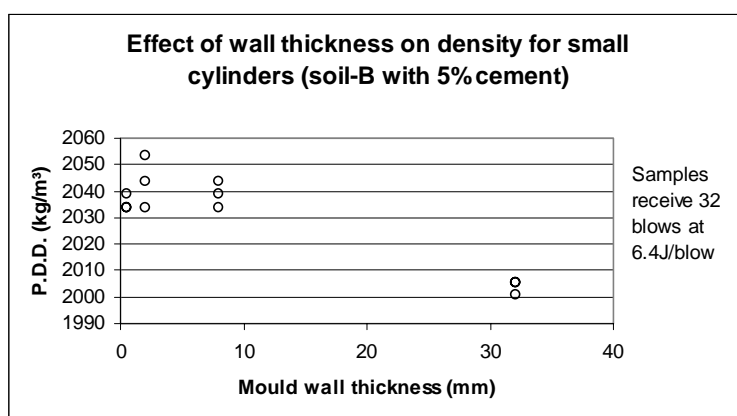

During the experiment the strain on the walls of the 0.5mm and 2mm wall thickness mould was measured. It was hoped that the level of compaction achieved using the

0.5mm wall mould would cause yield in the steel and therefore test the mould to failure. Interestingly the maximum strain experienced by either mould was only 40 micro-strain, a small fraction of the typical 1200 micro-strain that it takes for steel to reach its yield point. This is very encouraging, as it means that the forces sustained on the mould during dynamic compaction are only a small fraction of the forces applied during quasi-static compression. The ramifications of this finding will be discussed in greater depth later in the thesis.

#### **4.3 *Small cylinder production via dynamic compaction***

Further production of small cylinders is necessary to clarify the effect of new variables on the output measures. These tests have already been done via quasi-static compression, so for completeness they should be repeated at the same scale and with the same parameters using dynamic compaction. We are also aiming to achieve particular material characteristics (i.e. adequate material consolidation and compressive strength) and further tests applying different energy and momentum should indicate the relative performance of dynamic compaction more persuasively. The general aim is to achieve the same equivalent density as 10MPa would achieve (around 1950kg/m<sup>3</sup>) and also to maximise the 7-day wet compressive strength (ideally over 2MPa). The results that these tests give us will also dictate some of the tests carried out on the full size blocks in the next section.

### 4.3.1 Energy and momentum transfer

In order to get the desired density several different combinations of energy and momentum transfer were explored. A variety of impactor masses, drop heights and numbers of blows were used to manufacture samples in batches of three. All of these samples had a constant material (soil-B) and moisture content (6%).

The graph below shows the results of a series of different tests using a 2.5 or 5kg impactor falling through 0.2m a number of times. The number of blows applied included 8, 12, 16, 20 and 24 and the P.D.D. was calculated from the ejected sample height. It can be seen from this data that the energy transferred into the sample has a direct effect on the P.D.D. However, it is also apparent that a larger amount of energy per kg is being applied at this scale compared to quasi-statically compressed full-size blocks. (Gooding estimated that 280J/kg was equal to the energy consumed during quasi-static compression of a soil block to 10MPa.) This data shows that 400J/kg is necessary to *dynamically* compact the material to 1950kg/m<sup>3</sup> at this scale. However this is less than the 500J/kg required for *quasi-static* compression at the same scale.

Figure 4.4 – Energy density relationship for small cylinders of soil-B

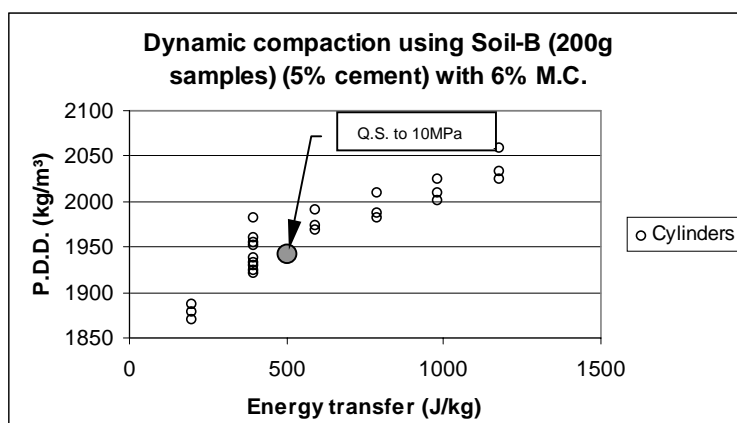



The data around the 400J/kg area indicates that for the same energy transfer a significant range of densities can result. This is because the relationship between energy transfer and density is not directly proportional. The same amount of energy can be applied to a sample in different ways, many of which will be far from the optimum configuration. The optimum momentum transfer was investigated by Gooding and determined that a low-velocity high-momentum blow is more effective. We can clarify this assertion at this scale by investigating a range of different momentum arrangements.

Another set of samples was produced using the combination of 2.5, 5 and 10kg impactors, 100, 200 and 400mm drop heights and 4, 8, 16 and 32 blows. Five combinations of these variables yield different momentum transfers for each blow applied, yet the same total energy. These results can be seen in the figure below. The data is presented more clearly by observing the averages of the P.D.D. from each sample set. The graph does not indicate a definite optimum as expected, but it does indicate that the graph is relatively flat (variation  $\pm 1\%$ ) over the region of interest.

Figure 4.5 – Optimisation of momentum transfer for small cylinders

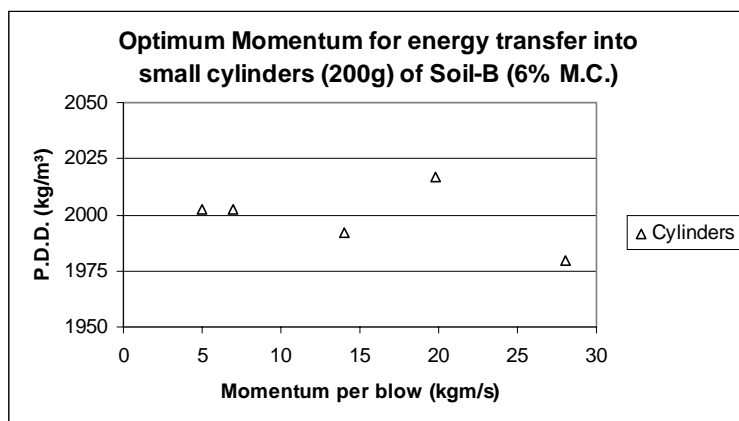

We want to be able to use this information to suggest a suitable momentum transfer for full-size blocks. But these results do not present any clear guidance and extrapolation of the data without subsequent confirmation is unacceptable. Therefore the impactor mass, drop height and number of blows used for full-size blocks will have to be determined by other factors such as practicality, cost and speed.

#### 4.3.2 Strength vs. density

Previous experiments indicated that there is an empirical relationship between the achieved density of the sample and the strength that the sample achieves. For the limited condition of using soil-B mixed with 5% cement it is possible to define a relationship between strength and density. The graph below is a summary of cylindrical samples produced by dynamic compaction for different moisture contents and energy transfers. It indicates a linear relationship over the range of interest. We can propose the following relationship between density and strength with a 95%

confidence:  $\sigma_{7\text{-day-wet}} = \frac{\rho_{P.D.D.} - 1880}{77 \times 10^{-6}}$ . Therefore we can say with 95% confidence

that a sample with a projected dry density of 2000kg/m<sup>3</sup> will have 7-day wet compressive strength of more than 1.6MPa. (The accuracy of this relationship is probably only limited to the range of data used to create it.) For the purposes of this investigation it shows the region of greatest interest, samples that exhibit wet compressive strengths between 1.5 and 3MPa, considered “Good” to “Excellent” by the CSSB literature.

Figure 4.6 – Density strength relationship for dynamically compacted cylinders

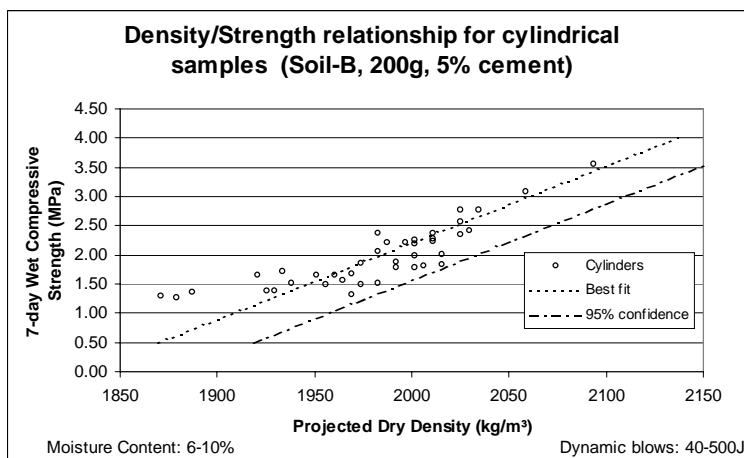

If the data from these small cylinders is added to the data received from the quasi-statically compressed samples then we have a bigger data set for analysis. Rather than present all the raw data together, we will only display the calculated 95% confidence lines from the cylindrical samples produced by dynamic compaction and quasi-static compression. These two lines are plotted on the graph in the figure below and it is clear that they are very similar. This gives more weight to the proposal that the strength can be calculated from the known density, a very attractive finding.

Figure 4.7 – 95% Confidence lines for density/strength relationship for cylinders

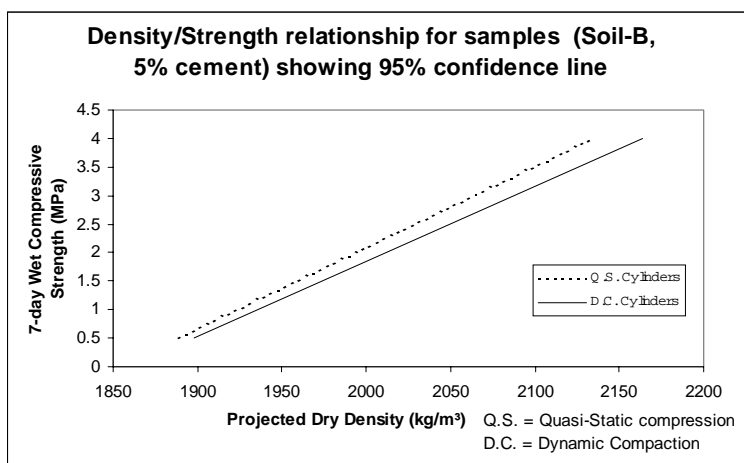

This data gives us a benchmark for the production of full-size blocks. We would aim to produce blocks with similar densities and see if their 7-day strengths lie in the same region. If they do, then assessment of the material characteristics of small cylinders can be assumed to be transferable to full-size blocks with a degree of confidence. The next section commences the extension of experimental investigation to include the production of full-size dynamically compacted stabilised soil blocks.

#### **4.4 Full-size block production via dynamic compaction**

A total of 22 full-size blocks were produced using soil-B by dynamic compaction, four of them were compacted without cement. Different moisture contents were investigated, the compaction curve for the dynamic process was also recorded, and the finished blocks were cut into 100mm cubes for compression testing after 7-day curing. There are two main motivations for the development of a dynamic compaction rig capable of producing full-size blocks. The first is to continue research into the production of full-size blocks, as confirmed possible by (Montgomery, 1997), and the second is to advance the development of a suitable machine for block making. Chapter 6 will discuss the Test Rig design in more depth, but the results of the block production generated from the Test Rig will be presented in this section.

##### **4.4.1 Compaction curve for dynamic compaction**

In order to maximise the data collected from the production of each block, the block height was measured remotely after every, or every other, blow. These results enable

us to plot a compaction curve for each block, monitoring the P.D.D. as well as the energy necessary to achieve it. The advantage of this system is that it offers a large number of data points for analysis that permits density estimations from known energy transfers. This information will be useful in comparing the results both between full-size and cylindrical samples and between dynamically compacted and quasi-statically compressed samples.

The remote measurement method uses a ruler guide on the impactor, so that after each blow the relative position of the impactor can be measured to  $\pm 0.5\text{mm}$ . Once the block is compacted, ejected and measured then this relative measurement can be used to calculate the in-situ block height during the compaction sequence. Such a compaction curve can be seen in the figure below. Two blocks labelled “2/11b” and “2/11c” have received 36 blows from a 36.8kg impactor falling through approximately 300mm. The graph clearly shows the similarity between two blocks compacted by the same method. They do not follow exactly the same compaction curve, but that is expected, as there is a small degree of variation in the process. The graph on the left shows the density against the number of blows applied, whilst the graph on the right shows the density against the energy transferred.

Figure 4.8 – Compaction curves for blocks at 6% moisture

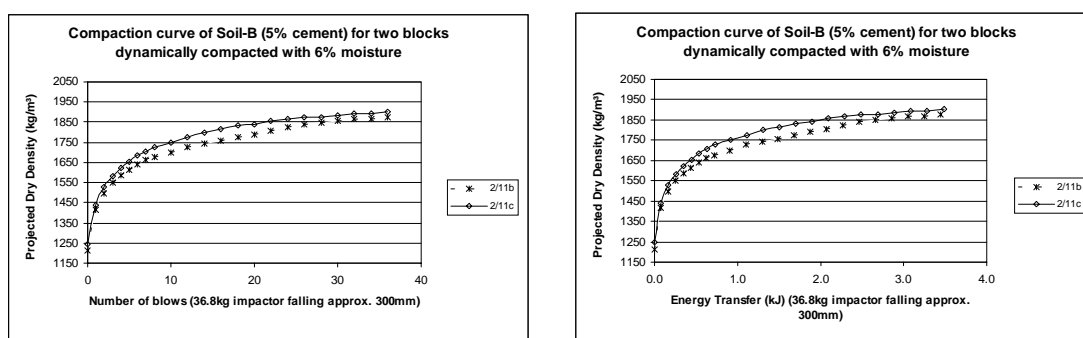

A disappointing outcome of these results is that the final P.D.D. of the blocks did not quite get to  $1950\text{kg/m}^3$  as was hoped. Furthermore, the quantity of energy transferred into the block (3.5kJ) was much higher than the equivalent energy to compress a similar block to 10MPa, ( $280\text{J/kg} \times 8\text{kg} = 2.2\text{kJ}$ ). This seems to contradict Gooding's findings of dynamic being more effective than quasi-static compression. Before we jump to any conclusions it would be good to investigate other moisture contents and other impactor arrangements to see if a comparable block can be made by this method using similar amounts of energy.

#### **4.4.2 Different moisture contents**

Experiments at small scale indicated that the moisture content has a significant effect on the P.D.D. for the same energy transfer, therefore the investigation of other moisture contents may yield more effective compaction. A total of thirteen blocks were produced each receiving 36 blows from a 36.8kg impactor falling approximately 300mm. Five different moisture contents, 6, 7, 8, 9 and 10% were explored and two or three blocks were made at each moisture content. These tests also provide significantly more data to help determine the inherent variation of the process. The graph below presents the average compaction curve for each moisture used. It is clear that the moisture content has a significant effect on the effectiveness of the compaction, as an increase in moisture content from 6 to 10% increases the density by about 8%.

Figure 4.9 – Compaction curves of blocks at different moisture contents

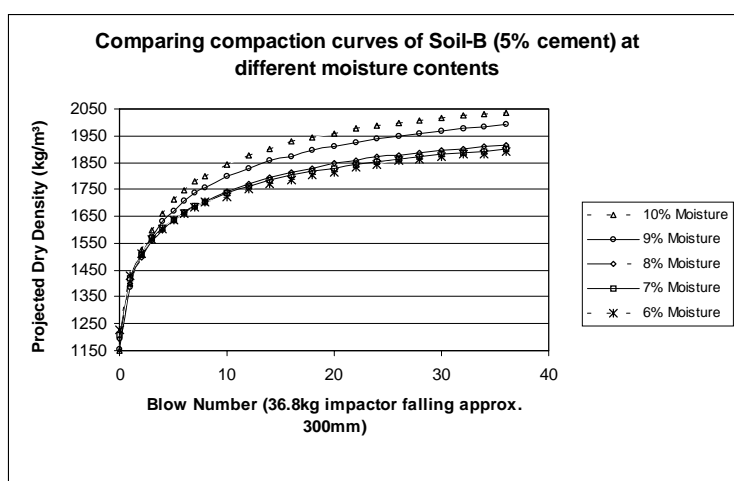

The differences between the curves on the graph are quite distinct confirming our expectations that increasing the water content would yield higher levels of consolidation. However, our motivation for selecting 6% was to achieve good handling characteristics of the finished block. Pushing the moisture content up to 10% reduces this handling strength, but fortunately this was offset due to the increased achieved density and did not present a problem.

It can be seen that the 10% moisture content line crosses the 1950kg/m<sup>3</sup> line after about 18 blows. This lower number of blows is much more attractive as it takes less time to apply. What now needs to be determined is whether or not a block can be produced using perhaps a heavier impactor lifted through a slightly larger distance to achieve 1950kg/m<sup>3</sup> with a more tolerable 16 blows or less. The graph in the figure below shows the compaction curve for a set of blocks compacted with a 60kg impactor falling from 400mm. Only a single block for each is used to display the compaction curve against the blow number or the total energy transferred. The top graph shows the different rates of compaction as each blow is applied, illustrating the

significant difference between different impactors and drop heights. Whilst the lower graph shows the total energy transfer by either impactor arrangement and shows that the higher mass and greater lift height only slightly improves the compaction effectiveness (i.e. consolidation per unit energy transferred).

Figure 4.10 – Compaction curves for different impactors

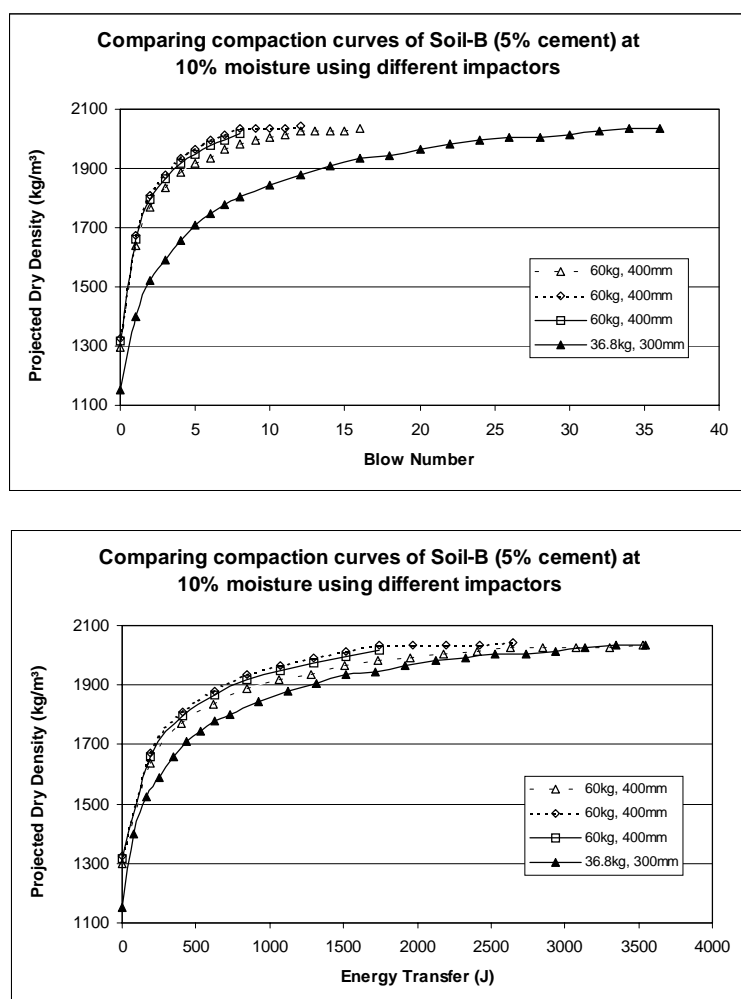

It is pleasing to see that the level of density achieved by these methods is well above the desired 1950kg/m<sup>3</sup>. It is even more encouraging that a small improvement in effectiveness is achieved if a larger impactor is dropped from a greater height. Our original concern about raising the impactor height was not found to be justified, as the



ejected blocks showed no signs of shattering or de-lamination from the increased velocity impacts.

#### **4.4.3 Block characteristics**

Being able to achieve a block density of over 1950kg/m<sup>3</sup> is only part of the necessary requirements for adequate block production. We already believe that such a density will give a material compressive strength that is enviable among CSSB, but we need to establish the actual strength of these blocks. Other characteristics of the material and the production effects will also be explored in this subsection.

The graph in the figure below summarises two important and related output measures, namely density and strength. Most of the full-size blocks that were made with cement were cured for 6 days and then cut into 100mm cubes before spending 24 hours in water prior to getting crushed. The results of these tests can be seen below. In many cases a block was cut to form two 100mm cubes thus doubling the compressive strength data for that particular block. The graph clearly shows a significant difference between the two ranges of moisture content used. Just as blocks made with 9-10% water had much higher densities, their strengths are also much higher than blocks made with less water. This again demonstrates the need for careful control of the water present in the soil mix to maximise the achieved density and subsequent strength.

Figure 4.11 – Strength results for dynamically compacted blocks

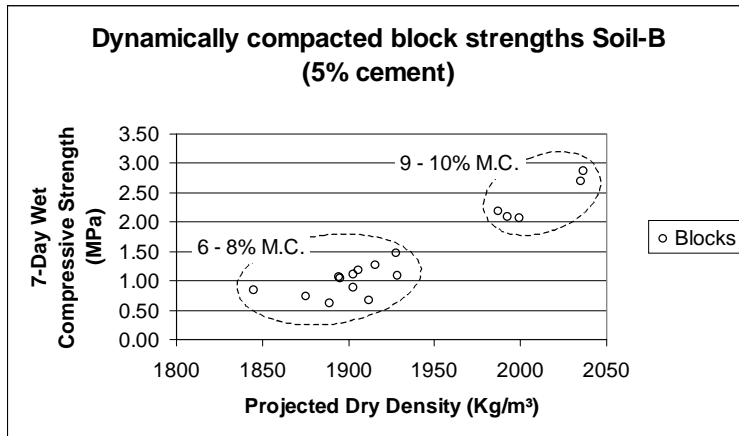

It is not clear from this graph whether or not the relationship between density and strength is similar for these blocks as the small cylinders. But we now have the data to plot the lines of 95% confidence for small cylinders compacted quasi-statically and dynamically as well as full-size dynamically compacted blocks, (see below).

Figure 4.12 – 95% Confidence lines for density/strength relationship for soil-B

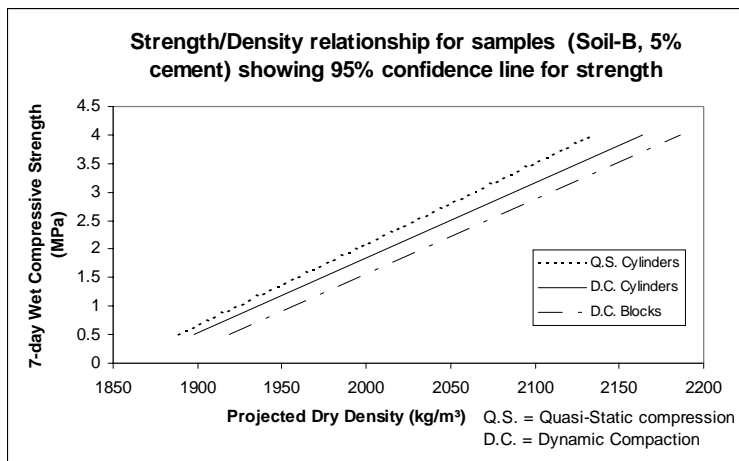

The figure above shows the three density/strength lines and it is encouraging to see that their gradients are very similar. It is disappointing that to achieve the same compressive strength dynamically compacted blocks need to be about 30kg/m<sup>3</sup> denser

than the quasi-statically compressed cylinders. This is an increase of slightly more than 1%, which cannot be considered normal variation in the material or processes but could be considered as an effect of changing scale. Indeed larger samples typically have lower strengths than smaller ones.

Another measure that has been considered with these results is the dimensional variation of the compacted blocks. The small cylinders exhibited a small variation in their length due to the impactor falling at a slight angle. The same was true for the full-size blocks. We need to be able to confirm that any dimensional variation (other than consistent and in-built variation from the dynamic compaction process, which could be eradicated later in the design) is less than  $\pm 2\text{mm}$  to comply with block standards found in (Centre for the Development of Industry, 1998).

We already have a set of blocks that have had their height measured accurately at six points that we can use to determine the height variation of the compacted blocks. The figure below shows a graph that has height data taken from 13 blocks made in the same production cycle over two consecutive days. The method of height measurement was the same for each block and the relative location of the front, back, left, right etc. was the same for each block.

The data is plotted not as absolute values of block height but as a variance from the average height for each block. The pattern displayed within the data clearly indicates that the impactor was not falling parallel with the base of the machine. The left-hand side of the impactor was falling lower than the right-hand side.

Figure 4.13 – Height variation of dynamically compacted blocks

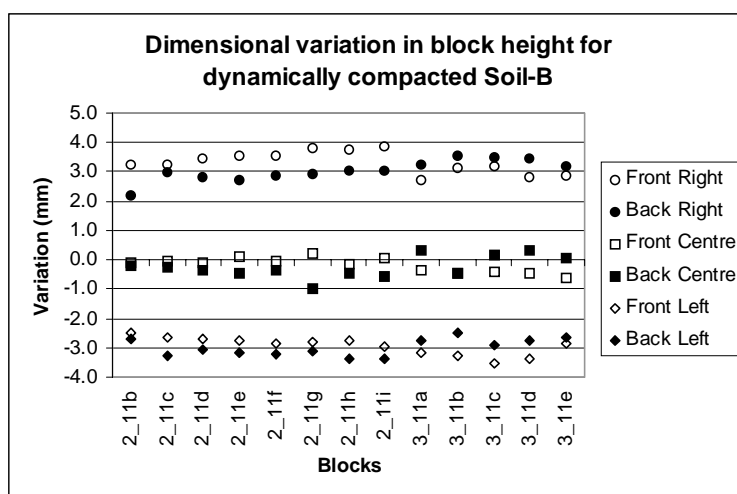

The above data also confirms that the actual variation across the surface of the block is less than  $\pm 2\text{mm}$  once the variation from the incorrectly aligned impactor has been removed. This is an acceptable variation and complies with the block standards. Unfortunately such a large variation would not be tolerable in interlocking blocks unless a different method of block orientation was used.

Measuring the green strength of the finished blocks was not possible using the standard soil penetrometer. The device is not designed to work on such a compact material and the majority of blocks made by dynamic compaction were too dense to get a reading. Consequently another test was developed to monitor the green strength of the block specifically for stabilised soil material. It involves dropping a 1kg mass onto an indentation pin and measuring the resulting diameter of the indentation. It was hoped that this measure would be a non-destructive test that could indicate future block strength as well as level of achieved densification. The results shown here are taken from air dried samples cut from the above 13 blocks after 156 days. The data

indicates a definite connection between the diameter of the indentation and the wet compressive strength of the block. The relationship is most easily seen when the values are plotted on log-log axis as shown below. This is a very exciting finding and one that would be well worth exploring further during field trials.

Figure 4.14 – Indentation results from tests on cured blocks

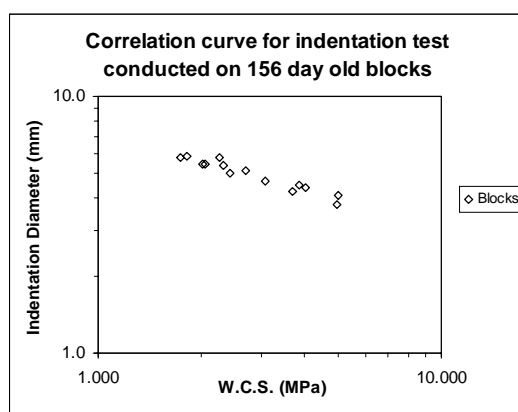

#### 4.4.4 Block variants

The CSSB variants summarised in subsection 3.4.4. indicated that hollow blocks, cement-rich skin blocks and interlocking blocks provided the most significant savings in cement. We could not investigate interlocking blocks, as this would have necessitated mould redesign and further rig development. However, we were able to produce some hollow blocks and some cement-rich skin blocks for testing and analysis.

We produced hollow blocks by reducing the total dry material in the block from 8kg to 6.5kg and adding a pair of wooden frogs (0.0011m<sup>3</sup> volume) to the mould. The soil

was mixed with 5% cement and 10% water and carefully placed into the mould in three separate charges to ensure better material placement around the frogs. This was further enhanced by manual prodding of the soil mixture around the frogs prior to compaction. Blocks were made using a 60kg impactor dropped twice from 0.2m and a further 6 times from 0.4m, delivering approximately 1.65kJ.

The finished blocks were ejected with great care, but they still suffered from minor crack defects. The blocks were measured and put to cure for 6 days before having their 7-day W.C.S. measured. The results of the four blocks in question are listed in the table below.

Table 4.4 – Characteristics of hollow blocks

Block Label		4/4a	4/4b	4/4c	4/4d
Average block height	mm	103.0	103.4	103.3	103.0
Standard deviation of heights	mm	0.3	0.4	0.4	0.4
Coefficient of variation of heights	%	0.29	0.38	0.36	0.36
Average P.D.D. of block (including voids)	kg/m <sup>3</sup>	1554	1548	1551	1555
Average P.D.D. of material	kg/m <sup>3</sup>	2108	2098	2102	2111
7-day block compressive strength	kN	12.69	12.17	14.18	13.41
7-day W.C.S. of block	MPa	0.31	0.30	0.35	0.33
Minimum 7-day W.C.S. of material	MPa	0.59	0.57	0.66	0.63

In order to draw meaningful conclusions from these results we will need to assess hollow blocks slightly differently than homogenous blocks. The average P.D.D. of the material takes into account the density variation that exists between the top surface and the bottom of the flanges around the central voids. The minimum 7-day W.C.S. of material indicates the compressive strength calculated using the reduced surface area for loading, making it comparable to the W.C.S. of homogenous blocks.

The hollow blocks had a very high average P.D.D. yet exhibited a very low W.C.S. We can suggest that this was because of the very high slenderness ratio of the flange (2.5-3) and the low density of the material at the bottom of the flanges where high strength is needed most. An indentation test on the flanges confirmed that the density at the bottom of the flange was smaller than at the top surface. The diagram below illustrates the results of the indentation test on the different regions of the hollow block. They clearly indicate a rapid change in density and strength in the thinnest part of the flanges.

Figure 4.15 – Sketch of indentation results on flanges of hollow blocks

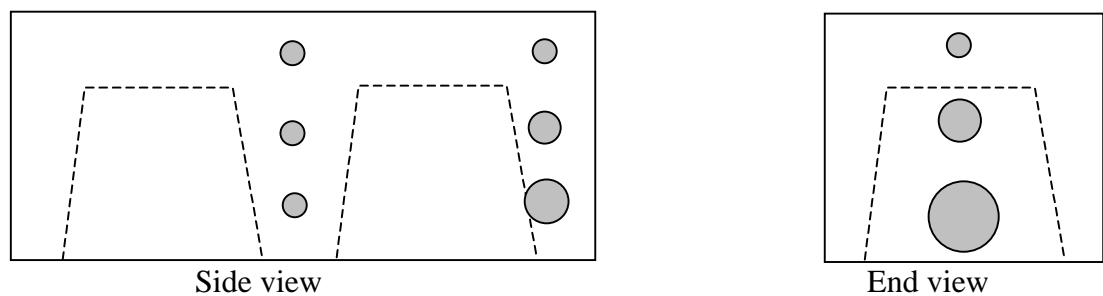

The indentation tests illustrate the problem with poor material placement and non-uniform consolidation. Whilst we can demonstrate that it is possible to produce hollow blocks using dynamic compaction, these results show a massive (70%) loss in block strength for only a 20% saving in cement. Reducing the cement content from 5% to 4% would have only reduced the strength by around 20-30% and the same savings would have been realised with lower mould complexity and faster production time. The hollow block technique would require further improvement to become an acceptable alternative.

Two cement-rich skin blocks were also produced by dynamic compaction. The production technique for these blocks required the cement rich layer to be placed and spread out in the mould manually. This layer received a single low energy blow after which the rest of the material was added and the total mix compacted together. We wanted the cement-rich skin to be 5mm thick, so approximately 10mm of un-compacted material was placed in the mould. The cement rich layer had a cement content of 10% and the remaining soil had the usual 5% cement. The material was compacted using a 60kg impactor dropped twice from 0.2m and a further 6 times from 0.4m, delivering approximately 1.65kJ.

Upon ejection the blocks were measured and then cured for 6 days. After curing they were air dried for one day and multiple indentation tests were carried out on the block surfaces. Only a small difference in the indentation tests could be noticed between the cement-rich side and the other sides of the block. This was enough; however, it was much easier to visually identify the cement rich layer on the block. The achieved P.D.D. of the two blocks were 1974 and 1965kg/m<sup>3</sup>, quite acceptable for the energy transfer and comparable with 10MPa quasi-static compression.

The added complexity of manually placing the cement-rich layer in the mould would make this technique impractical during normal block production. We also do not know the performance of this variant to be able to compare it accurately with other CSSB. Further research would be necessary to determine if this variant would provide the benefits that we want without adding significantly to the machine complexity or the block production time.



It was noticed during the production of these block variants that each block exhibited a dimensional variation of less than  $\pm 0.5\text{mm}$  over the top surface, significantly lower than the  $\pm 3.0\text{mm}$  experienced on previous blocks. All of the block variants enjoyed special care in the material placement prior to compaction, which could be the reason for the improved dimensional tolerance. Such a small variation would be acceptable for interlocking block manufacture if it could be sustained during normal production. Interlocking blocks were suggested to be another good method of reducing the cement material for walling. Therefore, this finding justifies further research into improved material placement for incorporation into dynamic compaction.

#### ***4.5 Comparison of dynamic and quasi-static consolidation***

This section summarises the data collected from experiments conducted using the two different compaction methods. It aims to clarify the comparison of the effectiveness of the two methods using several measures of interest, namely P.D.D., energy transfer and block ejection force.

##### **4.5.1 Achieved density for same energy transfer**

Using the data that has been collected on small cylindrical samples compacted by quasi-static and dynamic methods we can compare the two methods of compaction. The graph in the figure below shows averages of sample sets of cylinders of the same soil compacted by quasi-static (Q.S.) and dynamic compaction (D.C.). It confirms the original premise that dynamic compaction is somewhat more effective at material consolidation than quasi-static compression.

Figure 4.16 – Comparison of energy transfer for small cylinder production

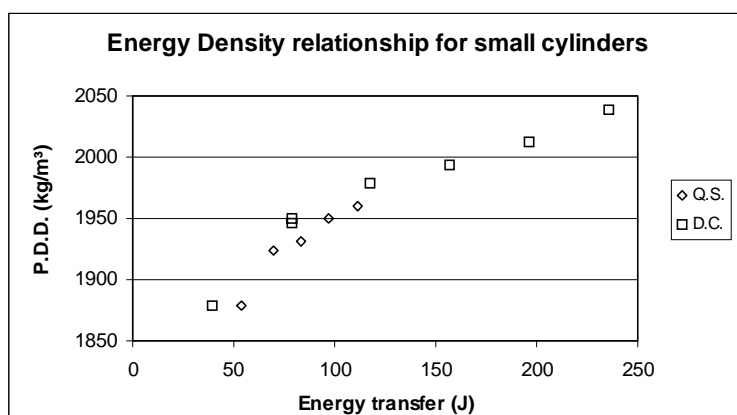

The graph plots data from 4-12MPa pressure and cylinders compacted with 8-24 blows and indicates the greater potential for compaction with dynamic over quasi-static. The application of extra blows delivers extra densification without the need for any machine modification, whereas significant machine modification would be necessary to increase a machine press from 4 to 12MPa or higher.

Early production of full-size blocks was conducted away from the optimum moisture content and this significantly reduced the achieved density for the energy transferred. Later block production indicated that a block could be manufactured with similar P.D.D. as a block compressed with 10MPa pressure using less than 1.7kJ of energy. This represents energy saving of about 20% over quasi-static compression (2.2kJ using soil-A). This also compares favourably to the estimated energy consumption of a 2MPa manual block press requiring 1.5kJ per block and very favourably with the 10MPa manual hydraulically-assisted press requiring 2.9kJ per block. We have therefore confirmed the original premise that dynamic compaction is more energy

efficient in material consolidation than quasi-static, providing suitable production parameters are chosen and maintained.

#### 4.5.2 Ejection force

With the results collected from the small samples it is also possible to analyse whether or not dynamic compaction offers any reduction in the ejection force of the compacted samples. This is interesting for the machine designers, as they will have to develop a system to provide the necessary force for block ejection. We have already established that the ejection force at small scale can be extrapolated to full-size blocks, so any findings at this scale can be assumed to apply at full-scale as well. The graph in the figure below shows a summary of the small cylindrical samples and their ejection force plotted against the compacted density. Due to the large variation in the numerical results between supposedly similar tests it is difficult to justify any practical difference between the two sets of data below. It was hoped that dynamic compaction would yield a small reduction in the ejection force for similar density samples and it is possible to see this marginal difference by applying lines of best fit to the data.

Figure 4.17 – Comparing ejection force for dynamic and quasi-static compaction

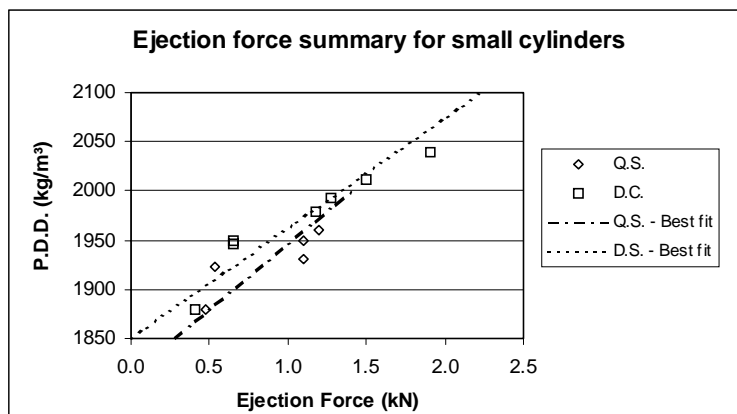

Such a small difference between the two methods of compaction does not present any real advantage of using dynamic compaction over quasi-static. We believe that much greater advantages can be found in reduced machine complexity as the next subsection explains.

### **4.5.3 Machine cost and complexity**

We have established that dynamic compaction provides slightly more effective compaction for the same energy transfer, but does not improve other criteria such as ejection force. Are there any other advantages dynamic compaction can offer over quasi-static? The simple answer comes from the process by which compaction takes place. Quasi-static compression transmits between 30-70% (Gooding, 1993) of the load applied to the top of the block onto the sides of the mould. The overall machine must also be able to withstand over 100% of the maximum applied load without yield, deformation or failure. These requirements result in significant mechanical structures being applied for safe and reliable machine operation. Whilst low-pressure can be applied by a long lever or cam mechanism, high-pressure requires an additional hydraulic circuit. Hydraulic circuits are expensive and require maintenance for longevity and are typically inappropriate for low-cost applications in developing countries.

Experimental evidence has shown that high-pressure equivalent densities can be achieved by dynamic compaction with very thin walled moulds without any sign of yield or significant strain. This leads us to believe that the dynamic compaction

process can be applied to full-size block making to produce high-pressure equivalent densities without the need for thick walled moulds or the complex hydraulic circuit. Removing these features from the machine design represents a large reduction in machine cost. The capital investment required for a dynamic machine would therefore be much less than a comparable quasi-static press, thus making it available to a wider market and more attractive for investment.

#### **4.5.4 Other beneficial block characteristics**

During the production of CSSB and their variants by impact compaction, several beneficial block characteristics were noticed. These may be of limited value but present some interesting features of dynamic compaction that have not been recorded during quasi-static compression. Gooding suggested that dynamic compaction delivered more uniform compaction, and this phenomenon has also been seen in the production of the full-size blocks through the indentation tests.

Another two features that have been identified as beneficial are to do with the surface characteristics of the block. During the cutting of the full-size blocks into cubes for compression strength tests it was noticed that the exterior skin of the block was harder than the core. This was further confirmed with the indentation test. The removal of the block from the 'splittable' mould does not cause the usual scraping and wiping effect normally experienced with ejection from quasi-static presses. The process of releasing the mould from around the block (something that is not appropriate with quasi-static compression) is delivering a visibly superior block surface. The combination of improved surface finish and increased surface hardness gives the finished block

slightly better resistance to environmental attack and abrasion, truly a beneficial by-product of dynamic compaction.

#### **4.6 Chapter summary**

The results presented in this chapter have been very encouraging. We have also been assured that the experimental data collected is sufficiently accurate and repeatable to draw sensible conclusions from them. The inherent variation experienced during tests on quasi-static samples is very similar to the variation in impact compaction, from which we can conclude that the dynamic compaction process does not add any further variation. This small variation ( $\pm 0.5\%$ ) is also present during full-size block manufacture.

We have established that dynamic compaction provides some 20% more energy efficient consolidation than quasi-static for each scale investigated. During block production small deviations ( $\pm 2\%$ ) from the optimum moisture content will require additional energy to achieve desired consolidation. Compaction to 10MPa pressure-equivalent densities has been successfully achieved and many samples achieved even higher densities with additional blows. After choosing appropriate production parameters block P.D.D. was frequently over  $2000\text{kg/m}^3$ , and exhibited 7-day W.C.S. of over 2MPa. From these findings we also re-calculated the relationship between P.D.D. and the W.C.S. for full-size blocks and found it to be only slightly different to the relationships discovered with the small cylinders.

The transfer of energy into the block via the falling impactor has a number of variables associated with it. Optimisation of the impactor mass, drop height and number of blows applied was investigated experimentally on small cylindrical samples. This indicated that the momentum transfer was not a critical parameter for compaction across the range investigated. This was assumed to be the same for full-size blocks as well and consequently the total energy transfer was monitored more carefully. Different impactor arrangements used during block manufacture indicated that a good solution was to use a 60kg impactor falling from 0.4m between 8 to 16 times.

Other aspects related to dynamic compaction were also investigated with some interesting findings. The practice of indirect compaction, (via intermediary billet) greatly reduces the potential for consolidation and should be avoided if possible. The losses of around 10% on density would result in unacceptably high strength losses of as much as 50%. The stiffness of the machine foundations was also found to have a practically significant effect on the final block properties. Increasing the delay between impacts was found to have a statistically significant effect on the blocks, but fortunately this was of little practical significance and any extra delay would have increased the production time unacceptably.

Our understanding of block manufacture by dynamic compaction has been greatly enhanced and will provide valuable guidance for machine design. It was discovered that thinner walled moulds are not only acceptable for dynamic compaction, but also yield slightly better consolidation compared with very thick walled moulds. A two-part thin walled mould was successfully implemented during full-size block

production and overcame the problem of block ejection. Poor block tolerances were caused by a combination of poor impactor constraints and poor mould filling. These issues may need to be further assessed for inclusion into an appropriate machine design. Block variants were also successfully produced using impact, but the increased production time and poorer block characteristics recommend further research and improvements to the process.

The numerical data collected during these experiments have also given us an idea of the processes taking place during dynamic compaction. We now know the compaction curves for the material at different moisture contents and different impactor arrangements. This information can help us to suggest the mechanisms of impact. We believe that impact generates significant forces that cause consolidation, but the magnitude of these forces is still not known. Interesting findings concerning mould wall thickness lead us to believe that other mechanisms are acting during the compaction that are different to quasi-static compression. Closer inspection of the point of impact, its duration and effects now needs to be carried out.



## **5 Impact Mechanism**

The literature review indicated that little was known about impact compaction and even less about impact compaction of confined soil. The results of experiments conducted in the previous chapter help us to make certain assumptions about the mechanisms involved in compacting soil by impact. The experiments described in this chapter have been conducted to investigate some of the fundamental mechanisms acting during an impact blow. Our motivation for conducting these experiments is twofold, firstly to improve understanding of the process of impact compaction and secondly to assess the magnitude of the forces delivered during impact and thereby assist with machine design. This chapter will be split into two sections. The first section develops a series of models for the compaction process and for impactor motion. The second section describes experiments conducted to measure certain features of dynamic compaction and assesses the models against the experimental evidence.

### ***5.1 Models of compaction***

The soils literature adequately describes the effects of soil compaction of soil without actually explaining any of the mechanisms that take place. Soil consolidation is achieved by bringing particles closer together and as a result driving out some gaseous material, and under extreme conditions, some liquid material as well. This section will develop models for three separate areas of interest; the force distribution during

compaction, particle-particle interaction, and air/water dismissal. Eight conceptual models are presented below:

1. Force distribution during compaction,
  - Shock wave propagation to bottom and back
  - Compression transfer to top and sides
2. Particle-particle interaction
  - Sliding of particles past each other
  - Knocking off of asperities
  - Plastic deformation of lumps of clay
3. Air/water dismissal
  - Expulsion of air in the short duration of impact
  - Diffusion of air into water
  - Pressurisation of air in core followed by its slow diffusion out

### **5.1.1 Force distribution during compaction,**

It is already known that during quasi-static compression the sides and the bottom of the block mould feel only a fraction of the pressure exerted onto the top of the block, (typically 30-70%). We assume that the same is true for dynamic compaction, because the medium for the force transfer is the same, namely the soil. Whatever force is applied to the top will be felt in some measure on the sides and the base, but how the force is distributed during impact is still not understood.

*Shock wave propagation to bottom and back* – Experiments conducted using soft foundations indicated the phenomenon of shock wave propagation through the material during an impact blow. This was seen most clearly when de-lamination occurs, (i.e. when upper layers of the block have an internal tensile force applied that exceeds cohesive forces and material separation results). Such a phenomenon suggests that a shock wave impulse formed by the falling impactor is travelling through the soil.

The diagram in the figure below shows four different possibilities for compaction wave propagation through material confined in a mould. The horizontal lines in the material represent the wave front of the compaction at a succession of times. This wave reaches the bottom of the mould in C and D and reflects back up as a rarefaction wave upward through the material, depicted by the solid lines.

Figure 5.1 – Compression wave propagation during compaction

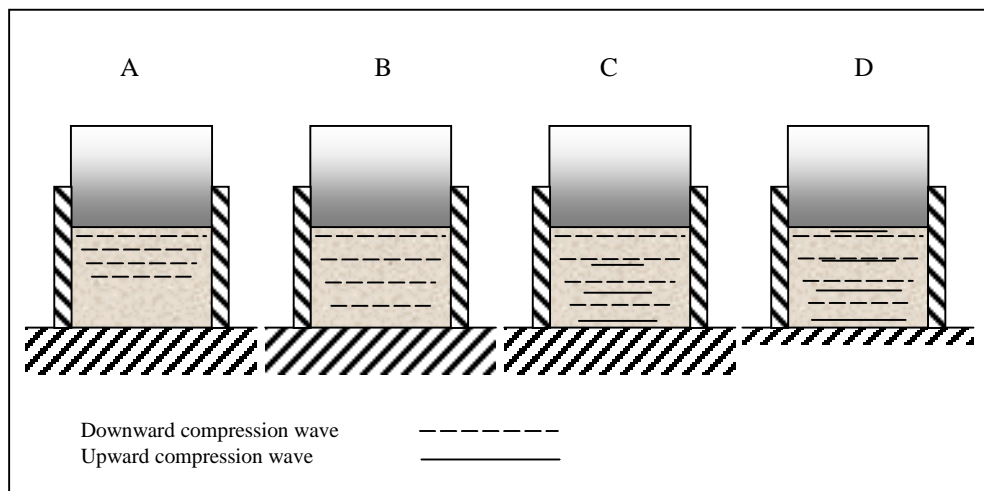

A – Has very low impact energy (similar to vibration) and only compacts the upper layers.

B – Has impact blows of higher energy that deliver shock waves as far as the bottom of the mould.

C – Has even higher energy impact blows and causes a reflection wave to bounce off solid foundations and travel back up some distance into the material.

D – Has elastic foundations and higher energy impact blows that causes a significant reflection wave travelling all the way back up the material causing de-lamination at the top of the block.

We can determine the speed of these compression waves if we know the speed of sound through the material. Sound waves travel through a material at a rate determined by the bulk modulus ( $G$ ) and the material density ( $\rho$ ) and using the following formula:

$$c = \sqrt{\frac{G}{\rho}} \quad (2)$$

We can estimate the density of the material during compaction from the height of the block, but we need a method of determining the value of  $G$  for the material as well. Whichever method is used to determine  $G$  and the resulting speed of sound through the material should be verified experimentally in some way. The concrete industry uses a Pundit tester to estimate concrete strength from the speed of sound passing through it. Such a test would be acceptable to determine the speed of sound through the compacted material.

***Compression transfer to top and sides*** – This model is similar to quasi-static compression model. It suggests that the force applied to the top surface of the material from the impact blow is transferred through the material along slip planes. If this force

is large enough, the particles resisting the force give way and move closer together. Similarly to quasi-static the maximum forces are felt on the top surface and they reduce significantly as one progresses through the material and towards the bottom (since the growing friction of the vertical forces has been transferred to the mould sides). This model would suggest that compaction force would be smaller at the bottom of the block and therefore display a lower achieved density. This material characteristic is well known in quasi-static compaction, but has not been noticed during previous or current dynamic compaction research.

### 5.1.2 Particle-particle interaction

*Sliding of particles past each other* – Typical soils consist of large particles surrounded with smaller ones. The very smallest particles are clay, which have a flat plate-like structure with water molecules bonded to these plates. In the presence of additional water and/or force these plates will slip past one another. As the force is applied to the material (via impact or squeeze) these clay particles slid past one another enabling the larger particles (that they are coating) to move into a closer arrangement. This model seems to most accurately explain the effect of better consolidation from the addition of extra water as seen in both the soils literature and the dynamic compaction experiments.

The dynamic viscosity ( $\mu$ ) of water and air at 25°C are 0.001 Ns m<sup>-2</sup> and  $1.853 \times 10^{-5}$  Ns m<sup>-2</sup>. From this we can calculate a maximum likely shear stress ( $\tau$ ) for these fluids assuming a 1m/s velocity change ( $du$ ) over 0.1mm ( $dy$ ) using:

$$\tau = \mu \frac{du}{dy} \quad (3)$$

This yields a shear stress of 10Pa for water and 0.2Pa for air. These stresses are tiny compared with the shear strength of the solid component. Therefore we can conclude that any slipping is due to the very small shear forces between particles surrounded by air and water rather than shear planes through solid material.

***Knocking off of asperities*** – This model may apply if the presence of clay or moisture is too small for sliding to occur between particles and the forces applied are large enough for material fracture. Sharp points on the particles may break off during the application of forces exerted by the impact blow. The load path through the material will be predominantly through point contacts between particles and these may crush or break under force. As compaction continues the number of point contacts increase until the force applied is sufficiently resisted without any further crushing and hence consolidation ceases.

If we assume the compressive strength of the rock particles is approximately 500MPa, this is significantly higher than the mean pressures that we are expected from dynamic compaction over the total surface of the block. If we were achieving a mean pressure of 10MPa there would need to be a 50 to 1 stress concentration for localised crushing to occur. Considering the wide range of particle sizes and close packing of them together, this seems highly unlikely and therefore we can assume that the forces are not physically affecting the solid particles.

***Plastic deformation of lumps of clay*** – Clay will exist in the form of closely packed lumps that have not been broken down into smaller pieces during the soil mixing process. In the presence of water these lumps are quite soft and will deform under applied force. Initially these lumps may hold harder particles further apart but as the forces applied during compaction are exerted these lumps will deform and permit closer arrangement of the harder particles. These lumps of clay will have a shear stress dependent on the quantity of water present in them, but much lower than the solid rock material present throughout the soil.

### **5.1.3 Air/water dismissal**

***Expulsion of air in the short duration of impact*** – The soil comprises of three phases, solid, liquid and gas. For the applied pressures it can be assumed that the solid and liquid phases are incompressible compared to the gaseous phase. During the first blow the air volume reduces to approximately 65% of its initial volume. If the air was originally at 1 bar (or 0.1MPa) and the volume is reduced by 35% then (assuming no air loss or temperature change) the new air pressure is 0.15MPa. Substituting an adiabatic assumption for an isothermal one raises this pressure to 0.18MPa. During the first impact blow a small amount of dust is usually ejected from the mould along with the expelled air. We believe that this air loss constitutes a significant proportion of the volume reduction experienced by the block during the impact blow. It is possible that some of the air does not escape during the impact time and becomes trapped and compressed within the block. The above values indicate that the increase in pressure would be very small assuming most of the air escapes during the impact blow.

*Diffusion of air into water* – As pressure is applied to the mixture and particle-particle intimacy increases the mixture of air and water and pressure could cause some of the air to diffuse into the water. What then happens to the air when the pressure is removed is open for debate. The solid particles could keep the pressure on the overall matrix and keep the air dissolved in the water, placing the material into tension. Alternatively the air could slowly diffuse out of the water and out of the material long after compaction has been completed. The quantity of air that could be diffused into the water depends on the amount of water present, the applied pressure, the temperature and the amount of air already dissolved in the water. Whilst we cannot rule out the possibility that air may diffuse into the water we can suggest that the effects will be small for a number of reasons. There will only be a small amount of air under pressure throughout the block and the pressure applied to the air will also be small. We have already established that if none of the air escaped then the air pressure within the soil would increase to less than 0.2MPa. We also know that some of the air does escape so it is even more unlikely that air would be diffusing into the water within the soil during initial blows. During latter blows the pressure might be higher, but the volumetric change in the air is even smaller so the effects will still be limited.

*Pressurisation of air in core with slow diffusion out* – We believe that at some stage during the compaction air is being trapped within the block and becoming pressurised during further consolidation. At the end of compaction this trapped air will be at a greater pressure than the local atmospheric conditions. This could suggest that the air pressure in the pores increases during each blow and pressure equalisation occurs some period later as the high-pressure core slowly diffuses out of the material between



blows. It could also suggest that as this pore pressure is increasing it could marginally hinder further consolidation until the pressure has equalised with the atmosphere.

#### 5.1.4 Theoretical models for impactor trajectory during impact

The process of the dynamic compaction is assumed to include a combination of elastic, plastic and possibly viscous effects. In order to anticipate what sort of compaction was dominant in the different stages of compaction, a set of basic equations of motion was derived. These describe the motion for the different effects taken one at a time, (plastic, elastic and viscous) from which a possible position trace could be generated. Below are the theoretical derivations of plastic, elastic and viscous models of impactor retardation.

**Plastic deformation** – constant retardation  $a = -k$

$$x = -\frac{kt^2}{2} + at + b = pt^2 + qt + r \quad \textcircled{1}$$

$$\text{and } v = \frac{dx}{dt} = 2pt + q \quad \textcircled{2}$$

$$\text{(i) at } t = 0, x = 0, \text{ inserting into } \textcircled{1} \text{ gives } r = 0 \quad \textcircled{3}$$

$$\text{(ii) at } t = 0, \frac{dx}{dt} = v_0, \text{ inserting into } \textcircled{2} \text{ gives } q = v_0 \quad \textcircled{4}$$

$$\text{(iii) at } v = 0, t = T, \text{ inserting into } \textcircled{2} \text{ gives } p = \frac{-v_0}{2T} \quad \textcircled{5}$$

$$\text{(iv) However at maximum indentation } (v = 0), x = X,$$

$$\text{inserting } \textcircled{3}\textcircled{4}\textcircled{5} \text{ into } \textcircled{1} \quad \text{giving: } \therefore X = \frac{1}{2}v_0T \quad \textcircled{4}$$

**Elastic deformation** – retardation is proportional to penetration  $\therefore m \ddot{x} = -kx$

$$x = A \cos \omega t + B \sin \omega t \quad \text{①}$$

where  $\omega = \sqrt{\frac{k}{m}}$  is constant

$$\text{and } v = \frac{dx}{dt} = -A\omega \sin \omega t + B\omega \cos \omega t \quad \text{②}$$

$$\text{(i) at } t = 0, x = 0, \text{ inserting into ① gives } A = 0 \quad \text{③}$$

$$\text{(ii) at } t = 0, v = v_0, \text{ inserting into ② gives } B = \frac{v_0}{\omega} \quad \text{④ } \therefore x = \frac{v_0}{\omega} \sin \omega t$$

$$\text{(iii) at } v = v_0 \cos \omega t = 0, t = T, \text{ giving } \omega = \frac{\pi}{2T} \quad \text{⑤}$$

$$\text{(iv) However, at maximum indentation } (v = 0), x = X, \text{ inserting ③ ④ ⑤ into ①}$$

$$\text{gives: } X = \frac{v_0}{\omega} \sin \omega T \quad \text{(5)}$$

**Viscous deformation** – retardation is proportional to velocity  $a = -cv$

$$x = P + Qe^{-ct} \quad \text{①} \quad \text{and} \quad \frac{dx}{dt} = -Qce^{-ct} \quad \text{②}$$

$$\text{(i) at } t = 0, x = 0, \text{ inserting into ① gives } Q = -P \text{ and } \therefore x = P(1 - e^{-ct}) \quad \text{③}$$

$$\text{(ii) at } t = 0, \frac{dx}{dt} = v_0, \text{ inserting into ② gives } Qc = -v_0 \quad \text{④ } \therefore P = \frac{v_0}{c} \text{ and } \therefore c = \frac{v_0}{P}$$

$$\text{(iii) at maximum indentation } (v = 0), t = T, \therefore X = P \text{ and } x = X \text{ inserting into ③}$$

$$\text{gives } x = X(1 - e^{-\frac{v_0}{X}t}) \quad \text{⑤}$$

$$\text{(iv) Relationship between } T \text{ and } X \text{ is } T \gg \frac{X}{v_0}$$

1. If pure plastic deformation occurs then the relationship between  $T$  and  $X$  is

$$T = \frac{2X}{v_0}$$

2. If pure elastic deformation occurs then the relationship between  $T$  and  $X$  is

$$T = \frac{\pi X}{2 v_0}$$

3. If pure viscous retardation is dominant then the relationship between  $T$  and  $X$  is

$$T \gg \frac{X}{v_0}$$

The graph below shows the possible displacement/time trace for the falling impactor as contact with the surface is made and compaction of the material results. The solid curved line represents the trace of the falling impactor whilst the dashed line indicates the original velocity at impact extended to cross the lowest point of impact to determine  $\tau$ .

Figure 5.2 – Theoretical displacement analysis of impactor

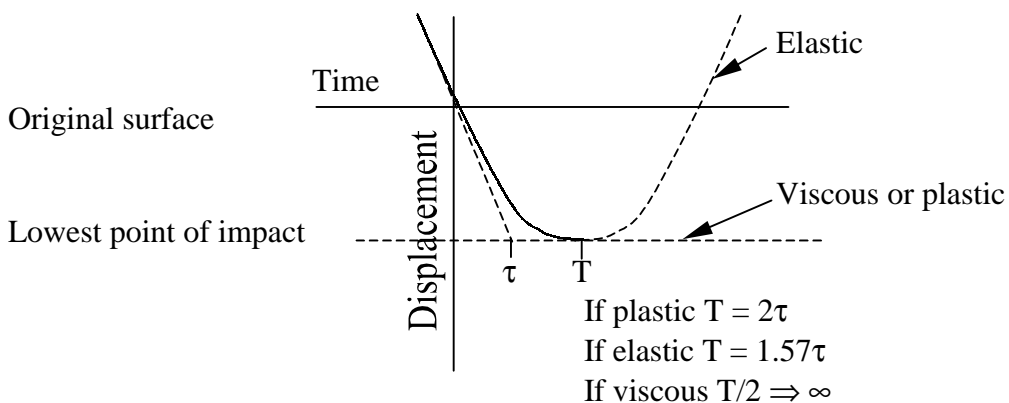

It was hoped that if an actual trace of the motion of the impactor could be gained then this trace could be analysed with reference to the theoretical traces. This would help to determine the dominant effect in the different stages of compaction and perhaps lead

to a deeper understanding of dynamic compaction. If we can analyse the position of the impactor accurately then we should also be able to analyse the position of the top surface of the block during the compressive part of the impact.

## **5.2 Experimental measurement of impact**

Earlier in the project it was assumed one real advantage of impact compaction was that the forces delivered to the block were smaller than with high-pressure quasi-static compression. It was of both academic interest and economic interest to determine whether this assumption was correct or not. Academic because the actions of an impact blow onto the surface of a confined soil sample had yet to be analysed. Economic, because lower forces justify the use of less material in the mould design and general machine structure.

Before attempting to accurately monitor the position of the impactor during a series of impact blows, we estimated certain characteristics from known equations of energy and motion. From experiments conducted earlier we can estimate the actual impactor drop height from relative impactor positions before and after each blow. This data gives the distance travelled and the deformation achieved by the applied blow. The impact sequence can be divided up into a series of sections:

***The impactor lift:***  $h_i = \text{height lifted to impactor stop,}$

$i = \text{blow number}$

***During impactor free-fall:***  $v^2 = 2gh_i ,$

$E = 1/2mv^2,$

$$a = g \text{ (9.81m/s}^2\text{)}$$

**Contact with material surface:**  $F_C = ma$ , (where 'a' is not constant)

**Retardation of impactor and compaction of material:**  $v = 0$ ,

$$u^2 = 2gh_i$$

**Elastic restitution of material:**  $e = \frac{v_2' - v_1'}{v_1 - v_2}$  where  $v_2$  and  $v_2' = 0$

**Impactor bounce:**  $E_b = mgb_i$ ,

$b_i =$  impactor bounce height

Experimentation was conducted on dynamic compaction of soil-B with 6.5% moisture and using a 36.8kg impactor falling through approximately 200mm. Therefore the impactor velocity at impact would be approximately 2m/s and the impact energy would be around 74J.

Several different methods could be used for monitoring the dynamic blow. Remote measurement could be used via a laser or sonic pulse monitoring absolute position. Alternatively a mechanical device or sensor that was attached to the impactor in some way could also monitor the location (e.g. via a rotary transducer) or acceleration (via an accelerometer) of the impactor. For practical and economic reasons it was decided to use a rotary transducer and monitor the relative position of the impactor during the compaction cycle. An accelerometer was also used, but it was only rated up to 25g and consequently could only be used to indicate the point of maximum acceleration rather than measure the magnitude of it.

The rotary transducer was connected to a toothed wheel and mounted onto the impactor guide. A timing belt passing over the toothed wheel had one end connected to the impactor base and the other end connected to a series of springs before being fixed to a remote part of the rig. This arrangement enabled the timing belt to move freely up and down past the rotary transducer whilst also staying sufficiently taut to accurately measure displacement both on the upward and downward strokes of the impactor. A diagram of the arrangement is shown below. The tension in this timing belt is negligible compared with the weight of the impactor.

Figure 5.3 – Diagram of sensor position for impactor analysis

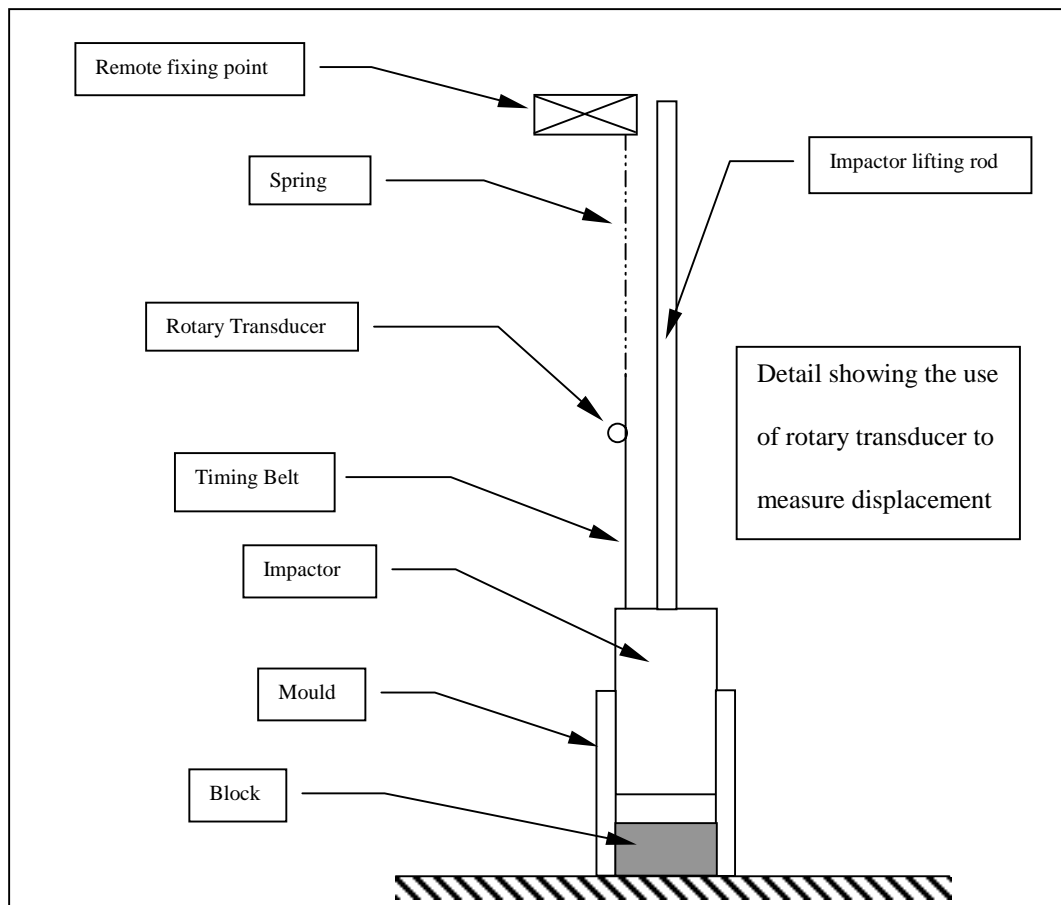

A digital decoder was connected to the rotary transducer to give an 8-bit number output from the transducer and this was intended to be transmitted directly into the parallel port of a computer. Unfortunately serious interfacing problems were encountered in capturing the digital data from the rotary transducer. After many weeks of trying, this method was shelved and another system of analogue analysis using a storage oscilloscope and digital video camera was implemented instead.

The resulting video was then analysed frame by frame to determine the actual position of the impactor relative to the impactor's starting position on the oscilloscope trace. This procedure was incredibly laborious and generated results of only passable numerical accuracy. Consequently it was only carried out on traces taken from the 1<sup>st</sup> and 38<sup>th</sup> blow delivered to a sample of soil. Traces from other blows were only analysed at the impact point determining the amount of compaction achieved, the impactor bounce height and the elastic displacement of the material.

### **5.2.1 Impactor position, velocity and acceleration**

Below are snapshots taken from the compaction video of two separate blows delivered to a test sample. On the left of the snapshot one can see the descent of the impactor indicated by the almost vertical lines running from the top to the bottom of the screen. Eventually contact is made with the sample and the impactor comes to a stop before bouncing backwards, (indicated by the hump). The flat line on the right side of the snapshot gives the final resting position of the impactor.

Figure 5.4 – Signal traces from rotary transducer and accelerometer during impact

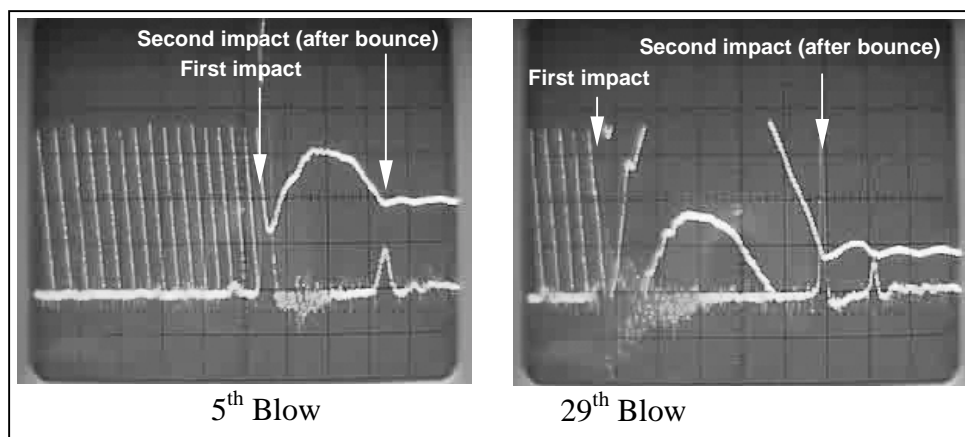

Spikes on the second line on the snapshots (the accelerometer trace) indicate the peak acceleration at impact both for the initial impact and for the subsequent bounce(s). It is clear that during the 5<sup>th</sup> blow the accelerometer is experiencing significant shock from the impact blow well in excess of its working range of 0.5 volt (vertical scale 1 div = 0.5V = 250m/s<sup>2</sup>). The shock becomes even more significant during latter blows. The rotary transducer was calibrated for displacement using a different system than the recording system and this resulted in an error of a factor of two throughout the data recorded. Once the error factor was found, then the data could be adjusted and the corrected results are reasonably close to the theoretical calculations for the experiments, hence making them of satisfactory accuracy for experimental interpretation.

The following data comes from another block that was manufactured by impact compaction with careful analysis of the video traces received from the experimental equipment described above. The results of the two position traces from the 1<sup>st</sup> and 38<sup>th</sup> blow can be seen in the graph below. For both of the traces the approximate soil level prior to the impact has been indicated as zero displacement and from this the level of



compaction or the elastic deformation can be identified. The data presented has also been time shifted to superimpose the two traces so that they coincide at their respective point of impact. The results demonstrate the significant difference between the initial blow applied and the much later blow where densification per blow has become very small.

Figure 5.5 – Graphical representation of impactor displacement

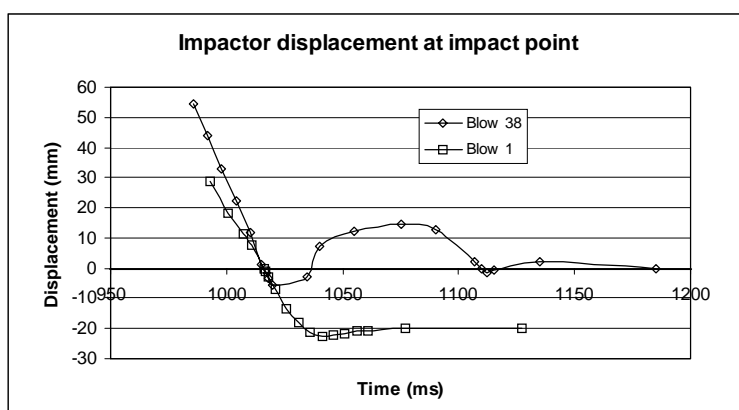

We can take a closer look at the impact region of the graph and analyse it with respect to the models generated earlier. The graph in the figure below shows the graphical interpretation of the trace. It is unfortunate that these numerical results do not seem to correspond very well with the theoretical models for impactor motion. This can be seen with the initial blow and where the impactor initially comes to rest more than 20mm below the original surface. The theoretical data suggested that for a completely plastic material deformation  $T = 2\tau$  and if completely elastic  $T = 1.57\tau$ . The dashed lines drawn onto the graph indicate the theoretical lines for determining  $T$  with respect to  $\tau$ . By inspection we can see that  $T < 2\tau$ , but also less than  $1.57\tau$ .

Figure 5.6 – Close up of impact point

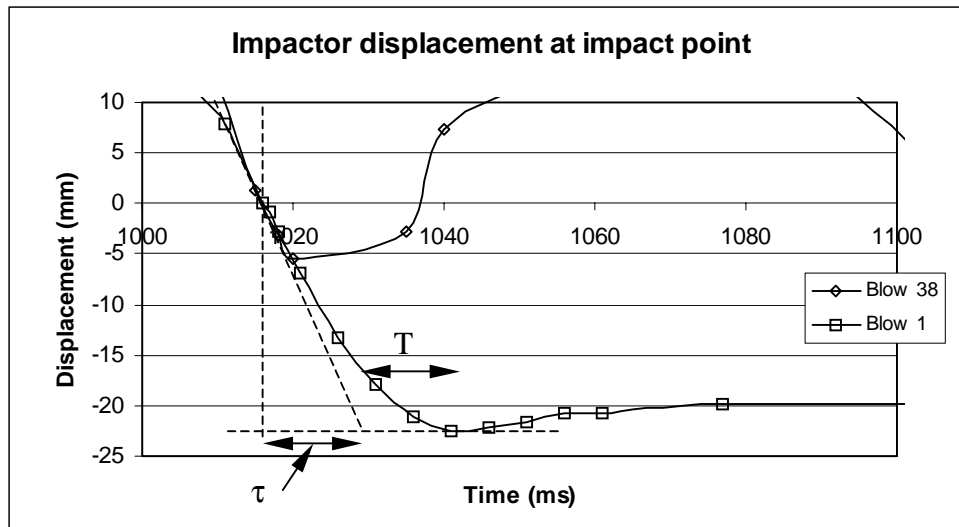

The graphical trace indicates at least three things. One, the curvature of the graph increases with displacement, (favours elastic over viscous interpretation). Two,  $T < 1.57\tau$  indicates some plastic or viscous action. Three, Rebound is small indicating plastic or viscous action. During the 38<sup>th</sup> blow the evidence is also a little confusing. Latter blows would be expected to be predominantly elastic as any plastic deformation has reduced to almost zero. However, the above graph indicates that for the 38<sup>th</sup> blow  $T \approx \tau$ . Perhaps these results could be interpreted in the following way. Initial blows are predominantly plastic ( $T$  is large) but as the sample becomes more compacted the plastic element decays and an elastic component becomes noticeable ( $T$  is smaller). This does in fact correspond with the theoretical data as  $2\tau$  (plastic) is larger than  $1.57\tau$  (elastic). Perhaps the numerical accuracy of the data received doesn't warrant any deeper or further analysis than this.

The changes that occur to the compaction process can also be monitored from the data received from the compaction video. The figure below shows the impactor displacement for three separate stages of an impact. The plotted variables are:

**Compaction** – permanent change in block height from the applied blow

**Restitution** – assumed elastic deformation of block during impact, defined as the recoil height of block surface from maximum indentation to final steady state

**Bounce** – height of impactor bounce after impact relative to final block surface (assumes negligible compaction from subsequent bounce impact)

The graph shows some very interesting phenomenon that has not been seen before. We can see that the compaction graph complies with the pattern of dynamic compaction as seen already, which gives us assurance that the measurement method is working OK. However, what we haven't seen before is the elastic region of the impact and the impactor bounce height relative to the block surface. It seems that there is a limit to the elastic deformation of the material, possibly dependent mould stiffness rather than the block material itself. This limit of elastic deformation stabilises at about 5mm after the first few blows. It should also be remembered that the impactor energy is almost constant, especially after the first few blows.

Another more striking feature of this data is that the bounce height of the impactor increases linearly after each blow and only seems to level off during the last few blows. This result combined with the almost constant elastic deformation of the block gives us a good clue about what is happening within the material. As the material becomes compacted the elastic restitution increases with each blow. Therefore subsequent blows achieve a greater bounce height than the previous blows do. The

elastic restitution is dependent on the materials that come into contact and their respective velocities. Generally the elastic restitution is related to the material hardness, and we believe that the block is becoming harder with compaction and therefore this fits in with the data quite well.

Figure 5.7 – Impactor position analysis for complete block production

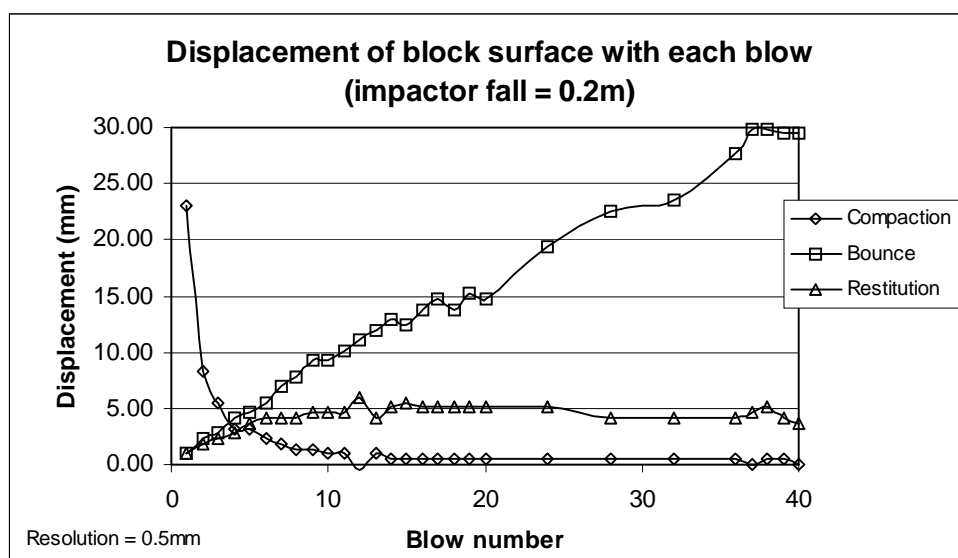

Up until the 20<sup>th</sup> blow a marginal compaction could be measured for each blow. After this the compaction is measured after every four blows to ensure a measurable compaction within the resolution of the equipment. It can be seen that the increase in compaction per blow drops to virtually zero after 20 blows, yet the bounce height seems to rise steadily. This phenomenon suggests that the elasticity of the material is increasing with each blow.

### 5.2.2 Changing material properties during compaction

We already know that the density of the material changes during compaction, but we now have good reason to believe that the overall material stiffness is also changing during compaction. This seems plausible as the material is increasing its resistance to further consolidation with similar energy blows and the impactor rebound height is increasing. We know the mechanical properties for the air and water and their respective fractions during the compaction sequence. We can also assume a certain overall stiffness of the material from the elastic restitution and rebound height of the impactor.

We can apply a parallel stiffness model or a series stiffness model to the composite material of air, water and rock. If we select the parallel stiffness model the stiffness of the material will be dominated by the rock, whilst the series stiffness model will be dominated by the air. We believe that the air within the block is playing a significant part in the compaction so we will apply the series stiffness model first.

If we replace stiffness by elastic bulk modulus we can estimate the elastic bulk

modulus of the material using the following equation: 
$$\frac{1}{G'} = \frac{\lambda}{G_a} + \frac{\gamma}{G_w} + \frac{1-\lambda-\gamma}{G_r}$$

Where  $\gamma$  and  $\lambda$  are the volumetric fractions of water and air during a sequence of impact blows.

By using  $c = \sqrt{\frac{G}{\rho}}$  and working backwards from the speed of sound through air and

water and their densities we can estimate the values of G for air and water to be 0.13MPa and 2.0GPa respectively. We have a range of 20 to 150GPa for the Young's

modulus (E) for rock taken from an Ashby diagram (Department of Engineering, 1996). Depending on the constraints this can be converted to bulk modulus using either  $G = \frac{3E}{8}$  (tri-axial) or  $G = \frac{E}{3}$  (uni-axial). This gives us a possible range for G of 6.7GPa to 56.3GPa. If we take a midrange value of 30GPa and calculate G' for the material at the beginning and end of consolidation we get a range of 0.28MPa to 0.78MPa. Knowing the final density as 1880kg/m<sup>3</sup> we calculated the final speed of sound through the material as 20m/s, (far less than the speed of sound through air alone). We then tested the speed of sound through a similar freshly compressed block using a pundit tester and after calibrating the device a speed of 490m/s was recorded. This suggests that the speed of sound through the block is dominated by the speed of sound through the small fraction of air and the series model is inaccurate by at least an order of magnitude.

With the parallel model we assume that the material is stacked in parallel and calculate G' using  $G' = G_a\lambda + G_w\gamma + G_r(1 - \lambda - \gamma)$ . This model yields a range for G' between 14GPa and 21GPa. If we again attempt confirmation by calculating the speed of sound through the material we get a maximum speed of 3342m/s, (grossly dominated by the speed of sound through the solid). From this we can assume that the mechanism by which sound travels through a composite material follows a model other than the parallel or series stiffness model. One would expect that the sound would travel through the solid material, hindered by the point contacts and interfaces with the water and air that surround them.

We can propose one further model that suggests that the total time through the material is the sum of the times through the solid, water and air taking the proportions rock, water and air as a fraction of the whole distance travelled. Taking the fractions of the total volume of the finished block and the speeds of sound through rock (estimated using  $G$  as 30GPa), water and air, using:  $c' = c_a\lambda + c_w\gamma + c_r(1 - \lambda - \gamma)$  we get an overall speed of 2620m/s. Unfortunately, as this model depends on the accuracy of  $G$  for the rock we cannot suggest that this model is superior than the parallel model despite yielding a better value for  $c'$ .

These investigations suggest that there is some link between the increasing consolidation affecting the block bulk modulus. The ranges for  $G'$  are numerically inadequate because they are based on a wide range of  $G$  for rock. Using the speed of sound through a *cured* block that was made yields a value for  $G'$  at around 10GPa. However, assessment of the Young's modulus on a freshly quasi-statically compacted block still constrained in the mould gives a value of 0.7GPa. Converting this to bulk modulus results in a rather low value of 2GPa, similar to that of water. The curing process will make the block stiffer and therefore increase the bulk modulus significantly so an initial value of 2GPa increasing to 10GPa is not unreasonable. Unfortunately we have not been able to establish a suitable model to determine the value of  $G'$  during the compaction procedure. All we can say is that as the material becomes compressed the rebound height increases and therefore the stiffness of the material also increases. Without an accurate value for  $G$  for the rock material we cannot verify our models or the results attained.

### 5.2.3 Maximum acceleration experienced by impactor

Early calculations conducted by (Montgomery, 1997) utilised an estimated stopping distance and time to estimate the acceleration and hence the force applied to the surface of the block. With the data that was collected from the rotary transducer a more accurate estimate could be made for the stopping distance. From the known impactor velocity prior to impact (calculated from the drop height) and the distance in which the impactor came to a stop the acceleration could be calculated.

By ignoring the horizontal scale on the traces (defining the time) and just looking at the height changes from the vertical scale it was determined that during latter blows the impactor came to a stop in 5mm from a velocity of 1.8m/s (drop height of 0.19m). By assuming ideal plastic deformation and hence constant rate of change of velocity we can determine the acceleration, (using  $v^2 = u^2 + 2as$  where  $v = 0$   $u = 1.8\text{m/s}$  and  $s = 0.005\text{m}$ ), giving a constant deceleration of  $324\text{m/s}^2$ .

For *plastic* deformation model use:  $v^2 = u^2 + 2ah$  which gives a value of  $a = \underline{324\text{m/s}^2}$

If deceleration is proportional to penetration (i.e. *elastic*):  $a = -kx = v \, dv/dx$

$$k = (1.8/0.005)^2 = 129,600$$

$$\text{Max acceleration} = 0.005k = \underline{648\text{m/s}^2}$$

If compaction follows *viscous* model then:  $a = -cv = v \, dv/dx$

$$c = V/X, a_{\text{max}} = cV = V^2/X$$

$$\text{Max acceleration} = 1.8^2/0.005 = \underline{648\text{m/s}^2}$$

Maximum acceleration during elastic or viscous deformation would be about twice as large at around  $\underline{650\text{m/s}^2}$ .



These values do not take into account the bounce achieved by the impactor, that drive the acceleration experienced by the impactor even higher. If the impactor bounces upwards with an initial velocity of 0.9m/s then the total change in velocity is 2.7m/s. If the compaction distance is 0.005m and the elastic restitution distance is 0.006m then  $s = 0.011\text{m}$  and the maximum constant acceleration is  $331\text{m/s}^2$ . Again this value could be as much as twice as large for elastic or viscous effects.

#### 5.2.4 Losses in the system

During very late blows no significant densification is achieved with each blow. It can therefore be assumed that no useful work is being done to the material and all the impact energy is being lost through a number of mechanisms.

***Kinetic energy*** – energy restored to the impactor causing it to bounce and vibration  
energy dissipated through the floor and foundations

***Heat energy*** – hysteresis losses from elastic displacement of material and mould

***Sound*** – energy lost through the generation of noise

Unfortunately the only mechanism that we can easily measure is the kinetic energy restored to the impactor. The rebound height of the impactor after impact gives an indication of the elastic energy required generating a restoring force sufficient to make the impactor bounce. We can assume that the energy attained by the impactor using  $E_b = mgb_i$  is equal to the elastic energy delivered by the material into the impactor. Using initial bounce velocity of 0.9m/s yields a final bounce height of 0.04m requiring 15J of energy for a 36.8kg impactor. Initial impactor energy is around 75J so

approximately 20% of the energy is lost during impactor bounce. The rest of the energy is lost through a combination of vibration dissipation, hysteresis and noise.

We have experimental evidence for the hysteresis losses incurred by quasi-static compression of full-size blocks from tests conducted on *soil-B*. The elastic deformation from impact compaction is higher than with quasi-static compression so it is reasonable to assume that the hysteresis losses would also be larger.

The data presented in the figure below is from the compression of a full-size block of soil-B compressed to 40 tonnes and then recompressed a second and third time monitoring the displacement of the two ends of the compression plate during the cycles. From this graph we can estimate the hysteresis losses experienced in the compression of the material to 40 tonnes. Calculation of the energy lost through hysteresis is the total energy input less the elastic restitution energy restored. For the block featured below the hysteresis losses were 16J for the second cycle and 31J for the third cycle. Please notice that the displacement achieved by the application of 40 tonnes is only about 2.5mm rather than the 5mm elastic displacement experienced during an impact blow.

Figure 5.8 – Hysteresis effects on compression of full-size blocks

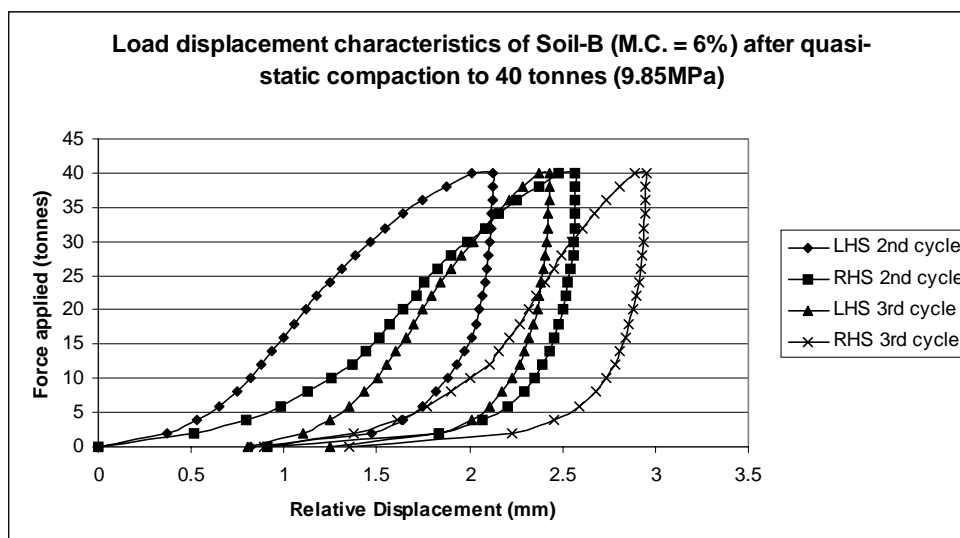

These hysteresis losses are not insignificant and could apply to dynamic compaction as well. Furthermore the losses experienced by elastic deformation during dynamic compaction of twice that recorded by quasi-static suggests that the loss of 60J is not out of the question. Noise generation and machine vibration are other possible outlets for energy losses that we are unable to easily isolate and determine the magnitude of.

It is improbable that these losses are present during very early blows as very little elastic deformation occurs initially. From this we can suggest that the impact initially delivers most of the impactor energy into compaction and then as the elastic restitution element increases the energy begins to be lost through impactor bounce and hysteresis within the material.

### 5.2.5 Assessment of forces for machine design

Now that we have reasonably accurately measured the relative position of the impactor during an impact blow we can make some assumptions and try and extrapolate the values to give estimates for the forces applied. Three different models were proposed elastic, plastic or viscous, and the maximum possible accelerations were calculated for each model. We need to extrapolate these results to yield possible values for a larger impactor being dropped from a greater height.

In the plastic model the acceleration is constant and therefore the resistive force is also constant. We know the 36.8kg impactor when dropped from 200mm penetrated the block during a latter blow by 0.005m. This was not entirely plastic, but lets assume that it was for a moment. Lets also assume that the resistive force of the material does not change during the impact, (consolidation does not occur). The indentation distance now depends on the impactor energy divided by the resistive force  $\Delta = \frac{mgh}{F_p}$ . So increasing the impactor drop height by a factor of two and the mass from 36.8 to 60 will result in a larger indentation by a factor of 3.26, but the same maximum force.

In the elastic model the material acts like a spring, so the higher impactor energy will change the indentation  $\Delta$  and therefore maximum force as well. Using the energy of

the impactor:  $mgh = k \frac{\Delta^2}{2}$  to give  $\Delta = \sqrt{\frac{2mgh}{k}}$  and

therefore,  $F_{\max} = \sqrt{2mghk}$  such that only  $m$  and  $h$  are variable. Increasing the impactor mass and drop height now increases the indentation by a factor of  $\sqrt{3.26}$  or 1.8. With greater indentation the force is also increased by a factor of 1.8.

In the viscous model the maximum force is dependent on the initial velocity of the impactor which has now been increased by a factor of  $\sqrt{2}$ . Calculating the increase in indentation is more complex because it depends on both the increase in velocity and the increase in impactor mass. Hence  $\Delta = \frac{mv_0}{k}$  so if the mass increases by 1.63 and  $v_0$  has increased by  $\sqrt{2}$  giving a combined increase of 2.3.

The table below summarises these relationships and extrapolations and leads us to suggest that the range of possible forces that could be applied is between 12kN and 43.2kN. Crudely taking an average for the three models yields a force of 30kN. Converting this to a pressure on the top of the block yields only 0.74MPa.

Table 5.1 – Extrapolation of compaction forces

	Indentation depth $\Delta$ (mm)	Maximum Force (kN)
Plastic Model		
36.8kg falling 200mm	5 ‡	12 †
60.0kg falling 400mm	$5 \times 3.26 = 16.3$	$12 \times 1 = 12$
Elastic Model		
36.8kg falling 200mm	5 ‡	24 †
60.0kg falling 400mm	$5 \times 1.8 = 9$	$24 \times 1.8 = 43.2$
Viscous Model		
36.8kg falling 200mm	5 ‡	24 †
60.0kg falling 400mm	$5 \times 2.3 = 11.5$	$24 \times \sqrt{2} = 34$

‡ - measured value

† - calculated value

We still believe that only a fraction of this force is felt at the mould sides. The literature suggests that the maximum force experienced on the sides of the mould is about 70% of the force applied to the top. We also need to take into account the change in the area that the force is applied to. The top plate is 0.0406m<sup>2</sup> and the area

of the mould side that we wish to design has a width of 0.29m and a height of 0.1m giving a wall area of 0.029m<sup>2</sup>. Assuming the pressure remains the same throughout the material, the force applied on the side  $F_s$  can be calculated using  $F_t A_t = F_s A_s$  to be  $1.4F_t$  which virtually cancels the 70% reduction suggested above. Consequently the force applied to the sides of the mould are approximately 30kN. It is now possible to use this figure to confirm the performance of the mould during the tests and apply the data to machine design.

## **6 Machine design and development**

The motivation for research into dynamic compaction of soil blocks was the need to solve a specific practical problem. The pioneer in the dynamic compaction of soil blocks, A. Groth (1987), went on to make a machine and built houses in Botswana with the finished blocks. Gooding (1993) made significant improvements in the understanding of dynamic compaction and suggested some parameters for machine design. Montgomery (1997) took those parameters and proved the potential of the process in the laboratory for full-size blocks. The experiments conducted during this Ph.D. have further improved the understanding of dynamically compacted production of full-size blocks. The next stage was to develop a suitable prototype for field trials and dissemination. This chapter describes the design methodology, the application of experimental results to machine design, the modifications made to the mould and the way that prototype models of Lego<sup>®</sup> were used to aid design selection.

### **6.1 Approach to a production machine**

The next stage in the design process was to draw up a set of specifications for the machine. The development of specifications can be a cyclic process with several iterations performed before a final set is chosen. The specifications outlined in this section derive from the understanding of the dynamic compaction process, the required block characteristics and the limitations of machine construction in developing countries. The specifications outlined here can be split up into three different sections. One section deals with the requirements for easy machine

manufacture. The second section is concerned with machine operation and use. The final section confirms the desired characteristics of the blocks produced by the machine and discusses methods that achieve them.

The Test Rig that was used for the experiments reported in previous chapters, is different both in form and function from a production machine. The Test Rig required a greater degree of flexibility than is necessary for production. Moreover, machine productivity was not a major concern during experimentation. Whereas a production machine needs a high production rate and its design needs to facilitate that.

### **6.1.1 Design for ease of manufacture**

*Machine to have few moving parts* – Soil can act as an abrasive if permitted to come between moving metallic parts of a machine. It is therefore important to design the machine with as few moving parts as possible. Those moving parts essential to its function should be located where the likelihood of soil contamination is small. The use of rolling element bearings should be avoided, as these will be especially prone to degradation from the presence of soil.

*Simple to manufacture and maintain* – Many developing countries already have a surplus of complex machinery that cannot readily be maintained. We do not want to be adding another machine to this category. The design of the machine should therefore take into consideration the level of technical competence and tooling availability in the area where it is to be used. Through personal experience and communication with other researchers in machine development, a basic level of skill and tooling has been identified. If the machine can be locally manufactured then the



necessary maintenance and repair work could also be performed locally. The machine needs to be manufactured using basic power tools such as a manual metal arc (stick) welder and a hand held angle grinder. These two tools can be found in many manufacturing centres in developing countries. Processes such as milling, grinding and even drilling are less common and require more specialised tooling and operator training, hence they should be excluded from the machine production if possible.

***Low-cost alternative to hydraulic block press*** – The aim was to meet the need for a low-cost machine that can produce a comparable block to that from a hydraulically assisted press. The removal of the hydraulic circuit, thick-sided moulds and heavy-duty bearings will dramatically reduce the overall cost of the machine. But this is only the start of potential cost reduction from machine design. Machine tolerances should be as large as possible to remove the need for some jigs and fixtures during machine production. Specific parts that need to be purchased, like hinges, should be kept to a minimum. Wherever possible parts should be manufactured on site reducing the costs and improving the potential for local maintenance. Greater emphasis needs to be placed on the function rather than the form of the machine.

### **6.1.2 Design for ease of use**

***Machine portability*** – We intend to reduce the transportation of soil and therefore promote an on-site building material production unit that utilises very local or on-site soil to make blocks. The machine will therefore need to be easily portable as a complete unit or at the very least it will need to be separable into different parts for moving from one site to another and reassembled with relative ease. This portability

requirement of the machine should limit the weight of any single part of the machine to less than 100kg.

***Low personnel requirements*** – Block production requires about 2.5kJ of human energy to compact each block. The rate of block production will therefore depend on the power output of the production team. The application of good ergonomic design and team rotation of the most arduous activities will help to maximise the productivity of the team. It is estimated that a team of three persons could operate the machine continuously to produce at least 60 blocks per hour (mean power output of 42W).

***Safety and ease of use*** – Dynamic compaction uses a heavy mass that falls onto the top of the block in a mould. Falling masses present a significant hazard and this machine should include adequate protection for its users and for bystanders. Improved safety can be achieved through good working practices, training and built-in safety mechanisms.

### **6.1.3 Confirming the block specifications**

***Block size and shape*** – The standards outlined in (Centre for the Development of Industry, 1998) define 6 types of blocks based on the standard parallelepiped shape. Some include perforations, horizontal and vertical indentations. It is not possible to produce every type with a single machine, but some machines can produce several different types with minimal modifications. Such a capacity should be incorporated into the machine design. For example, a block mould can be modified to include a frog relatively easily. Additional features on the block make the machine marginally more complex, but can significantly improve the block characteristics and reduce material consumption.

***High-density block production*** – Chapter 3 showed that the achieved density of the compacted block is closely related to its compressive strength. For the purposes of the machine design we have taken the requirement that the block has a wet compressive strength after 7-day curing of 2MPa. In order to achieve this strength a projected dry density of around 2000kg/m<sup>3</sup> is necessary. From this density we can estimate other necessary parameters from the experimental results, such as the ejection force.

***Versatility in material usage*** – One of the limitations of making blocks out of soil, is the specific range of soils that are should be used. Block compaction via impact can accommodate a wider range of soils, giving it greater site versatility. This can be further enhanced by machine versatility using different impactor arrangements and number of blows.

## **6.2 *Interfacing dynamic compaction with machine design***

Now we have a slightly better understanding of the process of dynamic compaction and the mechanisms involved during consolidation. From our experience in the production of small cylinders and full-size blocks we can reduce the ranges of certain machine design parameters. This section derives suitable parameter values from the experimental findings.

### **6.2.1 *Optimisation of energy transfer***

Previous research (Gooding, 1993) has already established that the application of neither one or two very high energy blows nor a very large number (e.g. >64) of low energy blows is as effective as a modest number of medium energy blows. This

optimisation study was repeated during this research using the small cylinders. The results indicated that over the range investigated (4 to 32 blows), there was a little variation (<1%) in the achieved density and a modest variation (13%) in the resulting strength for the energy transferred.

The results presented in Table 6.1 are for small cylindrical samples that each received a total energy transfer of 157J via a range of impactor masses, drop heights and number of blows. The 7-day W.C.S. and the P.D.D. shown are the average of three samples produced at each arrangement.

Table 6.1 – Small cylinder production using constant energy transfer

Number of Blows	Mass of impactor kg	Drop height m	P.D.D. kg/m <sup>3</sup>	7-day W.C.S. MPa
4	10	0.4	1980	1.62
8	5	0.4	1992	1.73
8	10	0.2	2017	2.02
16	2.5	0.4	2003	2.26
16	5	0.2	1993	2.17
32	2.5	0.2	2003	1.93

From the table above we can see that for each arrangement the P.D.D. is within  $\pm 1\%$  of the target of 2000kg/m<sup>3</sup>. As the inherent variability of the block density is also around 1%, we could conclude that 6 combinations of impactor mass, drop height and number of blows are equally satisfactory. However, the 7-day W.C.S. varies by slightly more than the inherent variability of 10%. The data indicates that the W.C.S. is highest between 8 to 16 blows and drops off at 4 or 32 blows. We will therefore limit the blow number (n) to between 8 to 16. Extrapolating these compaction parameters to produce a full-size block with a soil mass 40 times larger, needs to be done with care. Direct extrapolation of the energy used would suggest that about 6.3kJ

of energy is required. However we know from Chapter 4 that only 1.8-2.4kJ is sufficient to adequately compact a full-size block to 2000kg/m<sup>3</sup>.

Other considerations need to be applied during extrapolation that affect the ergonomics and productivity of the proposed production machine. Higher values of  $n$  will reduce the productivity of the machine as each blow takes 2-3 seconds to apply. We would not want to be lifting a mass of over 80kg, even with some form of mechanical lever. We have found that a 60kg impactor worked sufficiently well during experiments on the Test Rig. The lifting height for the impactor needs to have an upper limit of 400mm otherwise the lifting mechanism becomes un-ergonomic. More complex lifting mechanisms add to the cost and size of the machine. Higher lift heights generate higher impact velocities that may also generate detrimental negative pressure rebound waves.

Using the above upper limits for impactor mass ( $M = 80\text{kg}$ ) and drop height ( $h = 0.4\text{m}$ ) and knowing the maximum energy (2.4kJ) required making a block with P.D.D. of 2000kg/m<sup>3</sup>, we can calculate the minimum number of necessary blows to be 8. If only 1.8kJ is required then this reduces to only 6 blows. From this we can select suitable design values for the machine to be  $M = 60\text{kg}$ ,  $h = 0.4\text{m}$ ,  $n = 8-10$  to achieve a target of 2000kg/m<sup>3</sup>. However, if de-lamination occurs at 0.4m then the drop height can be reduced to say 0.3m without increasing the number of blows too significantly ( $n = 10-14$ ). This gives the machine a degree of flexibility to cope with different circumstances without further modification.

### 6.2.2 Improved impactor constraint

During the experimentation it was noticed that the top surface of the block had an intolerably high variation in its slope. This was believed to be a result of a combination of the following: the impactor falling at a slight angle, the base plate of the impactor being incorrectly aligned with the base of the machine and poor placement of soil in the mould. Originally the impactor of the Test Rig was a solid block of reinforced concrete with a metal plate at the bottom welded to the reinforcing bar. Initial tests with this indicated that the concrete was suffering from fatigue and beginning to crack. This prompted the change to a cylindrical metal impactor, but in so doing the impactor alignment became more difficult.

Part of the problem was that a rope pulley some 5 meters above the ground was the only lifting point for the impactor. Even with a 400mm linear bearing at approximately 2 meters off the ground it was virtually impossible to constrain a 60kg impactor successfully over a 400mm free fall. Better impactor constraints could have been implemented, but not without extensive rebuilding of the rig.

The original design for the impactor and impactor constraint could still be acceptable if the concrete was contained within a skin of steel. We need to determine the maximum permissible clearance between the impactor and the impactor guide so that the maximum angle at which the impactor can fall will not produce an unacceptable variation in the block height. This surface variation arises from the impactor rotating in the guide very slightly in both planes of constraint and thus is the sum of two components.

According to (Centre for the Development of Industry, 1998) the acceptable height variation across a block is  $\pm 2\text{mm}$ . The interior dimensions of the mould is  $0.29\text{m}$  by  $0.14\text{m}$ , and clearly to avoid any chance of the impactor hitting the mould sides, the interior dimensions of the *impactor guide* should be smaller than this, say no bigger than  $0.288\text{m}$  by  $0.138\text{m}$ . The impactor itself will be smaller still in order to give a clearance between the impactor guide and the falling impactor.

The variation ( $v_x$ ) caused by rotation about the x-axis and ( $v_y$ ) caused by rotation about the y-axis should sum to not more than  $4\text{mm}$ . The diagram shown below indicates how these variations can be calculated using the length of the impactor ( $L$ ), the width of the impactor guide ( $W$ ), the tolerance ( $T$ ) between the impactor and the impactor guide and the tolerance ( $U$ ) between the impactor guide and the mould. If we take  $L$  as  $500\text{mm}$  and  $W_x$  as  $288\text{mm}$  for the x-axis constraint and  $W_y$  as  $138\text{mm}$  for the y-axis constraint we can calculate the maximum acceptable tolerance to be  $1.8\text{mm}$ .

Figure 6.1 – Impactor constraint diagram

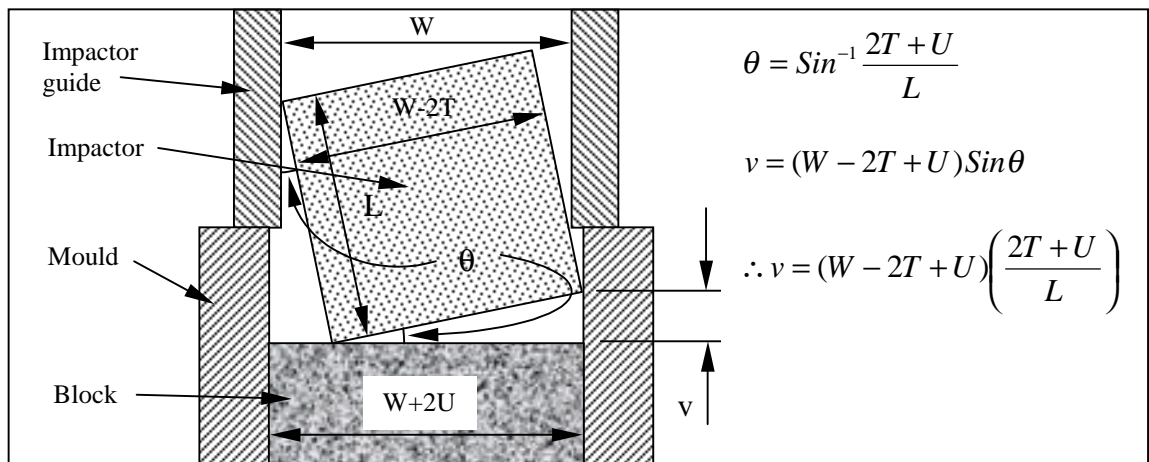

These calculations suggest that the impactor should be about 1.8mm smaller on all sides than the impactor guide, i.e. 284.4mm by 134.4mm. For design purposes we will select 285 by 135mm as the dimensions of the impactor.

### **6.2.3 Ergonomics and productivity**

Having now selected a suitable design of impactor we now wish to establish the method of energy transfer to the impactor to lift it to the desired height. The lifting mechanism may provide some mechanical advantage or may even be mechanised to reduce the human effort required. However the energy requirement remains constant and the more complex the mechanism the more potential there is for losses in the system. Ergonomic data {Gee, 1997} suggests that the aerobic energy output of a human is between 70-175 watts (W) for light intensity work, but this value would be lower in a hot environment.

We need to be applying a maximum of around 2.5kJ to each block and we wish to produce at least one block each minute. This equates to a man power requirement of 42W, easily within the range of a single person. However the force required lifting a 60kg mass is 600N, and the mass will be moved through 0.4m during approximately two seconds. This results in a power requirement during the lift phase of each impact cycle of approximately 120W. It is particularly difficult for the human body to apply such force and power and then cease them suddenly, as would be necessary to drop the impactor. This presents a design problem that can have a number of different mechanical solutions:



- Single pulley and two persons pulling on the rope (each exerts 300N through 0.4m)
- Single pulley and one person pulling on a lever attached to the rope (exerts 300N through 0.8m)
- Double pulley system and one person pulling on the rope (exerts 300N through 0.8m)
- Double pulley system and one person pulling on a lever attached to the rope (exerts 150N through 1.6m)
- Double pulley system and motor driven capstan operated by one person

The solution that was selected for the Test Rig was to use a double pulley system and a capstan driven by a high voltage DC motor. This may not be convenient or appropriate for the Production Prototype machine, and this will need to be assessed when the machine design is disseminated. A suitable system will need to be developed locally, that matches the available resources where the machine is going to be used.

### **6.3 Design of the mould**

This section explains some of the changes that were made to the design of the mould as a result of experimental work. The Test Rig was designed with the Production Prototype in mind, so many of the essential parts of the Rig closely resemble the prototype design. Assessment of the mould design used in the Test Rig has indicated where it is in need of modification prior to incorporation in the Production Prototype.

### 6.3.1 Confirming mould stiffness and strength calculations

The Test Rig mould was designed on the presumption that a maximum pressure of 5MPa is applied to the top of a block. This reduces to a pressure of approximately 3.5MPa on the side of this block, which equates to a force of 200kN distributed over the sides of the mould during compaction. We further assumed that the mould side could be modelled as a beam with encased ends supports. Adequate mould stiffness had been assumed to be the primary concern and the design deflection was restricted to be less than 1mm. A spreadsheet was drawn up to determine an appropriate arrangement of ribs for the mould sides. The mould side was selected to be 0.29m wide and 0.2m high with a material thickness of 0.005m, its height necessarily greater than the finished block height (90-100mm).

The calculations led to the selection of four 40mm wide ribs placed evenly around the mould. The ribs had the same thickness as the mould sides (5mm) to reduce the number of material sizes required for mould production. Four ribs were selected because they would provide stiffness all over the side of the mould rather than in just one plane. Four was considered to be a low enough number to permit sufficient access to the base of the ribs for welding to be carried out. This mould design led to a calculated maximum central deflection of 0.9mm from a distributed load of 200kN. This mould did not plastically distort during the dynamic compaction tests on full-size blocks.

With the data collected from the dynamic compaction analysis, the mould design detailed above can now be checked. The different dynamic compaction measurements from Chapter 5 suggested that the force delivered to the top of the block during an

impact blow could be around 30kN. The maximum stress in the mould had not been calculated previously, and although the mould remained undistorted during block production we still want to double check our calculations with this new force estimate. This force of 30kN was found to give a maximum stress of 109MPa in the mould side, about 40% of the yield stress for M26 steel, giving a factor of safety of about 2.5. We would have preferred 3 or 4, but we can still suggest that this is OK because we have ignored the additional mechanical constraint provided by the joint between the mould side and the base of the mould. This joint will increase the strength of the mould side and therefore raise the safety factor to acceptable levels. This lower force (of 30kN) reduces the side deflection of the mould to 0.13mm or 0.19% of the block width, which is excellent. Now we can be sure that the original mould will perform adequately in terms of both yield stress and deflection displacement.

A further test was conducted by putting the mould in a machine press to test the wall deflection when a measured force was applied to a batch of soil inside the mould. The deflection was monitored using two dial gauges positioned at the midpoint of the block (50mm above the base of the mould). The soil surface was cyclically loaded and unloaded in 0.1MPa increments up to 1MPa. The deflections observed are shown in the figure below. Greater displacement was noticed on the front dial gauge because the front of the mould was the removable section of the mould and would therefore move slightly prior to material deflection. The graphs indicate that the displacement experienced is around 0.22mm at 1MPa. Our calculations had indicated that a force of 30kN (equivalent pressure of 0.52MPa) should yield a displacement of 0.13mm. Therefore our computation (0.25mm/MPa) and experimental (0.22mm/MPa) are in good agreement.

Figure 6.2 – Mould deflection under 1MPa pressure

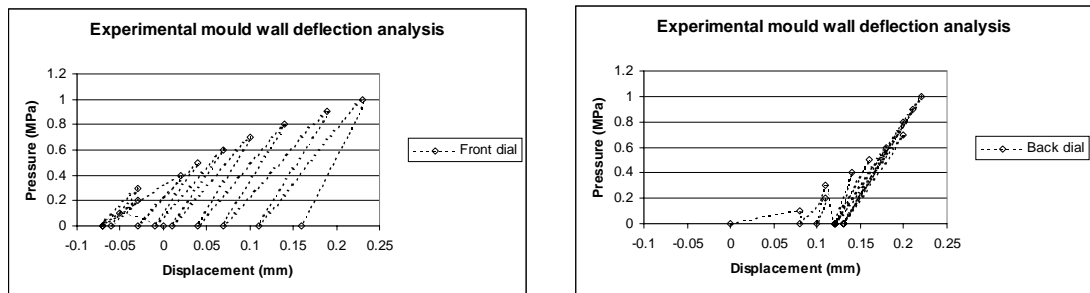

From these experiments and analysis we can now confirm that the mould design that was developed for the Test Rig is a suitable design for incorporation into the Production Prototype. It performs adequately on strength and stiffness and uses a tolerable amount of metal (11.2kg) to achieve this.

### 6.3.2 Further mould design developments

Early in the development of the Test Rig it was noted that an integral mould was unacceptable for use with dynamic compaction. In a traditional block press the mould is integral with the machine, having its four sides fixed and the top and bottom plates moving to compress the soil. It was not possible to apply this design to dynamic compaction, as the bottom plate would need to withstand the shock forces applied by the falling impactor. Moreover it would be mechanically very difficult to safely organise block ejection upwards toward the temporarily raised impactor. Finally the benefits of impact would be undermined by having to exert large forces to eject the newly formed block.

A different design of mould was therefore developed to enable compaction to occur onto a flat solid surface and the block removed from the side of the mould rather than from its top or bottom. This design involved breaking the perimeter wall of steel into two parts locked together through some mechanism. Figure 6.2 below illustrates the idea via a plan view of the mould showing the locking mechanisms and the two parts of the mould that come together. Figure 6.3 is a photograph of one half of the finished mould as used in the Test Rig.

Figure 6.3 – Plan view of the two-part mould design

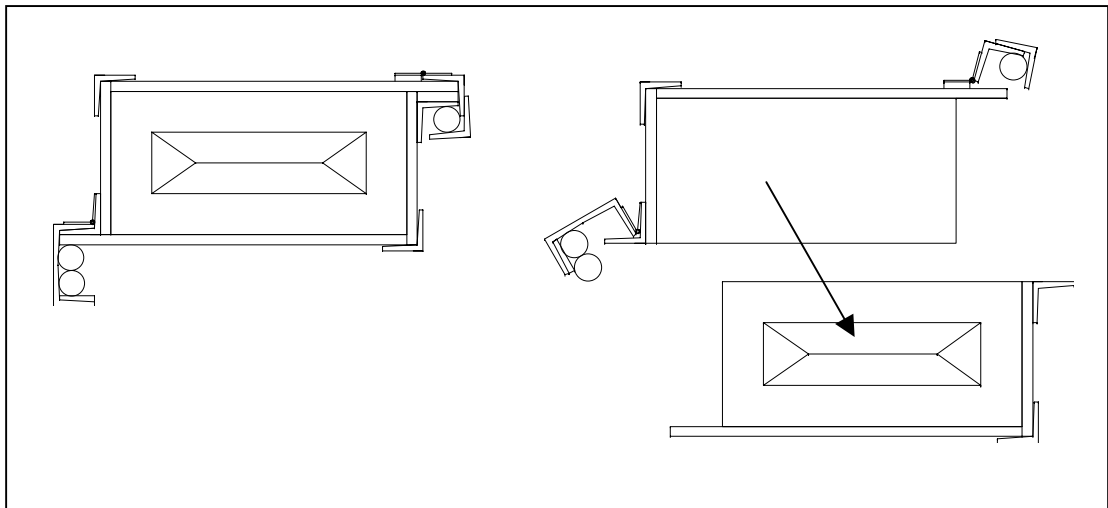
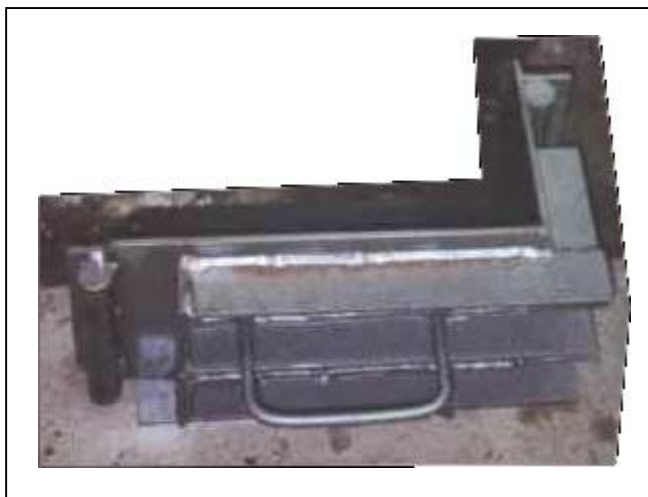

Figure 6.4 – Photograph of the finished front half of the mould



This two-part mould was a novel approach to block ejection and presented some new problems. Overcoming the adhesive forces between the moist compacted soil and the smooth steel mould walls was an exercise that required gentle persuasion. Blocks could only be successfully ejected from the mould by using a slow steady force: impact or jerking action resulted in the block becoming cracked and unsuitable. Furthermore the drag experienced by the block along the sides of the mould would often mar the corner edges upon ejection.

We have established that the initial mould design is adequate for dynamic compaction. There may be problems with fatigue that may need to be addressed during long term testing, but that is outside the scope of this work. The main issue with mould design used in the Test Rig that still needs to be addressed is a better system of block ejection. We know the magnitude of the forces involved in block ejection from our earlier experiments using cylindrical moulds. The ejection forces measured can be converted into the force per unit area of material in contact with the mould. The highest ejection force recorded during these tests, (1.5kN acting on a surface area of 0.0078m<sup>2</sup>), equates to an ejection force per unit area of 200kPa, a value considered excessive.

As viewed from above the Test Rig mould design used two 'L' shaped parts that came together to make the rectangular section required for the block, but block edges were getting damaged too easily during ejection. The proposed design for the Production Prototype has one 'C' shaped part of the mould fixed to the bed of the machine and a flat front with an attached base that can be drawn out of the machine from the front

with the block on top of it. The figure below shows a cross-section through the mould illustrating the proposed method of block removal.

Figure 6.5 – Proposed mould design for improved block removal shown in end elevation

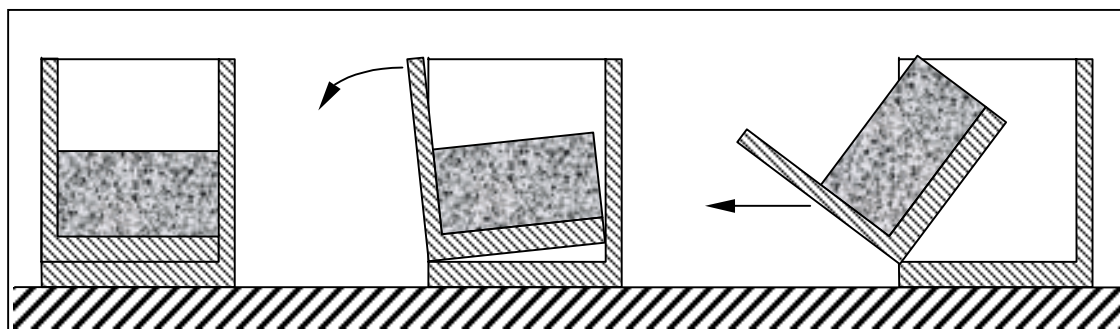

The advantage with this method is that a peeling action is used to remove the block from the back face of the mould as the front part is rotated slightly. Then this is followed by a pulling action to draw the block and front/base out of the rest of the mould. This way the majority of the block is supported by the base throughout the ejection process and should therefore reduce the damage caused to the corners. In order to design this mould we need to know the resistive forces that need to be overcome during the block ejection.

Unfortunately assessing the forces applied to this design of mould is not straightforward. The ejection force necessary for block removal needs to be split into two separate parts. Firstly the adhesion of the soil block to the mould walls usually dependent on the clay content, moisture content and smoothness of the mould walls. And secondly, the frictional shear force between the soil block and mould walls, where the frictional shear force depends on the normal force applied onto the surface.

In quasi-static compaction a large fraction of the force exerted to the top is felt on the sides of the mould. Some of this lateral force remains after the force from the top is removed as elastic strain in the mould. This elastic strain exerts a normal force that generates a high frictional shear force between the block and the mould walls. The process of splitting the mould into two parts releases any elastic strain in the mould and therefore reduces the normal force to almost zero. The remaining force that still needs to be applied is to overcome the adhesion between the compacted material and the mould walls. This adhesive force is most easily overcome through a peeling action rather than a shear or direct pulling action.

Experiments were conducted at different scales to assess the maximum ejection force required to eject a compacted block with density around  $2000\text{kg/m}^3$ . During these experiments the peak force was recorded as the quasi-static ejection force was applied to the compressed block. This peak force drops off rapidly once the block begins to move within the mould walls (i.e. the adhesive force has been overcome). In the Brepak operation manual (Webb & Lockwood, 1987) one is instructed to “jerk” the block ejection lever downwards to free the block from the side walls, to overcome the adhesive forces perhaps. The data in the table below summarises the recorded ejection forces for the different compression machines used and from the mould wall area calculates the shear friction stress in each occasion.

Table 6.2 – Shear friction stress summary for different compression machines

Compaction device	Mould wall area	Ejection force	Shear friction stress
400kN press	$0.0774\text{m}^2$	15kN	195kPa
Brepak (400kN)	$0.0774\text{m}^2$	(2kN)‡	(25kPa)
100kN press	$0.0023\text{m}^2$	1.1kN	480kPa

‡ - Estimated force applied to block after “jerk” operation



If the same jerk action is used with the design of mould described in Figure 6.4 then the adhesive forces can be overcome and the remainder of the ejection force required will be coming from the ends of the block that are wiping past the ends of the mould. Assuming that the frictional shear stress is the lower 25kPa (despite the open mould) this would result in a maximum ejection force of 625N. Such a force can be applied with a short lever inserted between the front handle and the front of the mould. To ensure that the base of the mould can withstand the hinge moment of the force distributed across the base plate, it has been increased in thickness to 10mm.

#### **6.4 *Prototype model exploration and design selection***

Six different models were made using Lego<sup>®</sup> over the duration of the project. Lego<sup>®</sup> is not the ideal modelling medium, but it did assist greatly in the development of several concepts that were adopted in the final machine design. The models were generally created to explore specific design questions raised. The following paragraphs describe the different versions of the models created and explain why different features were either included or rejected in the final design. Table 6.2 below summarises those features.

Mark I – This model was produced in response to the need for a machine design for the work conducted by Montgomery in 1997. It incorporated a flywheel driven rotary actuator that lifted a lever arm with the impactor attached to it. The rotary actuator lifted the arm upwards raising the impactor until the rotary actuator moved out of the

way of the lever arm causing it to fall back onto the surface of the block. A parallel linkage ensured that the impactor was constrained to fall in a vertical plane and directly into the mould. The design was rejected because of the problems in mould and impactor alignment, flywheel and rotary actuator complexity, overall machine size and cost.

Mark II – This design was based on the crank slider mechanism, or inverted piston arrangement. A crank arm at the top of the machine rotated with the assistance of two flywheels. The connecting rod between the crank and the impactor (piston) had an elongated slot on the impactor end to accommodate the different block heights during compaction. The design employed a series of roller bearing guides to constrain the impactor to fall into the mould. Whilst this design was compact and relatively simple, it was top heavy from the flywheels and the roller bearing added unacceptably high levels of complexity and cost.

Mark III – Marks I & II did not include any satisfactory method for mould filling or block ejection. These were not trivial issues and the modelling process identified some problem areas that needed to be considered. The design used in Mark III used a rope and pulley system to lift the impactor that was constrained by running along vertical bars connected to the machine. Two extra features of the design were the inclusion of a mould filling system using side access and the lifting of the mould to eject the finished block. Experience had suggested that the static impactor provided insufficient force to successfully de-mould a compacted block, so a locking mechanism to keep the impactor stationary relative to the moving mould still needed to be added. The letterbox-style single-sided access point for mould filling was a nice idea but involved

several moving parts in areas of high soil contamination and would have therefore been difficult to manage successfully.

Mark IV – This design adapted Mark III to include a lever mechanism to lift the impactor and a further mechanism to assist the lifting of the mould whilst keeping the impactor position fixed to eject the block. Mould filling was now accomplished by a dual hopper system filling the mould via larger side chutes. Overall this was an attractive system but the complexity of having the impactor guided within another guide (for the mould) was deemed too complex and awkward to use.

Mark V – The real breakthrough with this design was the incorporation of a two-part mould that could be opened from the side permitting the finished block to be removed from the front of the machine. The novel mould design was used with a single point pulley lifting system for the impactor constrained between vertical guides. A single point chute mould filling system was included to improve access to the machine front and to reduce complexity. A safety mechanism was also included in the mould design so that when the mould was open the impactor could not fall into the open mould space. The only complex component of the design was now the mould and this was seen to be a tolerable compromise.

Mark VI – This last design attempted to incorporate into the Mark V design a degree of automation in the lifting and dropping mechanism. The mould design was also slightly modified to make it easier to operate. Instead of an overhead pulley system a more elaborate system of levers and guides similar to those used in Mark I were included. The design was to be a manually assisted counterweighted lever that was

lifted upwards with the impactor until a certain point where the impactor would slide off the lever and drop into the mould. The lever could then be pulled back down and re-engage it with the impactor for another lift cycle. The system also included an upper locking off point so that the impactor could be securely placed prior to mould opening.

After the conceptual modelling of the different design ideas, more detailed design could commence. The Lego<sup>®</sup> models indicated where problems might be encountered and these would need to be addressed in the detailed design. Between the production of two block making test-rigs and the Lego<sup>®</sup> models it was hoped that the final selected solution would be an acceptable design for dissemination.

Table 6.3 – Summary of features of different prototype models

<b>Mark</b>	<b>I</b>	<b>II</b>	<b>III</b>	<b>IV</b>	<b>V</b>	<b>VI</b>
<b>Lifting Mechanism</b>	Rotary actuator	Lifting crank	Rope & pulley	Lever, rope & pulley	Rope & pulley	Counter-weighted lever
<b>Dropping Mechanism</b>	Rotary actuator	Falling crank	Rope release	Lever release	Rope release	Rotary actuator
<b>Impactor Constraint</b>	Parallel link	Roller bearings	Linear bearings	Sliding	Sliding	Sliding
<b>Soil Filling</b>	N/A	N/A	Side slot	Double side chute	Single side chute	Single side chute
<b>Mould Design</b>	Straight sided	Straight sided	Straight sided	Straight sided	Two Part	Two Part
<b>De-mould Mechanism</b>	N/A	N/A	Egg laying	Lift mould	Open mould	Open mould
<b>Basis of Test Rig</b>				✓	✓	
<b>Basis of Production Prototype</b>					✓	

The final design that was selected was Mark V with the additional modifications made to the mould as detailed in the previous section. Mark VI was considered to be too

complex for dissemination at this stage in the design development. Its features could be incorporated at a later date if desired or deemed necessary.

The final Lego<sup>®</sup> design attempted to incorporate everything necessary for machine operation in one complete unit. However, in the interests of simplicity only the dynamic mechanism and mould have been incorporated in the Production Prototype. This is the minimum necessary to produce blocks and is detailed in the following paragraphs and diagrams. The other features necessary for machine operation can be determined locally, e.g. the lifting mechanism for the impactor. This leaves the machine design open to interpretation, adaptation and improvisation, which is more appropriate for a developing country.

The configuration used in the Lego<sup>®</sup> model Mark V was adapted to make the Test Rig. Since this design has proved to be successful, the design proposed for Production Prototype is very similar. Modifications were made to the impactor constraint and the mould as a result of the tests conducted on the rig. Minor modifications were also made to the soil loader as it was too small to contain enough soil to make a complete block with a single charge. The impactor guide was also extended upwards to permit greater travel of the impactor, and to provide greater support when the impactor was raised to permit mould filling.

Other details of the design, such as the impactor guide support, are not essential to the functioning of the machine but are advisable additions to the design. Another feature that had been included in the machine design is the safety mechanism within the mould. Whilst the machine will perform adequately without this, its addition makes

the machine much safer to use. The pictures of the CAD models shown in the following figures illustrate the different features of the final design.

Figure 6.6a – CAD model of the mould

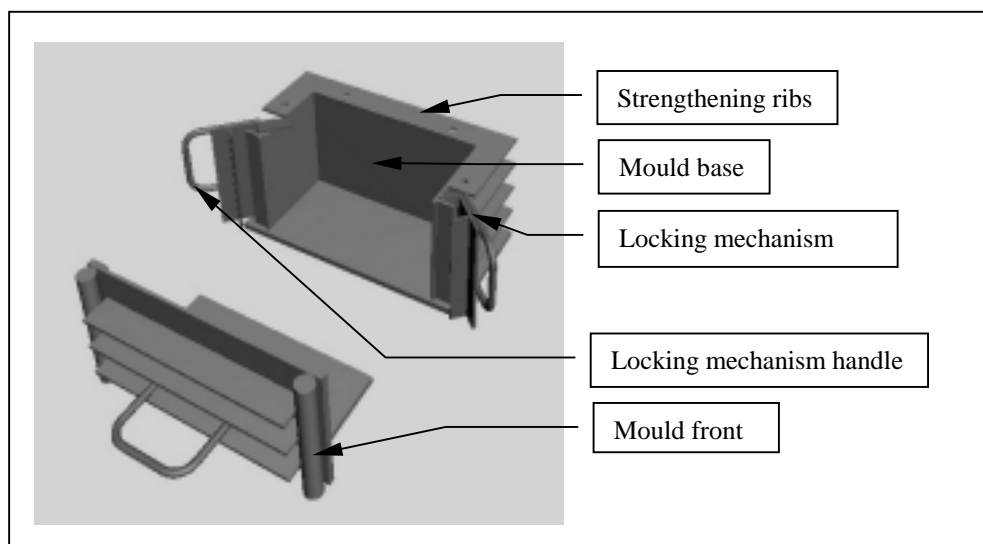

Figure 6.6b – CAD model of the final design

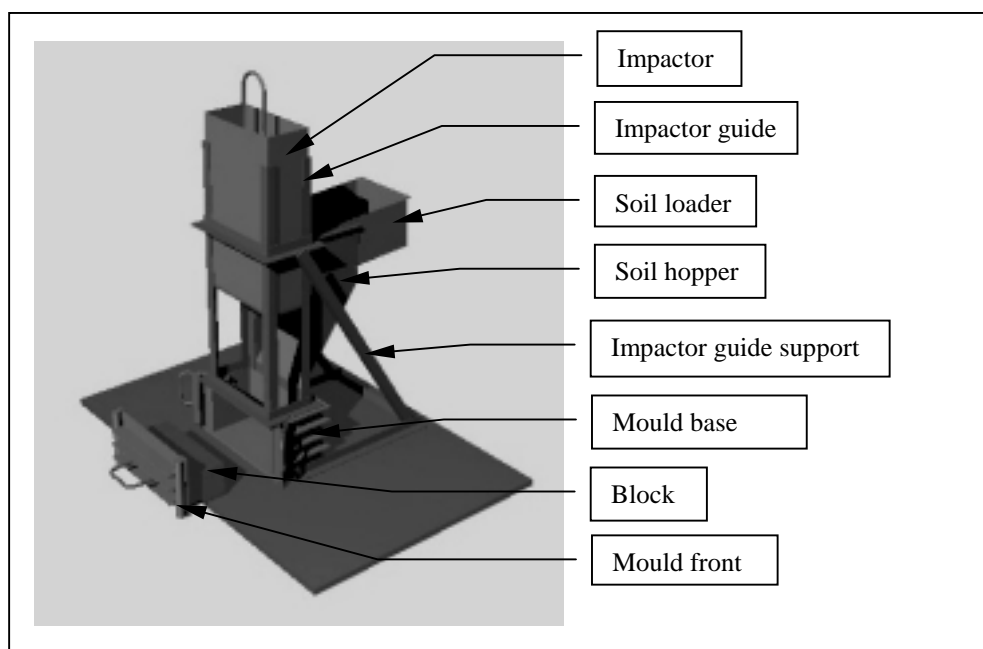
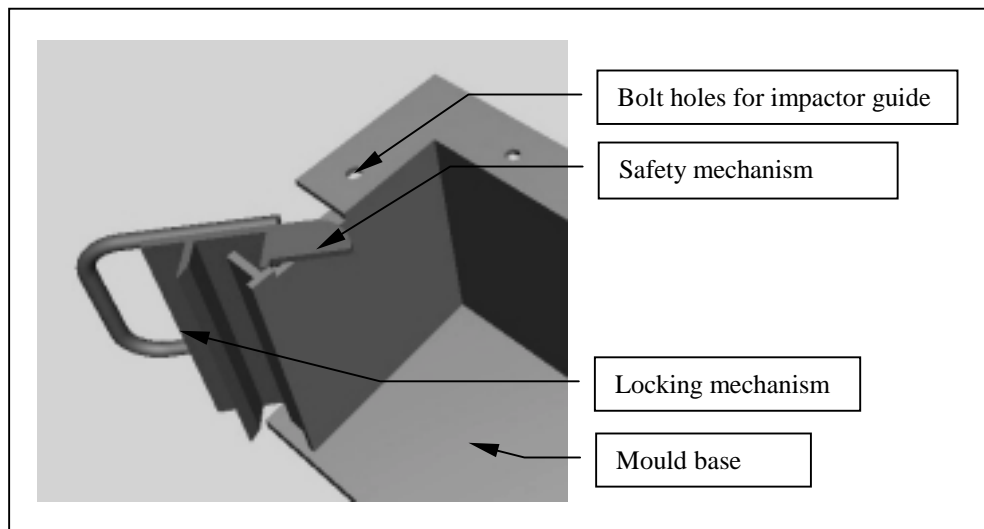

Figure 6.6c – CAD model of the mould safety mechanism



A complete set of drawings was generated from this model clearly showing the different parts of the machine. Scaled versions of these drawings can be found in Appendix D. The dimensional accuracy required for the design was limited to  $\pm 0.5\text{mm}$ . The use of the CAD modelling package has helped identify many of the problems in the dimensional accuracy of the design. The different parts are separately modeled and then assembled. The assembly process immediately highlights any problems in the model. This is a very useful tool and gives us greater confidence that the final design will perform as we expect.

### **6.5 Production guidelines**

In the interests of completeness we will now present a brief set of Instructions for Machine Use (for block manufacture). This will help us to also confirm that all major

components of the machine are suitably designed and will also be useful for the field testing process described in the following chapter.

### **6.5.1 Machine foundation selection**

The process of dynamic compaction has always required a firm foundation onto which the impact blows can be delivered. It was not known how significant the stiffness of the foundations was until tests were carried out on full-size blocks. Apart from reducing the potential consolidation achieved by each blow, an elastic foundation can also have the detrimental effect of increasing likelihood of material de-lamination, and a more elastic foundation will reflect higher energy shock waves.

The calculated flexural rigidity ( $EI$ ) (per meter width) of the strong floor used for dynamic compaction experiments was  $272\text{MNm}^2$ . A less firm foundation was also created by suspending a 20mm metal plate above the strong floor. This metal plate had a calculated flexural rigidity (per meter width) of  $0.133\text{MNm}^2$ . Those blocks produced on the softer foundation were about 10% less dense than those compacted on the strong floor. This is a modest difference in terms of density resulting from a 2000-fold decrease in the flexural rigidity of the foundations. This suggests that the achieved block density is quite insensitive to changes in the foundation flexural rigidity, which is good.

A more noticeable and damaging side effect observed when using the more elastic foundation is that de-lamination of the block is more common. This leads us to suggest that compaction should take place on the most solid and firm foundations



available. This may involve the production of a suitable foundation where the machine is set up incurring greater expense, but helping to ensure a better quality block free from any compaction defects.

### **6.5.2 Block production instructions**

These instructions assume that acceptable procedures are already being used for soil preparation and block curing. They list in order the actions that need to be carried out during block production.

1. Lift impactor to locking height, insert bar between the impactor bottom and the upper cross member of the impactor guide, lower impactor onto the bar and ensure it is held safely in position
2. Open and check mould, clear it of any debris and close it again, ensuring the locking mechanism is functioning properly
3. Add the measured quantity of soil to the soil loader
4. Rotate the soil-loader so that the contents fall down the soil hopper and into the mould
5. Lift the impactor slightly and remove the bar
6. Gently lower the impactor onto the surface of the soil
7. Lift the impactor to the desired height, (this can be done visually using points marked on the impactor guide), and drop the impactor onto the surface of the soil
8. Confirm that the impactor did not hit the edge of the mould by listening for the sound of metal hitting metal
9. Continue to apply the required number of blows

10. Lift impactor to locking height, insert bar between the impactor bottom and the upper cross member of the impactor guide, lower impactor onto the bar and ensure it is held safely in position
11. Open mould by releasing the two locking mechanisms
12. Using the 'rotate and pull motion' draw the block out of the mould
13. Lift the finished block from away from the front part of the mould
14. Place the block in the curing area
15. Clear the mould of any loose soil and close the mould
16. Repeat items 3 to 15 to make another block
17. An indentation test should be conducted on a number of blocks in each batch to confirm adequate consolidation is occurring
18. Density measurements should also be made frequently as a part of the production feedback

We now have sufficient information and detailed design to share with a collaborator and to begin the process of design dissemination and field trials. The next chapter deals with this next exciting phase of the project.

## **7 Technological dissemination and field trials**

Having established the potential of dynamic compaction theoretically and experimentally we need to conduct field trials of the process in a more representative environment. We wish to assess the Production Prototype for suitability for manufacture in a representative workshop, to test it for short term durability, productivity and ergonomic acceptability, to make any necessary design refinements and to assess the characteristics of produced blocks. The nature and scope of this work cannot be carried out in the UK so an overseas partner was needed to help provide the necessary facilities and environment for field trials to be conducted. In order to improve the readability of this chapter, the first person will be used to distinguish between work carried out by the author and the collaborators.

### ***7.1 Overseas collaboration***

Potential partners were identified in Botswana, Ethiopia, India and Tanzania who were all interested in the technology and were prepared to assist in some way. However, it was decided that the Indian partner had the best mix of facilities, expertise and local connections for machine production, development, testing and dissemination. We were extremely fortunate to find a collaborator with strengths in all these areas and who was also willing to collaborate with us without any additional financial assistance.

Our collaborator was Development Alternatives (DA) which is based in India with its head offices located in Delhi. It was established in 1983 as a non-profit corporate organisation and to date has been involved in a number of different areas of sustainable development. It has worked on the application of several technologies in the fields of :

- Construction: Compressed Earth Block, Ferro-cement roof channel, Micro-cement roof tile
- Textiles and paper: Manually driven “powerloom”, Recycled hand-made paper production
- Energy: Biogas electricity generation plants, charcoal briquette production machines
- Water: Portable water testing kits, check-dam construction

The main ethos of DA is to identify locally sustainable practices that generate income and to encourage collaboration between entrepreneurs and local communities in the deployment of these practices. DA has had many successful projects in different regions of India and is always interested to hear of a new technology that may be suitable for sustainable development. When we expressed our wish to collaborate with them in the development of a new type of block machine they were interested enough to accept the challenge and meet the primary practical needs of the project. We were reasonably convinced that the team at DA could manufacture our machine (called ‘Block Impacterre’) and also provide very useful development suggestions from their experience in block machine manufacture. Their connections with other organisations and knowledge of possible sites for building trials would also be very useful for further technological dissemination.

A 4-week visit was set up and suitable funding for the project was obtained. Engineering drawings of the machine were sent out about 4 weeks before the scheduled visit. Two copies of the machine plans were sent under separate cover by mail to DA. The arrival of the plans was confirmed and further communication was done through e-mail.

## **7.2 *Experience with machine***

Upon arrival in India contact with DA headquarters was made and from there I went to the workshop where the machine was being produced. I had anticipated that further machine production would be necessary, but it was with great surprise and delight that I found the machine was ready for assembly and testing. This section will summarise some of the machine modifications and block production issues faced during the testing.

The machine was fully built but some of the finer details had been omitted. These were not a major problem, but would need attention eventually. The impactor for example had not been filled with concrete, but with sand. This proved to be a poor solution and the sand was replaced eventually by concrete. The machine foundation was a large metal plate about 20mm thick that unfortunately had protrusions on the underside causing the machine to bounce during each blow. This produced a foundation similar to the soft foundations that were experimented on in the UK. The dimensional tolerance of the machine construction was generally within the  $\pm 0.5\text{mm}$  that was recommended. However, the design of the impactor guide was not

completely understood and consequently the mould dimensions were very slightly smaller than the internal impactor guide dimensions. This resulted in the impactor hitting the side of the mould on its descent, thereby slightly damaging the mould and causing less energy to be delivered into the block.

Another issue that was immediately brought to our attention was the problem with de-moulding. This was a design fault rather than a manufacturing problem. It was quickly apparent that the proposed de-moulding procedure of the “rotating and pulling” the front of the mould was not going to work successfully. It seemed that the adhesive force between the block and the walls of the mould was higher than anticipated. Several blocks were made and great difficulty was experienced in removing them from the mould, furthermore most had major defects. The proposed solution was to redesign the mould to include a slight taper to assist block ejection. A further proposal was to install a plate mounted on linear bearings on the back face of the mould to push the finished block out the mould rather than try pulling it out. These suggestions were based on the team’s understanding of other block making machines that they had worked on.

The diagram in the figure below shows a plan view of the modified mould design illustrating the concept of using the taper in the mould to release the adhesive forces between the block and the mould walls. Once the bond is broken then the block can be pulled out from the front of the mould with ease.

Figure 7.1 – Tapered mould design with ejection mechanism (plan view)

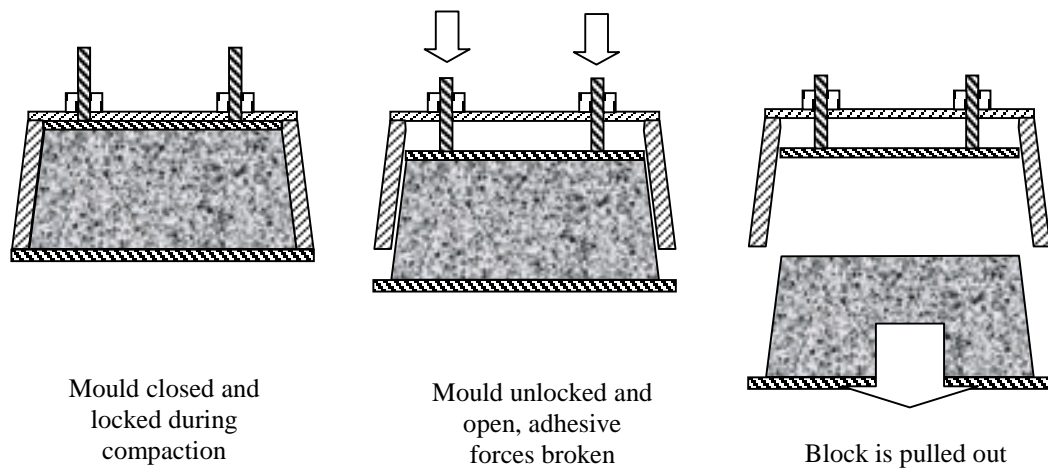

The original sand-filled impactor was not weighed, but with the single overhead pulley and rope arrangement three people were needed to lift it. Two people could not exert the necessary force to lift the impactor for a sustained period and so a third person was introduced to help. A bar was attached to the end of the rope to give each operator something to grasp and to ensure that the three operators were operating in unison. The figure shown below illustrates this lifting mechanism and the adapted lever system described below.

Figure 7.2 – Modified lifting mechanism for the impactor

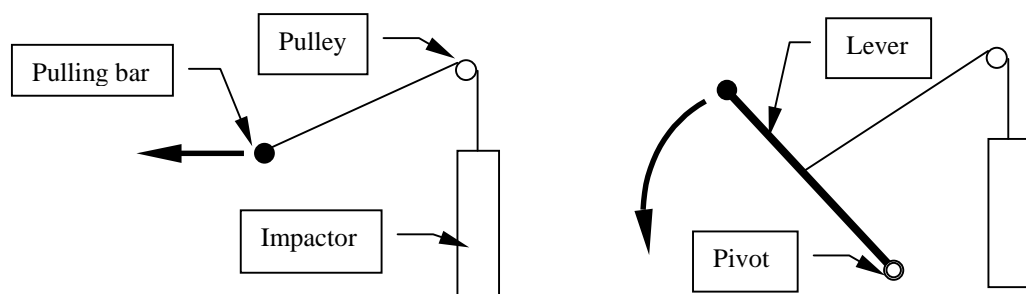

This lifting system was later modified to include a lever that provides a 2:1 lever ratio and reduced the necessary force so that only two operators were necessary. The

concrete impactor mass when it had been cast was approximately 66kg. This could still be lifted and dropped using the rope pulley and lever system by two operators.

Generally the concept of dynamic compaction was well received. Our collaborators hoped that the main advantage of this method of compaction would be the improved surface finish of the block. This was one of the major problems with CSSB and initial trials indicated that dynamic compaction offered a superior block finish compared with other block presses. The team was also impressed with the level of compaction achieved by the machine and was hopeful of its potential.

### ***7.3 Machine assessment and block analysis***

Once the modifications were made to the machine, block manufacture and testing could be conducted. The main aim of the block manufacture was to test the block characteristics and to compare these with the characteristics achieved by other available block machines. Two other machines were at the DA workshop that could be used to manufacture CSSB, one was a diesel-driven hydraulic press and the other a manual lever-operated press.

#### **7.3.1 The testing procedure**

In order to make a meaningful analysis of the blocks produced by the different machines, they all need to be made in similar ways and analysed using the same tests. A suitable sample of soil was available on site and this was used to make all of the blocks, we will call it soil-I. A particle size distribution analysis was carried out on



soil-I and the results can be found in the Appendix A. A constant quantity of cement (5% by weight) was mixed into each of the batches of soil. During testing the same quantity of water was added to the mix each time, however moisture content analysis indicated a slight difference in the moisture content for each batch of material. The blocks were produced on the three machines using their best machine settings. The pressure applied using the manual machine (Balram or BAL) and the hydraulic machine (Hydraform or HYD) could not be modified, however the level of compaction delivered by the dynamic compaction machine (Block Impacterre or BI) depends on the number of blows applied and the impactor drop height. These two variables were kept as constant as possible during the tests. The blow number did not vary by more than  $\pm 1$  blow and the impactor drop height unfortunately varied between 350-450mm.

Once the blocks were manufactured they were then carefully weighed to  $\pm 25$ g and measured to calculate their volumes. An indentation tester similar to the one used in the UK had been made in India and this was used on the surfaces of the blocks to determine the uniformity of the blocks. It was also used to gain the necessary data to calibrate the indentation tester from the compressive strength of the blocks. The finished blocks were then cured under plastic for 6 days during which they were sprinkled with water regularly. At the end of day 6, half of the blocks were put underwater, while the other half were placed in an oven for 24 hours at 105°C. At the end of their time in the oven or under water, they were then re-weighed and re-measured to calculate their respective wet and dry densities. All the blocks then had the indentation test repeated on them before they were crushed in a compression

machine, noting the maximum load before failure. The results of these tests can be found in Appendix H.

It was not possible to conduct all of the desired testing during the 4-week visit. Consequently, during the testing procedure a member of the team from DA observed the testing and carried out some of the tests personally. That way future tests should be conducted in similar manner and with similar levels of accuracy. The data from these tests were then sent back to the UK for further analysis and inclusion into the thesis report. This data can also be found in Appendix H.

### **7.3.2 Initial machine comparison**

We now wish to compare the output of the three different machines and draw some initial conclusions. The most obvious criterion for block comparison is the wet compressive strength (W.C.S.). We believe that density is a good surrogate for strength and the indentation tester also indicates possible strength of the material, but initially these methods were not calibrated for the soil and the conditions, so we must only use the W.C.S. measure.

The results of the wet and dry compression tests and the density calculations for the bulk (freshly ejected), dry (oven dried) and wet (soaked) density of the blocks from the three machines can be seen in the figure below.

Figure 7.3 – Initial results for comparing block machines

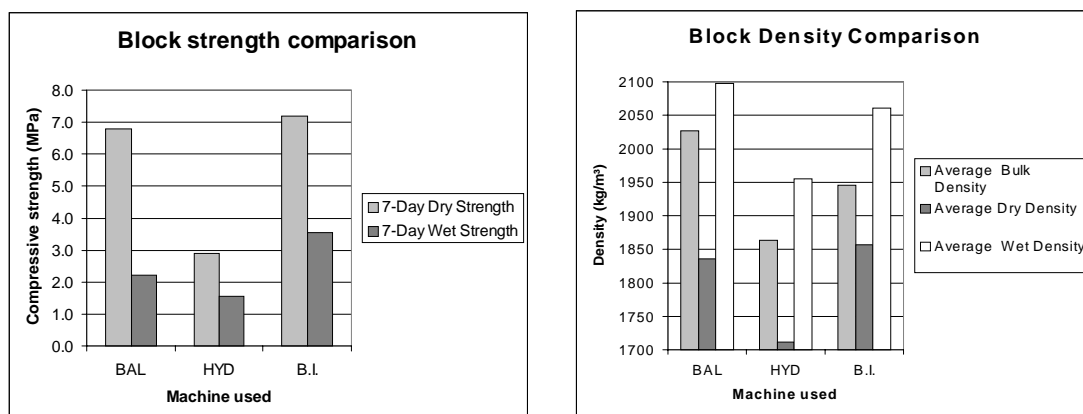

Although these are only the initial test results it can be seen that the BI blocks have performed significantly better than both the BAL and HYD blocks. Part of the reason for the difference is the different moisture contents used in the different machines. Testing of the soil after mixing indicated that the average M.C. for BAL was 12%, HYD was 10% and BI was 8%. The M.C. for BI was lower than desired and we would have expected even better block characteristics with higher water content.

The team at DA estimated that the cost of building Block Impacterre would be similar to the Balram (£500) as it contains similar quantities of material and has similar machining complexity. The block production rates for the BI was estimated to be between 60-100 blocks per hour. Unfortunately the block performance results do not provide conclusive evidence, as there were unavoidable differences in the production using the different machines. Furthermore, we do not know the inherent variability of the production methods used so it is difficult to conduct statistical analysis on these results.

### 7.3.3 Further block production and testing

After returning to the UK more blocks were produced using the *Block Impacterre* and the *Hydraform* machines in India. Unfortunately the block production and analysis regime was not exactly the same as the initial tests and consequently cross comparison will not be possible. However the larger numbers of block produced do provide a much better data set for statistical analysis. A new mixture of raw material containing soil-I (65 or 63%) and sand (30%) was used during the block production instead of the 95% soil-I used initially. Cement content was either 5% or 7% by mass and the optimum moisture content for *density* was established for both machines experimentally (shown in the figure below). DA further modified the BI machine to include an impactor stop to ensure a constant drop position for each blow.

Figure 7.4 – OMC analysis of two machines

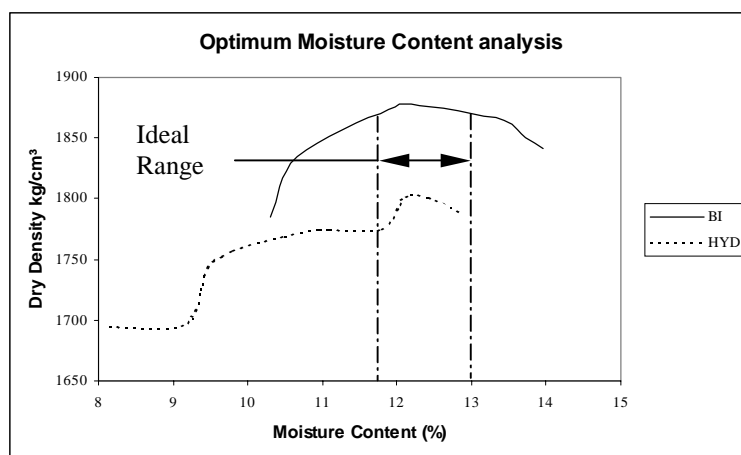

Unfortunately the data received from the blocks made during these tests was not recorded in a way that identified individual blocks adequately. Many blocks had their density calculated and the indentation test conducted on them and several of these were crushed, but there is no obvious way of determining what density the crushed

blocks had. Consequently the density and indention tests will have to be analysed in isolation from the W.C.S. results. Further confirmation of the indention test performance and the density/strength relationship would have been beneficial, but this is not possible with the data received.

The data in the following two tables summarise the results of block production using Block Impacterre and Hydraform. For each machine two groups of blocks were made, Group A (batches 1-4) had 5% cement, Group B (batches 5-8) had 7% cement. The data shows the average P.D.D. and the average indention diameter ( $\phi$ ) for each cement content used. The variation in the moisture content observed during different batch production has also been included for completeness and to check the reliability of the production method. Statistical analysis has been conducted on the data to determine the significance of changing the cement content on the P.D.D. and  $\phi$ .

**Table 7.1 – Density and indention results of Block Impacterre blocks**

Group (10/batch)	Cement Content	M.C.		P.D.D. (kg/m <sup>3</sup> )		Indention $\phi$ (mm)	
		Average	C. of V.	Average	C. of V.	Average	C. of V.
A (1-4)	5.0%	10.85%	4.32%	1890	1.92%	17.4	11.46%
B (5-8)	7.0%	10.36%	1.97%	1863	2.04%	18.3	13.23%

Statistical analysis						
Comparing	Standard Deviation of pop'n	Standard Error of means	Standard Error Difference	Difference Of Means	DOM/SED	Significance Normal Distribution
M.C.	0.0047	0.0023	0.0026	0.0048	1.90	94.26%
	0.0020	0.0010				
P.D.D.	36	6	8.31	27.43	3.30	99.90%
	38	6				
Indention	2.0	0.3	0.50	0.92	1.86	93.72%
	2.4	0.4				

The analysis shows that for Block Impacterre blocks there is an almost 95% probability that the ranges of moisture contents used for the two groups are not from

the same population, indicating a change in production method. This helps to account for the 99.9% probability that the P.D.D. achieved are not from the same data set either, (i.e. they are *statistically* significantly different). This is because even a small variation in the moisture content can change the P.D.D. by a noticeable amount. However, the results do not indicate that there is a commercially significant difference in the sets of blocks produced as their P.D.D. are within  $\pm 1\%$  of each other.

**Table 7.2 – Density and indentation results of Hydraform blocks**

Group (10/batch)	Cement Content	M.C.		P.D.D. (kg/m <sup>3</sup> )		Indentation $\phi$ (mm)	
		Average	C. of V.	Average	C. of V.	Average	C. of V.
A (1-4)	5.0%	10.99%	6.09%	1769	2.47%	18.4	9.25%
B (5-8)	7.0%	11.18%	2.76%	1764	0.56%	18.7	5.63%

Statistical analysis						
Comparing	Standard Deviation of pop'n	Standard Error of means	Standard Error Difference	Difference Of Means	DOM/SED	Significance Normal Distribution
M.C.	0.0067	0.0033	0.0037	0.0019	0.52	39.70%
	0.0031	0.0015				
P.D.D.	44	7	7.09	4.63	0.65	48.44%
	10	2				
Indentation	1.7	0.3	0.32	0.27	0.86	61.02%
	1.1	0.2				

By contrast, in the case of Hydraform blocks, the data shows that there is no statistically significant difference between the two groups in the moisture content used. Having established that the production method is not significantly different we can assess the difference in the P.D.D. and  $\phi$ . The results show that there is no statistically significant difference in the P.D.D. or  $\phi$ . From this we can conclude that the additional cement has not affected these two output measures significantly.

The data presented in the two tables above give us more material for machine comparison. It appears that the P.D.D. achieved by the *Block Impacterre* machine is

higher than the density achieved by the *Hydraform*. This can be confirmed as statistically and practically significant for the 5% cement batches. Unfortunately there is a statistically significant difference between the moisture content used in the two machines for the 7% cement batches that makes further comparison inconclusive. On average the *Block Impacterre* delivers a 6% increase in density above the *Hydraform* machine. Such an increase in density will also yield an increase in the compressive strength that is of great practical significance (possibly 60%).

Despite the large variation in the indentation diameters ( $\phi$ ) recorded, there is a statistically significant difference between the results collected from blocks made by each machine. Again, only the 5% cement batches can be analysed. Not only is the difference in  $\phi$  noticeable *statistically*, the difference also displays the correct phenomenon that a denser block yields a smaller value for  $\phi$ . For *Block Impacterre* a P.D.D. of 1890kg/m<sup>3</sup> yields a  $\phi$  of 17.4mm, whilst for *Hydraform* a P.D.D. of 1769kg/m<sup>3</sup> yields a  $\phi$  of 18.4mm. This demonstrates that the indentation tester provides meaningful results, but its sensitivity to changes in P.D.D. is too small for practical application. We would prefer a sensitivity of about 1mm/25kg/m<sup>3</sup> rather than 1mm/120kg/m<sup>3</sup>. This could be achieved by changing the cone angle of the indentation device and/or increasing the weight of the falling mass striking the indentation pin.

We also received results for the strength of the blocks produced by both of the machines. Blocks were crushed in batches of five to determine their 7-day and 28-day W.C.S. for both cement contents used. This data has been summarised in the table below indicating the average W.C.S. for each configuration. In every case the

recorded strength of the Block Impacterre blocks exceeded the Hydraform blocks and the average ratio of BI strength : HYD strength is 1.425. However only three out of the four comparisons (5% cement 7-day, 5% cement 28-day & 7% cement 7-day) show a statistically significant difference. The 7% cement 28-day BI specimens have a number of irregularities. Firstly, the C. of V. is unusually high, 23.8% instead of around 10%. Secondly, the blocks are weaker than the 5% cement specimens; they should be stronger with more cement. Thirdly, their measured density is about 2.5% lower than the 5% cement blocks, a difference that could result in a 25% loss of strength. These factors point to some error in the block production for the batches used to gain the 7% cement 28-day strength data for BI.

**Table 7.3 – Strength analysis of blocks produced by different machines**

Batch (n=5) Soil-I with 30% sand Machine	Cement Content (%)	Curing Period Days	Average W.C.S. MPa	C. of V. (%)	Ratio of W.C.S BI / HYD	Statistically Significant >95%
Block Impacterre	5.0	7	4.6	10.1	1.44	Yes
Hydraform	5.0	7	3.2	6.4		
Block Impacterre	7.0	7	5.6	10.2	1.46	Yes
Hydraform	7.0	7	3.8	2.9		
Block Impacterre	5.0	28	6.4	10.3	1.72	Yes
Hydraform	5.0	28	3.7	1.0		
Block Impacterre	7.0	28	5.8	23.5	1.08	No
Hydraform	7.0	28	5.4	5.8		

Statistical analysis						
Comparing W.C.S.	Standard Deviation	Standard Error	Standard Error Difference	Difference Of Means	DOM/SED	Significance Normal Distribution
5% cement 7-days	0.47	0.21	0.23	1.41	6.13	>99.99%
	0.21	0.09				
7% cement 7-days	0.57	0.25	0.26	1.77	6.85	>99.99%
	0.11	0.05				
5% cement 28-days	0.66	0.30	0.30	2.69	9.09	>99.99%
	0.04	0.02				
7% cement 28-days	1.36	0.61	0.62	0.43	0.69	50.98%
	0.31	0.14				



The strengths recorded here are noticeably higher than those experienced during initial tests using only soil-I, (see graphs in Figure 7.3). It would appear that the addition of sand to the soil significantly improves the strength of the material as it increased the average BI block 7-day strength from 3.6MPa to 4.6MPa and the average HYD block strength from 1.7MPa to 3.2MPa. The inherent variability of the strength ( $\pm 10\%$ ) seems to be consistent with the previous tests so we can presume that the tests have been conducted in a satisfactory manner. It is a shame that the BI blocks inherent variability is so much higher than the Hydraform blocks, but this is probably due to the very different compaction mechanism employed during consolidation. The variability of  $\pm 2\%$  on density and  $\pm 10\%$  on strength is an acceptable range for experimental analysis.

The strengths demonstrated by the BI blocks are all much higher than the original specifications of 2MPa strength after 7-days. If we assess these blocks using the Indian standard for masonry walling (28-day W.C.S. of 3.5MPa) we find that they all comply. Furthermore, all of the BI blocks achieve this strength after only 7 days. The general trend exists that the 28-day W.C.S. is about 25% higher than the 7-day W.C.S. In order to achieve a 3.5MPa strength at 28-day one wishes to achieve at least 2.5MPa at 7-days. Again, all of the blocks above comply with this. Recent work on CSSB durability conducted by (Kerali, 2001) shows that 28-day W.C.S. of 3.5MPa is an acceptable standard to ensure adequate durability. Therefore we can say that these blocks have adequate strength and durability.

#### **7.4 Dissemination overview**

Apart from gaining the practical experience in the field with the technology in a more representative environment, the field trials also gave us more experience in the process of technology dissemination. From an academic perspective this is valuable to us as it helps to provide and promote technology in ways that will be more accessible and appealing to those who will derive most benefit from it.

One of the big problems with technological dissemination is transferring information. This is a problem for both the end user communicating their real needs and desires to the research body and also for the researcher sharing their work with those who would most benefit from their research. During the visit to India there was the opportunity to speak directly with those who were more actively involved in supplying technological solutions to local needs. From these conversations it was found that current CSSB technology was not cost effective and with a poor track record CSSB was considered a second-rate material. Those who can afford to, build used burnt brick rather than CSSB. This poor perception of the material was not obvious from the information available to us at the start of the project. We knew that CSSB didn't perform as well, but we didn't know that it already had a bad name, which would be difficult to overcome.

The technological advancements that were proposed during the project all took a poor material and made it slightly better. There was no major breakthrough in terms of material performance, only cost reduction and material savings were realised. These improvements alone would not be enough to sway people from a tried and trusted less expensive material (burnt brick) to CSSB. A switch seems much more likely if burnt

brick was much scarcer as it is in the region of Bangalore in India. CSSB technology has been much more successful there due to a lack of appropriate alternatives.

Getting people to change their minds about techniques or products requires clever marketing and communication. However, successful marketing tools are not easily applicable to this level of technology and propagated in areas of poor communication. The team at DA suggested that an effective method of getting new technology accepted is to initiate it with a middle-class group rather than with the very poor. Something perhaps initially expensive, but desirable and cutting edge, which is a modest challenge with a low-cost mud brick machine. The Hydraform machine presents a high tech solution at a high price and leaves no possibility of local artisanal replication or even maintenance. However, if the Block Impacterre was initially marketed as a high tech solution that provides the same sort of product as the Hydraform machine but for a much lower price, that would make it more attractive. As the new-technology is accepted by the more prestigious and wealthy it becomes much more desirable to the poor. Now, the low complexity of the Block Impacterre machine leaves the potential for artisanal copying and maintenance if some marketable high-tech features are left out, without greatly compromising the machine performance.

Another issue that was not obvious from the information available in the literature was that environmentalists in India consider the use of soil for building a bad practise. Whilst in the United States earth building has become more acceptable for environmental reasons, in India the use of soil for building reduces the soil that could be cultivated for crops. Instead environmentalists recommend the use of waste

materials such as fly-ash from power stations. This material has been used successfully with the Hydraform machine to make blocks with a compressive strength of 30-40MPa. This impressive product is only hampered by the poor availability of the fly-ash material in areas away from the power stations, and the fact that Indian annual production of fly-ash is only a small fraction of the annual tonnage of walling materials used in the country.

We have demonstrated that the dynamic compaction technique is superior to quasi-static compression both during experiments and field trials. With the information gained from the overseas collaboration there are still outstanding questions about the economic viability of the new technology, its acceptance among the low-cost building market and its environmental implications. For the purposes of this research we are only able to investigate the economic viability of the technology compared with the other machines available. The next chapter analyses machine productivity and block viability.

## **8 Commercialisation and feasibility study of impacted blocks**

We now have details of the characteristics and performance of dynamically compacted blocks and the machine used to make them. We wish to quantitatively compare these with those of a suitable competitor to conduct a feasibility analysis. This chapter is split into three sections. The first investigates the features of the machines used in India to produce CSSB (including the Block Impacterre developed during my research). The second section normalises the material produced by each machine to a suitable standard and compares the requirements of each machine to produce adequate CSSB. The final section summarises these findings and suggests how feasible the dissemination of *Block Impacterre* into the block-making market would be.

### **8.1 Machine analysis and comparison**

We wish to compare the machines used during the production of CSSB using a number of different criteria. Three criteria that are easily assessed for each machine are its respective cost, production rate and energy consumption. A further criterion for assessment is the wet compressive strength of the material that each machine produces with similar raw materials. Our data for this criterion is divided up into the results gained when I was in India, (which included the investigation of three machines) and the comparative analysis of only Block Impacterre and Hydraform conducted by collaborators after I returned to the UK. The Hydraform machine in its various models

is a market leader in several countries. Due to problems with some of this data only the 7-day wet compressive strength has been included in this analysis.

The table below presents the summary of the different criteria for machine comparison. Some of the values presented have been estimated in good faith using the experience of the collaborator. Several values for the 7-day wet compressive strength have been presented. These highlight the difference between the machines when sand is added to the soil mix for CSSB production and also the improvement obtained.

Table 8.1 – Machine comparison

Machine name	Balram	Hydraform	Block Impacterre
Origin	India	South Africa	Warwick University
Machine cost (2001) £1 = Rs 70	Rs 36,000 £510	Rs 200,000 £2860	(Rs 35,000) (£500)
Production rate Blocks/hr	120-180	50-100	(60-100)
Energy consumption per block	0.75kJ	180kJ	3.7kJ
Average 7-day W.C.S with 5% cement, 95% soil (3 samples)	2.2MPa	1.6MPa	3.6MPa
Average 7-day W.C.S with 5% cement, 65% soil, 30% sand (5 samples)	N/A	3.2MPa	4.6MPa
Average 7-day W.C.S with 7% cement, 63% soil, 30% sand (5 samples)	N/A	3.8MPa	5.6MPa

Figures in parenthesis are projected

*Block Impacterre* performs adequately in terms of production rate and energy consumption, and delivers better results on W.C.S. due to increased material consolidation. *Hydraform* has an excessive energy requirement because of the diesel engine used to power the hydraulic press, something that neither *Balram* nor *Block Impacterre* suffer from being manually operated machines. The assessment indicates

that on the combined basis of machine cost, production rate and W.C.S. the Block Impacterre machine is the best performer.

A comparison of different machines was presented in Chapter 2 and identified the target area of a lower-cost machine with a lower cement demand. By applying the data from Chapter 7 and making certain assumptions, we can recreate that comparison for the three machines used in India. We have attempted to normalise the CSSB block performance from each machine by adjusting the cement content. The initial test using only soil and 5% cement indicated that 5% cement was sufficient for *Block Impacterre* to achieve 3.5MPa. But both *Hydraform* and *Balram* required a boost in cement to comply with this standard. Consequently we have selected a cement content of 7% for these two machines. From these figures and the block densities that each machine produces we can calculate the cement requirement per cubic meter of walling material using only soil and cement.

The graph below presents this data for the three machines. Whilst *Block Impacterre* does not achieve the target (<100kg cement per m<sup>3</sup> and < £400 per machine) originally suggested, it is the closest machine to it by a fair margin. Furthermore, a 20% reduction in the cost of *Block Impacterre* would bring the machine into the target area. *Balram* requires a significant reduction in its cement demand as well as a similar reduction in machine cost. *Hydraform* is too far away from the target area to be a possible contender.

Figure 8.1 – Re assessment of CSSB machines using recent data

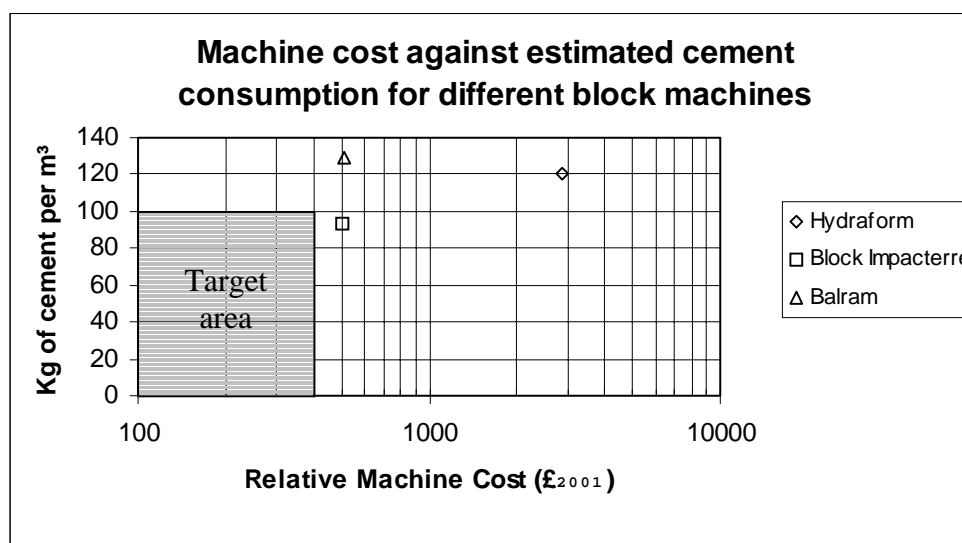

## 8.2 Material analysis for performance

It has been necessary to use material performance as a criterion for machine comparison. We now wish to assess the material produced by these CSSB machines to see their potential for meeting the needs of low-cost building materials in tropical regions. The building regulations in India require a minimum 28-day wet compressive strength of 3.5MPa for all masonry walling. (Kerali, 2001) recommends a similar figure for durable CSSB walling blocks. We will adopt this as the comparative strength of the materials produced by different machines instead of the 2MPa chosen for the analysis in Chapter 2.

The graph shown in the figure below projects the 7-day W.C.S. for different cement contents for the Hydraform and Block Impacterre. We know the general relationship between strength and cement content from our experience with CSSB, so we can



approximately predict from the results gained in India the necessary cement content required for either machine to produce CSSB with a 7-day W.C.S. of 3.5MPa. The material used here includes 30% sand, permitting a reduction in the cement content of the CSSB.

Figure 8.2 – Block strength using different machines and cement contents

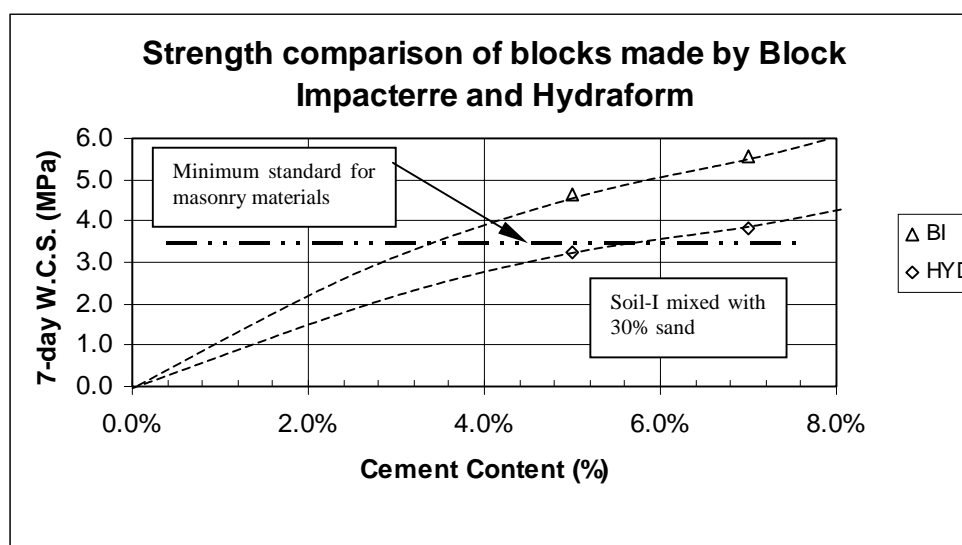

From this graph we can project that a block manufactured from soil-I with 30% sand by *Block Impacterre* requires about 3.5% cement to achieve the desired strength, whilst *Hydraform* needs closer to 5.5%. If sand is not used then the machines require 5% and 7% cement respectively to achieve the same standard. We can now use these figures to conduct an analysis of the CSSB production using these two machines and the different raw materials available.

In Chapter 2 and Chapter 3 a comparison of low-cost building material and CSSB variants was presented. Using a similar strategy and assumptions it is possible to calculate the respective energy consumption and cement requirement for walling made

with these machines and different raw materials. Any requirement for sand in the CSSB production makes on-site production marginally less suitable. The analysis indicates that *Block Impacterre* uses less cement and less energy than *Hydraform* per square meter of walling produced. Furthermore, with *Block Impacterre*, the addition of sand to the soil yields a cement demand of less than the original target of 15kg/m<sup>2</sup>. Even without the sand the analysis indicates that a normal CSSB requires only 17.5kg/m<sup>2</sup> instead of the originally calculated 18.7kg/m<sup>2</sup> in Chapter 3.

Table 8.2 – Comparison of CSSB walling material from different machines

Machine	Dimensions ( <i>l × b × h</i> )	Note	Energy	Cement	Suitability for production	
					'Locally'	On-site
	Mm		MJ/m <sup>2</sup>	kg/m <sup>2</sup>	Ranking (1 = best)	
Block Impacterre (with 30% sand)	290 × 140 × 90	1	309	14.0	2	3
Hydraform (with 30% sand)	215 × 221 × 116	2	529	22.8	3	4
Block Impacterre (without sand)	290 × 140 × 90	3	273	17.5	1	1
Hydraform (without sand)	215 × 221 × 116	4	466	29.0	2	2

Notes

0. All cement is assumed to have been transported 100km, all sand transported 25km and all material has a 7-day W.C.S. of 3.5MPa.
1. High-density (1925kg/m<sup>3</sup>) solid blocks manufactured on-site from local soil mixed with 30% sand and 3.5% cement, laid with 10 mm of soil/cement mortar (20% cement) and no render.
2. Medium-density (1775kg/m<sup>3</sup>) solid blocks manufactured on-site from local soil mixed with 30% sand and 5.5% cement, dry stacked with no external render.
3. High-density (1925kg/m<sup>3</sup>) solid blocks manufactured on-site from local soil mixed with 0% sand and 5% cement, laid with 10 mm of soil/cement mortar (20% cement) and no render.
4. Medium-density (1775kg/m<sup>3</sup>) solid blocks manufactured on-site from local soil mixed with 0% sand and 7% cement, dry stacked with no external render.

### 8.3 Feasibility study

The analysis in the previous two sections have demonstrated that dynamic compaction of CSSB using the *Block Impacterre* provides reasonable reductions in machine and walling cost without compromising the material properties of the finished block. It is possible to financially analyse these machines if we assume their respective working life to be 4 years for 240 days a year. We know the productivity of the machines from earlier analysis and their cement demand for adequate material properties. Taking a cost of cement as £0.05/kg (Rs 3/kg) we can draw up a projected total cost/m<sup>2</sup> of material produced using each machine.

Table 8.3 – Projected costs of walling for machines during lifetime

Machine and material	Cost (£)	Block production	Cost/m <sup>2</sup> (£)
Hydraform (soil)	2860	768000 blocks (1)	1.60
Block Impacterre (soil)	500	461000 blocks (2)	0.91
Hydraform (soil, 30% sand)	2860	768000 blocks (1)	1.29
Block Impacterre (soil, 30% sand)	500	461000 blocks (2)	0.74

(1) Average of 100 blocks per hour for 8 hours a day, 240 days a year for 4 years.

(2) Average of 60 blocks per hour for 8 hours a day, 240 days a year for 4 years

It appears that the *Block Impacterre* delivers a 40% reduction in walling costs compared to the *Hydraform* with or without sand in the blocks. The running cost of the machines and their respective maintenance has not been included in the analysis. Assuming that both machines use the same labour force the *Hydraform* also requires diesel to operate and more complex maintenance than the *Block Impacterre*. These factors would push the running costs of the *Hydraform* up higher. From an economic viewpoint, it appears that the process of dynamic compaction is superior to high-pressure quasi-static compression.

Proving that the process and machine is cost competitive is unfortunately insufficient to claim its future success in the market of low-cost walling. Certainly such significant savings would prompt many to try the new technology and this is most certainly what we hope would happen. However, the relative success of the *Hydraform* machine compared to the *Balram* may indicate that a mechanised machine is looked upon as better investment for entrepreneurs. The *Block Impacterre* was never designed to be part of the high-tech market, but was designed to fit into cottage industry type of environment. The problem with a low-tech and low-cost machine may be the limited resources for marketing, advertising and dissemination that is available for that type of product.

## **9 Conclusions and recommendations**

The research conducted during this Ph.D. has increased our understanding in several areas related to the production of low-cost building materials. This chapter aims to draw together the different aspects of block manufacture, machine design and analysis of impact compaction. It is split into four sections and each section makes recommendations for further work. The first section details the investigation of CSSB potential and acceptability. The second section extends this to include the work conducted on dynamic compaction of CSSB. The third reports the analysis of the mechanisms behind dynamic compaction and the implications for CSSB production. The final section includes the findings of overseas field trials and feasibility study of the application of dynamic compaction to CSSB block production in a developing country.

### ***9.1 Acceptability and potential of CSSB***

The use of earth as a building material is well known and its highly variable performance is well documented. Specific research in the production of building blocks over the years has revealed certain features of the material. Generally un-rendered low-cement (<6%) and low-density (<1800kg/m<sup>3</sup>) CSSB exhibit an unacceptably low tolerance to humid conditions and will deteriorate during less than 10 years. This deterioration is typically in the form of spalling of the exterior surface.

By increasing the cement content, and/or the density, the stability of the material is greatly enhanced and becomes more acceptable for use in humid areas.

Performance of the CSSB is usually defined by its wet compressive strength. Literature suggests that a CSSB that exhibits a 28-day wet compressive strength of 2MPa is considered a first class material (Houben & Guillaud, 1994). Previous research into CSSB production indicated that for suitable soils doubling the cement content more than doubles the wet compressive strength. It has also been noted that a 10% increase in density can approximately double the wet compressive strength. Higher cement content generates a more expensive material, but if a significant increase in density could be realised then the cement content could actually be reduced without harming the performance of the material. From this the potential of improving the performance for stabilised soil and more specifically CSSB has been identified.

There are other reasons for promoting the use of CSSB for low-cost walling. Several sources have indicated that environmentally unacceptable practises are currently involved in the delivery of low-cost walling. The use of clamp-fired brick and river sand is proving to be unsustainable in the long term and resources necessary for their production are becoming scarcer. CSSB has been identified as a more environmentally and socially acceptable alternative, if its production and use is carefully controlled.

An assessment of several different types of building materials indicated that high-density CSSB was the only material that consumes a modest amount of cement and has a low-energy requirement in its production and subsequent erection. Different block variants were also explored and these indicated that taller, interlocking and

hollow blocks had the most promise for further reducing the cement requirement of the material.

Testing of the finished CSSB involved a crushing test using sophisticated equipment and destroying the CSSB. The CSSB achieved the desired strength of 3.5MPa after 28-days. Unfortunately a suitable non-destructive test was still unavailable. The relationship between the density of the compacted material and the compressive strength showed potential as a method of strength estimation. Unfortunately this technique requires a careful production regime and calibration for each mixture of soil, cement and water. As this was not seen to be a practical solution an indentation tester was developed instead, which provided an indication of densification and the block strength. Readings could be taken at any point in the production cycle as a comparative measure of block performance. It could indicate large changes in block characteristics without the need for destructive testing. The limits of its accuracy were about 0.5MPa, so only changes in block characteristics larger than this could be identified. Improved resolution of the device could be achieved by modifying the shape of the indentation tip.

## **9.2 Performance of dynamic compaction**

The application of dynamic compaction to stabilised soil was initially investigated using small cylindrical samples. The results of the investigation were then extrapolated to the production of full-size blocks. Trials at the smaller scale confirmed previous findings that dynamic compaction is more energy efficient in consolidating

soil than quasi-static compression. This finding was not however replicated during the production of full-size blocks until their moisture content was raised from 6% to over 9%.

It was originally assumed that the lower moisture content suggested by the cement literature was more acceptable than the less handlable blocks with the higher water content. Trials indicated that the concrete literature did not apply to the production of stabilised soil and a much higher water content could be used successfully. The experimental evidence showed that adjusting the moisture content to achieve the greatest consolidation was an effective method of improving the strength of the material. This finding was consistent with the “optimum moisture content” defined in the soils literature.

Previous CSSB production guides suggest relatively basic systems for monitoring and controlling the moisture content, (drop test) and the quantity of material used to produce each CSSB, (volumetric measurement). After seeing how a small variation (2% drop) in the water content can have a pronounced effect on the block properties (50% drop in strength), it would be much better to implement an improved system of moisture control. Careful weighing is difficult to achieve in the field, but a small-scale compaction test may provide a suitable alternative for moisture content optimisation. The material measurement currently done by volume should be done by mass instead. The calculated density of the compacted material can be used as a method of feedback after block ejection only if an adequate system for mass measurement is incorporated in block production. Such systems are currently not in use, but the development of them would be beneficial in the field of CSSB production.



The process of dynamic compaction was investigated and compared with the equivalent quasi-static compression process. Both methods of consolidation exhibited similar levels of variation,  $\pm 1\%$  on density and  $\pm 10\%$  on wet compressive strength. The low variability of density was helpful in determining the optimum parameters for the dynamic compaction process. Earlier studies indicated that a heavy impactor with a low velocity provided marginally more effective material consolidation. Experiments conducted on small scale confirmed that this was true, and these findings were extrapolated to full-size. Full-size blocks required a higher energy transfer and therefore required a more massive impactor. A practical upper limit for the impactor mass was suggested as 80kg and 60kg was found to yield satisfactory results. The drop height of the impactor also had an upper limit because of the generation of a destructive reflection wave at high impactor velocities. It was found that a drop height of 400mm was acceptable on a firm foundation, but if a reflection wave was generated the drop height should be reduced.

Analysis of the potential of CSSB indicated that different block variants had potential for further reducing the cement and hence cost of the walling material. Two of these variants were tested using dynamic compaction, the cement-rich skin block and the hollow block. Unfortunately neither variant was very successful. The strength of the hollow block variant was too low for building purposes (0.6MPa). This was because the material density at the bottom of the block flange was quite low, as indicated by the indentation test. The potential of this type of block produced via dynamic compaction is uncertain and requires further work. Different methods of soil placement in the mould and different shaped voids may help deliver a more uniform

density throughout the block. The method for producing the cement-rich skin variant was too complicated for normal block production. A more automated system could be implemented but this variant yields only a small saving in cement and other variants hold more promise.

### **9.3 *Analysis of impact compaction***

We perhaps understand a little bit more about the process of soil consolidation after the experiments conducted on dynamic compaction. We have been able to determine that the closer arrangement of particles is primarily due to shock wave propagation through the material. The presence of free-water in the mixture aids this process significantly as the particles slide over one another into closer proximity with each other. The impact compaction drives out air from the mixture in this re-arrangement process at such a rate that some of the air becomes temporarily trapped and possibly compressed. This trapped or compressed air very slightly hinders further compaction, but not at a level of practical significance.

Careful monitoring of displacement during the impact cycle itself has revealed some interesting phenomenon in the process. From these findings it is possible to conclude that the method of dynamic compaction follows some sort of combined elastic-plastic-viscous model. Initially this model demonstrates high plastic deformation, low energy loss and low hysteresis. As the compaction process continues the model changes to include increased losses, a decreasing plastic component and the development of an elastic component. Towards the end of the possible compaction the plastic component

diminishes to zero, high energy loss is experienced through hysteresis and a small elastic component causes impactor bounce.

The discovery that the losses are so significant may seem like a disadvantage to the dynamic compaction process. The most effective compaction occurs during the very first few blows, but it is the latter blows that give the desired levels of compaction necessary for a high-density CSSB. These extra blows only require a small amount of extra time and therefore it seems reasonable to apply many of them. The large number of blows (>30) used for monitoring the impactor motion would not normally be experienced during normal block manufacture. Typically the number of blows would be smaller than this and could be stopped when further blows delivered little extra compaction rather than none at all.

The relative displacement was monitored during the impact cycle to gain an impression of the mechanisms behind impact compaction. An accelerometer was also used to determine the point of maximum acceleration, as the methods used for measuring the accelerations experienced by the impactor were unreliable beyond 25g. Calculations from the stopping distance applied to plastic, elastic and viscous models showed that the maximum accelerations experienced by the impactor were around 65g.

These accelerations experienced by the impactor were converted into forces delivered by the impactor, which were in turn experienced by the mould. These forces were a small fraction of the forces required for high-pressure quasi-static compression yet achieved similar and often better levels of consolidation with a tolerable number of

blows ( $<16$ ). A 10MPa hydraulic press would deliver about 400kN of force to the top of a block. Dynamic compaction was delivering about 30kN of force and also only for a short duration of 5-10ms.

The application of this dynamic lever in the compaction of CSSB provides another significant advantage over quasi-static in the potential use of a two-part mould rather than the very stiff 1-part mould required for quasi-static pressing. Significant forces (5kN) are required to overcome block friction and adhesion to the mould walls. These would be much reduced if the mould could be split into two parts after compaction. Dynamic compaction offers this possibility as the forces on the mould are much smaller and are very short in duration. The need of a large mechanical lever to eject the finished block would partially negate the advantages that dynamic compaction presents in machine design. Dynamic compaction removes large levers and forces applied to the block, so this novel method of mould design needs to be incorporated to maximise the advantages of the production process.

Trials of the two-part mould in the laboratory were a reasonable success. Blocks had to be ejected with care because of the adhesion between the block and the corner of the mould. The adhesion often resulted in small corners being left behind in the mould. After laboratory testing of the two-part mould and the necessary analysis for mould strength and stiffness from the data on the impact forces, the mould was slightly modified. The modified mould design used a different method of block removal, but the same two-part arrangement that was successful with dynamic compaction.

#### **9.4 Feasibility study of dynamically compacted CSSB**

The experiments in the laboratory indicated the potential success of dynamic compaction over quasi-static compression of CSSB. These findings needed to be confirmed in a more representative environment and consequently an overseas collaborator was sought out. A development organisation in India was the most promising of the different possible collaborators that we had correspondence with. They were able to comply with our requests for machine manufacture, future testing and possible dissemination if deemed successful.

Using a modest amount of machine tooling and expertise, a dynamic compaction block maker (Block Impacterre) was built in India. The team estimated the cost of machine production and block productivity was predicted following initial trials. Blocks produced were tested whilst I was there and further testing was conducted after I returned to the UK. The testing measured the performance of the material produced by Block Impacterre and a high-pressure competitor (Hydraform). From these findings it was possible to make a comparative analysis of walling material produced by both machines.

The study indicated that Hydraform could produce walling during its projected lifetime at a rate of £1.60/m<sup>2</sup>. Block Impacterre with its improvement in consolidation and hence lower cement requirements and much less expensive machine could produce walling costing only £0.91/m<sup>2</sup>. This represents a monetary saving of over 40%. The addition of sand to the soil mix makes the added cement even more

effective and therefore enables a greater reduction in cement whilst still maintaining the same strength. The addition of 30% of sand reduces the cost of walling to £1.29/m<sup>2</sup> and £0.74/m<sup>2</sup> for the Hydraform and Block Impacterre respectively, still representing a saving of over 40% using the dynamic process compared with quasi-static compression.

This analysis indicates that the process of dynamic compaction offers a significant incentive to switch from an alternative low-cost building material to dynamically compacted CSSB. However, such a switch is not guaranteed just because of a significant monetary incentive. Other factors need to be considered in order to assess if this material and this process will be successful. Communication with Indian building advisors suggests that CSSB is not cost effective if burnt brick is available. Typically a burnt brick in Delhi costs about £0.04 whilst a CSSB costs about £0.08. The 40% reduction in cost will go some way to bringing these two materials closer together, but the perceived poor performance of CSSB will drive away some potential customers. However, in areas where burnt brick is not available and consequently CSSB has a reasonable following already, the dynamic process of CSSB production should have significant potential. Further trials are necessary in such an environment along with pilot schemes to help disseminate the technology into communities with a need for low-cost walling.

The work carried out during this Ph.D. has been directed towards meeting a need for low-cost housing. It initiated with a concept that impact compaction provided a better alternative to material consolidation than slow squeezing. The research has taken this initial premise through stages of conceptualisation and laboratory testing during which

time the understanding of the process has been improved. Test results confirmed the initial potential of the process and this prompted machine design and dissemination for use in developing countries. The additional collaboration and field trials conducted on the finished machine have been very promising. Finally the analysis of the potential of the machine and its product has given the Ph.D. all aspects of research through to product dissemination. This has made the work both interesting and highly rewarding and will hopefully be useful to others in the future.

## Bibliography

1. Agarwal, Anil (1981) *Mud, mud*, IIED, London.
2. Agevi, E. (1999) "Technology Dissemination in Kenya", *Development Alternatives Newsletter*, Vol: 9 (11), 7-9.
3. Akroyd, T. N. W. (1962) *Concrete properties of manufacture*, Pergamon Press.
4. Ashurst, John and Ashurst, Nicola (1989) *Practical Building Conservation - Brick, terracotta and earth*, Gower Technical Press.
5. Bedford, A. and Fowler, W. (1997) *Statics*, Addison-Wesley.
6. Bee, Becky (1997) *The Cob Builders Handbook*.
7. Bondarik, G. K. (1967) *Dynamic and Static Sounding of Soils in Engineering Geology*, Israel Program for Scientific Translations, Ltd. Jerusalem, Israel.
8. Borland (1987) *Turbo C: The complete reference*, Osborne/McGraw-Hill.
9. Bramer, Brian and Bramer, Susan (1997) *C for Engineers*, Arnold.
10. British Standards Institution. (1971) *Specification for Portland cement (ordinary and rapid hardening)*. BS 12: 1971. BSI. England.
11. British Standards Institution. (1990) *Stabilised materials for civil engineering purposes. Part 1. General requirements, sampling, sample preparation and tests on materials before stabilisation*. BS 1924: Part 1: 1990. BSI. England.



12. British Standards Institution. (1990) *Stabilised materials for civil engineering purposes. Part 2: Methods of test for cement-stabilised and lime-stabilised materials*. BS 1924: Part 2: 1990. BSI. England.
13. British Standards Institution. (1990) *Method of test for soils for civil engineering purposes. Part 1. General requirements and sample preparation*. BSI 1377: Part 1: 1990. BSI. England.
14. British Standards Institution. (1990) *Method of test for soils for civil engineering purposes. Part 2. Classification tests*. BS 1377: Part 2: 1990. BSI. England.
15. British Standards Institution. (1990) *Method of test for soils for civil engineering purposes. Part 4. Compaction-related tests*. BS 1377: Part 4: 1990. BSI. England.
16. Britto, A. M. and Gunn, M. J. (1987) *Critical State Soil Mechanics via Finite Elements*, Ellis Horwood Limited.
17. Carvill, James (1997) *Mechanical Engineer's Data Handbook*, Butterworth-Heinemann.
18. Cedergren, H. R. (1967) *Seepage, Drainage, and Flow Nets*, John Wiley & Sons.
19. Centre for the Development of Industry (1998) *Compressed earth block standards*, CRAterre - EAG/CDI.
20. Chan, W. W. J., & Wu, C. M. L. (2000) "Durability of concrete with high

cement replacement", *Cement and Concrete Research*, Vol: 30 865-879.

21. Coates, R. C., Coutie, M. G., and Kong, F. K. (1994) *Structural Analysis*, Chapman & Hall.
22. Craig, R. F. (1997) *Soil Mechanics*, E & FN Spon.
23. Davies, Ian (1978) *Shelter after disaster*, Oxford Polytechnic Press Oxford, UK.
24. Department of Engineering (1996) *Engineer Data Book*, University of Warwick England.
25. Easton, David (1996) *The Rammed Earth House*, Chelsea Green England.
26. Flugge, Wilhelm (1967) *Stresses in shells*, Springer Verlag New York.
27. Gee (1997) *The Health and Safety Factbook*, Gee Publishing Limited.
28. Ghali, A. and Neville, A. M. (1997) *Structural Analysis: A Unified Approach*, Spon.
29. Gooding, D. E. M. (1993) *Improved processes for the production of soil-cement building blocks*, Unpublished doctoral dissertation: Warwick, University of Warwick.
30. Gooding, D. E. M., & Thomas, T. (1995). *The Potential of Cement-Stabilised Building Blocks as an Urban Building Material in Developing Countries*, ODA Report, UK.
31. Guillaud, Hubert, Joffroy, Thierry, and Odul, Pascal (1995) *Compressed earth blocks - Volume 2: Manual of design and construction*, GATE Germany.

32. Hanson. (2001) Hanson Bricks [Web Page]. URL [www.hanson-brickseurope](http://www.hanson-brickseurope)  
[Accessed: 2001].
33. Harr, M. E. (1962) *Groundwater and Seepage*, McGraw Hill.
34. Hausmann, Manfred. R. (1990) *Engineering Principles of Ground Modification*,  
McGraw Hill Sydney.
35. Head, K. H. (1980) *Soil Laboratory Testing - Volume 1*, Pentech Press, London.
36. Head, K. H. (1980) *Soil Laboratory Testing - Volume 2*, Pentech Press, London.
37. Holmes, Stafford and Wingate, Michael (1997) *Building with Lime*,  
Intermediate Technology Publications London, UK.
38. Houben, Hugo and Guillaud, Hubert *Earth Construction: A Comprehensive  
Guide*, Intermediate Technology Publications, UK.
39. Houben, Hugo, Rigassi, Vincent, and Garnier, Philippe (1994) *Compressed  
earth blocks: production equipment*, Centre Devt Industry (CDI) Brussels,  
Belgium.
40. Hutchings, Howard (1995) *Interfacing with C*, Butterworth-Heinemann Ltd.
41. Ingles, O. G. and Metcalf, J. B. (1972) *Soil Stabilisation Principles and  
Practice*, Butterworths, Sydney.
42. International Labour Office (1987) *Small-scale manufacture of stabilised soil  
blocks*, International Labour Office, Geneva.
43. International Labour Office (1990) *Small-scale brickmaking*, International

Labour Office, Geneva.

44. Jones, Norman (1997) *Structural Impact*, Cambridge.
45. Jones, R. (1962) *Non-Destructive Testing of Concrete*, Cambridge University Press Cambridge.
46. Keable, Julian (1996) *Rammed earth structures: a code of practice*, IT Publications London, UK.
47. Keddie, James and Cleghorn, William (1980) *Brick Manufacture in Developing Countries*, Scottish Academic, Edinburgh.
48. Kelkar, Vasant S. and Sewell, Robert T. (1987) *Fundamentals of the analysis and design of shell structures*, Prentice Hall, USA.
49. Kerali, A. G. (2001) *Durability of Compressed and Cement-Stabilised Building Blocks*, University of Warwick, UK
50. Kumar, A. (1999) "Sustainable building technologies for mass application", *Development Alternatives Newsletter*, Vol: 9 (11), 1,3,4.
51. Lambe, T. William and Whitman, Robert V. (1969) *Soil Mechanics*, John Wiley and Sons.
52. Lea, F. M. (1970) *The chemistry of cement and concrete*, Edward Arnold.
53. Mallet, Geoff (1991) *Fatigue of Reinforced Concrete*, HMSO.
54. Mbumbia, L., Mertens de Wilmars, A., & Tirlocq, J. (2000) "Performance characteristics of lateritic soil bricks fired at low temperatures: a case

- study of Cameroon", *Construction and Building Materials*, Vol: 14 121-131.
55. Miller, G. A., & Azad, S. (2000) "Influence of soil type on stabilization with cement kiln dust", *Construction and Building Materials*, Vol: 14 89-97.
56. Montgomery, D. E. (1997) *Design and Realisation of a Test Rig to Research the Production of Full Size Dynamically Compacted Soil-Cement Blocks*, University of Warwick, UK.
57. Neville, A. M. (1995) *Properties of Concrete*, Longman.
58. Norton, J. (1997) *Building with Earth*, Intermediate Technology Publication London.
59. Orchard, D. F. (1979) *Concrete Technology*, Applied Science Publishers.
60. Parry, J. P. M. (1979) *Brickmaking in developing countries*, Building Research Establishment, UK.
61. Parsons, A. W. (1992) *Compaction of soils and granular materials: A review of research performed at the Transport Research Laboratory*, HMSO, UK.
62. Popovics, Sandor (1998) *Strength and related properties of concrete: A quantitative approach*, John Wiley & Sons.
63. Powers, Treval C. (1968) *The properties of fresh concrete*, John Wiley & Sons.
64. Rigassi, Vincent (1995) *Compressed earth blocks - Volume 1: Manual of production*, GATE.

65. Sabir, B. B., Wild, S., & Bai, J. (2001) "Metakaolin and calcined clays as pozzolans for concrete: a review", *Cement and Concrete Composites*, Vol: 23 (6), 441-454.
66. Scott, R. A., & Pearce, R. W. (1975). "Soil compaction by impact" *Ground treatment by deep compaction*, Institute of Civil Engineers, London.
67. Shan, H.-Y., & Meegoda, J. N. (1998) "Construction use of abandoned soils", *Journal of Hazardous Materials*, Vol: 58 133-145.
68. Smith, Edward W. and Austin, George S. (1996) *Adobe, pressed-earth, and rammed-earth industries in New Mexico*, Authority of State of New Mexico, USA.
69. Thermalite. (2001) Thermalite [Web Page]. URL [www.thermalite.co.uk](http://www.thermalite.co.uk) [Accessed: 2001].
70. UNCHS/ILO (1995) *Shelter provision and employment generation*, Habitat/ILO Nairobi.
71. United Nations (1964) *soil-cement it's use in building*, United Nations, New York.
72. United Nations (1972) *The manufacture and utilisation of Portland cement*, United Nations.
73. Walker, P. (Aug/1999) "Bond Characteristics of Earth Block Masonry", *Journal of Materials in Civil Engineering*, Vol: 11 (3), 249-256.
74. Webb, D. J. T. (1988) *Stabilised Soil Building Blocks*, University of Newcastle-

upon-Tyne, UK.

75. Webb, D J T and Lockwood, A J (1987) *BREPAK Operators Manual*, BRE, Watford, UK.
76. Wolfs-kill, L. A., Dunlop, W. A., & Callaway, B. M. (1965) *Handbook for Building Homes of Earth*.
77. Yogananda (1999) "Stabilised Mud Block Homes in Bangalore", *Development Alternatives Newsletter*, Vol: 9 (11), 13.

## Appendices

### Appendix A - Analysis and production of soils used

#### Analysis of soil-A, soil-B and soil-I

Approximate values for the three main soil fractions for each soil

Particle	Size (mm)	soil-A (%)	soil-B (%)	soil-I (%)
Clay	0.000-0.002	15	20	7
Silt	0.002-0.063	8	1	32
Sand and gravel	> 0.063	77	79	61

Graphical results of sieve analysis

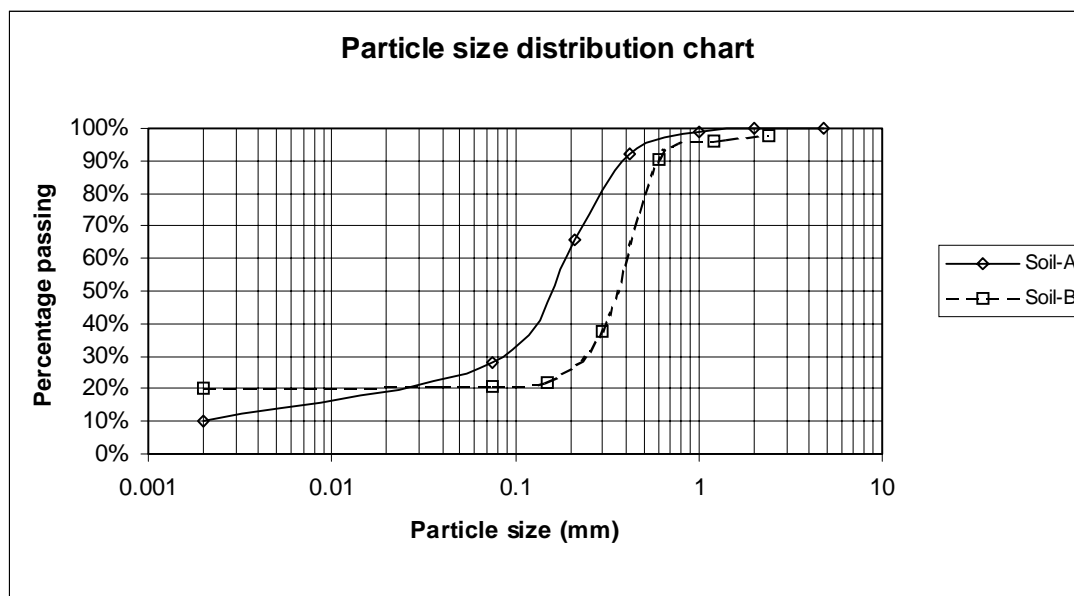



### Mixing of soil-B

The raw materials for the laboratory soil was generally mixed dry to ensure that the cement present in the mix would not start to hydrate until a known amount of water was added. This enabled large quantities of soil-B to be weighed and mixed waiting for further processing. Typically the dry mix was weighed out on a set of Avery Scales rated to 50kg to the following proportions:

Oven dry builders sand	15.2 kg	This results in a 4:1 mixture of sand to Kaolin clay and an overall percentage of cement equal to 5% by mass.
Kaolin clay grade-E	3.8 kg	
<u>Cement</u>	<u>1.0 kg</u>	
Total	20.0 kg	

The dry quantities were placed into plastic bags and mixed together when necessary in a steel drum with a lockable lid. Due to the high level of fines present in the mixture the sealed drum was necessary to keep the dust levels down and to also to ensure that the fines added remained in the mix rather than becoming airborne.

Water was added to the weighed out samples in a batch size of one and the water was mixed using a Hobart mixer. The mixer motor had been condemned, consequently the mixing paddle has to be turned by hand via the main crank shaft and gearbox through an attached handle. The handle was rotated at a rate of around 60 revolutions per minute and the mixture was mixed for at least 3 minutes. The mixture had always taken a uniform colour at this time and further mixing was not only exhausting, but also seemingly unnecessary.

Some tests required soil-B without any cement present and the quantities were mixed together in the electric drum mixer and mixed with water in the correct quantity. The finished mix was then placed into plastic bins and used when necessary ensuring the mixture was never left open any longer than necessary to extract a quantity of soil.

## Appendix B - Photographs

### The laboratory Test-Rig



Original test rig (cement impactor)

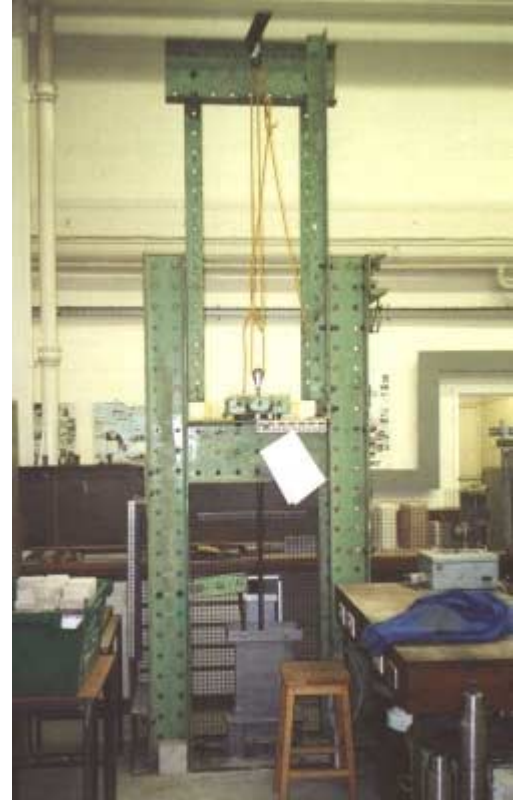

Modified test rig (steel impactor)



Two part mould in use, illustrating the problem with block ejection

### The Production Prototype



Production prototype



Overhead pulley added



Impactor lifting mechanism added



Ejection mechanism added



New cast concrete impactor



Overview of prototype

## Blocks



Early compacted block



First block in India



Improved block ejection



Finished blocks



Minor block defects



Hydraform blocks

**Different types of walling seen in India**



Balram block walling (self build)



The alternative



Bricks from waste material



Poorly fired bricks



Stone cladding over bricks



Hydraform house

**Appendix C - Test Rig design**

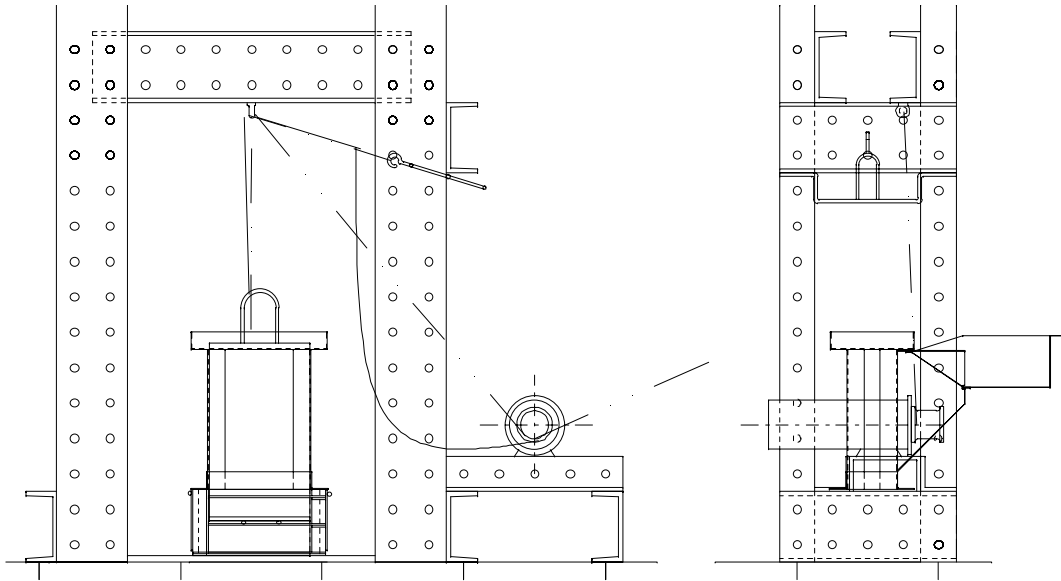

Overview of initial set up of Test Rig using the concrete impactor lifted via a pulley and motor driven capstan.

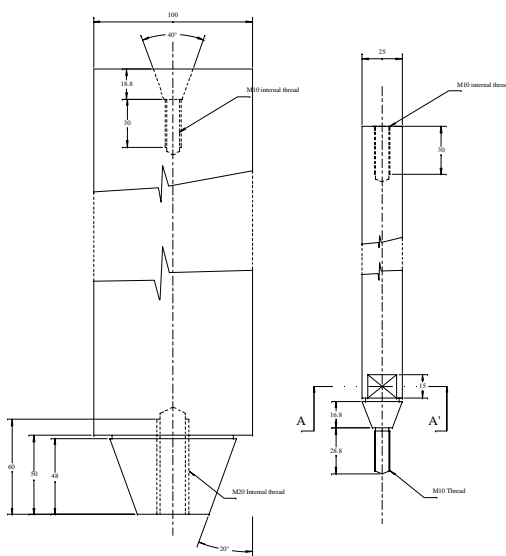

Metal impactor and lifting rod details

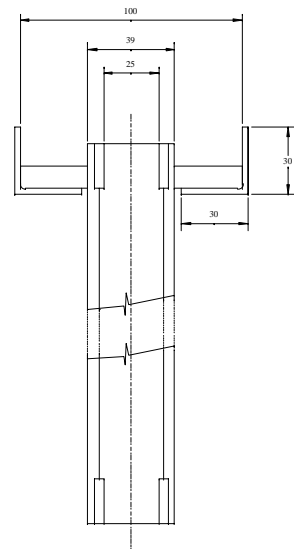

400mm linear bearing

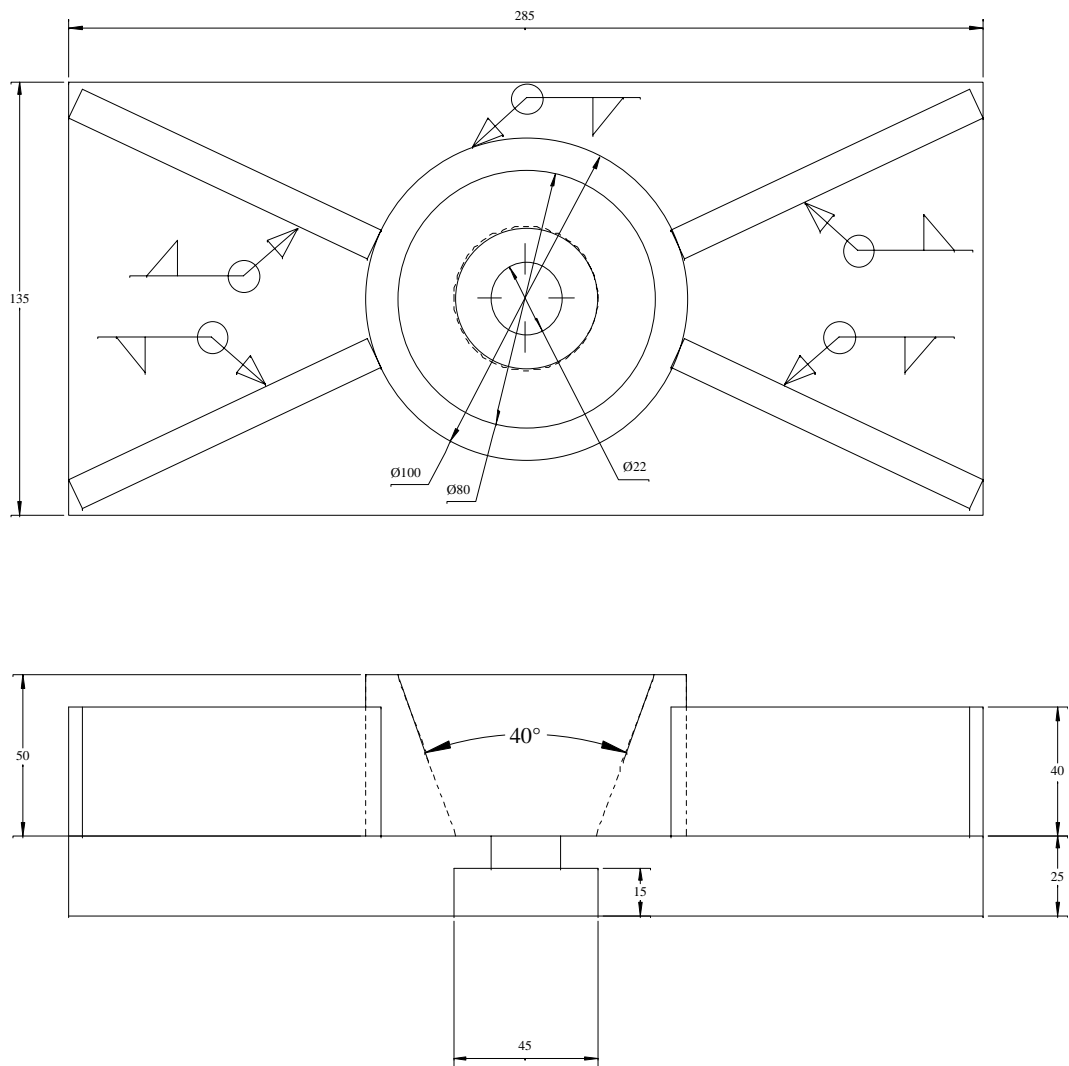

Metal impactor base details



### **Appendix D - Machine drawings**

The following pages contain 9 drawings that have been copied from the CAD program used to make them, (Pro-Desktop 2000i<sup>2</sup>). The original drawings were sent to India for them to manufacture the machine before the overseas trip. All of the following drawings have been scaled to fit onto the page and consequently are not displayed at the scale indicated on the drawing. The first drawing in this collection is the Arrangement drawing that identifies the different components of the machine. The following table summarises each of the drawings with reference to this arrangement drawing and identifies them with the part number that is used.

Part No.	Drawing name
1	D_D_Bucket
2	D_D_Hopper
3	D_D_Mould base
4	D_D_Impactor guide
5, 6	D_D_Impactor
7	D_D_Mould front
8, 9, 11	D_D_Locking handles
10	D_D_Impactor guide support

Note: the conversion process has caused some of the text on the drawings to be lost.

Also the symbol '∅' has been replaced by '%%c'.

### D\_D Arrangement

PARTS LIST	
ID	DESCRIPTION
1	Bucket
2	Hopper
3	Mould base
4	Impactor guide
5	Impactor skeleton
6	Impactor skin
7	Mould front
8	Right Locking Mech.
9	Left Locking Mech.
10	Impactor guide support
11	Handle
12	Block

	A Added guide support
	TITLE
Arrangement Drawing	
FILE NAME D_D_Arrangement	

# D\_D\_Bucket

The soil bucket is fabricated from sheet steel and folded into the shape below. A 4mm steel rod is welded to the bottom edge of the bucket to interface into the slot on the hopper.

All dimensions in millimeters

TITLE	Soil bucket								
FILE NAME	D_D_Bucket								

# D\_D\_Hopper

The soil hopper is fabricated from sheet steel folded into the shape shown.  
 A small slot 5mm wide permits the soil bucket to slot into the hopper and pivot about its rod.  
 Note: All dimensions should be only to the nearest millimeter.

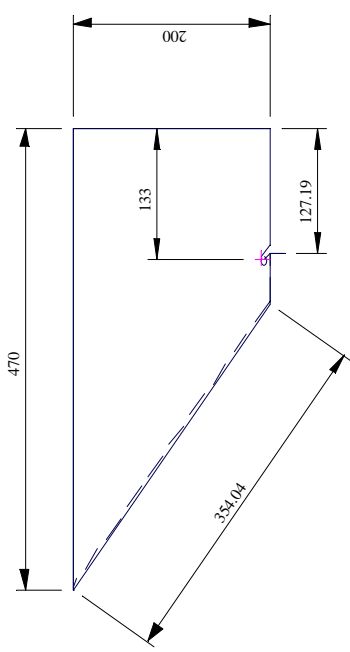

All dimensions in millimeters

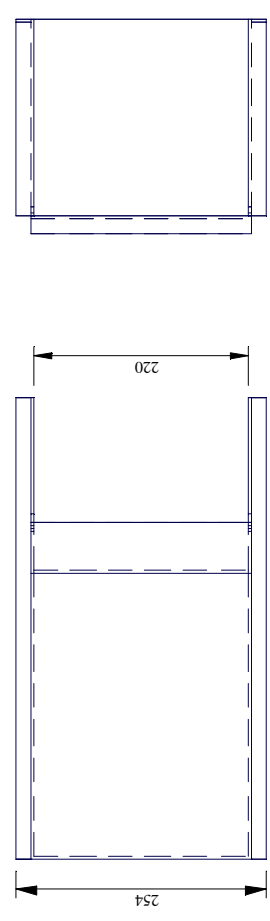

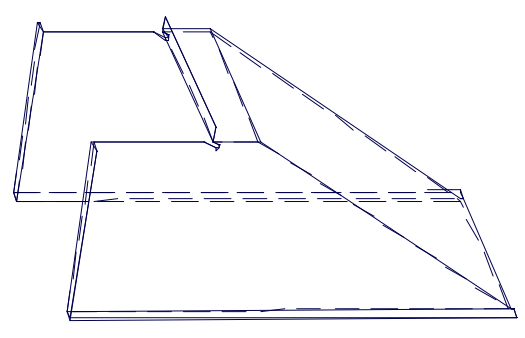

TITLE	Soil hopper				
FILE NAME	D_D_Hopper				

D\_D\_Mould base

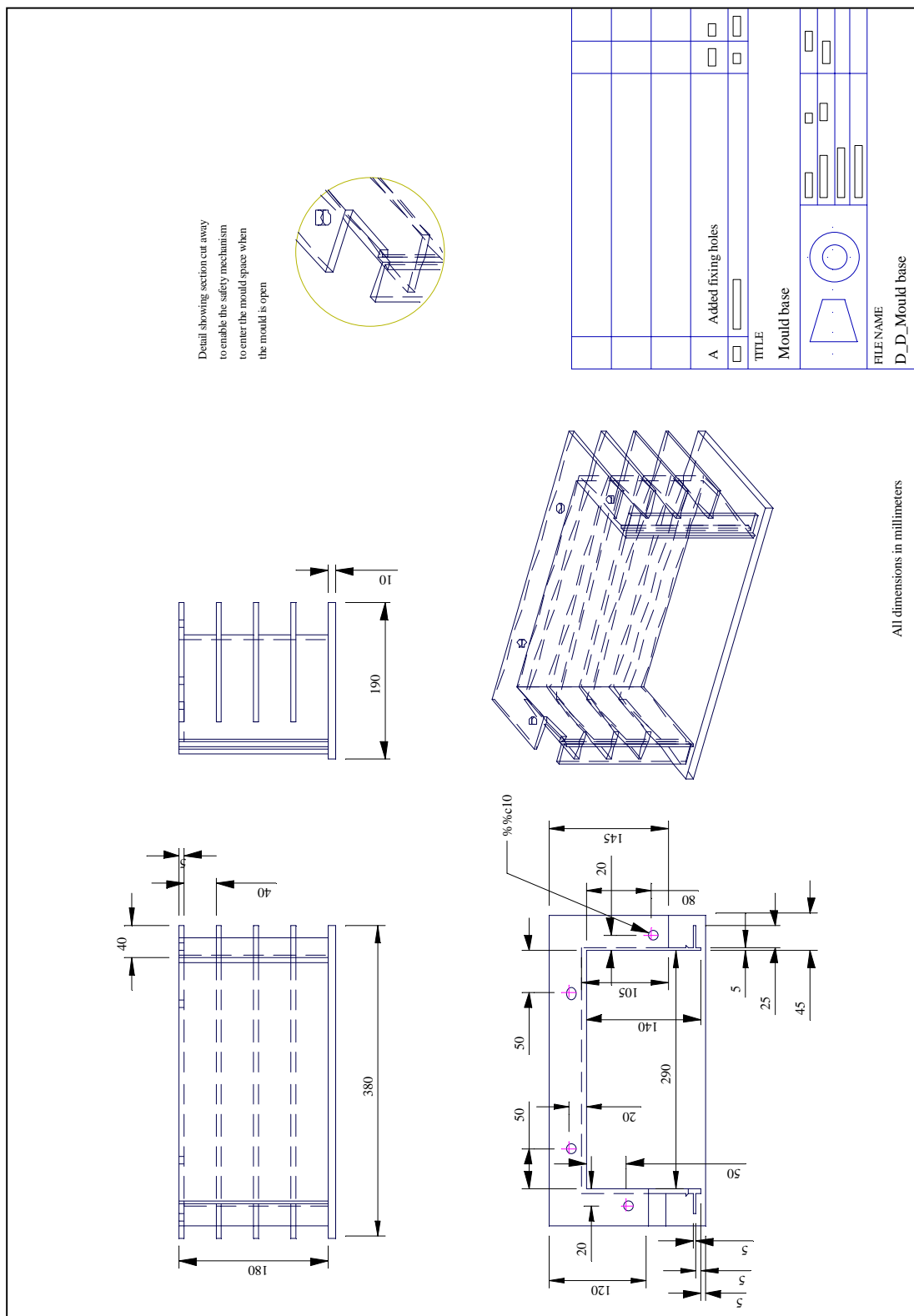











### D\_D\_Impactor guide support

The Impactor guide support is constructed from 5 pieces of angle iron. Two at 500mm long, Two at 800mm long and One at 380 mm long.

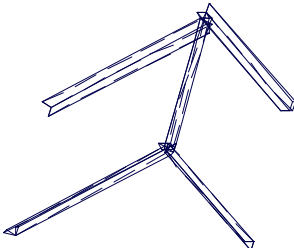
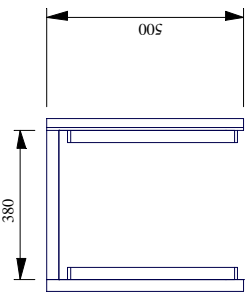
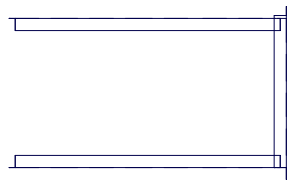
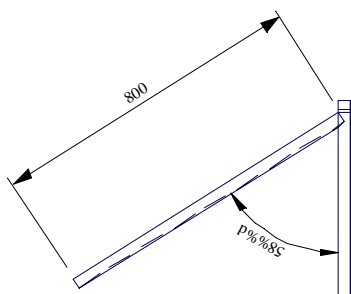
TITLE  
Impactor guide support

FILE NAME  
D\_D\_Impactor guide support

All dimensions in millimeters

## Appendix E - Material calculations – cement minimisation

### Comparing the energy and material requirements of some typical building materials

		Hollow Cement Block	Hollow Cement Block	CSSB High	CSSB Low	Clay Brick** Kiln	Clay Brick** Clamp	Thermalite Block
<i>Specifications</i>	Units	(Nearby)	(Far)‡	Density	Density			
Block Length	m	0.300	0.300	0.290	0.290	0.215	0.215	0.440
Block Width	m	0.150	0.150	0.140	0.140	0.105	0.105	0.140
Block Height	m	0.200	0.200	0.090	0.090	0.065	0.065	0.215
Material Density	kg/m <sup>3</sup>	2200	2200	2000	1700	1350	1350	480
Void Volume	%	50%	50%	0%	0%	0%	0%	0%
Block Mass	kg	9.9	9.9	7.3	6.2	2.0	2.0	6.4
Soil Content	%	0%	0%	95%	90%	100%	100%	0%
Sand Content	%	30%	30%	0%	0%	0%	0%	0%
Gravel Content	%	55%	55%	0%	0%	0%	0%	0%
Cement Content	%	15%	15%	5%	10%	0%	0%	15%
Comp. Str.	MPa	7	7	3	1.5	20	7	7
<i>Raw Materials</i>								
Soil Mass	kg	0.00	0.00	6.94	5.59	1.98	1.98	0.00
Sand Mass	kg	2.97	2.97	0.00	0.00	0.00	0.00	0.00
Gravel Mass	kg	5.45	5.45	0.00	0.00	0.00	0.00	0.00
Cement Mass	kg	1.49	1.49	0.37	0.62	0.00	0.00	0.95
<i>Production</i>								
Processing Energy	kJ/kg	0.4	0.4	0.8	0.6	1514.4	8076.9	0.9
<i>Construction</i>								
Mortar thickness	m	0.01	0.01	0.01	0.015	0.01	0.015	0.003
Render thickness	m	0	0	0	0.015	0	0	0
Material Density	kg/m <sup>3</sup>	1800	1800	1800	1800	1800	1800	1800
Soil Content	%	0%	0%	80%	80%	0%	0%	0%
Sand Content	%	80%	80%	0%	0%	80%	80%	0%
Cement Content	%	20%	20%	20%	20%	20%	20%	50%
Soil Mass/block	kg	0.00	0.00	0.79	1.89	0.00	0.00	0.00
Sand Mass/block	kg	1.10	1.10	0.00	0.00	0.44	0.67	0.00
Cement Mass/block	kg	0.28	0.28	0.20	0.47	0.11	0.17	0.25
<i>Transportation</i>								
Soil Mass	kg	0.00	0.00	7.73	7.48	1.98	1.98	0.00
Sand Mass/block	kg	4.07	4.07	0.00	0.00	0.44	0.67	0.00
Gravel Mass/block	kg	5.45	5.45	0.00	0.00	0.00	0.00	0.00
Cement Mass/block	kg	1.76	1.76	0.56	1.09	0.11	0.17	1.20
Soil distance	km	0	0	0	0	0	0	0
Sand distance	km	20	50	50	50	50	50	50
Gravel distance	km	20	50	50	50	50	50	50
Cement distance	km	100	100	100	100	100	100	100
Finished blocks distance	km	10	10	10	10	10	10	50
<i>Energy</i>								
<i>Extraction &amp; Processing</i>								
Soil (100 kJ/kg)	kJ	0	0	773	748	198	198	0

Sand (200 kJ/kg)	kJ	814	814	0	0	88	134	0
Gravel (100 kJ/kg)	kJ	545	545	0	0	0	0	0
Cement (6000 kJ/kg)	kJ	10562	10562	3372	6556	658	1004	7214
Block Production	kJ	4	4	6	4	3000	16000	6
<i>Transport</i>								
Truck (35kJ/kg/km)	kJ	16288	26280	4525	5999	1844	2450	15333
Total Per Block unit	MJ	28.21	38.21	8.68	13.31	5.79	19.79	22.55
<i>Comparators</i>								
Block units/m <sup>2</sup>		15.4	15.4	33.3	31.2	74.1	67.9	10.4
Soil	kg/m <sup>2</sup>	0.0	0.0	257.6	233.5	146.7	134.6	0.0
Sand	kg/m <sup>2</sup>	62.5	62.5	0.0	0.0	32.5	45.5	0.0
Gravel	kg/m <sup>2</sup>	83.6	83.6	0.0	0.0	0.0	0.0	0.0
<b>Cement</b>	<b>kg/m<sup>2</sup></b>	<b>27.0</b>	<b>27.0</b>	<b>18.7</b>	<b>34.1</b>	<b>8.1</b>	<b>11.4</b>	<b>12.4</b>
<b>Total Energy</b>	<b>MJ/m<sup>2</sup></b>	<b>433</b>	<b>587</b>	<b>289</b>	<b>416</b>	<b>429</b>	<b>1344</b>	<b>234</b>
Suitability for local Production	1 - 3 †	1	1	2	2	2	1	2
Suitability for on-site Production	1 - 3 †	2	2	1	1	3	2	3
<b>Notes:</b>								
‡		Sand and gravel is transported 50km instead of 20km						
†		Ranking 1 = Best, 3 = Worst						
*		Non-uniform distribution of cement in the block						
**		Brick wall includes a double brick buttress at 1 meter centers for enhanced stability						

## Comparing the energy and material requirements of High-density CSSB variants

		Normal	Hollow	Cement	Interlock	Tall	Rendered	Tall
		CSSB	CSSB	Rich skin	CSSB	CSSB	CSSB	Hollow
	Units			CSSB				Interlock
								CSSB
<i>Specifications</i>								
Block Length	m	0.290	0.290	0.290	0.297	0.290	0.290	0.297
Block Width	m	0.140	0.140	0.140	0.140	0.140	0.140	0.140
Block Height	m	0.090	0.090	0.090	0.097	0.140	0.090	0.147
Material Density	kg/m <sup>3</sup>	2000	2000	2000	2000	2000	2000	2000
Void Volume	%	0%	30%	0%	0%	0%	0%	30%
Block Mass	kg	7.3	5.1	7.3	8.1	11.4	7.3	8.6
Soil Content	%	95%	95%	96%	95%	95%	97%	95%
Sand Content	%	0%	0%	0%	0%	0%	0%	0%
Gravel Content	%	0%	0%	0%	0%	0%	0%	0%
Cement Content	%	5%	5%	4.0%	5%	5%	3%	5%
Comp. Str.	MPa	3	3	3	3	3	3	3
<i>Raw Materials</i>								
Soil Mass	kg	6.94	4.86	7.02	7.66	10.80	7.09	8.13
Sand Mass	kg	0.00	0.00	0.00	0.00	0.00	0.00	0.00
Gravel Mass	kg	0.00	0.00	0.00	0.00	0.00	0.00	0.00
Cement Mass	kg	0.37	0.26	0.29	0.40	0.57	0.22	0.43
<i>Production</i>								
Processing Energy	kJ/kg	0.8	1.2	0.8	0.7	0.5	0.8	0.7
<i>Construction</i>								
Mortar thickness	m	0.01	0.01	0.01	0.003	0.01	0.01	0.003
Render thickness	m	0	0	0	0	0	0.015	0
Material Density	kg/m <sup>3</sup>	1800	1800	1800	1800	1800	1800	1800
Soil Content	%	80%	80%	80%	80%	80%	80%	80%
Sand Content	%	0%	0%	0%	0%	0%	0%	0%
Cement Content	%	20%	20%	20%	20%	20%	20%	20%
Soil Mass/block	kg	0.79	0.79	0.79	0.24	0.89	1.43	0.27
Sand Mass/block	kg	0.00	0.00	0.00	0.00	0.00	0.00	0.00
Cement Mass/block	kg	0.20	0.20	0.20	0.06	0.22	0.36	0.07
<i>Transportation</i>								
Soil Mass	kg	7.73	5.65	7.80	7.90	11.69	8.52	8.40
Sand Mass/block	kg	0.00	0.00	0.00	0.00	0.00	0.00	0.00
Gravel Mass/block	kg	0.00	0.00	0.00	0.00	0.00	0.00	0.00
Cement Mass/block	kg	0.56	0.45	0.49	0.46	0.79	0.58	0.50
Soil distance	km	0	0	0	0	0	0	0
Sand distance	km	50	50	50	50	50	50	50
Gravel distance	km	50	50	50	50	50	50	50
Cement distance	km	100	100	100	100	100	100	100
Finished blocks distance	km	10	10	10	10	10	10	10
<i>Energy</i>								
<i>Extraction &amp; Processing</i>								
Soil (100 kJ/kg)	kJ	773	565	780	790	1169	852	840
Sand (200 kJ/kg)	kJ	0	0	0	0	0	0	0
Gravel (100 kJ/kg)	kJ	0	0	0	0	0	0	0
Cement (6000 kJ/kg)	kJ	3372	2714	2933	2780	4741	3467	2973
Block Production	kJ	6	6	6	6	6	6	6
<i>Transport</i>								
Truck (35kJ/kg/km)	kJ	4525	3374	4269	4445	6744	4580	4729
Total Per Block unit	MJ	8.68	6.66	7.99	8.02	12.66	8.91	8.55

<i>Comparators</i>								
Block units/m <sup>2</sup>		33.3	33.3	33.3	33.3	22.2	33.3	22.2
Soil	kg/m <sup>2</sup>	257.6	188.2	260.1	263.4	259.7	284.1	186.7
Sand	kg/m <sup>2</sup>	0.0	0.0	0.0	0.0	0.0	0.0	0.0
Gravel	kg/m <sup>2</sup>	0.0	0.0	0.0	0.0	0.0	0.0	0.0
<b>Cement</b>	<b>kg/m<sup>2</sup></b>	<b>18.7</b>	<b>15.1</b>	<b>16.3</b>	<b>15.4</b>	<b>17.6</b>	<b>19.3</b>	<b>11.0</b>
<b>Total Energy</b>	<b>MJ/m<sup>2</sup></b>	<b>289</b>	<b>222</b>	<b>266</b>	<b>267</b>	<b>281</b>	<b>297</b>	<b>190</b>
Suitability for local Production	1 - 3 †	2	2	1	2	2	2	2
Suitability for on-site Production	1 - 3 †	1	1	2	1	1	1	1
<u>Notes</u>								
Hollow	30% material removal from block core (deep frog arrangement)							
Cement rich skin	10% cement in first 20mm of exterior block surface, 3% in body of block							
Interlock	Thin mortar joint of only 3mm required							
Tall	Increased block height reduces mortar per square meter							
Rendered	15mm render on a block with only 3% cement in body of block							

## Comparing the energy and material requirements of CSSB machines used in

### India

			Hydraform CSSB	Block Impacterre	Hydraform CSSB	Block Impacterre
Block Production		Units		CSSB		CSSB
Specifications	Block Length	m	0.215	0.290	0.215	0.290
	Block Width	m	0.221	0.140	0.221	0.140
	Block Height	m	0.116	0.090	0.116	0.090
	Material Density	kg/m <sup>3</sup>	1875	1925	1875	1925
	Void Volume	%	0%	0%	0%	0%
	Block Mass	kg	10.3	7.0	10.3	7.0
	Soil Content	%	64.5%	66.5%	93.0%	95.0%
	Sand Content	%	30.0%	30.0%	0.0%	0.0%
	Gravel Content	%	0.0%	0.0%	0.0%	0.0%
	Cement Content	%	5.5%	3.5%	7.0%	5.0%
	7-day W.C.S.	MPa	3.5	3.5	3.5	3.5
Raw Materials	Soil Mass	kg	6.67	4.68	9.61	6.68
	Sand Mass	kg	3.10	2.11	0.00	0.00
	Gravel Mass	kg	0.00	0.00	0.00	0.00
	Cement Mass	kg	0.57	0.25	0.72	0.35
Production	Production rate	b/hr	100	60	100	60
	Production lifetime	hr	7680	7680	7680	7680
	Processing Energy	kJ/kg	17.4	0.5	17.4	0.5
Machine cost	Purchase Price	£	2860	500	2860	500
	Cost/m <sup>2</sup>	£	0.15	0.04	0.15	0.04
Construction	Mortar thickness	m	0	0.01	0	0.01
	Render thickness	m	0	0	0	0
	Material Density	kg/m <sup>3</sup>	1600	1600	1600	1600
	Soil Content	%	80%	80%	80%	80%
	Sand Content	%	0%	0%	0%	0%
	Cement Content	%	20%	20%	20%	20%
	Soil Mass/block	kg	0.00	0.70	0.00	0.70
	Sand Mass/block	kg	0.00	0.00	0.00	0.00
Transportation	Cement Mass/block	kg	0.00	0.17	0.00	0.17
Raw Materials	Soil Mass	kg	6.67	5.38	9.61	7.38
Total (Block unit)	Sand Mass	kg	3.10	2.11	0.00	0.00
	Gravel Mass	kg	0.00	0.00	0.00	0.00
	Cement Mass	kg	0.57	0.42	0.72	0.53
Distance	Soil	km	0	0	0	0
	Sand	km	25	25	25	25
	Gravel	km	50	50	50	50
	Cement	km	100	100	100	100
Energy	Finished blocks	km	10	10	10	10
Extraction &	Soil (100 kJ/kg)	kJ	667	538	961	738
Processing	Sand (200 kJ/kg)	kJ	620	422	0	0
	Gravel (100 kJ/kg)	kJ	0	0	0	0
	Cement (6000 kJ/kg)	kJ	3410	2525	4340	3159
	Block Production	kJ	180	3.7	180	3.7
Transport	Truck (35kJ/kg/km)	kJ	8319	5781	6149	4304
Total	Per Block unit	MJ	13.20	9.27	11.63	8.20
Material	Block units/m <sup>2</sup>		40.1	33.3	40.1	33.3

	Soil	kg/m <sup>2</sup>	267.3	179.2	385.4	246.0
	Sand	kg/m <sup>2</sup>	124.3	70.3	0.0	0.0
	Gravel	kg/m <sup>2</sup>	0.0	0.0	0.0	0.0
	<b>Cement</b>	<b>kg/m<sup>2</sup></b>	<b>22.8</b>	<b>14.0</b>	<b>29.0</b>	<b>17.5</b>
<b>Energy</b>	<b>Total</b>	<b>MJ/m<sup>2</sup></b>	<b>529</b>	<b>309</b>	<b>466</b>	<b>273</b>
<b>Cost</b>	<b>Total</b>	<b>£/m<sup>2</sup></b>	<b>1.29</b>	<b>0.74</b>	<b>1.60</b>	<b>0.91</b>
Suitability	Local Production	1 – 4 †	3	2	2	1
	On-site Production	1 – 4 †	4	3	2	1

† - Ranking 1 = best



## Appendix F - Numerical results of small scale tests

### First investigation results of pressure density relationship

soil-B with 5% cement and a 6% Moisture Content compressed to 20MPa in 32mm wall thickness mould

		First sample		Second sample		Third sample		
		Pre -	Projected	Pre -	Projected	Pre -	Projected	
Applied	Applied	Ejected	Dry	Ejected	Dry	Ejected	Dry	Average
Pressure	Force	Height	Density	Height	Density	Height	Density	P.D.D.
MPa	kN	mm	kg/m <sup>3</sup>	mm	kg/m <sup>3</sup>	mm	kg/m <sup>3</sup>	kg/m <sup>3</sup>
0	0.00	63.8	1349	63.5	1355	63.4	1358	1354
2	4.65	46.6	1847	48.2	1785	48.1	1789	1807
4	9.30	44.3	1943	45.7	1884	45.6	1889	1905
6	13.95	42.9	2005	44.4	1937	44.2	1947	1963
8	18.59	42.1	2046	43.6	1974	43.4	1985	2002
10	23.24	41.4	2077	42.9	2004	42.7	2016	2032
12	27.89	40.9	2104	42.4	2030	42.1	2042	2059
14	32.54	40.4	2128	41.9	2052	41.7	2066	2082
16	37.19	40.0	2149	41.5	2073	41.2	2087	2103
18	41.84	39.7	2169	41.1	2091	40.9	2106	2122
20	46.49	39.4	2186	40.8	2108	40.5	2124	2139
0	0.00	41.3	2083	43.0	2003	42.8	2009	2032

soil-B with 5% cement and a 8% Moisture Content compressed to 20MPa in 32mm wall thickness mould

		First sample		Second sample		Third sample		
		Pre -	Projected	Pre -	Projected	Pre -	Projected	
Applied	Applied	Ejected	Dry	Ejected	Dry	Ejected	Dry	Average
Pressure	Force	Height	Density	Height	Density	Height	Density	P.D.D.
MPa	kN	mm	kg/m <sup>3</sup>	mm	kg/m <sup>3</sup>	mm	kg/m <sup>3</sup>	kg/m <sup>3</sup>
0	0.00	64.1	1342	64.3	1339	63.3	1359	834
2	4.65	47.3	1817	46.9	1835	47.3	1821	1113
4	9.30	45.0	1913	44.6	1931	44.9	1917	1170
6	13.95	43.6	1971	43.2	1991	43.5	1976	1205
8	18.59	42.7	2015	42.3	2032	42.6	2019	1230
10	23.24	42.1	2046	41.7	2062	42.0	2049	1248
12	27.89	41.5	2072	41.2	2088	41.5	2075	1264
14	32.54	41.1	2095	40.8	2110	41.0	2098	1277
16	37.19	40.7	2116	40.4	2130	40.6	2119	1289
18	41.84	40.3	2135	40.1	2148	40.3	2138	1300
20	46.49	40.0	2153	39.7	2166	39.9	2155	1311
0	0.00	41.8	2057	42.0	2048	42.0	2048	1248

soil-B with 5% cement and a 10% Moisture Content compressed to 20MPa in 32mm wall thickness mould

		First sample		Second sample		Third sample		
		Pre -	Projected	Pre -	Projected	Pre -	Projected	
Applied	Applied	Ejected	Dry	Ejected	Dry	Ejected	Dry	Average
Pressure	Force	Height	Density	Height	Density	Height	Density	P.D.D.
MPa	kN	mm	kg/m <sup>3</sup>	mm	kg/m <sup>3</sup>	mm	kg/m <sup>3</sup>	kg/m <sup>3</sup>
0	0.00	63.5	1355	63.5	1356	63.7	1352	838
2	4.65	46.3	1857	45.7	1882	46.1	1865	1139
4	9.30	44.3	1944	43.6	1973	43.9	1959	1193
6	13.95	43.1	1998	42.4	2029	42.7	2016	1226
8	18.59	42.2	2039	41.6	2070	41.8	2058	1250
10	23.24	41.6	2067	41.0	2099	41.2	2087	1267
12	27.89	41.2	2091	40.5	2123	40.8	2112	1281
14	32.54	40.8	2110	40.2	2143	40.4	2133	1293
16	37.19	40.5	2127	39.8	2161	40.0	2151	1304
18	41.84	40.2	2140	39.5	2176	39.7	2168	1313
20	46.49	40.0	2154	39.3	2189	39.4	2182	1321
0	0.00	41.3	2081	41.4	2077	41.4	2076	1263

## Second investigation results of pressure density relationship

soil-B with 5% cement and a 6% Moisture Content compressed to 8, 10, 12MPa in 8mm wall thickness mould

		First sample		Second sample		Third sample		
Applied Pressure	Applied Force	Pre - Ejected Height	Projected Dry Density	Pre - Ejected Height	Projected Dry Density	Pre - Ejected Height	Projected Dry Density	Average P.D.D.
MPa	kN	mm	kg/m <sup>3</sup>	mm	kg/m <sup>3</sup>	mm	kg/m <sup>3</sup>	kg/m <sup>3</sup>
0	0.00	62.5	1377	63.0	1366	65.0	1324	1355
2	4.65	47.4	1815	46.6	1846	49.3	1747	1803
4	9.30	45.1	1908	44.4	1939	47.1	1827	1892
6	13.95	43.6	1972	43.0	1999	45.8	1878	1950
8	18.59	42.9	2007	42.1	2042	44.9	1915	1988
10	23.24	42.3	2036	41.5	2072	44.3	1943	2017
12	27.89	41.7	2062	41.0	2098	43.7	1967	2042
0	0.00	43.4	1983	43.7	1969	44.6	1929	1960
0	0.00	62.8	1370	63.6	1353	63.6	1353	1359
0.5	1.16	51.8	1662	52.8	1631	53.2	1617	1637
1	2.32	49.1	1752	50.1	1719	50.5	1704	1725
2	4.65	46.9	1834	47.5	1810	48.2	1785	1809
3	6.97	45.6	1885	46.2	1862	46.9	1836	1861
4	9.30	44.6	1928	45.3	1899	45.9	1874	1900
6	13.95	43.2	1994	44.0	1955	44.5	1933	1960
8	18.59	42.3	2035	43.1	1996	43.6	1973	2001
10	23.24	41.6	2067	42.5	2027	42.9	2005	2033
0	0.00	43.4	1983	44.2	1947	44.6	1929	1953
0	0.00	61.8	1392	62.8	1370	63.6	1353	1372
0.5	1.16	51.4	1675	52.2	1647	52.6	1635	1652
1	2.32	48.7	1766	49.3	1745	50.0	1721	1744
2	4.65	46.3	1858	46.9	1835	47.5	1812	1835
3	6.97	45.0	1913	45.5	1891	46.2	1864	1889
4	9.30	44.1	1951	44.5	1932	45.3	1900	1928
6	13.95	42.8	2011	43.2	1993	44.0	1956	1987
8	18.59	41.9	2054	42.2	2039	43.1	1999	2030
0	0.00	44.3	1942	44.6	1929	44.6	1929	1934

### Third investigation results of pressure density relationship

soil-B with 5% cement and a 6% Moisture Content compressed to 4, 6, 8, 10, 12MPa in 8mm wall thickness mould

Applied Pressure MPa	Energy Transfer J	Ejection Force kN	Ejected Height mm	P.D.D. kg/m <sup>3</sup>	Bulk Density kg/m <sup>3</sup>	7-day W.C.S. kN	7-day W.C.S. MPa
12	111	1.2	43.4	1983	2102	4.11	1.77
12	111	1.2	43.7	1969	2087	4.60	1.98
12	111	1.2	44.6	1929	2045	5.59	2.40
10	97	1.1	43.8	1965	2082	4.95	2.13
10	97	1.1	44.2	1947	2064	4.28	1.84
10	97	1.1	44.4	1938	2054	3.82	1.64
8	83	1.1	44.3	1942	2059	3.65	1.57
8	83	1.1	44.6	1929	2045	3.83	1.65
8	83	1.1	44.8	1921	2036	3.58	1.54
6	70	0.4	44.6	1929	2045	3.24	1.39
6	70	0.5	44.7	1925	2041	3.76	1.62
6	70	0.6	44.9	1916	2031	3.69	1.59
4	54	0.5	45.3	1900	2013	3.36	1.44
4	54	0.5	45.9	1875	1987	2.89	1.24
4	54	0.5	46.2	1863	1974	2.87	1.23

### Density, strength and ejection force variation for cylindrical samples

All samples compressed to 10MPa using soil-B (5% cement) at 6% M.C. in 8 mm wall mould

	Units	Batch	Order in batch		
			First	Second	Third
Ejection force	kN	1	0.64	1.22	1.23
Ejection force	kN	2	0.90	0.88	1.21
Ejection force	kN	3	0.90	0.96	0.99
Ejection force	kN	4	1.13	1.00	1.06
Ejection force	kN	5	1.04	1.22	1.14
Ejection force	kN	6	1.10	1.12	1.16
Average	kN		0.95	1.07	1.13
Standard deviation	kN		0.18	0.14	0.09
Coefficient of variation	%		18.9%	13.4%	8.0%
Ejected height	mm	1	44.1	44.3	44.8
Ejected height	mm	2	44.2	44.6	44.5
Ejected height	mm	3	44.5	44.8	44.6
Ejected height	mm	4	44.0	44.2	44.3
Ejected height	mm	5	44.0	44.0	44.3
Ejected height	mm	6	44.0	44.5	44.4
Average	mm		44.1	44.4	44.5
Standard deviation	mm		0.20	0.29	0.19
Coefficient of variation	%		0.4%	0.7%	0.4%
P.D.D.	kg/m <sup>3</sup>	1	1951	1942	1921
P.D.D.	kg/m <sup>3</sup>	2	1947	1929	1934
P.D.D.	kg/m <sup>3</sup>	3	1934	1921	1929
P.D.D.	kg/m <sup>3</sup>	4	1956	1947	1942
P.D.D.	kg/m <sup>3</sup>	5	1956	1956	1942
P.D.D.	kg/m <sup>3</sup>	6	1956	1934	1938
Average	kg/m <sup>3</sup>		1950	1938	1934
Standard deviation	kg/m <sup>3</sup>		9	13	8
Coefficient of variation	%		0.4%	0.7%	0.4%
7-day W.C.S.	MPa	1	1.80	1.63	1.45
7-day W.C.S.	MPa	2	1.72	1.52	1.63
7-day W.C.S.	MPa	3	1.64	1.53	1.53
7-day W.C.S.	MPa	4	1.72	1.76	1.68
7-day W.C.S.	MPa	5	1.77	1.77	1.74
7-day W.C.S.	MPa	6	1.91	1.48	1.72
Average	MPa		1.76	1.61	1.63
Standard deviation	MPa		0.09	0.13	0.11
Coefficient of variation	%		5.3%	7.8%	7.0%

## Indirect and direct compaction experimental results

All samples compacted at 6% M.C.

Indirect Dynamic Compaction						
Number	Impactor	Drop	Total	Energy	Ejected	P.D.D.
of blows	Mass	Height	Energy		Height	
	kg	m	J	J/kg	mm	kg/m <sup>3</sup>
8	2.5	0.26	51	255	49.5	1738
8	2.5	0.26	51	255	49.6	1735
8	2.5	0.26	51	255	49.7	1731
16	2.5	0.26	102	510	47.6	1808
16	2.5	0.26	102	510	47.6	1808
16	2.5	0.26	102	510	47.4	1815
32	2.5	0.26	204	1020	46.2	1863
32	2.5	0.26	204	1020	46.2	1863
32	2.5	0.26	204	1020	46.1	1867
Direct Dynamic Compaction						
8	2.5	0.2	39	196	45.6	1887
8	2.5	0.2	39	196	45.8	1879
8	2.5	0.2	39	196	46.0	1871
16	2.5	0.2	78	392	43.4	1983
16	2.5	0.2	78	392	44.5	1934
16	2.5	0.2	78	392	44.8	1921
32	2.5	0.2	157	785	43.0	2001
32	2.5	0.2	157	785	42.7	2015
32	2.5	0.2	157	785	43.2	1992

## Appendix G - Numerical results of full size blocks

### Block data for 12 full-size blocks of varying moisture content

Block production using Bre-pak block press with soil-A and 10MPa pressure

Block Label	Units	3.1	3.2	3.3	4.1	4.2	4.3
Pre wetted soil mass	g	8200	8200	8200	8200	8200	8200
Moisture content	%	0.9	0.9	0.9	0.9	0.9	0.9
Soil mass	g	8126	8126	8126	8126	8126	8126
Water mass	g	74	74	74	74	74	74
Added cement mass	g	446	446	446	451	451	451
Added water mass	g	267	267	267	360	360	360
Total solid mass	g	8572	8572	8572	8577	8577	8577
Moisture content	%	4	4	4	5	5	5
Cement content	%	5.2	5.2	5.2	5.3	5.3	5.3

Block height	mm	113.1	113.1	112.8	112.5	111.9	113.5
Ejected bulk density	kg/m <sup>3</sup>	1941	1941	1946	1973	1983	1955
Apparent dry density	kg/m <sup>3</sup>	1867	1867	1872	1878	1888	1861

Curing period	Days	7	7	7	7	7	7
Soaking period	Hours	20	20	20	20	20	20
Compression rate	kN/min	2	5	5	5	5	5
Wet compressive strength	MPa	0.91	0.96	0.88	1.49	1.47	1.54
Calculated 7-day W.C.S.	MPa	0.85	0.90	0.82	1.39	1.37	1.44

Block Label	Units	5.1	5.2	5.3	6.1	6.2	6.3
Pre wetted soil mass	g	8443	8443	8443	8443	8443	8443
Moisture content	%	3.75	3.75	3.75	3.75	3.75	3.75
Soil mass	g	8126	8126	8126	8126	8126	8126
Water mass	g	317	317	317	317	317	317
Added cement mass	g	446	446	446	446	446	446
Added water mass	g	201	201	201	287	287	287
Total solid mass	g	8572	8572	8572	8572	8572	8572
Moisture content	%	6	6	6	7	7	7
Cement content	%	5.2	5.2	5.2	5.2	5.2	5.2

Block height	mm	112.2	112.3	112.1	112.4	112.1	111.2
Ejected bulk density	kg/m <sup>3</sup>	1995	1994	1997	2011	2016	2032
Apparent dry density	kg/m <sup>3</sup>	1882	1880	1883	1878	1883	1899

Curing period	Days	7	7	7	7	7	7
Soaking period	Hours	20	20	20	20	20	20
Compression rate	kN/min	5	10	10	10	10	10
Wet compressive strength	MPa	2.15	2.29	2.31	2.57	2.51	2.37
Calculated 7-day W.C.S.	MPa	2.01	2.14	2.16	2.40	2.35	2.21

### Block data for 7 full-size blocks of varying moisture content

Block production using Bre-pak block press with soil-A and 10MPa pressure

Moisture Content	%	2.0%	3.1%	4.2%	5.3%	6.4%	7.5%	8.7%
Mass of wet soil	g	8200	8200	8200	8200	8200	8200	8200
Mass of added water	g	117	203	290	380	471	564	660
Block height	mm	110.3	110.2	110.3	109.7	109.1	109.7	108.4
Bulk Density	kg/m <sup>3</sup>	1857	1878	1896	1926	1958	1968	2013
Projected Dry Density	kg/m <sup>3</sup>	1831	1833	1831	1841	1851	1841	1863
T.C.	MPa	0.45	>0.45	>0.45	0.43	0.30	0.23	0.23
T.O.D.	MPa	0.40	>0.45	>0.45	0.43	0.25	0.20	0.15
S.C.	MPa	>0.45	>0.45	>0.45	0.43	0.23	0.23	0.20
S.O.D.U	MPa	>0.45	>0.45	>0.45	0.40	0.25	0.18	0.15
S.O.D.L	MPa	>0.45	>0.45	>0.45	0.45	0.33	0.25	0.18
E.C.	MPa	>0.45	>0.45	>0.45	0.45	0.33	0.23	0.20
B.C.	MPa	0.45	>0.45	>0.45	0.40	0.30	0.25	0.18
Penetrometer Average	MPa	N/A	N/A	N/A	0.43	0.28	0.22	0.18
Standard Deviation	MPa	N/A	N/A	N/A	0.02	0.04	0.03	0.03
Coefficient of variation	%	N/A	N/A	N/A	4.8%	14.2%	12.1%	15.3%

#### Key to abbreviations

Top Centre	T.C.
Top Offset Diagonal	T.O.D.
Side Centre	S.C.
Side Offset Diagonal Upper	S.O.D.U.
Side Offset Diagonal Lower	S.O.D.L.
End Centre	E.C.
Bottom Centre	B.C.

\*\*\*\*\*Put in some block data for dynamically compacted blocks\*\*\*\*\*



## Appendix H - Field trial results

### Block production using different machines during visit to India

<b>Balram</b>								
<b>Wet Block Tests</b>	M.C.	12.2%						
Block label	n/a	11w	12w	13w	14w	15w	16w	
Block Mass		3.69	3.8	3.76	3.73	3.86	3.82	
Total volume	m <sup>3</sup>	0.001834	0.001878	0.001872	0.001836	0.001899	0.001858	
Block Bulk Density	kg/m <sup>3</sup>	2012	2023	2008	2031	2032	2056	
P.D.D.	kg/m <sup>3</sup>	1794	1804	1791	1811	1812	1833	
Average Indentation	mm	21.4	19.8	19.3	19.4	18.4	17.8	
After 9 days curing and 24hours under water the following tests were conducted								
Average indentation	mm	12.5		12.5	11.5		11.625	
Wet Block mass	kg	3.86		3.94	3.89		3.97	
Total volume	m <sup>3</sup>	0.001853		0.001887	0.001854		0.001872	
Block wet Density	kg/m <sup>3</sup>	2083		2088	2098		2120	
Wet compressive strength	kN	40		40	40		50	
	MPa	2.1		2.1	2.1		2.6	
<b>Dry Block Tests</b>								
	M.C.	12.2%						
Block label	n/a	17d	18d	19d	20d	21d	22d	23
Block Mass		3.74	3.7	3.76	3.76	3.84	3.79	3.96
Total volume	m <sup>3</sup>	0.001873	0.001846	0.001875	0.001845	0.001911	0.001867	0.001929
Block Bulk Density	kg/m <sup>3</sup>	1997	2004	2005	2038	2010	2030	2052
P.D.D.	kg/m <sup>3</sup>	1781	1787	1788	1817	1792	1810	1830
Average Indentation	mm	21.4	19.8	19.3	19.4	18.4	17.8	17.5
After 9 days curing and 24hours in an oven at 105°C the following tests were conducted								
Average indentation	mm				7.8	6.9	7.1	6.9
Dry Block mass	kg				3.43	3.45	3.43	3.56
Total volume	m <sup>3</sup>				0.001847	0.001912	0.001869	0.001928
Block Dry Density	kg/m <sup>3</sup>				1858	1804	1835	1847
Dry compressive strength	kN				90	160	100	170
	MPa				4.7	8.4	5.2	8.9

<b>Hydraform</b>							
<b>Wet Block Tests</b>							
Block label	n/a	1w	2w	3w	4w	5w	6w
Block Mass		10.7	10.7	10.55	10.8	10.55	10.6
Total volume	m <sup>3</sup>	0.005798	0.005753	0.005671	0.005771	0.005629	0.005683
Block Bulk Density	kg/m <sup>3</sup>	1846	1860	1860	1871	1874	1865
P.D.D.	kg/m <sup>3</sup>	1683	1696	1696	1706	1709	1701
Average Indentation	mm	17.5	17.5	16.5	17.4	16.8	17.3
After 6 days curing and 24hours under water the following tests were conducted							
Average Indentation	mm	11.4		11.1		10.9	
Wet Block mass	kg	11.25		11.05		11.02	
Total volume	m <sup>3</sup>	0.005797		0.005624		0.005625	
Block wet Density	kg/m <sup>3</sup>	1941		1965		1959	
Wet compressive strength	kN	35		35		40	
	MPa	1.5		1.5		1.7	
<b>Dry Block Tests</b>							
Block label	n/a	1d	2d	3d	4d	5d	6d
Block Mass		10.6	10.9	10.55	10.6	10.25	10.25
Total volume	m <sup>3</sup>	0.00592	0.006045	0.005849	0.005715	0.005579	0.005529
Block Bulk Density	kg/m <sup>3</sup>	1790	1803	1804	1855	1837	1854
P.D.D.	kg/m <sup>3</sup>	1633	1644	1645	1691	1675	1690
Average Indentation	mm	18.0	17.6	17.9	17.6	18.9	17.4
After 6 days curing and 24hours in an oven at 105°C the following tests were conducted							
Average Indentation	mm	8.6		8.2		8.6	
Dry Block mass	kg	10		9.95		9.68	
Total volume	m <sup>3</sup>	0.005916		0.005838		0.005562	
Block Dry Density	kg/m <sup>3</sup>	1690		1704		1740	
Dry compressive strength	kN	60		75		75	
	MPa	2.5		3.1		3.1	

<b>Block Impacterre</b>						
<b>Wet Block Tests</b>	M.C.	8.5%				
Block label	n/a	1w	2w	3w	4w	5w
Block Mass			6.95	7.9	8.15	8.1
Total volume	m <sup>3</sup>		0.003506	0.00405	0.004263	0.00418
Block Bulk Density	kg/m <sup>3</sup>		1982	1951	1912	1938
P.D.D.	kg/m <sup>3</sup>		1826	1797	1761	1785
Average Indentation	mm		18.3	20.0	20.3	19.3
After 6 days curing and 24hours under water the following tests were conducted						
Average Indentation	mm		9.5	9.75	10.375	
Wet Block mass	kg		7.25	8.25	8.65	
Total volume	m <sup>3</sup>		0.003469	0.004022	0.004237	
Block wet Density	kg/m <sup>3</sup>		2090	2051	2042	
Wet compressive strength	kN		140	120	95	
	MPa		4.2	3.6	2.9	
<b>Dry Block Tests</b>	M.C.	8.5%				
Block label	n/a	7d	8d	9d		
Block Mass		8.4	7.8	8.4		
Total volume	m <sup>3</sup>	0.004312	0.004114	0.004274		
Block Bulk Density	kg/m <sup>3</sup>	1948	1896	1966		
P.D.D.	kg/m <sup>3</sup>	1795	1747	1811		
Average Indentation	mm	19.1	19.0	19.1		
After 6 days curing and 24hours in an oven at 105°C the following tests were conducted						
Average Indentation	mm	7.75	7.375	7.125		
Dry Block mass	kg	7.95	7.4	7.95		
Total volume	m <sup>3</sup>	0.004252	0.004073	0.004221		
Block Dry Density	kg/m <sup>3</sup>	1870	1817	1883		
Dry compressive strength	kN	240	200	275		
	MPa	7.2	6.0	8.3		

## Supplementary test results sent to UK by the collaborators

### 7 DAY TEST RESULTS OF THE BLOCKS OF THE IMPACTERRE MACHINE AND HYDRAFORM

All blocks soaked for 48 hours in water prior to Wet Compressive Strength test

BLOCK IMPACTERRE MACHINE		SOIL :-	65%
SOIL SAMPLE CODE :-	703/Del/118/2001	SAND :-	30%
Date of Production :-	25/09/2001	CEMENT :-	5%
Date of Testing :-	03/10/2001	WATER :-	10%

Sl. No.	Block Length	Block Width	Loading Area	Wet Weight	Indentation Diameter	Failure Load	Block Strength
	cm	cm	cm	kg	mm	(kN)	MPa
1	29.00	14.24	412.96	7.580	7.40	170.00	4.12
2	29.96	14.25	426.81	7.560	8.00	185.00	4.33
3	29.60	14.30	423.28	7.500	8.00	200.00	4.73
4	29.60	14.30	423.28	7.690	8.10	195.00	4.61
5	29.40	14.30	420.42	7.450	7.50	225.00	5.35
Average	29.51	14.28	421.35	7.56	7.80	195.00	4.63
C. of. V	1.2%	0.2%	1.2%	1.2%	4.2%	10.4%	10.1%

BLOCK IMPACTERRE MACHINE		SOIL :-	63%
SOIL SAMPLE CODE :-	703/Del/118/2001	SAND :-	30%
Date of Production :-	26/09/2001	CEMENT :-	7%
Date of Testing :-	03/10/2001	WATER :-	10%

Sl. No.	Block Length	Block Width	Loading Area	Wet Weight	Indentation Diameter	Failure Load	Block Strength
	cm	cm	cm	kg	mm	(kN)	MPa
1	29.52	14.34	423.32	7.440	7.00	250.00	5.91
2	29.30	14.32	419.58	7.760	7.00	220.00	5.24
3	29.80	14.30	426.14	7.800	6.80	205.00	4.81
4	29.80	14.32	426.74	7.380	6.50	240.00	5.62
5	29.50	14.34	423.03	7.280	7.00	265.00	6.26
Average	29.58	14.32	423.76	7.53	6.86	236.00	5.57
C. of. V	0.7%	0.1%	0.7%	3.1%	3.2%	10.1%	10.2%

## 7 DAY TEST RESULTS OF THE BLOCKS OF THE IMPACTERRE MACHINE AND HYDRAFORM

All blocks soaked for 48 hours in water prior to Wet Compressive Strength test

HYDRAFORM MACHINE SOIL :- 65%  
 SOIL SAMPLE CODE :- 703/Del/118/2001 SAND :- 30%  
 Date of Production :- 28/09/2001 CEMENT :- 5%  
 Date of Testing :- 05/10/2001 WATER :- 10%

Sl. No.	Block Length cm	Block Width cm	Loading Area cm	Wet Weight kg	Indentation Diameter mm	Failure Load (kN)	Block Strength MPa
1	21.23	10.00	212.30	11.030	6.00	65.00	3.06
2	21.20	10.00	212.00	11.020	6.80	70.00	3.30
3	21.48	10.00	214.80	11.120	7.00	75.00	3.49
4	21.37	10.00	213.70	11.050	7.80	70.00	3.28
5	21.88	10.00	218.80	11.335	7.00	65.00	2.97
Average	21.43	10.00	214.32	11.11	6.92	69.00	3.22
C. of. V	1.3%	0.0%	1.3%	1.2%	9.3%	6.1%	6.4%

HYDRAFORM MACHINE SOIL :- 63%  
 SOIL SAMPLE CODE :- 703/Del/118/2001 SAND :- 30%  
 Date of Production :- 28/09/2001 CEMENT :- 7%  
 Date of Testing :- 05/10/2001 WATER :- 10%

Sl. No.	Block Length cm	Block Width cm	Loading Area cm	Wet Weight kg	Indentation Diameter mm	Failure Load (kN)	Block Strength MPa
1	21.48	10.00	214.80	11.110	5.50	80.00	3.72
2	21.90	10.00	219.00	11.355	5.80	80.00	3.65
3	21.76	10.00	217.60	11.250	6.00	85.00	3.91
4	21.90	10.00	219.00	11.350	6.00	85.00	3.88
5	22.05	10.00	220.50	11.400	6.20	85.00	3.85
Average	21.82	10.00	218.18	11.29	5.90	83.00	3.80
C. of. V	1.0%	0.0%	1.0%	1.0%	4.5%	3.3%	2.9%

## 28 DAY TEST RESULTS OF THE BLOCKS OF THE IMPACTERRE MACHINE AND HYDRAFORM

All blocks soaked for 48 hours in water prior to Wet Compressive Strength test

BLOCK IMPACTERRE MACHINE			SOIL :-	65%
SOIL SAMPLE CODE :-	703/Del/118/2001	SAND :-	30%	
Date of Production :-	25/09/2001	CEMENT :-	5%	
Date of Testing :-	22/10/2001	WATER :-	10%	

Sl. No.	Block Length cm	Block Width cm	Block Height cm	Loading Area cm	Wet Weight kg	Wet Density kg/m <sup>3</sup>	Indentation Diameter mm	Failure Load (kN)	Block Strength MPa
1	29.06	14.30	8.25	415.56	7.240	2112	7.60	295.00	7.10
2	29.02	14.27	8.71	414.12	7.630	2115	7.70	295.00	7.12
3	29.06	14.13	8.87	410.62	7.685	2110	8.10	235.00	5.72
4	28.90	14.23	8.74	411.25	7.580	2109	7.00	260.00	6.32
5	28.89	14.13	8.80	408.22	7.600	2116	7.20	240.00	5.88
Average	28.99	14.21	8.67	411.95	7.55	2112.34	7.52	265.00	6.43
C. of. V	0.3%	0.6%	2.8%	0.7%	2.3%	0.1%	5.8%	10.9%	10.3%

BLOCK IMPACTERRE MACHINE			SOIL :-	63%
SOIL SAMPLE CODE :-	703/Del/118/2001	SAND :-	30%	
Date of Production :-	26/09/2001	CEMENT :-	7%	
Date of Testing :-	23/10/2001	WATER :-	10%	

Sl. No.	Block Length cm	Block Width cm	Block Height cm	Loading Area cm	Wet Weight kg	Wet Density kg/m <sup>3</sup>	Indentation Diameter mm	Failure Load (kN)	Block Strength MPa
1	28.90	14.29	9.53	412.98	8.100	2058	7.90	180.00	4.36
2	29.10	14.20	9.20	413.22	7.750	2039	7.10	245.00	5.93
3	28.94	14.29	9.50	413.55	7.970	2029	8.00	200.00	4.84
4	28.90	14.25	8.57	411.83	7.430	2105	6.00	325.00	7.89
5	28.90	14.23	9.10	411.25	7.765	2075	6.00	245.00	5.96
Average	28.95	14.25	9.18	412.57	7.80	2061.09	7.00	239.00	5.79
C. of. V	0.3%	0.3%	4.2%	0.2%	3.3%	1.5%	14.0%	23.4%	23.5%

## 28 DAY TEST RESULTS OF THE BLOCKS OF THE IMPACTERRE MACHINE AND HYDRAFORM

All blocks soaked for 48 hours in water prior to Wet Compressive Strength test

HYDRAFORM MACHINE SOIL :- 65%  
 SOIL SAMPLE CODE :- 703/Del/118/2001 SAND :- 30%  
 Date of Production :- 28/09/2001 CEMENT :- 5%  
 Date of Testing :- 05/10/2001 WATER :- 10%

Sl. No.	Block Length cm	Block Width cm	Loading Area cm	Wet Weight kg	Indentation Diameter mm	Failure Load (kN)	Block Strength MPa
1	21.60	10.00	216.00	11.240	9.00	80.00	3.70
2	21.30	10.00	213.00	11.100	8.00	80.00	3.76
3	21.30	10.00	213.00	11.135	8.00	80.00	3.76
4	21.10	10.00	211.00	11.040	6.00	80.00	3.79
5	21.60	10.00	216.00	11.220	8.00	80.00	3.70
Average	21.38	10.00	213.80	11.15	7.80	80.00	3.74
C. of. V	1.0%	0.0%	1.0%	0.7%	14.0%	0.0%	1.0%

HYDRAFORM MACHINE SOIL :- 63%  
 SOIL SAMPLE CODE :- 703/Del/118/2001 SAND :- 30%  
 Date of Production :- 28/09/2001 CEMENT :- 7%  
 Date of Testing :- 27/10/2001 WATER :- 10%

Sl. No.	Block Length cm	Block Width cm	Loading Area cm	Wet Weight kg	Indentation Diameter mm	Failure Load (kN)	Block Strength MPa
1	21.60	10.00	216.00	11.200	7.70	110.00	5.09
2	21.60	10.00	216.00	11.215	7.00	110.00	5.09
3	21.80	10.00	218.00	11.315	7.00	115.00	5.28
4	21.70	10.00	217.00	11.280	7.00	120.00	5.53
5	21.50	10.00	215.00	11.160	6.80	125.00	5.81
Average	21.64	10.00	216.40	11.23	7.10	116.00	5.36
C. of. V	0.5%	0.0%	0.5%	0.6%	4.9%	5.6%	5.8%





<b>Block Impacterre</b>		<b>STABILISED</b>						
Total weight of each Mix =		<b>70 Kg</b>		<b>With 5% Cement</b>				
Water =	<b>7.00 Kg</b>							
<b>BATCH 3</b>	<b>M.C. =</b>	<b>11.41%</b>						
	<b>Block</b>	<b>Block</b>	<b>Block</b>	<b>Block</b>	<b>Block</b>	<b>Bulk</b>	<b>Indentation</b>	
	<b>Length</b>	<b>Width</b>	<b>Height</b>	<b>Volume</b>	<b>Mass</b>	<b>Density</b>	<b>P.D.D.</b>	<b>Diameter</b>
Block No.	<b>(cm)</b>	<b>(cm)</b>	<b>(cm)</b>	<b>(m3)</b>	<b>(kg)</b>	<b>(kg/m<sup>3</sup>)</b>	<b>(kg/m<sup>3</sup>)</b>	<b>(mm)</b>
1	28.930	14.240	8.360	0.003444	7.180	2085	1871	16.60
2	28.940	14.240	8.610	0.003548	7.300	2057	1847	16.00
3	28.820	14.170	8.680	0.003545	7.250	2045	1836	17.63
4	28.851	14.160	8.620	0.003522	7.270	2064	1853	18.30
5	28.860	14.240	8.640	0.003551	7.360	2073	1861	17.40
6	28.800	14.150	8.620	0.003513	7.300	2078	1865	16.08
7	28.854	14.130	8.700	0.003547	7.250	2044	1835	18.00
8	28.820	14.160	8.660	0.003534	7.350	2080	1867	15.30
9	28.820	14.000	8.810	0.003555	7.320	2059	1848	17.40
10	28.720	14.050	9.130	0.003684	7.490	2033	1825	18.50
<b>Avg.</b>	<b>28.842</b>	<b>14.154</b>	<b>8.683</b>	<b>0.003544</b>	<b>7.307</b>	<b>2062</b>	<b>1851</b>	<b>17.12</b>
<b>S.D.</b>	<b>0.063</b>	<b>0.080</b>	<b>0.193</b>	<b>0.00006</b>	<b>0.083</b>	<b>17.280</b>	<b>15.510</b>	<b>1.075</b>
<b>C. of V.</b>	<b>0.22%</b>	<b>0.57%</b>	<b>2.23%</b>	<b>1.67%</b>	<b>1.14%</b>	<b>0.84%</b>	<b>0.84%</b>	<b>6.28%</b>
<b>BATCH 4</b>	<b>M.C. =</b>	<b>11.01%</b>						
	<b>Block</b>	<b>Block</b>	<b>Block</b>	<b>Block</b>	<b>Block</b>	<b>Bulk</b>	<b>Indentation</b>	
	<b>Length</b>	<b>Width</b>	<b>Height</b>	<b>Volume</b>	<b>Mass</b>	<b>Density</b>	<b>P.D.D.</b>	<b>Diameter</b>
Block No.	<b>(cm)</b>	<b>(cm)</b>	<b>(cm)</b>	<b>(m3)</b>	<b>(kg)</b>	<b>(kg/m<sup>3</sup>)</b>	<b>(kg/m<sup>3</sup>)</b>	<b>(mm)</b>
1	28.850	14.090	8.200	0.003333	7.250	2175	1959	16.10
2	28.880	14.070	8.500	0.003454	7.340	2125	1914	14.00
3	28.880	14.090	8.410	0.003422	7.240	2116	1906	16.90
4	28.850	14.070	8.570	0.003479	7.340	2110	1901	15.64
5	28.820	14.010	8.600	0.003472	7.430	2140	1928	13.50
6	28.800	14.020	8.700	0.003513	7.550	2149	1936	12.70
7	28.870	14.050	8.620	0.003496	7.400	2116	1907	14.30
8	28.830	14.080	8.740	0.003548	7.400	2086	1879	15.20
9	28.820	14.040	8.840	0.003577	7.560	2114	1904	14.80
10	28.800	14.100	8.820	0.003582	7.460	2083	1876	15.50
<b>Avg.</b>	<b>28.840</b>	<b>14.062</b>	<b>8.600</b>	<b>0.003488</b>	<b>7.397</b>	<b>2121</b>	<b>1911</b>	<b>14.86</b>
<b>S.D.</b>	<b>0.031</b>	<b>0.031</b>	<b>0.195</b>	<b>0.00008</b>	<b>0.109</b>	<b>27.903</b>	<b>25.135</b>	<b>1.265</b>
<b>C. of V.</b>	<b>0.11%</b>	<b>0.22%</b>	<b>2.27%</b>	<b>2.15%</b>	<b>1.48%</b>	<b>1.32%</b>	<b>1.32%</b>	<b>8.51%</b>

<b>Block Impacterre</b>		<b>STABILISED</b>						
Total weight of each Mix =		<b>70 Kg</b>		<b>With 7% Cement</b>				
Water =	<b>7.00 Kg</b>							
<b>BATCH 1</b>	<b>M.C. =</b>	<b>10.22%</b>						
	<b>Block</b>	<b>Block</b>	<b>Block</b>	<b>Block</b>	<b>Block</b>	<b>Bulk</b>		<b>Indentation</b>
	<b>Length</b>	<b>Width</b>	<b>Height</b>	<b>Volume</b>	<b>Mass</b>	<b>Density</b>	<b>P.D.D.</b>	<b>Diameter</b>
Block No.	<b>(cm)</b>	<b>(cm)</b>	<b>(cm)</b>	<b>(m3)</b>	<b>(kg)</b>	<b>(kg/m<sup>3</sup>)</b>	<b>(kg/m<sup>3</sup>)</b>	<b>(mm)</b>
1	28.890	14.160	8.290	0.003391	7.220	2129	1932	12.20
2	28.890	14.180	8.460	0.003466	7.350	2121	1924	17.10
3	28.850	14.080	8.670	0.003522	7.450	2115	1919	17.30
4	28.850	14.170	8.770	0.003585	7.440	2075	1883	16.20
5	28.800	14.110	8.830	0.003588	7.560	2107	1912	17.00
6	28.700	14.170	8.900	0.003619	7.530	2080	1888	14.30
7	28.890	14.230	9.130	0.003753	7.540	2009	1823	15.30
8	28.880	14.200	9.400	0.003855	7.630	1979	1796	17.80
9	28.890	14.130	9.430	0.003849	7.620	1979	1796	16.90
10	29.000	14.190	7.600	0.003127	7.480	2392	2170	13.00
<b>Avg.</b>	<b>28.864</b>	<b>14.162</b>	<b>8.748</b>	<b>0.003576</b>	<b>7.482</b>	<b>2066</b>	<b>1875</b>	<b>16.49</b>
<b>S.D.</b>	<b>0.077</b>	<b>0.044</b>	<b>0.546</b>	<b>0.00022</b>	<b>0.133</b>	<b>60.865</b>	<b>55.221</b>	<b>1.163</b>
<b>C. of V.</b>	<b>0.27%</b>	<b>0.31%</b>	<b>6.24%</b>	<b>6.16%</b>	<b>1.78%</b>	<b>2.95%</b>	<b>2.95%</b>	<b>7.05%</b>
<b>BATCH 2</b>	<b>M.C. =</b>	<b>10.58%</b>						
	<b>Block</b>	<b>Block</b>	<b>Block</b>	<b>Block</b>	<b>Block</b>	<b>Bulk</b>		<b>Indentation</b>
	<b>Length</b>	<b>Width</b>	<b>Height</b>	<b>Volume</b>	<b>Mass</b>	<b>Density</b>	<b>P.D.D.</b>	<b>Diameter</b>
Block No.	<b>(cm)</b>	<b>(cm)</b>	<b>(cm)</b>	<b>(m3)</b>	<b>(kg)</b>	<b>(kg/m<sup>3</sup>)</b>	<b>(kg/m<sup>3</sup>)</b>	<b>(mm)</b>
1	28.830	14.100	8.500	0.003455	7.360	2130	1926	16.40
2	28.980	14.160	8.500	0.003488	7.270	2084	1885	17.00
3	28.920	14.200	8.530	0.003503	7.280	2078	1879	16.50
4	28.840	14.180	8.560	0.003501	7.290	2082	1883	16.20
5	28.890	14.100	8.720	0.003552	7.370	2075	1876	15.00
6	28.890	14.160	8.470	0.003465	7.230	2087	1887	15.80
7	28.890	14.140	8.770	0.003583	7.350	2052	1855	18.20
8	28.840	14.210	8.730	0.003578	7.270	2032	1838	17.50
9	28.860	14.260	8.990	0.003700	7.600	2054	1858	19.20
10	28.900	14.280	8.970	0.003702	7.620	2058	1861	17.20
<b>Avg.</b>	<b>28.884</b>	<b>14.179</b>	<b>8.674</b>	<b>0.003553</b>	<b>7.364</b>	<b>2073</b>	<b>1875</b>	<b>16.90</b>
<b>S.D.</b>	<b>0.045</b>	<b>0.060</b>	<b>0.194</b>	<b>0.00009</b>	<b>0.137</b>	<b>26.653</b>	<b>24.103</b>	<b>1.209</b>
<b>C. of V.</b>	<b>0.16%</b>	<b>0.43%</b>	<b>2.23%</b>	<b>2.52%</b>	<b>1.86%</b>	<b>1.29%</b>	<b>1.29%</b>	<b>7.16%</b>

<b>Block Impacterre</b>		<b>STABILISED</b>						
Total weight of each Mix =		<b>70 Kg</b>		<b>With 7% Cement</b>				
Water =	<b>7.00 Kg</b>							
<b>BATCH 3</b>	<b>M.C. =</b>	<b>10.49%</b>						
	<b>Block</b>	<b>Block</b>	<b>Block</b>	<b>Block</b>	<b>Block</b>	<b>Bulk</b>		<b>Indentation</b>
	<b>Length</b>	<b>Width</b>	<b>Height</b>	<b>Volume</b>	<b>Mass</b>	<b>Density</b>	<b>P.D.D.</b>	<b>Diameter</b>
Block No.	<b>(cm)</b>	<b>(cm)</b>	<b>(cm)</b>	<b>(m3)</b>	<b>(kg)</b>	<b>(kg/m<sup>3</sup>)</b>	<b>(kg/m<sup>3</sup>)</b>	<b>(mm)</b>
1	28.930	14.080	8.420	0.003430	7.140	2082	1884	20.20
2	28.960	14.060	8.660	0.003526	7.220	2048	1853	20.30
3	28.940	14.070	8.670	0.003530	7.290	2065	1869	19.00
4	29.050	14.200	8.740	0.003605	7.250	2011	1820	19.90
5	28.970	14.220	8.524	0.003511	7.180	2045	1851	18.48
6	28.986	14.230	8.810	0.003634	7.370	2028	1836	20.38
7	28.998	14.100	8.908	0.003642	7.440	2043	1849	20.50
8	28.974	14.240	8.818	0.003638	7.350	2020	1828	20.08
9	28.982	14.280	9.110	0.003770	7.510	1992	1803	20.20
10	28.998	14.226	9.420	0.003886	7.660	1971	1784	20.96
<b>Avg.</b>	<b>28.979</b>	<b>14.171</b>	<b>8.808</b>	<b>0.003617</b>	<b>7.341</b>	<b>2030</b>	<b>1838</b>	<b>20.00</b>
<b>S.D.</b>	<b>0.034</b>	<b>0.083</b>	<b>0.289</b>	<b>0.00013</b>	<b>0.161</b>	<b>33.275</b>	<b>30.116</b>	<b>0.731</b>
<b>C. of V.</b>	<b>0.12%</b>	<b>0.59%</b>	<b>3.28%</b>	<b>3.68%</b>	<b>2.19%</b>	<b>1.64%</b>	<b>1.64%</b>	<b>3.66%</b>
<b>BATCH 4</b>	<b>M.C. =</b>	<b>10.16%</b>						
	<b>Block</b>	<b>Block</b>	<b>Block</b>	<b>Block</b>	<b>Block</b>	<b>Bulk</b>		<b>Indentation</b>
	<b>Length</b>	<b>Width</b>	<b>Height</b>	<b>Volume</b>	<b>Mass</b>	<b>Density</b>	<b>P.D.D.</b>	<b>Diameter</b>
Block No.	<b>(cm)</b>	<b>(cm)</b>	<b>(cm)</b>	<b>(m3)</b>	<b>(kg)</b>	<b>(kg/m<sup>3</sup>)</b>	<b>(kg/m<sup>3</sup>)</b>	<b>(mm)</b>
1	28.976	14.230	8.434	0.003478	7.250	2085	1893	20.76
2	29.028	14.260	8.198	0.003393	7.090	2089	1897	21.28
3	29.000	14.250	8.200	0.003389	7.160	2113	1918	18.86
4	28.990	14.300	8.520	0.003532	7.290	2064	1874	21.60
5	28.994	14.288	8.460	0.003505	7.220	2060	1870	20.40
6	28.970	14.220	8.650	0.003563	7.280	2043	1855	20.80
7	28.978	14.220	8.774	0.003615	7.330	2027	1840	21.40
8	28.974	14.208	8.774	0.003612	7.330	2029	1842	20.34
9	28.984	14.294	8.746	0.003623	7.360	2031	1844	20.18
10	29.008	14.244	9.060	0.003744	7.520	2009	1824	21.00
<b>Avg.</b>	<b>28.990</b>	<b>14.251</b>	<b>8.582</b>	<b>0.003545</b>	<b>7.283</b>	<b>2055</b>	<b>1866</b>	<b>20.66</b>
<b>S.D.</b>	<b>0.018</b>	<b>0.033</b>	<b>0.272</b>	<b>0.00011</b>	<b>0.117</b>	<b>32.978</b>	<b>29.936</b>	<b>0.789</b>
<b>C. of V.</b>	<b>0.06%</b>	<b>0.23%</b>	<b>3.17%</b>	<b>3.11%</b>	<b>1.61%</b>	<b>1.60%</b>	<b>1.60%</b>	<b>3.82%</b>

<u>Hydraform Machine</u>			<u>STABILISED</u>					
Total weight of each Mix =			<b>110 Kg</b>	<b>With 5% Cement</b>		<b>Pressure =</b>		<b>85</b>
Water =	<b>11 Kg</b>							
<b>BATCH 1</b>	<b>M.C. =</b>	<b>11.19%</b>						
	<b>Block</b>	<b>Block</b>	<b>Block</b>	<b>Block</b>	<b>Block</b>	<b>Bulk</b>		<b>Indentation</b>
	<b>Length</b>	<b>Width</b>	<b>Height</b>	<b>Volume</b>	<b>Mass</b>	<b>Density</b>	<b>P.D.D.</b>	<b>Diameter</b>
Block No.	(cm)	(cm)	(cm)	(m <sup>3</sup> )	(kg)	(kg/m <sup>3</sup> )	(kg/m <sup>3</sup> )	(mm)
1	21.195	22.100	11.630	0.005448	10.840	1990	1790	19.10
2	21.510	22.100	11.630	0.005529	10.920	1975	1776	21.40
3	21.361	22.100	11.630	0.005490	10.910	1987	1787	21.40
4	21.134	22.100	11.630	0.005432	10.830	1994	1793	19.00
5	20.903	22.100	11.630	0.005373	10.610	1975	1776	17.50
6	21.460	22.100	11.630	0.005516	10.870	1971	1772	17.00
7	21.930	22.100	11.630	0.005637	10.000	1774	1596	16.00
8	21.530	22.100	11.630	0.005534	10.870	1964	1767	15.50
9	21.750	22.100	11.630	0.005590	10.940	1957	1760	16.20
10	21.700	22.100	11.630	0.005577	10.930	1960	1762	16.28
<b>Avg.</b>	<b>21.447</b>	<b>22.100</b>	<b>11.630</b>	<b>0.005512</b>	<b>10.858</b>	<b>1975</b>	<b>1776</b>	<b>17.94</b>
<b>S.D.</b>	<b>0.310</b>	<b>0.000</b>	<b>0.000</b>	<b>0.00008</b>	<b>0.287</b>	<b>64.657</b>	<b>58.150</b>	<b>2.186</b>
<b>C. of V.</b>	<b>1.45%</b>	<b>0.00%</b>	<b>0.00%</b>	<b>1.45%</b>	<b>2.65%</b>	<b>3.27%</b>	<b>3.27%</b>	<b>12.18%</b>
<b>BATCH 2</b>	<b>M.C. =</b>	<b>11.78%</b>						
	<b>Block</b>	<b>Block</b>	<b>Block</b>	<b>Block</b>	<b>Block</b>	<b>Bulk</b>		<b>Indentation</b>
	<b>Length</b>	<b>Width</b>	<b>Height</b>	<b>Volume</b>	<b>Mass</b>	<b>Density</b>	<b>P.D.D.</b>	<b>Diameter</b>
Block No.	(cm)	(cm)	(cm)	(m <sup>3</sup> )	(kg)	(kg/m <sup>3</sup> )	(kg/m <sup>3</sup> )	(mm)
1	21.150	22.100	11.630	0.005436	10.660	1961	1754	20.10
2	22.000	22.100	11.630	0.005655	10.020	1772	1585	21.00
3	21.830	22.100	11.630	0.005611	10.860	1936	1732	20.20
4	21.610	22.100	11.630	0.005554	10.760	1937	1733	18.30
5	21.630	22.100	11.630	0.005559	10.820	1946	1741	18.90
6	21.480	22.100	11.630	0.005521	10.740	1945	1740	18.50
7	21.670	22.100	11.630	0.005570	10.860	1950	1744	16.90
8	21.950	22.100	11.630	0.005642	10.930	1937	1733	16.50
9	21.870	22.100	11.630	0.005621	10.970	1952	1746	17.30
10	21.730	22.100	11.630	0.005585	10.820	1937	1733	15.50
<b>Avg.</b>	<b>21.692</b>	<b>22.100</b>	<b>11.630</b>	<b>0.005575</b>	<b>10.824</b>	<b>1945</b>	<b>1740</b>	<b>18.32</b>
<b>S.D.</b>	<b>0.250</b>	<b>0.000</b>	<b>0.000</b>	<b>0.00006</b>	<b>0.270</b>	<b>55.168</b>	<b>49.354</b>	<b>1.782</b>
<b>C. of V.</b>	<b>1.15%</b>	<b>0.00%</b>	<b>0.00%</b>	<b>1.15%</b>	<b>2.49%</b>	<b>2.84%</b>	<b>2.84%</b>	<b>9.73%</b>

<u>Hydraform Machine</u>			<u>STABILISED</u>					
Total weight of each Mix =			<b>110 Kg</b>	<b>With 5% Cement</b>				
Water =	<b>11 Kg</b>							
<b>BATCH 3</b>	<b>M.C. =</b>	<b>10.19%</b>						
	<b>Block</b>	<b>Block</b>	<b>Block</b>	<b>Block</b>	<b>Block</b>	<b>Bulk</b>		<b>Indentation</b>
	<b>Length</b>	<b>Width</b>	<b>Height</b>	<b>Volume</b>	<b>Mass</b>	<b>Density</b>	<b>P.D.D.</b>	<b>Diameter</b>
Block No.	(cm)	(cm)	(cm)	(m <sup>3</sup> )	(kg)	(kg/m <sup>3</sup> )	(kg/m <sup>3</sup> )	(mm)
1	21.430	22.100	11.630	0.005508	10.850	1970	1788	21.30
2	21.450	22.100	11.630	0.005513	10.840	1966	1784	19.20
3	21.846	22.100	11.630	0.005615	11.050	1968	1786	18.45
4	21.310	22.100	11.630	0.005477	10.750	1963	1781	18.50
5	21.360	22.100	11.630	0.005490	10.790	1965	1784	18.00
6	21.500	22.100	11.630	0.005526	10.850	1963	1782	19.20
7	21.440	22.100	11.630	0.005511	10.810	1962	1780	18.90
8	21.432	22.100	11.630	0.005509	10.870	1973	1791	19.00
9	21.350	22.100	11.630	0.005487	10.810	1970	1788	19.20
10	20.868	22.100	11.630	0.005364	10.630	1982	1799	19.30
<b>Avg.</b>	<b>21.399</b>	<b>22.100</b>	<b>11.630</b>	<b>0.005500</b>	<b>10.825</b>	<b>1968</b>	<b>1786</b>	<b>19.11</b>
<b>S.D.</b>	<b>0.238</b>	<b>0.000</b>	<b>0.000</b>	<b>0.00006</b>	<b>0.105</b>	<b>6.025</b>	<b>5.468</b>	<b>0.879</b>
<b>C. of V.</b>	<b>1.11%</b>	<b>0.00%</b>	<b>0.00%</b>	<b>1.11%</b>	<b>0.97%</b>	<b>0.31%</b>	<b>0.31%</b>	<b>4.60%</b>
<b>BATCH 4</b>	<b>M.C. =</b>	<b>10.79%</b>						
	<b>Block</b>	<b>Block</b>	<b>Block</b>	<b>Block</b>	<b>Block</b>	<b>Bulk</b>		<b>Indentation</b>
	<b>Length</b>	<b>Width</b>	<b>Height</b>	<b>Volume</b>	<b>Mass</b>	<b>Density</b>	<b>P.D.D.</b>	<b>Diameter</b>
Block No.	(cm)	(cm)	(cm)	(m <sup>3</sup> )	(kg)	(kg/m <sup>3</sup> )	(kg/m <sup>3</sup> )	(mm)
1	21.105	22.100	11.630	0.005424	10.720	1976	1784	20.50
2	21.848	22.100	11.630	0.005615	11.040	1966	1775	20.30
3	21.410	22.100	11.630	0.005503	10.930	1986	1793	20.00
4	21.300	22.100	11.630	0.005475	10.750	1964	1772	18.90
5	21.480	22.100	11.630	0.005521	10.870	1969	1777	19.00
6	21.582	22.100	11.630	0.005547	10.820	1951	1761	18.50
7	21.868	22.100	11.630	0.005621	10.980	1954	1763	16.00
8	21.850	22.100	11.630	0.005616	10.980	1955	1765	15.80
9	21.575	22.100	11.630	0.005545	10.860	1958	1768	17.86
10	21.550	22.100	11.630	0.005539	10.810	1952	1762	16.50
<b>Avg.</b>	<b>21.557</b>	<b>22.100</b>	<b>11.630</b>	<b>0.005541</b>	<b>10.876</b>	<b>1963</b>	<b>1772</b>	<b>18.34</b>
<b>S.D.</b>	<b>0.251</b>	<b>0.000</b>	<b>0.000</b>	<b>0.00006</b>	<b>0.105</b>	<b>11.615</b>	<b>10.484</b>	<b>1.751</b>
<b>C. of V.</b>	<b>1.16%</b>	<b>0.00%</b>	<b>0.00%</b>	<b>1.16%</b>	<b>0.97%</b>	<b>0.59%</b>	<b>0.59%</b>	<b>9.55%</b>

<u>Hydraform Machine</u>			<u>STABILISED</u>					
Total weight of each Mix =			<b>110 Kg</b>			<b>With 7% Cement</b>		
Water =	<b>11 Kg</b>							
<b>BATCH 1</b>	<b>M.C. =</b>	<b>11.13%</b>						
	<b>Block</b>	<b>Block</b>	<b>Block</b>	<b>Block</b>	<b>Block</b>	<b>Bulk</b>		<b>Indentation</b>
	<b>Length</b>	<b>Width</b>	<b>Height</b>	<b>Volume</b>	<b>Mass</b>	<b>Density</b>	<b>P.D.D.</b>	<b>Diameter</b>
Block No.	(cm)	(cm)	(cm)	(m <sup>3</sup> )	(kg)	(kg/m <sup>3</sup> )	(kg/m <sup>3</sup> )	(mm)
1	21.480	22.100	11.630	0.005521	10.830	1962	1765	20.50
2	21.550	22.100	11.630	0.005539	10.860	1961	1764	19.10
3	21.400	22.100	11.630	0.005500	10.870	1976	1778	19.80
4	21.830	22.100	11.630	0.005611	11.070	1973	1775	19.22
5	21.824	22.100	11.630	0.005609	11.070	1974	1776	20.30
6	21.930	22.100	11.630	0.005637	11.120	1973	1775	18.20
7	21.800	22.100	11.630	0.005603	11.030	1969	1771	18.00
8	21.628	22.100	11.630	0.005559	10.990	1977	1779	18.00
9	21.780	22.100	11.630	0.005598	11.050	1974	1776	19.20
10	21.540	22.100	11.630	0.005536	10.870	1963	1767	17.30
<b>Avg.</b>	<b>21.676</b>	<b>22.100</b>	<b>11.630</b>	<b>0.005571</b>	<b>10.976</b>	<b>1970</b>	<b>1773</b>	<b>18.96</b>
<b>S.D.</b>	<b>0.179</b>	<b>0.000</b>	<b>0.000</b>	<b>0.00005</b>	<b>0.108</b>	<b>6.099</b>	<b>5.488</b>	<b>1.064</b>
<b>C. of V.</b>	<b>0.82%</b>	<b>0.00%</b>	<b>0.00%</b>	<b>0.82%</b>	<b>0.98%</b>	<b>0.31%</b>	<b>0.31%</b>	<b>5.61%</b>
<b>BATCH 2</b>	<b>M.C. =</b>	<b>11.43%</b>						
	<b>Block</b>	<b>Block</b>	<b>Block</b>	<b>Block</b>	<b>Block</b>	<b>Bulk</b>		<b>Indentation</b>
	<b>Length</b>	<b>Width</b>	<b>Height</b>	<b>Volume</b>	<b>Mass</b>	<b>Density</b>	<b>P.D.D.</b>	<b>Diameter</b>
Block No.	(cm)	(cm)	(cm)	(m <sup>3</sup> )	(kg)	(kg/m <sup>3</sup> )	(kg/m <sup>3</sup> )	(mm)
1	21.366	22.100	11.630	0.005492	10.780	1963	1762	19.23
2	21.300	22.100	11.630	0.005475	10.750	1964	1762	20.40
3	21.750	22.100	11.630	0.005590	10.950	1959	1758	18.86
4	21.328	22.100	11.630	0.005482	10.700	1952	1752	20.54
5	21.824	22.100	11.630	0.005609	10.930	1949	1749	18.26
6	21.850	22.100	11.630	0.005616	10.970	1953	1753	19.50
7	21.470	22.100	11.630	0.005518	10.780	1954	1753	17.66
8	21.582	22.100	11.630	0.005547	10.860	1958	1757	17.75
9	21.360	22.100	11.630	0.005490	10.710	1951	1751	17.30
10	21.574	22.100	11.630	0.005545	10.860	1959	1758	18.20
<b>Avg.</b>	<b>21.540</b>	<b>22.100</b>	<b>11.630</b>	<b>0.005536</b>	<b>10.829</b>	<b>1956</b>	<b>1755</b>	<b>18.77</b>
<b>S.D.</b>	<b>0.209</b>	<b>0.000</b>	<b>0.000</b>	<b>0.00005</b>	<b>0.099</b>	<b>5.126</b>	<b>4.600</b>	<b>1.133</b>
<b>C. of V.</b>	<b>0.97%</b>	<b>0.00%</b>	<b>0.00%</b>	<b>0.97%</b>	<b>0.92%</b>	<b>0.26%</b>	<b>0.26%</b>	<b>6.04%</b>

<u>Hydraform Machine</u>			<u>STABILISED</u>					
Total weight of each Mix =			110 Kg			With 7% Cement		
Water =	11 Kg							
<b>BATCH 3</b>	<b>M.C. =</b>	<b>10.76%</b>						
	<b>Block</b>	<b>Block</b>	<b>Block</b>	<b>Block</b>	<b>Block</b>	<b>Bulk</b>		<b>Indentation</b>
	<b>Length</b>	<b>Width</b>	<b>Height</b>	<b>Volume</b>	<b>Mass</b>	<b>Density</b>	<b>P.D.D.</b>	<b>Diameter</b>
Block No.	(cm)	(cm)	(cm)	(m <sup>3</sup> )	(kg)	(kg/m <sup>3</sup> )	(kg/m <sup>3</sup> )	(mm)
1	22.928	22.100	11.630	0.005893	11.630	1974	1782	20.80
2	21.380	22.100	11.630	0.005495	10.770	1960	1770	19.24
3	21.480	22.100	11.630	0.005521	10.850	1965	1774	19.72
4	21.620	22.100	11.630	0.005557	10.870	1956	1766	18.20
5	21.690	22.100	11.630	0.005575	10.930	1961	1770	18.40
6	21.580	22.100	11.630	0.005547	10.890	1963	1773	18.00
7	21.880	22.100	11.630	0.005624	11.020	1960	1769	19.40
8	21.630	22.100	11.630	0.005559	10.870	1955	1765	16.40
9	21.340	22.100	11.630	0.005485	10.730	1956	1766	17.60
10	21.360	22.100	11.630	0.005490	10.750	1958	1768	18.20
<b>Avg.</b>	<b>21.689</b>	<b>22.100</b>	<b>11.630</b>	<b>0.005575</b>	<b>10.931</b>	<b>1961</b>	<b>1770</b>	<b>18.60</b>
<b>S.D.</b>	<b>0.467</b>	<b>0.000</b>	<b>0.000</b>	<b>0.00012</b>	<b>0.261</b>	<b>5.487</b>	<b>4.954</b>	<b>1.234</b>
<b>C. of V.</b>	<b>2.15%</b>	<b>0.00%</b>	<b>0.00%</b>	<b>2.15%</b>	<b>2.38%</b>	<b>0.28%</b>	<b>0.28%</b>	<b>6.64%</b>
<b>BATCH 4</b>	<b>M.C. =</b>	<b>11.39%</b>						
	<b>Block</b>	<b>Block</b>	<b>Block</b>	<b>Block</b>	<b>Block</b>	<b>Bulk</b>		<b>Indentation</b>
	<b>Length</b>	<b>Width</b>	<b>Height</b>	<b>Volume</b>	<b>Mass</b>	<b>Density</b>	<b>P.D.D.</b>	<b>Diameter</b>
Block No.	(cm)	(cm)	(cm)	(m <sup>3</sup> )	(kg)	(kg/m <sup>3</sup> )	(kg/m <sup>3</sup> )	(mm)
1	21.780	22.100	11.630	0.005598	11.040	1972	1770	20.20
2	21.800	22.100	11.630	0.005603	11.000	1963	1762	18.00
3	22.200	22.100	11.630	0.005706	11.080	1942	1743	19.20
4	21.370	22.100	11.630	0.005493	10.820	1970	1768	18.50
5	21.480	22.100	11.630	0.005521	10.850	1965	1764	19.00
6	21.700	22.100	11.630	0.005577	10.980	1969	1767	18.64
7	21.400	22.100	11.630	0.005500	10.750	1954	1755	18.00
8	21.770	22.100	11.630	0.005595	10.850	1939	1741	17.60
9	21.900	22.100	11.630	0.005629	11.050	1963	1762	17.40
10	21.980	22.100	11.630	0.005649	11.050	1956	1756	18.10
<b>Avg.</b>	<b>21.738</b>	<b>22.100</b>	<b>11.630</b>	<b>0.005587</b>	<b>10.947</b>	<b>1959</b>	<b>1759</b>	<b>18.46</b>
<b>S.D.</b>	<b>0.263</b>	<b>0.000</b>	<b>0.000</b>	<b>0.00007</b>	<b>0.118</b>	<b>11.443</b>	<b>10.273</b>	<b>0.838</b>
<b>C. of V.</b>	<b>1.21%</b>	<b>0.00%</b>	<b>0.00%</b>	<b>1.21%</b>	<b>1.08%</b>	<b>0.58%</b>	<b>0.58%</b>	<b>4.54%</b>

**Appendix I - Indentation tester design**

