

[Home](#) > [ar](#).[cn](#).[de](#).[en](#).[es](#).[fr](#).[id](#).[it](#).[ph](#).[po](#).[ru](#).[sw](#)

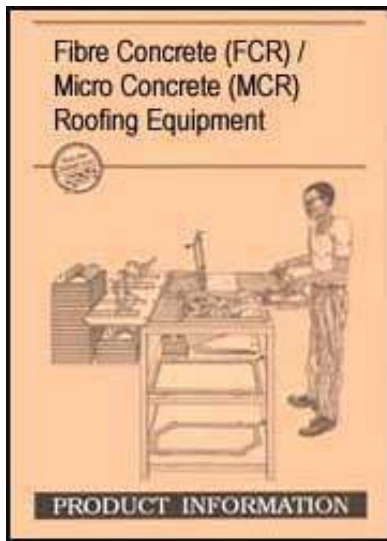

➔  **Fibre Concrete (FCR) / Micro Concrete (MCR) Roofing Equipment (GTZ, 1991, 20 p.)**

 **(introduction...)**

 **Acknowledgements**

 **Technology**

 **Equipment**

 **Criteria for selection and purchase**

 **Checklist for Potential Buyers**

 **DCS Foot-Powered Vibrating Table**

 **Development Alternatives TARA Vibrator**

 **ECO Systems Concrete Rooftile Machine**

 **MATECO Multitile Vibrator**

 **APPRO-TECHNO Tegulamatic**

 **Parry/ITW Electric and Hand-Powered**

 **Parry/IIW Gyrodrive**

 **Bibliography**

[Home](#) > [ar](#).[cn](#).[de](#).[en](#).[es](#).[fr](#).[id](#).[it](#).[ph](#).[po](#).[ru](#).[sw](#)

 **Fibre Concrete (FCR) / Micro Concrete (MCR) Roofing Equipment (GTZ, 1991, 20 p.)**

➔  **(introduction...)**

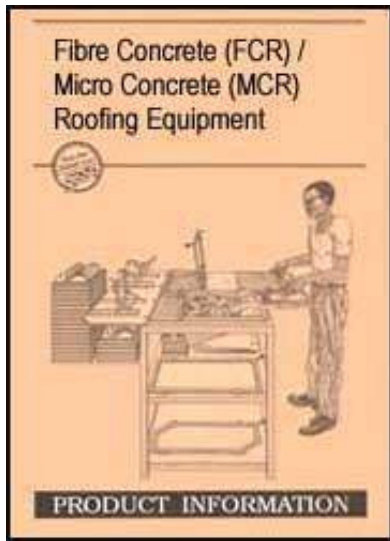

- 📄 **Acknowledgements**
- 📄 **Technology**
- 📄 **Equipment**
- 📄 **Criteria for selection and purchase**
- 📄 **Checklist for Potential Buyers**
- 📄 **DCS Foot-Powered Vibrating Table**
- 📄 **Development Alternatives TARA Vibrator**
- 📄 **ECO Systems Concrete Rooftile Machine**
- 📄 **MATECO Multitile Vibrator**
- 📄 **APPRO-TECHNO Tegulamatic**
- 📄 **Parry/ITW Electric and Hand-Powered**
- 📄 **Parry/IIW Gyrodrive**
- 📄 **Bibliography**

A Publication of the Deutsches Zentrum fr Entwicklungstechnologien - GATE , a Division of the Deutsche Gesellschaft fr Technische Zusammenarbeit (GTZ) GmbH - 1991

NOTE 1: The technical details were provided by the producers. GATE is not in a position to verify these data and therefore cannot accept responsibility for any inaccuracies. In cases where prices have been quoted, these are subject to change and are thus meant to serve only as guidelines valid for 1991.

NOTE 2: from the cd-rom library editors: if you perform a search on "FCR" and "roofing" in other sections or documents in this cd-rom, you will find articles,

books or information that may usefully complement or update the information contained herein.



[Home](#) > [ar](#).[cn](#).[de](#).[en](#).[es](#).[fr](#).[id](#).[it](#).[ph](#).[po](#).[ru](#).[sw](#)

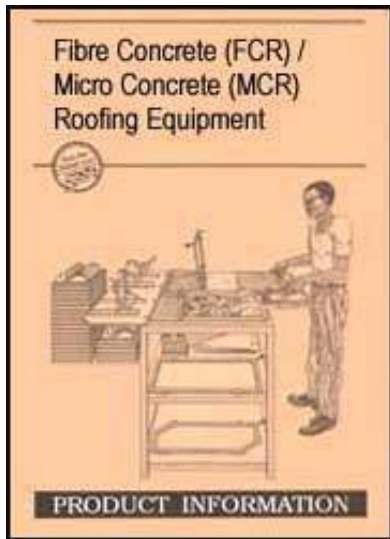

 **Fibre Concrete (FCR) / Micro Concrete (MCR) Roofing Equipment (GTZ, 1991, 20 p.)**

 **(introduction...)**

 **Acknowledgements**

 **Technology**

 **Equipment**

 **Criteria for selection and purchase**

 **Checklist for Potential Buyers**

 **DCS Foot-Powered Vibrating Table**

 **Development Alternatives TARA Vibrator**

 **ECO Systems Concrete Rooftile Machine**

  **MATECO Multitile Vibrator**

 **APPRO-TECHNO Tegulamatic**

 **Parry/ITW Electric and Hand-Powered**

 **Parry/IIW Gyrodrive**

 **Bibliography**

MATECO Multitile Vibrator

Model "Peru"

Manufacturer MATECO S.A.

Division Equipos

Shell 319 Of. 906

Miraflores, Lima Peru

Tel. [. . 51] 14 - 44 25 25

Fax. [. . 51] 14 - 4126 96

Description

The Multitile Vibrator Model "Peru" was designed and developed by Ing. Raul D'Angelo Kruger as a means to achieve increased productivity in a commercial workshop and produce more competitive FCR/MCR tiles for the open market.

The all-steel workstation has a large screeding table mounted on rubber shock absorbers. The screeding surface is a rubber sheet stuck onto the steel table, in order to ensure a tight fit of the frame and prevent the wet mortar from leaking out during vibration.

The key feature of the machine is that 3 or 4 rooftiles can be made during each screeding operation, depending on the type of interchangeable frame used, of which 5 different types are available: 2 kinds of curved tiles (Pantile and Romana) with 3 tiles per frame, and 3 kinds of plain tiles (Plane, Serrana and Provenzal) with 4 tiles per frame. These allow for a high output rate of 300 to 450 tiles per day, depending on the type of tile made and the skill of the operator.

The vibrator, which acts horizontally, is powered by a 12 volt DC electric motor, which runs on a car battery.

The MATECO Experience

MATECO S.A. is a private enterprise producing FCR products in Lima/Peru since early 1989. Its origins date back to 1986, when contacts were established between SKAT and the Peruvian architect, Manuel de Rivero which resulted in the setting up of a workshop in 1988.

The first FCR tiles were made on equipment obtained from JPM Parry & Associates, U.K., but it was soon realized that the local circumstances required certain modifications of the equipment and production process. Thus, on the basis of extensive experimentation, the following conclusions were drawn:

- Fibres: The most appropriate locally available fibres were found to be eucalyptus waste from the manufacture of wood-wool products. The fibres are already cut to 1.5 cm lengths (as needed for FCR tiles) and only need to be cleaned before use.**
- Mortar mix: 10 kg of clay-free sand, 3.85 kg of Portland cement and 25 g of eucalyptus fibre mixed with 2 litres of water constitute a mixture enough to produce 7 pantiles or Roman tiles, or 8 plain tiles. The relatively small proportion of fibres ensures good appearance of the tile without forfeiting the strength needed to avoid damage during transportation and handling.**
- Coloured tiles (particularly red ones) are preferred among Peruvians. After numerous trials the ideal combination was found to be a blend of 60 % red and 40 % yellow pigments, added in a proportion of 200 g per unit of mixture. Black**

coloured tiles are now also in demand, although a uniform appearance is difficult to achieve, because of the variation in the quality of pigments. However, in general, 300 g per unit of mixture IS used.

· Solar curing: Since the tiles cured in water generally had unsightly white stains on the surface, which had to be washed off with a special solution, other methods of curing were tried out. The most ideal method turned out to be a kind of autoclaving using solar energy (called solar curing): batches of 10 - 15 tiles (held in box-like frames) are placed in the curing tanks, which contain just a few centimeters of water. The tanks are deep enough to hold two layers of frames (ie one above the other) and are covered with black plastic sheets so that the tiles remain moist and the tank and its contents are heated up by solar energy. 4 days of solar curing followed by 10 days of air curing were found to give the tiles greater impact resistance than by water immersion curing for 7 days and subsequent air curing for 14 days. This method, therefore, not only saves curing space and time, but also prevents staining and produces stronger tiles.

· Screeding table: The output of one tile per cycle was found to be commercially unsatisfactory, which is why a larger screeding table was developed, incorporating a set of interchangeable screeding frames with which 3 or 4 tiles could be made at a time, thus achieving a considerably higher output rate.

Operating the Multitile Vibrator

To operate the Multitile Vibrator, one man is needed to work at the table, while two other men are occupied (about three quarters of the time) with the preparation of the mix, demoulding the previous days tiles, moving and cleaning

moulds and plastic sheets, etc.

For each tile a separate plastic interface sheet is clamped down under the screeding frame. For each tile a lump of mortar, measured with the scoop, is placed in each field, all of which are spread out and smoothed with a float under vibration, which should not take longer than 90 seconds. The frame is opened and tilted up on the side opposite the operator, who moves to the right of the table to place a PVC mould onto the projecting brackets. With both hands, the first interface sheet with the screeded mortar is carefully pulled over the mould and aligned with the guide markings. The mould is removed and placed on the mould stack for initial curing and the procedure is repeated for each of the other tiles, before the production cycle can begin again.

On the next day the tiles are demoulded and placed in solar curing tanks (described below) for 4 days and later air cured for 10 days before the tiles are ready for use.





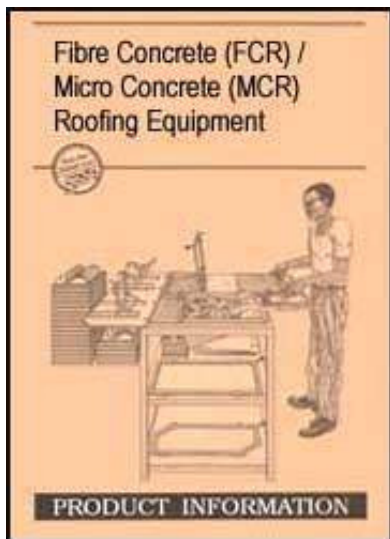

Technical Details	Multitile Vibrator Model "Peru"	
Size of screeding table (1 x w x h)	92 x 65 x 92 cm (36 x 26 x 36 m)	
Weight of screeding table	85 kg	
Sizes of crates for shipment	a. Machine & accessories	100 x 120 x 90 cm (39 x 47 x 35 in)
	b. 300 moulds	100 x 120 x 90 cm (39 x 47 x 35 in)
Weight of the two crates	a + b (132 + 211	343 kg







Standard tile size (Roman or pantile)	kg) 50 x 25 x 0.8 cm (19.7 x 9.8 x 0.31 in)	
Energy input	electrical (car battery)	
No. of tiles per cycle/output rate	3 or 4 / 36 to 56 tiles per hour	
Labour force required (incl. mixing and stacking)	3 men	
Price (ex works)	Multitile Vibrator	1350 US\$
valid June 1991	PVC Mould	9 US\$
	Screeding Frame	50 US\$
	FOB expenses	100 US\$

[Home](#) > [ar](#).[cn](#).[de](#).[en](#).[es](#).[fr](#).[id](#).[it](#).[ph](#).[po](#).[ru](#).[sw](#)



Fibre Concrete (FCR) / Micro Concrete (MCR) Roofing Equipment (GTZ, 1991, 20 p.)

-  **(introduction...)**
-  **Acknowledgements**
-  **Technology**
-  **Equipment**
-  **Criteria for selection and purchase**
-  **Checklist for Potential Buyers**
-  **DCS Foot-Powered Vibrating Table**

-  **Development Alternatives TARA Vibrator**
-  **ECO Systems Concrete Rooftile Machine**
-  **MATECO Multitile Vibrator**
-  **APPRO-TECHNO Tegulamatic**
-  **Parry/ITW Electric and Hand-Powered**
-  **Parry/IIW Gyrodrome**
-  **Bibliography**

APPRO-TECHNO Tegulamatic

Roof Tile Plant

Manufacturer

APPRO-TECHNO

24 Rue de la Rieze

B-5660 Couvin (Cul-des-Sarts)

Belgium

Tel. [. . 32] 60 - 37 76 71

Tlx. 51622 ap tec b

Fax. [. . 32] 60 - 37 78 87

Description

The Tegulamatic is a roof tile screeding machine that produces 2 tiles at a time. It is supplied with a complete production plant, which, in addition to the screeding machine, comprises 3 frames:

- **1 for 2 overlapping pantiles 49 x 23.5 cm,**
- **1 for 1 overlapping under-ridge tile and 1 overlapping edge tile (each 49 x 23.5 cm),**
- **1 for 2 49 cm long ridge tiles, a concrete mixer,**
a roll of plastic sheeting to be cut locally into 1000 interface sheets, a measuring scoop for mortar, a rubber box to hold fresh mortar, afloat, a balance, a 10 litre bucket, a jig
samples of fibres and colourants. The main bulk of the plant is the set of double tile moulds, supplied in sets of 100 to 400 moulds, depending on the desired production rates (between 190 and 700 tiles per day).

The screeding table is an especially robust steel construction, designed for intensive use over long periods. The electric vibrator has the following characteristics: 3000 rpm, 0.095 kW 220 V monophasic, 220/380 V triphase, 50/60 Herz (tropicalization on request), 24 or 12 V direct or alternating current (also available on request).

The standard thickness of the screeding frames is 8 mm, but frames of 10 mm thickness are also available to produce more resistant tiles.

The self-stacking double moulds are made of galvanized steel. There are 2 different types one for pantiles and one for ridge tiles. tech double mould is 108 cm long and weighs 4 kg. The following table shows the different sets available for different output rates:

Type moulds	pantile moulds	ridge tile tiles/day	No of roof/day	m² of
AP 100	95	5	190	15

AP 150	145	5	290	23
AP 200	190		380	30
AP 250	235	15	470	37
AP 300	280	20	560	44
AP 350	325	25	650	52
AP 400	375	25	700	56

In each case, the nominal output is slightly less than the number of moulds provided, so that the operator can already begin the day's work with the unused moulds of the previous day' while the rest are being demoulded and cleaned.

Training

Professional training courses (covering both the technology and management aspects) are conducted by APPRO-TECHNO in Belgium or in Abidjan / Ivory Coast, or elsewhere at the customer's request.

Operating the Tegulamatic

A variety of design details have been incorporated in the Tegulamatic screeding table to simplify the operator's work. These are, for instance:

- a tray extending on the side of the table to hold the rubber mortar box at working height**
- a foot pedal to clamp down and release the screeding frame, leaving the hands free to do other things, eg hold down the nibs when lifting off the frame (a hand operated lever can also be used instead of the foot pedal, if necessary)**

- **adjustable screws at the 3 clamping points to ensure a tight fit of the frame on the screeding surface**
- **4 bolts to adjust the level of the table, indicated by 2 water gauges fixed at visible points on the table;**
- **3 standardized hinges to facilitate the changing of frames;**
- **a second foot pedal to switch the vibrator on and off**
- **2 adjustable and retractable brackets to hold the mould and permit the plastic interface sheets and screeded mortar to slip smoothly over the mould.**

The production of FCR or MCR tiles on the Tegulamatic is essentially the same as on other screeding machines: clamping down a plastic sheet with the screeding frame, placing measured amounts of mortar on the screeding surfaces, spreading it out under vibration and smoothing the surface, filling the nib construction boxes, lifting the screeding frame, removing the plastic sheets with the screeded mortar and placing them on a the mould for setting. The main difference is that a part of the work is done by means of foot pedals, leaving the operator's hands free to carry out the work more efficiently. Furthermore, the output rate is higher, since two tiles are made per cycle.

After demoulding the tiles the next day, the recommended duration for curing under water is 5 days and subsequent dry curing in a shaded place is 15 to 20 days, after which the tiles are ready for use.

Other APPRO-TECHNO Equipment

APPRO-TECHNO has a long experience record in the manufacture of high standard equipment for the production of building materials. Apart from the Tegulamatic Roof Tile Plant, these are:

1. TERSTARAM, a manually operated mobile soil block press with interchangeable moulds, which can also be used to mould clay bricks and roof tiles;

2. SEMI-TERSTAMATIQUE, a motorized (electric or diesel powered) soil block press with interchangeable moulds, functioning in much the same way as the TERSTARAM, but with a much higher output.

3. TERSTARAM Ground Breaker, a mobile (electric or diesel powered) earth pulverizer with which the dry clay lumps in the raw material are disintegrated to produce a homogenous soil for brick production.

4. TERSTAMIX (also available under the trade name TETRAMIX), a mobile (electric or diesel powered) two-paddle planetary mixer, required to prepare the soil for block production, but also to prepare mortars and renderings.







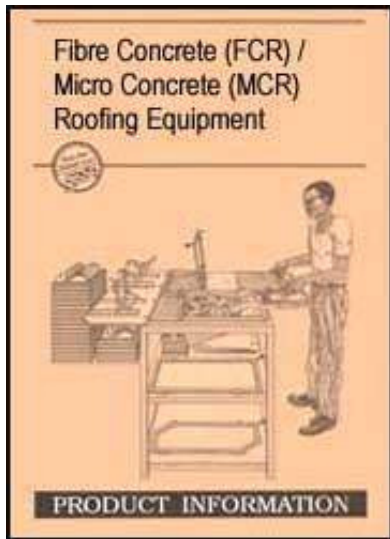

Technical Details	Tegulamatic AP 100	
Size of screeding table (l x w x h)	110 x 50 x 100 cm (43 x 20 x 39 in)	
Weight of screeding table	148 kg	
Sizes of crates for shipment	a. Machine & accessories	177 x 135 x 112 cm (70 x 53 x 44 in)
	b. 100 moulds	120 x 120 x 50 cm (47 x 47 x 20 in)
Weight of the two crates	a + b (450 + 600 kg)	1050 kg
Standard tile size /weight	49 x 23.5 x 0.8 cm (19.3 x 9.3 x 0.31 in)/2.1 kg	







Energy input	electrical (95 watts)	
No. of tiles per cycle/output rate	2/60 tiles per hour	
Labour force required (incl. mixing and stacking)	4 men	
Price (ex works)	Tegulamatic AP 100	145000 FB (~ 4200 US\$)
valid June 1991	Tegulamatic AP 400	325000 FB (~ 9300 US\$)
FB = Belgian Francs		

[Home](#) > [ar](#).[cn](#).[de](#).[en](#).[es](#).[fr](#).[id](#).[it](#).[ph](#).[po](#).[ru](#).[sw](#)



Fibre Concrete (FCR) / Micro Concrete (MCR) Roofing Equipment (GTZ, 1991, 20 p.)

-  **(introduction...)**
-  **Acknowledgements**
-  **Technology**
-  **Equipment**
-  **Criteria for selection and purchase**
-  **Checklist for Potential Buyers**
-  **DCS Foot-Powered Vibrating Table**
-  **Development Alternatives TARA Vibrator**

-  **ECO Systems Concrete Rooftile Machine**
-  **MATECO Multitile Vibrator**
-  **APPRO-TECHNO Tegulamatic**
-  **Parry/ITW Electric and Hand-Powered**
-  **Parry/IIW Gyrodrive**
-  **Bibliography**

Parry/ITW Electric and Hand-Powered

Vibration Screeding Machines

Manufacturer

JPM Parry & Associates Ltd

Overend Road, Cradley Heath

West Midlands B64 7DD

United Kingdom

Tel. [. . 44] 384 - 69171 (3 lines)

Tlx. 334132 it parr g

Fax. [. . 44] 384 - 637753

Description

The Intermediate Technology Workshops (ITW), which is the research and consultancy division of JPM Parry & Associates, were the first to develop and manufacture vibration screeding machines for the production of fibre concrete rooftiles. They are thus the most experienced manufacturers of these machines, of

which several types are available, catering for various production scales and energy inputs.

The ITW 250, ITW 500 and ITW 1000 are the three principal electric powered rooftile plants which are designed to produce 250 500 and 1000 rooftiles per week respectively based on a working week of 5 working days of 8 hours each with the minimum number of operators. All electric plants now use the Multivibe detachable vibrator (described in a separate leaflet in the GATE Product Information folder on Concrete Block Producing Equipment), which runs on 12 volt DC power from a car battery or transformer-rectifier connected to a mains power source. The advantage of the Multivibe is that it can also be used with alternative moulds and accessories to manufacture a number of other concrete building components.

Hand-powered versions of these machines, the HP 250, HP 500 and HP 1000, are available for remote areas where power supplies are unreliable or do not exist at all. The vibrator is set in motion by a second operator, who cranks a handle on the side of the machine, producing vibrations of identical amplitude and frequency to the electric machines. Kits are available to convert the HP machines to electric power should this subsequently become available.

The standard rooftiles produced on these machines are pantiles and Roman 11 tiles, 50 cm long, 25 cm wide and 6, 8 or 10 mm thick. To cover one square metre of roof 13 tiles are needed. As an alternative, Parry Associates also offer larger machines and moulds to produce semi-sheets 60 cm long and wide, requiring only 4 elements to cover one square metre. The semi-sheet production plants are available as NS 150, 250, 400, 600 and 800, depending on the desired output

rates. Operation and handling of the semi-sheet equipment are principally the same as for the standard rooftiles.

The injection moulded polypropylene moulds are self-stacking, ie they interlock when placed on top of each other, saving space and providing air-tight, humid chambers for the wet tiles to set during the first 24 hours after moulding.

The standard accessory packs comprise sand and cement batching boxes, mortar measuring scoop, fibre balance, demoulding and quality control jig, sample sieve, sample tile, sample dry mortar mix, 2 trowels and a spare parts kit. Various optional extras are available, including hand power conversion kits, battery chargers, and tile testing devices.

Operating the Parry Screeding Machines

An interface sheet is placed on the screeding surface and clamped down with the screeding frame. A level scoop of mortar is measured and spread out on the screeding surface with a float. (In the case of semi-sheets, 4 scoops of mortar are needed). With the vibrator switched on, the mortar is smoothed out such that the surface is level with the frame. Finally the nib-forming box is filled under vibration and - if necessary - a wire loop is inserted.

The mould is then placed on the brackets, the frame released carefully, making sure not to damage the nib, and the interface sheet with the screeded mortar pulled onto the mould, taking care that the edges of the tile are exactly in line with the guide markings on the mould. The mould is set aside on the curing stack.

On the next day the mould and green tile are placed upside down on the

demoulding jig, so that the mould can be lifted off and the polythene interface sheet peeled off. Any rough edges of the tile are trimmed off and the tile is left to cure for 2-3 weeks, fully immersed in a water tank, or in a humid container, where it gains its full strength.

Training Courses

On request, special training courses are offered at the Intermediate Technology Workshops, Cradley Heath, U.K. and at several other overseas locations. The courses are not only on the technology of fibre concrete rooftile and semi-sheet production, but can also include other production technologies with Parry equipment, such as those of a large variety of concrete building components, as well as clay bricks and rooftiles.

Course durations are typically 5 or 10 days costing a fee of 250 or 500 £ Sterling respectively.

Technical Details	MV 250	ITW/MV 500	ITW/MV 1000
Size of machine/workstation (I x w x h)	38 x 65 x 19 cm	65 x 61 x 92 cm	65 x 67 x 92 cm
Weight of machine/workstation	32kg	61 kg	61 kg
Size of crate for shipping	91 x64x 84 cm	110x65 x 84cm	132x96x 114cm
Weight of packed plant	170 kg	260 kg	470 kg
Standard tile size (Roman or pantile) 50 x 25 x 0.6/0.8/1 cm	50 x 25 x 0.6/0.8/1 cm	50 x 25 x 0.6/0.8/1 cm	

Number of moulds: rooftiles / ridge tiles	48 / 2	96 / 4	192 / 8
Energy input / transmission electric / mechanical	electric / mechanical	electric / mechanical	
Output: No of tiles per cycle / per day	1 / 50	1 / 100	1 / 200
Labour force required	1 man	2 men	3 men
Price (FOB) with Multivibe 1320 £ Sterling (~ 2310 US\$)	1990 £ Sterling (~ 3480 US\$)	3070 £ Sterling (~ 5370 US\$)	
valid June 1991 detachable vibrator			
Technical Details	HP 250	HP 500	HP 1000
Size of machine/workstation (I x w x h)	65 x 67 x 92 cm	65 x 67 x 92 cm	65 x 67 x 92 cm
Weight of machine/workstation	61 kg	61 kg	61 kg
Size of crate for shipping	91 x 64 x 84 cm	110 x 65 x 84 cm	132 x 96 x 114 cm
Weight of packed plant	245 kg	260 kg	470 kg
Standard tile size (Roman or pantile) 50 x 25 x 0.6/0.8/1 cm	50 x 25 x 0.6/0.8/1 cm	50 x 25 x 0.6/0.8/1 cm	
Number of moulds: rooftiles / ridge tiles	48 1 2	96 / 4	192 / 8
Energy input / transmission N manual / mechanical	manual / mechanical	manual / mechanical	

Output: No of tiles per cycle / per day	1 / 501	1 / 100	1 /200
Labour force required	2 men	3 men	4 men
Price(FOB) with hand 1615 £ Sterling (~2830US\$)	2095 £ Sterling (~3670US\$)	3180 £ Sterling (~5570US\$)	
valid June 1991 powered vibrator			
Technical Details	NS 150	NS 40	NS 800
Size (I x w x h) / number of machines	96 x 93 x 94 cm / 1	96 x 93 x 94 cm / 1	96 X 93 X 94 cm /2
Weight of machine/workstation	105 kg	105 kg	105 kg
Size of crate for shipping	96x 157x 115cm	96x 157x 115cm	2boxes,of 96x 157x 115cm
Weight of packed plant	400 kg	620 kg	1240 kg
Standard semi-sheet size	60 x 60 x 0.8 cm	60 x 60 x 0.8 cm	60 x 60 x 0.8 cm
Number of moulds: semi-sheets / double ridge tiles 30/3	80/8	160/16	
Energy input / transmission	electric / mechanical electric / mechanical	electric / mechanical	
Output: No of semi-sheets per cycle / per day 1 /50	1 / 100	1 / 200	
Labour force required	1 man	2 men	3 men

Price (FOB)	WITH MULTIVIDE 2250 £ Sterling (~ 3940 US\$)	3550 £ Sterling (~ 6220 US\$)	7070 £ Sterling (~ 12400 US\$)
valid June 1991 detachable vibrator			

[Home](#) > [ar.cn.de.en.es.fr.id.it.ph.po.ru.sw](#)

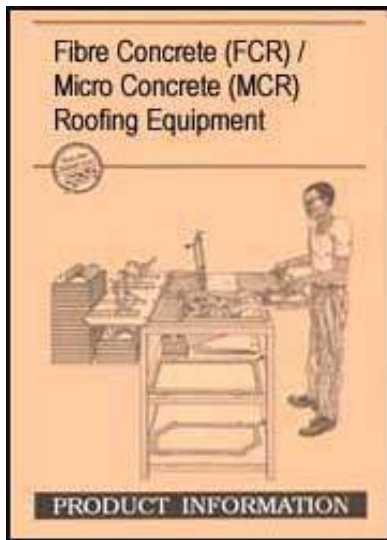

Fibre Concrete (FCR) / Micro Concrete (MCR) Roofing Equipment (GTZ, 1991, 20 p.)

 ***(introduction...)***

 **Acknowledgements**

 **Technology**

 **Equipment**

 **Criteria for selection and purchase**

 **Checklist for Potential Buyers**

 **DCS Foot-Powered Vibrating Table**

 **Development Alternatives TARA Vibrator**

 **ECO Systems Concrete Rooftile Machine**

 **MATECO Multitile Vibrator**

 **APPRO-TECHNO Tegulamatic**

 **Parry/ITW Electric and Hand-Powered**

 **➔ Parry/IIW Gyrodrive**



Bibliography

Parry/IIW Gyrodrive

Screeding Machine

Description

The Gyrodrive is a hand-powered screeding machine, which is operated with the same speed, efficiency and convenience as an electrically powered machine. While the other HP models vibrate only as long as the handle is cranked, the Gyrodrive stores the energy in a flywheel, which gives 40 seconds of vibration with 10 turns of the handle. A special "ball gearbox" transmits the energy to the vibrator, which can be switched on and off at will. Thus the Gyrodrive can be operated by just one person.

Both workstation (GHP 1000) and table top (GHP 250) versions of the Gyrodrive are available, but the machine has also been designed such that it can be bolted onto existing Parry electric or hand-powered vibrating machines, therefore the power pack and underchassis can be bought separately.

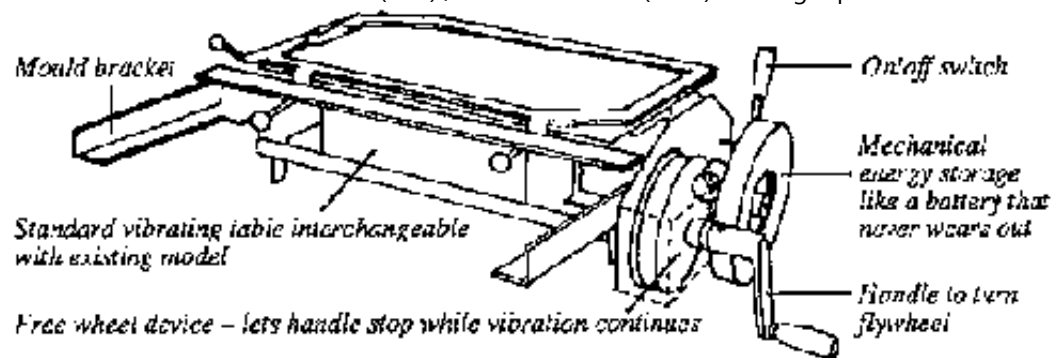
**FIGURE**

Technical Details	GHP 250	
Size of machine (length x width x height)	76 x 43 x 26 cm	
Weight of machine	48 kg	
Size of crate for shipment (whole plant)	91 x 64 x 84 cm	
Weight of packed plant	200 kg	
Standard tile size	50 x 25 x 0.6/0.8/1 cm	
Energy input/transmission	manual / mechanical	
No. of tiles per cycle/output rate per day	1 / 50	
Labour force required	1 man	
Price (FOB)	GHP 250 (complete plant)	1585 £ Sterling (~ 2780 US\$)
valid June 1991	GHP 1000 (complete	3330 £ Sterlina (~ 5830

plant)

US\$)

Overseas Agents, Representatives, Distributors (Stockists) and Training Facilities

JPM Parry and Associates has a growing number of agents throughout the developing world. They not only supply equipment, but also train operators and help to solve technical problems encountered.

BANGLADESH*

Castle Construction Co Ltd

PO Box 2680

House No 50, Road No 2A

Dhanmondi R/A

Dhaka 1209

Tel 507497/502404

Tlx 632509

Fax 863044

BELIZE

Gush & Emy Ltd

5 Mapp Street

PO Box 1237

Belize City

Tel (02) 45953

Fax (02) 31042

DOMINICAN REPUBLIC

Grupo Sofonias

Apdo 182

San Juan de la Maguana

Tel 5574197

Fax 5574061

GHANA*

Parakuo Estates Ltd

Plot 7, Block 5

Dadaban Street, Ring Road

PO Box 3727

Accra

Tel 223245/226757

Tlx 2292

Training facilities at:

Technical Consultancy Centre

University of Science and Technology

Kumasi

KENYA*

East Africa Representatives

JPM Parry & Associates (Kenya)

4th Ngong Avenue

**PO Box 45156
Nairobi
Tel (2) 720 962/720963
Tlx 22014
Fax (2) 727657**

**Agents and Distributors
Kate Freight + Travel Ltd
Ufanisi House
PO Box 28330
Nairobi
Tel (2) 543716
Tlx 22575
Fax (2) 544446**

MADAGASCAR*

**Landis Madagaskar SA
5 Rue Robert Ducroq
BP 633
Antananarivo 101
Tel (2) 40095
Tlx 22334
Fax (2) 33748**

NICARAGUA*

Grupo Sofonias
Apdo 88
Jinotepe, Carazo
Tel 041814

NIGERIA*

Niger Equipment Ltd
Jagal House
Jagal Road
Oregun, PO Box 3959
Ikeja, Lagos
Tel (1) 900010 - 19
Tlx 26663 JAGAL or 27369 SWORD
Fax (1) 964409

RWANDA*

Rwandex Chillington
BP 356
Kigali
Tel (7) 6684
Tlx 22509
Fax (7) 3967

SUDAN*

Maria Enterprises Ltd

**PO Box 2519
Street 47
Khartown 2
Tel (11)45392
Tlx 24183 or 22345**

SURINAM*

**Hesdy Landbrug
Sureineve Kanehai Weg 53
PO Box 5147
Paramaribo
Tel 65643
Tbc 295 HOTAM SN
Fax 10555**

SWAZILAND*

**APT Swaziland (PTY) Ltd
PO Box 569
Suite 108, 2nd Floor
Development House
Swazi Plaza
Mbabane
Tel 42861/61505
Tlx 2119 WD
Fax 45015**

TANZANIA*

Standard Engineering Ltd

PO Box 2293

Nkurumah Street

Nkurumah, Dar es Salaam

Tel (51) 33441 or 22107

Tlx 41304

Fax via (51) 35456

UGANDA*

Magric (U) Ltd

Kitgum House

PO Box 3218

Kampala

Tel (41) 232100

Tlx 61208 MAGRIC

Fax (41) 244606

WESTERN SAMOA

Baudry Marine (Samoa) Ltd

PO Box 178

Apia

Tel 21283

Tlx 201 SX

Fax 21316

ZAMBIA*

Lutanda Ltd

PO Box 20516

Miseshi Road

Kitwe

Tel (2) 218166

Tlx 51550 or

Compresstair Ltd

PO Box 33139

Washama Road

Lusaka

Tel (1) 216110

Tlx 43290



[Home](#) **[ar](#)** **[.cn](#)** **[.de](#)** **[.en](#)** **[.es](#)** **[.fr](#)** **[.id](#)** **[.it](#)** **[.ph](#)** **[.po](#)** **[.ru](#)** **[.sw](#)**

 **Fibre Concrete (FCR) / Micro Concrete (MCR) Roofing Equipment (GTZ, 1991, 20 p.)**

 ***(introduction...)***

 **Acknowledgements**

 **Technology**

 **Equipment**

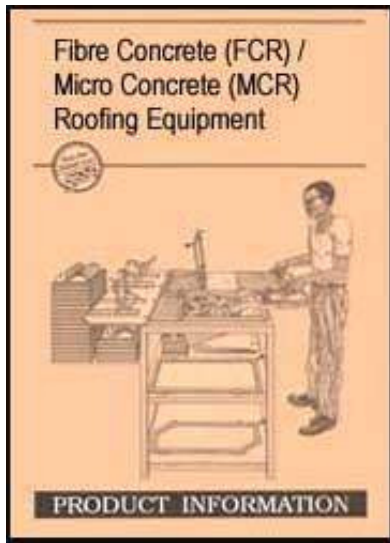

- 📄 **Criteria for selection and purchase**
- 📄 **Checklist for Potential Buyers**
- 📄 **DCS Foot-Powered Vibrating Table**
- 📄 **Development Alternatives TARA Vibrator**
- 📄 **ECO Systems Concrete Rooftile Machine**
- 📄 **MATECO Multitile Vibrator**
- 📄 **APPRO-TECHNO Tegulamatic**
- 📄 **Parry/ITW Electric and Hand-Powered**
- 📄 **Parry/IIW Gyrodrome**
- ➔ 📄 **Bibliography**

Bibliography

(E) = English; (F) = French; (S) = Spanish

01 Brys, Gilbert: Tuiles en fibromortier, Procédé de production et pose en toiture, Technology Series, Memorandum No. 16, International Labour Office (ILO), Geneva, 1988 (F)

02 Gram, H.E.; Gut, P.: Quality Control Guidelines, for Fibre or Micro Concrete Tiles, FCR/MCR Toolkit - Element 23, SKAT, St. Gall; ILO, Geneva, 1991 (E)

03 Gram, H.E.; Parry, J.P.M.; Rhyner, K.; Schaffner, B.; Stulz, R.; Wehrle, K.; Wehrli, H.: FCR - Fibre Concrete Roofing, A comprehensive report on: The Possibilities of Fibre Concrete Roofing, The Limits of Application, and The State of the Art, SKAT, St. Gall, 1986 (E)

04 Heierli, Urs; Beck, Victor: FCR - Fibre Concrete Roofing, Feasibility and Market

Study Guides, SKAT, St. Gall, 1987 (E)

05 Lola, Carlos R.: Fibre Reinforced Concrete Roofing Sheets, Technology Appraisal Report, AT Internationai, Washington, D.C., 1985 (E)

06 Parry, John: Fibre Concrete Roofing, Intermediate Technology Workshops, Cradley Heath, 1985 (E)

07 SKAT: The Basics of Concrete Roofing Elements, Fundamental Information on the Micro Concrete Roofing (MCR) and Fibre Concrete Roofing (FCR) Technology for Newcomers, Decisionmakers, Technicians, Field Workers and all those who want to know more about MCR and FCR, SKAT, St. Gall, 1989 (E)

08 SKAT: Informacion Basica Sobre Techos de Micro Concreto (TMC) y Flbro Concreto (TFC), Introduccion para Arquitectos, Tecnicos, Epresarios, Instituciones de Desarrollo y el Publico Interesado en TMC y TFC, SKAT, St. Gallen, 1989 (S)

09 Stulz, Roland, Mukerji, Kiran: Appropriate Building Materials, A Catalogue of Potential Solutions, SKAT, St. Gall, GATE, Eschborn, IT Publications Ltd., London, 1988 (E)

10 Twigt, Fred Jan: Fibre Concrete Roofing In Malawi, Kenya, Tanzania, Zambia and Uganda, FCR Advisory Services, SKAT, St. Gall, 1988 (E)

Audio-Visual Material

11 BASIN Video (VHS/PAL): Sustainable Building Technologies - Fibre-Concrete Roofing, (Running time 21 minutes), A GTZ/SKAT/ITDG production on behalf of SKAT-FAS, St. Gall, 1990 (E)



[Home](#)"" """"> [ar.cn.de.en.es.fr.id.it.ph.po.ru.sw](#)

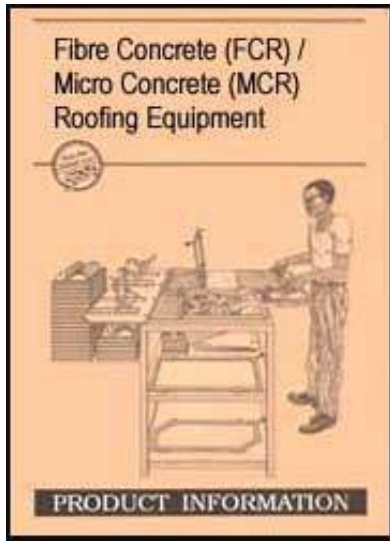

Fibre Concrete (FCR) / Micro Concrete (MCR) Roofing Equipment (GTZ, 1991, 20 p.)

 **(introduction...)**

  **Acknowledgements**

 **Technology**

 **Equipment**

 **Criteria for selection and purchase**

 **Checklist for Potential Buyers**

 **DCS Foot-Powered Vibrating Table**

 **Development Alternatives TARA Vibrator**

 **ECO Systems Concrete Rooftile Machine**

 **MATECO Multitile Vibrator**

 **APPRO-TECHNO Tegulamatic**

 **Parry/ITW Electric and Hand-Powered**

 **Parry/IIW Gyrodrive**

 **Bibliography**

Acknowledgements

**German Appropriate Technology Exchange
Dag-Hammarskjold-Weg 1
Postfach 5180
D-6236 Eschborn 1
Federal Republic of Germany**

Tel. (06196) 79-0 Tlx. 41523-0 gtz d

GATE - stands for German Appropriate Technology Exchange, founded in 1978 as a special division (Division 4020) of the government-owned Deutsche Gesellschaft für Technische Zusammenarbeit (GTZ) GmbH (German Agency for Technical Cooperation).

GATE is a centre for the dissemination and promotion of appropriate technologies for developing countries. GATE defines "appropriate technologies" as those which appear particularly apposite in the light of economic, social and cultural criteria. They should contribute to socio-economic development whilst ensuring optimal utilization of resources and minimal detriment to the environment. Depending on the case at hand, a traditional, intermediate or highly developed technology can be the "appropriate" one.

GATE focusses its work on the following areas:

- Technology Dissemination**
- Research and Development**
- Environmental Protection**

GATE offers a free information service in appropriate technologies for all public and private development institutions in countries dealing with the development, adaptation, application and introduction of technologies.

BASIN is a coordinated network of experienced international professionals, set up to provide qualified advice and information in the field of building materials and construction technologies.

The activities of BASIN are divided between four leading European, non-profit appropriate technology organizations, each of which covers a separate specialized subject area, in order to provide more qualified expertise with greater efficiency.

The services offered by BASIN encompass:

- **responses to technical enquiries;**
- **maintenance of a documentation and computer database with. evaluated information on documents, technologies, equipment, institutions, consultants, projects, etc;**
- **monitoring of practical field experiences;**
- **preparation of publications to close information gaps;**
- **organization of training courses, workshops, seminars and exhibition;**
- **implementation and management of research and development projects.**

This Product Information Portfolio was conceived to inform users as objectively as possible about fibre concrete and micro concrete roofing in general, and more specifically about the available equipment, as well as aspects of selecting and buying the most suitable type. The aim was not to deal with the technology in depth, as sufficient literature is available elsewhere, but to give practical information for the user to understand the advantages and limitations of the alternative technical systems and equipment available in different regions.

This enables the user to compare the machines with each other, and make a preliminary selection, before requesting more detailed information from the manufacturer.

Note: The technical details were provided by the producers. GATE is not in a position to verify these data and therefore cannot accept the responsibility for any inaccuracies. As the prices and exchange rates are subject to change, they are only meant to serve as guidelines.

Text, illustrations, layout:

K. Mukerji, H. Worner, SKAT (1991)



[Home](#) > [ar.cn.de.en.es.fr.id.it.ph.po.ru.sw](#)

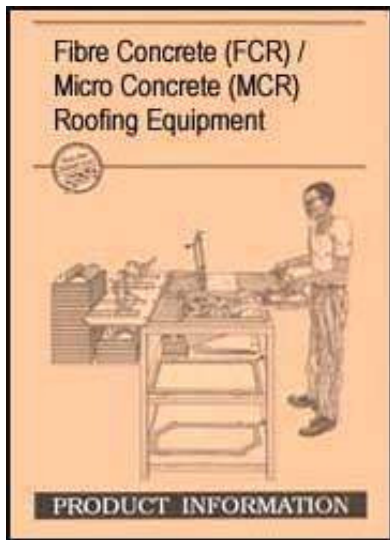

 **Fibre Concrete (FCR) / Micro Concrete (MCR) Roofing Equipment (GTZ, 1991, 20 p.)**

 **(introduction...)**

 **Acknowledgements**

  **Technology**

 **Equipment**

 **Criteria for selection and purchase**

 **Checklist for Potential Buyers**

 **DCS Foot-Powered Vibrating Table**

 **Development Alternatives TARA Vibrator**

 **ECO Systems Concrete Rooftile Machine**

 **MATECO Multitile Vibrator**



-  **APPRO-TECHNO Tegulamatic**
-  **Parry/IIW Electric and Hand-Powered**
-  **Parry/IIW Gyrodrive**
-  **Bibliography**

Technology

General

Of the roofing options available in most developing countries, galvanized corrugated iron (gci) sheeting is by far the most widely used "modern" material, mainly due to its ease of handling and large span, requiring less supporting structure. The disadvantages, however, are that it is an imported material in most developing countries; its thermal performance is very unsatisfactory (extremely hot during the day, cold at night, causing condensation problems); heavy rainfall causes serious noise problems; and the often poorly galvanized sheets tend to rust through within 2 or 3 years.

Asbestos cement (ac) sheets are also extremely popular in many countries for similar reasons as gci, and also on account of their better thermal performance and fire resistance. However, they are brittle and difficult to transport, the fibres or the whole sheets have to be imported in many countries, and the serious health risks of mining and processing asbestos are leading to a steady decline of the ac industry.

A promising alternative has been found in fibre reinforced concrete roofing (FCR) and more recently in micro concrete roofing (MCR). These are roofing elements basically made of sand, cement and water, and in the case of FCR, with the

addition of natural or synthetic fibres for reinforcement.

The main advantages of FCR and MCR are:

- + they can be produced locally in any developing country, where cement is available at sufficiently low cost;**
- + the technology is adaptable to any scale of production, including one-man production units;**
- + with a proper training course in the production and installation of FCR and MCR, virtually anyone (even unskilled workers) can learn the techniques;**
- + the thermal and acoustic performance of FCR and MCR is superior to that of gci and ac sheets;**
- + compared with burnt clay tiles, FCR and MCR require less timber for the supporting structure, can cost less to buy and can be equally durable;**
- + compared with thatch roofs, FCR and MCR are more durable and eliminate the fire risk.**

There are, however, some problems of FCR and MCR, such as:

- the limited availability and high price of cement in some developing countries;**
- especially in dry areas with limited water supplies, the large amount of clean water required for preparing and curing the roofing elements**
- the need for good training of producers and users of FCR and MCR, and strict quality control, without which failures are almost certain;**
- the need for great care in handling, transporting and installing the roofing**

elements to avoid cracks and breakage;

- the difficulty of introducing this relatively new roofing system, where potential users do not know the advantages, or have heard of past negative experiences (which were mainly because of insufficient training of the producers and inadequate construction of the roof substructures);
- the fact that the roof is generally not strong enough to be walked on.

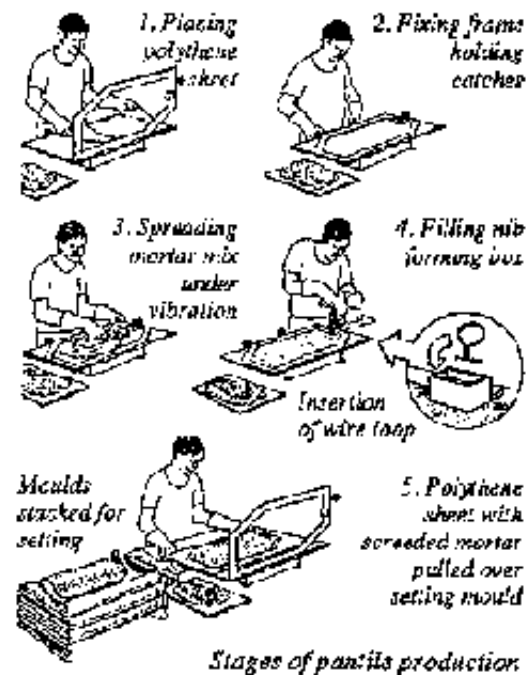

FIGURE

Development of FCR and MCR

The most well-known fibre reinforced concrete was asbestos cement, which was invented in 1899. In the 1960s fibre reinforced concretes, using steel, glass and synthetic fibres were developed and research is still underway. However, these

can generally be considered inappropriate for applications in developing countries, due to the high costs and limited supplies of such fibres. Therefore, the fibres referred to in FCR are mainly natural fibres.

In the mid- 1970s, FCR developments focussed on the production of sheets of about one metre square, since the aim was to substitute gci and ac sheets. However, the FCR sheets, which were produced with simple, locally made equipment and without any mechanization, had several disadvantages, for instance:

- high cement consumption (about 15 kg per m²), similar to that of asbestos cement;**
- on account of their large size and weight, difficulty to handle and cure in water tanks, and to transport and install without breakage;**
- the need for very accurately constructed supporting structures to avoid differential stresses and breakage of sheets.**

On the basis of a research and development project for FCR sheets, funded until 1981 by the U.K. Government through the Intermediate Technology Development Group (ITDG), the Intermediate Technology Workshops (ITW) of J.P.M.Pany & Associates Ltd., Cradley Heath, U.K., succeeded in 1983 in developing a new pantile system, which requires only 5 kg of cement per m² (by means of vibration compaction), is easier to manufacture, transport and install, and is less sensitive to errors. This is the basis of the technology dealt with here.

Research and development continued both in the field and laboratory, where the

tendency of the fibres to decay in the alkaline matrix, especially in warm humid environments, was one of the main issues. Fibre decay is not a serious problem in roof tile production - as explained below - but ways were found, especially by the careful selection and preparation of the raw materials, to produce roof tiles without fibre reinforcement - this was called MCR.

Procedures

As indicated above, FCR and MCR technology requires good training and practical experience to achieve satisfactory results. The information given on this folder must therefore be regarded as a brief introduction to the technology and not as an instruction manual. The reader is advised to refer to some of the publications listed under Select Bibliography for further details, but when embarking on FCR or MCR production, advice should be sought from the Roofing Advisory Service (c/o Swiss Center for Appropriate Technology, Tigerbergstr. 2, CH - 9000 St. Gall, Switzerland), from where details of experienced equipment suppliers and users of FCR and MCR can be obtained.

Materials, Proportioning and Mixing

Cement

- Ordinary Portland cement of the standard quality available in most places is usually suitable. Slow setting qualities should be avoided as they delay demoulding and thus require far more moulds and working space.**
- About 0.4 kg of cement is needed for a 6 mm thick pantile of 50 x 25 cm, corresponding to a cement: sand ratio of 1 :3 by weight or volume**

(because their densities are roughly the same). Using too much cement means additional cost, but too little cement will produce a brittle and porous tile.

· Partial replacement of the cement by a pozzolana (eg rico husk ash, crushed burntclay, fly ash) to increase the durability of the fibres is possible, but not recommended, as it causes slow setting.

Sand

· Usually any type of clean sand that is suitable for cement mortars can be used for FCR and MCR, but in order to minimize the amount of voids, angular sand particles of good grain size distribution between 0.125 mm and 2.0 mm is ideal. The small particles fill the gaps between the large ones, needing less cement and resulting in a less permeable mix.

Aggregates up to 4.0 mm may be used in MCR elements.

· Fine particles of silt and clay should be reduced as far as possible, as clay interferes with the bond between sand and cement.

· One pantile needs about 1.2 kg of sand, but the right amount must be found by sample tests. Too much sand makes a brittle, porous product; too little sand means a wastage of cement and a greater tendency to develop cracks on drying.

Fibres

· Natural fibres are likely to decay in the alkaline matrix within less than a year, especially in warm humid areas. In FCR this loss of strength is not necessarily a drawback. The fibres are required to hold together the wet

mix, inhibit cracking while it is being shaped and during setting, and give the product sufficient strength to survive transports, handling and installation. When the fibres lose their strength, the product is equivalent to unreinforced concrete. However, by then the concrete will have attained its full strength, and since cracking had been prevented in the early stages, it can be stronger than a similar product made without fibres.

- The fibre content ranges between 0.5 and 1% by weight, never by volume, as fibre densities can vary greatly.**
- Sisal is the most common natural fibre used, but satisfactory results have also been achieved with other fibres, such as jute, flax, hemp, coir and banana fibre, as long as they are clean.**
- In the early stages of development, long fibres were used. These gave high impact resistance and bending strengths, but making such FCR elements is cliff cult and thus rarely done.**
- The fibres are now normally chopped to lengths of 12 to 25 mm and thoroughly mixed with the dry cement and sand before adding water. Since the fibres are randomly distributed, they impart crack resistance in all directions. The length and quantity of fibres is important, since too long and too many fibres tend to form clumps and balls, and insufficient fibres can cause excessive cracking, if the other ingredients are not of the right type or incorrectly proportioned.**

Additives

- Generally no additives are needed for FCR and MCR, except perhaps a pigment to make a more attractively coloured product.**

Water

- **Tests have shown that concrete mixes prepared with brackish water are capable of producing satisfactory FCR and MCR elements, because they contain no steel reinforcements, which could corrode. However, it is always recommended to use the cleanest available water, preferably of drinking water quality, and this is essential when wire loops (for fixing on roofs) are inserted into the tile.**
- **Experience is needed to determine the correct amount of water, which should be just enough to make the mortar mix workable. Mixes with too little water are hard to work with and mould without cracking. Cement needs a certain amount of water to hydrate: insufficient water leaves some cement unhydrated (without bonding effect), while excessive water gradually evaporates, leaving pores which weaken the product and increase permeability.**
- **Water is also needed to cure the tiles for about two weeks. The amount of water needed for this is often underestimated and can cause serious problems where water is scarce.**

Moulding and Curing

- **For these operations a screeding machine and a set of moulds are required. These are described in the section on Equipment.**
- **The wet mix is trowelled onto a polythene interface sheet on the screeding machine and, under vibration, smoothed with a trowel to the same level as the surrounding steel frame. At a predetermined spot at the top end of the pantile, a matchbox-size nib is formed, into which a wire**

loop is inserted for better fixing to the roof.

- **The steel frame is lifted off the screeding surface and the plastic sheet slowly pulled over the setting mould, ensuring correct aligning of the tile edge to achieve uniform curvature.**
- **The mould with the fresh tile is then placed on a stack of moulds for initial setting and curing (24 hours), after which the tiles should be demoulded and cured for 2 weeks in water tanks.**
- **After curing, the hard tiles are then allowed to harden for another 2 or 3 weeks, before they can be used for installation on the roof.**
- **Since curing under water has frequently led to an unsightly efflorescence on the tile surfaces, some producers place the tiles on a wet gravel bed (such that the water does not reach the tiles), and cover them with black plastic sheets. This method, called "vapour curing", is a kind of autoclaving using solar energy. The tile quality and appearance is improved, while the setting and curing time is greatly reduced and a considerable amount of water is saved.**

Roof Design and Installation of Tiles

- **The main criteria for FCR and MCR roof construction are:**
 - **minimum pitch of 22° in moderate climates, 30° in areas with severe driving rains;**
 - **although straight and parallel rafters and battens are always recommended, pantiles tolerate slight inaccuracies (which are less acceptable for Roman tiles and must be avoided in the case of large sheets); pantiles may even be laid on a carefully constructed pole timber or**

bamboo structure (gaps between pantiles, eg on kitchen roofs, are often preferred, as smoke and hot air can escape easily and thus improve indoor comfort);

- the timber connections and fixing of tiles onto the battens must take into consideration that the uplift forces (suction) in windy areas can be much higher than the wind pressure and weight of tiles (special wire loops and fixing bolts have proved effective);

- only experienced craftsmen with special training in this technique should be entrusted with the roof construction and cladding.

- As an alternative to pantiles, ITW introduced a larger component, called the semi-sheet, which is 60 x 60 cm large and 8 mm thick. The semi-sheet can be produced faster than pantiles for the same roof area and can also reduce the installation time, as only 4 semi-sheets are needed to cover 1 m² of roof, as compared to 8 to 12 pantiles. Furthermore, the full roll overlaps of the semi-sheets exclude reflected light and lessons the entry of dust and insects. Semisheets are, however, unsuitable for 'L' or 'U' shaped buildings with angled valleys and hips, which require cutting of components.**
- In all cases, simple 'V' shaped tiles with no corrugations are laid along the ridge with about 25 cm overlap, and the joints filled with mortar.**

[Home](#) > [ar](#).[cn](#).[de](#).[en](#).[es](#).[fr](#).[id](#).[it](#).[ph](#).[po](#).[ru](#).[sw](#)

 **Fibre Concrete (FCR) / Micro Concrete (MCR) Roofing**

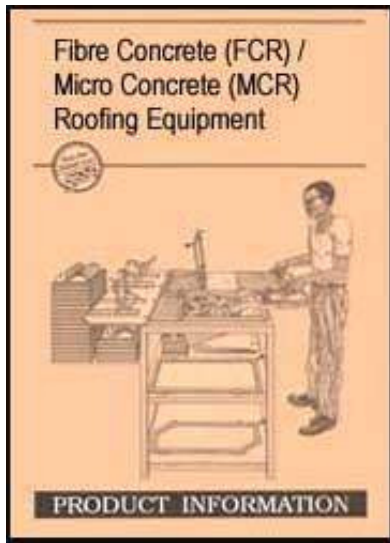

Equipment (GTZ, 1991, 20 p.)

 **(introduction...)**

 **Acknowledgements**

 **Technology**

 **Equipment**

 **Criteria for selection and purchase**

 **Checklist for Potential Buyers**

 **DCS Foot-Powered Vibrating Table**

 **Development Alternatives TARA Vibrator**

 **ECO Systems Concrete Rooftile Machine**

 **MATECO Multitile Vibrator**

 **APPRO-TECHNO Tegulamatic**

 **Parry/ITW Electric and Hand-Powered**

 **Parry/IIW Gyrodrive**

 **Bibliography**

Equipment

Apart from a set of ordinary masonry implements (eg spades, measuring pans, wheelbarrows, sieves, trowels, sand and cement batching boxes, balance and the like), the production of FCR and MCR elements requires some special equipment:

- **screeding machines**
- **moulds**
- **testing equipment.**

Screeding machine

- **This comprises a vibrating screeding surface and interchangeable, hinged frame (for products of different shapes and thicknesses). The machine can be a small, portable 'mini-plant', or a stationary workstation.**
- **The vibrating mechanism requires an energy source, which can be electricity (from a mains outlet, converted to 12 volt dc power by a transformer-rectifier; or from a car battery), handpower (crank with pulley system or metal springs), foot-power (treadle or bicycle pedal system), or flywheel energy (hand-operated).**

Advantages and problems of the various screeding machines

· Electric machines:

- + relatively quiet, do not tire out the user, produce uniform, good quality elements;**
- relatively expensive, dependent on reliable power supplies for operating the machines or recharging batteries, risk of production setback due to bad battery maintenance.**

· Hand-powered machines:

- + independent of power supplies and can thus be used in remote rural areas;**
- relatively noisy and tiring and needs 2 people to operate, uniformity of vibration dependent on the way the handle is turned, thus possibility of**

non-uniform quality of products.

- **Foot-powered machines:**

- +more or less the same advantages and disadvantages as hand-powered machines, except that, depending on the design, the second worker can be omitted, as the hands remain free to spread the mortar duringvibration.**

- **Flywheel-powered machines:**

- + incorporate all the advantages of electric and hand-powered machines and can be operated by a single person;**
 - cost about the same as electric machines.**

Setting moulds

- **These can be of various shapes and sizes, depending on the local requirements and are needed in large numbers - at least as many as the number of components produced in two working days, because the tiles are demoulded after 24 hours.**
- **The moulds can be made of different materials, such as vacuum formed PVC (polyvinyl chloride) and fibreglass. FCR and MCR producers in developing countries have devised methods of making moulds out of concrete. These are produced in 3 stages: first making a concrete 'grandmother mould', from which several concrete 'mother moulds' are formed and sold to local tilemakers, who make the actual concrete moulds themselves. More recently, plywood 'mother moulds' have been devised, eliminating the 'grandmother mould'.**

- **The PVC and fibreglass moulds are designed for self-stacking; in most cases, the concrete moulds are placed in special wooden racks for initial curing, but self-stacking concrete moulds (either entirely concrete or with metal frames) have also been developed.**

Advantages and problems of the various types of setting moulds

- **PVC moulds:**

- + **produced industrially and hence uniform and of good quality, extremely lightweight and easy to handle, can be stacked airtight (vital requirement for curing) and save storage space;**
- **most expensive moulds, no local production in developing countries.**

- **Fibreglass moduls:**

- + **similar advantages as PVC moulds, can be produced locally if the materials and skills are available;**
- **tend to be less accurate than PVC moulds.**

- **Concrete moulds:**

- + **extremely cheap and can be produced by the tilemaker himself;**
- **heavy and less accurate than PVC, and if not self-stacking and not airtight, the rack in which they are placed has to be well covered with a plastic sheet (which is often not done carefully, causing the green tiles to crack due to non-uniform drying).**

Testing Equipment

- **Several tests should be carried out before, during and after the production process to ensure that FCR and MCR products are of consistently good quality. The tests are generally very simple and only a few need special equipment.**
- **Some FCR/MCR machines are equipped with a demoulding jig, on which the 24 hour old tiles are placed upside down, together with the setting mould, which can then be lifted off. Subsequently, the plastic sheet can be peeled off carefully and the rough edges trimmed off. A close fit of the tile and the edges being in line with those of the jig show that the tile has exactly the right shape.**
- **After curing and drying, random samples of tiles from each batch produced should be tested as follows:**
 - **Ring test: holding the tile by the nib and knocking a coin on the tile - a clear metallic sound should be heard.**
 - **Bending test: placing the tile across a gap of 35 cm between two tables and, in the centre, hanging a piece of wood (with a curved edge to fit in vertical position exactly on the tile), which can be loaded with different weights 6 mm thick tiles should resist at least 30 kg; 8 mm tiles 50 kg, and 10 mm tiles 80 kg.**
 - **Nib tensile test: clamping the tile at the edge of a table, allowing 50 mm of the tile to project beyond the edge with the nib on the underside, and hanging a weight from the wire loop - the tile should withstand a load of at least 20 kg.**
 - **Water tightness test: placing the tile horizontally, forming mortar barriers at the extreme ends of the channel, and after they have dried, filling the channel with water- after 24 hours, no drops should be visible on the underside.**
- **These and many other tests are described in greater detail in the SKAT/ILO publication, Quality Control Guidelines, which can be obtained from the Roofing Advisory Service of SKAT, Tigerbergstrasse 2, CH - 9000 St. Gall, Switzerland.**



[Home](#) > [ar](#).[cn](#).[de](#).[en](#).[es](#).[fr](#).[id](#).[it](#).[ph](#).[po](#).[ru](#).[sw](#)

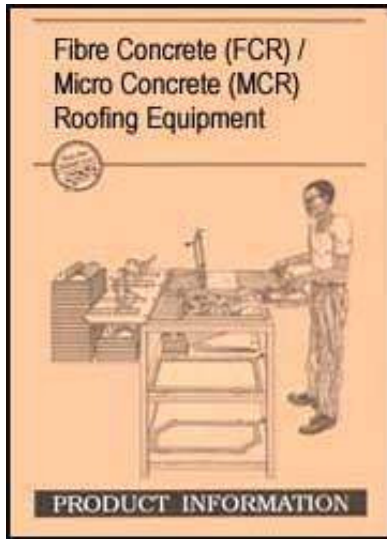

Fibre Concrete (FCR) / Micro Concrete (MCR) Roofing Equipment (GTZ, 1991, 20 p.)

 **(introduction...)**

 **Acknowledgements**

 **Technology**

 **Equipment**

  **Criteria for selection and purchase**

 **Checklist for Potential Buyers**

 **DCS Foot-Powered Vibrating Table**

 **Development Alternatives TARA Vibrator**

 **ECO Systems Concrete Rooftile Machine**

 **MATECO Multitile Vibrator**

 **APPRO-TECHNO Tegulamatic**

 **Parry/ITW Electric and Hand-Powered**

 **Parry/IIW Gyrodride**

 **Bibliography**

Criteria for selection and purchase

General Considerations

FCR and MCR being relatively new technologies, the number of equipment suppliers are still very few. In the early stages of development, the equipment used was locally made by research institutes and appropriate technology groups, which mainly experimented with the production of large sheets. No equipment was commercially available.

ITW of Cradley Heath, U.K., who were the first to develop small roofing components and a method to produce them by vibration, were also the first to supply equipment on a commercial basis. The earliest equipment was the portable 'Mini Plant' (1983), which was followed two years later by an 'Industrial' version of the same production process, and a series of other modified and improved equipment later on.

While this equipment was principally available all over the world, the relatively high capital and transport costs, prohibitive currency exchange rates and import restrictions in many developing countries led to the local production of equipment. Thus there are several types of FCR/MCR equipment on the market and it may be difficult for a newcomer to this technology to decide which one should be bought. The following points will help the potential buyer to make a good choice.

Design of Screeding Machine

- The design of a screeding machine is the result of several stages of development:**
 - Development and design of prototype**
 - Testing and modification of prototype**
 - Field testing of 5 to 10 prototypes for at least 1 year**
 - Modifications resulting from field tests**

- Finalization of design, production manual, accessories, etc.

These steps can only be followed if appropriate workshop facilities, qualified engineering capacity, qualified production and quality control capacity and sufficient funds are available. Depending on the extent to which these requirements are met, there are great differences in the quality of machines available.

- If an FCR or MCR tile production plant is to operate successfully in a developing country, the equipment must be capable of withstanding rough use. If possible, machines that have been in use under such conditions for a reasonably long time (say 3 to 4 months) should be inspected to check, for example, whether the screeding surface and/or the hinged frame is warped or damaged, handles or switches are broken off, and so on.**
- Special consideration should be given to the working conditions for the production team, especially with regard to operation procedures and handling of products, that is, avoidance of dangerous or exceptionally hard manual work and activities that have to be done in a bent position.**
- A balance must be found between the desired output rate, quality standard and level of sophistication. Complicated mechanical devices often necessitate special training and experience for maintenance and repairs. Spare parts can be expensive and if imported, may be difficult and take long to procure.**
- The choice of screeding machine will also depend on the tile size required, which is basically a choice between the pantile (or Roman tile, depending on the mould) of 50 to 60 cm length, 25 to 29 cm width and 6 mm thickness (requiring 8 to 12 tiles to cover 1 m²), and the larger semi-sheet, which is 60 x 60 cm and 8 mm thick (requiring 4 elements to cover 1 m²).**

Energy Sources

- **The type of energy required to operate the vibration mechanism is one of the most important selection criteria. Hand or foot operated machines can be used anywhere, and are the only viable option in remote areas, where power supplies are unreliable or not available. If electric machines with car batteries are used in such areas, it may be possible to recharge the batteries with a photovoltaic solar energy system, but such devices have so far not proved successful.**
- **The vibration mechanism normally consists of rapidly rotating eccentric weights. With two shafts rotating in opposite directions, the horizontal component of vibrations can be neutralized, so that the screeding surface is subjected to a simple harmonic motion in the vertical direction only.**
- **A less common vibration method is with flat metal springs, which hit the underside of the screeding plate at a rate of about 2000 times per minute, by turning a rattle wheel. With this method it is more difficult to achieve uniform vibration frequency, but the machine is very cheap to construct and easy to repair, but on the other hand very noisy.**

Design of Setting Moulds

- **Since a very large number of moulds are needed, they represent the highest single cost factor. The industrially produced PVC moulds are the best in all respects, but by far the most expensive. Considerable costs can be saved if the moulds are produced locally.**
- **The most successful locally made moulds are concrete moulds (as described above). However, great care is needed in production and handling. The usual practice for initial curing is to put the moulds with the fresh tiles in special wooden racks, which have to be covered with plastic sheets to retain the moisture in the tiles. If this is not done properly, parts of the tiles may dry out earlier,**

causing cracks. Therefore, self stacking concrete moulds should be preferred.

Material Quality

- **With good equipment, good tiles can be produced, but if the ingredients are of poor quality or prepared incorrectly, good equipment is not likely to produce good tiles. Therefore, quality control must begin with the selection and preparation of the ingredients.**
- **Broken tiles, leaking roofs and other serious problems associated with FCR in the early stages of development have shown the extreme importance of strict quality control during all phases of tile production, roof construction and installation of tiles. A tile testing kit, as described under Testing Equipment, is essential in every FCR and MCR production plant.**
- **But, above all, the main prerequisite for good quality products is a thorough professional training of the production team and supervisory staff, and efficient management.**

Manufacturer

- **Equipment suppliers are basically of two types:**
 - **private, commercial producers**
 - **non-government organizations (NGOs) based in developing countries.**

The advantages of private producers are:

- + **their dependency on good sales, and hence the need to produce good equipment, as failures or bad service would seriously harm their reputation and ultimately stop business;**

+ their experience in international trade and good administrative backing, making them reliable business partners.

However, the need to support a qualified technical and administrative staff with modern equipment, to maintain a consistently high standard and respond to changing needs, makes their products expensive. Importing these into a developing country not only increases the costs considerably (high exchange rates, transport costs, insurances, duty, etc), but also can be extremely difficult (due to import formalities and restrictions, long delivery time, problems due to breakage in transit, etc).

The advantages of NCOs are:

+ their high motivation and closeness to the target group, enabling them to adapt their methods and products to local requirements, and provide assistance and advice whenever needed;

+ their low overhead and production costs, and if their equipment is sold locally, the additional additional on foreign exchange, transport costs, duty, the trouble with import formalities and delivery time, and the like.

However, these groups do not always have the required funds, technical staff and workshop facilities to carry through all the tests and modifications that the maturing of a new product needs. Unfortunately, this problem is sometimes underestimated.

· Personal visits to the manufacturer and/or sites at which their machines are in use should be undertaken as far as possible. The value of reference lists is to be able to meet or correspond with users, to learn about their experiences. If such lists do not contain addresses, these should be specifically asked for.

Professional Training Courses

- **Of special importance are training courses offered by all good equipment suppliers. As far as possible, these courses should be conducted at a place where the whole production team can participate.**
- **There should be no preconditions for participation in the courses, other than knowledge of the language used. The method and content must be understandable for people without special skills or formal school education, and the course should cover all phases of tile production, roof construction and laying of the tiles, as well as administration and marketing.**

Purchase of Machine

- **The "FOB" price (free on board) includes packaging, transportation and insurance costs of the machine within the retailer's country. This price can be artificially inflated in order to compensate for the reduction offered on the factory price.**
- **As regards sales or rental conditions, one must be suspicious of contracts providing for price indexing based on the number of tiles produced or for payment of royalties for patent use, which is often not justified. A patent is not necessarily a proof of guaranteed quality and constructors frequently apply for patents for processes that are already of the public domain.**
- **It is advisable to include a penalty clause in the contract, to safeguard against late delivery,**
- **In the case of an after sales service contract, the waiting period for repairs and maintenance must be clearly indicated. A detailed handbook should be provided, including specifications of all spare parts and a maintenance plan, indicating operations necessary and expected maintenance frequency.**



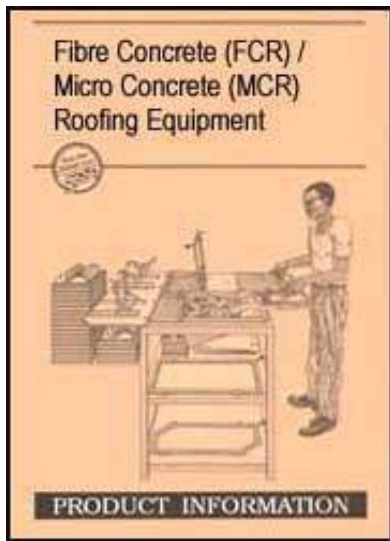

Fibre Concrete (FCR) / Micro Concrete (MCR) Roofing Equipment (GTZ, 1991, 20 p.)

 **(introduction...)**

 **Acknowledgements**

 **Technology**

 **Equipment**

 **Criteria for selection and purchase**

  **Checklist for Potential Buyers**

 **DCS Foot-Powered Vibrating Table**

 **Development Alternatives TARA Vibrator**

 **ECO Systems Concrete Rooftile Machine**

 **MATECO Multitile Vibrator**

 **APPRO-TECHNO Tegulamatic**

 **Parry/ITW Electric and Hand-Powered**

 **Parry/IIW Gyrodrive**

 **Bibliography**

Checklist for Potential Buyers

The following is a summary of the main points to be considered when selecting FCR or MCR tile production equipment:

- **Available financial resources (budget restraints can limit the choice to locally**

available equipment).

- **Required size and shape of FCR/MCR tiles (smaller components are easier to produce and handle, and suitable for all sloped roofs; pantiles are less sensitive to inaccuracies than Roman tiles; semi-sheets are quicker to produce and install per unit area, but less suitable for complex roofs, as semi sheets are more wasteful to cut than tiles).**
- **Required production rate (this depends on the expected market demand and determines the quantity of equipment needed).**
- **Available energy sources (not only the costs must be considered, but also the frequency of power failures; manual operation is always appropriate, but can be very tiring).**
- **Availability of spares and skilled technicians for maintenance and repairs (machines with standardized parts create less problems).**
- **Professional training (this should be an important part of the deal).**
- **Operational safety (this is not usually a problem in FCR/MCR tile production).**
- **References (contacts with equipment users should be sought whenever possible).**
- **Conditions of purchase (since machines of similar types are available, comparisons of prices, discounts for large orders, delivery time, etc. are urgently recommended, but also - if applicable - import restrictions, after sales service, guarantee period, etc should be taken into account).**
- **After sales services (not only should the manufacturers be fair enough to rectify defects of their machines by providing technical assistance or supplying spare parts at minimum or no-cost; users should also take the trouble to send accounts of their experiences and suggestions for improvements to the manufacturers, for without this feed back, no effective development is possible).**

[Home](#) > [ar](#).[cn](#).[de](#).[en](#).[es](#).[fr](#).[id](#).[it](#).[ph](#).[po](#).[ru](#).[sw](#)

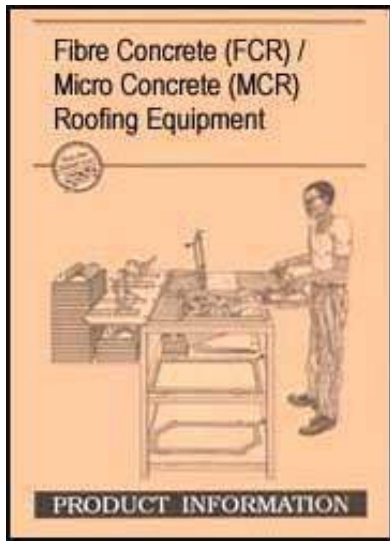

Fibre Concrete (FCR) / Micro Concrete (MCR) Roofing Equipment (GTZ, 1991, 20 p.)

 **(introduction...)**

 **Acknowledgements**

 **Technology**

 **Equipment**

 **Criteria for selection and purchase**

 **Checklist for Potential Buyers**

  **DCS Foot-Powered Vibrating Table**

 **Development Alternatives TARA Vibrator**

 **ECO Systems Concrete Rooftile Machine**

 **MATECO Multitile Vibrator**

 **APPRO-TECHNO Tegulamatic**

 **Parry/ITW Electric and Hand-Powered**

 **Parry/IIW Gyrodrive**

 **Bibliography**

DCS Foot-Powered Vibrating Table

Manufacturer

Development and Consulting Services

P.O. Box 8

Butwal

Nepal

Tel. [. . 977] 73 - 20391

Tlx. 2315 umnepa

Fax [. . 977] 73 - 20465

Description

The DCS Foot-Powered Vibrating Table is a one-person operation screeding table, manufactured in Nepal since 1987. The vibrating surface and drive mechanism are mounted on an angle iron frame. Connected to this is a seat, which is adjustable to suit the tile maker's stature, so that he can sit comfortably at the table while making the tile. Herocks the two foot pedals back and forth at an easy speed driving a bicycle wheel, which in turn drives an eccentric weight assembly beneath the aluminium vibrating surface at a speed of 2500 to 3000 rpm. Careful fitting of all nine sealed bearings ensures easy operation and long life for the machine. The screeding table has a one year guarantee.

The screeding frames for tiles (6 and 8 mm thick) are shaped to provide an "interlock" at the mitre - the diagonal mitre has been replaced by a dog-legged mitre. The frames also provide nib construction boxes for a wind proof fixing of all tiles. Experience shows that wind forces are sufficient to lift tiles, so all tiles are made with a lower fixing nib. A second nib may be made at the top for special conditions (top line of monoslope roofs, edges with long overhangs). When they are not needed, these nib boxes can be swung out of the screeding area (to leave it unobstructed for quick working) and positioned when needed.

The moulds are 535 mm long concrete elements fixed into galvanized sheet stacking frames, which also serve to protect the fresh tile from drying out during setting. DCS sells fitted moulds and frames with the screeding tables. This ensures that the moulds used are accurate and of good quality and allows the entrepreneur to start tile production immediately, so that he soon can produce a demonstration roof to show interested customers and begin to earn money without delay. He can however, also buy a fibreglass mother mould, with which he can make his own moulds later (when he has sufficient experience), in order to replace broken moulds or increase his production capacity.

In addition to the screeding table and tile moulds, the following accessories are supplied:

- a set of batching boxes for fast measurement of cement and sand to correct proportions and workable batch size;**
- a set of tile maker's scoops to enable correct batching of the wet mortar as tiles are made;**
- a tile thickness gauge for checking finished tiles according to the standard;**
- a batten gauge to aid quick and accurate roof building.**

Entrepreneurs may purchase extra tools for quality checking:

- standard vessel to measure water for mixing;**
- prism mould, loading jig and thickness gauge for checking mortar strength.**

DCS also supplies sieves for screening sand and fine aggregate, shovels, trowels, pliers, tile stack covers, interface plastics etc.

Maintenance

The screeding table is maintenance free for up to 5 years, if cleaned regularly

during tile making. The tile frame and screeding surface must be cleaned after each tile is screeded, in order to avoid distorting them. Bearings are protected by seals and cover plates. The bushes for the frame clamping arms and for the vibrating drive should be lubricated before the machine is stored for a period of no production, to avoid seizure from rust. The screeding surface mounting rubbers need replacing every year, as they absorb/damp vibration when they are perished. Replacement rubbers can be hand made from a scrap truck tyre, footwear repairers always have this type of rubber available.

Moulds need regular cleaning to avoid build-up of spilt mortar. Daily cleaning with a cloth or handful of fibre is quick and easy. Mortar left longer can be scraped off without fear of damage to the mould, as it has a hard surface,

Training

DCS selects prospective entrepreneurs from applicants for an 11-day training course in FCR/MCR. The training is held in Butwal and includes theory and practical sessions covering

- production (including raw material selection, quality checks),**
- tile use (roof types, construction, tile fitting),**
- entrepreneur motivation,**
- marketing skills,**
- ease reports and a tour to an established tile producer,**
- book-keeping,**
- obtaining finance.**

Operating the DCS Vibrating Table

Before production, the tile maker must adjust the seat to enable him to sit comfortably while working. Also the screeding surface must be levelled before beginning. A small backrest is provided to give the light support needed while operating the foot pedals and screeding the mortar. Pedalling is not heavy work for the operator's legs.

When the mortar has been batched and mixed, the operator sits at the table, places a plastic interface sheet on the screeding table, then clamps down the appropriate tile frame. Using the corresponding scoop, a measured lump of mixed mortar is placed on the screeding table, and then this is trowelled out to an even thickness within the tile frame, while generating the vibration by rocking the foot pedals back and forth. When the screed surface is smooth and level with the screeding frame, the nib on the lower tile end is made by swinging the nib construction box into place, filling it with mortar under vibration, and inserting a wire loop for fixing on the supporting roof batten. Depending on the roof design, some of the tiles will need a second nib on the upper end, for which another nib box is provided.

After the nibs are made, the plastic sheet with the screeded mortar is lifted onto the next empty mould. This mould is then moved to the stack of newly moulded tiles and the position of the screed on the mould is checked. It is covered with the next mould and screed, or a mould cover if it is at the top of the stack, to prevent the mortar from drying.

The tiles are removed from the moulds after about 24 hours and subsequently cured for 2 weeks in water tanks or vapour curing beds.

TECHNICAL DETAILS

Size of machine (length x width x height)	102 x 74 x 85 cm (40 x 29 x 33 in)
Weight of machine	48 kg
Size of crate for shipment	85 x 85 x 90 cm (33 x 33 x 35 in)
Weight of packed machine plus accessories	65 kg
Standard tile size	50 x 26 x 0.6/0.8 cm (19.7 x 10.2 x 0.24/0.31 in)
Frame for ridge tile	53.5 x 28 cm (21 x 11 in)
Energy input	manual
No. of tiles per cycle/output rate	1/50 tiles per man-day
Labour force required (incl. mixing and stacking)	1 - 5 people per machine
Price (ex works) DCS vibrating table (incl. accessories)	9000 NRs (~ 300 US\$)
valid June 1991 Mould (fitted to stacking frame)	80 NRs (~ 2.60 US\$)
NRs = Nepali Rupees Galvanized steel stacking frame	70 NRs (~ 2.30 US\$)

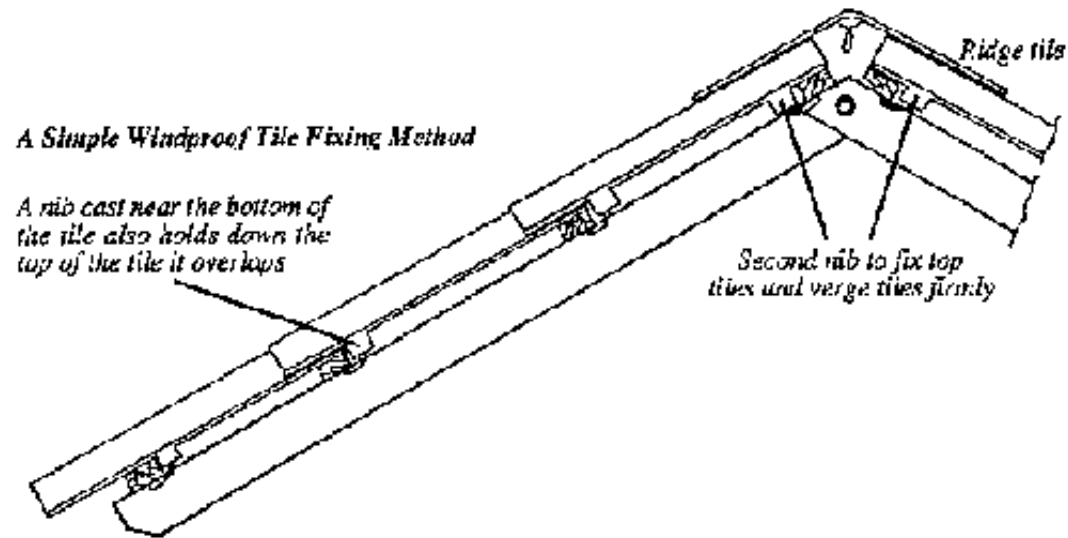

FIGURE

[Home](#) > [ar](#).[cn](#).[de](#).[en](#).[es](#).[fr](#).[id](#).[it](#).[ph](#).[po](#).[ru](#).[sw](#)

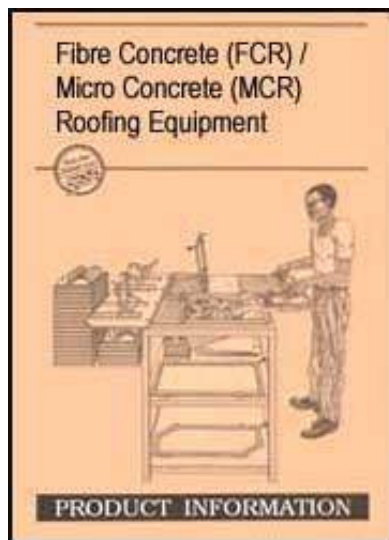

 **Fibre Concrete (FCR) / Micro Concrete (MCR) Roofing Equipment (GTZ, 1991, 20 p.)**

 **(introduction...)**

 **Acknowledgements**

 **Technology**

 **Equipment**

 **Criteria for selection and purchase**

 **Checklist for Potential Buyers**

 **DCS Foot-Powered Vibrating Table**



-  **Development Alternatives TARA Vibrator**
-  **Eco Systems Concrete Rooftile Machine**
-  **MATECO Multitile Vibrator**
-  **APPRO-TECHNO Tegulamatic**
-  **Parry/ITW Electric and Hand-Powered**
-  **Parry/IIW Gyrodrive**
-  **Bibliography**

Development Alternatives TARA Vibrator

Manufacturer

Development Alternatives

B-32, Institutional Area

Tara Crescent, New Mehrauli Road

Hauz Khas, New Delhi 110 016

India

Tel. [. . 91] 11 - 665370 or 657938

Tlx. 031-73216 daft in

Fax [. . 91] 11 - 686-6031

Description

The TARA Vibrator is the result of design and production research at the Regional Centre for FCR/MCR Technology at Development Alternatives, New Delhi. The roofing tiles are being produced since 1988 and the TARA Vibrator since 1989.

The TARA Vibrator consists of an aluminium table top, which is vibrated by a

rotating eccentric mass at a frequency of 2800 rpm, and an interchangeable hinged frame for the production of different shapes and thicknesses of tiles. The machine is powered by an electric motor (1/4 hp), driven from a mains supply of 230 volts.

A clear disadvantage of some of the vibrating machines available is their inability to control the vibration. The TARA Vibrator provides a unique mechanism suspended on leather belts which allows for the vibration to be controlled by adjustable tie rods, depending on the type of cement mix, availability of materials and water cement ratio. The machine operation is optimized to give a vibration time of about 45 seconds for high strength and minimum porosity of tiles.

Another special feature of the machine is a swivel seating arrangement for the operator to sit on, reducing the physical strain during tile making and permitting free rotation when the fresh tile is transferred to the mould stack at the side of the machine.

The machine requires very little maintenance which is normally restricted to the changing of bearings after prolonged operation.

The TARA Vibrator is preferably used to produce micro-concrete tiles, because fibre reinforcement has proved to be a major constraint towards achieving high production and consistent quality of tiles. The micro-concrete mix consists of 1 part cement, 2 parts of graded sand and 1 part of stone grit passing through 4 mm mesh. This mix requires a water-cement ratio between 0.45 and 0.5. With this mix and a labour force of 4 persons, a production rate of up to 200 tiles a day is easily achieved.

Together with the vibrating table, Development Alternatives supplies 200 self-stacking, high impact polystyrene moulds (mounted on wooden frames) and the necessary accessory tools, such as trowels, scoops and quality control implements.

Training

Development Alternatives conducts training courses in MCR tile production for supervisors and masons. The courses, which are held in New Delhi or at one of the many collaborating institutions in India, not only deal with practical aspects, but also with economical aspects management and marketing

Operating the TARA Vibrator

Theoretically, MCR tiles can be made on the TARA Vibrator by a single person, but for an uninterrupted and constantly high production rate of about 200 tiles per day, a team of 4 persons is required.

The production process is principally the same as for all other screeding machines: clamping down a plastic sheet with the screeding frame, placing a measured amount of mortar on the screeding surface, spreading it out under vibration and smoothing the surface, filling the nib. construction box, lifting the screeding frame, removing the plastic sheet with the screeded mortar and placing it on a the mould for setting. The main difference is that the operator can remain seated during the whole operation, even when placing the fresh tile on the mould, making the work less tiresome. The 3 helpers are mainly occupied with supplying the operator with fresh mortar and moulds, as well as other odd jobs.

Development Alternatives / TARA

Development Alternatives (DA) is a nonprofit, self-financing corporate organization, established in 1983. Its main objectives are to design and promote better approaches for the sustainable development of India.

The prime commercial partner of DA is its sister organization, TARA (Technology and Action for Rural Advancement). TARA manufactures and markets all products of DA and provides feedback on relevant production engineering and market information to the designers of DA to facilitate the continual adaptation and improvement of the technologies.

The operations of TARA are self-financing and conducted through a decentralized network of franchised enterprises. An enterprise can be an individual entrepreneur, a cooperative, a voluntary organization, an existing business, a government agency, or any other entity capable of manufacturing and marketing the products designed by DA.

Under a contractual arrangement between the franchiser (TARA) and the franchisee (the local enterprise), their respective duties are clearly defined. Broadly, TARA is responsible for technology development, technology transfer and training, standardization, networking, common procurement and bulk purchasing, quality control and marketing.

The franchisee is responsible for manufacturing, selling and providing after sales service to the local market. The franchisee pays a nominal royalty and fees to TARA, which in turn pays royalty and service fees to DA.

The technologies and services of DA include:

- **Improved cookstoves (chulhas)**
- **Low cost housing technologies**
- **Mudblock presses**
- **Improved handlooms**
- **Biomass energy systems**
- **Bicycle trailers**
- **Paper, board making equipment**
- **Pottery products**
- **Energy plantations**
- **Solar energy systems**
- **Water and sanitation**
- **Environment management**

Technical Details	TARA Vibrator
Size of machine (l x w x h) without seat	100 x 54 x 50 cm (40 x 21 x 20 in)
with seat	115x54x87cm(45x21x34in)
Weight of machine without seat	35 kg
	with seat 45 kg
Size of crate for shipment	113 x 63 x 76 cm (44 x 25 x 30 in)
Weight of packed machine	160 kg
Standard tile size/weight	48.8 x 24 x 0.8 cm (19.2x 9.4 x 0.3in)/2.3kg
Energy input	electrical (80 watts)

Energy input	Electrical (60 watts)
No. of tiles per cycle/output rate	1/25 tiles per hour
Labour force required (incl. Mixing and stacking)	4 men
Price (ex works) TARA Vibrator (incl. accessories)	10000 Rs (~ 480 US\$)
valid June 1991 Polystyrene mould (on wooden frame)	180 Rs (~ 8.60 US\$)
Rs = Indian Rupees	

[Home](#) > [ar](#).[cn](#).[de](#).[en](#).[es](#).[fr](#).[id](#).[it](#).[ph](#).[po](#).[ru](#).[sw](#)

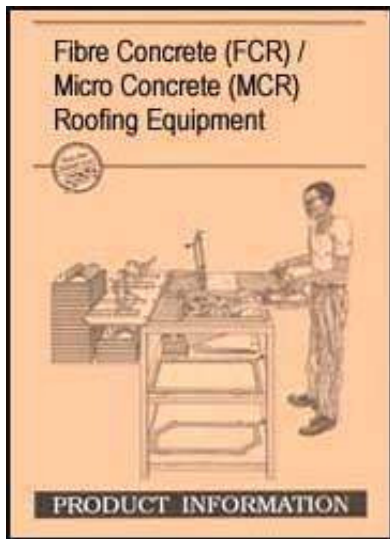

Fibre Concrete (FCR) / Micro Concrete (MCR) Roofing Equipment (GTZ, 1991, 20 p.)

 **(introduction...)**

 **Acknowledgements**

 **Technology**

 **Equipment**

 **Criteria for selection and purchase**

 **Checklist for Potential Buyers**

 **DCS Foot-Powered Vibrating Table**

 **Development Alternatives TARA Vibrator**

  **ECO Systems Concrete Rooftile Machine**

 **MATECO Multitile Vibrator**

-  **APPRO-TECHNO Tegulamatic**
-  **Parry/ITW Electric and Hand-Powered**
-  **Parry/IIW Gyrodrome**
-  **Bibliography**

ECO Systems Concrete Rooftile Machine

Manufacturer

ECO Systems

P. O. Box 938

Blantyre

Malawi

Tel. [. . 265] 620167

Tlx 44891 eco mi

Fax [. . 265] 634 281

Description

Since 1986 ECO Systems has been producing rooftiles and rooftile machines. The original tiles were manufactured according to the specifications of the Malawi Government Rural Housing Project (RHP) staff.

The RHP/ECO machine, which is basically a wooden box, is vibrated by two flat metal springs that hit it from underneath at a frequency of 2000 per minute. This is achieved by turning a handle, which requires little manual effort to operate.

A disadvantage of the earlier versions of the machine was the noise they produced. Therefore, the machines are now fixed firmly to a brick socle (instead of

a light steel frame) reducing the noise and increasing the vibration intensity.

Two types of screeding machines are available: with a flat top for standard tiles and with a concave top for improved tiles (which are 9 mm thick at the troughs and 6.5 mm at the ridges). Thus, with the improved tile machine, a separate machine is required for making moulds and ridge tiles. If standard tiles are to be produced, only a combination machine is needed, which has interchangeable frames to make moulds and ridge tiles.

The concept of ECO Systems is to produce all roofing components without fibres. The MCR mix generally comprises 1 part cement to 2.5 parts river sand. For higher qualities, a mix of 1 part cement to 1 part quarry dust (or fine sharp sand) to 2.5 parts quarry stone of 3 to 4 mm (or similar small pebbles) is recommended.

The Moulding System

The profile of the tiles has been optimized to provide a closer fit at the overlaps (see profile sketches). This is achieved by making the crest of the tiles thinner (ie 6.5 mm) than the valley thickness (ie 9 mm). In order to obtain these different thicknesses, the screeding machine has a concave top and a moulding frame with a curved profile of 2 mm thickness. An additional advantage of this device is that the frame touches the screeding surface only along the narrow strip of 2 mm, avoiding the accumulation of mortar under the frame, improving tile quality and increasing working speed.

The mothermoulds, which were previously made of concrete, are now of preformed plywood, in order to ensure greater uniformity and reduce weight. For

the same reasons the grand mothermould has been omitted.

The machines are supplied together with a set of mothermoulds, with which two types of concrete moulds can be produced: with and without stacking brackets. Moulds with stacking brackets can be piled up in stacks of five tiles, while plain moulds, which are made much faster, are stacked in simple wooden frames.

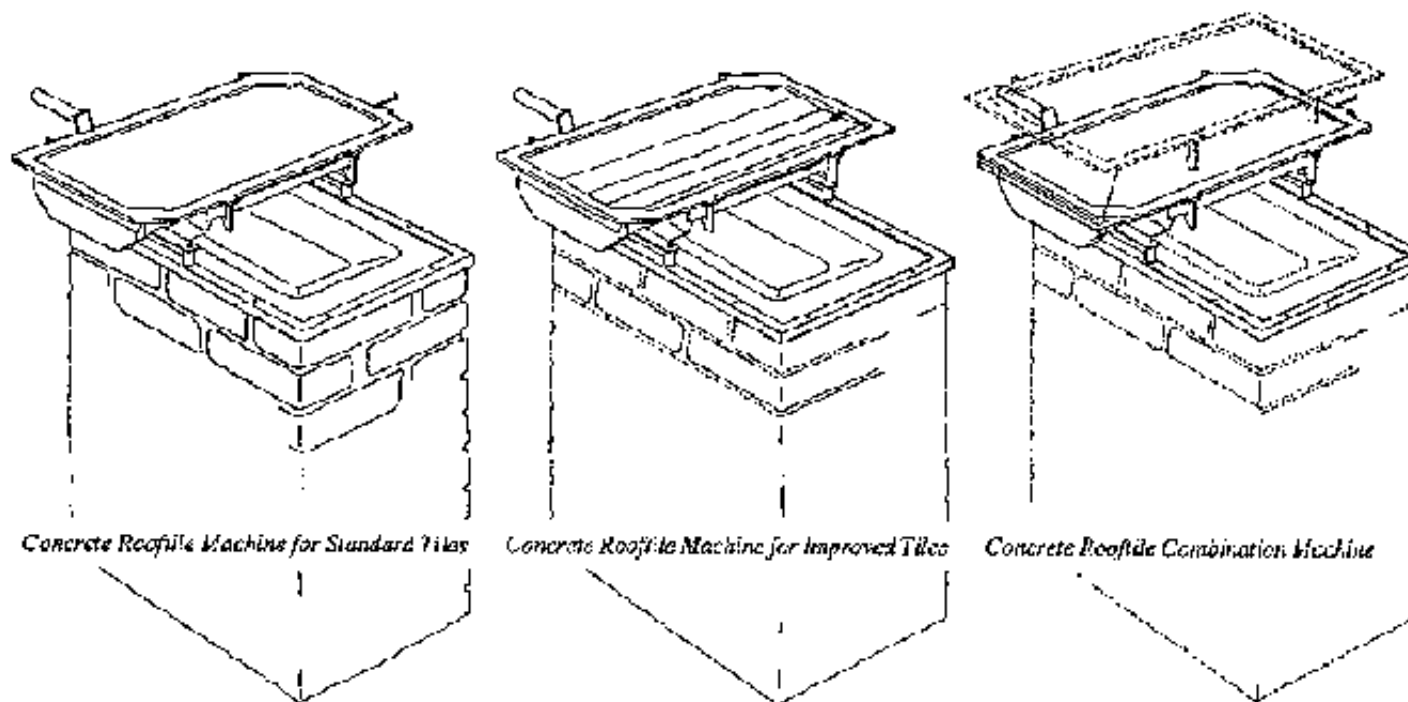

FIGURE

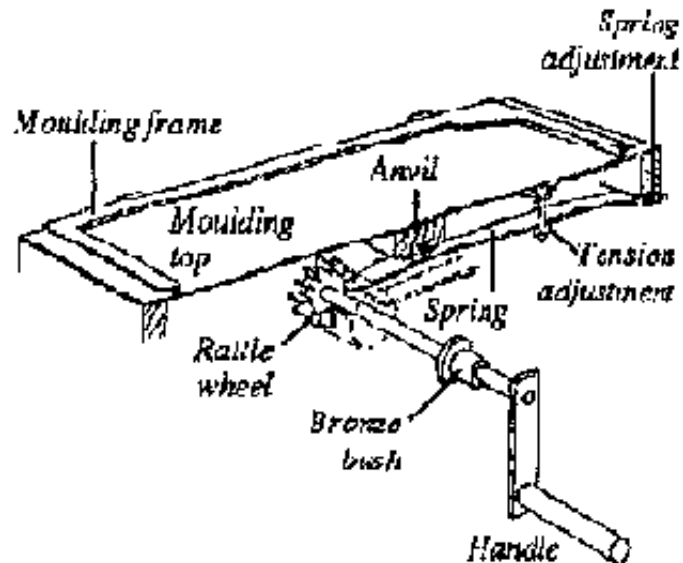
**FIGURE**

Technical Details	ECO Systems Concrete Rooftile Machine
Size of machine (length x width x height)	65 x 45 x 1 5 cm (25 x 1 8 x 6 in)
Weight of machine (combination machine)	15 kg
Size of crate for shipment	80 x 76 x 25 cm (32 x 30 x 10 in)
Weight of packed machine	29 kg
Standard tile size / weight	60 x 28.5 x 0.65 cm (23.6 x 11.2 x 0.26 in) /2.45 kg
Improved tile size / weight	60 x 28.5 x 0.65/0.9 cm (23.6 x 11.2 x 0.26/0.35 in)/3.15kg
Energy input	manual
No. of tiles per cycle / output rate	1 / 20 - 60 tiles per hour

NO. of tiles per cycle/output rate	1/30 - 60 tiles per hour	
Labour force required (incl. mixing and stacking)	6 men	
Price (ex works)	Standard tile machine	250 US\$
	Improved tile machine	290 US\$
valid	Combination machine for standard tile	325 US\$
June 1991	Mould and ridge machine	245 US\$
	Mother mould / Ridge mould	22/8 US\$
	Concrete mould	0.5 US\$
	Stacking frame	10 US\$

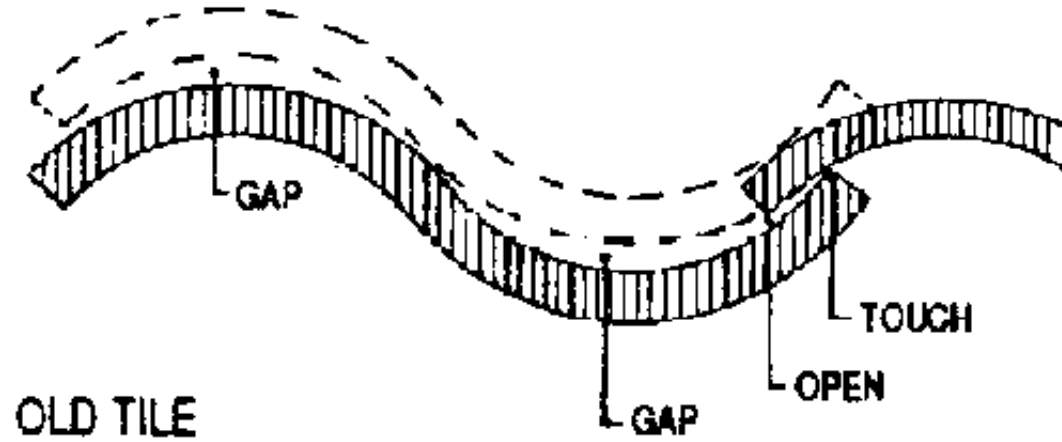

OLD AND NEW TILE PROFILE (Dimensions exaggerated to show differences more clearly)

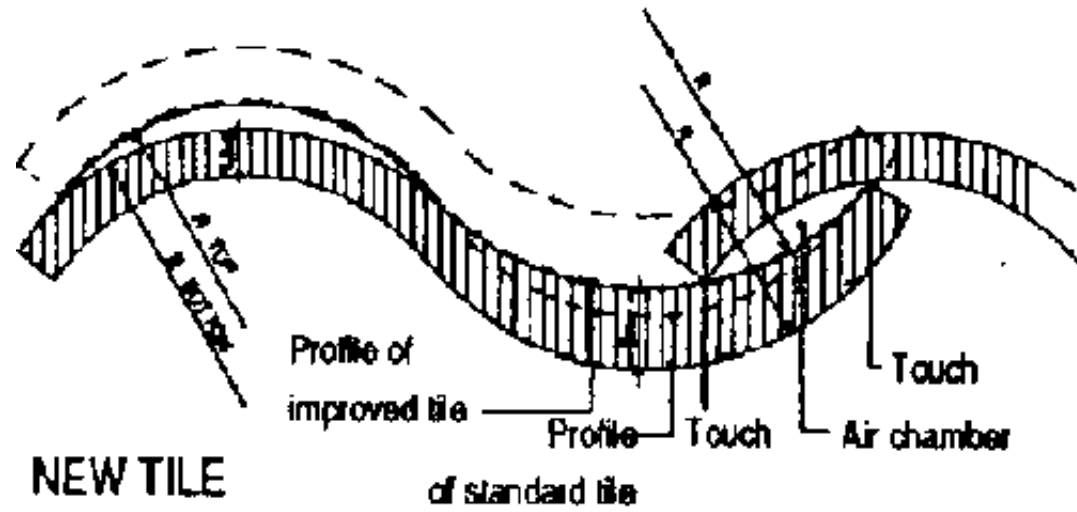

FIGURE

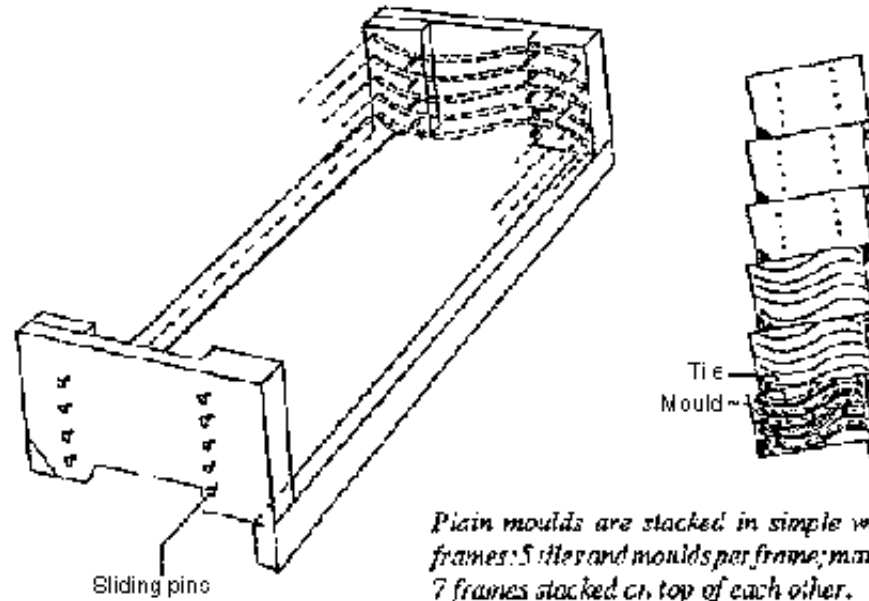

Plain moulds are stacked in simple wooden frames: 5 tiles and moulds per frame; maximum 7 frames stacked on top of each other.

FIGURE

Tile moulds with stacking ridges can be piled up in stacks of 5 tiles.

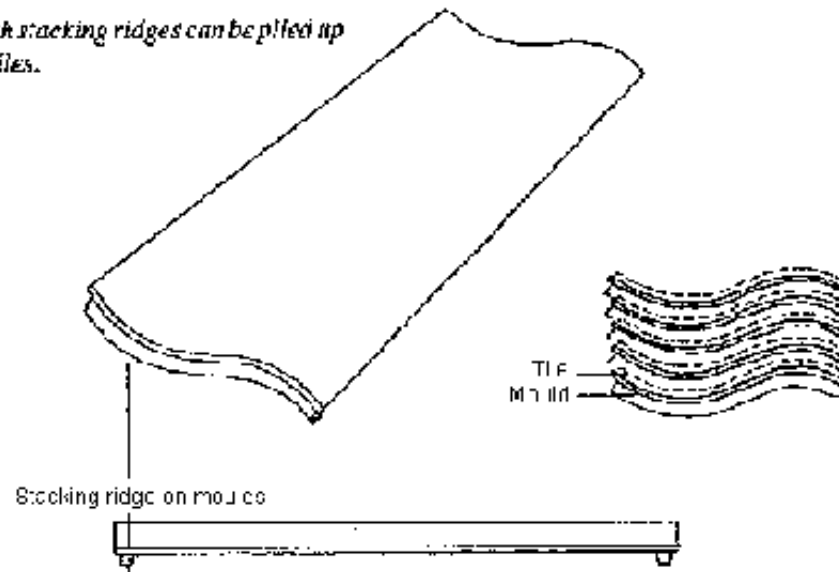

FIGURE

typical rafter dimensions at 1,2 m cc

- up to 2,0m free span 50 x 100 mm sw
- up to 3,6m span with one bracing in centre
50 x 100 mm sw
- up to 3,0m without bracing 50 x 150mm sw.
- up to 4,5m with bracing 50 x 150mm
- above that, ask advise from structural engineer.

average quantity softwood
required per m² roof
approx 0,72 m³
(20 dm³)

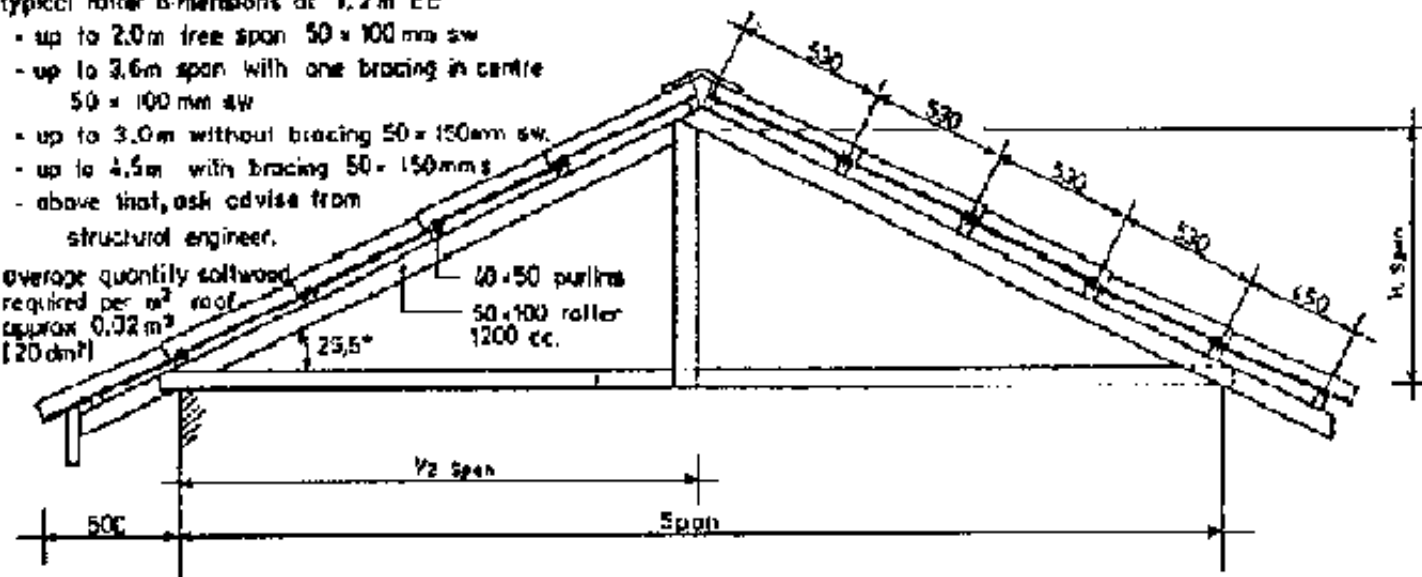

Span = width of house = 675 (number of tiles) - 750

Number of tiles to cover house = $\frac{\text{width of house} + 750}{175} \times \frac{\text{length of house} + 960}{240}$

FIGURE