



➔  **Quality Control Guidelines - Fibre or Micro Concrete Tiles (SKAT, 1991, 79 p.)**

 **(introduction...)**

 **1. Introduction**

 **2. Raw materials**

 **(introduction...)**

 **Cement / Visual test**

 **Cement / Quality test**

 **Sand & aggregate clay & silt content test**

 **Sand & aggregate moisture content test**

 **Sand & aggregate grading test**

 **Fibres chemical purity**

 **3. Production process**

 **(introduction...)**

 **Mortar preparation workability test**





 **Mortar preparation mortar strength test**





 **Demoulding / Size and shape**

 **4. End control**

 **(introduction...)**

 **Pore and crack test**









-  **Ring test**
-  **Bending test**
-  **Nib tensile test**
-  **Water tightness test**
-  **Weight test**

-  **5. Further readings**
-  **Annex 1 - Summary of tests**
-  **Annex 2 - Preparing sample sand**
-  **Annexes related**



[Home](#) > [ar](#) [cn](#) [de](#) [en](#) [es](#) [fr](#) [id](#) [it](#) [ph](#) [po](#) [ru](#) [sw](#)



-  **Quality Control Guidelines - Fibre or Micro Concrete Tiles (SKAT, 1991, 79 p.)**
- ➔  **(introduction...)**
-  **1. Introduction**
-  **2. Raw materials**
-  **3. Production process**
-  **4. End control**
-  **5. Further readings**
-  **Annex 1 - Summary of tests**
-  **Annex 2 - Preparing sample sand**



Annexes related

Tests for the quality control of the raw materials, the production process and the end product.

A co-publication of the Swiss Center for Appropriate Technology (SKAT) and the International Labour Office (ILO), supported by the Swiss Development Cooperation (SDC)

**FCR / MCR TOOLKIT-DIAGRAM:
NATIONAL CENTER KIT**

PROMOTION KIT

PRODUCER KIT

- 1 National Center Guide
- 2 Feasibility Study Guide
- 3 Guide for Trainers
- 4 Standards Guide
- 5 FCR / MCR, a comparison
- 6 Constraints in Dissemination of FCR/MCR Technology

- 10 FCR/MCR Basics
- 11 Case Reports
- 12 Product Information
- 13 Promotion Material

Technical Part

- 20 Workshop and Equipment
- 21 Production Management Guide
- 22 Production Guide
- 23 Quality Control Guidelines
- 24 Roof Design Guide

Economical Part

- 30 Basic Business Economics
- 31 Adv. Business Economics
- 32 Marketing Guide

Figure

Authors: Hans-Erik Gram and Paul Gut

Editing Committee: Karl Wehrle, Roland Stulz, Gilbert Brys

Co-Published by: SKAT, Swiss Center for Appropriate Technology in collaboration with ILO, International Labour Office Employment and Technology Branch

First edition: 1991 by SKAT, Swiss Center for Appropriate Technology and ILO, International Labour Office

Layout: SKAT P. Gut

Illustrations: Jose Benites

Cover: SKAT

Copyright: by SKAT, St. Gallen, Switzerland, and ILO, Geneva, Switzerland

Comments:

Please send any comments concerning this publication to: SKAT, Tigerbergstr. 2, CH-9000 St. Gallen, Switzerland

Printed by: Niedermann, St. Gallen, Switzerland

ISBN: 3-908001-23-4 (SKAT)

92-2-107864-7 (ILO)

Distribution by: SKAT-BOOKSHOP Tigerbergstr. 2 CH-9000 St. Gallen, Switzerland

Phone: *41 (0)71 302585, Fax: *41 (0)71 224656

March 1991, 1000 ex

The designations employed in ILO publications, which are in conformity with United Nations practice, and the presentation of material therein do not imply the expression of any opinion whatsoever on the part of the International Labour Office concerning the legal status of any country, area or territory or of

its authorities, or concerning the delimitation of its frontiers.

The responsibility for opinions expressed in signed articles, studies and other contributions rests solely with their authors, and publication does not constitute an endorsement by the International Labour Office of the opinions expressed in them. Reference to names of firms and commercial products and processes does not imply their endorsement by the International Labour Office, and any failure to mention a particular firm, commercial product or process is not a sign of disapproval.

F = Field (workshop) test

L = Laboratory test



[Home](#) > [ar.cn.de.en.es.fr.id.it.ph.po.ru.sw](#)

 **Quality Control Guidelines - Fibre or Micro Concrete Tiles
(SKAT, 1991, 79 p.)**



(introduction...)



1. Introduction



2. Raw materials



3. Production process



4. End control



5. Further readings



Annex 1 - Summary of tests

Annex 2 - Preparing sample sand

Annexes related

1. Introduction

What are FCR and MCR

FCR (Fibre Concrete Roofing) is a new roof covering technology. It consists of concrete tiles made of cement mortar mixed with a small amount of natural or synthetic fibre. Today many producers have abandoned the use of fibre. This product is called Micro Concrete Roofing or MCR.

The FCR/MCR Toolkit

This guide is one element of the FCR/MCR Toolkit. This kit mediates the entire know-how that is required in the field of the FCR-technology, covering all technical aspects as well as the economical, organizational, management and

marketing aspects. The toolkit-diagram shows the structure of its contents. The kit is now (1991) at its development stage. Many elements are already available, other elements exist in a draft version or at least in an outline. The entire kit or elements of it are available from SKAT.

What you will find in this guidelines:

The guidelines provide detailed technical information on how to control and test the quality of the product. It contains a systematic guideline on how to test

- **the raw materials**
- **the production process**
- **the product.**

What you will NOT find in this guidelines:

The guidelines are intended for persons who already know the basics of FCR/MCR or who are already producing FCR/MCR elements. Consequently it does not contain:

- **the basic information required for new-comers such as advantages and disadvantages, and guidelines to be considered as first steps towards FCR/MCR.**

It also does not contain:

- **rules for the production**
- **information on production management**
- **specifications of cost and profit**
- **information about particular problems in particular countries**

If you are interested in basic information we suggest you procure and read the following booklet:

“The Basics of Concrete Roofing Elements. Fundamental Information on the Micro Concrete Roofing (MCR) and the Fibre Concrete Roofing (FCR) Technology for New comers, Decision makers, Technicians, Field Workers and all those who want to know more about MCR and FCR. ” (available free of charge in English, French and Spanish). This publication as well as the FCR/MCR toolkit and further information are available from

**SKAT
Roofing Advisory Service
Tigerbergstrasse 2
CH-9000 St. Gallen
Switzerland
Tel 071 /30 25 85**

Objectives of this guidelines

The roof constitutes the most important part of a building and special care has to be taken in preparing the roof and the roofing elements. The best available

raw materials should be used and throughout the production process it should be kept in mind that a bad quality roofing product will not only result in a failing roof but may also lead to severe damage to the whole building.

To promote the FCR/MCR technology a product of high and constant quality is required. This is not only needed to gain and maintain a reputable product but also because misinvestments can not be afforded by the low income sector . Therefore, systems of constant quality control and assurance as well as adequate technology transfer and comprehensive dissemination of know-how are important tools in the production process of FCR/MCR. This guidelines are designed for advisory centres and producers, to facilitate the implementation of the necessary tests in a standardised manner. These tests should become a routine part of the production process. The chances of improved production on a broad basis are then increased, benefiting from the well established technological know-how that exists.

The structure of this guidelines

The guidelines are structured on a modular basis, consisting of tests for laboratory use and tests for field (workshop) use. The numbering system (code) allows an easy update at the stage of an eventual later edition in case additional or other tests are to be included. The systematic also corresponds to the Production Guide (Toolkit-Element 22) so that these two guides can easily be used side by side.

The field tests:

Simple tests that can easily be implemented on the workshop level are printed on yellow paper and are numbered with the code x.x.10.

The laboratory tests:

Some tests are too difficult to be reliably implemented in a simple workshop situation. They require higher qualified personnel and also specific equipment. These tests are printed on brown paper and are numbered with the code x.x.20.

Description of tests:

The description of tests contains information about the reasons for testing, the method, the person that should implement and the moment when the test should be carried out. Also information is given about the result to be achieved and the consequences in case the test fails.

The summary:

In the summary all tests are listed with indication of the frequency and the time when the tests should be implemented.

The reporting formats:

The annex contains reporting formats numbered with the code of the related test. They are an important working instrument to maintain proper records.

Spare formats for use in the workshop or laboratory you can find in the back-cover.

Bibliography:

At the end of this guidelines you find a bibliography with recommended further readings.

Rules for production

Complementary to these guidelines the Production Guide, element 22 of the toolkit, shall be used. It is concipated with a corresponding structure and numbering system and contains the necessary guidelines and rules for the production.

General remarks

Responsibility:

For each test it is specified who shall implement it. However, the sole responsibility that the tests are done correctly and at the right time, and also that the records are filled in, should lie with one person (i.e. the head of the workshop). Keep the records for at least five years.

Validity of the figures:

The rules and figures presented in this guidelines are based on a general average. Figures such as the mix to be used, compaction and curing time as

well as the test results etc. may vary slightly from place to place. Experience will tell you the exact dates that are valid for a particular workshop.

Comments:

Comments and feed back information are welcome and will help to further improve these guidelines and with it the technology. They may be sent to SKAT.

Acknowledgment

We would like to thank all the persons that were helping us with their valuable comments and remarks based on their wide experience. The draft version of these guidelines was field tested in various leading workshops, and their contribution was an important input to guarantee its practical suitability. The following groups participated in this field testing phase:

Development Alternatives, New Delhi

Development and Consulting Services, Butwal, Nepal

Grupo Sofonias, Caribbean

Mateco SA, Peru

Intermediate Technology Development Group, Kenya



[Home](#) "" "" "" "" > [ar.cn.de.en.es.fr.id.it.ph.po.ru.sw](#)



Quality Control Guidelines - Fibre or Micro Concrete Tiles (SKAT, 1991, 79 p.)

2. Raw materials

 **(introduction...)**

 **Cement / Visual test**

 **Cement / Quality test**

 **Sand & aggregate clay & silt content test**

 **Sand & aggregate moisture content test**

 **Sand & aggregate grading test**

 **Fibres chemical purity**

Quality Control Guidelines - Fibre or Micro Concrete Tiles (SKAT, 1991, 79 p.)

2. Raw materials

Introduction

The use of good quality raw material is vital for the quality of the end product.

The basic raw materials required for the production, where tests are involved, are:

2.1 Cement

2.2 Sand and fine aggregate

2.3 Fibre

Cement / Visual test

Fieldtest

Why this test

Too old cement contains lumps, especially under humid conditions. Such cement gives a poor tile quality.

How

Check visually, if the cement contains lumps.

Who

Foreman

When

Every morning; always when a new part of the stock is used.

Result

Record keeping: yes

The cement shall be free of lumps.

Consequence

If test fails

If there are small and soft lumps, break and pass them through a 0.5 mm sieve, use richer mortar, for instance by using 50 % of this cement and 50 % of another, better cement.

If there are hard lumps, do not use the cement, because the setting process of such cement has already started and the product would not gain the required strength anymore.

Cement / Quality test

Laboratory test

Why this test

Cement from different sources may have different properties. This can influence the mix standard to be used.

How

Laboratory test methods according to standard methods given by B.S., ASTM or DIN (strength, setting time, fineness, SO₃ content, soundness).

Who

Laboratory staff

When

When cement from different suppliers is introduced or when the cement quality is questioned.

Result

Record keeping: yes

The setting time for cement should be more than 60 minutes and less than 6 hours.

Consequence

If the setting time is longer than 2 - 3 hours special care concerning water evaporation from the mix and from the freshly cast roofing products has to be taken.

Sand & aggregate clay & silt content test

Field test

Why this test

A too high clay and silt content affects the strength and durability of the tile.

How

Prepare the sample sand according to the rule described in annex 2.

Put the sand into a transparent jar, add water to about 50% above the sand level and shake the jar strongly for at least 30 seconds.



Water & Sand

Place the jar on a table and after at least one hour, when the water is clear, measure the thickness of the clay and silt layer (h_1) and the thickness of the total material layer (h_2).

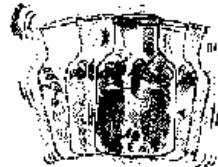

Shake strongly and wait until the water is clear

Calculate the clay and silt content by dividing h_1 in mm with h_2 in mm and multiply with 100.



$$\text{Clay and silt content} = 100 * h_1 / h_2$$

The strength test shows, how high the maximum acceptable clay and silt content is.

To achieve the required accuracy, the height of the jar should be at least double the diameter.

Who

Foreman

When

During the establishment of mix proportions of the mortar and each time when a new source of deposit is exploited.

Result

Record keeping: yes

The clay and silt content may usually not exceed 4 %.

Consequence

If test fails

If the clay and silt content is too high, wash the sand or look for a more suitable source.

Washing the sand implies the danger that also too much of the fine sand components is lost. Therefore make afterwards the grading test (see 2.2.21).

Sand & aggregate moisture content test

Laboratory test

Why this test

To determine more accurately the quantity of water to be added to the mix, the moisture content of the sand has to be considered. A too high water content results in a higher water to cement ratio. As a consequence the product would be porous, with low strength and insufficient water tightness.

How

Prepare the sample sand according to the rule described in the annex 2.

Take about 400 g sand, determine the actual quantity on a scale (Q_1), put the sand into a frying pan for instance and heat the sand so that the water totally

evaporates.

Let the dry sand cool down for ten minutes. Determine the weight of the dry sand (Q_2).

Calculate the moisture content by using the following formula:

$$(Q_1 - Q_2) \times 100 / Q_1 = MC (\%)$$

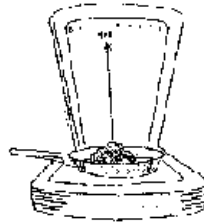

Determine weight of wet sand (Q_1)



Heat it

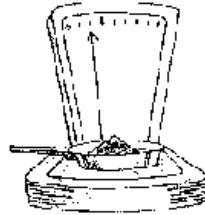

Determine weight of dry sand (Q₂)

Who

Laboratory staff

When

During the establishment of the mix proportions of the mortar.

Result

Record keeping: yes

The weight of the sand multiplied with the moisture content equals to the absolute amount of water that the sand contains.

$Q_1 \times MC (\%) = \text{moisture content in g}$

Consequence

The water to cement ratio of the mix is of great importance (see also "Production Guide" paragraph 3.1). Therefore the moisture content of the sand has to be included when calculating the quantity of water to be added to the mix.

Sand & aggregate grading test

Laboratory test

Why this test

The grading of the sand and aggregate should be within the values given below. These are recommended to achieve a harmonic particle size distribution curve.

Particle size distribution with mostly fine particles will result in an easy workable mix, but the cement consumption is higher and the shrinkage of the product is bigger.

More coarse aggregates will result in a more harsh mix, but the cement consumption and shrinkage are less.

How

Prepare the sample sand according to the rule described in annex 2.

Use BS or ASTM or DIN - norms.

Who**Laboratory staff****When****Each time the sand deposit is filled.****Result****Record keeping: yes****Grading for FCR:**

The quantity of sand remaining on the 2 mm sieve should be less than 10 %. Already a few per cent remaining on the 2 mm sieve indicates that the sand preparation has to be controlled. (Control the openings of the sieve, check the sieving procedures).

Maximum grain size	2 - 3 mm
Component above 2 mm	0 - 10 %
Component 0.5 - 2 mm	35 - 75 %
Component below 0.5 mm	25 - 55 %

Grading for MCR:

If micro concrete roofing products (without adding fibres) are prepared, the maximum grain size of the aggregate should not exceed two thirds of the thickness of the product.

Product thickness	6 mm	8 mm	10 mm
Maximum grain size	4 mm	5.5 mm	7 mm
Component above 2 mm	25-45 %	30-50 %	35-55 %
Component 0.5- 2 mm	20-50 %	10-55 %	10-50 %
Component below 0.5 m	15-45 %	15-40 %	15-40 %

No particle may be bigger than product thickness minus 1 mm.

Consequence

If test fails

If the grading differs from the above limits, an alternative suitable source should be selected.

Fibres chemical purity

Laboratory test

Why this test

Polluted fibre reduces the strength of the tile and lengthens the setting time of

the mortar.**How**

Put about 20 g of fibres into about 0.1 litre of water (an ordinary water glass) and store them in the water for 2 hours. Keep also a glass of clean water beside the fibre water glass.

Remove the fibres and discard. Mix exactly 50 g of cement with 15 g of the fibre water in a container and keep the container close to the fibre water glass. Prepare at the same time a mix of 50 g cement and 15 g of clean water and place the container close to the clean water glass.

During setting time cover the containers with a plastic sheet.

Check the stiffening time of the two cement pastes every 30 minutes by pressing the sharp end of a pencil or a nail into the surface. Note the time when the paste is so hard that the pencil or the nail only with difficulty can be pressed deep (3 mm) into the paste.

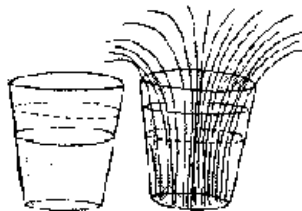

Clean water / 20 g fibres in 0.1 l water for 2 hours

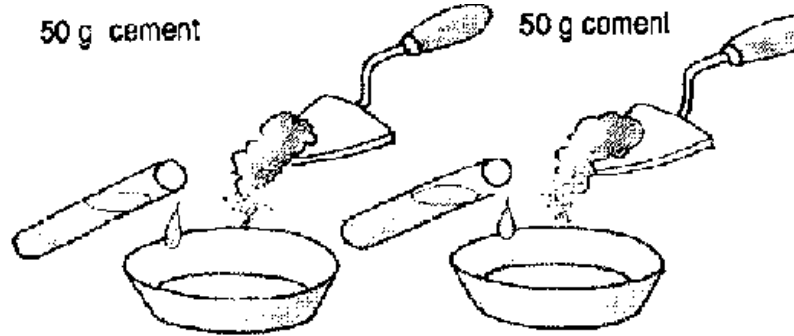

Mix 50 g cement with 15 g water



Check stiffening every 30 minutes

Who

Laboratory staff

When

When a bad fibre quality is suspected.

Result

Record keeping: yes

The stiffening time of the fibre water paste should not be considerably longer than that of the clean water paste.

Consequence

If test fails

If the stiffening time of the fibre water paste is more than double that of the clean water paste or if the stiffening time of the fibre water paste is more than 50°/0 longer than earlier tests have shown the fibres should be washed in water before being used.



[Home](#) > [ar.cn.de.en.es.fr.id.it.ph.po.ru.sw](#)

 **Quality Control Guidelines - Fibre or Micro Concrete Tiles (SKAT, 1991, 79 p.)**

➔  **3. Production process**

 **(introduction...)**

 **Mortar preparation workability test**



Mortar preparation mortar strength test Demoulding / Size and shape

Quality Control Guidelines - Fibre or Micro Concrete Tiles (SKAT, 1991, 79 p.)

3. Production process

Introduction

Beside the quality of the raw materials, careful production is the other important requisite for a high standard product.

The tests involved in the production process are:

3.1 Mortar preparation

3.4 Demoulding

Mortar preparation workability test

Fieldtest

Why this test

An easy way of controlling that the right mix proportions have been used in the mortar is to check its workability.

How

The workability can be measured in the following way:

Place a plastic interface sheet on the vibrating table top. Place a standard mould in the center of the table top. Press the mould down to the table and fill it with mortar and tamp the mortar 20 times with a tamper (for instance the thick end of a pencil).

Cut off the mortar flush with a trowel.

Remove the mould, start the vibrator and let it work for exactly 10 seconds or the time you would normally use when producing your tiles (should not exceed 20 seconds). For pedal driven vibrators count also the cycles, e.g. 14 each leg in approx. 10 seconds.

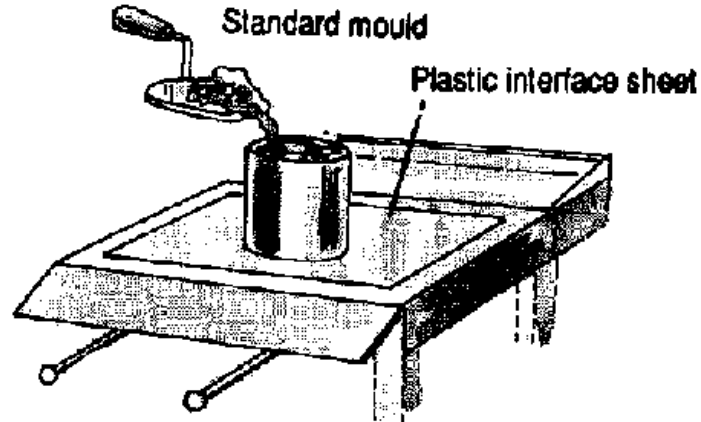
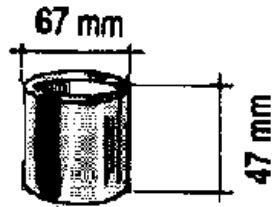

Fill mould with mortar



Tamp the mortar 20 times



Cut off the mortar flush

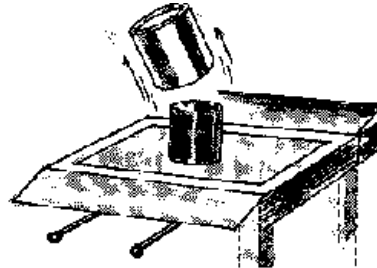

Figure

Who

Foreman

When

The workability of the mortar should be controlled for each mix immediately before casting the first tile and before casting the last tile.

Result

Record keeping: yes

Measure the average diameter of the mortar "pancake" that results.

Consequence

The bigger the diameter of the "pancake", the shorter vibration time is needed for the compaction. If the workability is too high, the mortar might be overvibrated during production, i.e. the components of the mix may separate. In this case the water addition has been too high. (The sand may also be too wet). You should therefore add extra cement to the mix.

Experience tells you what the best workability for a given raw material is.

If the workability differs more than 20 % from your standard adjust the mix. If too stiff, add cement paste (a mixture of water and cement with fixed, low water to cement ratio). If too wet, add sand.

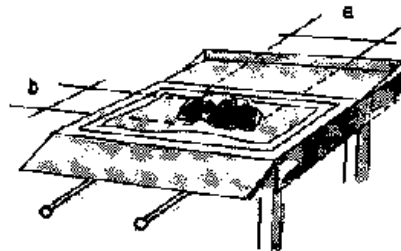

$$(a + b) / 2 = \text{workability}$$

Mortar preparation mortar strength test

Laboratory test

Why this test

The strength development of the mortar has to be tested

- to determine the best mix and to control the quality of the raw materials.**
- to control if the FCR/MCR products have gained enough strength prior to demoulding (after 24 h).**

In a situation where this test is too complicated it may be substituted with the "Bending Test" (4.3.10).

How

The strength development of the mortar can be controlled on specially prepared specimens.

The specimens could be prepared for mortar produced at the end of the day.

Procedure:

Place a plastic interface sheet on the vibrating table and place the special prism mould on the plastic interface sheet. Press the mould down with one hand and fill it with mortar. Cut off the mortar flush with a trowel, start the vibrator and let it work for exactly 10 seconds (or the time you would normally use for casting the tiles). Press the mould down with two fingers during the

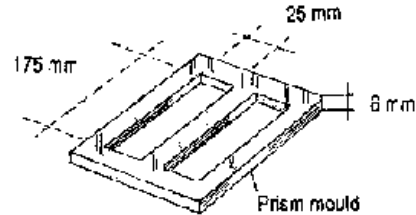
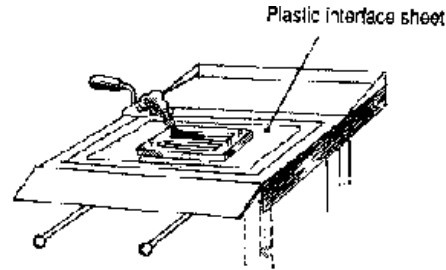
whole operation.**Figure****Vibrating table**

Transfer the plastic interface sheet with the mould over to a plank or other flat surface. Cover the mould immediately with another plastic interface sheet and a plank.

Demould the two specimens after 24 hours (or according to the time you intend to demould your tiles) and test one of them immediately. Mark the

second specimen with the date and store it in the curing tanks together with the FCR/MCR products produced the previous day.

The specimens tested at the age of 28 days should be cured in the same way as the FCR/MCR products, i.e. in water for at least 5 days and in air protected against sunshine and fast evaporation for one week. After the curing period the specimens may be stored dry in the workshop.

The strength test is done by placing the specimen into the strength test rig and placing the appropriate weight, 100 g for the 24 hour old specimen and 500_g for the 28 day old specimen on the edge of the specimen.

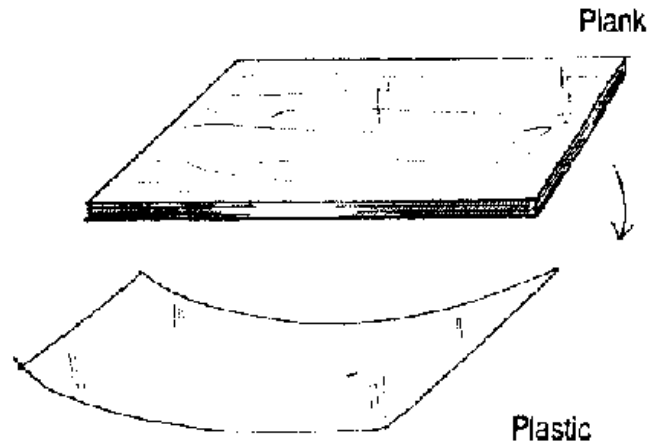

Figure

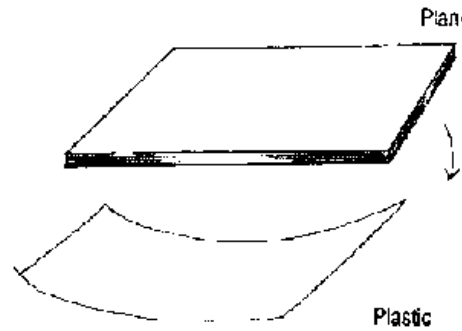

Figure

100 g weight at the age of 24 hours

500 g weight at the age of 28 days

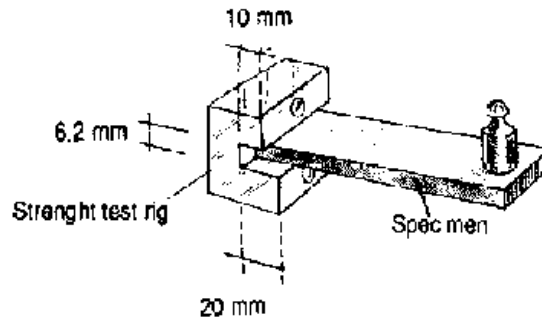

Figure

Who

Foreman or laboratory staff

When

The mortar strength test should be done once a day. The strength of the specimens should be determined after 24 hours or according to the time you intend to demould the tiles.

Result

Record keeping: yes

If the specimen does carry the load it has a flexural strength of at least 1 MPa (N/mm² or 10 kp/cm²) after 24 hours and at least 5 MPa after 28 days.

This is sufficient for a good quality tile.

Consequence

If test fails

1. A specimen tested after 24 hours fails:

It can be tested again by putting the other end of the specimen into the strength test rig and applying the actual weight (100 g) on the previously broken edge. If the specimen carries the load no other action is necessary other than preparing new specimens for testing the following day.

2. The specimen also fails this second test: The demoulding of the FCR/MCR products cast the previous day should be delayed for some hours and the demoulding be made under special care. All the FCR/MCR products produced during this period should be water cured for five extra days.

Before new FCR/MCR products are produced the reasons for the low strength must be found. Prepare new test specimens and test both of them after 24 hours. If they also fail:

- change the water to cement ratio,**
- or use a different type of cement,**
- or increase cement quantity,**
- or use a different type of sand.**

3. The 28 day test fails: The regional center should be contacted for investigating the reasons for the failure.

Demoulding / Size and shape

Field test

Why this test

Only the correct size and shape of all tiles ensures a proper fixing on the roof. Poorly fitting tiles easily crack under load and wind driven water may enter the roof.

Tiles that are not square will not fit properly and the overlap will not be sufficient.

Tiles that are too thin will leak and are not strong enough.

How

Check every tile that it has the right dimensions, shape and profile during the demoulding operation. For tiles the special quality control jig developed by JPM Parry can be used.

Hold the mould on edge and place the tile against the quality control jig. Roll the mould with the tile over on the jig's pivots until upside down. Lift the mould off. Remove the plastic interface sheet by pulling straight across from the side edge.

Run around tile edge with a knife to remove any excess flash. Check carefully that the tile fits the jig and does not wobble.

The edge of the bar should be seen, but should not have a gap showing beneath it.

If the jig is not available the test can also be done on a mould.

Always use an especially assigned mould only used for this purpose. If a plastic mould is used then it must be adequately supported to prevent flexing.

Squareness:

Test on a standard mould that the edges of the tile are parallel with the mould.

Thickness at the edges:

Check if the thickness of the upper part of the tile (a) differs from the thickness of the lower part of the tile (b). For a 6 mm thick tile it should range between 5.5 and 6.5 mm. Check on both ends of the tile.

Thickness in the middle:

Occasionally, check also the thickness of the tile in its center, by breaking the tile.

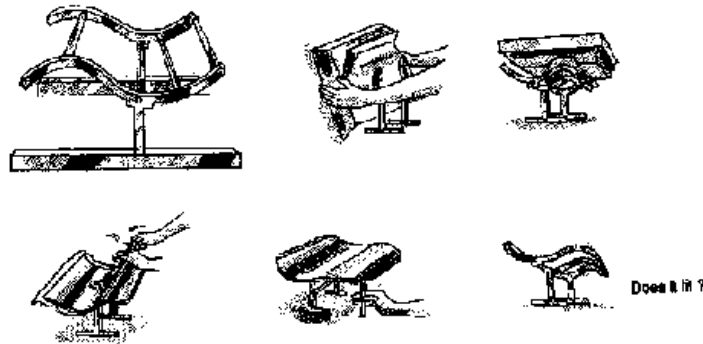

Figure

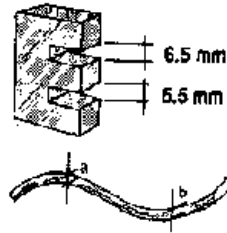
**Figure****Who****Worker****When****During demoulding****Result****Record keeping: yes****The product should be within the following tolerances:**

Tolerance on length	+/-	10 mm
Tolerance on width	+/-	5 mm
Tolerance on profile	+/-	3 mm
Tolerance on thickness	+/-	0,5 mm

Tolerance on squareness ± 3 mm

Consequence

If test fails

Discard tiles that fail the test. If the thickness varies too much the mix has to be examined and/or the worker should improve his performance.









[Home](#) > [ar.cn.de.en.es.fr.id.it.ph.po.ru.sw](#)



Quality Control Guidelines - Fibre or Micro Concrete Tiles (SKAT, 1991, 79 p.)



- 4. End control**
-  **(introduction...)**
-  **Pore and crack test**
-  **Ring test**
-  **Bending test**
-  **Nib tensile test**
-  **Water tightness test**
-  **Weight test**

Quality Control Guidelines - Fibre or Micro Concrete Tiles (SKAT, 1991, 79 p.)

4. End control

Introduction

Shortly before the tiles are sold or - in case the producer installs the tiles - just before installation the end control is done.

Some tests have to be done with every single tile, others can be done on a random sample basis.

The tests are:

4.1 Pores and cracks

4.2 Strength (ring test)

4.3 Bending test

4.4 Nib tensile test

4.5 Water tightness

4.6 Weight

Pore and crack test

Field test

Why this test

Too many and too large pores are a sign of insufficient compaction due to incorrect workmanship during mixing or vibrating.

Cracks are not only a potential point of leakage but also of reduced strength. Even if the tile should pass the strength test, its durability is reduced.

How

Every tile should be visually checked for pores and cracks.

Surface:

Control if the FCR/MCR product has any surface pores deeper than 2 mm or surface pores with a diameter larger than 5 mm.

Check also if the number of surface pores on the whole tile with a diameter greater than 2 mm is bigger than six.

Holes:

Holes are not acceptable.

Cracks:

Control if the FCR/MCR product has any visible cracks longer than 5 mm.

Who

Worker

When

Before selling

Result

**Record keeping: yes
see above**

Consequence

If test fails

Reject units that have

- too deep pores**
- or pores with a diameter greater than 5 mm**
- or more than six pores with a diameter greater than 2 mm.**

Also reject FCR/MCR products with visible cracks in length greater than 5 mm.

Note the number of rejected units as well as the reason for it.

Ring test

Field test

Why this test

Tiles may have cracks or other weak portions that are not visible, but which sharply reduce the integrity of the tile and with it the strength and durability.

How

Every tile should be tested. The test is done by tapping the tile with a coin or a stone.

The tile must be dry.



Figure

Who

Worker

When

Before selling

Result

Record keeping: yes

A clear ring should be heard. If there is a dull sound the tile is probably cracked and should be rejected.

Consequence

If test fails

Reject failing tiles.

Bending test

Field test

Why this test

This test is an alternative possibility to test the mortar strength. It may substitute the mortar strength test (3.1.20).

How

1 % of the tiles may be tested.

The tile shall be dry when tested. The tile is supported by battens at a distance of 350 mm. In the center between the support a weight is placed over a plank fitting exactly to the profile of the tile. Put a 5mm thick rubber between the

plank and the tile for even distribution of the load.

The test is more accurate when wet tiles are tested, after they have been immersed in water for 24 hours. Then the corresponding load is to be reduced by about 15%.

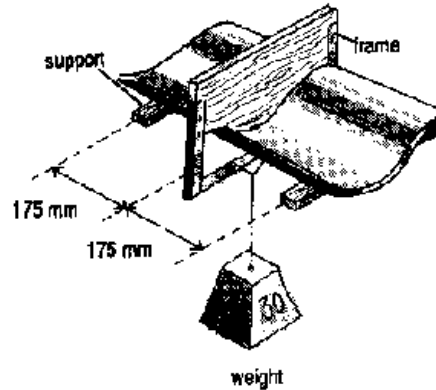

Figure

Who

Foreman

When

Before selling

Result

Record keeping: yes

The tile, when tested dry, must not break under the following load:

A 6 mm thick tile should bear 30 kg weight

A 8 mm thick tile should bear 50 kg weight

A 10 mm thick tile should bear 80 kg weight

Consequence

If test fails

If the test tile breaks, other tiles should be tested as well.

Make the test with two tiles. If one of them fails, keep the rest of the tiles from this batch covered (air curing) for another 14 days and repeat the bending test on three tiles. If one or more of them fail the test, contact the regional center for further investigations. Do not sell tiles from this batch.

Nib tensile test

Field test

Why this test

A firm connection of the nib to the tile and of the wire to the nib is essential for a safe roof.

How

1 % of the tiles shall be tested, by suspending a 20 kg weight on the loop of the nib.

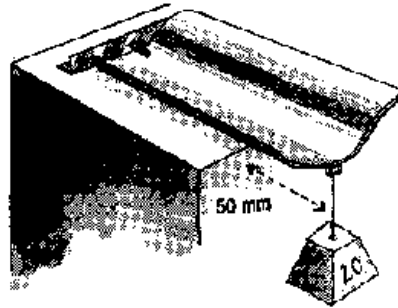

Figure

Who

Foreman

When

Before selling

Result

Record keeping: yes

The nib should bear a weight of 20 kg without cracking.

Consequence

If test fails

If the test tile fails, other tiles should be tested as well. Make the test with two tiles. If one of them fails, keep the rest of the tiles from this batch covered (air curing) for another 14 days and repeat the nib tensile test on three tiles. If one or more of them fail the test, contact the regional center for further investigations. Do not sell tiles from this batch.

Water tightness test

Field test

How

1 % of the tiles should be tested.

Form two small weirs to allow water to stand in a pool. Make weirs using wet mortar or clay. Put the tile on supports away from the weirs. Carefully fill with water.

Remark:

The test works only if the atmosphere is humid (minimum 70 % relative humidity). In a warm and dry climate eventual seepage dries immediately, so

that it can not be observed.

During dry season the test has to be done in a high-humidity chamber or by covering the test set-up with a plastic sheet.

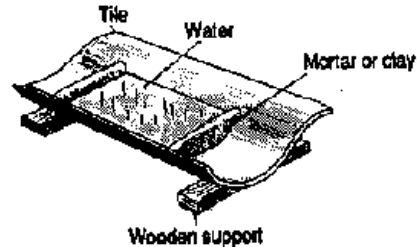

Figure

Who

Foreman

When

Before tiles are shipped to the customer.

Result

Record keeping: yes

If after 24 hours there is no free water (drips) on the underside of the tile, it has passed. There may be signs of damp, but this area should not exceed 50 %

of the total tile area.

Consequence

If test fails

If one or several of the FCR/MCR products tested are not water tight, the whole production process has to be controlled with special emphasis on the mix proportions (the water to cement ratio) and the curing operation.

Weight test

Laboratory test

Why this test

Determining the weight of the tiles is one easy way of controlling the dimensions, especially the thickness.

How

Take 4 randomly chosen tiles from each week's production, store them dry for 24 hours and weigh them.

Good scales are essential.

Who

Foreman or laboratory staff

When

When the tiles are dry.

Result

Record keeping: yes

The weight of the tile should not differ more than 10 % from the expected weight.

Consequence

If test fails

If the weight differs more than 10 % from the expected weight (mean value of tiles with nominal thickness) the casting procedures have to be examined.



[Home](#) > [ar.cn.de.en.es.fr.id.it.ph.po.ru.sw](#)

 **Quality Control Guidelines - Fibre or Micro Concrete Tiles (SKAT, 1991, 79 p.)**

 **(introduction...)**

 **1. Introduction**

 **2. Raw materials**



- ☐ **3. Production process**
- ☐ **4. End control**
- ➔ ☐ **5. Further readings**
- ☐ **Annex 1 - Summary of tests**
- ☐ **Annex 2 - Preparing sample sand**
- ☐ **Annexes related**

5. Further readings

(E) = English; (F) = French; (S) = Spanish

01 Brys, Gilbert: Tuiles en fibromortier. Procd de production et pose en toiture, Technology Series, Memorandum No. 16, International Labour Office (ILO), Geneva, 1988 (F)

02 Evans, Barrie: Understanding Natural Fibre Concrete, Its Application as a Building Material, IT Publications Ltd., London, 1986 (E)

03 Gram, H.E.; Parry, J.P.M.; Rhyner, K.; Schaffner, B.; Stulz, R.; Wehrle K.; Wehrli, H.: FCR - Fibre Concrete Roofing. A comprehensive report on: The Possibilities of Fibre Concrete Roofing. The Limits of Application, and The State

of the Art, SKAT, St. Gall, 1986 (E)

04 Heierli, Urs; Beck, Victor: FCR - Fibre Concrete Roofing, Feasibility and Market Study Guides, SKAT, St. Gall, 1987 (E)

05 Lola, Carlos R.: Fibre Reinforced Concrete Roofing Sheets, Technology Appraisal Report, AT International, Washington, D.C., 1985 (E)

06 Parry, John: Fibre Concrete Roofing, Intermediate Technology Workshops, Cradley Heath, 1985 (E)

07 SKAT: The Basics of Concrete Roofing Elements, Fundamental Information on the Micro Concrete Roofing (MCR) and Fibre Concrete Roofing (FCR) Technology for Newcomers, Decisionmakers, Technicians, Field Workers and all those who want to know more about MCR and FCR, SKAT, St. Gall, 1989 (E)

08 SKAT: Informacin Bsica Sobre Techos de Micro Concreto (TMC) y Fibro Concreto (TFC), Introduccin para Arquitectos, Tcnicos, Empresarios, Instituciones de Desarrollo y el Pblico Interesado en TMC y TFC, SKAT, St. Gallen, 1989 (S)

09 Stulz, Roland; Mukerji, Kiran: Appropriate Building Materials, A Catalogue of Potential Solutions, SKAT, St. Gall, GATE, Eschborn, IT Publications Ltd., London, 1988 (E)

10 Twigt, Fred Jan: Fibre Concrete Roofing in Malawi, Kenya, Tanzania, Zambia

and Uganda, FCR Advisory Services, SKAT, St. Gall, 1988 (E)

Audio-Visual Material

11 Macwhinnie, Ian: An Introduction to FCR/MCR Production, A BASIN Video, ITDG/GTZ-GATE, Eschborn, 1990 (E)



[Home](#) > [ar.cn.de.en.es.fr.id.it.ph.po.ru.sw](#)



Quality Control Guidelines - Fibre or Micro Concrete Tiles (SKAT, 1991, 79 p.)

 **(introduction...)**

 **1. Introduction**

 **2. Raw materials**

 **3. Production process**

 **4. End control**

 **5. Further readings**

 **➔ Annex 1 - Summary of tests**

 **Annex 2 - Preparing sample sand**

 **Annexes related**

Annex 1 - Summary of tests

F = Field (workshop) - test L = Laboratory test

RAW MATERIAL

F - 2.1.10 Cement / Visual Test

L - 2.1.20 Cement / Quality Test

F - 2.2.10 Sand & Aggregate / Clay & Silt Content Test

L - 2.2.20 Sand & Aggregate / Moisture Content Test

L - 2.2.21 Sand & Aggregate / Grading Test

L - 2.3.20 Fibres / Chemical Purity

PRODUCTION PROCESS

F - 3.1.10 Workability Test

L - 3.1.20 Mortar Strength Test

F - 3.4.10 Size and Shape Test

END CONTROL

F - 4.1.10 Pore and Crack Test

F - 4.2.10 Ring Test

F - 4.3.10 Bending Test

F - 4.4.10 Nib Tensile test

F - 4.5.10 Water Tightness Test

L - 4.6.20 Weight Test

Check			
2x/day	1x/day	1x/week	
	X		when opening a new bag
			at delivery
			at delivery
			occasionally
			each time sand deposit is filled
			occasional y

X			
	X		
			during demoulding

			before selling
			before selling
			before selling
			before selling
		X	
		X	

Figure

[Home](#) > [ar.cn.de.en.es.fr.id.it.ph.po.ru.sw](#)

 **Quality Control Guidelines - Fibre or Micro Concrete Tiles (SKAT, 1991, 79 p.)**

 **(introduction...)**





- ☐ **1. Introduction**
- ☐ **2. Raw materials**
- ☐ **3. Production process**
- ☐ **4. End control**
- ☐ **5. Further readings**
- ☐ **Annex 1 - Summary of tests**
- ➔ ☐ **Annex 2 - Preparing sample sand**
- ☐ **Annexes related**

Annex 2 - Preparing sample sand

For any test to be undertaken the sample sand should represent a good average of the stock. When the sand is stored, finer particles tend to separate out a bit. Therefore take sand from at least 6 different places in the deposit and place it on the floor in a heap. Part this heap into four parts, take two parts away and make a new heap. Part the second heap into four parts and take two parts away. Take about 200 g of the remaining parts for testing.

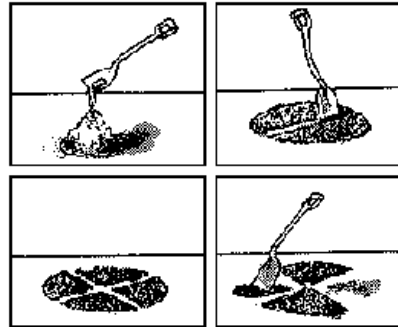







Figure

[Home](#) > [ar.cn.de.en.es.fr.id.it.ph.po.ru.sw](#)



 **Quality Control Guidelines - Fibre or Micro Concrete Tiles (SKAT, 1991, 79 p.)**

-  **(introduction...)**
-  **1. Introduction**
-  **2. Raw materials**
-  **3. Production process**
-  **4. End control**
-  **5. Further readings**
-  **Annex 1 - Summary of tests**



Annex 2 - Preparing sample sand

Annexes related

Annexes related

Reporting Format

Date of delivery	Date of control	Number of bags	Quality comments

CEMENT

Reporting Format

Date of delivery	Date of control	Quantity (kg)	Clay and silt content (max 4%)

SAND AND AGGREGATE

Reporting Format

Date of delivery	Date of control	Quantity (kg)	Moisture content (%)	Quantity of sand and aggregate		
				> 2mm	2 - 0.5 mm	< 0.5mm

SAND AND AGGREGATE

Reporting Format

Date of delivery		Quantity (kg)	Stiffening time for cement paste with	
	control		fibre water	clean water

FIBRES**Reporting Format**

Mix no.	Date of test	Workability

WORKABILITY TEST**Reporting Format**

Mix no.	Date of control	Test passed after 24 hours yes / no	Date of control	Test passed after 28 days yes / no

MORTAR STRENGTH TEST

Reporting Format

Date of control	No. of tiles tested	Number of tiles rejected because of			
		wobbling on jig	edge alignm.	thickness $a \neq b$	other reasons

SIZE AND SHAPE

Reporting Format

Date of production	Date of control	No of tiles tested	Number of tiles rejected because of				
			pores deeper than 2 mm	pores bigger than 5 mm	more than 6 pores > 2mm	holes	cracks longer than 5 mm

END CONTROL 1**Reporting Format**

Date of production	Date of control	No of tiles tested	Number of tiles rejected because of			
			Ring test	Bending test	Nib tensile test	water tightness

END CONTROL 2**Reporting Format**

Date of production	Date of control	Weight per tile	Difference from normal (%)

WEIGHT TEST**Reporting Format**

Date of delivery	Date of control	Number of bags	Quality comments

CEMENT**Reporting Format**

Date of delivery	Date of control	Quantity (kg)	Clay and silt content (max 4%)

SAND AND AGGREGATE

Reporting Format

Date of		Quantity (kg)	Moisture content (%)	Quantity of sand and aggregate		
delivery	control			> 2mm	2 - 0.5 mm	< 0.5mm

SAND AND AGGREGATE

Reporting Format

Quality Control Guidelines - Fibre or M...

Date of		Quantity (kg)	Stiffening time for cement paste with	
del very	control		fibre water	clean water

FIBRES**Reporting Format**

Mix no.	Date of test	Workability

WORKABILITY TEST**Reporting Format**

Mix no.	Date of control	Test passed after 24 hours yes / no	Date of control	Test passed after 28 days yes / no

MORTAR STRENGTH TEST

Reporting Format

Date of control	No. of tiles tested	Number of tiles rejected because of			
		wobbling on jig	edge alignment	thickness a ± b	other reasons

SIZE AND SHAPE

Reporting Format

Quality Control Guidelines - Fibre or M...

Date of production	Date of control	No of tiles tested	Number of tiles rejected because of				
			pores deeper than 2 mm	pores bigger than 5 mm	more than 8 pores > 2mm	holes	cracks longer than 5 mm

END CONTROL 1**Reporting Format**

Date of production	Date of control	No of tiles tested	Number of tiles rejected because of			
			Ring test	Bending test	No tensile test	water tightness

END CONTROL 2**Reporting Format**

Date of production	Date of control	Weight per tile	Difference from normal (%)

WEIGHT TEST

