

**Sudan Council of Churches \* Munuki Water and Sanitation Project**

by  
**Marta and Rudi Guóth-Gumberger**  
1987

**0. Introduction****0.2. Foreword**

Two people are named as authors of this training manual; however, in reality it is the result of the work of very many people. We hope that it will serve a great number of people as well.

The development of the manual has a long history. We had the opportunity to work with the Sudan Council of Churches from 1982 to 1987, first in the Integrated Rural Development Programme in Yirol, and then in the Munuki Water and Sanitation Project in Juba, both in Southern Sudan. We had been assigned as Water Supply Coordinator (Marta) and Community Development Coordinator (Rudi). In the beginning we had background knowledge but little field experience. So we started to learn with and from the people and from the literature. At the same time we started training the people with whom we worked. In the beginning the training was exclusively on site. However, in the second project, the training became more formalised into a full two years programme of both class and field work. We began from the actual level of knowledge of the trainees without the assumption that "one should know this or that", and gathered whatever knowledge was necessary to do the project work together. Soon, compiling and distributing of written material became necessary, and so this manual was begun.

It includes many of our experiences in the water and sanitation work during the last five years. The bulk of the information was ready in first draft in April 1987. Photocopies were distributed to the participants of a three months training course. Contributions and questions from the participants were invaluable, and many sections were revised/improved. Actually, the manual would have never been written without the eagerness of the Munuki project's staff to learn. This interest made learning and teaching very enjoyable. After the training course, the entire manual was revised further and finally completed to the present version.

We thank our colleagues in the Munuki Water and Sanitation Project for all we learned from them, for their good cooperation and for their contributions to the manual. They are: Edward Lako, Arthur A. Columbano Lado, Rhoda Benjamin, Joseph Lado Lubajo, Joan Batul Eliaba, Simon John Lubang, Gloria Habakuk Soro, Paulino Onorato Legge, Prissy M. Wai Wai, Jackson Onan. We also thank the course participants from Swedish Free Mission and Sudanaid for their contributions. They are: Inga Andersson, Margaret Toya, Isaac Kajokole Kenyi, James Jamil, James Wani, Lona Kojo Michael, Julius Sebit, Erasto Tupa, George Mogga Wani, Elijah Biar, Rose Paul, Robert Otik, Rhoda Yangi

**Wesley, Quintino Pitya, Anna Itto Njimirano, Ben Juma.**

**We extend our thanks also to Tom Benton, Sr. Margaret Donohue RSM, Paul McGleenan, Paul Hiebert, Char Holcomb, Stephen Power SJ, Dr. Douglas Reitsma, Susan Sunflower, Dr. Ruth Goehle, Betsy Bascom, for the tiresome work of proofreading.**

**We thank Mike Gogonya, Hakim Benjamin and Stephen Hakim for many of the drawings.**

**We are also very grateful to Michael Kubrom Habtai who shared his office with us during the weeks of final revision and typing, made the SCC library available for us and encouraged us with practical help and supporting words.**

**We thank the Sudan Council of Churches, and especially the Deputy General Secretary, Kosti Manibe, for the generous support which made this manual possible, by providing working facilities, financial resources, an electronic typewriter and numerous other resources.**

**There are many other individuals whom we would like to thank for their helpful contributions, but who are too numerous to be named.**

**We apologise for mistakes which remain in the manual in spite of revisions and corrections, and kindly ask the readers to send any corrections, comments and suggestions about the manual to one of the following two addresses:**

**Márta Guóth-Gumberger, Rudolf Gumberger  
Neue Heimat 5a  
D-83024 Rosenheim  
Germany  
Tel.: 08031/81103  
Fax: 08031/43695**

**Munuki Water and Sanitation Project  
Sudan Council of Churches  
P.O. Box 469  
Khartoum  
Sudan**

**For further copies of the manual please contact:**

**Publicity Office  
Sudan Council of Churches  
P.O. Box 469  
Khartoum  
Sudan**

**Any parts of this manual may be copied, reproduced or adapted to local needs, without permission from the authors or publisher, provided the parts reproduced are distributed free or at cost, not for profit. For any reproduction with commercial ends, permission must be obtained from the authors and the Sudan Council of Churches, The authors appreciate being sent a copy of any materials in which text or illustrations have been used.**

**As this work would never have been possible by our own strength without God's help, so we hope that God will also protect and strengthen any persons who use this manual and any future work done with the help of this manual.**

**Khartoum, 11.11.1987  
Márta and Rudi Guóth-Gumberger**

### 0.3. Purpose Of The Manual

The following introduction should help the reader to orientate her/himself to the manual and make best use of it.

According to the title, this manual is intended for small development projects with 20 to 40 staff members. The administrative and organisational structures described correspond to this project size.

Secondly, this book is a training manual. It does not intend to present all the information available for professionals about a covered topic, but rather to select the most basic and relevant information about a topic. Then it arranges and presents it in such a way as to introduce a beginner, but also that a trained staff can find it helpful. The manual will help senior staff to organise and improve their management.

The aim of this manual is to train senior secondary school leavers to become skilled technicians in water supply and sanitation work, to run a store, to keep records and do qualified field work, or to become community development officers. They should be able to lead a team later on and to do basic work in administration.

However, the manual can serve different purposes as described below:

#### 1. Training:

- It can be used by the trainee for self-study or as complementary material to the teaching in class.
- It can be used by the teacher/instructor as a guideline for preparing lessons in class about the covered topics.
- Some parts can be used as guideline for technical training for illiterate people.
- Some parts can be used as guideline for training sessions in the community.

#### 2. Guideline:

- It can be used by experienced people as a help to develop and build up a new small project.

#### 3. Reference book:

- It can be used as reference in day-to-day project work in the different covered fields.
- It can be used by the trainee for looking up particular information after the course.
- It can be used for revising previously acquired knowledge.

### 0.4. Possible Readers of the Manual

The manual provides material for a two years training course for several (technical) areas with 25% training in class and 75% training in the field. It is expected that not everything in the manual is for every trainee or reader.

The manual was developed in a water and sanitation project. Therefore, major parts deal with these subjects. However, many parts are of a more general nature so that they might be useful for staff of other projects, for churches, communities and development organisations.

In detail, material from the manual might be useful for the following groups of staff:

No	Staff or Trainees	Relevant Sections	Relevant Chapters
1	senior staff in management functions	1,2,3,7	4.18; 4.21; 5.1; 5.2;8.11 8.29; 9.8
2	administrative staff, typist	1,2	5.1; 5.2; 5.8
3	bookkeeper	1,5	2.9-18; 3.3-4; 7.2-12
4	community development staff	1,4,9	2.7; 2.11-12; 2.18; 3.1; 3.2; 3.11-13; 5.1-2; 5.8 7.1; 7.6; 8.1-11; 8.29; 8.33; 8.36-39
5	water supply staff	1,5,6,7,8,9	2.11-15; 2.18; 3,1-2; 3.11-13; 4,1-2; 4,15-16;
6	other technical staff like building staff	1,3,5,6,7	
7	storekeeper	1,5,6,7	8.32
8	logistics staff	1,3,5,7	2.18; 6,3-5
9	driver	1,3,5	2.18; 6,3-5; 7.6

### 0.5. Summary of the Contents

The manual consists of nine sections, compiled in three volumes:

Volume I	1. General Knowledge
ADMINISTRATION	2. Administration
and	3. Running a Vehicle
COMMUNITY DEVELOPMENT	4. Community Development
Volume II	5. Mathematics
WATER SUPPLY	6. Basic Technical Knowledge
	7. Building Administration
	8. Water Supply
Volume III	9. Sanitation
SANITATION	

Volume I contains the general parts combined with community development, volume II and III contain the technical parts.

The manual was divided into three volumes so that it can be used in parts and become more handy for the reader- Sanitation was taken as a separate volume, because many may be interested in this section alone. Still, the manual is one work and the different sections belong together. There are many references pointing to other chapters in a different volume.

The different sections are briefly introduced in the following:

### 1. General Knowledge

Relevant information not fitting into the other sections was compiled here. "Using a Dictionary", "Reading Techniques" and "Study Techniques" are useful for the work with the manual. "Private Budgeting", "First Aid" and "Applications" are also generally needed knowledge.

### 2. Administration

The basic administrative knowledge and procedures for a small project of 20 to 40 staff members are compiled here.

### 3. Running a Vehicle

Here everything which a responsible user of a vehicle - not a mechanic! - has to know in order to run the vehicle economically and to prevent unnecessary damages is compiled. The section is important for both senior staff or logistics staff and drivers.

### 4. Community Development

This section compiles basic information necessary for community development work, both of general nature and background information as well as practical procedures.

### 5. Mathematics

The manual is not intended to be a mathematics book. Therefore, you cannot find detailed explanations of mathematical principles. Rather you will find a collection of mathematical knowledge in recipe-style about whatever was found necessary for the project work - mostly very simple things and few more sophisticated.

### 6. Basic Technical Knowledge

Basic technical knowledge for the water supply and sanitation work is compiled here, "Basic Technical Drawing", "Using Measuring Tools", "Tools", and "Cement and Concrete" being the most important ones to be studied first.

### 7. Building Administration

The specific administration necessary for construction work is described here, consisting of "Planning", "Record Keeping", "Cost Calculation", "Purchasing" and "Storekeeping".

### 8. Water Supply

The section about water supply starts with general knowledge about water, discusses the different well types, the selection of a well site. Construction of hand dug wells with concrete rings is described in detail. An overview about pump types is given; some of them are described in more detail, especially hand pumps, and basic plumbing is added. "Well Disinfection", "Water Treatment" and "Health Education" are discussed in the end.

Hand dug wells and hand pumps were deliberately selected as main topics to be covered. Other books (see bibliography No. 17, 18,35) cover these topics much more comprehensively; however, here the emphasis was to prepare training material in easily understood overviews and step-by-step procedures.

### 9. Sanitation

This section starts with general background knowledge about sanitation. The different types of disposal systems are introduced and guidelines for selecting the suitable latrine suggested. Deliberately, only sanitation systems without water were selected to be covered. Several are described in more detail. The main emphasis lies on compost latrines, including different designs, composting process, construction, operation and maintenance, and follow-up. Chapters about children's squatting slab, bath, waste

matter and pesticides complete the section. Many parts of this section are suitable for training sessions about sanitation in the community or in schools.

## 0.6. Format and style of the Manual

As the purpose of the manual is to assist trainees, teachers and field staff, we put emphasis on giving it a consistent and easily understandable format. The colleagues in the project work found that providing structures was helpful, and they had no difficulties at all filling the structures with life and flesh. Therefore, the manual offers a lot of structures, forms, tables, boxes, and step-by-step procedures. This shall help to gain an overview about the field and to easily find the required information.

### A) Format of the Manual

The page numbers on top of each page reflect the format of the manual. Each one of the nine main sections contains several chapters. Each chapter has one or more pages.

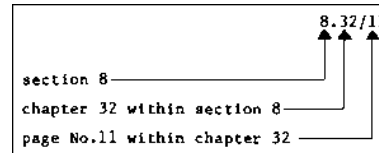

The introduction with foreword, etc., is added as another section 0. The appendix with bibliography, index, etc., is added as section 10. Section 0 and 10 are attached to all three volumes to help the reader use the manual. Thus, the volumes contain these sections:

<p>Volume I: sections 0, 1, 2, 3, 4, 10          Volume II: sections 0, 5, 6, 7, 8, 10          Volume III: sections 0, 9, 10</p>
---

Consecutive page numbers at the bottom of each page run in each volume separately.

Each chapter starts on a new page. Both the title of the section and the chapter are named:

## 8. Water Supply

### 8.14. Basic Plumbing

Directly under this headline you will find one or several bible quotations in some chapters. These were used for the prayer fellowships which were an integrated part of the three months course, and are related to the topic where they are mentioned.

Usually, each chapter starts with a brief introduction as each chapter is an entity by itself and should be readable by itself. The material within one chapter is mostly structured according to the same system, for example, in the lesson "Basic Plumbing":

### A) Threads

#### 1. Thread Types

- a) Internal/External Threads
- b) Right Hand/Left Hand Threads
- c).....
- d).....
- e).....

f).....

**2. Thread Standards for Bolts and Nuts**a) **Metric Coarse Threads M**

b).....

c).....

**3. Thread Standards for Pipes**

a).....

b).....

**4. Pipe Measurements****B) Basic Operations of Plumbing**1. **Cutting with a Hacksaw**2. **Pipe Cutting**

3.....

**C) Pipe Joints**

1.....

2.....

.....

Most lessons have only a structure A, B, C,... and 1., 2., 3.,... All titles are capitalised and underlined, as well as other important words within the text. All important messages are put into boxes. Step-by-step procedures are either numbered or put into a box with a separate column giving the reasons. All tables are in boxes.

As each chapter is a separate entity and can be used as a teaching unit, a continuous flow between the chapters is not maintained. Repetitions occur sometimes, otherwise, a reference refers to the relevant chapter containing more information about a certain point.

**B) Language of the Manual**

The manual deliberately uses simple English to explain a topic, to give trainees with limited English knowledge a chance. Simple sentence constructions were preferred to elegance of style. Some special vocabulary in the different topics was introduced, but always with explanations. Often another equivalent word is given in brackets, e.g.

"serrated (= toothed)",

"aquifer (= water-bearing layer)"

As the book is a training manual, no foot-noting was applied. We used drawings and information from books together with project experience and compiled them for the teaching purpose. The literature used and useful for further readings is compiled in the bibliography.

### C) Drawings

Many drawings are added for illustration and easy reading. In the technical part, mostly proper technical drawings are used (such as cross-section, layout plan, etc.), because they convey the information in a more correct and complete way than other types of drawings. The reader/trainee not acquainted with technical drawings must study chapter 6.1 "Basic Technical Drawing" before reading. Experience showed that the trainees without previous technical training were soon able to read technical drawings. The drawings in the manual shall also give the trainee practice in reading technical drawings. Almost all drawings are placed below or beside the relevant text, although this way consumed more space. This shall ease the reading as well.

#### 0.7. Instructions on how to Use the Manual

As not everything in the manual is useful for each reader, you need to pick what is interesting for you. Selection should be easy because of the provided structures. The following can help you to make full use of the manual:

1. Do not attempt to read the manual from the first to the last page like a novel.
2. Make yourself acquainted with the format and the paging of the manual (see 0.6).
3. Cut separation taps from carton paper for the different sections and glue and staple them to the title page of each section

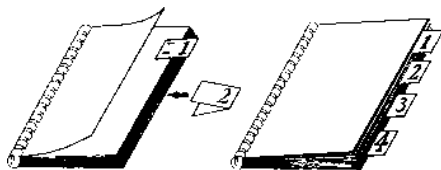

4. Use the SQ3R-method explained in 1.3 to read the manual.
5. Read the table of contents and mark which chapters are interesting for you.
6. Decide which chapters to read first. Chapters 1.2, 1.3, 1.4, 5.1, 5.2, provide necessary basics for further reading of the manual; for technical staff also 5.3, 5.4, 6.1.
7. Apply the SQ3R-method for each chapter as well. Read the headlines of the chapter first to get an overview, collect your questions about the material, etc.
8. Underline important key-words; write your notes, remarks and questions into the manual wherever needed.
9. Use the list of abbreviations, list of forms used, list of leaflets and posters, in the end of each volume.
10. Use the index in the end of each volume to quickly find information about a certain point.
11. Use the bibliography for further studies.

#### 0.8. Instructions on how to Teach with the Manual

There are many books about how to teach, and teaching methods are not the topic of this manual. Thus, only a few suggestions are compiled in the following on how to teach with this manual (see also 4.14; 4.24).



**A) General Learning Conditions**

Help obtain good learning conditions:

1. Take special care that the class becomes a community, that the trainees get to know and respect each other, that they can mutually help each other. Fruitful learning can only take place in an atmosphere of cooperation.
2. Believe that the trainees are capable of learning. Trust is essential for encouragement and learning.
3. Take special care that the physical situation is supportive for learning: an adequate room, water, feeding, sanitation must be available. Involve the trainees by distributing assignments (fetching water, cleaning, organising food, etc.).
4. Take care that the trainees have sufficient materials like files, paper, pens, etc.
5. Arrange the class in the classroom in a circle whenever possible. This is the case for most of the chapters in this manual, except for the ones involving calculations.

**B) Planning Lessons**

Good preparation is essential for good teaching:

1. Take time for preparing your lessons. Roughly estimate as much time for preparation as for class time.
2. Plan the syllabus before a training course.
3. Each chapter in this manual is an entity by itself and can be used as guideline for a lesson. Some chapters may take several lessons to cover. Roughly, maximum five pages can be covered in a teaching unit of two hours.
4. Plan extra lessons in the beginning of the course just for explaining the syllabus and the format of the manual.
5. Plan enough time for evaluation.
6. When planning your lessons, mix the teaching methods: mix group-work with class discussions, calculations with explanations on a model, etc.
7. Have your teaching material (models, posters, etc.) ready before the lesson.

**C) Teaching Methods in Class**

A variety of teaching methods is suitable for teaching with this manual in class:

1. You can structure many lessons according to the SQ3R-method (see 1.3):

**S = Survey:** Explain at the beginning what the lesson will cover.

**Q = Question:** Ask the trainees if they have questions about the topic and note these down. Check after the lesson if the questions were answered.

**R = Read:** Conduct the lesson. Explain the material.

**R = Recite:** Let trainees repeat and explain with their own words what they have learnt and understood.

**R = Revise:** Give homework, revise the following day or after one week.

2. Use group-work. Let groups of 4 to 5 discuss a certain question, try to read a passage or a drawing of the manual together, collect different aspects of a topic, etc.
3. Use discussion in the whole class to summarize group-work, to introduce something new, to explain an aspect relevant to all.
4. Use from time to time work on a certain assignment for each trainee alone (e.g. calculations).
5. Use role plays whenever possible (e.g. first aid, interaction of technicians with the community, etc.). They are fun and very educative.
6. Teach by action whenever possible (e.g. cleaning and rehabilitating a latrine, safety measures, interview, etc.).
7. Include field visits into your training programme.
8. Use posters, models, actual examples, whenever possible. Many of the drawings in the manual can be drawn on big posters for use in class. Well construction work is best understood when demonstrated with small models. Bring pieces of material for everything you discuss in class.

#### **D) Questions**

Asking questions is a way to learn, for both the teacher and the trainee.

1. Encourage the trainees to ask questions.
2. Ask at the end of a lesson whether there are any questions.
3. Ask in the beginning of a lesson if questions remain from the day before.
4. If you cannot answer a question, do not pretend and dodge around. Admit it, look it up after the lesson, and answer it the next day.
5. Spend some time before and after the lesson in class to give the trainees a chance to ask.

#### **E) Homework**

Study on her/his own is essential for the trainee in order to be able to digest the material learnt.

1. Give homework to almost all of your lessons.
2. Encourage students to keep their homework well filed and organised with chapter numbers and headlines.
3. Ask trainees from time to time to prepare for a lesson on their own by studying the manual in advance.
4. Take time to correct the homework and return it as soon as possible.

#### **F) Teaching Field Work**

Some extra efforts in teaching field work will improve the results considerably.

1. **Before** you do a new type of work the first time in the field (like lowering concrete rings into a well), discuss the step-by-step procedures in detail in class. Use a model to illustrate the steps. This will help the trainees to keep an overview of the work. It will also help them see themselves as a part of the whole team and process rather than individuals doing just menial work. Discussion beforehand in class is better than trying to explain on the spot in the hot sun when half of the staff cannot hear you.
2. Sit down in the shade with the staff after having completed a new job or after something has gone wrong. Evaluate what happened by asking: What did you learn? What was new? What went wrong? What could be done better?, etc. (see also 2.7). This can help a lot how to judge the situation and how to improve techniques.
3. The same methods can be applied when teaching field work to illiterate people. Using models is even more important.

## 9. Sanitation



### 9.1. Importance of Adequate Sanitation

Everybody has to dispose his/her waste matter every day, not only faeces and urine (together called excreta), but also rubbish and other waste.

In each culture, ways have been developed to deal with this problem and in all cultures there are certain taboos regarding waste, and especially regarding defaecation and urination. Everywhere, also, the problems of health and pollution are present. Adequate sanitation means to deal with these problems in an effective way, that is find a solution which is harmless or even useful.

In order to do this, hygiene (= personal cleanliness) and sanitation (= public cleanliness) are equally important and depend on each other. Clean water supply, needed for health and hygiene, must go with taking care of excreta and garbage. If the connection is not considered, diseases spread easily. Therefore, sanitation is an important preventive health measure.

The importance of sanitation will become clear to people if health education and information are based on the daily life experience and practice. Change will only happen if it is convenient and the solutions offered are easy and accessible.

The following questions can stimulate reflection on the topic in a group:

1. Is food a need of your body?

**What are your efforts for satisfying this need?**

**2. Is water a need of your body?**

**What are your efforts for satisfying this need?**

**3. Is sleep a need of your body?**

**What are your efforts for satisfying this need?**

**4. Is defaecation a need of your body?**

**What are your efforts for satisfying this need?**

**The following picture explains the connection between sanitation, water supply and disease, and shows in which ways the transmission cycle can be broken:**

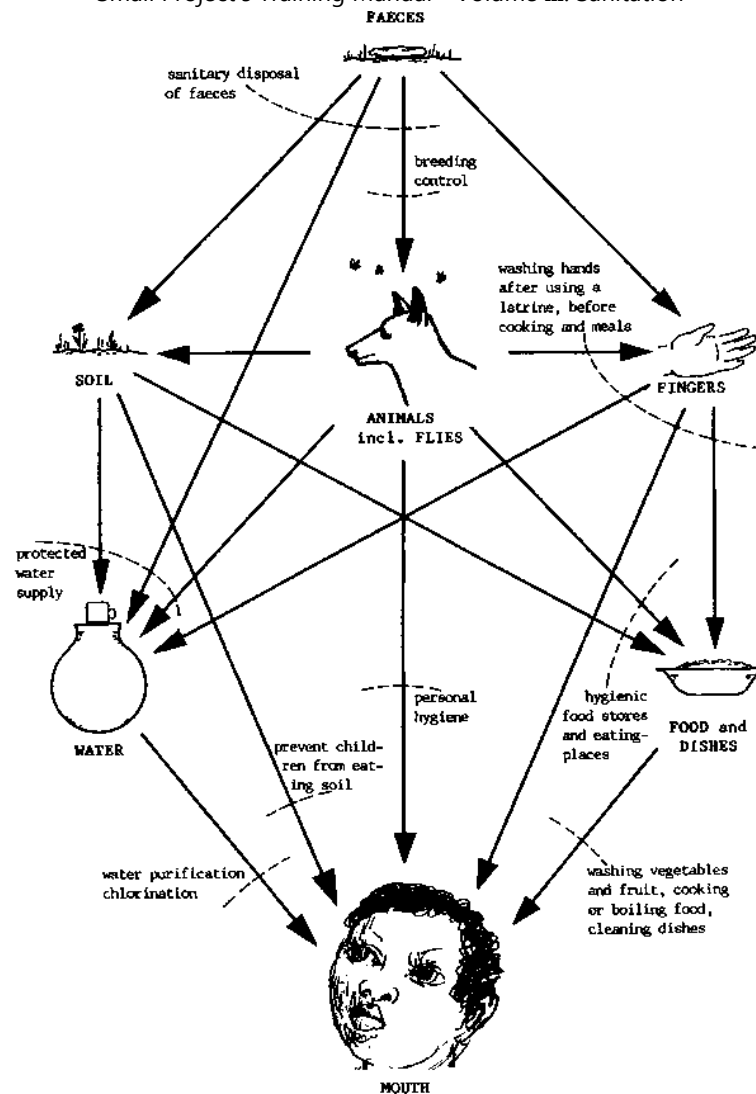

9.2. Life Cycles

Jn 6,57; 12,24

The world was created in such a way that the different living creatures support and benefit from each other mutually. These processes are repeated again and again, they happen continuously in life cycles. If the life cycles are interrupted or disturbed, there might be no immediate visible reaction, but disastrous effects will show in the long run.

A) Life Processes of Plants and Animals/Humans

The two following basic (and simplified) life processes of plants and animals (including human beings) correspond and supplement each other.

1. Plants: Photosynthesis

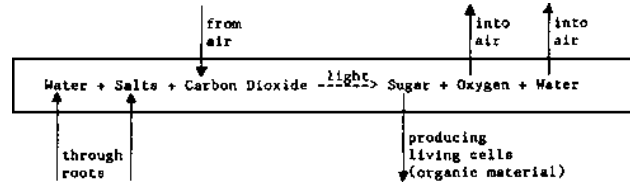

2. Animals and Humans: Respiration

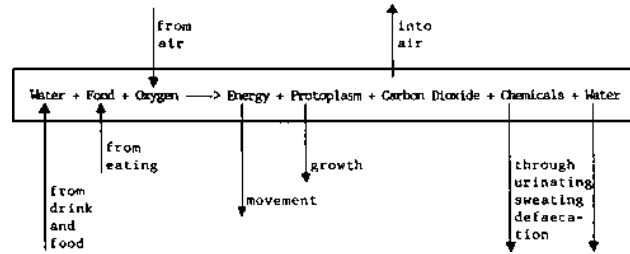

What is a waste product of the plant is a resource for the animal and the human being, and the other way round.

This fact can clearly be shown in the life cycle of air and the life cycle of food:

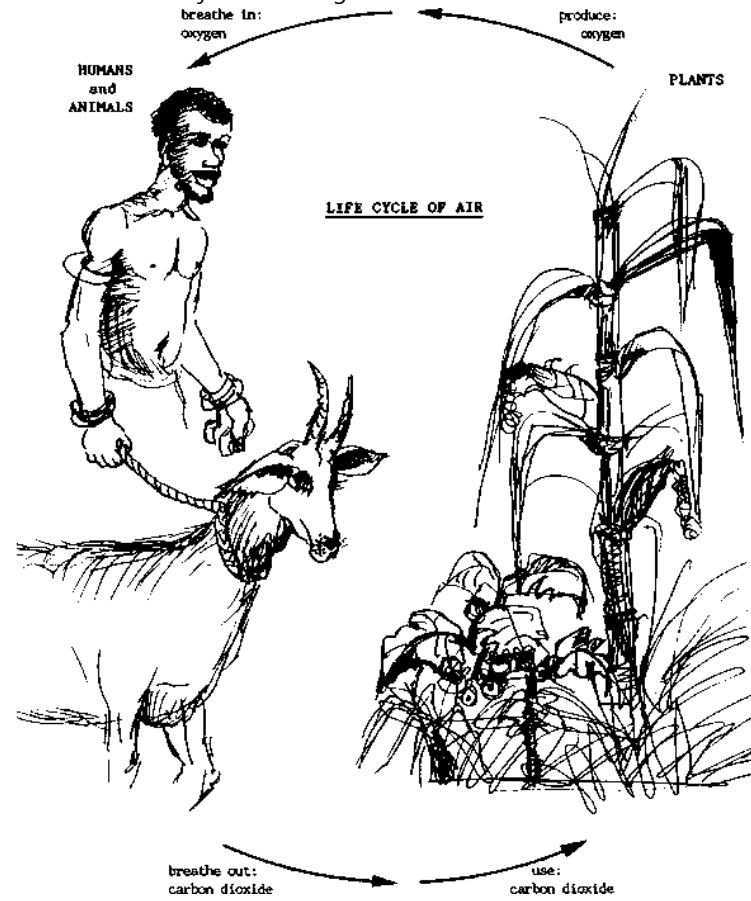

Therefore:

**ONE CANNOT LIVE WITHOUT THE OTHER.**

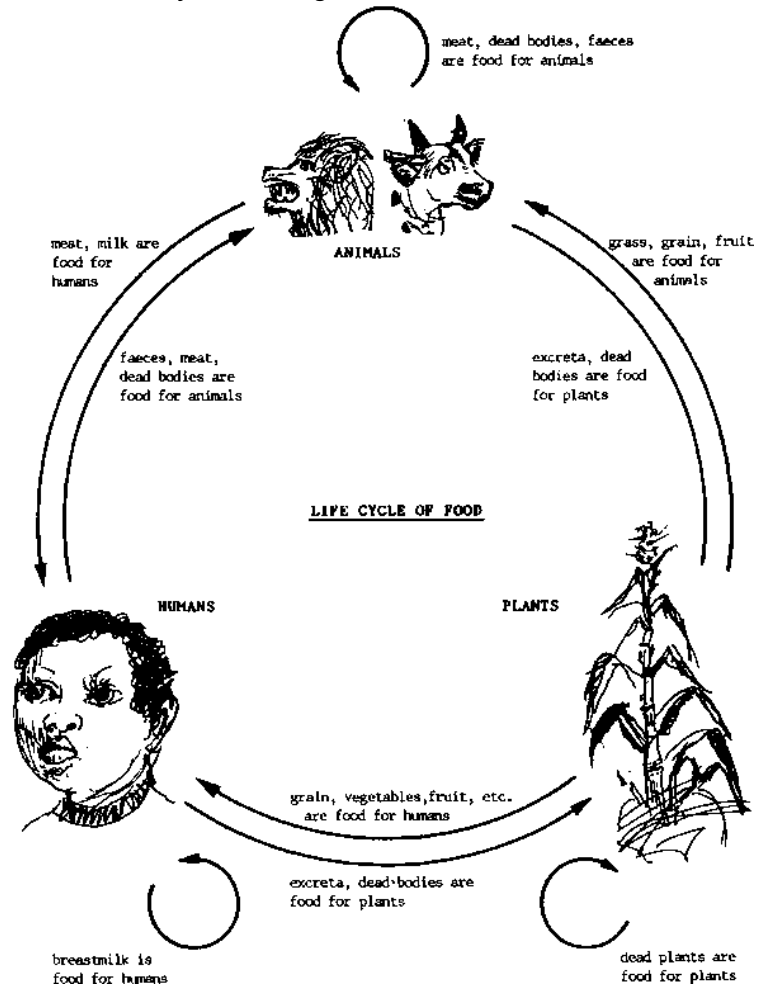

Therefore:

**ONE CANNOT LIVE WITHOUT THE OTHER**

**B) Use of Human Excreta**

Problems will arise if the life cycle is interrupted at any place. Using human excreta is one way of fitting into the life cycle.

The following is valid, when using human excreta:

	turns into	
<b>Waste</b>	----->	<b>Resource</b>



However, because of the dangers involved, we have to pursue a double aim:

<b>Aim 1:</b>	<b>Avoid Harm</b>	----->	<b>Control Diseases</b>
<b>Aim 2:</b>	<b>Support Benefits</b>	----->	<b>Utilize Fertilizer</b>

### 9.3. Flies/Mosquitoes/Cockroaches

Waste disposal provides two attractive materials for the breeding of insects: rich organic material (that is faeces), and water. The presence of insects and other animal life in latrines is necessary for the break-down of the organic matter and changing it into safe manure. Problems occur if the insects leave the latrine and become carriers of disease (= vectors), either by carrying it mechanically or as hosts.

The three insects most connected with sanitation are:

#### A) Flies

There are eleven families of flies connected with waste disposal. The most common are the house fly and the blow fly. Their main breeding place is not latrines, but garbage, the house fly preferring more solid material, the blow fly more liquid one.

A female fly lays its eggs into excreta or garbage, about 130 in a batch and 21 batches in her lifetime, that is altogether about 2,730 eggs. After one or two days, maggots come out of the eggs, living on the waste. The maggots become pupae after about ten days and after another 3 to 6 days the adult fly creeps out of the pupa. It lives for about 30 days. The process of developing from egg to maturity varies according to the temperature between 12 and 46 days.

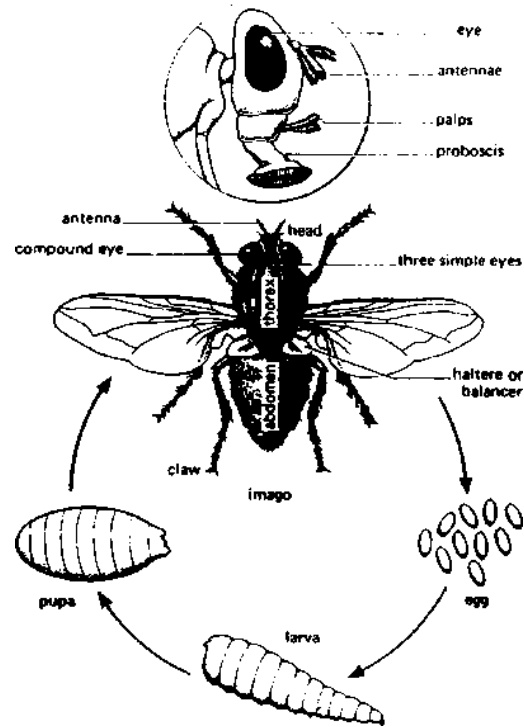

Flies can fly up to five miles in a day and, thereby, transmit diseases over quite a distance.

House and blow flies transmit germs and worm eggs by

- carrying them on the hairs of their feet and body,
- defaecating (every few minutes),
- vomiting.

Other flies transmit diseases by being hosts to parasites or germs and injecting them into the blood of a person when they bite, e.g. sand flies, black flies and tse-tse flies.



Flies can be controlled in the following ways, most effectively, if method 1 and 2 are combined:

#### 1. Mechanical Control

- Keep general cleanliness.
- Eliminate breeding places, e.g. garbage heaps.
- Build and use latrines properly.
- Use screening, especially for places where food is kept.
- Use a fly-swatter.
- Build and use fly-traps:

Example 1:

Screened ventpipe for a latrine

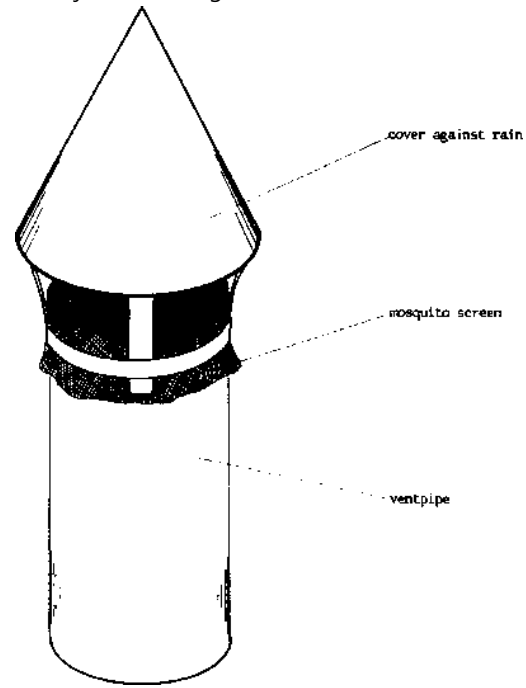

Example 2:

Fly-trap window in a latrine

ISOMETRIC VIEW OF CUT FLY-TRAP WINDOW

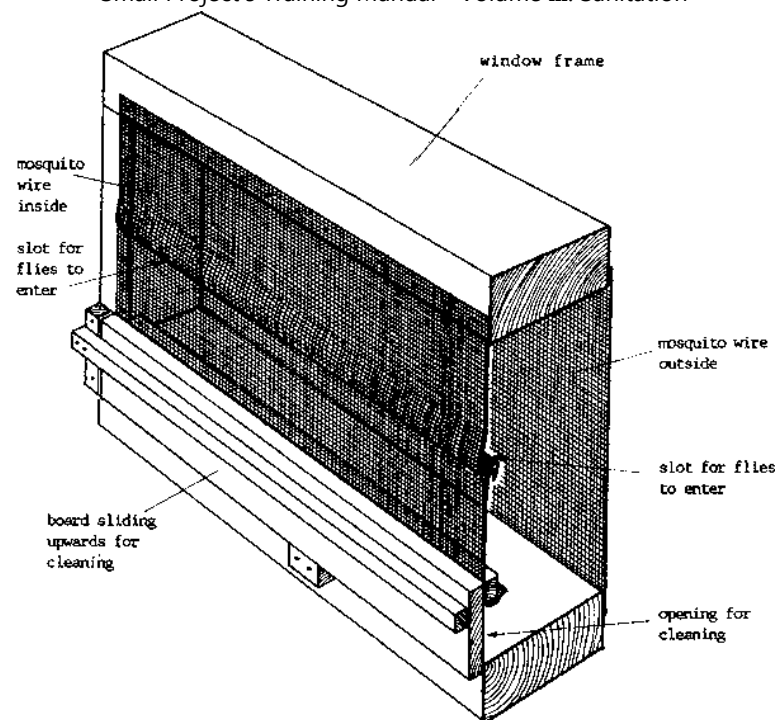

A latrine is usually dark, and the flies are attracted by the light falling in through the window. They enter the fly-trap in the window, cannot escape and die.

The trap is made in a very simple and inexpensive way. Mosquito wire is nailed on the window frame inside and outside. The flies will be trapped in between. The mosquito wire on the inside consists of two parts. They are nailed in such a way, that there is a little overlapping slot in between them, about 5 mm open. The flies will enter through this slot. Another slot of about 3 cm is left open in the bottom for cleaning out the dead flies. This opening is covered with a board, which can slide upwards to allow cleaning. The dead flies can be given to the chicken as food. Such a trap will not catch all flies, but most of them.

### Example 3:

Fly-traps attached to the squatting hole of a latrine

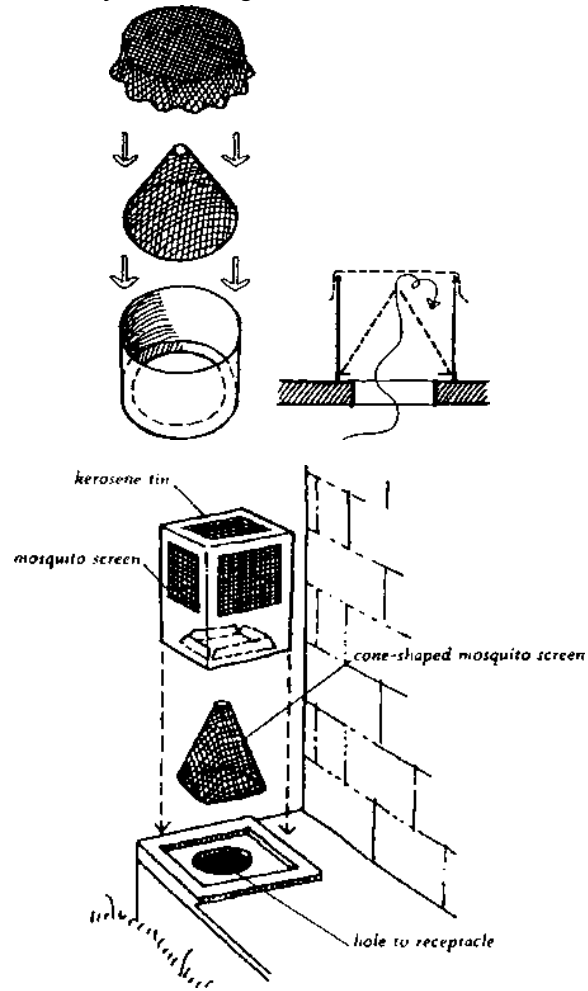

**Example 4:**

**Free standing fly-trap with bait**

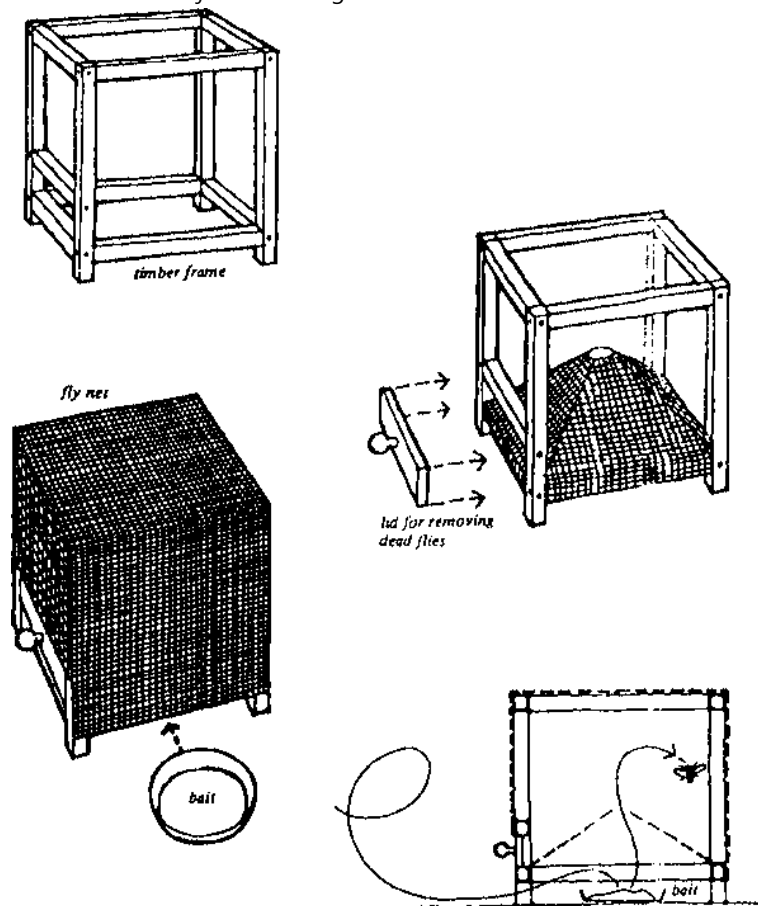

## 2. Biological Control

Encourage predators and parasites which live on flies (and mosquitoes) like frogs, lizards, chamaeleons, spiders. Also some birds live mainly on flies and mosquitoes.

## 3. Chemical Control

Using pesticides can be more harmful to human beings and domestic animals than it is for the pests they shall control. It will also kill the enemies of the flies and mosquitoes. The flies and mosquitoes will develop resistance quickly and will not be affected anymore by the poison.

If chemical control has to be used, take all precautions necessary (see 9.22).

## 4. Thermal Control

As 40°C is the lethal temperature for mosquitoes and 49°C for flies, burning rubbish or pouring boiling water over it will kill all eggs and larvae. However, this method is dangerous and of limited use, especially for compost latrines.

## B) Mosquitoes

**Mosquitoes breed in water and some kinds especially in foul water, that is flooded latrines, septic tanks, drains, etc.**

There are two types which transmit diseases. That is Anopheles, transmitting malaria, and different Culicinae mosquitoes, transmitting filariasis, yellow fever, Dengue fever, and other virus diseases. The transmission happens when an infected mosquito (only the female) is sucking blood, which it needs to do before laying its eggs, and thereby, injecting the parasites into the blood stream of the person bitten. Other mosquitoes will be infected when sucking blood from this person, and then spread it to other people.

Concerning control see the chapter about flies. The most important is the eradication of breeding places (like filling up pools with standing water), keeping grass short, having screening in the house and keeping doors shut after dusk, and using mosquito nets in order not to be bitten and infected.

### C) Cockroaches

Cockroaches need about 7 to 15 months to develop from egg into adult. They also depend on darkness. They are living on organic material and may move from waste matter to food if a place is not kept clean. However, no known disease is spread by cockroaches. They are not dangerous like flies, but rather a nuisance. The best control is to cover food properly to give them no access, and to keep the house clean, airy and light.

## 9.4. "Germs"

When talking about "germs" in connection with diseases, we have to consider different types of living creatures, most of them too small to be seen by human eyes (= micro-organisms).

They are as follows:

### A) Bacteria

Bacteria are everywhere, e.g. 100 millions in 1 gram soil, and also in our bodies. They are adjusted to it and many are helpful and even necessary. We use bacteria, e.g. when making cheese or vinegar. Bacteria do most of the work to transform dead organisms into harmless matter. Most bacteria are not pathogenic (= causing disease).

Bacteria are distinguished as

- aerobic = needing air to live,
- anaerobic = needing no air to live
- facultative = living with or without air.

They reproduce by dividing themselves.

Their names are given according to their shape, e.g., bacilli are rod-shaped bacteria.

Diseases caused by bacteria are for example

- tuberculosis (TB)
- diphtheria
- leprosy
- typhoid
- cholera
- tetanus
- pneumonia
- meningitis



- syphilis
- diarrhea (some kinds).

Diseases caused by bacteria can be treated by antibiotics like penicillin etc.

## B) Viruses

Viruses are smaller than bacteria. They are consisting of nuclear material (DNA), enclosed in a coat of protein. They are parasites and cannot live outside living cells. They multiply rapidly by division.

Diseases caused by viruses are for example

- measles
- influenza (flu, cold)
- small pox
- hepatitis
- polio
- yellow fever
- aids

Virus-caused diseases cannot be treated with antibiotics, as viruses do not respond to them.

## C) Protozoae

Protozoae are single celled small animals which can move. Amoebae are a kind of protozoae.

Amoebae divide themselves into either

- cysts:

They are covered with a coat and carried outside the body. They are not harmful, unless they reach the intestines of somebody, where the coat breaks and reproduction starts.

- two new amoebae:

Those divide again and again and live on the mucus covering the intestines. By that they destroy the lining of the intestines and cause bleeding. They move to the liver, but cannot infect other people, as they die shortly after leaving the body.

Diseases caused by protozoae are for example

- amoebiasis
- malaria (transmitted through mosquitoes)
- sleeping sickness (transmitted through tse-tse fly)
- giardiasis

#### D) Worms

Worms are animals, laying eggs. Some can be several metres long when living inside one's body.

Infection happens, except for the hook worm which comes through the skin, through the mouth by infected fingers, food or water.

The following diseases are caused by worms for example:

- schistosomiasis/bilharziasis (transmitted through water snails)
- filariasis (transmitted through mosquitoes)
- onchocerciasis (transmitted through flies)
- tape worm (transmitted through pig/cattle/fish)
- ascariasis
- whip worm
- pin worm

Clean water and proper sanitation plus personal hygiene and cleanliness are the best method to prevent most of the above diseases. If affected, get proper treatment by a trained person and take the full course of medicine prescribed as it was ordered.

#### 9.5. Diseases Transmitted by Faeces

The following diseases are transmitted by faeces or urine in different ways (see also 8.6):

- polio
- hepatitis
- gastroenteritis
- cholera
- typhoid
- bacillary dysentery
- amoebiasis
- giardiasis
- worms
- schistosomiasis (= bilharziasis)
- filariasis and others.

Therefore:

It is indispensable to dispose of human excreta in a sanitary way if we want to reduce and combat the sicknesses transmitted via faeces.

If you want to reduce your suffering from intestinal diseases and the suffering of your family, try to keep to the guidelines and suggestions in the following chapters.

Most time, you cannot see how the contamination is spread and reaches your body. It can happen for example in the following two ways:

#### Possible Way, How Intestinal Diseases Can Spread

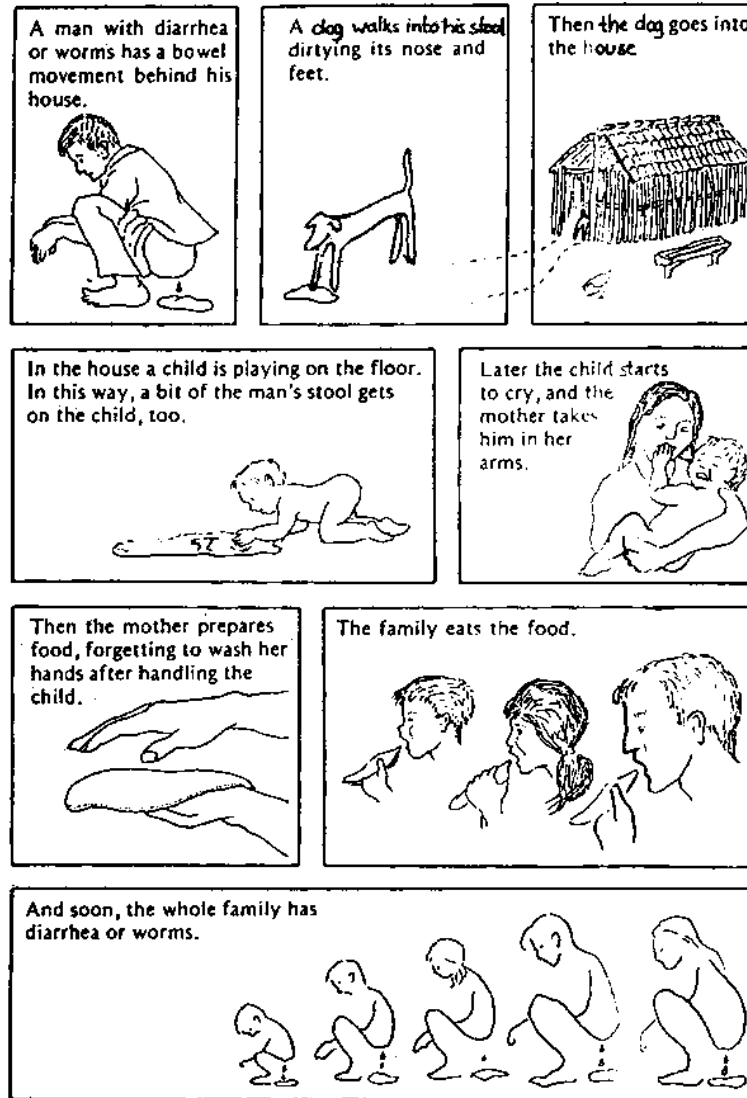

Another Way, How Intestinal Diseases Can Spread (see also 8.38/1f)

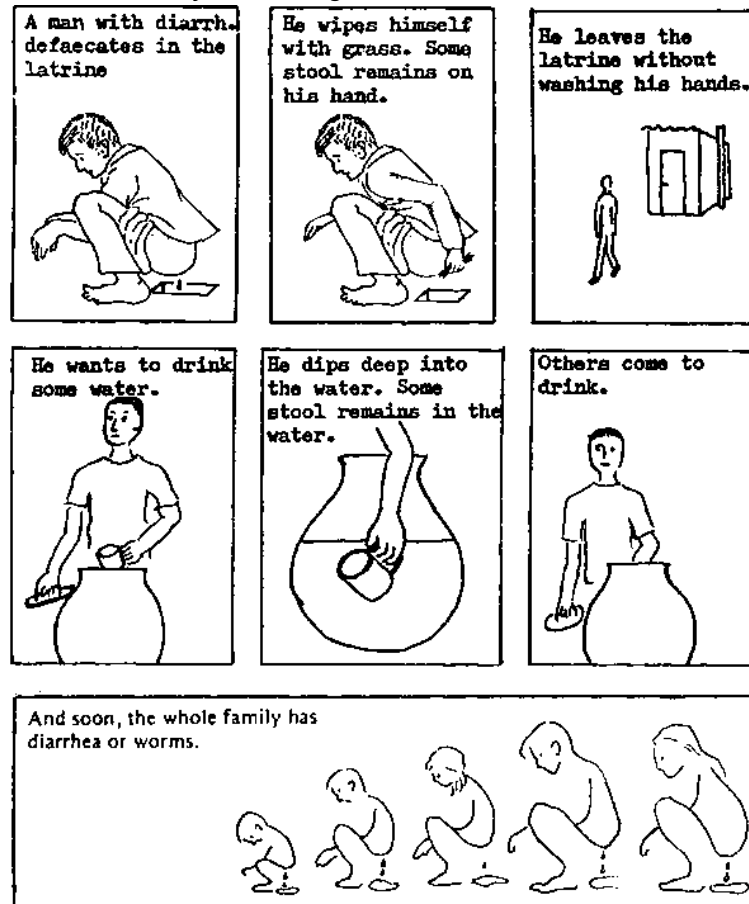

### 9.6. Basic Guidelines for Cleanliness (Hygiene)

Lev 5,2-3.21.24; 12; 15,7.8.11.12.15.31; Num 19,11.15.16.19; Ez 36,25.29;  
Mk 7,14-23; Mt 15,2.10-20; Lk 11,39; Acts 10, 15.28: 11,8-9; 2 Cor 6,6

These are the most important guidelines to be followed:

1. Always wash your hands with soap after a bowel movement. Soap is cheaper than treatment of diarrhea. Have water and soap in or near the latrine, if possible, to remember easily.
2. Always wash your hands with soap before the meals and not only afterwards. If you have no soap, use ashes. If water is scarce, use the "leaky tin" for hand-washing.

**LEAKY TIN:**

- Find a small empty tin.
- Punch a small hole near its bottom with a nail.
- Hang the tin from a branch or fix it on a pole.
- Pour only one small cup of water into the tin.
- Mash your hands in the fine stream of water leaking through the hole.
- Plant a tree seedling below the tin.

Design: AMREF, Nairobi

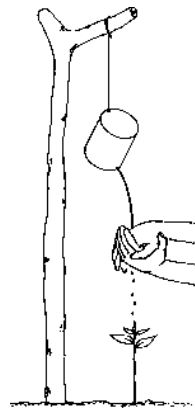

3. After cleaning a baby after a bowel movement, wash your hands with soap.

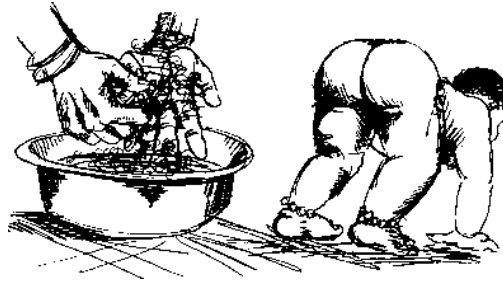

**4. Bathe often. This prevents skin infections.**



**5. Brush your teeth every day in the morning and evening, and after each time you ate sweets as soon as possible.**

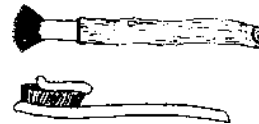

**6. Cut your finger nails short.**



**7. Do not spit on the floor or wall inside the house. Spit can spread disease. Cover your spit outside with some dust.**



**8. De-lice the whole family often. People with lice should cut their hair short, comb it several times per day and wash it with soap. Against clothes-lice boil the clothes and iron it. Lice and fleas carry many diseases.**



9. Do not go barefoot or allow children to do so in areas where hook worm or sand fleas are common.

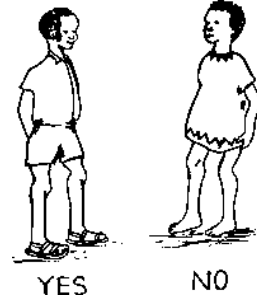

10. Do not let dogs or cats lick children or climb up on beds or tables or come near to the cooking place. Dogs and cats, too, can spread diseases, especially worms.



11. Drink safe drinking water (from a safe source or boiled and not contaminated afterwards, from a clean cup).

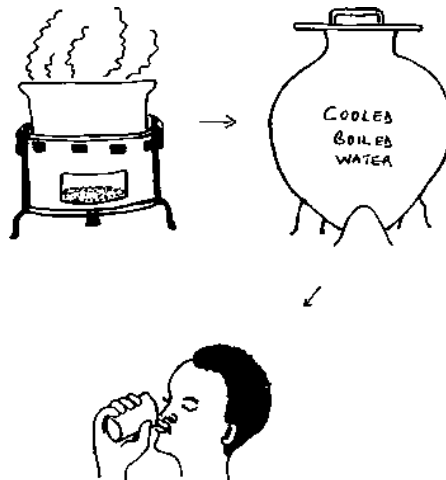

12. Before eating fruits or vegetables, wash them well with water you can drink safely. Insist that children do the same.

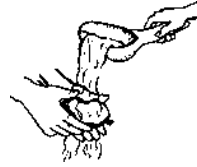

13. Only eat meat that is well cooked or roasted. Be especially careful with liver and intestines.



14. Drink only milk which is boiled.

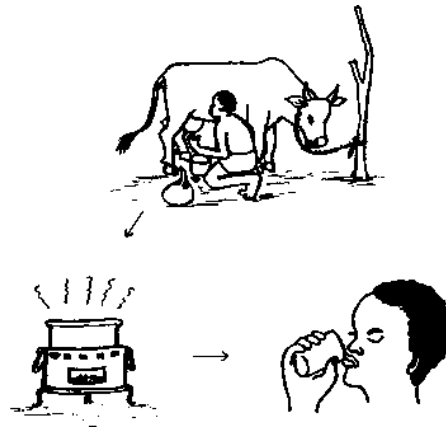

15. Do not eat food that is old or smells bad. It may be poisonous,





16. Do not let flies and other insects crawl on food; these insects can spread diseases. Do not leave food scraps around; put them into your latrine. Do not leave dirty dishes lying around, as they attract flies and breed germs. Protect food by keeping it covered or in cupboards with screens.



17. People with tuberculosis, flu, cold, hepatitis or other infectious diseases must eat from separate plates and drink from separate cups.



18. Put dishes on a stand after cleaning them and not on the ground.



19. Hang and spread sheets and blankets in the sun often. If possible, do not spread them on the ground, but hang them up. Wash clothes and underwear frequently and hang

them up for drying. Iron if possible.

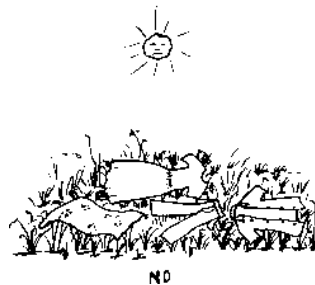
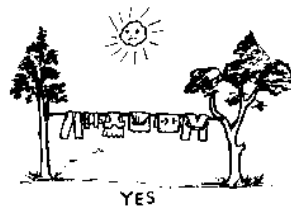

20. Clean the home and compound often. Fill in cracks and holes in the floor and walls, where fleas, bedbugs, cockroaches and scorpions can hide. It is very advisable to smear the floor regularly.



21. If children or animals have a bowel movement in or near the house clean it up at once. Bury it or throw it into the latrine. Better even, get a children's squatting slab and teach the children how to use it.



Reflect on which of these guidelines you have followed already?

Are the guidelines practicable?

Which ones have you not followed yet? Why? Could you change something?

Do all members of your family follow these guidelines?

Discuss all this with them.

## 9.7. Types of Disposal Systems

There is a wide range of disposal systems for human excreta (= sanitation systems). The following is an overview about the most common sanitation systems. The list is not complete and there are also mixtures of different types in use, but it includes all the systems used in Sudan.

### A) Overview of Sanitation Systems

see table page 9.7/2

### B) Short Description of the Different Sanitation Systems

#### 1. Defaecation in the Open

see 9.9

#### 2. Pit Latrine from Local Materials

see 9.10

#### 3. Pit Latrine from Permanent Materials

A pit latrine from permanent materials consists of a pit which may be lined, a slab, and a superstructure from permanent materials like bricks, etc.

#### 4. VIP

see 9.11

#### 5. Double Vault Compost Latrine

see 9.12, 9.13, 9.14, 9.16, 9.17, 9.18

#### 6. Bucket Latrine

A bucket latrine consists of a permanent building with a squatting slab. A bucket is placed from outside underneath the squatting slab. The bucket has to be emptied every time it is full. The contents have to be buried nearby. Handling of fresh excreta is necessary. Flies have easy access to the excrements.

#### 7. Pour-Flush Latrine

A pour-flush latrine consists of a building, a squatting slab with a pan with a waterseal, and a pipe leading to a soak-away pit. After each use, one must flush the latrine with 2-3 lit water. The liquids soak away into the ground, eventually into the groundwater; the sludge has to be emptied from time to time by truck. The septic tank provides a breeding place for mosquitoes.

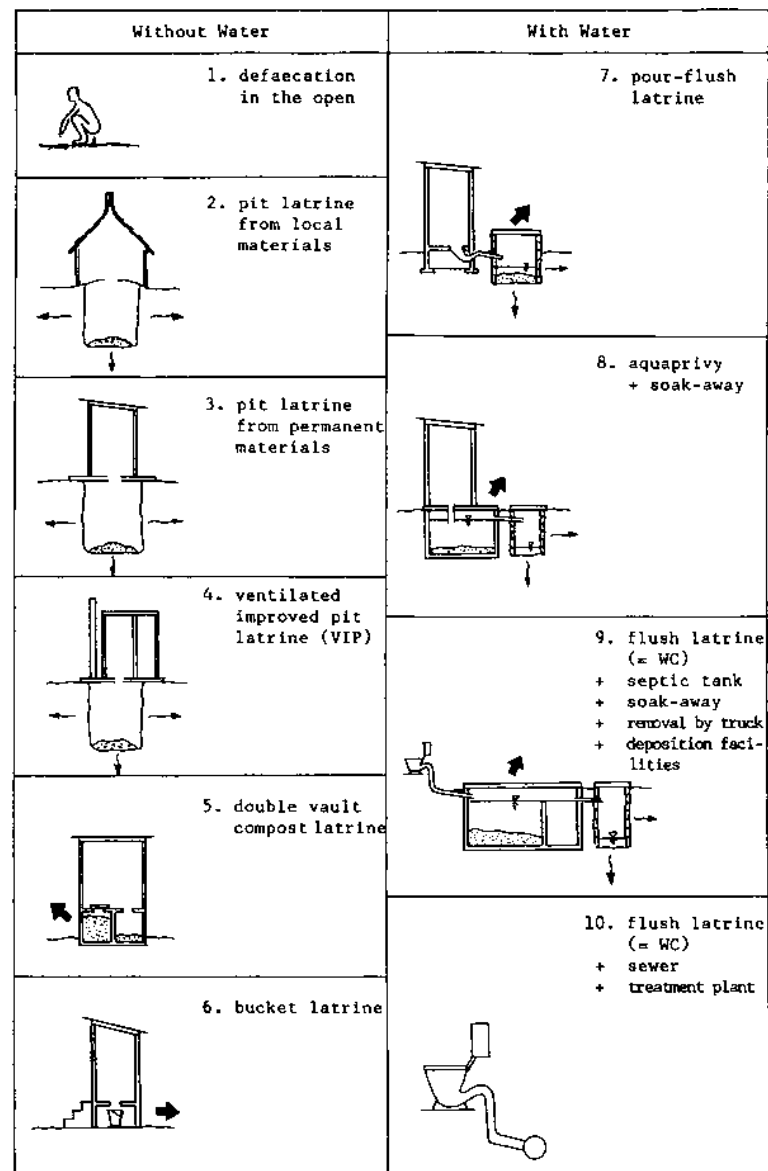

### 8. Aquaprivy

An aquaprivy consists of a superstructure over a septic tank. A chute (= large diameter pipe) reaches into the water in the septic tank from the squatting hole and, thus, provides a seal against smell and insects. The chute has to be washed regularly; water has to be filled into the tank regularly in order to keep the water table constant. Excess liquid flows through an overflow pipe into a soakaway pit and from there into the ground and, eventually, into the groundwater. From time to time the sludge in the septic tank needs to be emptied. For this the superstructure and the slab have to be removed. The gases from the septic tank are dangerous; the septic tank provides a breeding place for

mosquitoes.

### 9. Flush Latrine and Septic Tank

A flush latrine (= WC = Water Closet) is connected with a piped water supply. After each use the toilet bowl is to be flushed with about 20 l water. The contents flow through pipes into the septic tank. Excess liquid flows through an overflow pipe into a soak-away pit and then into the ground and, eventually, the groundwater. The septic tank has to be emptied by a truck regularly. The unsafe contents have to be deposited somewhere. The septic tank provides a breeding place for mosquitoes. Blockage and insufficient water supply make the WC unsafe and inconvenient.

### 10. Flush Latrine and Sewer

If a flush latrine (WC) is connected with a sewer, the flushed contents flow through a pipe into the main sewer (= a large diameter pipe under the street), and from there into a treatment plant near the next river. There the sewage should be treated (in optimal case mechanically, biologically and chemically). Then the cleaned water is released into the river. Sewage system and treatment are technically sophisticated and very expensive. Therefore sewage water is very often released into rivers without sufficient treatment.

### C) Comparison of the Different Sanitation Systems

The features of the different sanitation systems are compared in the following table:

System	No.	Name	Rural Application Possible?	Urban Application Possible?	Construction Costs?	Operating Costs?	Kind of Labour Required?	Selfhelp Possible?	Soil Conditions Required?	Water Required?	Possible Positions for Use	Anal Cleaning possible with....	Investment Off-site necessary?	Re-use of Excreta Possible?	
without water	1	defaecation in the open	not suitable	not suitable	none	none	none		any	no	squatting	anything: toilet paper ordinary p. grass, corncobs, sticks stones, water	no	partly	d
	2	pit latrine from local materials	yes	partly	low	low	unskilled labour	yes	stable, permeable soil groundwater below pit	"	squatting or sitting	"	"	no	s
	3	pit latrine from permanent materials	"	yes (in medium density areas)	medium	"	some skilled labour	"	"	"	"	"	"	"	
	4	VIP (ventilated	"	"	"	"	"	"	"	"	"	"	"	"	

		improved pit latrine)													
	5	Compost Latrine (double vault)	"	"	"	"	"	"	any(can be built above ground)	"	"	"	"	"	yes
	6	bucket latrine	no	no	"	high	"	"	"	"	"	"	deposition pit	partly	d
with water	7	pour flush latrine	partly	yes (in medium density areas)	ll	medium	"	partly	stable, permeable soil groundwater deep	yes, near latrine	squatting	only toilet or ordinary paper, water	treatment facility for sludge	"	o   c r 
	8	aquaprivy + septic tank	"	"	"	"	"	"	"	"	squatting or sitting	anything	"	"	
	9	flush latrine + septic tank + soak-away + removal by truck + deposition facility	no	"	high	high	skilled labour	no	"	piped water in the house	"	only toilet paper and water	"	"	
	10	flush latrine + sewer + treatment plant	"	yes (in high density areas)	very high	very high	engineer + skilled labour	"	any	"	"	"	sewer + treatment plant		o   :

### 9.8. Selecting the Right Latrine

Ez 34,17-19

There are many different sanitation systems. Which is the best?

There is no "best latrine" for all conditions everywhere.

Instead, the best solution for each given condition needs to be selected each time again.

In the following, we give suggestions how to select the right type of latrine for certain conditions. These suggestions are the subjective opinion of the authors and the project staff. Others have other opinions because they have different priorities and different assumptions.

#### A) Criteria (= Guidelines) for Selecting the Right Latrine

We suggest that the following criteria shall guide our choice:

1. Protection of groundwater and surface water.
2. Protection of health.
3. Saving water.
4. Acceptability by the community.
5. Economic suitability.

Protection of groundwater is the first priority, because groundwater is one of the most valuable and essential resources of the people. In most areas, where people depend on on-site sanitation, they also depend on on-site water supply. Protection of the groundwater is a "must" if we want to protect health and well-being.

Protection of both, individual and public health is essential as well. Therefore, sanitation systems which allow and encourage mosquito breeding and, thus, malaria as well as other transmission of diseases, are questionable.

Saving water, that means to use as little water as possible, is also a high priority, because the majority of people has no access to clean and sufficient water. It seems to be irresponsible to waste water on sanitation, while other reasonable options are available, and at the same time uncountable people have to carry water over long distances and do not get sufficient and clean water at all.

The chosen sanitation system must be understood and accepted by the users. However, this depends very much on and can be influenced by education.

The system should be affordable for the majority of people. It is a great advantage if the users can maintain the system on their own and with their own resources.

#### B) Sanitation with Water

All sanitation systems with water have the following disadvantages:

1. They support mosquito breeding and, thus, malaria and other sicknesses. Septic tanks and their lids are only tight in theory. Normally, compounds with septic tanks have mosquitoes during the whole dry season. The same is valid for pour flush latrines and aqua privies.
2. Water is not available in such quantities (in a dry country like Sudan) that everybody could use a sanitation system with water. Even in the urban areas, there are many people without sufficient water supply even for drinking, if the water supply is insufficient, all sanitation systems with water become unsafe and inconvenient.
3. Sanitation systems with water endanger the groundwater and sometimes the surface water. The overflow is directed into the groundwater by soak-away pits. Also, many septic tanks are leaking or flooded during rainy season.
4. Sanitation systems with water are considerably more expensive than those without water.

5. Sanitation systems with water spoil quickly if ordinary paper, grass, leaves, corncobs, small sticks or stones are used for anal cleaning.

6. Flush latrines are very often discriminating for village people who never learnt to use them.

Because of these reasons, mainly the first two, we suggest:

**Discourage all sanitation systems with water.**

The exception may be very crowded urban areas with multi-storey buildings (see also 8.29/5).

### C) Sanitation Systems without Water

For obvious reasons like cleanliness, public health, contamination of ground and surface water, and handling of fresh excreta, we suggest:

**Discourage defaecation in the open.  
Discourage bucket latrines.**

Thus the choice remains between the different types of pit latrines and the compost latrine.

Groundwater protection is a high priority. Therefore:

**Avoid flooded latrine pits by any means.**

because they

- endanger the groundwater by bacteriological pollution,
- increase the nitrates and nitrites in the groundwater,
- encourage mosquito breeding,
- are a nuisance for the users,
- can collapse easily (see also 8.7/4).

Therefore:

**If the groundwater in rainy season is 2 m below the bottom of the pit, and the next well is more than 50 m away, the pit latrine is suitable.**

The reasons are:

The pit latrine

- is simple to build,
- is simple to use,
- and misuse can be corrected easily.



The type of pit latrine depends on the local conditions and the availability of materials.

For areas with high groundwater table there are three options:

- bucket latrine,
- flush latrine with sewer,
- compost latrine.

The bucket latrine is excluded because of hygienical reasons, the flush latrine is beyond reach (for the majority). Therefore, the compost latrine remains the only alternative if we insist on the groundwater being protected.

Therefore:

The compost latrine is the suitable solution if either

- the groundwater table is high (less than 4 m at least temporarily), or
- the subsoil is rock (digging deep is not needed), or
- the subsoil is black cotton soil, or
- the owner wants a well and a latrine on the same compound, or
- the owner is interested in a latrine which will never be finally full,
  
- the owner is very interested in fertilizer.

A great deal of care and attention for the latrine is necessary, as well as repeated health education. The concerned people (users, project staff) must be ready for that. This is a condition for the functioning of the compost latrines. The costs for a pit latrine and a compost latrine are about the same. Therefore, the compost latrine turns out to be cheaper on the long run if we consider its life time.

#### D) Maintenance of Sanitation Systems

There is no maintenance free sanitation system.

except defaecation in the open.

If people want to live in more densely populated areas and remain healthy, there is no way out: they will have to participate in the up-keep and maintenance of a sanitation system.

The up-keep and maintenance is the most difficult part of establishing a sanitation system.

This is more difficult than any technical problem. This is valid for all types of sanitation systems. We can see that on the examples when the up-keep and maintenance do not function:

- smelly, dirty latrines, flooded with water, with many flies;
- overflowing buckets;
- blocked pour flush latrines;

- blocked WCs;
- smelly septic tanks;
- streets flooded by not-functioning sewers.

Most books about sanitation are based on the assumption that sanitation with water is the best, only it is not (yet) reachable for most people. This is a subjective and biased opinion, based on certain priorities and the assumption that the technology most common in industrialised countries is good at all and the best for everybody. The above suggestions for the selection of a latrine differ from this opinion. They represent an approach towards water supply and sanitation in which the two fields are seen in connection with each other and on the background of the needs of the majority of people.

### 9.9. Defaecation in the Open

Defaecation in the open, be it behind the fence of the neighbour or in open spaces or dried up riverbeds, is dangerous. It not only harms the one doing it, but also others who can be infected by diseases transmitted from the uncovered excreta. It harms the community.

This problem was already known-in the times of the Old Testament: "You must have a latrine outside the camp, and go out to this; and you must have a mattock among your equipment; and with this mattock, when you go outside to ease yourself, you must dig a hole and cover your excrement. For Yahweh, your God, goes about within your camp to guard you and to deliver your enemies to you. Your camp must, therefore, be a holy place. Yahweh must not see anything improper among you or he would turn away from you." (Deuteronomy 23,12-14; The Jerusalem Translation)

Therefore:

Contribute yourself to reducing defaecation in the open:

- Avoid defaecating in the open.
- Construct latrines.
- Contribute to the cleaning and up-keep of the latrines you use.

However, there are situations when you are forced to defaecate in the open, e.g. on a journey or when visiting people in a village where there is no latrine. In these cases act in a responsible way:

If you are forced to defaecate in the open

- Look for a small hole or dig one with a stick.
- Cover your excreta with earth, grass and leaves.

This will ensure quick decomposition and prevent flies from transmitting germs.

In general, urine is a sterile and harmless substance. Thus it is by far less dangerous for transmitting diseases than faeces. However, certain sicknesses are transmitted by urine, too.

Therefore:

If you have hepatitis, typhoid fever, bilharzia (= schistosomiasis), leptospirosis or other serious sicknesses, always urinate into a closed latrine.

**In areas with schistosomiasis (= bilharzia) nobody should urinate in the open, especially not into a river or lake.**

A person with schistosomiasis has the disease for life and, unless adequately treated, will continue to pass eggs through the urine.

If you want to use urine as a fertilizer, it must be diluted by water, otherwise it will "burn" the plants (cause them harm because of the great concentration of chemical substances in the urine).

Therefore:

**Dilute collected urine with water (1 part urine/5 parts water) and pour it directly in the garden as fertilizer.**



#### 9.10. Pit Latrine from Local Materials

The most simple type of pit latrine, made completely from local materials, is not an ideal solution. But in many places, for example in remote villages or very poor areas, another type of sanitation is not available for people. Therefore, it is important to make the best out of it and use the materials locally available.

Following the guidelines below can improve the latrine considerably. Spread this information among the people who may need it.

1. Select a location for your latrine which is not flooded during heavy rains, preferably a bit elevated, and far enough from the kitchen and a well, always downstream or downhill from where the water is taken.
2. Dig a pit. It should be small with straight walls, maybe 1.00 m × 1.00 m or round. It should never reach the groundwater. If the water is near or the soil can easily collapse, dig it only 1.00 m or 1.50 m deep.
3. Make a few mudblocks or take big stones. Build a collar around the pit or make the collar from mud directly. It is important that the level of the "slab" is above ground. Fill earth around and compact it well.

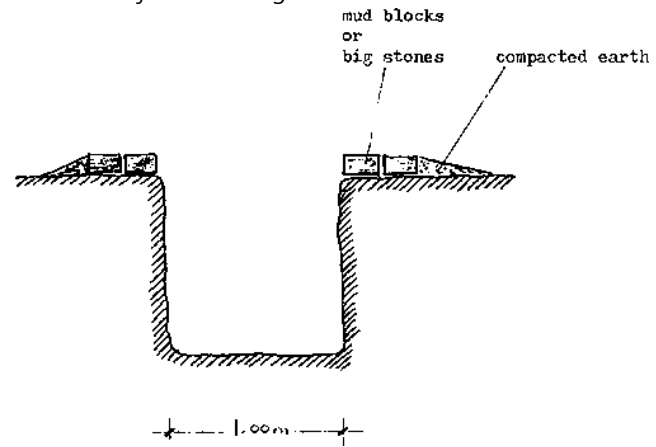

4. Construct a slab from poles, covered with earth. The squatting hole must be  $20 \times 40$  cm. If it is too small, the latrine will not remain clean.

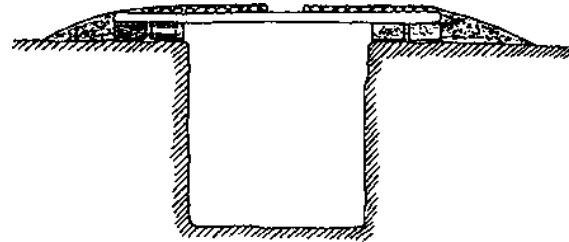

5. Build a roof over the latrine and a wall around it, it is most important to prevent rainwater from entering the pit.

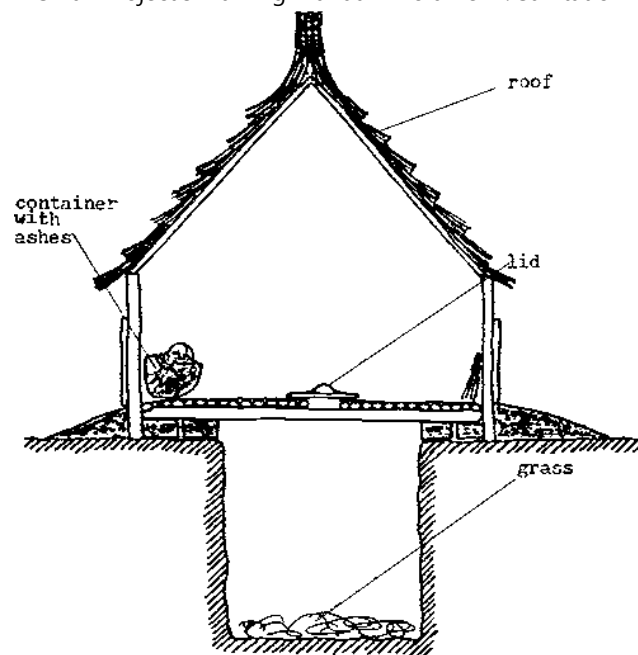

6. Smear the floor. A smeared floor is easier to be kept clean.

7. Build a fitting lid for the squatting hole:



8. Put a container, e.g. a broken clay pot with ashes and sand, a calabash, and a broom into the latrine.

9. Put grass and leaves into the pit before starting to use it.

10. Use the latrine in the way described for compost latrines (see 9.17). Discuss and explain the correct use to the family members repeatedly. Insist on keeping the rules.

11. When the latrine is full, build a new one. Cover the contents of the first with earth. After one year you can dig them out as fertilizer for the garden and you may use the pit again.

12. Build a small children's squatting slab from local material.



This will help the children to learn how to use a latrine properly. (see 9.19)

Such a latrine will have no bad smell and have few flies and no mosquitoes and will, therefore, be safe if

- the contents of the pit are kept dry;
- the lid is always closed;
- ashes and sand are sprinkled after each use, and grass and leaves regularly added.

## How to improve your pit latrine

1. Put a lid, a container with sand and a tin for sprinkling and a broom (not to be used elsewhere) into the latrine!
2. Put some sand or ashes into the hole after each use!
3. Close the lid after each use!
4. If dirty, pour sand over the dirt and sweep it into the hole!
5. Put grass, leaves, sweepings, kitchen left overs into the hole several times a week!
6. **Do not** pour any water into the hole! Clean the latrine dry or with wet grass, but do not rinse it with water!
7. **Do not** put glass, tins or plastic into the hole!
8. **Do not** use disinfectant, old engine oil or DDT!

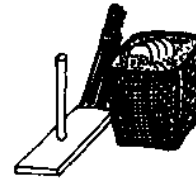

### Further information:

If there are too many flies or a bad smell, a screened ventpipe can help.

If your pit is full of water and mosquitoes, a compost latrine prevents these disadvantages.

Assistance for building a compost latrine and further information you find at:

Sudan Council of Churches - Munuki Water and Sanitation Project - Juba, Box 209

## Sika ita bamul mustra betak ahsan

1. **Kutu** kuta, guffa beta ramla,  
hilba al ita bekubu al ramla  
ma huo wa mukshasha fi al  
mustra! Mukshasha da ma be  
stamilu fi mahal tani.

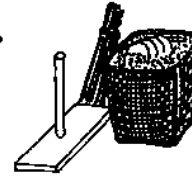

2. **Kutu** ramla walla ramat basit fi ufra  
bad ita stamilu !



3. **Gafulu** kuta bad ita stamilu !



4. **Kan** waskan kubu ramla fogu wasaka  
de wa nadifu jua al ufra !



5. **Kutu** gesh, warsal, wasaka al  
nadifu min midan taki wa min madba  
fi ufra kullu usbu !



6. **Mata** kubu moya fi ufra kullu  
kullu ! Nadifu mustra yabis walla  
ma gesh al bilu be moya, lakin  
ma ta kasilu ma moya !



7. **Mata** kutu gisasat walla hilbat walla  
listic walla naylon fi al ufra kullu kullu !



8. **Mata** stamil Dettol walla Finik walla  
zet mahruk walla DDT kullu kullu !



### Kabar zeda le de :

Kan fi duban ketir walla riha batal, masura be mumulia  
fi ras beta besadu ita.  
Kan mustra taki malyan ma moya wa bauta, bachana  
min ufraten bewagaf kullu mushakil de.  
Musada beta abinu bachana min ufraten zeda ita be ligu  
fi maktab beta mejles al kanais.

Sudan Council of Churches - Munuki Water and Sanitation Project - Juba, Box 209

## كيف تتحست البغائز

١ وضع غطاء و العلبة مملوءة بالرمل و الثانية صغيرة التي يمكنك أن ترش بها الرمل على بلاط و الفرشاة النظافة و التي لا تستعمل في أي مكان إلا داخل البغائز.

٢ وضع الرمل أو الرماد داخل العفرة بعد الاستعمال.

٣ اقل العفرة بعد كل استعمال.

٤ إذا غير منظم دفع الرمل على الأوساخ ثم نظفها إلى داخل العفرة.

٥ وضع القش، أوراق، أوساخ و البقايا الأكل في المطبخ داخل العفرة مرات عديدة في الأسبوع.

٦ لا تدفق الماء داخل العفرة، نظف البغائز نظيفاً بالقش مبلوه بالماء و لا تدخلها داخل الماء.

٧ لا توضع الزجاج أو الصفحيات المقطع أو البلاستيك إلى داخل العفرة.

٨ لا تستعمل المبيدات للحشرات أو زيت الماكنة القديمة أو DDT.

### معلومات أخرى

إذا هناك ذباب كثيرة أو الرائحة أفنت ضع ماسورة تهوية لكي تساعد. إذا البغائز مملوءة بالماء و البعوض المرحاض تساعد على ذلك. توجد المساعدة للبناء المرحاض عند مشروع منوكي للأصحاء و الماء.

مجمع الكنائس في السودان، مشروع منوكي للأصحاء و الماء، جوبا، ص.ب. ٢١.

## 9.11. Ventilated Improved Pit Latrine (VIP)

The ventilated improved pit latrine (VIP) was designed to reduce smell and fly nuisance. The main difference, compared with a traditional pit latrine, is the ventpipe.



The ventpipe (Ø 8-20 cm) is painted black and placed on the sunny side of the latrine. The air inside the ventpipe will thus heat up and create an updraft to expel bad smells. A corrosion resistant screen on top of the ventpipe prevents the flies from escaping and entering.

Many VIPs have no removable lid on the squatting hole. The interior of the latrine is dark, as the superstructure is constructed in spiral shape. Thus flies do not escape from the squatting hole, but are attracted by the light falling into the pit through the ventpipe. Dark latrines, however, may cause users to leave the latrine slab dirty. Snakes and scorpions also like to hide in the dark. Therefore, it is more advisable to provide a window and a removable lid.

Whether a VIP is safe healthwise depends on correct use and operation and maintenance; it is best managed in the same way as a compost latrine (see 9.17).

Remember:

A badly kept, dirty pit latrine does not differ from defaecation in the open.

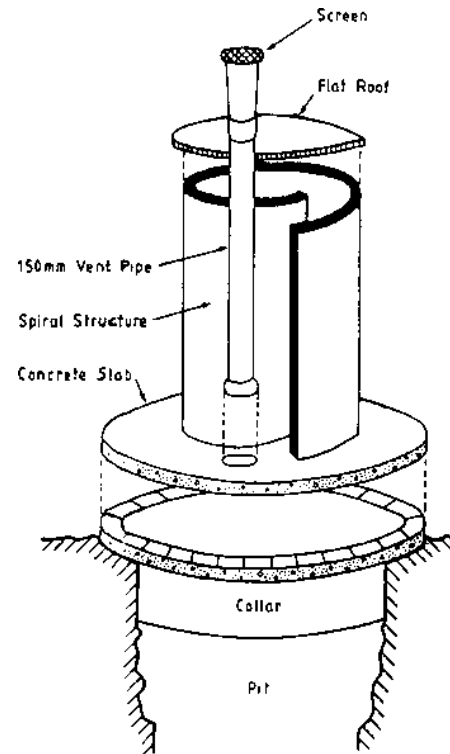

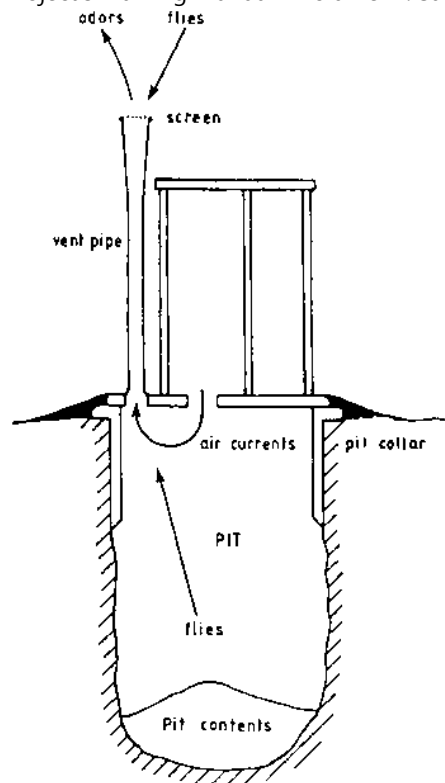

## 9.12. Compost Latrine

### A) Description of a Compost Latrine

A compost latrine consists of a pair of waterproof vaults (= receptacles) that receive excreta, ashes, sawdust, grass, leaves, sand, kitchen residues, etc. Each vault is equipped with a slab with a hole for defaecating, a rear opening for removing the compost, and a hole for the ventpipe.

### B) Usage of the Compost Latrine

Only one receptacle is used at a time. The other one is closed by a permanent lid. When almost full, grass and soil are put into it and it is closed. Then the second receptacle is used until almost full.

While the second receptacle is being filled (6 to 12 months), the contents of the first one have time to decompose. Then they are not dangerous anymore for transmitting diseases. When the second is almost full, the first one is emptied and used again. Thus the two receptacles are used alternatively.

### C) Special Features of a Compost Latrine

- The compost latrine works as a part of the life cycle, recycling human excreta as a resource, usable as fertilizer.
- If well kept, the compost latrine prevents spreading of diseases.
- There is no groundwater pollution.

- Deep digging is not necessary; the compost latrine can be built above ground.
- The pit cannot collapse.
- Only composted, dry matter needs to be handled.
- The compost latrine is never finally full, but can be re-used again and again.
- The costs are reasonable.

#### D) Possible Problem Areas of Compost Latrines

Compost latrines must be used in the correct way (as any other latrines). However, if not used correctly, the contents may not decompose in time, and they will be very unpleasant to empty (like those of a septic tank). Compost latrines need a high degree of care and attention from each user. Intensive and repeated health education is needed for promoting compost latrines.

#### E) Types of Compost Latrines

There are different types and ways of constructing a compost latrine:

##### 1. Double Vault Compost Latrine below Ground

This compost latrine is built from cement blocks. Basically the same type, but larger and built from bricks, is described in detail in 9.14.

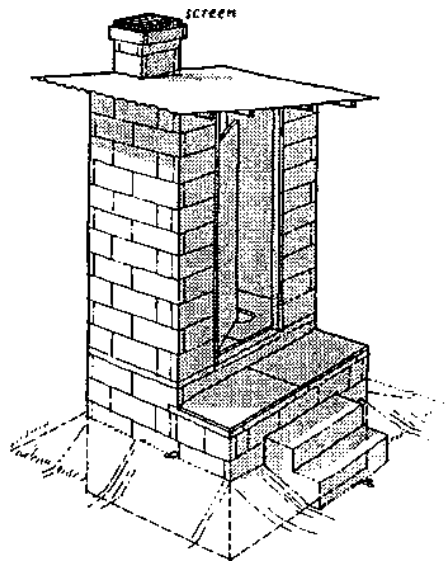

##### 2. Double Vault Compost Latrine above Ground

#### LAYOUT PLAN

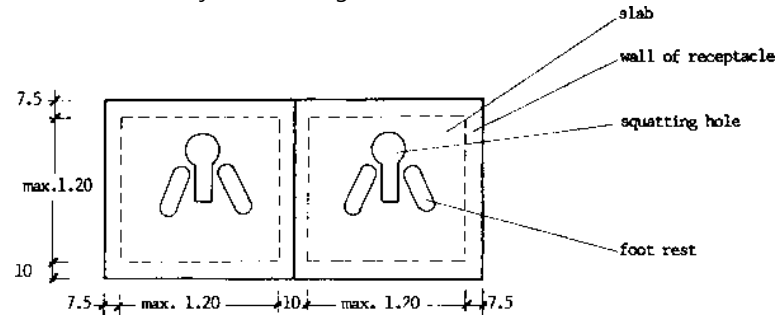

**BACK-VIEW**

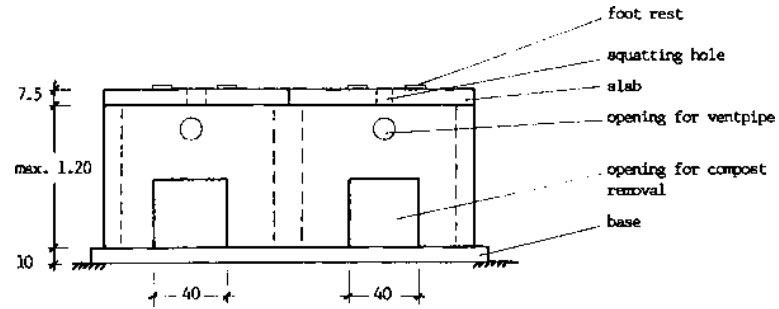

**SIDE-VIEW**

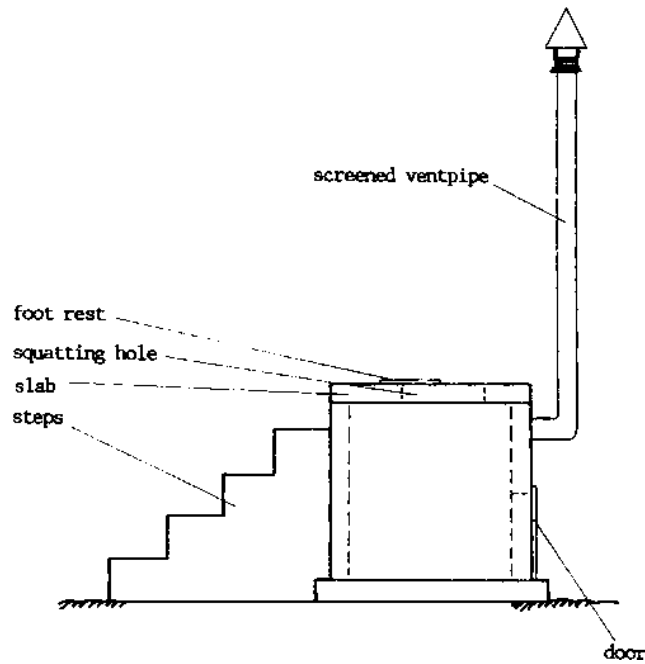

**3. Double Vault Compost Latrine above Ground with Separation of Urine (Vietnamese Compost Latrine)**

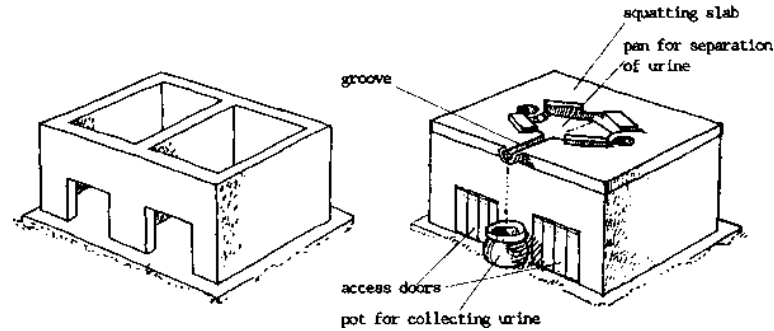

**4. Compost Latrine from Local Materials**

When the pit is full, a new pit is dug and the slab and superstructure moved on top of it. Six months later the decomposed contents of the first are removed.

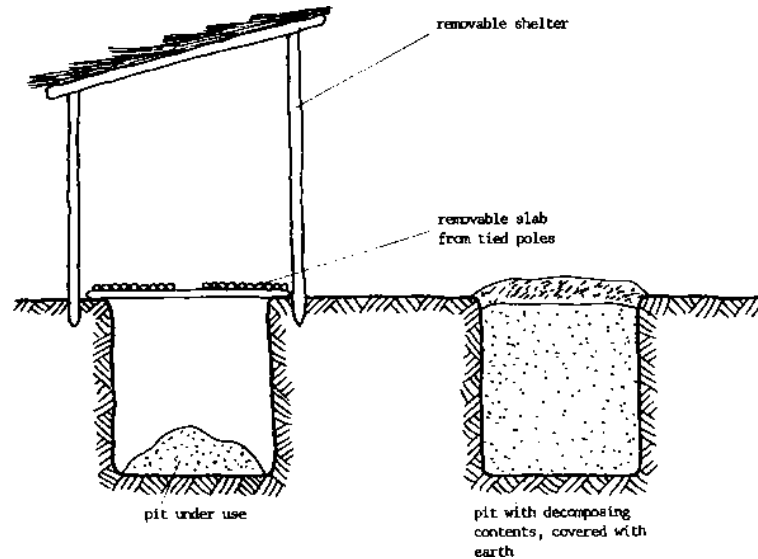

**F) Example for Advertising Leaflet about Compost Latrines**

Sudan Council of Churches \* Munuki Water and Sanitation Project

**DO YOU WANT TO DO SOMETHING FOR YOUR HEALTH AND THE HEALTH OF YOUR FAMILY???**

**WHY NOT BUILD A LATRINE?**

**YOU THINK THERE ARE PROBLEMS?**

- The underground is rocky and it will be hard work and expensive to dig.
- Or the water is near and the latrine may be flooded and become a breeding place for flies and mosquitoes.
- Or building materials have become too expensive.

**THE COMPOST LATRINE WILL SOLVE YOUR PROBLEMS!!!**

- Only one metre deep to dig - the best for rocky ground.
- Completely closed compartments - the best if the water table is near; no flooding anymore.
- Never troubles as with a WC if the water supply is cut - you do not depend on a water supply.
- To be used for generations and it will never fill up finally - once you invest, always you enjoy.
- The waste is turned into manure in a safe way - you can even use it in your garden.
- Cash contribution only £S 250.000 m/ms for the standard version.

For further information contact:

Sudan Council of Churches  
Munuki Water and Sanitation Project  
P.O. Box 209, Juba

Office Hours:  
Monday to Friday, 7.30 a.m. to 2.30 p.m.

**YOU ARE WELCOME ANY TIME!**

### 9.13. Composting Process

Composting takes place in the compost heap in the garden or in a compost latrine. It is important to understand the process for being able to maintain a compost latrine properly.

Composting is a biological process. Various types of organisms break down organic substances to make humus (= mature compost). This needs to happen under controlled conditions. Otherwise, decomposition will not take place fully, leaving a foul, smelly mass with pathogenic (= sickness carrying) organisms behind.

The following factors influence decomposition:

#### A) Availability of Air (Aeration)

Some microbes need oxygen to carry on decomposition (= aerobic decomposition). Others do not require oxygen (= anaerobic decomposition). Both types are going on in a compost heap.

Conditions with enough air available (= aerobic conditions) are necessary for rapid and smell-free decomposition and for destruction of pathogenic organisms by heat.

Air is provided on the surface and by earthworms, maggots, beetles, cockroaches, and others digging into the heap. Obviously, in flooded pits with too much moisture, the material becomes soggy, compact and unable to contain sufficient air in between the particles.

#### B) Temperature

Dry decomposition produces a lot of heat. In the middle of a compost heap it can reach 50°C. High temperatures contribute to the destruction of pathogenic organisms.

#### C) Moisture

The best moisture content in a compost heap is 50-60%. Too much or not enough moisture are both bad for the composting process. An extremely wet latrine is bad for composting and invites mosquito breeding. It can be caused by

- humid climate,
- water used for anal cleaning,
- urine and faeces deposited,
- too many users,
- no addition of organic refuse,
- no addition of sand, ashes or other dry matter,
- an unventilated receptacle,
- entry of rain water, surface water or groundwater.

Take care that the compost is not too wet and muddy by regularly adding enough dry material.

If it is wet, check the cause and remove it.

#### D) Ratio of Carbon and Nitrogen

Carbon and nitrogen are two different chemical substances found in nature.

Microbes feed on organic matter containing, amongst other things, carbon and nitrogen; they use carbon for energy and nitrogen for body building. The carbon and nitrogen content must be balanced in a compost heap. It is best if there is 15 times more carbon in the compost than nitrogen (Carbon/Nitrogen ratio = C/N ratio = 15/1).

Faeces have only 8 times more carbon than nitrogen (C/N ratio = 8/1); urine has even less carbon than nitrogen (C/N ratio = 0.8/1). Therefore, it is very important to add carbon-rich material in order to reach the correct balance.

Carbon rich materials are all organic materials (such as grown plants) especially:

- |   |                   |
|---|-------------------|
| - ashes                                 | Almost all carbon |
| - sawdust                               | C/N ratio = 500/1 |
| - straw                                 | C/N ratio = 150/1 |
| - green leaves, grass, kitchen residues | C/N ratio = 15/1  |

Therefore:

**Regularly pour ashes, leaves, grass, sawdust, etc. into the compost pit in big quantities. Put all kitchen residues into the pit.**

Do not worry about the pit being filled too quickly. The volume of all these materials is very much reduced during decomposition.

#### E) Life in the Compost Heap

A variety of organisms live in a compost pit, like viruses, bacteria, fungi, algae, earthworms, fly maggots, snails, ants, spiders, beetles, cockroaches, mice, etc. They play a major role in mixing, airing, and tearing apart the contents of the latrine. As long as they remain inside the receptacle, their activities are good and should be encouraged. They should not be killed by chemicals or poisons or disinfectants poured in. But we do not like to see such organisms outside the receptacle.

Therefore:

- Always keep the lid closed.
- Check the screens on the ventpipe for eventual holes and repair.
- Keep the covers for emptying well covered with earth.
- Sprinkle ashes and sand after each use to reduce flies.
- Do not throw tins, glass, plastic into the receptacle.
- Do not pour DDT, old engine oil or disinfectant (Dettol, Finik) into the pit (see also 8.7/4).

#### F) Destruction of Pathogenic Organisms

Pathogenic organisms are destroyed by

- high temperatures,
- time,
- unfavourable pH value (alkalinity or acidity),
- competition for food,
- antibiotic action,
- toxic by-products of decomposing organisms,
- anaerobic conditions.

**After six months in a closed receptacle, the contents of a well-functioning compost latrine are safe enough to be taken out.**

Take them out and cover them with soil. Most parasitic organisms have been destroyed.

The period of one year in a closed receptacle is on the safe side. All pathogenic organisms are destroyed.

However, if the compost latrine was not well kept, or no organic material was added, or the contents are muddy, it will be unpleasant to remove the contents. Dispose of them in a trench and cover them immediately with earth. Learn from experience and keep the latrine better next time.



**G) Compost as Fertilizer**

Addition of compost will make the soil more fertile, easier to cultivate, and improve its water holding capacity. The fertilizer from compost is well balanced in all its ingredients. Plants can use it almost 100%. Compost does not endanger the groundwater as chemical fertilizers do. Compost is a treasurable resource.

**9.14. Compost Latrine Construction**

Three different designs for compost latrines are described here:

1. Compost latrine, standard size (15 - 25 people), from permanent materials;
2. Compost latrine, standard size (15 - 25 people), with local superstructure;
3. Double compost latrine, large size (100 - 120 people), from permanent materials;

The construction steps and the materials needed are given for the first design only. However, they are similar for the other designs.

**A) Designs****1. Compost Latrine from Permanent Materials**

The compost latrine, standard size, is intended for extended families. The volume of the two pits together is about 2.7m<sup>3</sup>; this is equal to the volume of an ordinary round pit Ø 1.00 m, 3.50 m deep. It is built from half-brick wall throughout. Additional reinforcement in the slabs makes it unnecessary to have a beam to bridge the pits.

**Prefabricated Parts:**

Quant.	Item	Measurements	Remarks
2	concrete slabs with squatting hole and foot marks	95 cm × 110 cm × 5 cm	reinforcement: welded mesh and 1 Ø 10 mm
2	concrete covers	50 cm × 110 cm × 5 cm	reinforcement: welded mesh; two handles
1	lid from cement mortar 1:4	53 cm × 20 cm × 5 cm	see 9.14/19
1	wooden lid with handle	53 cm × 20 cm × 2 cm	see 9.14A9
1	ventpipe from ferrocement	inside Ø 20 cm, outside Ø 25 cm, length 2.70 m	reinforcement: chicken wire with screen and rain-cover

**LAYOUT PLAN A-A PITS**

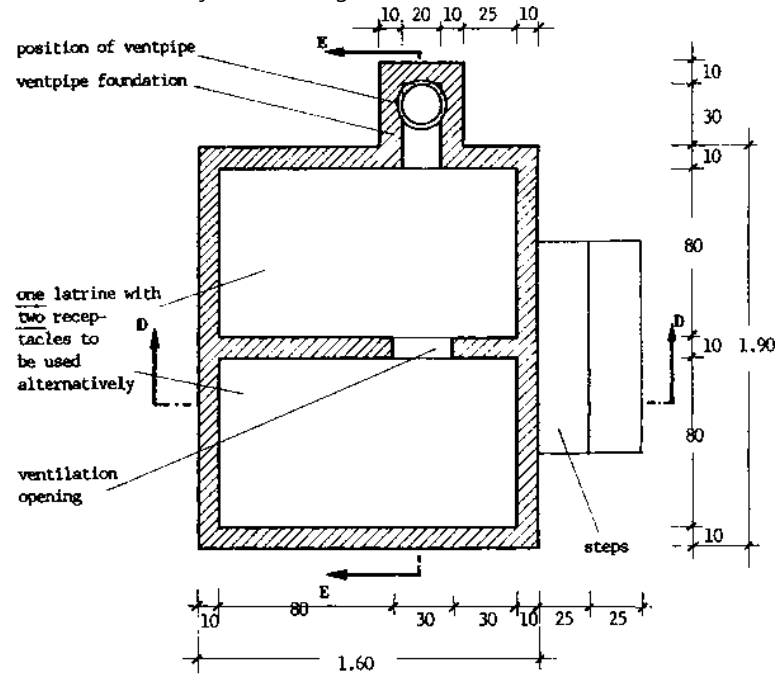

SCALE 1:25

How to read technical drawings is explained in 6.1.

LAYOUT PLAN B-B SUPERSTRUCTURE

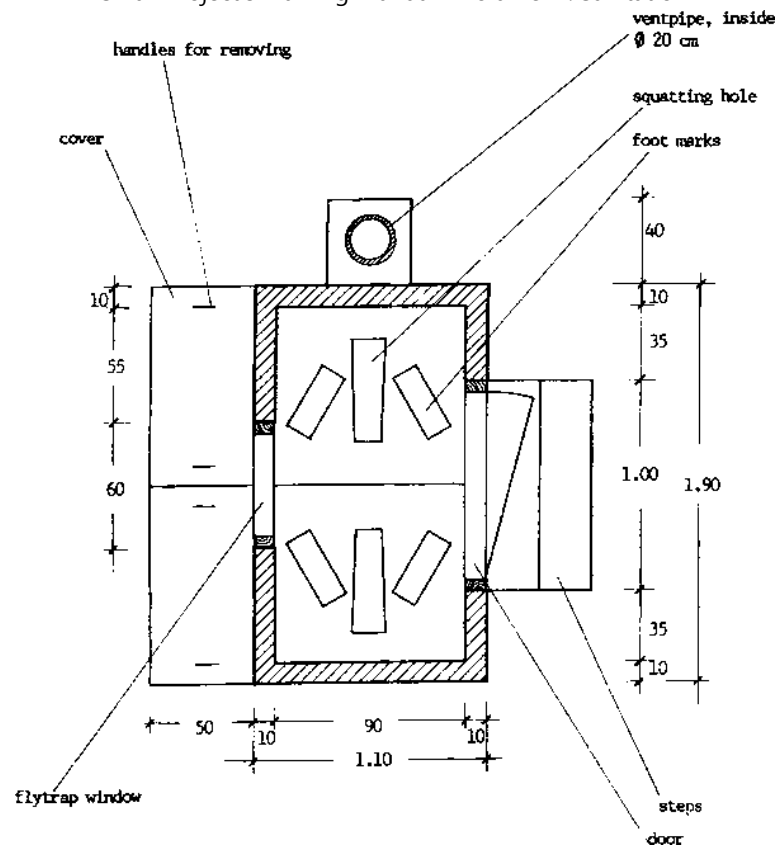

SCALE 1:25

**LAYOUT PLAN C-C: SLABS AND COVERS**

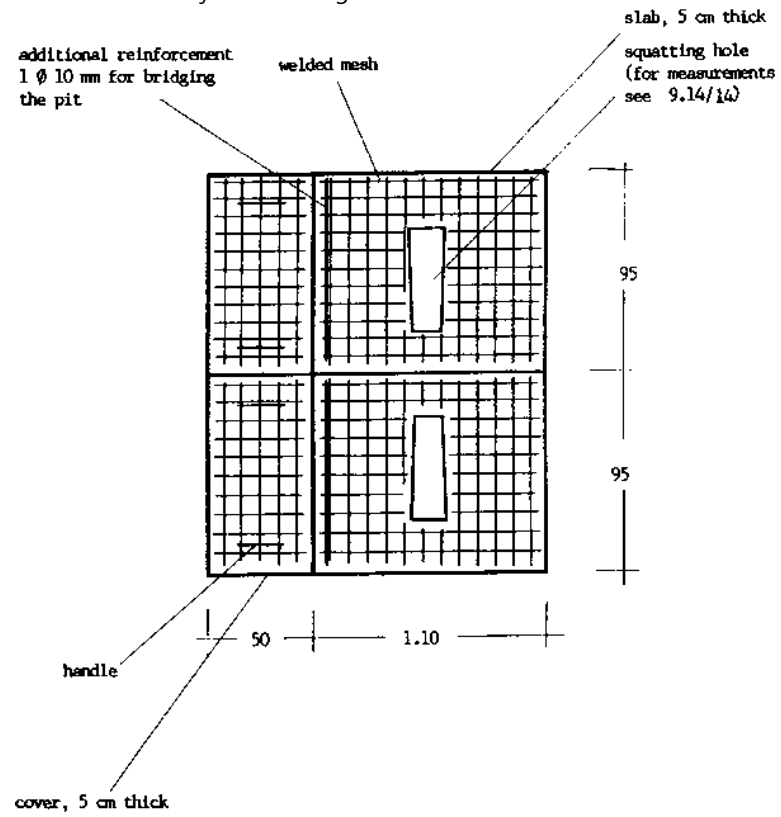

SCALE 1:25

CROSS-SECTION D-D: ACROSS THE BUILDING

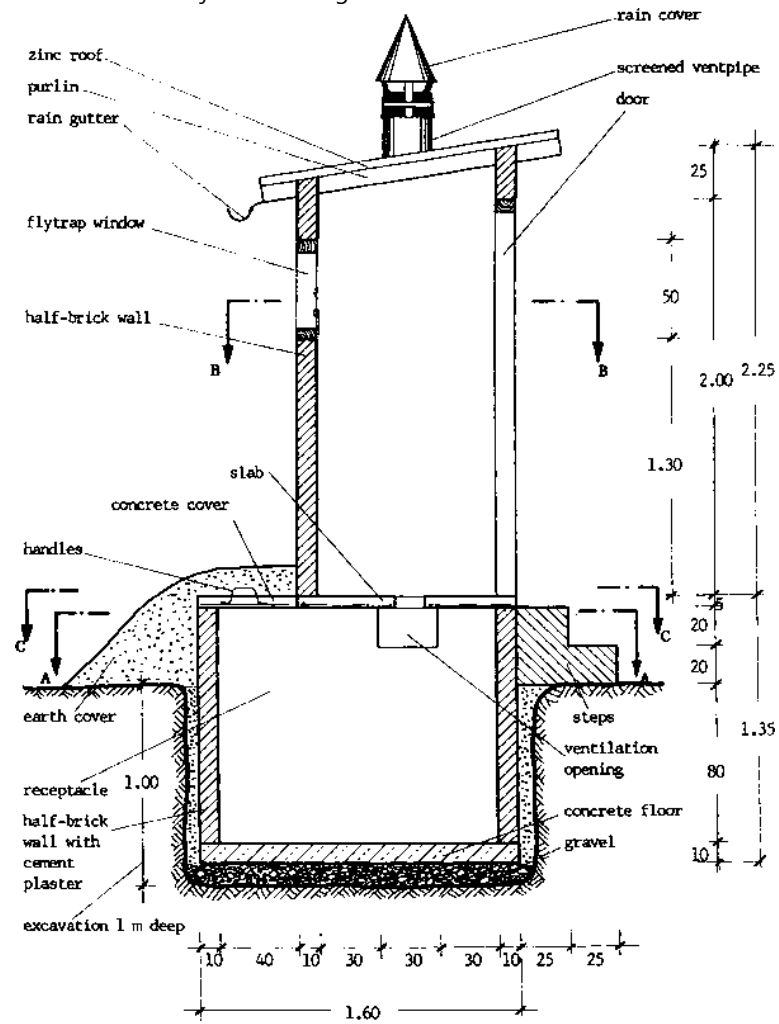

SCALE 1:25

**CROSS-SECTION E-E: ALONG THE BUILDING**

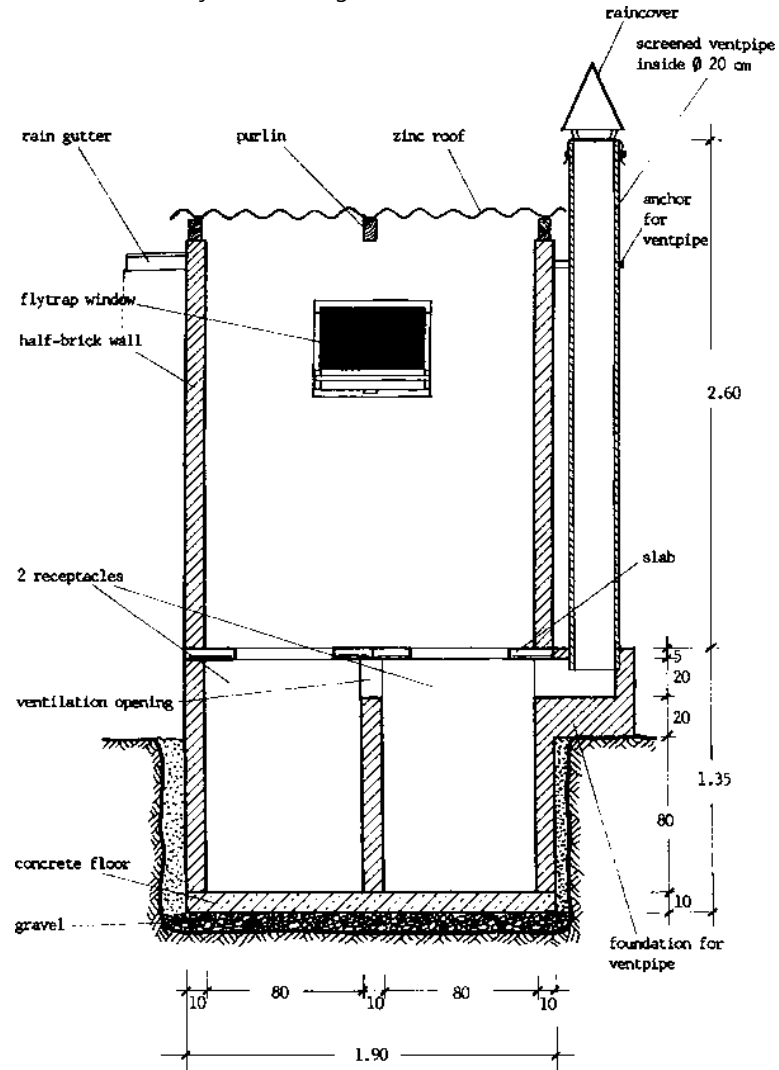

SCALE 1:25

**2. Compost Latrine with Local Superstructure**

The pit including the slabs is exactly the same as for the compost latrine from permanent materials.

**CROSS SECTION A-A**

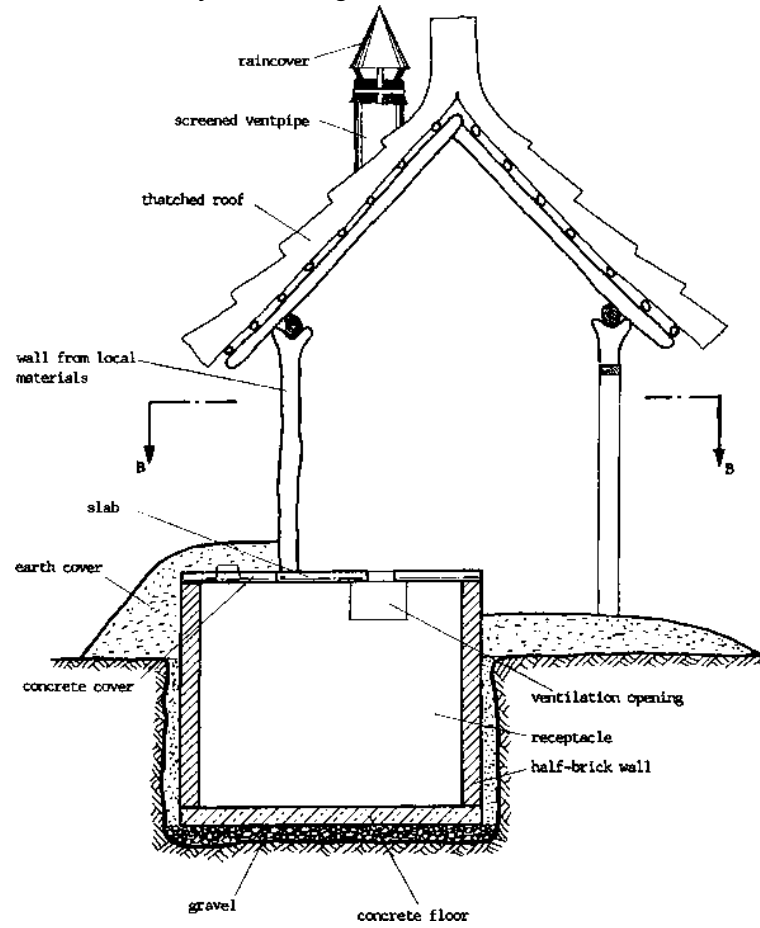

**LAYOUT PLAN B-B**

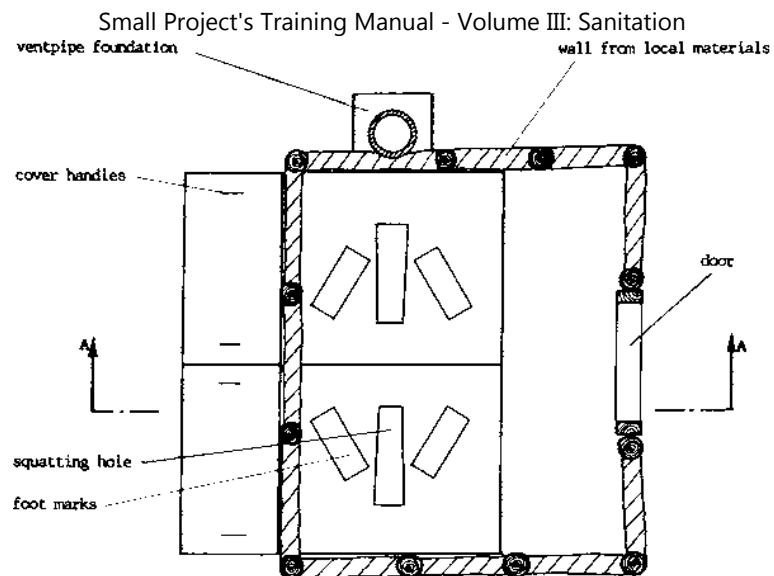

SCALE 1:25

### 3. Double Compost Latrine for Institutions (Schools, Offices, Clinics, etc.)

The volume of the two pits is 5.1 m<sup>3</sup>, the volume of all the four together is 10.2 m<sup>3</sup>. All walls are one brick walls (alternatively, the superstructure can be built as half-brick wall). A reinforced concrete beam spans the pit. For more users a triple compost latrine can be built.

#### Prefabricated Parts

Quant.	Item	Measurements	Remarks
2	concrete beams	15 cm × 20 cm × 2.50 m	reinforcement 2 Ø 10 mm
4	concrete slabs with squatting hole and foot marks	170 cm × 125 cm × 5 cm	reinforcement: welded mesh
4	concrete covers	85 cm × 125 cm × 5 cm	reinforcement: welded mesh; with two handles
2	lids from cement mortar 1:4	53 cm × 20 cm × 5 cm	see 9.14/19
2	wooden lids with handle	53 cm × 20 cm × 2 cm	see 9.14/19
2	ventpipes from ferrocement	inside Ø 20 cm, outside Ø 25 cm, length 2.70 m	reinforcement: chicken wire with screen and rain-cover

#### LAYOUT PLAN A-A: PITS



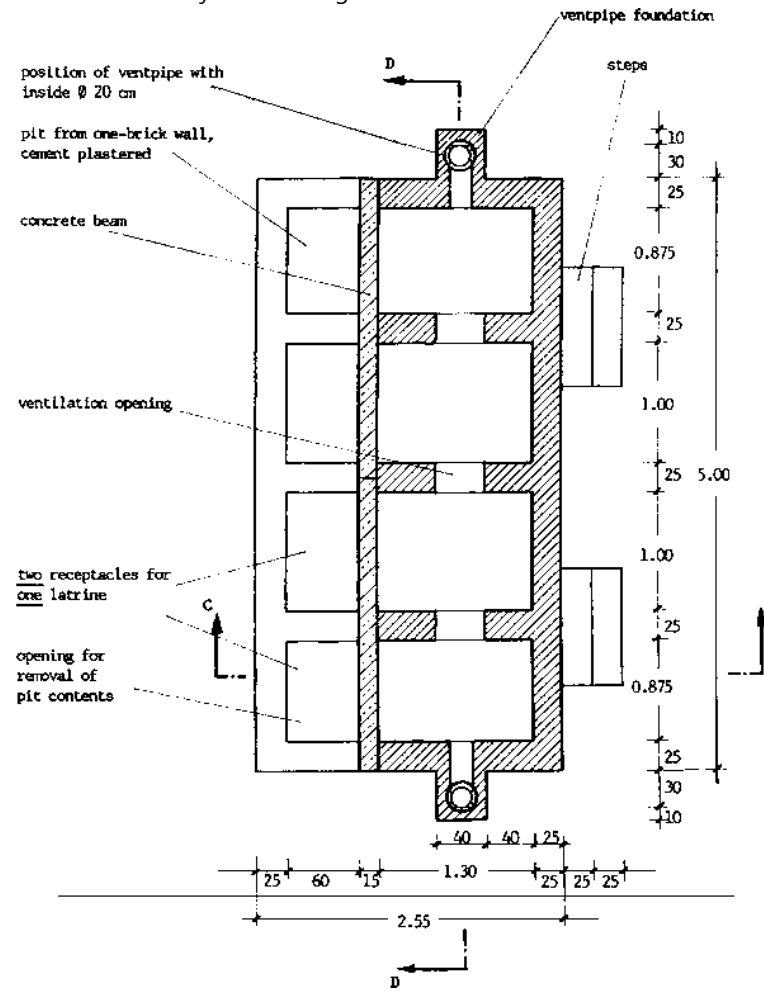

SCALE 1:40

**LAYOUT PLAN B-B: SUPERSTRUCTURE**

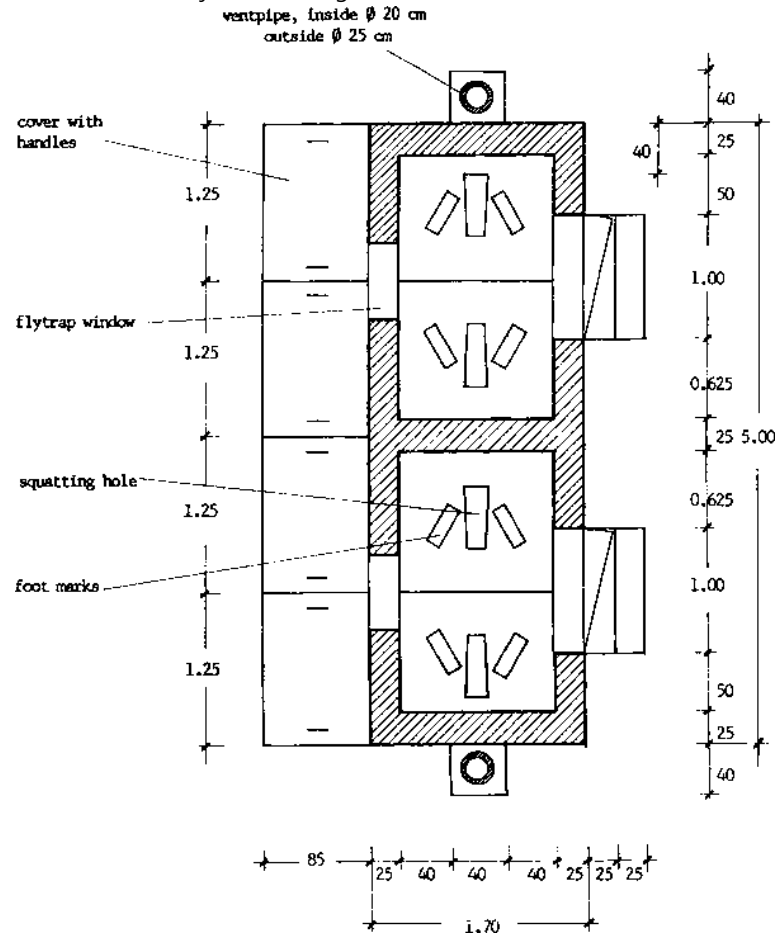

SCALE 1:40

**CROSS SECTION C-C: ACROSS THE BUILDING**

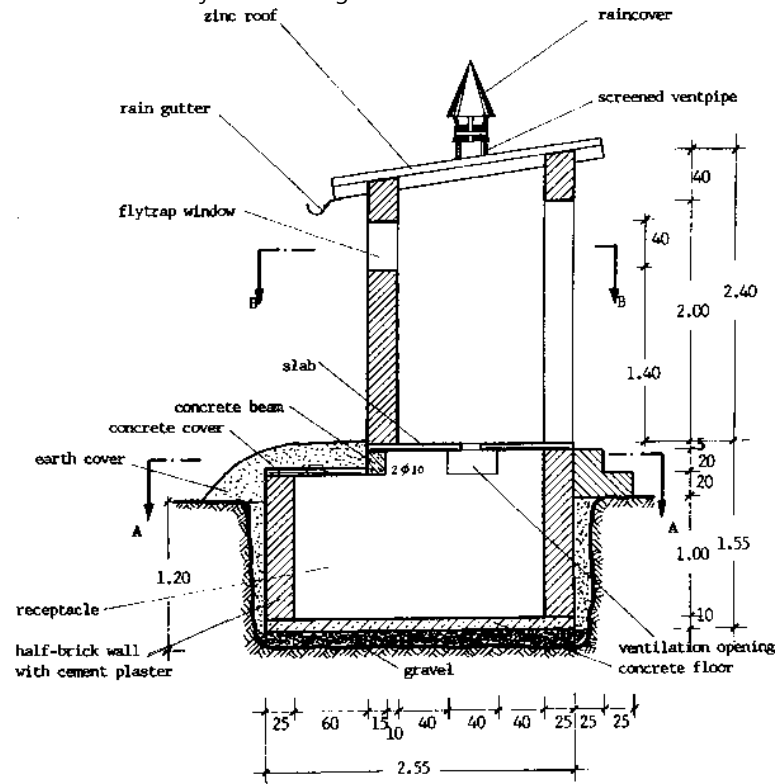

SCALE 1:40

CROSS-SECTION D-D: ALONG THE BUILDING

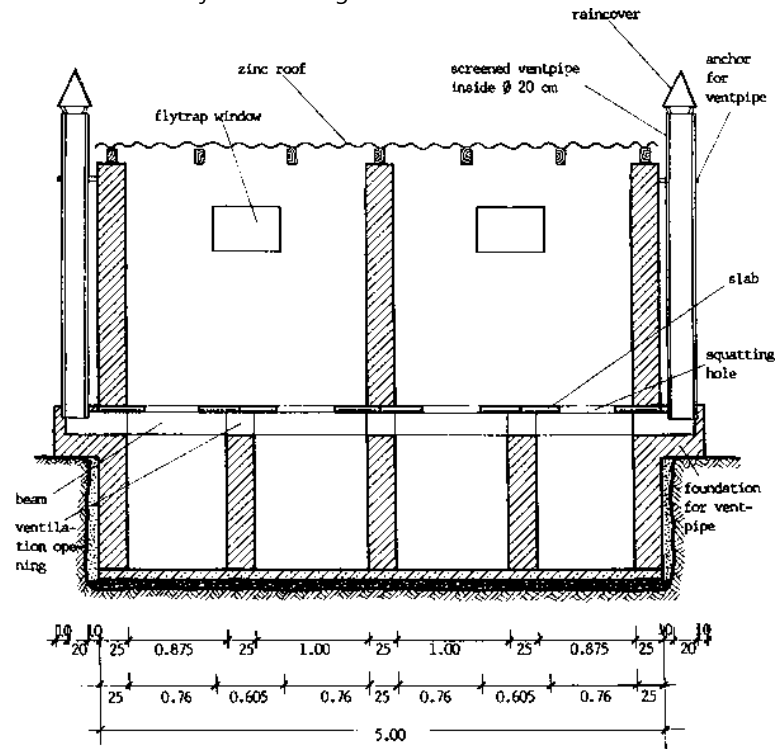

SCALE 1:40

## B) Step-by-step Procedures for Construction of a Compost Latrine, Standard Size

### 1. Pit

Dig a pit 2.00 m broad, 2.30 m wide, and 1.00 m deep, with straight walls (see 6.2, Marking Rectangular Layout Plan)

Pit 2.00 × 2.30 × 1.00

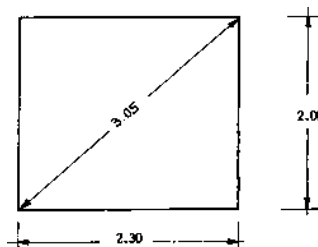

### 2. Slabs and Covers

- Prepare two sets of wooden frames from timber 2"×4" which can be used for manufacturing many slabs and covers (for measurements see 9.14/15).

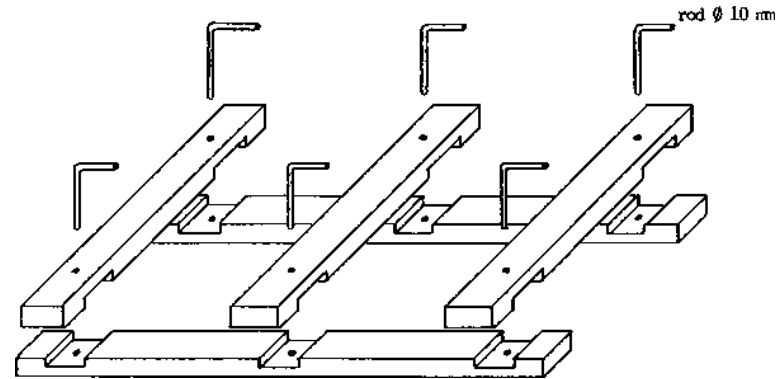
**EXPLODED DIAGRAM**

- Prepare a form for the squatting hole and the foot marks. It can be used for manufacturing many slabs. Cut it from plywood, and cut out the places for the squatting hole and the foot marks.

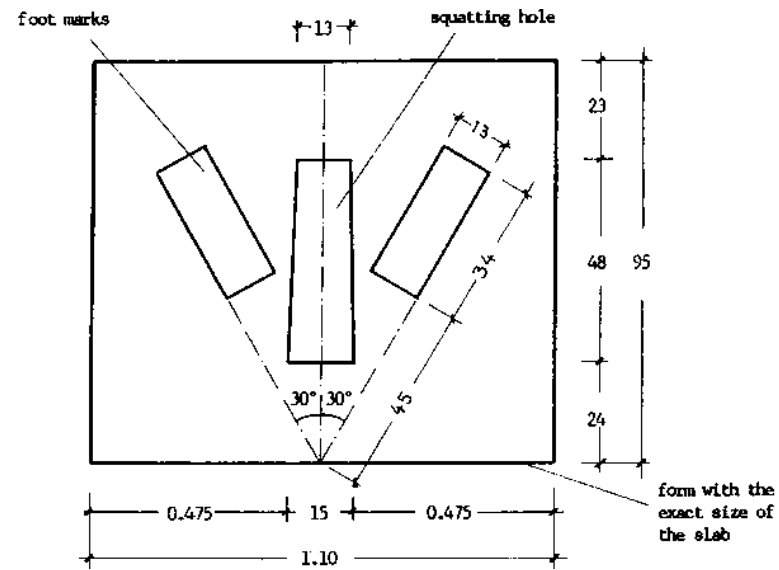

SCALE 1:12.5

- Reinforce all edges with timber 1" × 1" like this:

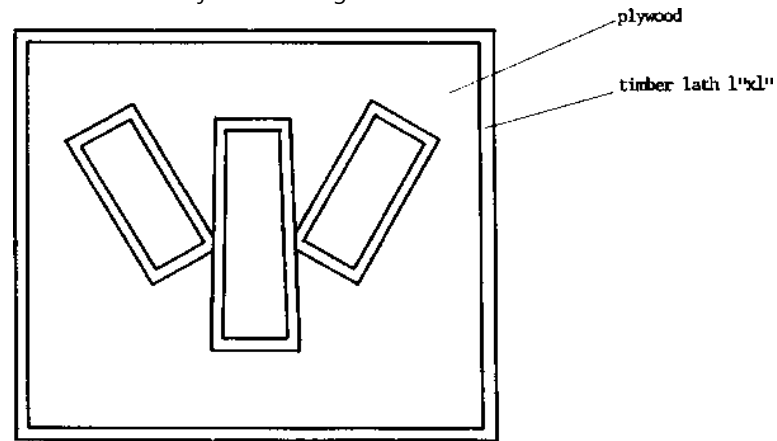

SCALE 1:12.5

- Prepare a wooden plug for casting the squatting hole which can be used many times. It needs to fit easily into the form for the squatting hole

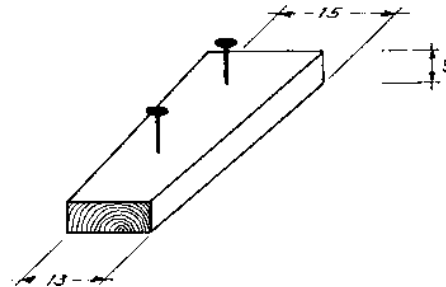

- Put wet sand on level ground, and level its surface with a straight edge.
- Paint the frame inside with old engine oil.
- Place the frame on the sand. Check the measurements inside and, especially, if both diagonals are equal. Slabs which are not rectangular cause a lot of troubles when placed on the pits later.

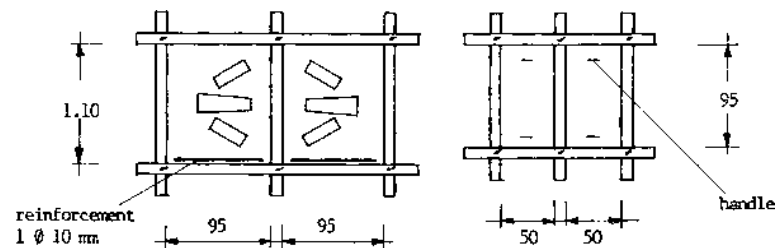

SCALE 1:50

- Place the plug for the squatting hole (see drawing above).
- Cut welded mesh in the size of slabs and covers. Cut out the places for the squatting holes. Cut reinforcement  $\varnothing$  10 mm for the beam. Cut handles for the covers from reinforcement  $\varnothing$  6 mm.
- Mix the concrete (mixtures see C).
- Pour concrete 1 cm thick into the frames and compact it well.
- Place the welded mesh, reinforcement  $\varnothing$  10 mm and handles on top of the concrete (location see above drawing).
- The position of the reinforcement should be like this:

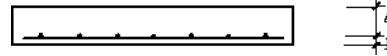

- Pour the rest of the concrete and compact it well.
- Make the top of slabs and covers straight with a straight edge. Make a concrete finish.
- Remove the plug from the squatting hole and apply a finish inside the hole.
- Mark on the slab where you have placed the additional reinforcement  $\varnothing$  10 mm.
- After an hour, cover the slabs and covers with wet sand and a nylon sheet.
- The frames can be removed after 6 hours.
- Keep slabs and covers wet for five days.
- Do not move or lift them before a week.

Slabs and covers can be either manufactured on site or centrally in a workshop. The latter is more economical if many latrines are to be built.

### 3. Floor

- Put some gravel into the pit and level it.
- Cast a concrete floor 10 cm thick and compact it well.
- Level the top. A concrete finish is not necessary.

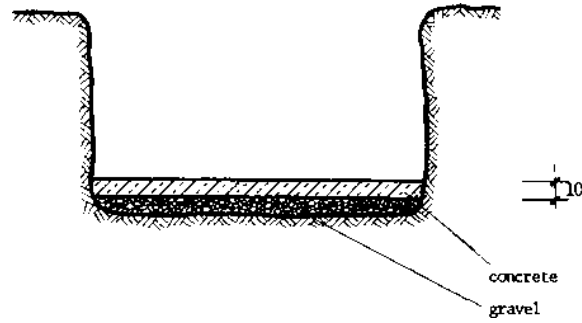

#### 4. Brick Walls

- Mark the layout plan of the pit (outside edge) on the concrete floor (see 6.2, Marking Rectangular Layout Plan).

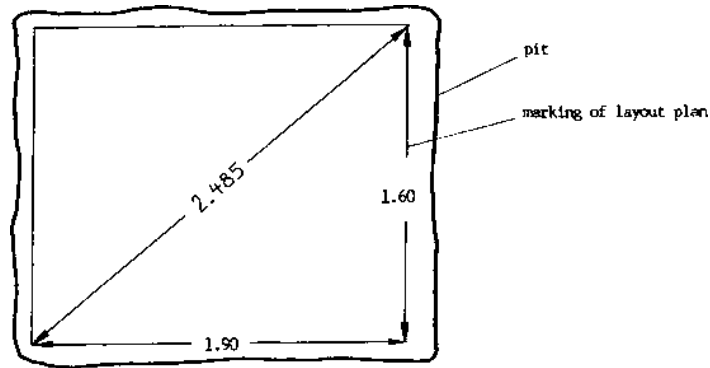

SCALE 1:25

- Span a building line. Check all sides and diagonals.

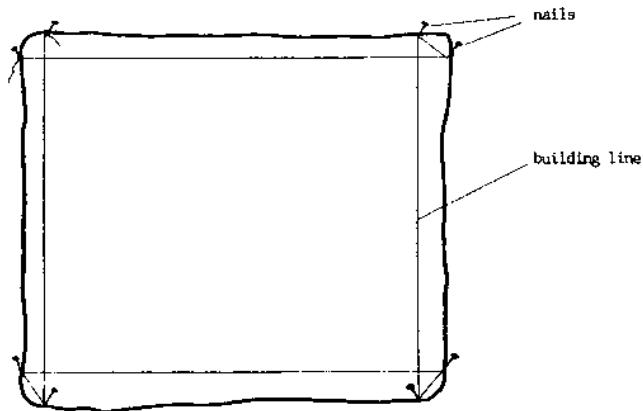



- Build the first course.

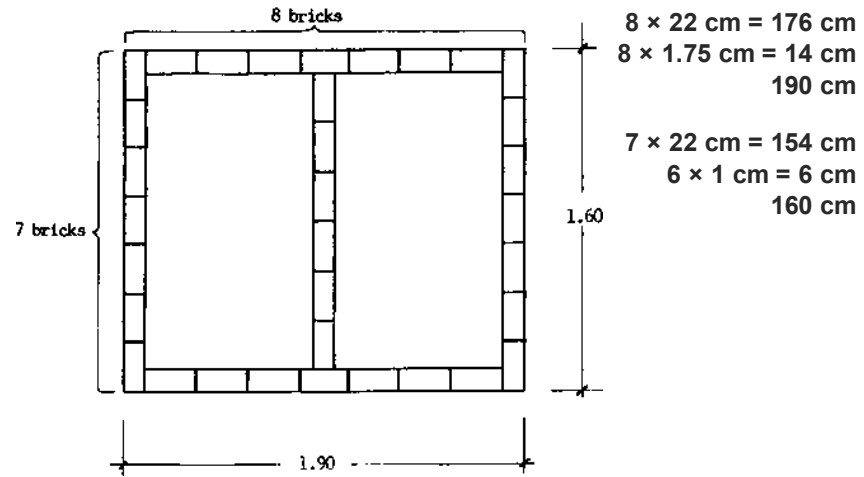

- Build the second course.

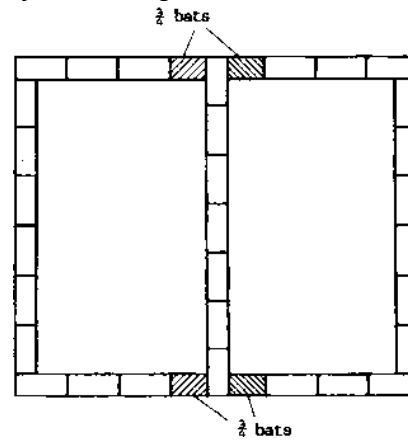

SCALE 1:25

- Build again the first course and continue building first and second course alternatively.
- Check the measurements and diagonals from time to time; check as well if the walls are vertical.
- Continue to build the walls until about 30-40 cm above ground; however, leave the openings for ventilation and to the ventpipe.
- Build the foundation for the ventpipe.
- For details see also 6.7, Bricklaying.

### 5. Plastering

- Plaster the two pits inside with cement mortar (mixture see C).

### 6. Preparing the Lids

- Make a heavy concrete lid for the squatting hole not to be used.
- Make a wooden lid with handle for the other squatting hole.

#### Concrete Lid:

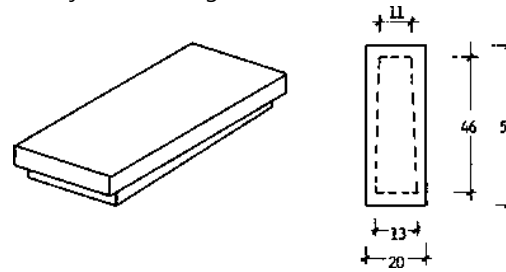

### Wooden Lid with Handle:

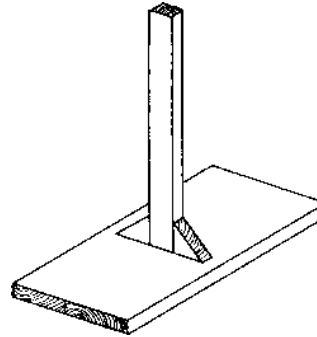

SCALE 1:15

### 7. Placing the Slabs

- The slabs must have been cured at least for two weeks before you can place them on the pit.
- Place cement mortar on the wall where you place the slabs.
- Place the slabs. The mark for the reinforcement  $\varnothing$  10 mm must be above the pit, not above the wall. The additional reinforcement  $\varnothing$  10 mm acts instead of a beam which spans the pit.
- The squatting positions must face each other (see drawing).
- Make sure with the spirit level that the slabs are horizontal. Fill in all cracks with cement mortar.
- Place mud mortar on the wall where you place the covers.
- Place the covers. Fill in all cracks with mud mortar.

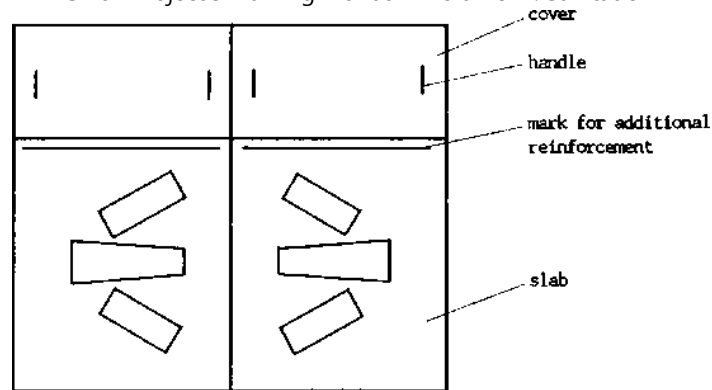

### 8. Superstructure

The superstructure is to be built by the owner. Its construction is conventional building. It can be done with permanent or local materials and shall not be described here.

### 9. Fixing the Ventpipe

Manufacturing ventpipes is described in 9.15. When the superstructure is completed,

- Fix mosquito wire on top of the ventpipe with wire.
- Fix a small roof on top of the ventpipe against rain.
- Fix the ventpipe in its foundation with cement mortar.
- Connect the ventpipe with the superstructure with an anchor from flat iron or similar.

### 10. Preparing the Latrine for Handover

- Clean the pits and slabs from mortar and brick rubble. The pit must be dry.
- Prepare the pit for use as described in 9.16.
- Put earth over the covers as an additional seal.
- Put the heavy concrete lid on the squatting hole not to be used first.
- Put the wooden lid on the other squatting hole.
- Place a basket with ashes or sand with a tin, a broom and papers in the latrine.
- Fix the posters for instruction on the wall.

### 11. Operating Instruction

After the technical work is done, inform the community development staff to conduct an operating instruction for the users of the latrine (see 9.17).

**C) Materials Needed for a Compost Latrine, Standard Size, without Superstructure**

Work	Cement Buckets	Sand Buckets	Gravel Buckets	Mixture	Bricks	Other Material
slabs	3	8	6	1:2.7:2	---	1 welded mesh plus reinforcement Ø 10
finish of slabs	1/2	---	---	---	---	---
filling under floor	---	---	10	---	---	---
floor	3	8	10	(1:3:4)	---	***
walls	4 $\frac{1}{2}$	18	---	1:4	700	---
ventpipe foundation	$\frac{1}{2}$	2	---	1:4	30	---
plastering	2	12	---	1:6	---	---
fixing slabs and ventpipe	$\frac{1}{2}$	2	---	1:4	---	ventpipe mosquito wire
steps	$\frac{1}{2}$	4	---	1:8	20	---
contingency	1 $\frac{3}{4}$	26			250	
<b>Total</b>	16 $\frac{1}{4}$ = 5 bags		50		1000	

1 bag of cement =  $3\frac{1}{4}$  buckets; 1 bucket is about 10 litres;

\*\*\* in black cotton soil put 2 layers of welded mesh into the floor (see 6.6/11).

### 9.15. Ventpipes

Some basic information about ventpipes for latrines and a way to manufacture ventpipes locally are compiled here.

#### A) General Information

A correctly installed and well maintained ventpipe is an improvement for any pit or compost latrine. It has the following functions:

1. It provides ventilation for the pit. The gases produced during composting can escape.
2. It enables the contents of the pit to dry (in a hot climate).
3. It acts as a fly-trap.

In order to serve these purposes, the following conditions must be fulfilled:

file:///D:/cd3wddvd/crystal\_A6/construction/stuff.htm

1. The ventpipe must have a sufficient diameter, either a smaller diameter with smooth inside surface or a larger diameter with rough inside surface. 10 cm diameter is the minimum for smooth pipes, 15 - 20 cm diameter is better.
2. The ventpipe must be long enough; it should reach higher than the highest point of the roof (to avoid turbulences above the ventpipe).
3. It is an advantage if the ventpipe is dark or black because it will heat up more and, thus, create an upward draft.
4. It should be exposed to sun. The sun will heat it up and create an upward draft.
5. Rain should be prevented from entering the ventpipe by a small cover. There must be sufficient space between the top of the pipe and the cover to allow air to pass (drawing see 9.3/3).
6. The top of the ventpipe must be sealed with mosquito wire to prevent flies from escaping and, thus, kill them. As the gases produced by the composting process are highly corrosive, ordinary mosquito wire gets holes after some time. It is most essential to replace the mosquito wire every 6 to 12 months.
7. The footing of the ventpipe must have no cracks which would allow flies to escape.

A ventpipe with its screen torn is worse than a latrine without a ventpipe. The warm gases escaping from the ventpipe will attract by their smell more flies than without a ventpipe. You can feel the gases with your hand over a ventpipe if the composting process has already begun.

Therefore, you should only install a ventpipe if you or the users are able and ready to maintain it, i.e. to replace the mosquito wire regularly. Otherwise, it is better to have a latrine without a ventpipe. Such a latrine can also function well and be smell-free if sand and ashes are poured into the pit after each use.

#### B) Manufacturing Ventpipes Locally

Manufacturing ventpipes locally might be an alternative to industrially produced plastic or metal pipes which can be expensive depending on the logistics facilities of the area. Do not use asbestos cement pipes because mining and production of asbestos cause asbestosis, a deadly lung disease for the workers.

Also, local manufacturing encourages local skills and local trade and provides work and income.

Ventpipes from ferrocement, inside  $\varnothing$  20 cm, can be produced according to the following steps:

1. Make a mould for the ventpipe by sewing a 0.65 m  $\times$  2.50 m sack-cloth to form a sleeve or pipe. Preferably, take good quality sack-cloth or canvas.

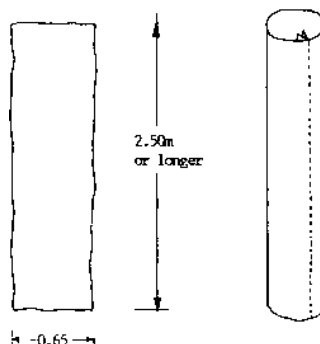

2. Fix a ring of reinforcement  $\varnothing$  8 mm or a ring of flat iron, 2 cm broad, on top and bottom of the sack-cloth pipe. A double ring from flat iron to be closed by a bolt can be

easily fixed and removed again. The sack-cloth is clamped in between the two rings.

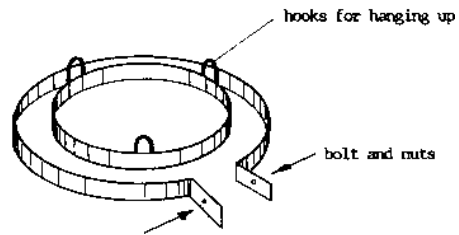

3. Dip the sack-cloth pipe into water until it is completely wet.

4. Hang the top of the sack-cloth pipe on the roof truss. Place some bricks and a piece of plywood under its bottom end.

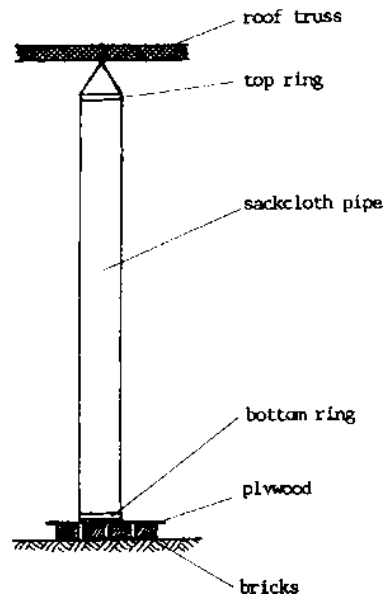

5. Fill the sack-cloth pipe with sand from the top. Take care that it is straight.

6. Mix cement mortar 1:4.

7. Plaster the sack-cloth pipe evenly in a 1 cm thick layer.

8. Cover the pipe with a nylon sheet.

9. Next day wrap one layer of chicken wire around the pipe.

10. Make the pipe wet.

11. Add a second layer of plaster 1 cm thick. Smooth the outside of the pipe.

12. Cover the pipe with a nylon sheet and keep it wet for three days,

13. Wait for seven days.

14. Remove the bricks and the plywood.

15. Remove the sand.

16. Lower the pipe to the ground.

17. Remove one of the rings holding the sackcloth.

18. Pull out the sackcloth pipe.

19. Store the pipe carefully and let it cure for another two weeks.

A ventpipe of this kind is quite heavy. The inside is not completely smooth and the pipe might not be completely straight, but the large diameter compensates for that.

The ventpipe is quite strong once installed, but not very resistant to damages during transportation. It should not be transported over long distances by car and should be handled with great care.

The ventpipe can also be manufactured without chicken wire (because of the costs). In that case it must be carefully kept wet for three days and even more care is needed for transportation.

Another alternative to produce ventpipes locally is by making chimney blocks. Square blocks with a round opening are made from a cement/sand mixture or cement/soil mixture and then built as a ventpipe into the corner of the latrine (see bibliography No. 46, April 83).

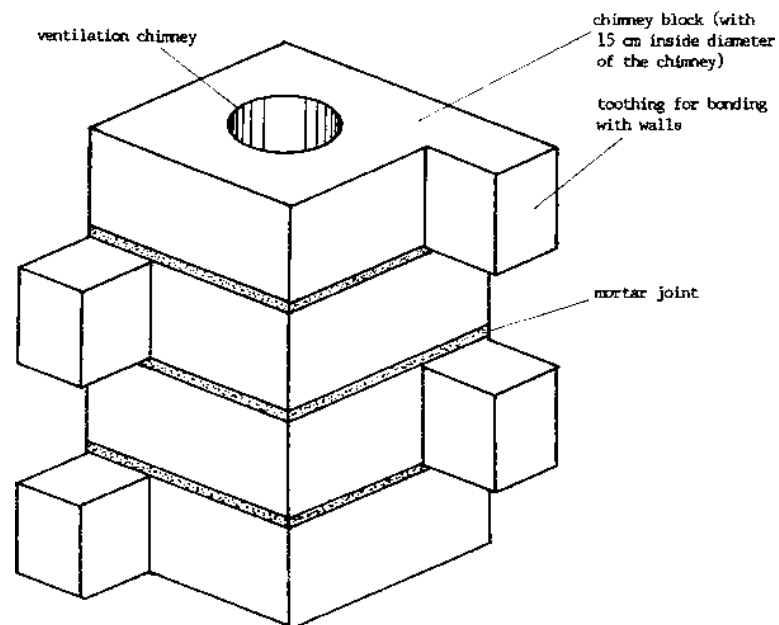



### 9.16. Operation and Maintenance of a Compost Latrine

The following operating instructions are primarily intended for a compost latrine. But they are as valid for all sanitation systems without water, like

- pit latrine of local materials,
- VIP (ventilated improved pit latrine),
- children's squatting slab.

Any pit latrine will function better if managed like a compost latrine.

#### A) Essential Equipment Inside the Latrine

The following items are vital for a well kept latrine. Provide, maintain and replace them when broken:

- basket or any other container with ashes and sand,
- calabash or tin for sprinkling ashes and sand,
- container with waste paper or toilet paper (if people use paper for anal cleaning; when paper is not provided, people might use the leaflets from the wall for their cleaning),
- broom (not to be used elsewhere),
- removable lid for squatting hole,
- permanent, heavy lid for squatting hole of the second receptacle (from concrete or timber with a heavy stone; see 9.14/19),
- instruction leaflets and posters on the wall.

#### B) Starting-up a Latrine

Before the latrine is used for the first time, put into the receptacle some loosely packed organic residue: grass, weeds, leaves, sawdust, yard sweepings. This absorbs liquids, provides carbon for the composting process, increases the variety of micro-organisms and prevents the pile from becoming too compact. All compost and pit latrines will function better if you start them up like this.

#### C) Daily Use

The daily use is described in the leaflet following which is to be used for explanation and shall be finally fixed on the wall of the latrine.

These rules are the core of good latrine keeping. Success of a latrine will depend on keeping them or not. The reasons for these rules are given in chapter 9.13.

It is not easy to introduce these rules in an extended family, an office or school community, etc., using a latrine together.

## How to use your compost latrine

1. Put some sand or ashes into the hole after each use! 
2. Close the lid after each use! 
3. If dirty, pour sand over the dirt and sweep it into the hole! 
4. Put grass, leaves, sweepings, kitchen left overs into the hole several times a week! 
5. **Do not** pour any water into the hole! Clean the latrine dry or with wet grass, but do not rinse it with water! 
6. **Do not** put glass, tins or plastic into the hole! 
7. **Do not** use disinfectant, old engine oil or DDT! 

Sudan Council of Churches  
Munuki Water and Sanitation Project  
1.1.85/MGG

**Sika ita stamilu  
al bachana min ufraten**

1. **Kutu** ramla walla romat basit fi ufra bad ita stamilu! 
2. **Gafulu** kuta bad ita stamilu! 
3. **Kan** waskan kubu ramla fogu wasaka de wa nadifu jua al ufra! 
4. **Kutu** gesh, warsal, wasaka al nadifu min midan taki wa min madba fi ufra kullu usbu! 
5. **Mata** kubu moya fi ufra kullu kullu! Nadifu musta yabis walla ma gesh al bilu be moya, lakin ma ta kasilu ma moya! 
6. **Ma ta** kutu gisarat walla hilbat walla listic walla naylon fi al ufra kullu kullu! 
7. **Ma ta** stamil Dettol walla Finik walla zet mahruk walla DDT kullu kullu! 

**كيف تستعمل  
المرحاض ذو العزائين**

١ وضع الرمل أو الرماد داخل  
العفرة بعد الاستعمال.

٢ اقل العفرة بعد كل استعمال.

٣ إذا غير منظف دقق الرمل على  
الأوساخ ثم نظفها إلى داخل  
العفرة.

٤ وضع القش، أوراق، أوساخ و  
البقايا الأكل في الطبخ داخل  
العفرة مرات عديدة في الاسبوع.

٥ لا تدفق الماء داخل العفرة، نظف  
المرحاض نظيفاً بالقش مبلو بالماء  
و لا تدخلها داخل الماء.

٦ لا توضع الزجاج أو المصحف المقطع  
أو البلاستيك إلى داخل العفرة.

٧ لا تستعمل المبيدات للعشرات أو  
زيت الماكينة القديمة أو DDT.

مجمع الكنائس في السودان، جوبا، ص.ب ٢٩  
مشروع منوكي للإسماح و الماء

1985/MGG

Sudan Council of Churches - Munuki Water and Sanitation Project - Juba, Box 209

To run a compost latrine successfully requires a kind of "administration", such as home administration or school administration. The up-keep needs to be organised, implemented and followed up.

We suggest compiling the work which needs to be done regularly in a check list:

**Tasks of the person caring for the latrine:**

**Daily**

- Sweep the latrine.

**Once a Week**

- Fill the basket with ashes and sand.
- Fill the basket with paper.
- Sweep the walls.
- Put grass and leaves into the latrine.
- Check posters and leaflets.
- Check the contents of the pit whether they are dry.
- Check if the outside lids are well covered with earth.
- Check the screen on the ventpipe.

The following suggestions shall help to ensure a proper up-keep:

1. A person needs to be assigned for overall responsibility concerning the latrine, preferable an elderly person or somebody else with authority. The up-keep of latrines does not work if no one or everybody is responsible. For the daily and weekly up-keep, the different members of the community can be assigned in weekly shifts. The person in overall charge shall remind and encourage the members in their tasks.
2. Repeated instructions of the community or family are necessary, like an operating instruction in the beginning and follow-ups later on. Sit down from time to time with the family/community to discuss problems and remind the members of the correct use.
3. Make use of the psychological effect: A clean place is much less likely to be messed up than a dirty one. Keep your latrine very clean and people will hesitate to mess it up.
4. Keep an eye on who is using the latrine. Usually it is always the same people who notoriously make the latrine dirty. Check the latrine after such a person has used it and, if it is dirty, call her/him back to clean it. Insist that the one causing the dirt will clean it him/herself without quarrelling.
5. Do not use latrine cleaning as a means of punishment or threat for faults of other kind. Do not assign the lowest status people in the family/community for latrine cleaning. This produces the deep impression that latrine cleaning is something shameful and disagreeable. On the contrary, try to explain that by cleaning the latrine we are contributing to the life cycle and preventing diseases, which is a very important and honourable task. Additionally, as Christians we are called to the service of others.

#### D) Changing Vaults (see leaflet following page)

When the receptacle of a compost latrine is almost full, cover the pile with grass and soil. Close the vault with a heavy lid and start up the second receptacle.

#### E) Removing Compost

When the second receptacle is nearly full, it is time to remove the compost from the first one. Take off the cover, and remove the contents with hoe and shovel. Do not remove all of it, but leave some to give the new pile a good start. The compost should by now be fairly dry, soil-like and completely odour-free. It is very much reduced in volume. It is not any more dangerous to handle than soil in the garden. Carry the compost to the garden and put it into a shallow trench. Cover it with about 10 cm of topsoil and grow vegetables on top.

#### F) Number of Users

A compost latrine should not be overloaded; that is used by too many people. 15 to 20 people can use the standard size of compost latrine (volume 2.7 m<sup>3</sup>) and will need about one to one and a half years to fill one receptacle. All kitchen waste of the same number of people should be added to provide sufficient carbon.

#### G) Maintenance of the Latrine

Keep the outside covers (those used when emptying the latrine) well covered with earth. Arrange the ground around the latrine so that surface water drains away.

Check the screen on the ventpipe. If it has a hole, replace it. Ordinary mosquito screen might be corroded after 3 months only.

## How to empty your compost latrine

1. Use one receptacle only! The other one is closed with a permanent lid.

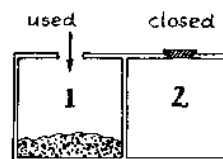

2. When almost full, put grass and soil into receptacle and close it with the permanent lid! Use the second receptacle!

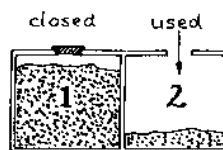

3. When the second receptacle is almost full, put grass and soil into it and close it with the permanent lid! Empty the first receptacle with hoe and shovel! Use the compost in the garden! Now use again the first receptacle!

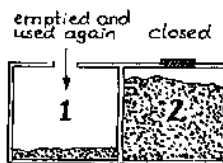

4. Continue to use the 2 receptacles alternatively, one at a go!
5. When emptying, repair any cracks with cement mortar and replace the mosquito wire on the ventpipe if corroded!

1985/MGG

Sudan Council of Churches - Munuki Water and Sanitation Project - Juba, Box 209

# Teriga anina befadi al bachana min ufraten

1. **S**tamil safa wahid bas! Tani da yakun mogful tamam.

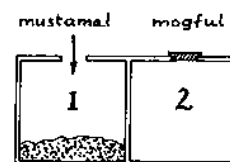

2. **K**an gerib malyan kutu gesh wa torab fi al ufra wa gafulu tamam! **S**tamil al ufra tani de!

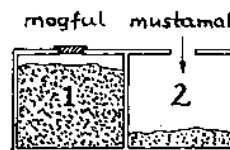

3. **K**an ufra tani gerib malyan, kutu gesh wa torab fogu wa gafulu tamam! **F**adi al ufra nimra wahid be toria wa korek! **S**tamil tin al kwais da fi jenena betak! **H**assa raja fi ufra nimra wahid!

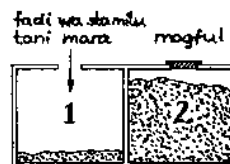

4. **S**tamir stamilu al ufraten be dor!

5. **A**ssa ita be fadi, salau mahalat moksurin be muna sement wa salau al numulia fog al masura kan karabu!

Mejles al kanais- Juba, Munuki  
1985/MGG

Sudan Council of Churches - Munuki Water and Sanitation Project - Juba, Box 209

### كيف تتفرغ مراحيضك

**١** استعمال واحد حفرة فقط و تغفل حفرة الثانية بالغطاء ثابتة

**٢** وإذا ملئ الحفرة الاول ضع القش و التراب على الغطاء ثابتة و استعمال الحفرة الثانية.

**٣** وإذا ملئ الحفرة الثانية وضع القش و التراب عليها و اقلها ثم اخرج البراز باستعمال الجاروف و بعد إخراج البراز أدفنها في الزرعة الاغضروات و الان استعمال الحفرة الاول.

**٤** وتستمر هذه الطريقة بعد ملئ كل حفرة حتى حيث أخر.

**٥** إذا تريد أن تفرغ صلح الاماكن المكسورة بتسعمال السمنت و الرمل ثم النملية على ماسورة التهوية.

مجمع الكنائس في السودان، جوبا، ص.ب ٢٠٩  
مشروع منوكي للإصحاح و الماء

1985/MGG

Sudan Council of Churches - Munuki Water and Sanitation Project - Juba, Box 209

#### H) Rehabilitation of a Compost Latrine

A well kept compost latrine is odour-free and without flies. But what to do if the slab looks like a "map", is full of urine and faeces, with hundreds of flies swirling around, and the pit is like a smelly pool??? Such a latrine needs a general rehabilitation.

##### 1. Procedure

- Scratch all faeces from the slab with sticks into the hole.



- Pour lots of sand and ashes over the wet slab and let it soak.
- Brush the sand into the pit and repeat several times.
- Pour earth, sand and ashes into the pit until no water can be seen anymore and the contents are wet, but not soaked. You might need quite a lot of material for that.
- Pour grass, leaves and especially ashes in plenty into the pit. The contents most likely have too much urine and not enough carbon.
- Clean the inside of the latrine including walls.
- Rub the slab with wet grass or wet sponge and throw it into the pit. Do not rinse the slab with water.
- Pour ashes over it and sweep them in.
- Replace or provide baskets with sand and ashes, paper, broom, lid, etc.
- Check the outside of the latrine for eventual necessary maintenance.
- Seriously advise the users for future use.

If such a rehabilitation is done in time, the pile can still decompose reasonably. If you have to empty a compost pit and the contents are not decomposed but a cesspool, it will be very unpleasant to empty it (by hand or desludging truck).

Learn from experience and keep the latrine better.

**Do not blame the compost latrine, but the people who failed to teach and implement the proper up-keep.**

## 2. Example for a Rehabilitation of a Compost Latrine in an Institution (School or Office)

The following detailed action plan is advisable if we want durable improvement. For compost latrines in private homes the rehabilitation process is to be simplified but keeping to the same basic steps.

- Form a group to work on this task.
- Contact the persons responsible for the compost latrine(s) and ask for permission and support for the action.
- Prepare an "action plan".
- Develop a questionnaire.
- Test the questionnaire.
- Prepare and duplicate the final questionnaire.
- Conduct interviews with the users.
- Inspect the compost latrine and write a small report.

- Evaluate interviews and inspection.
- Prepare users' meeting about problems.
- Conduct the meeting with the aim of a decision about how to manage the compost latrine(s) in future.
- Do the practical rehabilitation including cleaning, making the pits dry, and providing missing equipment.
- Prepare operating instruction with drama, poster and health education.
- Conduct operating instruction.
- Handover the compost latrine(s) with the keys to the people in charge.
- Follow up the compost latrine regularly for eventual problems.

#### Guidelines for conducting the interview:

- Introduce yourself.
- Ask if the time is suitable.
- Explain purpose of interview (which is: gathering information about compost latrines in general, gathering information for improving the compost latrines on the SCC compound).
- Ask if the person is ready for the interview.
- Ask the questions and fill the questionnaire. Make sure that the person has understood the question properly. Do not comment on the answers. Note down the answers also if they are wrong.
- Ask if you can note down the name of the person. If not, note down only male or female.
- Hand out the anonymous questionnaire. Ask for it to be filled in and thrown into the closed box.
- Thank for the interview.

#### Sudan Council of Churches \* Munuki Water and Sanitation Project

#### INTERVIEW OF COMPOST LATRINE USERS ON THE SCC COMPOUND

#### QUESTIONNAIRE

- 1- Did you hear about compost latrines? yes/no
2. Do you know what a compost latrine is? yes/no

3. How many pits does a compost latrine have .....  
.....

4. Why does a compost latrine have two pits?  
.....  
.....  
.....

5. What happens with the contents of a compost latrine?  
.....  
.....  
.....

6. Why do we need to put ashes or sand into the compost latrine after defaecation?  
.....  
.....  
.....

7. Why must the squatting hole always be covered by the lid?  
.....  
.....  
.....

8. Do you like compost latrines? **yes/no**  
Why?.....  
.....  
.....

9. Do you see any difference between the left and the right compost latrine on the SCC compound? **yes/no**

10. Are there any problems with the compost latrine on the right side **yes/no**

Which problems?.....  
.....

Is the latrine dirty? **yes/no**

11. What do you think are the reasons for these problems?

.....  
.....

12. Are there any problems with the compost latrine on the left side?

yes/no

Which problems?.....  
.....

Is the latrine dirty?

yes/no

13. What do you think are the reasons for these problems?

.....  
.....

14. How do you think these problems could be solved?

.....  
.....  
.....  
.....

15. Are you ready to attend a meeting about the latrine problem?

yes/no

16. Can your department contribute regularly money for the latrine up-keep?

yes/no

17. Are you ready to participate personally in the latrine cleaning in shifts?

yes/no

only if.....  
.....

18. Are you ready to attend an information meeting for the users?

yes/no

19. Would your department like to take over responsibility for the care of one of the compost latrines? yes/no

20. Which of these suggestions No. 15-19 would you prefer?

No.....

21. Do you have any further comments or suggestions?

.....

.....

.....

.....

.....

.....

.....

.....

22. Are you ready to give

your name:.....

title:.....

department:.....

male/female

Date of Interview.....

Name of Interviewer:.....

Sudan Council of Churches \* Munuki Water and Sanitation Project

GATHERING INFORMATION ABOUT COMPOST LATRINES ON THE SCC COMPOUND

QUESTIONNAIRE

Please kindly answer the following questions. They are necessary for gathering information about the sanitation situation on the SCC compound. Make a cross at the correct answer. You can cross several possible answers. Do not write your name on the questionnaire. Please, throw the filled questionnaire into the closed box in the Munuki office. Thanks.

1. Are you

0 male

0 female

2. Where do you go for a long call?

0 outside the SCC compound into the bush

0 to the flush latrine (WC) near the dispensary

0 to the flush latrine (WC) in one of the guest house rooms

- 0 to the compost latrine on the left side
- 0 to the compost latrine on the right side
- 0 at home

### 3. Where do you go for a short call?

- 0 outside the SCC compound into the bush
- 0 at the fence
- 0 in the bathroom behind the generator
- 0 to the flush latrine (WC) near the dispensary
- 0 to the flush latrine (WC) in one of the guest house rooms
- 0 to the compost latrine on the left side
- 0 to the compost latrine on the right side
- 0 at home

\*\*\*\*\*

### 9.17. Operating Instruction for Compost Latrines

For all compost latrines built, an operating instruction is conducted for the users. The most important point is not just to have a latrine building, but to use it properly and keep it clean. Otherwise, it will be worse than defaecation in the open and not only become a nuisance, but a danger to health as well.

Therefore, the operating instruction is aimed at giving the future user an idea about what they can do to keep and maintain the latrine properly to avoid problems. It is conducted at the place of the latrine with all members of the household or institution who are going to use the latrine.

The methods used are demonstration, drama, posters, model, leaflets, flip-chart, songs, depending on the audience and the time available (see 4.26 to 4.29).

The topics covered are as follows:

- Why do we need a latrine?
- What is a compost latrine?
- How do we use a compost latrine?
  - \* every day (see poster series attached)
  - \* when full (see poster series attached)
- What else do we need to pay attention to?
  - \* Who is responsible for taking care?
  - \* What to do if there are problems?

The operating instruction will be followed by regular follow-up visits (see 9.18) and may be repeated if need be.

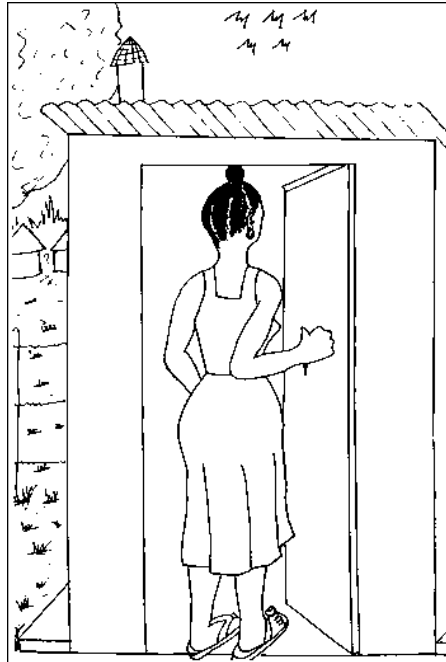
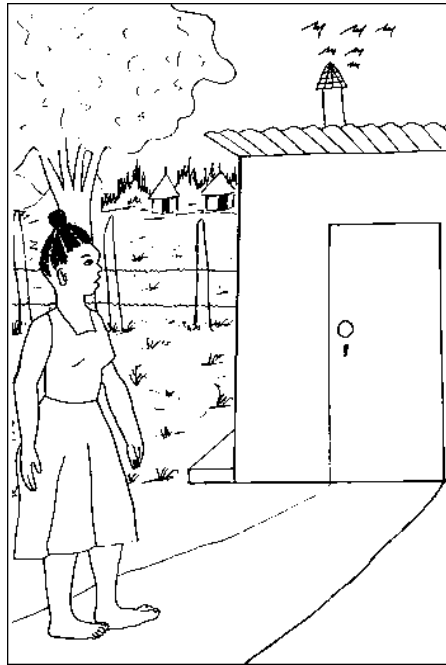





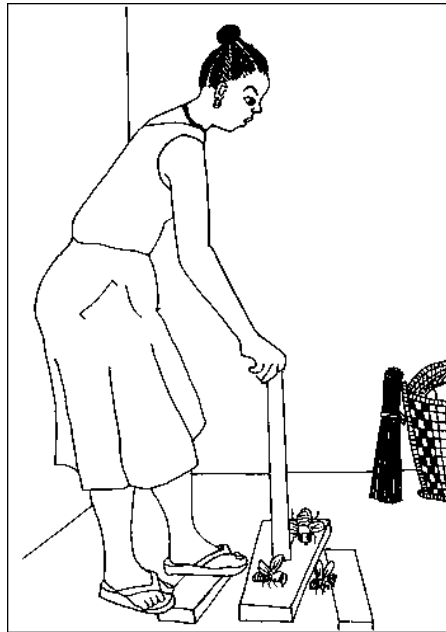

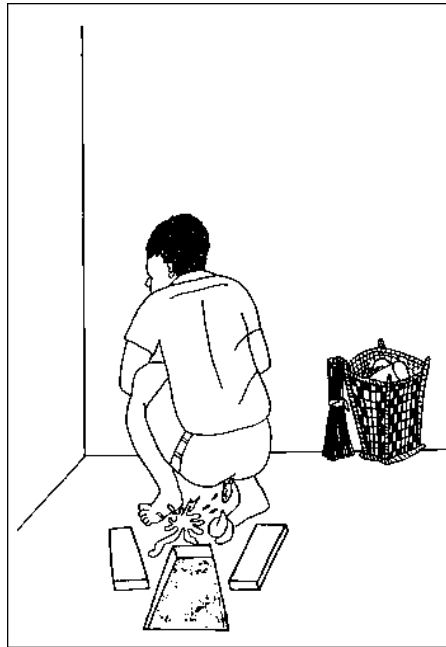

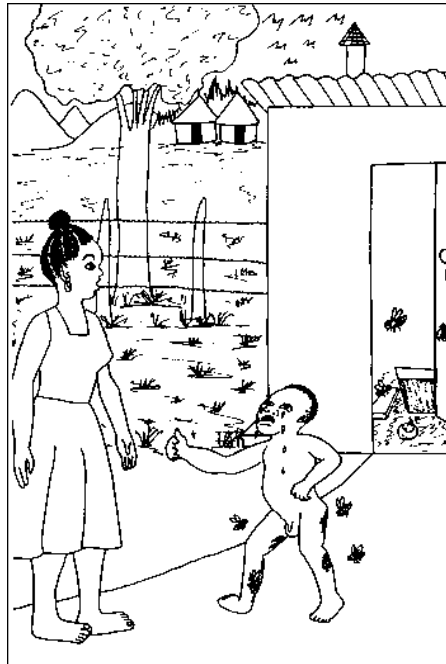
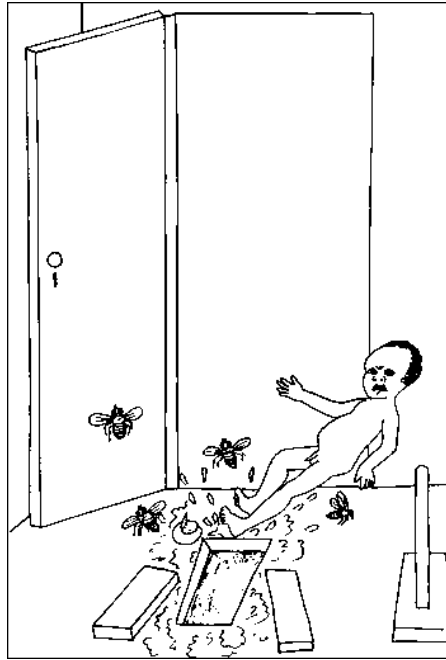

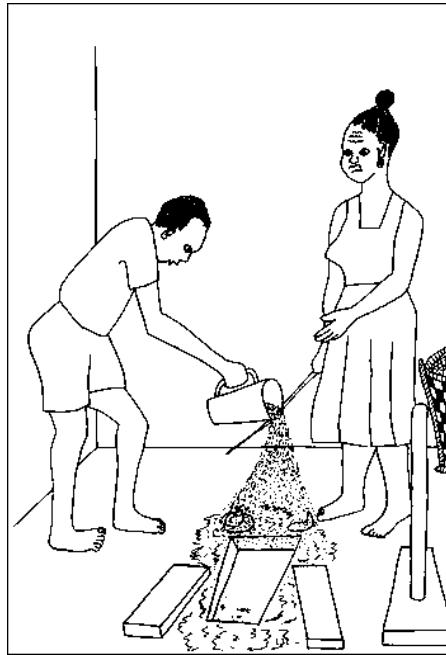
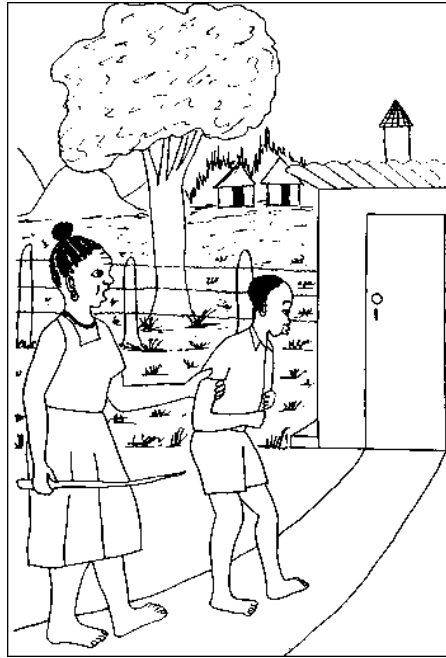





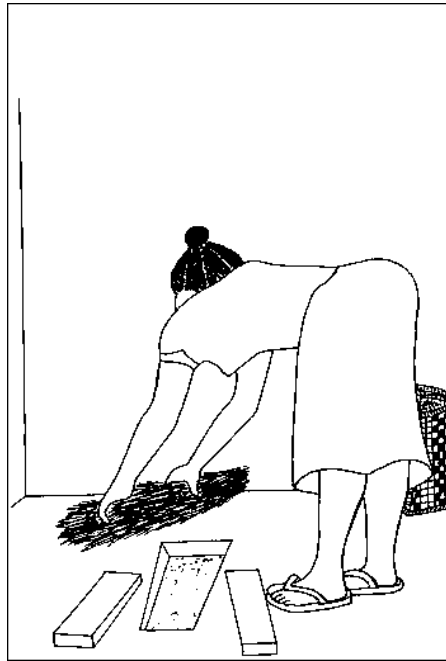

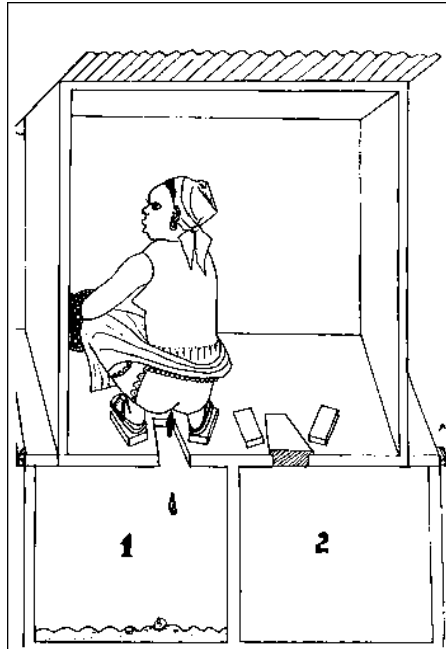



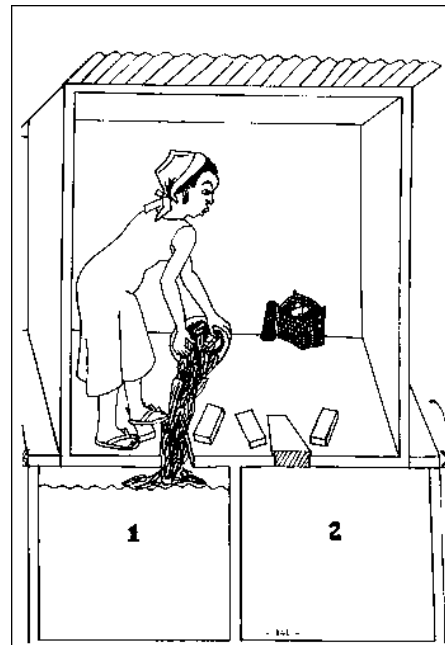
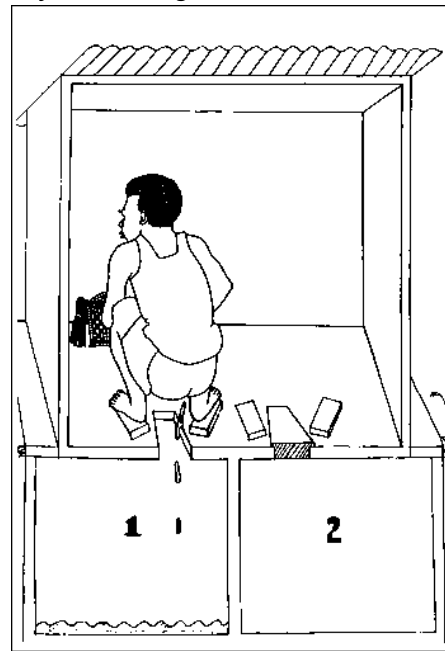

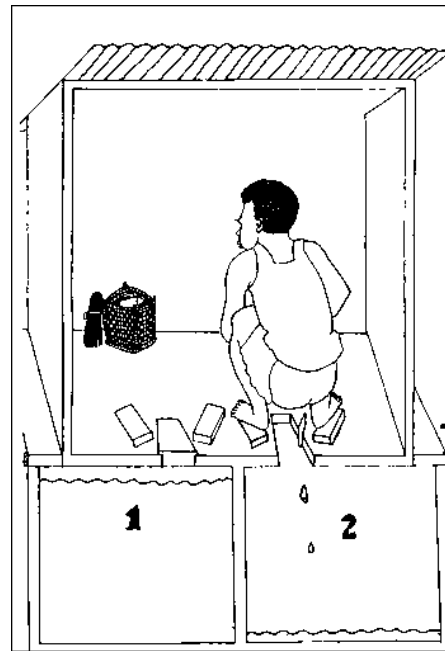
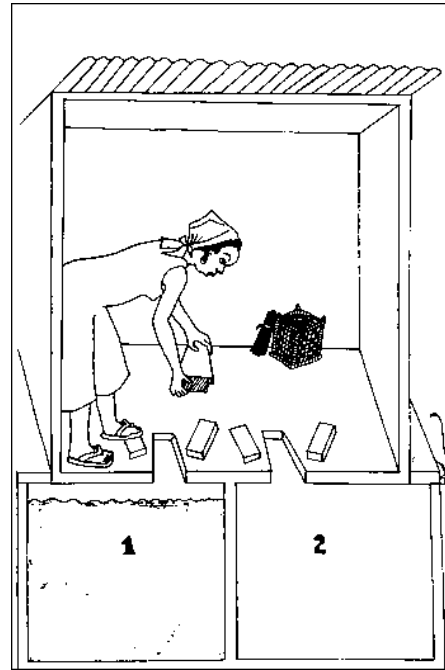

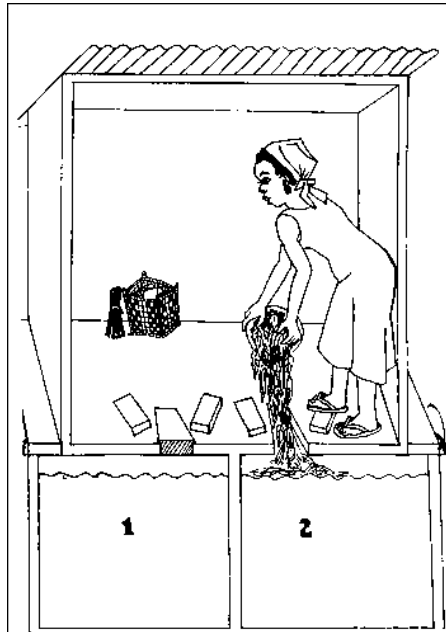
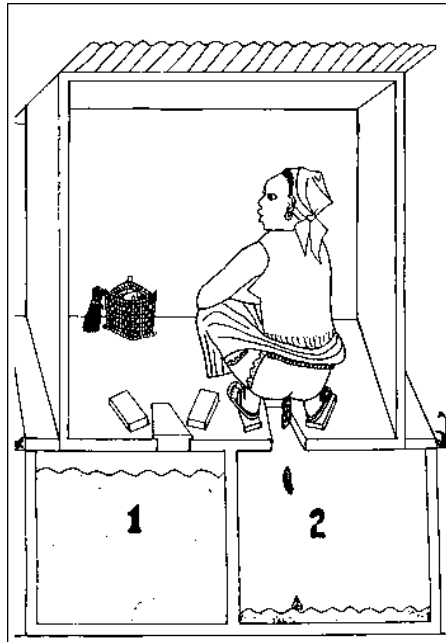

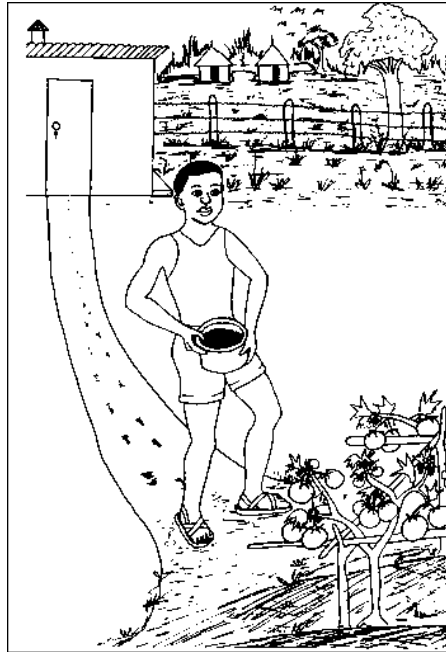
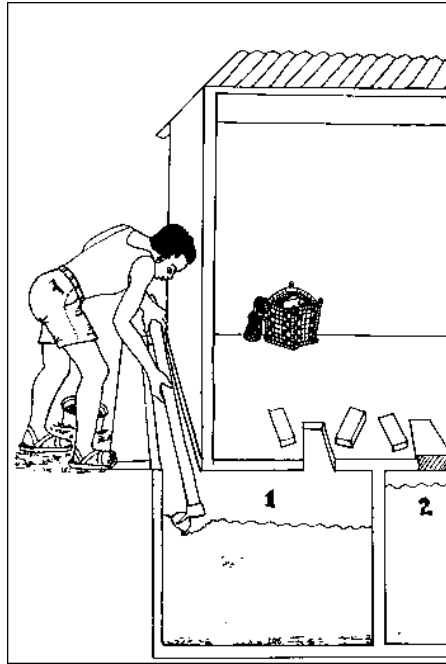

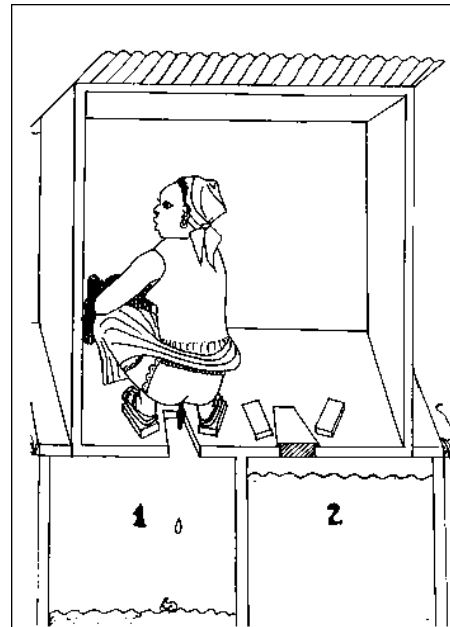

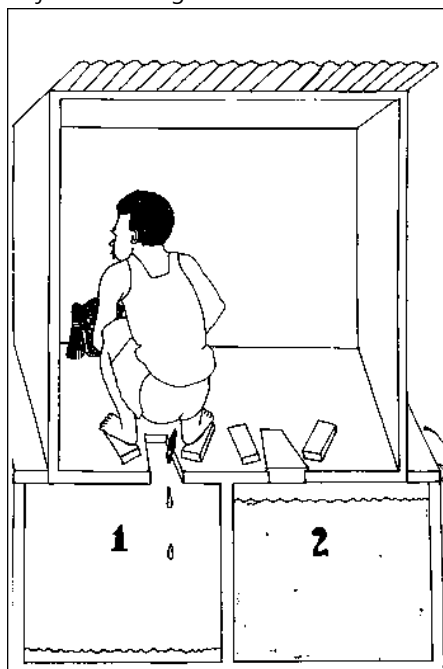

### 9.18. Latrine Follow-up

It is essential to follow up whether compost latrines are used correctly and, eventually, to advise and encourage the users.

#### A) Questions to the Users

The following questions need to be discussed with the owner/users.

No.	Question	Possible Suggestions
1	Do you have any problems with your compost latrine?	
2	How many people use the latrine?	
3	When did you start to use this pit?	
4	How full is it?	
5	Did you empty a pit already?	
6	Do you use sand and ashes?	It is preferable to use sand and ashes.
7	Do you regularly add grass, leaves, kitchen waste?	Adding these materials is necessary for better composting.
8	Is the container for ashes and sand filled	This is very necessary to encourage the users. Little children can be assigned for this task.

9	regularly? Do the users sprinkle sand and ashes?	Remind them if they forget.
10	Do you sweep the latrine daily?	This is very important for cleanliness
11	Do you use the broom somewhere else?	The broom shall not be used elsewhere because of transmission of diseases.
12	Are there many flies in the latrine?	Pour lot of sand and ashes. Keep the lid always closed.
13	Are there many flies in. your kitchen?	Keep your compound clean and dry. Bury or burn rubbish.
14	Are there many mosquitoes in your compound?	Your latrine pit must be dry. Your bathing place must be dry. Dig ditches for run-off of rain water. Fill up all water pools in the surrounding.
15	Is the run-off of the bathing place muddy and dirty	Dig a soak-away pit and fill it with stones or broken bricks.

### B) Inspection

The following points need to be inspected.

No.	Check	Possible Help
1	Are the latrine surroundings clean?	Clean the surroundings.
2	Is the latrine clean inside?	Clean the latrine inside.
3	Is the latrine slab clean or is there urine spilled ("maps")?	Scratch off any dried dirt. Sprinkle ashes and sweep it into the pit. Rub the slab with wet grass. Do not rinse.
4	Is there a basket with sand and/or ashes, a tin, paper, a broom inside? Is there a wooden lid and a concrete lid on the two holes?	Replace what is missing.
5	Are all the leaflets and posters, "How to use the latrine", on the wall?	Replace what is missing.
6	Look into the pit with a torch. Is there water in the pit? Is everything well covered with sand or ashes?	Fill earth, sand, ashes, grass, leaves into the pit until all water is sucked up.
7	How full is the pit?	If the pit is almost full, the contents can be pushed back with a stick for even filling. Remind the owner to call the project when he wants to change the receptacle.
8	Is there any bad smell?	Put a lot of ashes into the pit to stop it.
9	Are there many flies?	Advise the owner on the correct use (to place the lid, etc.) which will reduce the flies.
10	Are the concrete covers of the emptying holes well covered with earth and air tight?	Cover the concrete covers with earth.
11	Is any place around the latrine and especially the steps washed out?	Fill any washed out place with earth.
12	Does the mosquito wire on top of the ventpipe have holes?	Replace it by new mosquito wire.

Do not forget to fill in the form, "LATRINE FOLLOW-UP" after each check and put it in the file of the latrine. This is necessary to see any improvement/deterioration and to evaluate by comparing with other latrines and over a certain period of time.

Sudan Council of Churches \* Munuki Water and Sanitation Project

**LATRINE FOLLOW-UP**

Latrine No:.....
Owner:.....
Site:.....

Number of follow-up visit.....

Check done by..... Date:.....

How many people use the latrine?	.....
How full is the pit?	.....
Is there water in the pit?	yes/no
Is the lid on top of the squatting hole?	yes/no
Are sand and ashes available?	yes/no
Are sand and ashes sprinkled?	yes/no
Are grass/leaves/kitchen waste/...../..... added	yes/no
Are there flies?	yes/no
Are there mosquitoes?	yes/no
Is there a bad smell?	yes/no
Are the covers for emptying well covered?	yes/no
Is the mosquito wire on the ventpipe all right?	yes/no
Has the second compartment been started?	Date: ..... yes/no
Has the first compartment been emptied?	Date: ..... yes/no
Were the contents decomposed properly?	yes/no
Is the latrine clean? very dirty 0 1 2 3 4 5 very clean	

Remarks:

.....

.....

.....



### 9.19. Children's Squatting Slab

Children will learn after a certain age to imitate the adults when defaecating. However, because the squatting holes of the latrines are too big, they will not go there, but just squat anywhere, in or near the compound. Thereby, they will provide breeding places for flies and contribute to the transmission of diseases. This can be helped by taking the excrements of a child immediately and throwing them into the latrine. However, the children's squatting slab will provide an easier solution and can additionally help to introduce the child into using a latrine properly later on. It will also help to reduce the nuisance of smell and flies from the excreta of the children squatting just anywhere.

The children's squatting slab is a slab of 50 × 50 cm from concrete, reinforced with chicken wire with a small squatting hole in the middle. It has a wooden lid.

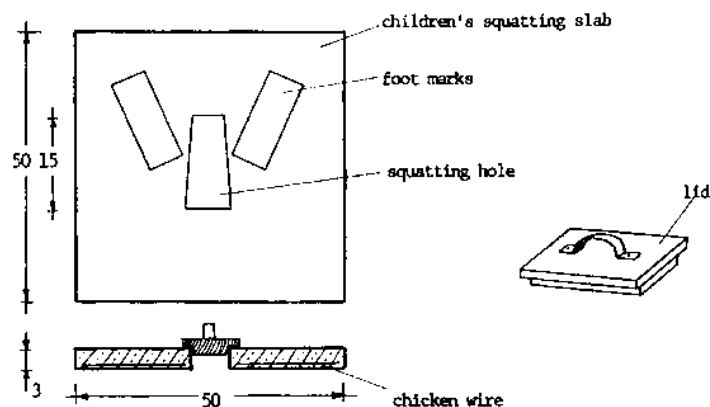

SCALE 1:10

It is to be used as follows:

1. Dig a pit a bit smaller than the slab so that the slab can rest on the edges of the hole. It should not be deeper than 50 cm and in a place which is not flooded by rains. Put the soil of the digging aside and partly around the edge of the pit, to raise it a bit above the normal ground
2. Place the slab and smear the edges with mud so that it is sitting firmly on the ground. Put the lid on the squatting hole.

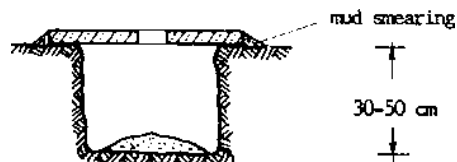

3. Teach the children to use the squatting hole properly, to put some sand or earth into the hole after defaecation and to replace the lid after finishing.



4. When the pit is full, take away the slab and put it on a new pit. Cover the old, full one with earth.

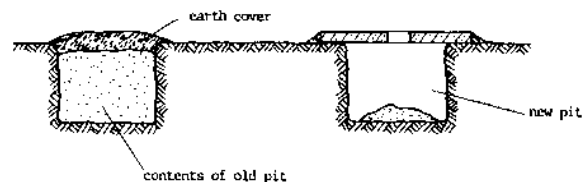

#### 9.20. Bath and Soak-Away Pit

A place for taking a bath is essential for personal cleanliness and hygiene. It can be within the house with running water from a tap or a separate building, where we get water from an elevated tank, or just a place with a fence using water from a bucket. However, in any case it is important to keep it clean in order not to make it a breeding place for germs and let it become a smelly nuisance, especially if it is also used for urinating.

Therefore, take care that

- there is never standing water in the bathing place, but that it can run off easily;
- the water is not just running outside and then forming a cess-pool stinking in front of your fence;
- you clean the bath regularly with enough water and soap. Normally, there is no need for disinfectants like Dettol, Finik, etc., if you keep the place clean and dry. Disinfectants should be used only if there are fungi infecting the feet. Then disinfect the bathing place - using boiling water is as effective as any disinfectant. Do not forget to treat the disease, otherwise it will just spread again.

A latrine with bath and soak-away pit:

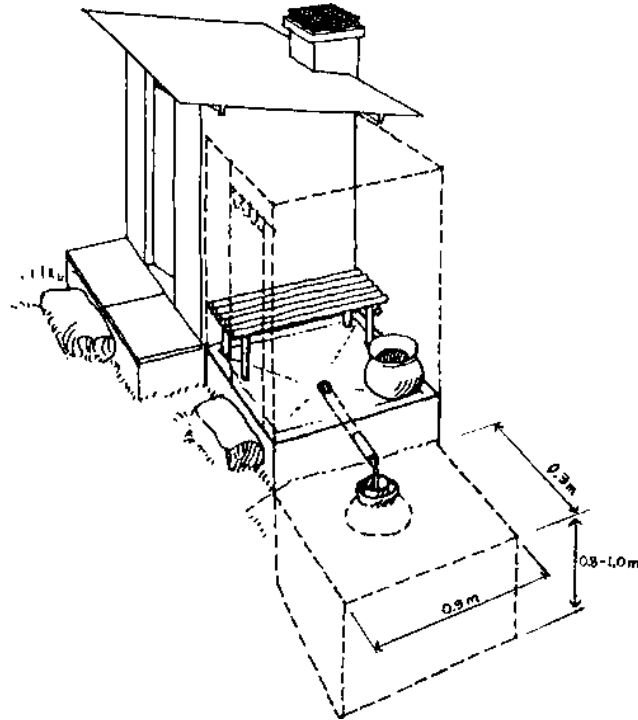

To prevent water from standing, care for proper drainage and a soak-away pit. A soak-away pit to last for many years and not be clogged by grease and silt and bacteria, must be built properly.

Cross-section through soak-away pit:

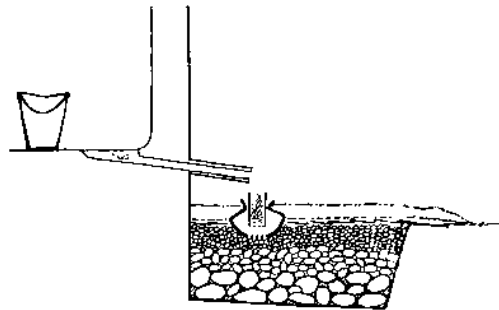

In order to build a proper soak-away pit, do as follows:

1. Choose the Proper Location

It should be at least 6 m distance from the house and 30 m from the nearest source of water supply. It should not be in an area where surface water will stand or flow over it sometimes. The soil should be neither pure sand nor pure clay.

**2. Dig a Pit**

The bottom of the pit should be at least 1 metre above the groundwater level in rainy season and 1 m above any impervious layers. The size should be about 1 m deep and 1 to 3 m diameter.

**3. Fill the Pit**

In the bottom third, big stones (about the size of a papaya), on top of that the next third, middle size stones (about as big as mangoes). The rest shall be filled with small stones or gravel; if available, you can put a layer of charcoal in between.

Soak-away pit with second layer of middle size stones:

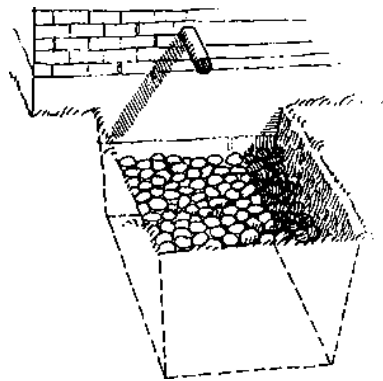
**4. Prepare and Put a Silt and Grease Trap**

Make holes into the bottom of a clay pot and a tin fitting into the mouth of the pot.

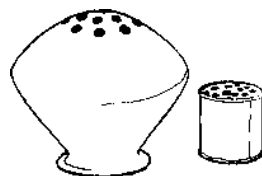

Fill the pot with grass or straw, but do not press it together. Put the tin into the mouth of the pot and fill it also with grass.

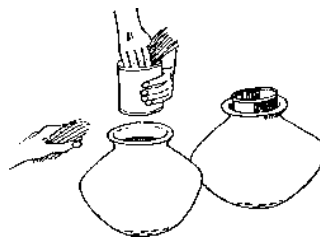

Put the pot with the tin into the layer of small stones under the outlet of the waste water.

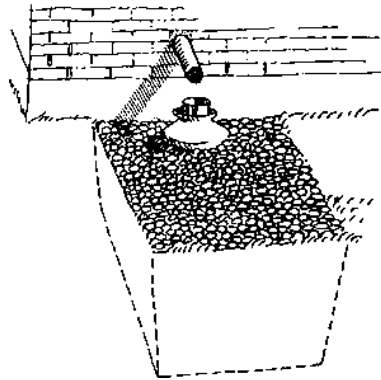

5. Cover the Pit with palm leaves and old sackcloths or mats, so that only the silt trap looks out. Cover the mats with 5 to 10 cm of earth.

For maintenance you have to change the grass in the pot every two weeks.

If the pit is not soaking anymore (after some years), take out everything, wash the stones, take away a layer of soil from the walls of the pit and let it dry out. Then start again at step No. 3 to re-do it.

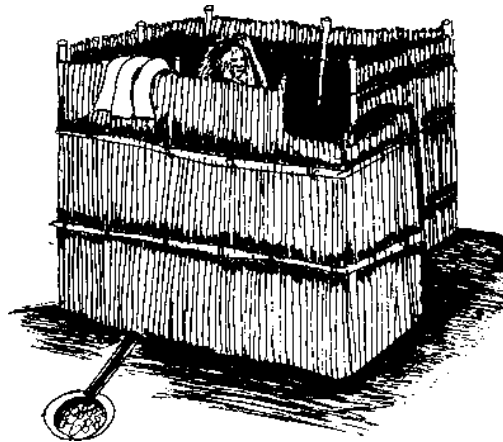

### 9.21. Handling Waste Matter in The Home

Beside excreta, there is other waste matter in the household which needs to be handled in a proper way to avoid diseases.

#### A) Principles

1. Minimize rubbish (e.g. by using a basket for shopping instead of buying new nylon bags each time).
2. Check to see if waste can be a resource by reusing/recycling it.
3. Whenever you are collecting, handling or disposing of waste, take care not to get injured (if you do, disinfect and clean immediately), and wash afterwards with soap and enough water.

## **B) What Can You Do with Waste Matter?**

In crowded areas only a collection system could ensure safe disposal. However, if that is not available and we cannot re-use the waste safely, we should try to get rid of it in a safe way, that is:

### **1. Rubbish**

Rubbish means all material which is not organic, like broken utensils, scraps of metal, glass, nylon bags, old batteries, rubber, etc.

If you collect rubbish in a waste-bin, do not mix it with garbage.

Always cover the bin not to allow rats, flies, etc. to live and breed in it.

Re-use it if it is possible in a safe way, e.g. use nylon bags several times after washing them, or re-use tins, but cut them open with a tin-opener to have a smooth edge and you will not cut yourself.

Bury it regularly in a suitable pit. The pit needs to be far enough from wells and streams to prevent water pollution. The bottom of the pit should be at least 1 m above the water table in rainy season.

The pit should also be far enough from houses to prevent nuisance by smell, flies, rats, etc.

Eventually burn the rubbish, but always cover it with soil.

### **2. Garbage and Other Organic Matter**

Garbage means organic matter like food and crop waste, sweepings, kitchen leftovers, etc. Additionally, there is organic matter like small branches and leaves, animal manure, dead animals and ashes. Do not mix it with rubbish, but collect it separately. Re-use if possible and safe, e.g. kitchen leftovers as animal food. Recycle by using it for composting, either by throwing it into your compost latrine, or on a compost heap. A compost heap you can make by digging a pit, 1 m deep, throwing the waste in and covering it with earth immediately to prevent flies, rats, etc. It is very good if you can mix garbage, animal manure and ashes. This will give a very good manure for the garden.

Ashes you can also re-use for cleaning, for your pit latrine or compost latrine, or for making combo.

In case of bigger dead animals you have to bury them deep enough and cover them properly with soil to prevent them from being dug out again by dogs or hyenas.

### **3. Paper**

Paper can be completely re-used if it is collected in a separate basket, either as scrap paper for drafts, for wrapping things, for the latrine or for lighting a fire.

### **4. Waste Water**

Waste water can be re-used for

- cleaning,
- watering trees or the garden (if it is not too soapy).

If it is not re-used, it should be disposed of in a soak-away pit (see 9.20).



## 9.22. Pesticides

### A) General Information

Pesticides are poisonous chemicals for killing "pests", that is insects, weeds, fungi, etc. They are designed for use in agriculture, disease control (mosquito control), timber protection, etc.

Pesticides are advertised as offering a promise of a better life, easier and more comfortable, higher production and higher profits.

### But

- they do not fulfill these promises, especially in the long run: Even if production increases, there is no guarantee that the poor will share the benefits. They will rather be the ones suffering most from the side effects.

Costs are increasing and a crisis develops between worsening control of the pests and spiralling prices, and efficiency decreases.

- they have serious side effects, especially, if used uncontrolled.

The background for the uncontrolled use of pesticides in Sudan and other Third World countries shows a new dimension of underdevelopment: beside the economical exploitation there is an ecological exploitation. Chemicals whose production, marketing and use are forbidden in industrialised countries, because of its well-known dangers for the health of people and the environment, are produced, marketed and used in Third World countries. E.g. West Germany exports yearly 140,000 metric tons of chemicals whose use in Germany is either severely restricted or forbidden at all.

Annually there are about 500,000 poisonings' in connection with pesticides according to WHO and a high rate of unreported cases.

Poisonings happen because of misuse or overuse by

- poor training in the proper use and improper handling and use;
- irresponsible marketing practices;
- spraying on calendar schedule.

There is also a very low awareness about the dangers among the public. Pesticides are seen as "medicine" (almost in a magic sense) and not as the poisons they actually are.

The legislation in Third World countries is often not sufficient and, where it exists, problems arise because of inadequate enforcement.

See also 8.7/4.

**B) Example DDT**

DDT is a very good example for all the things described above:

DDT is one of the "Dirty Dozen", that is extremely hazardous pesticides which are banned or severely restricted in industrialized countries as threats to public health and environment, e.g. in Germany it has been forbidden since 1972. In Sudan its use was officially banned in 1980 according to some literature, but just to be replaced by other chemicals of similar kind or to be used in spite of the ban.

The chemical name of DDT is DichloroDiphenylTrichlorethane (C<sub>14</sub>H<sub>9</sub>Cl<sub>5</sub>) Its use as an insecticide was detected in 1939.

It is so far prohibited in 15 countries because of its

- toxicity:

This is increased by DDT being persistent and accumulating in body fat at each level of the food chain, and it is also increased in case of a protein deficient diet.

- residual action on humans, the wildlife and environment:

It concentrates in mothers' milk and in the fat tissue of the body. In Sudan it was used in the Gezira since 1947. The result is that in the fat of a Sudanese a residue content of an average of 30.9 ppm is found compared to a world level of 6 ppm.

Because DDT is essentially non-biodegradable in the environment, it is meanwhile present in virtually all foods and living things. The half-life of DDT in soil is a minimum of 2.5 years, that means that after 2.5 years half the amount originally applied will still be there, after five years a quarter, and so on. Its break-down products, DDD and DDE, are also extremely long lived and extremely toxic for fish and birds.

- alteration of the ecological balance:

DDT is lethal to many predators and parasites of the target pests. It also contributes to the deterioration of the soil quality because of destruction of micro-organisms, earthworms and ground insects. The World Bank, therefore, suggests it not to be used in agriculture.

- development of resistance:

It was originally thought of as a weapon against malaria. Meanwhile, 51 out of the 60 malaria-bearing mosquito types are resistant, and altogether there are more than 300 DDT-resistant pests now.

- health risk:

It is thought to be carcinogenic (= causing cancer). It also causes nerve and brain damage, as well as liver and kidney damage and tremors. There is also a decrease in sperm count reported which may be due to impurities of DDT.

**C) Safety Precautions**

For the use of DDT and other pesticides, the following safety precautions are necessary:

- Wear protective clothes which cover the whole body including a hat and veil covering the whole head, and long gloves.
- Wear special working clothes which are to be removed at the end of each working day.



- Wash the clothes and the body using soap at the end of work with sufficient water, using separate containers for cleaning which shall not be used for anything else. Dispose of the water in a safe way.
- Wear rubber boots.
- Handle the pesticide with special implements and not with the hands or containers used for other purposes.
- Secure safe transport and storage and proper equipment for application including spare parts and repair facilities.

It is quite clear that all these do not happen in practice for different reasons. However, the question to be asked is whether the use of pesticides is necessary and reasonable at all, and, if necessary, when and where to use them, or whether there are safer alternatives.

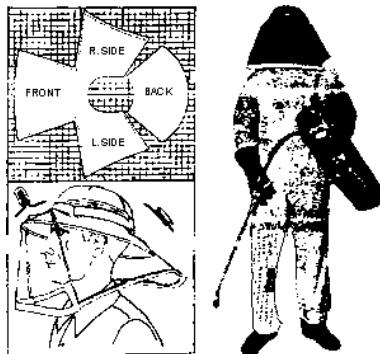

## 10. Appendix

### 10.1. List of Abbreviations

<b>A/...</b>	<b>Assistant...</b>
<b>Adm.</b>	<b>Administration</b>
<b>BH</b>	<b>Borehole</b>
<b>ca.</b>	<b>circa = about</b>
<b>CD</b>	<b>Community Development</b>
<b>CDO</b>	<b>Community Development Officer</b>
<b>CL</b>	<b>Compost Latrine</b>
<b>c/o</b>	<b>care of</b>
<b>e.g.</b>	<b>exempli gratia = for example</b>
<b>etc.</b>	<b>et cetera = and so on</b>
<b>...f</b>	<b>... and the following page</b>
<b>...ff</b>	<b>... and the following pages</b>

<b>GW</b>	<b>Groundwater</b>
<b>HP</b>	<b>Hand Pump</b>
<b>ID</b>	<b>Inside Diameter</b>
<b>i.e.</b>	<b>id est = that is</b>
<b>L</b>	<b>Latrine</b>
<b>Log</b>	<b>Logistics</b>
<b>£S...m/ms</b>	<b>Sudanese Pounds... milliemes</b>
<b>OD</b>	<b>Outside Diameter</b>
<b>pc</b>	<b>Piece</b>
<b>pcs</b>	<b>Pieces</b>
<b>PMT</b>	<b>Project Management Team</b>
<b>San</b>	<b>Sanitation</b>
<b>SCC</b>	<b>Sudan Council of Churches</b>
<b>W</b>	<b>Well</b>
<b>WC</b>	<b>Water Closet</b>
<b>WS</b>	<b>Water Supply</b>
<b>WT</b>	<b>Water Table</b>

**Abbreviations for Measurements** see 5.3

**Abbreviations in Mathematics** see 5.4 and 5.7

## 10.2 List of Forms

<b>Chart for Comparison of Candidates for Employment</b>	<b>2.17/4</b>
<b>Community Meeting - Minutes</b>	<b>2.5/10</b>
<b>Cost Calculation for Operating a Vehicle</b>	<b>3.4/2</b>
<b>Cost Estimation/Calculation for Construction Work</b>	<b>7.3/2; 7.4/7ff; 7.11/5</b>
<b>Dispatch Book - Incoming</b>	<b>2.13/3</b>
<b>Dispatch Book - Outgoing</b>	<b>2.13/2</b>
<b>Finance Book</b>	<b>2.10/1</b>
<b>Hand Augering Evaluation</b>	<b>8.13/12</b>
<b>Hand Augering Log</b>	<b>8.13/8f</b>
<b>Incoming/Outgoing Radio Message</b>	<b>2.15/2</b>

<b>Incoming/Outgoing Radio Message - Money Transfer</b>	<b>2.15/3</b>
<b>Latrine Construction - Time Table..</b>	<b>2.5/4</b>
<b>Latrine Follow-Up</b>	<b>9.18/4</b>
<b>Logbook Evaluation</b>	<b>3.3/1</b>
<b>Maintenance Logbook</b>	<b>3.2/2</b>
<b>Memo</b>	<b>2.14/1</b>
<b>Offer for Construction of a Compost Latrine</b>	<b>2.5/8f</b>
<b>Offer for Construction of a well</b>	<b>2.5/6f</b>
<b>Personnel Records</b>	<b>2.17/6</b>
<b>Pretest Form for Visual Aids</b>	<b>4.27/13</b>
<b>Procedure for Compost Latrine Construction</b>	<b>4.15/4</b>
<b>Procedure for Well Construction on Community Basis</b>	<b>4.15/5</b>
<b>Procedure for Well Construction on Contract Basis</b>	<b>4.15/6</b>
<b>Profile for Candidates for Employment</b>	<b>2.17/4</b>
<b>Purchasing List</b>	<b>7.6/1f</b>
<b>Questionnaire Use of Latrines</b>	<b>9.16/12ff</b>
<b>Questionnaire Use of Hand Pumps in Munuki Area</b>	<b>4.23/9</b>
<b>Reference Letter</b>	<b>2.17/3</b>
<b>Soil Profile</b>	<b>8.13/9</b>
<b>Stock-Card</b>	<b>7.9/3</b>
<b>Stock-Taking List</b>	<b>7.12/1</b>
<b>Summary of Cost Calculation for Community Work</b>	<b>7.4/11</b>
<b>Summary of Cost Calculation for Contract Work</b>	<b>7.5/2</b>
<b>Tools on Site</b>	<b>7.11/4</b>
<b>Transport Logbook</b>	<b>3.2/3</b>
<b>Waybill</b>	<b>3.13/2</b>
<b>Well Construction Time Table</b>	<b>2.5/5</b>
<b>Work Contract</b>	<b>2.17/7ff</b>
<b>Work Plan</b>	<b>7.1/4; 2.4/5</b>
<b>Work Records</b>	<b>2.5/3</b>

Work Records, Compost Latrine No. 7.2/4

Work Records, Well No. 7.2/3; 7.4/5f

### 10.3 List of Leaflets and Posters

Advertisement for the Compost Latrine	9.12/5
How to Change Receptacles and Empty a Compost Latrine	9.17/21-32
How to Empty Your Compost Latrine (English)	9.16/7
How to Empty Your Compost Latrine (Juba Arabic)	9.16/8
How to Empty Your Compost Latrine (Arabic)	9.16/9
How to Improve Your Pit Latrine (English)	9.10/4
How to Improve Your Pit Latrine (Juba Arabic)	9.10/5
How to Improve Your Pit Latrine (Arabic)	9.10/6
How to Take Care of a Well	8.39/3-7
How to Use and Care for a Compost Latrine	9.17/2-20
How to Use Your Compost Latrine (English)	9.16/2
How to Use Your Compost Latrine (Juba Arabic)	9.16/3
How to Use Your Compost Latrine (Arabic)	9.16/4

### 10.4. List of Illustrations (from literature)

*References to illustrations page numbers and authors given in the table below reflect the printed version. In order to have the exact correspondence please consult the PDF version of this file.*

All illustrations not mentioned in the following list as well as the adaptations were made by Márta Guóth-Gumberger.

Section	Illustration Page No.	Taken from/Made by
1	1.3/2; 1.6/6; 1.7/1	Ben Hakim
2	2.4/4; 2.7/2; 2.8/2; 2.12/1	Ben Hakim
	2.18/1-4; 2.18/6	bibliography No. 12; 27
3	3.1/2; 3.3/2; 3.6/1; 3.7/1; 3.8/1; 3.9/3	Ben Hakim
4	4.8/1-3; 4.19/3	Ben Hakim
	4.4/2; 4.8/5; 4.12/1f; 4.14/3-6; 4.18/4f	Mike Gogonya
	4.1/4	The Guardian Weekly

	4.6/1	The International Women's Tribune
	4.6/3 (below)	Sueddeutsche Zeitung
	4.6/3 (top); 4.8 (adapted); 4.12 (adapted); 4.14 (adapted); 4.16/2; 4.18 (adapted); 4.23/3 (below); 4.27 (partly adapted)	bibliography No. 20; 37; 48
6	6.4/8; 6.6/14	Ben Hakim
	6.3 (partly adapted)	catalogue 1986, Luna AB Sweden, and catalogue 1983, Mittermeyer, W-Germany
	6.1/20	manual diaphragm pump, Van Reekum Materials, Netherlands
	6.1/21	manual Hatz Generator, West Germany
	6.1/22 (bottom); 6.6/2 (adapted); 6.6/6; 6.7 (adapted)	bibliography No. 6a; 8; 44
7	7.2/2; 7.3/1; 7.6/3; 7.8/3; 7.12/3	Ben Hakim
8	8.7/5; 8.9/2; 8.37/7 (left); 8.39/3-7	Ben Hakim
	8.24/24 (adapted)	leaflet, Mono Pump
	8.24/29	leaflet, Homa Pump
	8.24/30	leaflet, Jet pump
	8.24/7-30 (partly adapted); 8.30 (adapted); 8.35 (adapted); 8.37/4,6	bibliography No. 18; 21; 22; 44; 46
	9.9/2; 9.19/2; 9.20/5; 9.21/2	Ben Hakim
	9.6/1,2(bottom), 3-10; 9.17/2-32	Mike Gogonya
	9.1/2; 9.2/2; 9.2/3; 9.6/2 (top),4 (bottom)	Stephen Hakim
9	9.3/1; 9.3/2; 9.3/5f; 9.5/2f (adapted); 9.6(adapted); 9.12/2; 9.12/3 (adapted); 9.12/4 (top, adapted); 9.20/1-4; 9.11/2; 9.22/3	bibliography No. 6; 23; 34; 48; 49
0 to 9	drawings title pages	Ben Hakim

## 10.5. Bibliography

Literature used and recommended for further studies:

1. A Growing Problem, by David Bull; OXFAM, 274 Banbury Road, Oxford OX 2 7 DZ, England
2. A Manual And Resource Book For Popular Participation Training, 4 Vol., UN-Publications ST/ESA/66 Vol. I-IV; UN Publications, 1211 Geneva, Switzerland
3. A Manual For Group Facilitators, by The Centre for Conflict Resolution; The Centre for Conflict Resolution, 731 State Street, Madison, Wisconsin 53703, USA
4. African Churches And People's Development, ccpd-document No. 4; WCC, P.O. Box 66, 1211 Geneva 20, Switzerland
5. Appropriate Building Materials, by Roland Stulz; SKAT, Varnbuelstr. 14, 9000 St. Gallen, Switzerland

**6. Biology, by Soper/Smith; MacMillan Publishers**

**6a. Brickwork For Apprentices, by J.C. Hodge; Edward Arnold**

**7. Bridging The Gap, by Save The Children; Save the Children, 54 Wilton Road, Westport, Conn. 06880, USA**

**8. Building Science And Materials, by John Elliot; MacMillan Publishers**

**9. Communicable Diseases, by Eshuis/Manschot; AMREF, P.O. Box 30125, Nairobi, Kenya**

**10. Communication, by C.S. Deverell; Gee & Co. Publishers**

**11. Communication Skills For Rural Development, by McDonald/Hearle; Evans Brothers Limited**

**12. Communications Guide for Extension Workers, by RSCTU/UNICEF; UNICEF, Eastern Africa Regional Office, P.O. Box 44145, Nairobi, Kenya**

**13. Community Development Workers Training Series, 7 volumes, by UNICEF; address see 12.**

**14. Development/Seeds of Change, diverse issues; SID, Palazzo della Civiltà del Lavoro, Roma 00144, Italy**

**15. Guidelines For Development, by CCIA; Christian Conference of Asia, 480 Lorong 2, Toa Payoh, Singapore 1231**

**16. Handbook For Development Workers Overseas, by Glynn Roberts; Returned Volunteer Action, 1 Amwell Street, London EC 1 R 1 UL, England**

**17. Hand Dug Wells And Their Construction, by Watts/Wood; ITDG Publications, 9 King Street, London WC 2 E 8 HN, England**

**18. Handpumps, by Eugene Mc Junkin; IRC, P.O. Box 5500, 2280 HM Rijswijk, Netherlands**

**19. Handpump Maintenance In The Context Of Community Well Projects, by Arnold Pacey; ITDG Publications, address see 17**

**20. Helping Health Workers Learn, by David Werner/Bill Bower; The Hesperian Foundation, P.O. Box 1692, Palo Alto, CA 94302, USA**

**21. How To Protect A Water Source And Why?, by Rogers/Kokole; OXFAM/UNHCR, South Sudan Water Team, Juba**

**22. India Mark II Handpump Installation Manual; Richardson & Cruddas, 23 Rajaji Salai, Madras 600001, India**

**23. Insecticides, by The Ross Institute; The Ross Institute, Keppel Street, London WC 1 E 7 HT, England**

**24. Learning From The Rural Poor, by Volken/Kumar/Kathathara; Indian Social Institute, Lodi Road, New Delhi 11003, India**

**25. Making The Links, Guidelines For Hygiene Education In Community Water Supply And Sanitation, by IRC; IRC, address see 18.**

**26. Maths For Living, by W.D. Wright; James Nisbet**

**27. Navamaga, Training Activities For Group Building, Health And Income Generation; Overseas Education Fund, 2101 L Street NW, Suite 916, Washington DC 20037, USA**

**28. Notes For Draughtsmen, by Neil Orton; Mac Donald**

**29. Ordinary Level Mathematics, by F.G.J. Norton; Heinemann**

30. **Organisational Techniques; Overseas Education Fund, address see 27.**
31. **People In Development, by John Staley; SEARCH, 256 First Block, Jayanagar, Bangalore 560011, India**
32. **People's Technologies and People's Participation, by Pascal de Pury; WCC, address see 4.**
33. **Sanitation And Disease, by Feachem/Bradley/Carelick/Mara; John Wiley**
34. **Sanitation Without Water, by Uno Wimblad/Wen Kilama; Mac Millan Publishers**
35. **Shallow Wells, by DHV; DHV Consulting Engineers, P.O. Box 85, Amersfoort, Netherlands**
36. **Small Excreta Disposal Systems, by Feachem/Cairncross; The Ross Institute, address see 23.**
37. **Teaching And Learning With Visual Aids; Educational Materials Unit, Program for International Training in Health, School of Medicine, University of North Carolina, Chapel Hill, North Carolina, USA**
38. **Technical Health Training Manual, 2 volumes; Peace Corps, Information Collection and Exchange, 806 Connecticut Avenue NW, Washington DC 20525, USA**
39. **The Expanded Programme On Immunization, Health Education Trainers' Manual For Extension Workers In Sudan; UNICEF, Juba, Sudan**
40. **The Programmer's Tool Kit; Overseas Education Fund, address see 27.**
41. **The Role And Training Of Development Activists, by Khamla Basin; FFHS/AD, FAO, 55 Max Mueller Marg, New Delhi 110003, India**
42. **Visual Aids; Peace Corps, address see 38.**
43. **WASH Technical Reports; WASH, 1611 N Kent Street, Room 1002, Arlington, VA 22209, USA**
44. **Water For The World Series; US-AID, Development Information Centre, Washington DC 20523, USA**
45. **Water Sources And Their Protection, by Rogers/Kokole; OXFAM/UNHCR, Southern Sudan Water Team, Juba**
46. **Waterlines, diverse issues; ITDG Publications, address see 17.**
47. **Well Construction, by Richard E. Brush; Peace Corps, address see 38.**
48. **Where There Is No Doctor, by David Werner; TALC, P.O. Box 49, St. Albans, Herts., AL 1 4 AX, England**
49. **World Bank Technical Papers And Technical Notes Series, Water Supply And Sanitation; The World Bank, 1818 H Street NW, Washington DC 20433, USA**

[Please provide your feedback](#)

[English](#) | [French](#) | [Spanish](#) | [German](#)