

## **Soil Block Presses (GTZ, 1988, 38 p.)**

 **(introduction...)**

 **Acknowledgements**

 **Technology**

 **Equipment**

 **Criteria for selection and purchase**

 **Checklist for potential buyers**

 **Press - bloc 80 tm mobile production unit**

 **Kit 15/30 megabrik**

 **CLU 3000 soil brick plant**

 **Multibloc BREPAK block press**

 **TEK- Block Press**

 **Vs CINVA ram**

 **Terstaram hand operated press**

 **Semi-terstamatique motor operated press**













 **DSH hydraulic press**

 **Ceraman manual press**

 **Ceramatic automatic brick press**

 **Pact 500 mechanical press**

 **Dynaterre 01. 4 m mobile production unit**

-  **Ellson blockmaster**
-  **Astram soil block machine**
-  **Tara balram**
-  **IIT Madras cam block press**
-  **CINVA- ram**
-  **CETA- Ram**
-  **CTA triple - block press**
-  **CRATerre America Latina press**
-  **UNATA 1003 and 1004**
-  **MARO DC Press**
-  **Go 50**
-  **DSM**
-  **Bibliography**

## **MARO DC Press**

### **Manual Block Presses Produced in Europe 2**

#### **Manufacturer**

**M. Klein - MARO Enterprise**

**95 bis Route de Suisse**

**CH-1290 Versoix (Geneva)**

**Switzerland**

**Tel. (022) 55 4146 (office)**

**(021) 38 42 21 (works)**

**Tlx. 427 130**

## **Description**

**The MARO DC Press is a modified CINVARam, which was developed by Mark Klein in 1985, and has gone through a series of improvements since. However, the main concept and principal features have remained the same, and are as follows:**

- All parts are machined and assembled with bolts and screws. This facilitates repairs and replacing of broken parts, and avoids possible distortions that can be caused by arc welding.**
- The machine has a self-supporting base and can do without counterweights or a heavy base board for stability. It is also designed for one man operation.**
- The entire mechanism is mounted on 6 sealed, greased-for-life ball bearings, by which the effort lost through friction is negligible; no greasing, oiling or maintenance is required; no sand or soil can collect between the moving parts, thus eliminating wear and the need for replacement of parts.**
- By means of a double compression system, by which the blocks are pressed by the bottom plate and finally by the mould cover, very homogeneous and durable blocks are produced.**

**Optional items are a feeding tray, which greatly accelerates the process of filling the mould, and adjustable con-rods, which reduce the mould depth for making tiles. A variety of frogs and inserts can be provided for the production of specially shaped blocks and tiles.**

## Operating the MARO DC Press

**With the lever arm in the vertical position, the mould cover is held by two hands and moved sideways to open the mould, which can be quickly filled with the help of the feeding tray. In the same way as for opening, the cover and lever are moved back to close the mould.**

**The lever is pulled down straight away, and after compacting the block, returned to the vertical position, in which the mould can be opened again.**

**By pulling down the lever again, on the same side as for compaction, the block is ejected. Since the lever remains in this position on its own, the operator can release it and remove the block from the mould. Thus it is possible for the machine to be operated by only one worker.**

## MARO Modular Construction Systems

**For special application in developing countries, eg in remote areas, or in reconstruction projects after disasters, MARO Enterprise has developed simple frame construction systems, using light steel or even bamboo elements to erect the roof-supporting frame, with infill walls of specially formed compressed soil blocks (made from local soils) giving the building stability and durability.**

## Technical Details

Size of machine (length x width x height)		50 x 27 x 90 cm (20 x11 x36 in)
Weight of machine		105 kg









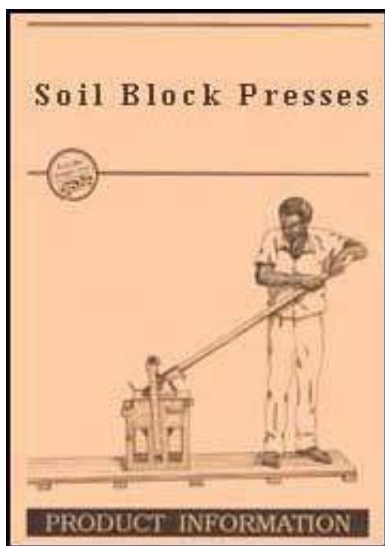











Size of crate for shipment		54 x34 x 94 cm (21 x 14 x37 in)
Weight of packed machine		115 kg
Standard block size (single mould)	a	30 x 15 x 10 cm (11.8 x 5.9 x 4 in)
	b	30 x 15 x 5cm(11.8x5.9x2in)
Maximum nominal compaction force		11.5 tonnes
Nominal compaction pressure		2.5 N/mm <sup>2</sup> (360 p.s.i.)
Compression ratio		1.63:1
Energy input/transmission		manual/mechanical
No. of blocks per cycle/output rate	a. & b.	1 / 150 blocks per hour
Labour force required (incl. excavation and mixing)		3 men















Price (ex works)	MARO DC Press	1500 SF	(approx. 980 US\$)
valid June 1988	Feeding tray	100 SF	(approx. 65 US\$)
SF = Swiss Francs	Adjustable con-rods for tile production	100 SF	(approx. 65 US\$)
	(Discounts of up to 40 % are given for large orders)		



[Home](#) > [ar](#).[cn](#).[de](#).[en](#).[es](#).[fr](#).[id](#).[it](#).[ph](#).[po](#).[ru](#).[sw](#)



-  **Soil Block Presses (GTZ, 1988, 38 p.)**
-  **(introduction...)**
-  **Acknowledgements**
-   **Technology**
-  **Equipment**
-  **Criteria for selection and purchase**
-  **Checklist for potential buyers**
-  **Press - bloc 80 tm mobile production unit**
-  **Kit 15/30 megabrik**
-  **CLU 3000 soil brick plant**
-  **Multibloc BREPAK block press**
-  **TEK- Block Press**
-  **Vs CINVA ram**
-  **Terstaram hand operated press**
-  **Semi-terstamatique motor operated press**
-  **DSH hydraulic press**
-  **Ceraman manual press**
-  **Ceramatic automatic brick press**
-  **Pact 500 mechanical press**

-  **Dynaterre 01, 4 m mobile production unit**
-  **Elson blockmaster**
-  **Astram soil block machine**
-  **Tara balram**
-  **IIT Madras cam block press**
-  **CINVA- ram**
-  **CETA- Ram**
-  **CTA triple - block press**
-  **CRATerre America Latina press**
-  **UNATA 1003 and 1004**
-  **MARO DC Press**
-  **Go 50**
-  **DSM**
-  **Bibliography**

## **Technology**

### **Building with Earth**

**The advantages of building with earth are:**

- availability in large quantities in most regions,**
- hence low cost for excavation and transportation or no cost, if found on the building site,**

- **easy workability, usually without special equipment,**
- **suitability both as wall and roof construction material,**
- **fire resistance,**
- **favourable climatic performance in most regions, due to the high thermal conductivity and porosity, thus subduing extreme outdoor temperatures and maintaining a satisfactory moisture balance,**
- **low energy input in processing and handling unstabilized soil, requiring only 1 % of the energy needed to manufacture and process the same quantity of cement concrete (soil-cement requires up to 75 %),**
- **unlimited reuseability of unstabilized soil (in recycling of demolished buildings),**
- **environmental appropriateness (use of an unlimited resource in its natural state, no pollution, negligible energy consumption, no wastage).**

**In spite of these advantages, earth constructions have not found the wide acceptance they deserve, largely due to the poor durability of various traditional and wrongly constructed buildings. The main reasons are:**

- **excessive water absorption, causing**
- **cracks and deterioration by frequent wetting and drying (swelling and shrinkage)**
- **weakening and disintegration by rain and floods,**
- **low resistance to abrasion and impact, thus rapid deterioration through climatic elements and human usage, and penetration by rodents and insects,**



- **low tensile strength, making earth constructions susceptible to destruction during earthquakes.**

**On account of these limitations, soil constructions still lack institutional acceptability in most countries, which is why building codes and performance standards often do not exist.**

**Contrary to common belief, building with earth is not a simple technology. The mere fact that natives of many countries have been building their houses with earth since thousands of years does not mean that the technology is sufficiently developed and known to everyone. It is indeed the lack of expertise that brings about poor constructions, which in turn gives the material its ill reputation. On the other hand, it must be remembered that some cultures give longevity least importance, eg in the case of nomadic tribes or those who abandon the house when the owner dies.**

## **Procedures**

**As stated above, the technology of soil construction is a complex one, requiring a deeper knowledge of the material, its limitations, methods of handling and proper design. The number of possible solutions is enormous, so that the problem is mainly one of making the best choice. In the following, the main procedural steps for a satisfactory soil construction are listed with brief comments. These operations are well documented in a number of publications (see Select Bibliography) and the reader is advised to refer to them for details.**

## **Soil Selection**

- **The variety of naturally occurring soils is immense and not all soils are suitable for all building purposes.**
- **They can differ in chemical composition and grain size distribution, factors which determine their performance.**
- **Soil selection is not only a matter of experience, simple field tests and subsequent laboratory tests are vital.**

## **Soil Testing**

- **The list of tests is long and not all are needed for each soil type and use.**
- **The main field tests are by sight, smell, touch, by making balls, ribbons and threads, by sedimentation in a glass jar and by dropping.**
- **Laboratory apparatus is needed for particle size analysis by sieving, for determining shrinkage, plasticity, dry strength, compressibility, optimum moisture content and cohesion.**

## **Soil Preparation**

- **Depending on the type of construction (eg rammed earth, adobe, compressed blocks) the soil mixture must satisfy certain requirements.**
- **These may call for: addition of sand or clay, crushing, sieving, dry and wet mixing, all these with regular checks to achieve uniform qualities. An optimum soil mix can compensate for a number of other deficiencies.**

## **Soil Stabilization**

- **To improve the qualities of the soil mixture, a large variety of stabilizers can be added. The main ones are:**
- **Fibres (such as straw, agricultural wastes, animal and synthetic fibres) to improve the tensile strength.**
- **Cement, to improve the compressive and tensile strength, dimensional stability, erosion resistance.**
- **Lime, dependent on the clay content of the soil, to achieve a similar improvement as with cement.**
- **Bitumen, mainly to reduce water absorption.**
- **Natural and synthetic resins, for increased load-bearing capacity, elasticity and impermeability.**
- **Animal (cow dung, blood, hair, casein) and vegetable products (oils and fats, ashes, sap).**
- **Commercial products, mainly for impermeability.**

## **Soil Compaction**

- **All soil constructions require some form of compaction, either by throwing, vibrating, ramming or mechanical compression. The method and degree of**

**compaction are directly related to the ultimate strength of the structure.**

**· This Product Information Portfolio deals with mechanical compression, which can achieve the highest level of compaction, usually in the form of blocks for masonry structures. The devices required for this purpose are described in "Equipment".**

## **Drying and Curing**

**· All soil constructions have to dry for several days to gain strength, the time needed depending mainly on the weather conditions. Hence, controlled drying and protection from rain are essential.**

**· When cement or lime is used for stabilization, the material must be kept moist for the first 4-5 days (for curing).**

**· Depending on the degree of compaction, compressed soil blocks can be stacked (up to 5 layers) immediately or on the next day. Some block producers claim using the blocks in the building operations, without any drying beforehand. This technique is not widely accepted, as problems of durability are believed to arise.**

## **Design and Construction**

**· For space limitations, the innumerable criteria for design and construction cannot be mentioned here. But an old saying puts these criteria in a nutshell: "All cob (soil) wants is a good hat and a good pair of shoes" that is, the base and the roof of a building are of greatest importance.**

· **A well designed building with well compacted earth walls can do without external rendering, though in humid climates some surface protection is usually recommended. Good quality compressed soil-cement blocks generally need no surface protection, thus saving costs, time and energy. If a render is applied, the choice is very wide, and some experience is needed to select the most appropriate one.**



[Home](#) > [ar](#).[cn](#).[de](#).[en](#).[es](#).[fr](#).[id](#).[it](#).[ph](#).[po](#).[ru](#).[sw](#)

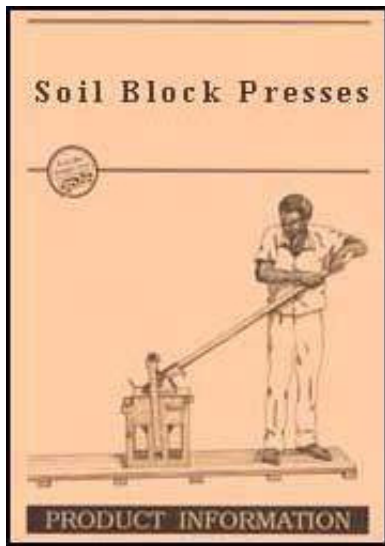

## **Soil Block Presses (GTZ, 1988, 38 p.)**

 **(introduction...)**

 **Acknowledgements**

 **Technology**

 **Equipment**

 **Criteria for selection and purchase**

 **Checklist for potential buyers**

 **Press - bloc 80 tm mobile production unit**

 **Kit 15/30 megabrik**





















 **CLU 3000 soil brick plant**

 **Multibloc BREPAK block press**

 **TEK- Block Press**

 **Vs CINVA ram**

 **Terstaram hand operated press**

-  **Semi-terstomatique motor operated press**
-  **DSH hydraulic press**
-  **Ceraman manual press**
-  **Ceramatic automatic brick press**
-  **Pact 500 mechanical press**
-  **Dynaterre 01. 4 m mobile production unit**
-  **Ellson blockmaster**
-  **Astram soil block machine**
-  **Tara balram**
-  **IIT Madras cam block press**
-  **CINVA- ram**
-  **CETA- Ram**
-  **CTA triple - block press**
-  **CRATerre America Latina press**
-  **UNATA 1003 and 1004**
-  **MARO DC Press**
-   **Go 50**
-  **DSM**
-  **Bibliography**

**Go 50**

**Manual Block Presses Produced in Europe 3**

**Manufacturer****ALTECH - Societe Alpine  
de Technologies Nouvelles****Rue des Cordeliers****F-05200 Embrun****France****Tel. 92 43 21 90****Tlx. 420219****Description**

**The Geo 50 is produced in collaboration with Ste SOUEN, Centre de Terre, Lavalette, F-31590 Verfeil, where Joseph Colzani, ARCHECO, developed the machine in 1984.**

**The portable block press is designed to produce soil blocks with the lever action only on one side. The downward movement of the lever pushes the vertical stroke piston upwards and simultaneously pulls the mould cover downward by means of a cam, thus achieving double compaction and consequently higher density blocks.**

**It is advantageous to mount the machine on a strong wooden base board or two strong beams to provide rigid support.**

**Operating the Geo 50**

**Generally, two people are sufficient to operate the machine, and three or four people are required for excavation, transportation and preparation of the soil.**

**The mould is conveniently filled from the side opposite the lever arm. The cover, which is hooked to the lever arm, is pushed to vertical position and unhooked, allowing the lever arm to be pulled back to horizontal position, by which the block is fully compacted. Back to vertical position, the lever arm is hooked to the cover, which is pulled back, ejecting the compressed block, which is removed for drying.**

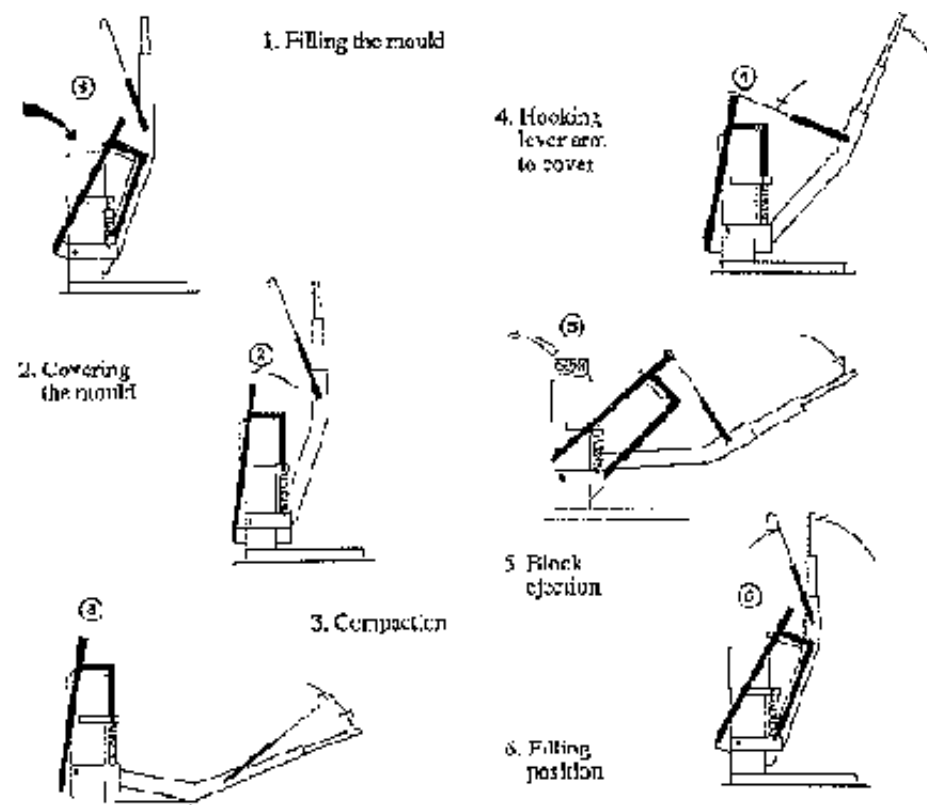

**FIGURE**

## Technical Details

Size of machine (length x width x height)	40 x 35 x 100 cm ( 16 x 14 x 40 in)
With lever arm extension: total length	250 cm (99 in)



Weight of machine (including lever arm)	125 kg
Size of crate for shipment	50 x 45 x 110 cm (20 x 18 x 44 in)
Weight of packed machine	160 kg
Standard block size (single mould)	29.5 x 14 x 9 cm (11.6 x 5.5 x 3.5 in)
Maximum nominal compaction force	8 tonnes
Nominal compaction pressure	2 N/mm <sup>2</sup> (290 p.s.i.)
Compression ratio	1.75: 1
Energy input/transmission	manual/mechanical
No. of blocks per cycle/output rate	1 / 90-110 blocks per hour
Labour force required (incl. excavation and mixing)	5 - 7 men

Price (ex works)	Geo 50	6100 FF	(approx. 1050 US\$)
valid June 1988	Packing		on request
FF= French Francs			

[Home](#) > [ar](#).[cn](#).[de](#).[en](#).[es](#).[fr](#).[id](#).[it](#).[ph](#).[po](#).[ru](#).[sw](#)

## **Soil Block Presses (GTZ, 1988, 38 p.)**





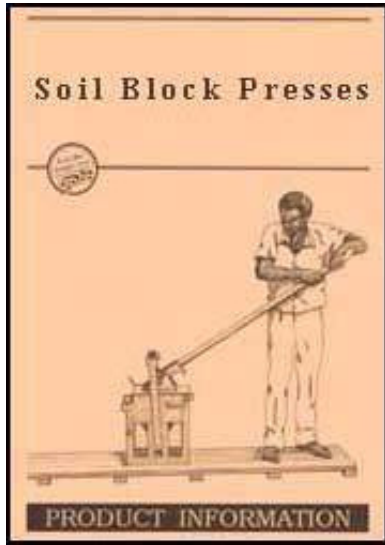

 **(introduction...)**

 **Acknowledgements**

 **Technology**



- 📄 **Equipment**
- 📄 **Criteria for selection and purchase**
- 📄 **Checklist for potential buyers**
- 📄 **Press - bloc 80 tm mobile production unit**
- 📄 **Kit 15/30 megabrik**
- 📄 **CLU 3000 soil brick plant**
- 📄 **Multibloc BREPAK block press**
- 📄 **TEK- Block Press**
- 📄 **Vs CINVA ram**
- 📄 **Terstaram hand operated press**
- 📄 **Semi-terstamatique motor operated press**
- 📄 **DSH hydraulic press**
- 📄 **Ceraman manual press**
- 📄 **Ceramatic automatic brick press**
- 📄 **Pact 500 mechanical press**
- 📄 **Dynaterre 01. 4 m mobile production unit**
- 📄 **Ellson blockmaster**
- 📄 **Astram soil block machine**
- 📄 **Tara balram**
- 📄 **IIT Madras cam block press**
- 📄 **CINVA- ram**
  
- 📄 **CETA- Ram**

-  **CTA triple - block press**
-  **CRATerre America Latina press**
-  **UNATA 1003 and 1004**
-  **MARO DC Press**
-  **Go 50**
-  **DSM**
-  **Bibliography**

## **DSM**

### **Manual Block Presses Produced in Europe 4**

#### **Manufacturer**

**La Mecanique Regionale**

**23, rue de la Gare**

**F-51140 Muizon**

**France**

**Tel. 26 02 95 75**

**Tlx. 306 022 Imr f**

#### **Description**

**The DSM was developed by De Silvestri, and the patent acquired by C.T.B.I. (Construction Terre Bois International), Muizon, a French firm that used to specialise in earth and wood construction. Based on the CINVA-Ram, the machine is a robust, portable, single-mould press, with a cover that slides sideways and a lever arm, which is operated only on one side of the machine.**

**A relatively high degree of compaction is achieved by double compression acting simultaneously from the base plate and the cover. A steel angle base frame extension is provided and can be loaded with heavy stones or mounted on a heavy timber base board, to keep the machine in a stable position.**

**All rigid connections are welded and screw connections are provided for those parts that need to be dismantled for transportation.**

### **Operating the DSM**

**The machine is operated by two people, with one worker occupied with filling the moulds and removing the ejected bricks and the other person handling the lever arm and cleaning the mould from time to time.**

**With the lever in vertical position, the cover plate is slid aside to open the mould, which is filled by means of a shovel or bucket. The cover is closed again and the lever pulled down for compression. Again in vertical position, the cover is slid aside and the lever arm pressed downwards to eject the brick.**

### **Technical Details**

Size of machine (length x width x height)	115 x 28 x 102 cm (46 x 11 x 41 in)
With lever arm extension: total height	225 cm (89 in)
Weight of machine (including lever arm)	85 kg
Size of crate for shipment	55 x 35 x 95 cm (22 x 14 x 38 in)
Weight of packed machine	110 kg

Standard block size (single mould)	29 x 14.5 x 10.5 cm (11.4 x 5.7 x 4.1 in)
Maximum nominal compaction force	12 tonnes
Nominal compaction pressure	2.8 N/mrn <sup>2</sup> (405 p.s.i.)
Compression ratio	1.57: 1
Energy input/transmission	manual/mechanical
No. of blocks per cycle/output rate	1/90 - 110 blocks per hour
Labour force required (incl. excavation and mixing)	5 - 7 men

Price (ex works)	DSM	5000 FF	(approx. 860 US\$)
valid June 1988	Packing	300 FF	(approx. 52 US\$)
FF= French Francs			

[Home](#) > [ar](#).[cn](#).[de](#).[en](#).[es](#).[fr](#).[id](#).[it](#).[ph](#).[po](#).[ru](#).[sw](#)

## **Soil Block Presses (GTZ, 1988, 38 p.)**





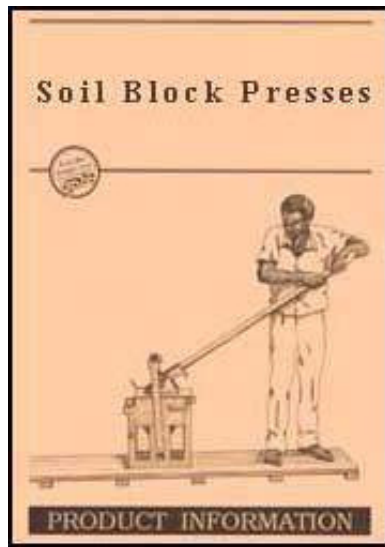

 ***(introduction...)***

 **Acknowledgements**

 **Technology**



- 📄 **Equipment**
- 📄 **Criteria for selection and purchase**
- 📄 **Checklist for potential buyers**
- 📄 **Press - bloc 80 tm mobile production unit**
- 📄 **Kit 15/30 megabrik**
- 📄 **CLU 3000 soil brick plant**
- 📄 **Multibloc BREPAK block press**
- 📄 **TEK- Block Press**
- 📄 **Vs CINVA ram**
- 📄 **Terstaram hand operated press**
- 📄 **Semi-terstamatique motor operated press**
- 📄 **DSH hydraulic press**
- 📄 **Ceraman manual press**
- 📄 **Ceramatic automatic brick press**
- 📄 **Pact 500 mechanical press**
- 📄 **Dynaterre 01. 4 m mobile production unit**
- 📄 **Ellson blockmaster**
- 📄 **Astram soil block machine**
- 📄 **Tara balram**
- 📄 **IIT Madras cam block press**
- 📄 **CINVA- ram**
  
- 📄 **CETA- Ram**

-  **CTA triple - block press**
-  **CRATerre America Latina press**
-  **UNATA 1003 and 1004**
-  **MARO DC Press**
-  **Go 50**
-  **DSM**
-  **Bibliography**

## **Bibliography**

**(E) = English; (G) = German; (F) = French; (S) = Spanish**

**01 Agarwal, Anil: Mud, Mud - The potential of earth-based materials for Third World Housing, Earthscan/International Institute for Environment and Development, London, 1981 (E)**

**02 Bardou, P.; Arzoumanian, V.: Archi de Terre, Paranthèses, Marseille, 1978 (F)**

**03 CRATerre (Centre de recherche et d'application - Terre: P. Doat; A. Hays; H. Houben; S. Matuk; F. Vitoux): Construire en terre, éditions alternatives, Paris, 1985 (F)**

**04 CRATerre (H. Houben, P.E. Verney); ENTPE (M. Olivier, A. Mesbah, Ph. Michel): Raw Earth Construction: The French Equipment, CRATerre, Grenoble, 1987 (E)**

**05 CRATerre; GAITerre: Marrakech 83 Habitat en Terre, Rexcoop - Plan Construction, Paris, 1983 (F)**

**06 CRATerre (slain Hays, et al): Tecnicas mixtas de construccion con sierra, Rexcoop -Plan Construction, Paris, 1986 (S)**

**07 Dethier, Jean: Down to Earth: Mud Architecture - an old idea, a new future, Thames and Hudson, London, 1982 (E)**

**08 Department of Housing and Urban Development: Earth for Homes, HUD, Washington,D.C., 1955 (E)**

**09 Fathy, Hassan: Architecture for the Poor - An Experiment in Rural Egypt, The University of Chicago Press, Chicago, 1973 (E)**

**10 Ferm, Richard: Stabilized Earth Construction - An Instructional Manual, The International Foundation for Earth Construction, Washington, D.C., October 1985 (E)**

**11 Grasser, Klaus; Mukerji, Kiran: Minimum Cost Housing Construction in El Salvador,Project Report of the Institut fur Tropenbau, Dr.-Ing. G. Lippsmeier, Starnberg, in cooperation with FSDVM and CIG, San Salvador, Aus der Arbeit von GATE, Eschborn, 1981 (E, G, S)**

**12 Hammond, A.A.: Prolonging the Life of Earth Buildings in the Tropics, Building Research and Practice (May/June 1973) Building and Road Research Institute, UST Kumasi, 1973 (E)**

**13 Houben, Hugo; Guillaud, Hubert: Earth Construction Technology, (4 Volumes: a. Manual on Basic Principles of Earth Application; b. Manual on Design and Construction Techniques; c. Manual on Production of Rammed Earth, Adobe and**



**Compressed Soil Blocks; d. Manual on Surface Protection), UNCHS, (Habitat), Nairobi, 1986 (E)**

**14 Jagadish, K.S.; Venkatarama Reddy, B.V.: A Manual of Soil Block Construction, Alternative Building Series - 1, Centre for Application of Science and Technology for Rural Areas, (ASTRA), Indian Institute of Science, Bangalore, January 1981 (E)**

**15 Lunt, M.G.: Stabilized Soil Blocks for Building, Overseas Building Note No. 184, Building Research Establishment, Garston, February 1980 (E)**

**16 McHenry jr., P.G.: Adobe and Rammed Earth Buildings, Design and Construction, John Wiley & Sons, New York, 1984 (E)**

**17 Minke, Cernot (Ed.): Bauen mit Lehm, Journal on Building with Soil, Reports on new developments, research studies and building projects, Okobuch-Verlag, Grebenstein/Freiburg, 1984/1987 (G) 18 Mukerji, K.; Bahlmann H.: Laterite for Building, I.F.T. Report 5, Institut fur Tropenbau, Dr.-Ing. G. Lippsmeier, Starnberg, 1978 (E, G)**

**19 Mukerji, K.: Soil Block Presses, Report on a global survey, Aus der Arbeit von GATE, Eschborn, 1986 (E)**

**20 Norton, John: Building with Earth, A Handbook, IT Publications, London, 1986 (E)**

**21 Odul, Pascal: Case Studies on Earth Construction: Synthesis, PGC-HS, Katholieke Universiteit Leuven, 1984 (E)**

**22 Schneider, Jurgén: Am Anfang die Erde-Sanfter Baustoff Lehm, Das Buch zur ZDF-Sendung im Februar 1985, Edition Fricke, Verlagsgesellschaft Rudolf Muller, Koln, 1985 (G)**

**23 Schreckenbach, Hannah; Abankwa, Jackson G.K.: Construction Technology for a Tropical Developing Country, Deutsche Gesellschaft für Technische Zusammenarbeit (GTZ) GmbH, Eschborn, 1983 (E)**

**24 Smith, R.G.; Webb, D.J.T.: The Manufacture of Stabilized Soil Bricks, International Labour Office, Geneva, 1987 (E) 25 Spence, R.J.S.; Cook, D.J.: Building Materials in Developing Countries, John Wiley & Sons, Chicester, 1983 (E)**

**26 Stulz, Roland; Mukerji, Kiran: Appropriate Building Materials, A Catalogue of Potential Solutions, SKAT (Swiss Center for Appropriate Technology), St. Gall, and Intermediate Technology Publications Ltd., London, GATE, Eschborn, 1988 (E)**

**27 Wolfskill, L.A.; Dunlap, W.A.; Gallaway, B.M.: Earthen Home Construction, A field and library compilation with an annotated bibliography, Texas Transportation Institute, College Station, 1962 (E)**



[Home](#) > [ar](#).[cn](#).[de](#).[en](#).[es](#).[fr](#).[id](#).[it](#).[ph](#).[po](#).[ru](#).[sw](#)





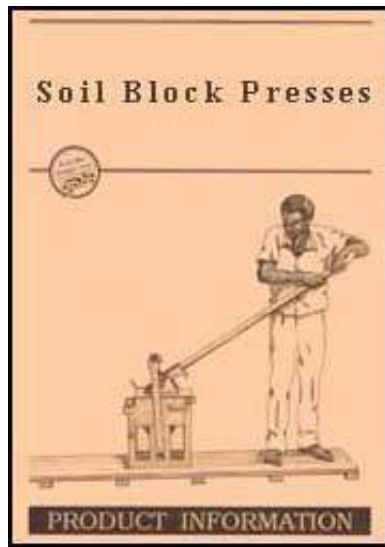

 **Soil Block Presses (GTZ, 1988, 38 p.)**

 ***(introduction...)***

 **Acknowledgements**



- Technology
- ➔ Equipment
- Criteria for selection and purchase
- Checklist for potential buyers
- Press - bloc 80 tm mobile production unit
- Kit 15/30 megabrik
- CLU 3000 soil brick plant
- Multibloc BREPAK block press
- TEK- Block Press
- Vs CINVA ram
- Terstaram hand operated press
- Semi-terstamatique motor operated press
- DSH hydraulic press
- Ceraman manual press
- Ceramatic automatic brick press
- Pact 500 mechanical press
- Dynaterre 01. 4 m mobile production unit
- Ellson blockmaster
- Astram soil block machine
- Tara balram
- IIT Madras cam block press
- CINVA- ram
- CETA- Ram

-  **CTA triple - block press**
-  **CRATerre America Latina press**
-  **UNATA 1003 and 1004**
-  **MARO DC Press**
-  **Go 50**
-  **DSM**
-  **Bibliography**

## **Equipment**

### **Development of Soil Block Presses**

**Since the quality and durability of soil constructions was generally compared with that of burnt brick masonry and more recently with concrete block structures, the compressive strengths achieved by manual compaction (by throwing or ramming) were not always satisfactory. In order to achieve higher compaction, mechanical devices were developed, both in the form of tampers, as well as in the form of block presses (first made out of wood, later out of iron or steel). The first documented block press was developed in France in 1789.**

**The earlier presses functioned mainly as ramming devices for dynamic compaction, eg with heavy covers (30 kg) which close down with great force, displacing the excess soil. Since the beginning of the 20th century press makers have been devising manual and motorized presses that make use of static force. One of the earliest machines, LA MADELON, is still being manufactured in Belgium, although with several modifications and under different names. But most of the**

**older machines have disappeared from the market.**

**All these machines were relatively large, heavy and expensive, so that their use was limited. What was needed, was a small, light, simple and cheap block press, which could be used on the remotest building sites in the Third World.**

**According to these requirements, the Chilean engineer, Raul Ramirez, developed such a machine in 1956. He was then working with CINVA, the Inter-American Housing Center in Bogota, Colombia. The press was, therefore, called CINVA-Ram, whereby "Ram" was derived either from Ramirez, or from the English word for a compacting device.**

**The CINVA-Ram is now by far the best-known and most widely used block press. Numerous variations of it have been manufactured in many countries, but, in its original form, it still is the lightest and least expensive block press available - every improvement, in terms of handling, output and sturdiness, invariably means an increase in price.**

**In the 1950s and 60s, interest in soil constructions was generally low. In the 1970s, research work and implementation of soil technologies in development projects steadily increased, largely on account of the world-wide energy crisis. Apart from several other publications, Hassan Fathy's "Architecture for the Poor", which was published in 1973, did a great deal to revive interest in soil construction systems.**

**In the course of these developments, a new generation of soil block presses came into existence in the 1970s, namely complete production units on wheels. The**

**equipment generally required for blockmaking, apart from the press, are a sieve, a mixer and a measuring scoop for charging the mould, although quite often these are substituted by manual operations and estimation of appropriate soil mix proportions and required quantity of mould filling. The new, partially or fully automatic machines accomplished all these tasks in quickly repeating operation cycles, thus achieving higher outputs of uniform, superior quality bricks.**



**FIGURE**

## **Soil Block Presses Today**

**There are basically four types:**

**Manual presses:** the moulding and turning out operations are carried out by the machine which is operated manually.

**Motorized presses:** the moulding and turning out operations are carried out by the machine which is power driven.

**Mobile production units:** the production unit is easily transportable and the moulding and turning out operations, the preparation of the raw material and/or

**the evacuation of the finished product are entirely automated.**

**Industrial production units: these production units are particularly difficult to transport but the entire process is automated. These units are not included in the Product Information.**

**Corresponding to the great diversity of these machines, the prices range between 500 and 75.000 US\$. The following "extremely generalized) compilation of the respective advantages and problems clearly shows that each system caters for a certain range of needs and thus has a valid place to fill. Grossly simplified, the cheaper devices are taken to be manually operated, while the expensive machines are referred to as motor-driven and automated.**

**Advantages of manually operated presses:**

- Low capital and operational costs.**
- Quick delivery.**
- Low weight (devices like the CINVA-Ram can, if necessary, be taken along as unaccompanied flight luggage; easy to transport on wheelbarrows or bullock-carts).**
- Small size, thus little storage space required.**
- Simple to use, even for unskilled workers.**
- Apart from cleaning the mould and lubrication of moving parts, low maintenance**

## **requirements.**

- **Possibility of repairs in local workshops, no special spare parts required, except for compression rings special hard steel (45 - 50 Rockwell).**
- **No additional costs of energy.**
- **No time loss due to failure of energy supply.**

## **Problems of manually operated presses:**

- **Low rate of production per machine (on average between 40 and 150 blocks per hour), thus requiring a number of machines to achieve a reasonable output.**
- **Low compaction pressure (averaging 0.5 to 2.5 N/mm<sup>2</sup>), hence poor soils are likely to produce weaker blocks (in lower compressive strength, higher moisture absorption, susceptibility to disintegration).**
- **Tendency to produce irregular block sizes or compaction, depending on compressing system, if filling the mould is done manually.**
- **Tiring operation; thus, in the course of a series production, tendency of gradual drop in quality and uniformity of blocks produced, if the pressure is continuously exerted by the same person.**

## **Advantages of automatic, motor-driven presses:**

- **High rate of production (on average between 200 and 1500 blocks per hour).**



- **High compaction pressure (between 4 and 24 N/mm<sup>2</sup>), hence good quality of soil blocks (optimum dimensional uniformity, stability of edges and high compressive strength, low moisture absorption, saving of costly and tedious surface treatment).**
- **Continuously uniform quality of blocks, since no muscle power is applied.**
- **Requirement of only small proportions of binder (thus saving costs), on account of the high compaction pressure.**
- **Reduction of manual work, thus saving costs, where wages are high.**

#### **Problems of automatic, motor-driven presses:**

- **High capital and operational costs.**
- **Relatively long delivery time.**
- **Usually very heavy, requiring powerful lifting gear and vehicles for transportation, ie transports are troublesome and expensive.**
- **Large size, requiring large working area, making safe storage under lock and key difficult.**
- **Requirement of high insurance cover.**
- **Necessity of skilled labour for operation of machines.**
- **Maintenance requirements (eg some hydraulic machines) comparable or more**

**complex than for motor vehicles.**

- **Requirement of specialists for repairs; spare parts possibly expensive and difficult to get, or only after long delivery time.**
- **Dependency on local energy supply.**

## **Summary**

**The above list of advantages and disadvantages of the different categories of soil block presses lead to the following conclusions:**

**Small, manually operated machines are best suited:**

- **in case of limited capital resources;**
- **for projects in remote areas, or those that lack the necessary infrastructure;**
- **on small building sites, with limited working space;**
- **in areas of low precipitation, thus excluding the danger of excessive water absorption;**
- **for small building projects with single-storeyed structures, for which the quality of soil blocks is of less importance;**
- **in places, where the potential for self-help inputs is high;**
- **or where entrepreneurs, with a small capital base and a team of unskilled**

**workers, produce soil blocks for the local market.**

**Powered, high capacity machines are advantageous:**







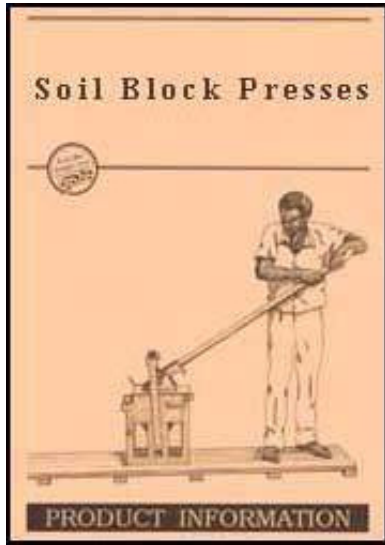



- **where sufficient financial resources are available;**
- **in cases where high production rates are needed and there is a high demand over a long period;**
- **for projects that specify better qualities of soil blocks;**
- **in working environments with sufficient energy supply, as well as maintenance and repair facilities;**
- **in cases, where labour is expensive or not easily available;**
- **or in case of disaster aid operations, which necessitate efficient and quick help, and good, cheap material in large quantities. (Quite often, tents and other temporary accommodations are provided at high costs, requiring more permanent substitutes later on. It is wiser to help disaster victims to build stable, permanent houses straight away. Thus it could be a far better bargain, to invest the money, which usually is spent on provisional measures, in the procurement of a high capacity soil block press.)**



**[Home](#) > [ar](#).[cn](#).[de](#).[en](#).[es](#).[fr](#).[id](#).[it](#).[ph](#).[po](#).[ru](#).[sw](#)**



- 📖 **Soil Block Presses (GTZ, 1988, 38 p.)**
- 📄 **(introduction...)**
- 📄 **Acknowledgements**
- 📄 **Technology**
- 📄 **Equipment**
- ➔ 📄 **Criteria for selection and purchase**
- 📄 **Checklist for potential buyers**
- 📄 **Press - bloc 80 tm mobile production unit**
- 📄 **Kit 15/30 megabrik**
- 📄 **CLU 3000 soil brick plant**
- 📄 **Multibloc BREPAK block press**
- 📄 **TEK- Block Press**
- 📄 **Vs CINVA ram**
- 📄 **Terstaram hand operated press**
- 📄 **Semi-terstamatique motor operated press**
- 📄 **DSH hydraulic press**
- 📄 **Ceraman manual press**
- 📄 **Ceramatic automatic brick press**
- 📄 **Pact 500 mechanical press**
- 📄 **Dynaterre 01. 4 m mobile production unit**
- 📄 **Ellson blockmaster**
- 📄 **Astram soil block machine**
- 📄 **Tara balram**

-  **IIT Madras cam block press**
-  **CINVA- ram**
-  **CETA- Ram**
-  **CTA triple - block press**
-  **CRATerre America Latina press**
-  **UNATA 1003 and 1004**
-  **MARO DC Press**
-  **Go 50**
-  **DSM**
-  **Bibliography**

## **Criteria for selection and purchase**

### **General Considerations**

**In view of the vast choice of machines available, it seems difficult to decide which one should be bought. If there is not enough money to buy expensive equipment, the choice is smaller and the decision much easier. But generally, the following points need to be considered, especially when the available resources allow for the purchase of higher priced equipment.**

### **Design of Press**

- Compressing blocks is only part of the operation, hence apart from the press, additional equipment (eg crushing machine, sieve, mixer, measuring scoop) is needed. In the case of machines which incorporate all these functions in a single**

**unit, consideration should not only be given to the costs, but also to the required storage and working space, ease of transport, production efficiency and quality, output rate and the like.**

- However, sophisticated mechanical and electronic control devices often necessitate special training and experience for maintenance and repairs. Spare parts are usually expensive and difficult to procure (import).**
- The filling of moulds both manually and automatically is commonly by volume (less frequency, though more accurately by mass). In rotating or drawer moulds, which only pass once under a fixed trooper, the quantity of fill on each side is likely to differ, thus producing non-homogeneous blocks.**
- Moulds have to withstand high pressures over long periods, hence preference must be given to thick, reinforced mould walls for durability and resistance to deformation. Speed and ease of changing moulds also need consideration, which can be a drawback, the more moulds a rotating table has.**
- Compression and ejection can be in vertical and/or horizontal direction. Ideally the blocks should be laid in masonry such that the structural forces follow the same direction as the compression force during production. Also the exposed side of the block should preferably be smooth for greater durability.**

## **Energy sources**

- Smaller presses are invariably manually operated (muscle power), while larger units are usually motorized (electric motor, diesel, or petrol engine). Manual presses depend on the weight, strength, stamina and motivation of the operator,**

**while mechanized presses overcome the problems of human fatigue and non-uniform products.**

- **Energy transmission to the block can be via a lever, toggle, cam, pivot, ball and socket joint, piston, etc. But principally there are two systems of energy transmission: mechanical and hydraulic.**
- **Mechanical systems are usually simple but relatively heavy, unless special alloys are used, in which case repairs may be difficult.**
- **Hydraulic systems are susceptible to dust, sand and heat, under harsh conditions the hydraulic fluid must be changed once a month, so that maintenance can be difficult and costly. The systems are usually designed for operating temperatures around 70° C, but under tropical conditions temperatures can reach 120° C, requiring cooling mechanisms and/or special spare parts and oils to withstand the heat. Flexible tubing, joints, etc. that need frequent replacement should best be standardized.**

### **Compression of Blocks**

- **There is a difference between the real pressure acting on the brick and the theoretical pressure, which neglects losses due to friction and inertia. The difference can be about 50 % of the theoretical value. The required standards generally specify the real pressure at the end of the cycle, hence manufacturers should be asked to explain their measurement procedures in order to check their validity.**
- **The compression ratio, which is the difference between the depth of the mould**

**(with uncompacted earth) to the height of the compressed block, should not be less than 1.65, preferably around 2, which is rarely achieved by mechanical compaction. Hence, pre-compression (eg by forceful closing of fold-back lid) can be advantageous. Machines in which the compression ratio can be adjusted according to the soil type, can be especially useful.**

**· The speed of the compression process is of significance for the rate of production, but it must be noted that compression cycles below 2 seconds for 10 cm thick blocks run the risk of lamination. If the compression process is too rapid, the cycle should be interrupted after pre-compression to allow the compressed air to escape, after which the cycle is completed at a slower pace.**

## **Material Quality**

**· The quality of the block improves proportionately with the increase of moulding pressure. However, this is true only up to a critical point, which lies between 4 and 10 N/mm<sup>2</sup> (depending on the soil type), after which lamination can occur, especially when applied too rapidly.**

**· Double-sided compaction from above and below produces more homogeneous and durable blocks, than one-sided compression.**

**· Even though the compressive strength of blocks, in most cases, need not be high - the quality of the CINVA-Ram type blocks is structurally quite adequate - it is important to note that insufficiently compacted blocks are porous and easily absorb moisture, the coarse surface is difficult to keep clean and can be abraded easily, while cracks and cavities are likely to harbour vermin. Such surfaces**



**usually need some protective coating, which naturally incurs additional costs. Denser blocks, which have been compacted with pressures upwards of about 3 to 4 N/mm<sup>2</sup> can remain untreated, offer no refuge to insects, and can do with only small quantities of binder (in cement or lime).**

**· Alternatively, in case of low compaction pressures, a chemical additive (eg asphalt-based) can provide the necessary moisture resistance. However, such additives do not increase the compressive strength of the block, and it should also be remembered that these substances invariably have to be imported, thus making the production of blocks more expensive and dependent on supplies.**

## **Block Dimensions**

- Small sizes require a greater number of blocks per cubic metre than larger ones, so the overall effort needed to produce small blocks is greater than that of making larger ones. Furthermore, masonry constructions with small bricks require more mortar, since the proportion of joints is higher. Therefore, the best block format is determined by the maximum weight and size that can be easily handled by a single person using only one hand. The most common dimensions are 29.5 x 14 x 9 cm (l x b x h).**
- When pressure is applied only on one side, the height of the block is limited to 10 cm, above which the opposite side remains weakly compacted.**
- It is useful to be able to produce hollow blocks of all kinds, partially or totally hollowed out from one side to the other. The total volume hollowed is generally limited to about 30 % for the most efficient processes. Frogs (removeable mould**

**inserts) up to 5 % are usual.**

- **Certain presses can produce a complete range of products (large and small blocks, paving and roofing tiles, etc.) which is a distinct advantage, but which has its price.**

## **Productivity**

- **Under theoretical conditions, given a 15 second cycle, for example, 2000 production cycles can be run in an eight hour working day. If one increases the complexity of the compression action (double compression, compression in two steps, dynamic compaction) the cycle is longer, in this event, the constructors provide for the production of several blocks per cycle.**
- **The machine's output is often indicated according to the theoretical production cycle. The real productivity in the field is different and depends upon a number of factors that are totally independent of the machine's theoretical capacity, eg breakdown time, manpower organization, maintenance, etc. Real productivity lies quite often around or under 50 % of the theoretical production cycle.**
- **The theoretical production cycles of the most efficient manual presses lie between 30 and 60 seconds.**
- **As concerns the motorized presses calling for human intervention, it is difficult to run a complete cycle in less than 15 seconds - filling, compression (1 to 2 seconds) and turning out included.**
- **Automatic production units can, in the best of cases, complete this same cycle in**

## **4 or 5 seconds.**

### **Manual Work**

- **The normal work force comprises about 5 people excavating, sieving and mixing the soil, as well as curing and stacking the previous day's production, and at least 3 people to fill the mould, operate the press and remove the block to the curing area.**
- **Considering that a manually operated press requires the person, who pulls or pushes down the lever, to exert a great force, up to about twice every minute, it becomes clear that gradual exhaustion causes diminishing performance and lower quality blocks. In view of this, every means of facilitating manual operations should be given priority, if the financial resources permit. If a motor-driven machine is chosen, it would be advantageous to also be able to operate it manually, in case of short supply of energy, or failure of the motor.**
- **Special attention should be given to safety measures, such as avoidance of projecting moving parts, designing manual operations such that hands cannot get jammed between moving parts, clearly marking and/or protecting dangerous points, incorporating thermal fuses, security pins, etc. Automatic machines must at all cost be equipped with an emergency stop switch, which is easily accessible.**

### **Manufacturer**

- **The advantages of large machine producing companies are generally:**
  - **a strong capital base,**
  - **large, efficient working team with modern equipment,**

- **high sales figures and good (international) references,**
- **good administrative backing,**

**but the machines are likely to be more expensive than those of smaller firms.**

- **In small machine producing firms, the manager is usually part of the workshop team. The advantages are generally:**

- **high motivation,**
- **low overhead and production costs, thus lower price of machine,**
- **frequent modification and improvement of machine.**

**Small firms or their machines are often not so well-known, because of small advertising budgets, hence their list of references can be small in spite of a good product.**

- **Personal visits to the manufacturer and/or sites at which the machine is in use should be undertaken as far as possible. The value of reference lists is to be able to meet or correspond with users, to learn about their experiences. If reference lists do not contain addresses, these should be specifically asked for.**

- **Of special advantage are training courses, offered by some manufacturers. To be effective, they should not only include the production of blocks, and handling and maintenance of the machine, but also the testing and use of problem soils, as well as design guidelines for building construction. Trainees should also learn to dismantle and assemble the machines, to understand their function and conduct repairs by themselves.**

## **Purchase of Machine**

- **The "FOB" price (free on board) includes packaging, transportation and insurance costs of the machine within the retailer's country. This price can be artificially inflated in order to compensate for the reduction offered on the factory price.**
- **As regards sales or rental conditions, one must be suspicious of contracts providing for price indexing based on the number of blocks produced or for payment of royalties for patent use, which is often not justified. A patent is not necessarily a proof of guaranteed quality and constructors frequently apply for patents for processes that are already of the public domain.**
- **It is advisable to include a penalty clause in the contract, to safeguard against late delivery.**
- **In the case of an after sales service contract, the waiting period for repairs and maintenance must be clearly indicated. A detailed handbook should be provided, including specifications of all spare parts and a maintenance plan, indicating operations necessary and expected maintenance frequency.**



[Home](#) > [ar](#).[cn](#).[de](#).[en](#).[es](#).[fr](#).[id](#).[it](#).[ph](#).[po](#).[ru](#).[sw](#)

 **Soil Block Presses (GTZ, 1988, 38 p.)**





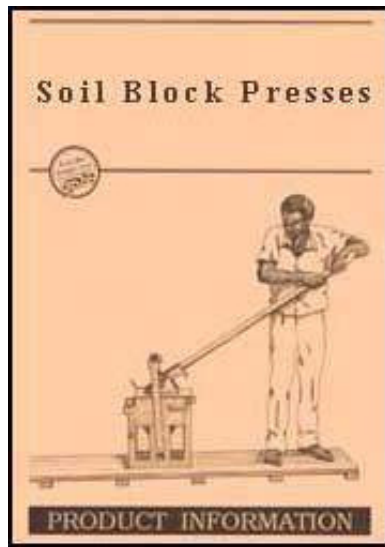

 **(*introduction...*)**

 **Acknowledgements**

 **Technology**



- 📄 **Equipment**
- 📄 **Criteria for selection and purchase**
- ➔ 📄 **Checklist for potential buyers**
- 📄 **Press - bloc 80 tm mobile production unit**
- 📄 **Kit 15/30 megabrik**
- 📄 **CLU 3000 soil brick plant**
- 📄 **Multibloc BREPAK block press**
- 📄 **TEK- Block Press**
- 📄 **Vs CINVA ram**
- 📄 **Terstaram hand operated press**
- 📄 **Semi-terstamatique motor operated press**
- 📄 **DSH hydraulic press**
- 📄 **Ceraman manual press**
- 📄 **Ceramatic automatic brick press**
- 📄 **Pact 500 mechanical press**
- 📄 **Dynaterre 01. 4 m mobile production unit**
- 📄 **Ellson blockmaster**
- 📄 **Astram soil block machine**
- 📄 **Tara balram**
- 📄 **IIT Madras cam block press**
- 📄 **CINVA- ram**
  
- 📄 **CETA- Ram**

-  **CTA triple - block press**
-  **CRATerre America Latina press**
-  **UNATA 1003 and 1004**
-  **MARO DC Press**
-  **Go 50**
-  **DSM**
-  **Bibliography**

## **Checklist for potential buyers**

**The following is a summary of the main points to be considered when selecting the most suitable block press:**

- Available financial resources (budget restraints can limit the choice considerably).**
- Required quality of blocks (small low-cost houses do not need highly compacted blocks, harsh climates may need stronger blocks).**
- Required prod action rate (the choice can be several less efficient presses, or a few high-output machines).**
- Weight and mobility of machine (the presses may have to be moved frequently from site to site).**
- Available energy sources (not only the costs must be considered, but also the frequency of power failures and supply shortages of diesel, petrol, etc.).**

- **Availability of spares and skilled technicians for maintenance and repairs (machines with standardized parts create less problems).**
- **Versatility of machine (presses with interchangeable moulds for a variety of products can bring about considerable savings).**
- **Operational safety (for this, several demonstrations of use, especially with unskilled workers, should be seen).**
- **References (contacts with users of the machine should be made whenever possible).**
- **Conditions of purchase (since machines with similar outputs are available, comparisons of prices, discounts for large orders, delivery time, etc. are urgently recommended**
- **After sales services (not only should the manufacturers be fair enough to rectify defects of their machines by providing technical assistance or supplying spare parts at minimum or no-cost; users should also take the trouble to send accounts of their experiences and suggestions for improvements to the manufacturers, for without this feed back no effective development is possible).**

## **Final Advice**









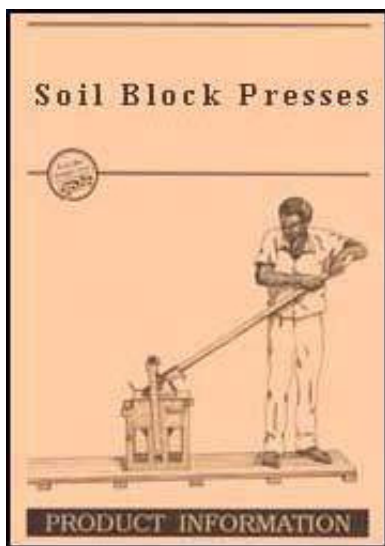











**The quality of the soil used is more important than the quality of the press. In other words, a good soil in a poor press can give better results than a poor soil in a good press.**



















[Home](#) > [ar](#).[cn](#).[de](#).[en](#).[es](#).[fr](#).[id](#).[it](#).[ph](#).[po](#).[ru](#).[sw](#)



-  **Soil Block Presses (GTZ, 1988, 38 p.)**
-  **(introduction...)**
-  **Acknowledgements**
-  **Technology**
-  **Equipment**
-  **Criteria for selection and purchase**
-  **Checklist for potential buyers**
-   **Press - bloc 80 tm mobile production unit**
-  **Kit 15/30 megabrik**
-  **CLU 3000 soil brick plant**
-  **Multibloc BREPAK block press**
-  **TEK- Block Press**
-  **Vs CINVA ram**
-  **Terstaram hand operated press**
-  **Semi-terstamatique motor operated press**
-  **DSH hydraulic press**
-  **Ceraman manual press**
-  **Ceramatic automatic brick press**
-  **Pact 500 mechanical press**

-  **Dynaterre 01, 4 m mobile production unit**
-  **Elson blockmaster**
-  **Astram soil block machine**
-  **Tara balram**
-  **IIT Madras cam block press**
-  **CINVA- ram**
-  **CETA- Ram**
-  **CTA triple - block press**
-  **CRATerre America Latina press**
-  **UNATA 1003 and 1004**
-  **MARO DC Press**
-  **Go 50**
-  **DSM**
-  **Bibliography**

## **Press - bloc 80 tm mobile production unit**

**Manufacturer**  
**GEOBETON ONE**  
**B.P.91**  
**F-53021 Laval CEDEX**  
**France**  
**Tel. 43 49 09 48**  
**Tlx. 722 603 f**

## **Description**

**The PRESS - BLOC 80 TM, first constructed in 1984, succeeded the company's first machine, the H 60 press, developed in 1981.**

**The machine is a mobile production unit, fixed on a self-carrying chassis equipped with 4 wheels, in accordance with road transport standards. The self-contained unit incorporates a vibrating sieve, a horizontal shaft mixer, a hopper and a hydraulic press, all powered by a single 47 hp diesel engine, which has a 301 tank and diesel consumption of 5 l/h**

**The press is designed to produce blocks of 29 x 14 x 9 cm with a tolerance of  $\pm 3$  mm for the height (at maximum compression) and a very smooth surface, achieved by hypercompression reaching a working pressure of 20 N/mm<sup>2</sup>. The blocks can be made solid or with recesses (by inserting frogs). Different sized blocks can be made to suit local requirements by changing the mould (within 1 hour). The height of the blocks is adjustable between 5 and 10 cm.**

**The PRESS - BLOC 80 TM is conceived for use in harsh tropical conditions, and has a large in built safety factor in all hydraulic jacks, pumps flexible pipes and mechanical items. Resisting parts are manufactured in special steel and are replaceable.**

### **Operating the PRESS -BLOC 80 TM**

**The production of soil blocks comprises both manual and automatic operations and is carried out in two stages, which function independently of each other.**

**The vibrating screen is fed manually by a crew with shovels or a front-end loading tractor. The screen vibrates automatically, separating stones and foreign debris from the earth, which drops into a hopper and through an automatically controlled funnel loader into the mixer.**

**The addition of a stabilizer (if required) and water is done manually, directly in the mixer. After thorough blending, the mixer is lifted up automatically by the two lateral pivoting shafts. At the topmost position, the mixer opens automatically, dropping the soil mix into the 2001 fixed hopper. This concludes the first production phase.**

**The automatic filling, hydraulic compression and fuming out cycle is controlled independently of the other operations by an electronic and pre-programmed computerized device, which incorporates a release mechanism. The compression speed of the vertical stroke hydraulic jack is 75 mm/s during precompression and 10.8 mm/s during hypercompression. the compression pressure is adjustable.**

**A worker, standing on the base frame, removes the blocks as they are ejected from the press, at intervals of approximately 8 seconds.**

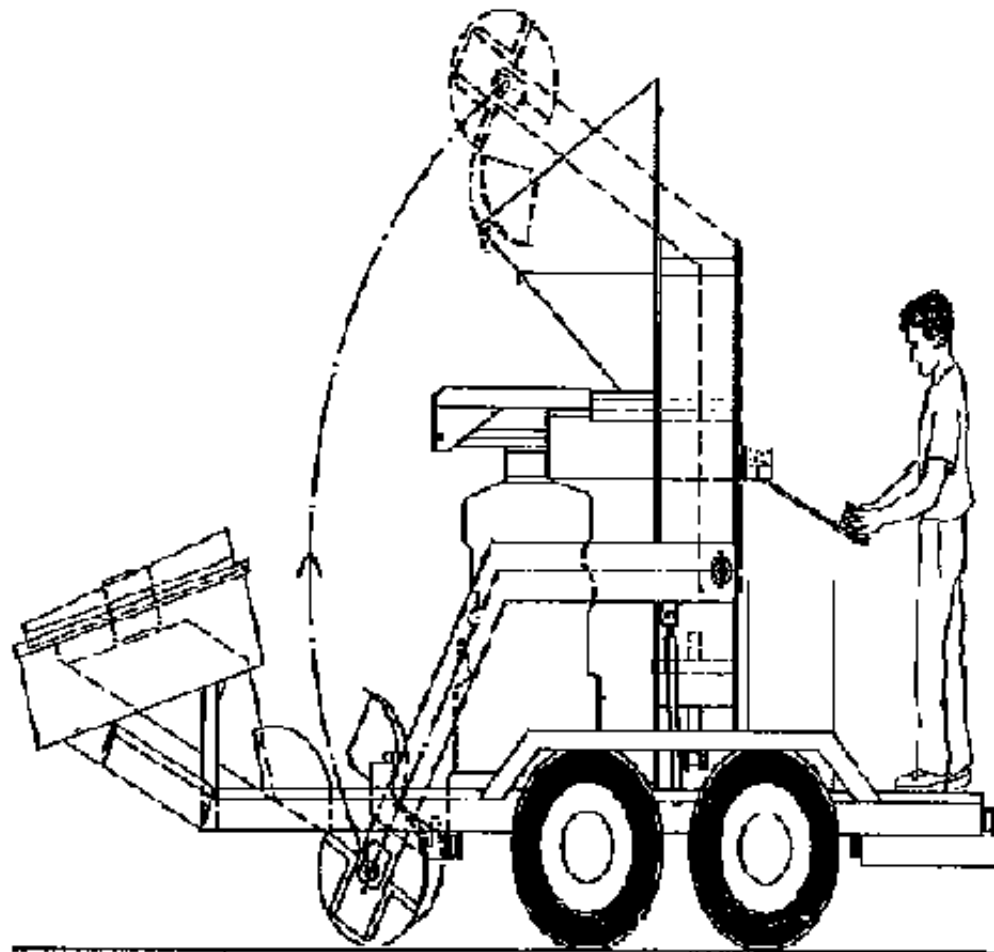

**FIGURE**

Technical Details	
Size of machine (length x width x height)	462 x 222 x 295 cm(182 x 88 x 116 in)
Weight of machine (without mould)	3500 kg
Shipment of machine	in standard container (details according to

Weight of packed machine	shipping company) 3800 kg
Standard block size (single mould)	29 x 14 x 9 cm (11.4 x 5.5x 3.5 in)
Maximum nominal compaction force	80 tonnes
Nominal compaction pressure	20 N/mm <sup>2</sup> (2900 p.s.i.)
Compression ratio	2:1
Energy input/transmission	motorized / hydraulic
No. of blocks per cycle/output rate	1 / 320 blocks per hour
Labour force required (incl. excavation and mixing)	6 - 8 men







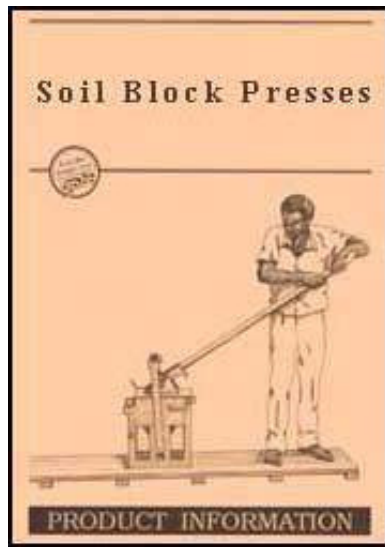

Price (ex works)	PRESS - BLOC 80 TM	525000 FF (approx. 90200 US\$)
valid June 1988	Kit for mould substitution	on request
	Spare parts package	included in the price of the machine
FF=		
French Francs		

[Home](#) > [ar](#).[cn](#).[de](#).[en](#).[es](#).[fr](#).[id](#).[it](#).[ph](#).[po](#).[ru](#).[sw](#)

 **Soil Block Presses (GTZ, 1988, 38 p.)**  
 **(introduction...)**



- 📄 **Acknowledgements**
- 📄 **Technology**
- 📄 **Equipment**
- 📄 **Criteria for selection and purchase**
- 📄 **Checklist for potential buyers**
- 📄 **Press - bloc 80 tm mobile production unit**
- ➔ 📄 **Kit 15/30 megabrik**
- 📄 **CLU 3000 soil brick plant**
- 📄 **Multibloc BREPAK block press**
- 📄 **TEK- Block Press**
- 📄 **Vs CINVA ram**
- 📄 **Terstaram hand operated press**
- 📄 **Semi-terstamatique motor operated press**
- 📄 **DSH hydraulic press**
- 📄 **Ceraman manual press**
- 📄 **Ceramatic automatic brick press**
- 📄 **Pact 500 mechanical press**
- 📄 **Dynaterre 01. 4 m mobile production unit**
- 📄 **Ellson blockmaster**
- 📄 **Astram soil block machine**
- 📄 **Tara balram**
  
- 📄 **IIT Madras cam block press**

-  **CINVA- ram**
-  **CETA- Ram**
-  **CTA triple - block press**
-  **CRATerre America Latina press**
-  **UNATA 1003 and 1004**
-  **MARO DC Press**
-  **Go 50**
-  **DSM**
-  **Bibliography**

## **Kit 15/30 megabrik**

### **Manufacturer**

**Les Ateliers du Progres  
23 avenue Mont Fleury**

**F-06300 Nice**

**France**

**Tel. 93 89 24 01**

**Tlx. 970 826 secnce f**

**Fax. 93 87 47 49**

### **Description**

**The MEGABRIK, which was designed in 1985, is conceived as a machine consisting of several components that can be assembled in different combinations, according to the requirements of the user. It is, therefore, available as an assembly kit,**



**designed to be put together by a "low-technology" artisan, as well as in a fully assembled, ready-to-use version.**

**The kit version includes:**

- a semi-automatic or automatic hydraulic device, 100 x 80 x 30 cm, called PROHA 15 s (Process Hydraulique Automatique) weighing 85 kg and consisting of a pump, a 100 l hydraulic fluid tank and command panel;**
- a compression device, 70 x 70 x 70 cm, called COMPAC 30 tonnes, weighing 320 kg and comprising a mould, moveable hopper with 4 hydraulic jacks and 2 vertical stroke hydraulic jacks for compression;**
- and a set of blue prints for assembly.**

**The ready-to-use version is fixed on a self-carrying chassis with 2 pneumatic wheels, in accordance with road transport standards. The machine is powered either by an electric motor or a 15 hp diesel engine, and can be equipped with a 200 l capacity planetary mixer, which is assembled on two lateral pivoting shafts, which are moved by a hydraulic jack.**

**Operating the MEGABRIK**

**The earth, stabilizer and water are fed manually into the mixer, which blends the contents in 200 s cycles. It is then lifted up automatically by the lateral pivoting shafts to fill the hopper.**

**The hopper incorporates a vibrating system (exclusive) for constant volume filling**

of the mould. The top cover of the mould is also attached to the hopper and moves back and forth with each change of the hopper's position, as shown in the diagram.

The filling, compression and turning out is done semi-automatically by means of a 7- position manually operated lever, or automatically by means of a pre-programmed device with a hydraulic by-pass. The theoretical duration of one production cycle is 20 seconds for semiautomatic operation and 15 seconds for automatic production.

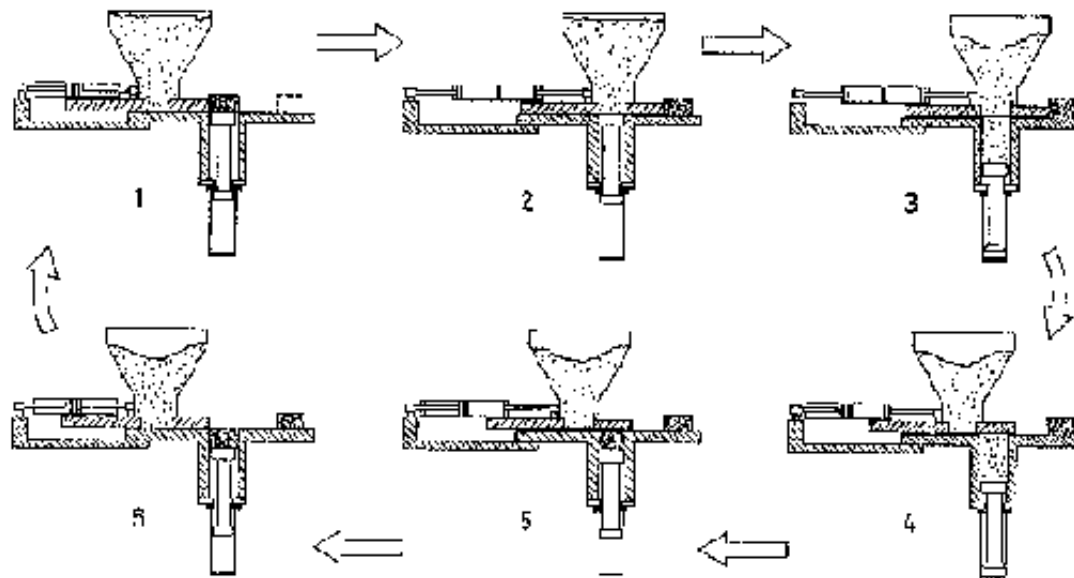

**FIGURE**

<b>Technical Details</b>		
Size of machine (length x width x height)		400 x 200 x 210cm (158 x 79 x 83 in)
Weight of machine:	Basic Kit (PROHA + COMPAC)	650 ka







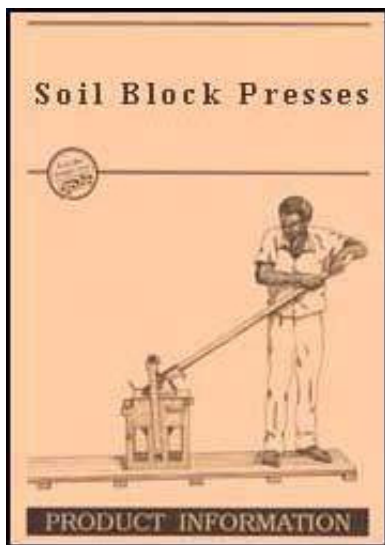

	Complete Unit (automatic, diesel) with mixer	700 kg
Shipment of machine	in crate or container (depending on kit or unit delivered)	
Weight of packed machine	ranges from 750 to 1900 kg	
Standard block size (single mould)	a.	29 x 14 x 9 cm (11.4 x 5.5 x 3.5 in)
Standard block size (single mould)	b.	24 x 12 x 6 cm (9.4 x 4.7 x 2.4 in)
Nominal compaction force		31.4 tonnes
Nominal compaction pressure		7.7 N/mm <sup>2</sup> (1100 p.s.i.)
Compression ratio		1.8: 1
Energy input/transmission		motorized/hydraulic
No. of blocks per cycle/output rate	a. or b. semi-automatic	1/160 blocks per hour
	a. or b. automatic	1/220 blocks per hour
Labour force required (incl. excavation and mixing)		4 - 6 men
Price (ex works)	MEGABRIK	
valid June 1988	Semi-auto., electr., without mixer	99000 FF (approx. 17000 US\$)
	Semi-auto., diesel, without	106500 FF (approx.























	mixer	18300 US\$)
	Semi-auto., electr., with mixer	134000 FF (approx. 23000 US\$)
	Semi-auto. diesel with mixer	154000 FF (approx. 26500 US\$)
	Automatic electr. with mixer	146000 FF (approx. 25000 US\$)
FF = French Francs	Automatic, diesel, with mixer	166000 FF (approx. 28500 US\$)
	KIT (PROHA + COMPAC + Plans)	56000 FF (approx. 9600 US\$)

[Home](#) > [ar](#).[cn](#).[de](#).[en](#).[es](#).[fr](#).[id](#).[it](#).[ph](#).[po](#).[ru](#).[sw](#)



## **Soil Block Presses (GTZ, 1988, 38 p.)**

-  **(introduction...)**
-  **Acknowledgements**
-  **Technology**
-  **Equipment**
-  **Criteria for selection and purchase**
-  **Checklist for potential buyers**
-  **Press - bloc 80 tm mobile production unit**
-  **Kit 15/30 megabrik**

- ➔  **CLU 3000 soil brick plant**
-  **Multibloc BREPAK block press**
-  **TEK- Block Press**
-  **Vs CINVA ram**
-  **Terstaram hand operated press**
-  **Semi-terstamatique motor operated press**
-  **DSH hydraulic press**
-  **Ceraman manual press**
-  **Ceramatic automatic brick press**
-  **Pact 500 mechanical press**
-  **Dynaterre 01. 4 m mobile production unit**
-  **Ellson blockmaster**
-  **Astram soil block machine**
-  **Tara balram**
-  **IIT Madras cam block press**
-  **CINVA- ram**
-  **CETA- Ram**
-  **CTA triple - block press**
-  **CRATerre America Latina press**
-  **UNATA 1003 and 1004**
-  **MARO DC Press**
  
-  **Go 50**

## **CLU 3000 soil brick plant**

### **Manufacturer**

**Intrex GmbH**

**P.O. Box 1328**

**D-5608 Radevormwald**

**Federal Republic of Germany**

**Tel. (02196) 7069**

**Tlx. 8513025 intr d**

### **Description**

**The CLU 3000 was developed in 1980 by the Consolid AG, Switzerland. It succeeded the CLU 2000 (developed in 1977), which was the first self-sufficient, self-powered mobile soil brick plant, fully equipped with a mechanically geared paddle mixer and hydraulically operated, valve controlled press and extruder.**

**The CLU 3000 incorporates a double mixer unit, the upper mixer used for blending the chemical compounds with the soil, the lower one completing the mixing process and simultaneously feeding the rotating moulds. The 4-station rotating table automatically turns 90° for each step (filling, inspecting, pressing and ejecting). The mixer can also be used independently, if only mortar needs to be mixed.**

**The whole plant is mounted on a special one-axle trailer with spring-suspended**

**7.00 x 14 tyres, an adjustable shaft bar, a height adjustable front wheel and hand break. Any suitable vehicle (from a tractor to a bullock cart) can be used to tow the plant to the next production site.**

## **International Cooperation**

**Numerous building projects in Africa, Asia and Latin America have been carried out with soil bricks made with the CLU 3000 and incorporating the additives of the CONSOLID system.**

**The machine and the chemical products are being manufactured under licence in Mexico and India, as well as in other countries in the near future.**

**Details can be obtained from:**

**CONSOLID AG**

**CH-9467 Fruemslen**

**Switzerland**

**Tel. (085) 75686**

**Fax. (085) 75795**

**Tlx. 855122 coag ch**

## **The CONSOLID System**

**Three chemical products, designed to control the water sensitivity of soil as a construction material, were developed in the early 1970s by the CONSOLID AG, Switzerland:**

**CONSOLID 444 a liquid, used in proportions of less than one part per thousand**

**parts of soil, serving to agglomerate the fine particles irreversibly, thus reducing the capillary rise of water and improving the compactability of the soil. CONSERVEX a liquid, used in proportions of less than 1 % by weight of the soil, to further reduce the tendency to absorb water, thus improving the effectivity of CONSOLID 444. SOLIDRY a dry powder, used instead of CONSERVEX, in the same proportions, in cases when the soil is too moist to permit the satisfactory blending of CONSERVEX. SOLIDRY can also be added to cement and lime to improve**

### **Additional Equipment**

**CATAPULTER Sieve Machine - Model UNI 400 - which pulverizes soil lumps and removes coarse particles larger than 20 mm, in order to provide the uniform, finely grained soil required for high quality brick production.**

**The mobile sieve machine (equipped with two semi-pneumatic tyres) is powered either by 7 hp gasoline engine or 5.5 kW electric motor. Weight 220 kg; dimensions 725 x 700 x 1400 mm; output approx. 3 m<sup>3</sup> soil per hour.**

### **Operating the CLU 3000**

**Two workers are required to fill the mixer with loose soil (100 litres for each batch), additives, such as cement, lime and/or chemical waterproofing compounds (CONSOLID 444 and CONSERVEX), and water. After thorough blending, the mixture is discharged into the lower mixer by means of a sliding valve. Further mixing takes place, and when the rotating table is started, the material is continuously filled into each mould, as it passes under the hole at the bottom of the mixer. In this way, the moulds are always filled with the same quantity of soil**



**mix, ensuring a uniform thickness of the bricks.**

**The next turn (90°, anticlockwise) exposes the filled mould for inspection by the third worker, who operates the control switches and thus can respond to any deficiencies immediately. Moving to the next position can be controlled manually or automatically at variable speeds, with intervals between each quarter-turn of about 6 to 10 seconds.**

**At the third station, each brick is hydraulically compacted by applying 15 tonnes (corresponding to 5 N/mm<sup>2</sup>). The finished brick is ejected at the fourth station, where a fourth worker removes the brick and places it for drying.**

### **Special Rental Service**

**The CLU 3000 Soil Brick Plant with electric motor is also available on a rental basis within Europe. Special discounts are negotiable for rental periods exceeding 30 days.**

**The machine is available ex works and can be towed by any suitable vehicle or loaded on a truck. The transportation including a transportation insurance can be arranged by Intrex GmbH at cost price, if the customer so wishes.**

**A detailed manual for the production of compressed soil bricks and for the operation and maintenance of the machine is supplied with the CLU 3000.**

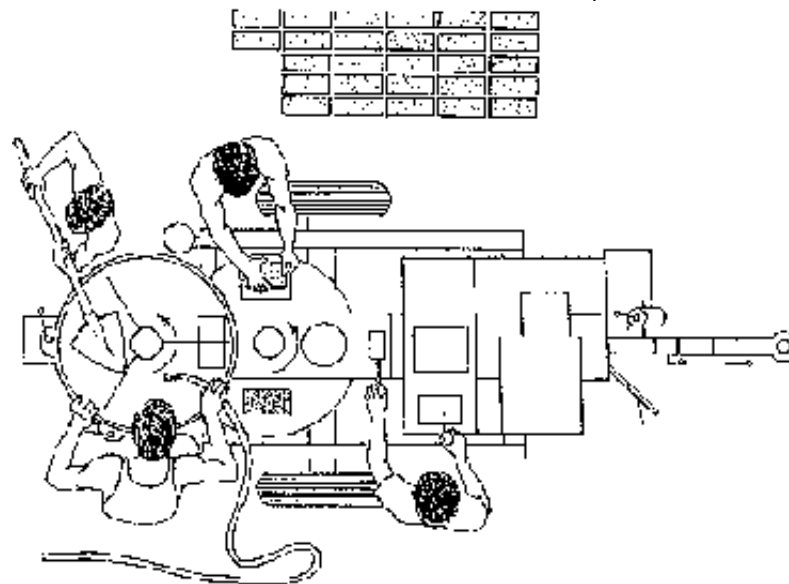
**FIGURE****Technical Details**

Size of machine (length x width x height)	300 x 145 x 152 cm (118 x 57 x 60 in)
Weight of machine (with motor / without motor)	1600 /1472 kg
Size of crate for shipment	320 x 165 x 188 cm (126 x 65 x 74 in)
Weight of packed machine	2310 kg

Standard brick size (single mould)	a.	25 x 12 x 7.5 cm (9.8 x 4.7 x 2.9 in)
Standard brick size (single mould)	b.	22.8 x 11.4 x 6.3 cm (9 x 4.5 x 2.5 in)
Standard brick size (single mould)	c.	24 x 11.5 x 7.1 cm (9.4 x 4.5 x 2.8 in)

Maximum nominal compaction force

15 tonnes

Maximum nominal compaction force	15 tonnes
Nominal compaction pressure	5 N/mm <sup>2</sup> (715 p.s.i.)
Compression ratio	1.8: 1
Energy input/transmission	motorized / hydraulic
No. of bricks per cycle/output rate (same for a., b. and c.)	1 /350 bricks per hour
Labour force required (incl. excavation and mixing)	6 men

Price (ex works)	CLU 3000	51900.—DM (approx. 31000.—US\$)
valid June 1988	CONSOLID 444	(1 liter) 8.40 DM (approx. 5.—US\$)
	CONSERVEX (1 liter)	2.65 DM (approx. 1.60 US\$)
	SOLIDRY (1 kg)	1.50 DM (approx. 90 US\$)
DM =	Spare parts package	1453.—DM (approx. 870.—US\$)
Deutsche Mark	Rental cost of CLU 3000 daily	186.90 DM (approx. 112.—US\$)