[Printable version](#)[Export document as HTML file](#) [Help](#)[Export document as PDF file](#)

Small Projects' Training Manual - Volume II: Water Supply (SCC; 1987; 399 pages)

0. Introduction

- [0.2 Foreword](#)
- [0.3 Purpose of the Manual](#)
- [0.4 Possible Readers of the Manual](#)
- [0.5 Summary of the Contents](#)
- [0.6 Format and Style of the Manual](#)
- [0.7 Instructions on how to Use the Manual](#)
- [0.8 Instructions how to Teach with the Manual](#)

5. Mathematics

- [5.1 Basic Calculations](#)
- [5.2 Percent Calculations](#)
- [5.3 Measurements](#)
- [5.4 Basic Geometry](#)
- [5.5 Calculation of Diagonal](#)
- [5.6 Calculation of Volumes](#)
- [5.7 Calculation of Weights](#)
- [5.8 Calculation of Time](#)





















6. Basic Technical Knowledge

- [6.1 Basic Technical Drawing](#)
- [6.2 Marking Rectangular Layout Plan](#)
- [6.3 Tools](#)
- [6.4 Using Measuring Tools](#)
- [6.5 Building and Other Materials](#)
- [6.6 Cement and Concrete](#)
- [6.7 Bricklaying](#)
- [6.8 Improved Local Building](#)

[7. Building Administration](#)

- [7.1 Planning](#)
- [7.2 Work Records](#)

-  **7.3 Records of Materials**
-  **7.4 Cost Calculation for Community Work**
-  **7.5 Cost Calculation for Contract Work**
-  **7.6 Purchasing Locally**
-  **7.7 Purchasing from Khartoum**
-  **7.8 Purchasing from Abroad**
-  **7.9 Storekeeping - Recording**
-  **7.10 Organising a Store**
-  **7.11 Storekeeping - Procedures**
-  **7.12 Stock-Taking**
-  **8. Water Supply**
 -  **8.1 Story about Good Water Supply**
 -  **8.2 Connection of Water Supply with the Community**
 -  **8.3 Process of Community Development - Water Supply Cooperation**
 -  **8.4 Cooperation of Water Supply Technicians with the Community**
 -  **8.5 Importance of Adequate Water Supply**
 -  **8.6 Water Related Diseases**
 -  **8.7 Basic Facts about Water**
 -  **8.8 Groundwater**
 -  **8.9 Desertification**
 -  **8.10 Wells**
 -  **8.11 Comparison of Borehole and Hand Dug Well**
 -  **8.12 Selection of Well Sites**
 -  **8.13 Site Survey by Hand Augering**
 -  **8.14 Construction Methods for Hand Dug Wells**
 - 8.15 Well Digging Techniques**
 - 8.16 Manufacturing Concrete Rings**
 - 8.17 Lowering Concrete Rings into a Well**
 - 8.18 Manufacturing a Well Cover**
 - 8.19 Well Head with Hand Pump**
 - 8.20 Completion of a Well**
 - 8.21 Safety Measures**
 - 8.22 Ventilation in Wells**
 - 8.23 Ropes and Knots**

-  **8.24 Types of Pumps and Other Water Lifting Devices**
-  **8.25. Dewatering Wells during Construction**
-  **8.26. Diaphragm Pumps**
-  **8.27 Fuel-Powered Suction Pumps**
-  **8.28. Submersible Pumps**
-  **8.29. Drawing Water from a Well for Human Consumption**
-  **8.30. Hand Pump Parts and Functions**
-  **8.31. Hand Pump Installation**
-  **8.32. Basic Plumbing**
-  **8.33. Hand Pump Caretaking**
-  **8.34. Calculation of Pump Discharge**
-  **8.35. Spring Protection**
-  **8.36. Well Disinfection**
-  **8.37. Water Treatment at Home**
-  **8.38. Handling Water at Home**
-  **8.39. Health Education about Water/Operating Instruction for Wells**
-  **10. Appendix**
 -  **10.1. List of Abbreviations**
 -  **10.4. List of Illustrations (from literature)**
 -  **10.5. Bibliography**

Small Projects' Training Manual - Volume II: Water Supply

Sudan Council of Churches * Munuki Water and Sanitation Project

**by
Marta and Rudi Guoth-Gumberger**

**I did the planting,
Apollos did the watering,
but God made things grow.
Neither the planter,
nor the waterer matters:
Only God who makes things grow.**

1 Cor 3,6-7

0. Introduction



0.2 Foreword

Two people are named as authors of this training manual; however, in reality it is the result of the work of very many people. We hope that it will serve a great number of people as well.

The development of the manual has a long history. We had the opportunity to work with the Sudan Council of Churches from 1982 to 1987, first in the Integrated Rural Development Programme in Yirol, and then in the Munuki Water and Sanitation Project in Juba, both in Southern Sudan. We had been assigned as Water Supply Coordinator (Marta) and Community Development Coordinator (Rudi). In the beginning we had background knowledge but little field experience. So we started to learn with and from the people and from the literature. At the same time we started training the people with whom we

worked. In the beginning the training was exclusively on site. However, in the second project, the training became more formalised into a full two years programme of both class and field work. We began from the actual level of knowledge of the trainees without the assumption that "one should know this or that", and gathered whatever knowledge was necessary to do the project work together. Soon, compiling and distributing of written material became necessary, and so this manual was begun.

It includes many of our experiences in the water and sanitation work during the last five years. The bulk of the information was ready in first draft in April 1987. Photocopies were distributed to the participants of a three months training course. Contributions and questions from the participants were invaluable, and many sections were revised/improved. Actually, the manual would have never been written without the eagerness of the Munuki project's staff to learn. This interest made learning and teaching very enjoyable. After the training course, the entire manual was revised further and finally completed to the present version.

We thank our colleagues in the Munuki Water and Sanitation Project for all we learned from them, for their good cooperation and for their contributions to the manual. They are:

Edward Lako, Arthur A.Columbano Lado, Rhoda Benjamin, Joseph Lado Lubajo, Joan Batul Eliaba, Simon John Lubang, Gloria Habakuk Soro, Paulino Onorato Legge, Prissy M. Wai Wai, Jackson Onan.

We also thank the course participants from Swedish Free Mission and Sudanaid for their contributions. They are:

Inga Andersson, Margaret Toya, Isaac Kajokole Kenyi, James Jamil, James Wani, Lona Kojo Michael, Julius Sebit, Erasto Tupa, George Mogga Wani, Elijah Biar, Rose Paul, Robert Otik, Rhoda Yangi Wesley, Quintino Pitya, Anna Itto Njimirano, Ben Juma.

We extend our thanks also to Tom Benton, Sr. Margaret Donohue RSM, Paul McGleenan, Paul Hiebert, Char Holcomb, Stephen Power SJ, Dr. Douglas Reitsma, Susan Sunflower, Dr. Ruth Goehle, Betsy Bascom, for the tiresome work of proofreading.

We thank Mike Gogonya, Hakim Benjamin and Stephen Hakim for many of the drawings.

We are also very grateful to Michael Kubrom Habtai who shared his office with us during the weeks of final revision and typing, made the SCC library available for us and encouraged us with practical help and supporting words.

We thank the Sudan Council of Churches, and especially the Deputy General Secretary, KostiManibe, for the generous support which made this manual possible, by providing working facilities, financial resources, an electronic typewriter and numerous other resources.

There are many other individuals whom we would like to thank for their helpful contributions, but who are too numerous to be named.

We apologise for mistakes which remain in the manual inspite of revisions and corrections, and kindly ask the readers to send any corrections, comments and suggestions about the manual to one of the following two addresses:

Márta Guóth-Gumberger, Rudolf Gumberger
Neue Heimat 5a
D-83024 Rosenheim
Germany
Tel.: 08031/81103
Fax: 08031/43695

**Munuki Water and Sanitation Project
Sudan Council of Churches
P.O. Box 469
Khartoum
Sudan**

For further copies of the manual please contact:

**Publicity Office
Sudan Council of Churches
P.O.Box 469
Khartoum
Sudan**

Any parts of this manual may be copied, reproduced or adapted to local needs, without permission from the authors or publisher, provided the parts reproduced are distributed free or at cost, not for profit. For any reproduction with commercial ends, permission must be obtained from the authors and the Sudan Council of Churches. The authors appreciate being sent a copy of any materials in which text or illustrations have been used.

As this work would never have been possible by our own strength without God's help, so we hope that God will also protect and strengthen any persons who use this manual and any future work done with the help of this manual.

**Knartoum, 11.11.1987
Márta and Rudi Guóth-Gumberger**

0.3 Purpose of the Manual

The following introduction should help the reader to orientate her/himself to the manual and make best use of it.

According to the title, this manual is intended for small development projects with 20 to 40 staff members. The administrative and organisational structures described correspond to this project size.

Secondly, this book is a training manual. It does not intend to present all the information available for professionals about a covered topic, but rather to select the most basic and relevant information about a topic. Then it arranges and presents it in such a way as to introduce a beginner, but also that a trained staff can find it helpful. The manual will help senior staff to organise and improve their management.

The aim of this manual is to train senior secondary school leavers to become skilled technicians in water supply and sanitation work, to run a store, to keep records and do qualified field work, or to become community development officers. They should be able to lead a team later on and to do basic work in administration.

However, the manual can serve different purposes as described below:

1. Training:

- It can be used by the trainee for self-study or as complementary material to the teaching in class.**

- It can be used by the teacher/instructor as a guideline for preparing lessons in class about the covered topics.
- Some parts can be used as guideline for technical training for illiterate people.
- Some parts can be used as guideline for training sessions in the community.

2. Guideline:

- It can be used by experienced people as a help to develop and build up a new small project.

3. Reference book:

- It can be used as reference in day-to-day project work in the different covered fields.
- It can be used by the trainee for looking up particular information after the course.
- It can be used for revising previously acquired knowledge.

0.4 Possible Readers of the Manual

The manual provides material for a two years training course for several (technical) areas with 25% training in class and 75% training in the field. It is expected that not everything in the manual is for every trainee or reader.

The manual was developed in a water and sanitation project. Therefore, major parts deal with these subjects. However, many parts are of a more general nature so that they might be useful for staff of other projects, for churches, communities and development organisations.

In detail, material from the manual might be useful for the following groups of staff:

No	Staff or Trainees	Relevant Sections	Relevant Chapters
1	senior staff in management functions	1,2,3,7	4.18; 4.21; 5.1; 5.2;8.11 8.29; 9.8
2	administrative staff, typist	1,2	5.1; 5.2; 5.8
3	bookkeeper	1,5	2.9-18; 3.3-4; 7.2-12
4	community development staff	1,4,9	2.7; 2.11-12; 2.18; 3.1; 3.2; 3.11-13; 5.1-2; 5.8 7.1; 7.6; 8.1-11; 8.29; 8.33; 8.36-39
5	water supply staff	1,5,6,7,8,9	2.11-15; 2.18; 3,1-2; 3.11-13; 4,1-2; 4,15-16;
6	other technical staff like building staff	1,3,5,6,7	
7	storekeeper	1,5,6,7	8.32
8	logistics staff	1,3,5,7	2.18; 6,3-5

9	driver	1,3,5	2.18; 6,3-5; 7.6
---	--------	-------	------------------

0.5 Summary of the Contents

The manual consists of nine sections, compiled in three volumes:

Volume I	1.	General Knowledge
ADMINISTRATION	2.	Administration
and	3.	Running a Vehicle
COMMUNITY DEVELOPMENT	4.	Community Development
Volume II	5.	Mathematics
WATER SUPPLY	6.	Basic Technical Knowledge
	7.	Building Administration
	8.	Water Supply
Volume III	9.	Sanitation
SANITATION		

Volume I contains the general parts combined with community development, volume II and III contain the technical parts.

The manual was divided into three volumes so that it can be used in parts and become more handy for the reader. Sanitation was taken as a separate volume, because many may be interested in this section alone. Still, the manual is one work and the different sections belong together. There are many references pointing to other chapters in a different volume.

The different sections are briefly introduced in the following:

1. General Knowledge

Relevant information not fitting into the other sections was compiled here. "Using a Dictionary", "Reading Techniques" and "Study Techniques" are useful for the work with the manual. "Private Budgeting", "First Aid" and "Applications" are also generally needed knowledge.

2. Administration

The basic administrative knowledge and procedures for a small project of 20 to 40 staff members are compiled here.

3. Running a Vehicle

Here everything which a responsible user of a vehicle - not a mechanic! - has to know in order to run the vehicle economically and to prevent unnecessary damages is compiled. The section is important for both senior staff or logistics staff and drivers.

4. Community Development

This section compiles basic information necessary for community development work, both of general nature and background information as well as practical procedures.

5. Mathematics

The manual is not intended to be a mathematics book. Therefore, you cannot find detailed explanations of mathematical principles. Rather you will find a collection of mathematical knowledge in recipe-style about whatever was found necessary for the project work - mostly very simple things and few more sophisticated.

6. Basic Technical Knowledge

Basic technical knowledge for the water supply and sanitation work is compiled here, "Basic Technical Drawing", "Using Measuring Tools", "Tools", and "Cement and Concrete" being the most important ones to be studied first.

7. Building Administration

The specific administration necessary for construction work is described here, consisting of "Planning", "Record Keeping", "Cost Calculation", "Purchasing" and "Storekeeping".

8. Water Supply

The section about water supply starts with general knowledge about water, discusses the different well types, the selection of a well site. Construction of hand dug wells with concrete rings is described in detail. An overview about pump types is given; some of them are described in more detail, especially hand pumps, and basic plumbing is added. "Well Disinfection", "Water Treatment" and "Health Education" are discussed in the end.

Hand dug wells and hand pumps were deliberately selected as main topics to be covered. Other books (see bibliography No.17, 18,35) cover these topics much more comprehensively; however, here the emphasis was to prepare training material in easily understood overviews and step-by-step procedures.

9. Sanitation

This section starts with general background knowledge about sanitation. The different types of disposal systems are introduced and guidelines for selecting the suitable latrine suggested. Deliberately, only sanitation systems without water were selected to be covered. Several are described in more detail. The main emphasis lies on compost latrines, including different designs, composting process, construction, operation and maintenance, and follow-up. Chapters about children's squatting slab, bath, waste matter and pesticides complete the section. Many parts of this section are suitable for training sessions about sanitation in the community or in schools.

0.6 Format and Style of the Manual

As the purpose of the manual is to assist trainees, teachers and field staff, we put emphasis on giving it a consistent and easily understandable format. The

The purpose of the manual is to assist trainees, teachers and field staff, to put emphasis on giving it a consistent and easy understandable format. The colleagues in the project work found that providing structures was helpful, and they had no difficulties at all filling the structures with life and flesh. Therefore, the manual offers a lot of structures, forms, tables, boxes, and step-by-step procedures. This shall help to gain an overview about the field and to easily find the required information.

A) Format of the Manual

The page numbers on top of each page reflect the format of the manual. Each one of the nine main sections contains several chapters. Each chapter has one or more pages.

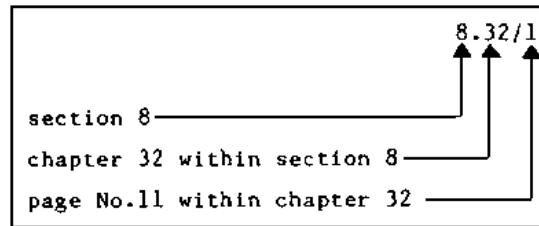

The introduction with foreword, etc., is added as another section 0. The appendix with bibliography, index, etc., is added as section 10. Section 0 and 10 are attached to all three volumes to help the reader use the manual. Thus, the volumes contain these sections:

Volume I	: sections 0,1,2,3,4,10
Volume II	: sections 0,5,6,7,8,10
Volume III	: sections 0,9,10

Consecutive page numbers at the bottom of each page run in each volume separately.

Each chapter starts on a new page. Both the title of the section and the chapter are named:

8. Water Supply

8.14 BASIC PLUMBING

Directly under this headline you will find one or several bible quotations in some chapters. These were used for the prayer fellowships which were an integrated part of the three months course, and are related to the topic where they are mentioned.

Usually, each chapter starts with a brief introduction as each chapter is an entity by itself and should be readable by itself. The material within one chapter is mostly structured according to the same system, for example, in the lesson "Basic Plumbing":

A) Threads

1. Thread Types

a) Internal/External Threads

b) Right Hand/Left Hand Threads

- c)
- d)
- e)
- f)

2. Thread Standards for Bolts and Nuts**a) Metric Coarse Threads M**

- b)
- c)
-

3. Thread Standards for Pipes

- a)
- b)
-

4. Pipe Measurements**B) Basic Operations of Plumbing****1. Cutting with a Hacksaw****2. Pipe Cutting****3.****C) Pipe Joints**

- 1.
- 2.
-

Most lessons have only a structure A, B, C, ... and 1., 2., 3., ... All titles are capitalised and underlined, as well as other important words within the text. All important messages are put into boxes. Step-by-step procedures are either numbered or put into a box with a separate column giving the reasons. All tables are in boxes.

AS each chapter is a separate entity and can be used as a teaching unit, a continuous flow between the chapters is not maintained. Repetitions occur sometimes, otherwise, a reference refers to the relevant chapter containing more information about a certain point.

B) Language of the Manual

The manual deliberately uses simple English to explain a topic, to give trainees with limited English knowledge a chance. Simple sentence constructions were preferred to elegance of style. Some special vocabulary in the different topics was introduced, but always with explanations. Often another equivalent word is given in brackets, e.g.

“serrated (= toothed)”,

“aquifer (= water-bearing layer)”

As the book is a training manual, no foot-noting was applied. We used drawings and information from books together with project experience and compiled them for the teaching purpose. The literature used and useful for further readings is compiled in the bibliography.

C) Drawings

Many drawings are added for illustration and easy reading. In the technical part, mostly proper technical drawings are used (such as cross-section, layout plan, etc.), because they convey the information in a more correct and complete way than other types of drawings. The reader/trainee not acquainted with technical drawings must study chapter 6.1 “Basic Technical Drawing” before reading. Experience showed that the trainees without previous technical training were soon able to read technical drawings. The drawings in the manual shall also give the trainee practice in reading technical drawings. Almost all drawings are placed below or beside the relevant text, although this way consumed more space. This shall ease the reading as well.

0.7 Instructions on how to Use the Manual

As not everything in the manual is useful for each reader, you need to pick what is interesting for you. Selection should be easy because of the provided structures. The following can help you to make full use of the manual:

1. Do not attempt to read the manual from the first to the last page like a novel.
2. Make yourself acquainted with the format and the paging of the manual (see 0.6).
3. Cut separation taps from carton paper for the different sections and glue and staple them to the title page of each section.

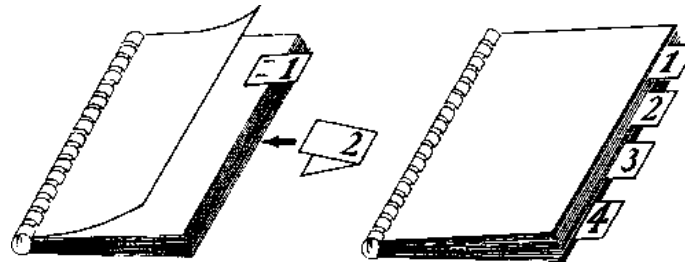

4. Use the SQ3R-method explained in 1.3 to read the manual.
5. Read the table of contents and mark which chapters are interesting for you.

6. Decide which chapters to read first. Chapters 1.2, 1.3, 1.4, 5.1, 5.2 provide necessary basis for further reading of the manual; for technical staff

6. Decide which chapters to read first. Chapters 1.2, 1.3, 1.4, 5.1, 5.2, provide necessary basics for further reading of the manual, for technical staff also 5.3, 5.4, 6.1.

7. Apply the SQ3R-method for each chapter as well. Read the headlines of the chapter first to get an overview, collect your questions about the material, etc.

8. Underline important key-words; write your notes, remarks and questions into the manual wherever needed.

9. Use the list of abbreviations, list of forms used, list of leaflets and posters, in the end of each volume.

10. Use the index in the end of each volume to quickly find information about a certain point.

11. Use the bibliography for further studies.

0.8 Instructions how to Teach with the Manual

There are many books about how to teach, and teaching methods are not the topic of this manual. Thus, only a few suggestions are compiled in the following on how to teach with this manual (see also 4.14; 4.24).

A) General Learning Conditions

Help obtain good learning conditions:

1. Take special care that the class becomes a community, that the trainees get to know and respect each other, that they can mutually help each other. Fruitful learning can only take place in an atmosphere of cooperation.
2. Believe that the trainees are capable of learning. Trust is essential for encouragement and learning.
3. Take special care that the physical situation is supportive for learning: an adequate room, water, feeding, sanitation must be available. Involve the trainees by distributing assignments (fetching water, cleaning, organising food, etc.).
4. Take care that the trainees have sufficient materials like files, paper, pens, etc.
5. Arrange the class in the classroom in a circle whenever possible. This is the case for most of the chapters in this manual, except for the ones involving calculations.

B) Planning Lessons

Good preparation is essential for good teaching:

1. Take time for preparing your lessons. Roughly estimate as much time for preparation as for class time.
2. Plan the syllabus before a training course.
3. Each chapter in this manual is an entity by itself and can be used as guideline for a lesson. Some chapters may take several lessons to cover. Roughly, maximum five pages can be covered in a teaching unit of two hours.

4. Plan extra lessons in the beginning of the course just for explaining the syllabus and the format of the manual.
5. Plan enough time for evaluation.
6. When planning your lessons, mix the teaching methods: mix group-work with class discussions, calculations with explanations on a model, etc.
7. Have your teaching material (models, posters, etc.) ready before the lesson.

C) Teaching Methods in Class

A variety of teaching methods is suitable for teaching with this manual in class:

1. You can structure many lessons according to the SQ3R-method (see 1.3):

S = Survey: Explain at the beginning what the lesson will cover.

Q = Question: Ask the trainees if they have questions about the topic and note these down. Check after the lesson if the questions were answered.

R = Read: Conduct the lesson. Explain the material.

R = Recite: Let trainees repeat and explain with their own words what they have learnt and understood.

R = Revise: Give homework, revise the following day or after one week.

2. Use group-work. Let groups of 4 to 5 discuss a certain question, try to read a passage or a drawing of the manual together, collect different aspects of a topic, etc.
3. Use discussion in the whole class to summarize group-work, to introduce something new, to explain an aspect relevant to all.
4. Use from time to time work on a certain assignment for each trainee alone (e.g. calculations).
5. Use role plays whenever possible (e.g. first aid, interaction of technicians with the community, etc.). They are fun and very educative.
6. Teach by action whenever possible (e.g. cleaning and rehabilitating a latrine, safety measures, interview, etc.).
7. Include field visits into your training programme.
8. Use posters, models, actual examples, whenever possible. Many of the drawings in the manual can be drawn on big posters for use in class. Well construction work is best understood when demonstrated with small models. Bring pieces of material for everything you discuss in class.

D) Questions

Asking questions is a way to learn, for both the teacher and the trainee.

1. Encourage the trainees to ask questions.
2. Ask at the end of a lesson whether there are any questions.
3. Ask in the beginning of a lesson if questions remain from the day before.
4. If you cannot answer a question, do not pretend and dodge around. Admit it, look it up after the lesson, and answer it the next day.
5. Spend some time before and after the lesson in class to give the trainees a chance to ask.

E) Homework

Study on her/his own is essential for the trainee in order to be able to digest the material learnt.

1. Give homework to almost all of your lessons.
2. Encourage students to keep their homework well filed and organised with chapter numbers and headlines.
3. Ask trainees from time to time to prepare for a lesson on their own by studying the manual in advance.
4. Take time to correct the homework and return it as soon as possible.

F) Teaching Field Work

Some extra efforts in teaching field work will improve the results considerably.

1. Before you do a new type of work the first time in the field (like lowering concrete rings into a well), discuss the step-by-step procedures in detail in class. Use a model to illustrate the steps. This will help the trainees to keep an overview of the work. It will also help them see themselves as a part of the whole team and process rather than individuals doing just menial work. Discussion beforehand in class is better than trying to explain on the spot in the hot sun when half of the staff cannot hear you.
2. Sit down in the shade with the staff after having completed a new job or after something has gone wrong. Evaluate what happened by asking: What did you learn? What was new? What went wrong? What could be done better?, etc. (see also 2.7). This can help a lot how to judge the situation and how to improve techniques.
3. The same methods can be applied when teaching field work to illiterate people. Using models is even more important.

5. Mathematics

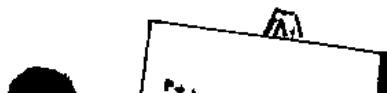

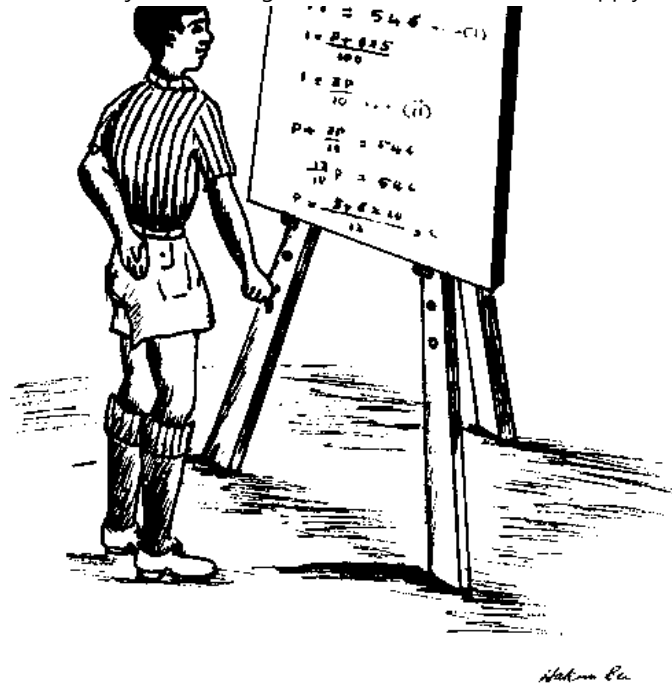

5.1 Basic Calculations

The most basic rules for calculations are compiled here for the everyday project work.

A) Decimals

Money, measurements (not time!) are expressed in decimals. All the figures to the left of the decimal point are whole numbers - units, tens, hundreds, thousands etc. All those to the right are fractional parts - tenths, hundredths, thousandths etc.

whole numbers				decimal fractions																	
9	4	3	2	.	1	2	7	=	(9x1000)	+	(4x100)	+	(3x10)	+	(2x1)	+	$\frac{1}{10}$	+	$\frac{2}{100}$	+	$\frac{7}{1000}$
thousands	hundreds	tens	units		tenths	hundredths	thousandths														

No matter how many figures come after the decimal point, they amount to less than one unit. 0.78925 is less than one.

The figures to the right of the decimal point are called “decimal places”. For example, 4.06 has 2 decimal places.

B) Addition and Subtraction of Decimals

D) Addition and Subtraction of Decimals

Adding and subtracting decimals is just the same as adding and subtracting whole numbers.

- The sums must be set down in an orderly way.
- Keep the units, tens, hundreds, etc., in their correct columns.
- Keep the tenths, hundredths, thousandths, etc., in their correct columns.
- Keep the decimal points in a vertical straight line.
- A whole number like 15 may be written 15.00 to keep it more easily in the correct columns. Putting the decimal point and adding a convenient number of zeros (= noughts = 0) after it does not alter the amount.
- Start the work on the column farthest to the right of the decimal point. Carry tens in the ordinary way, as if the decimal point was not there.
- Put the decimal point in the answer under the decimal points above.
- Using checkered paper can help to avoid mistakes.

Example:

$$\begin{array}{r}
 6.8 \\
 4.54 \\
 15.00 \\
 \hline
 38 \\
 \hline
 26.72
 \end{array}$$

$$\begin{array}{r}
 613.090 \\
 - 23.418 \\
 \hline
 589.672
 \end{array}$$

C) Multiplication and Division of Decimals

The most frequent cause of mistakes in multiplication and division of decimals is putting the point in the wrong place. There are simple rules for placing the point correctly.

1. Multiplication of Decimals by 10, 100, 1000, etc.

- To multiply a decimal number by **10**, simply move the point **one** place to the **right**.
- To multiply by **100**, move the point **two** places to the **right**.
- To multiply by **1000**, move the point **three** places to the **right**.
- Add extra zeros (= noughts), if necessary.

Examples:

$$4 \times 10 = 4.0 \times 10 = 40$$

$$\overset{\frown}{6.7} \times 100 = \overset{\frown}{6.70} \times 100 = 670$$

$$\overset{\frown}{4.329} \times 10 = 43.29$$

$$\overset{\frown}{4.329} \times 100 = 432.9$$

The decimal point is moved one place right for each zero in the multiplier,
e.g. to multiply by 10,000 you move the decimal point 4 places.

4 zeros

$$\overset{\frown}{8.25346} \times 10,000 = 82534.6$$

2. Division of a Decimal by 10, 100, 1000, etc.

- To divide a decimal number by 10, move the point one place to the left.
- To divide by 100, move the point two places to the left.
- To divide by 1000, move the point three places to the left.
- Add extra zeros (= noughts), if necessary.

Examples:

$$200 \div 10 = \overset{\frown}{200.0} \div 10 = 20$$

$$\overset{\frown}{27.6} \div 10 = 2.76$$

$$\overset{\frown}{27.6} \div 100 = 0.276$$

$$0.48 \div 100 = \overset{\frown}{000.48} \div 100 = 0.0048$$

The decimal point is moved one place left for each zero in the divisor:

$$\overset{\frown}{43,597.65} \div 10,000 = 4.359765$$

4 zeros

3. Multiplication of a Decimal with a Whole Number

- Work like for ordinary multiplication sum.
- Start at the far right of the decimal point.
- Keep the figures and the decimal points in their correct columns.
- Check that you have the same number of decimal places in the answer as you have in the numbers you are multiplying.

Example:

Multiply 468.25 by 3

468.25

3

1404.75**4. Multiplication of a Decimal Number by Another Decimal Number**

- Ignore the decimal points while you multiply.
- Count how many decimal places there are altogether in the two numbers you have multiplied.
- Count that number of places from the right in the answer, and put in the point.

Example:

Multiply 2.45 by 3.6

$\underbrace{\quad\quad}$ $\underbrace{\quad}$
 2 places 1 place
 $\underbrace{\quad\quad\quad}$
 altogether there are 3 decimal places

$$\begin{array}{r}
 245 \\
 \underline{36} \\
 7350 \\
 \underline{1470} \\
 8820 \\
 \underbrace{\quad\quad\quad} \\
 3 \text{ decimal places in the answer}
 \end{array}$$
5. Division of a Decimal Number by a Whole Number

- Work like for an ordinary division.
- Keep the figures and the decimal points in their correct columns.
- Extra zeros may be added after the decimal figures of the dividend.
- You will sometimes be able to get an exact answer, but sometimes you may only work to two or three decimal places.

Example:

Divide 26.1 (= dividend) by 6 (= divisor)

$$\begin{array}{r}
 04.35 \\
 6 \overline{) 26.10}
 \end{array}$$

$$\begin{array}{r} 24 \\ 21 \\ \hline 18 \\ 30 \end{array}$$

6. Division of a Decimal Number by a Decimal Number

- First turn the divisor into a whole number by moving the decimal point the necessary number of places to the right.
- Move the decimal point of the dividend the same number of places in the same direction. (If you multiply the dividend and the divisor by the same amount, the answer will still be the same:

Example: $\frac{30}{10} = \frac{300}{100} = 3$

- Then work out the division in the ordinary way.

Example:

Divide 2.367 (= dividend) by 0.46 (= divisor)

$$\begin{array}{l} 2.367 \\ 0.46 \end{array} \begin{array}{l} \text{becomes } 236.7 \\ \text{becomes } 46 \end{array} \left. \vphantom{\begin{array}{l} 2.367 \\ 0.46 \end{array}} \right] \begin{array}{l} \text{both have been} \\ \text{multiplied by } 100 \end{array} \quad \left(\text{or } \frac{2.367}{0.46} = \frac{236.7}{46} \right)$$

$$\begin{array}{r} 5.145 \\ 46 \overline{) 236.700} \\ \underline{230} \\ 6.7 \\ \underline{4.6} \\ 2.10 \\ \underline{1.84} \\ .260 \\ \underline{.230} \\ .030 \\ \dots \end{array}$$

D) Rounding Up and Down

When looking for the nearest whole number:

- Ignore anything less than half.
- Count half or more as another whole number.

Examples:

357.1 → 357

357.4 → 357

357.5 → 358

357.9 → 358

When looking for a certain number of decimal places:

- Look at the following decimal place.
- If the last figure is less than 5, ignore it.
- If it is 5 or more, add 1 to the previous figure.

Examples:

4.213 → 4.21

4.214 → 4.21

4.215 → 4.2 2

4.219 → 4.2 2

4.295 → 4.3 0

E) Avoiding Mistakes

Keep to the following discipline to avoid mistakes:

- Always use enough space for calculations. Squeezing them onto a small piece of paper leads to mistakes.
- Always write clearly.
- Calculate each addition and subtraction twice before you proceed to use the answer. This will help avoid wasting time searching for mistakes later on.
- Don't let yourself get a ridiculous answer! Before you work out a problem in detail, you can make a rough estimate of what the answer should be. If your answer is very different, you will know you have made a mistake. A rough estimate is not a guess. You simplify the figures so that you know the answer cannot be more than a certain amount, or less than a certain amount. Therefore, the right answer must lie between them.

Examples:

$$\begin{array}{l} 2 \quad \times 15 = 30 \\ 3 \quad \times 15 = 45 \end{array} \left. \vphantom{\begin{array}{l} 2 \\ 3 \end{array}} \right\} \begin{array}{l} \text{The answer must be} \\ \text{between 30 and 45.} \end{array}$$

$$2.73 \times 15 = 40.95 \checkmark$$

5.2 Percent Calculations

“Per cent” (= %) means “out of each hundred”.
 “ % “ can be replaced by “ $\times \frac{1}{100}$ “ or by “ $\times 0.01$ “.

The percentage is a certain part of a whole. % indicates the proportion of the part to the whole. For comparison 100 is used as a convenient standard.

Example:

$$5\% = 5 \times \frac{1}{100} = \frac{5}{100} = \frac{1}{20} = 0.05; \text{ or conversion back :}$$

$$\frac{1}{20} = 0.05 = 0.05 \times 100\% = 5\%$$

A) Equivalent

The size of each part of a whole can be expressed in four different ways. Watch out for these equivalents:

No.	Expression	Conversion
1.	in words	
2.	as a fraction	fraction $\times 100 \rightarrow \%$
3.	as a decimal	decimal $\times 100 \rightarrow \%$
4.	as a percentage of the whole	$\% \div 100 \rightarrow$ fraction or decimal

Parts of a whole

in words	fraction	decimal	percentage	drawing
the whole	1	1.00	$\frac{100}{100} = 100\%$	
three quarter	$\frac{3}{4}$	0.75	$\frac{75}{100} = 75\%$	
one half	$\frac{1}{2}$	0.50	$\frac{50}{100} = 50\%$	
a third	$\frac{1}{3}$	0.33	$\frac{33}{100} = 33\%$	
a quarter	$\frac{1}{4}$	0.25	$\frac{25}{100} = 25\%$	
a fifth	$\frac{1}{5}$	0.20	$\frac{20}{100} = 20\%$	

a tenths	$\frac{1}{10}$	0.10	$\frac{10}{100} = 10\%$	<input type="checkbox"/>
a twentieth	$\frac{1}{20}$	0.05	$\frac{5}{100} = 5\%$	<input type="checkbox"/>
a hundredth	$\frac{1}{100}$	0.01	$\frac{1}{100} = 1\%$	

B) Basic Operations

There are two basic operations:

1. Operation

Calculate a certain percentage of a given number (= whole).

To find the percentage of a given number, write the percentage as a fraction (with the denominator 100) and multiply it by the number. Simplify by cancelling, if possible.

$$\text{part} = \frac{\text{percentage}}{100} \times \text{whole}$$

Example 1:

Your salary of £S 120.000 shall be raised by 157% at the beginning of the year. What will be your new salary?

given: salary £S 120 = 100% (= whole)

asked: 15% of £S 120 =? (= part)

$$15\% \text{ of } \text{£S } 120 = \frac{15}{100} \times \text{£S } 120 = \text{£S } 18$$

old salary **£S 120**

15% increase **£S 18**

new salary **£S 138**

Example 2:

The costs estimated for a double compost latrine of a school are £S 9500. 5% shall be added for supervision and depreciation of equipment. How much will be the total costs?

given: building costs £S 9500 = 100% (= whole)

asked: 5% of £S 9500 =? (= part)

$$5\% \text{ of } \pounds 9500 = \frac{5}{100} \times \pounds 9500 = \pounds 475$$

building costs **£S 9500**

5% supervision **£S 475**

total costs **£S 9975**

2. Operation

Calculate what percentage one number (=part) is of another number (=whole).

In order to find what percentage one number (= part) is of another number (= whole), we divide the part by the whole and multiply by 100. Thus you obtain a result in %.

$$\text{percentage of a part of a whole} = \frac{\text{part}}{\text{whole}} \times 100$$

Example 1:

During one month the project car was driven 255 km for CD-department, 510 km for WS-department and 315 km for Administration, total 1080 km. How many % did each department drive?

given: total 1080 km = 100% (= whole)

asked: 255 km (=part) =? % of 1080 km

510 km (=part) =? % of 1080 km

315 km (=part) =? % of 1080 km

$$\text{CD: } \frac{255\text{km}}{1080\text{km}} \times 100 = 23.6\%$$

$$\text{WS: } \frac{510\text{km}}{1080\text{km}} \times 100 = 47.2\%$$

$$\text{Adm.: } \frac{315\text{km}}{1080\text{km}} \times 100 = 29.2\%$$

100.0%

(Check if the sum of all percentages is 100%!!)

Example 2:

The total costs of a well were £S 8700. £S 3900 were contributed by the community, £S 4800 by the project. How many % did the community contribute, and

how many % the project?

given: total costs £S 8700 = 100% (= whole)

asked: £S 3900 (= part) =? % of £S 8700

£S 4800 (= part) =? % of £S 8700

community: $\frac{£S 3900}{£S 8700} \times 100 = 44.8\%$

project: $\frac{£S 4800}{£S 8700} \times 100 = 55.2\%$

100.0%

5.3 Measurements

The most important and common measurements for water supply work are compiled here in transformation tables.

A) Measurements for Distances in Metric System

		to these:				
		mm	cm	dm	m	km
If you want to change these units:	mm		÷ 10	÷ 100	÷ 1,000	÷ 1,000,000
	cm	× 10		÷ 10	÷ 100	÷ 100,000
	dm	× 100	× 10		÷ 10	÷ 10,000
	m	× 1,000	× 100	× 10		÷ 1,000
	km	× 1,000,000	× 100,000	× 10,000	× 1,000	

mm = millimetre

cm = centimetre

dm = decimetre

m = metre

km = kilometre

Using transformation tables you can change from one unit to another. Use them as follows:

Example:

435 m =? km

You want to transform the unit "m" to "km". Look in the left column for "m" and along the top row for "km". You find the necessary operation for transformation where the column of "km" meets the row of "m": $\div 1,000$

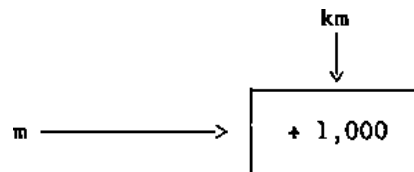

Therefore divide 435 by 1,000.

$$435 \text{ m} = (435 \div 1,000) \text{ km} = 0.435 \text{ km}$$

B) Measurements for Distances in English System

		to these:				
		1/16 "	"	'	yd	mile
If you want to change these units:	1/16 "		$\div 16$	$\div 192$	$\div 576$	$\div 1,013,760$
	"	$\times 16$		$\div 12$	$\div 36$	$\div 63,360$
	'	$\times 192$	$\times 12$		$\div 3$	$\div 5,280$
	yd	$\times 576$	$\times 36$	$\times 3$		$\div 1,760$
	mile	$\times 1,013,760$	$\times 63,360$	$\times 5,280$	$\times 1,760$	

1/16 " = one sixteenths inch

" = inch

' = foot

yd = yard

mile = mile

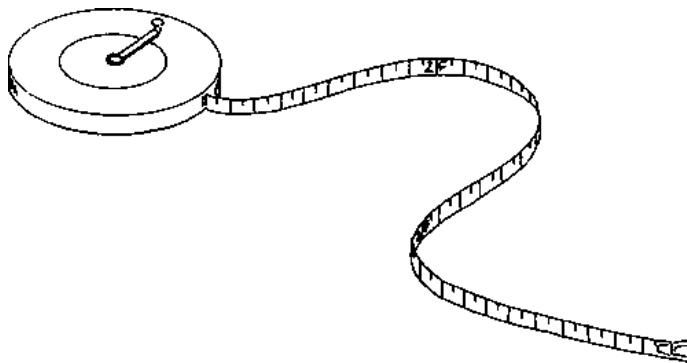

C) Measurements for Distances: Transformations between Metric and English System

		to these:						
		cm	"	'	yd	m	km	mile
If you want to change these units:	cm		÷ 2.54	÷ 30.48	÷ 91.44	÷ 100		
	"	× 2.54		÷ 12	÷ 36	÷ 39.37		
	'	× 30.48	× 12		÷ 3	÷ 3.28		
	yd	× 91.44	× 36	× 3		÷ 1.09		
	m	× 100	× 39.37	× 3.2808	× 1.0936		÷ 1,000	÷ 1,609
	km					× 1,000		÷ 1.609
	mile					× 1,609	× 1.609	

- cm = centimetre
- " = inch
- ' = foot
- yd = yard
- m = metre
- km = kilometre
- mile = statute mile



D) Measurements for Areas in Metric System

		to these:		
		cm ²	dm ²	m ²
If you want to change these units:	cm ²		÷ 100	÷ 10 000

If you want to change these units:	cm²	× 100		÷ 100
	m²	× 10,000	× 100	

cm² = square centimetre

dm² = square decimetre

m² = square metre

E) Measurements of Volumes

		to these:				
		cm³ = ml	dm³ = lit	gal	drum	m³
If you want to change these units:	cm³		÷ 1,000	÷ 4,550	÷ 220,000	÷ 1,000,000
	dm³	× 1,000		÷ 4.55	÷ 220	÷ 1,000
	gal	× 4,550	× 4.55		÷ 48.4	÷ 220
	drum	× 220,000	× 220	× 48.4		÷ 4.55
	m³	× 1,000,000	× 1,000	× 220	× 4.55	

cm³ = cubic centimetre = ml = millilitre

dm³ = cubic decimetre = ℓ = lit = litre

gal = gallon (imperial)

drum = drum

m³ = cubic metre

For transformation of measurements of pumping rates (= yields = discharge = volume/time) see 8.34/1.

F) Measurements for Time

		to these:			
		sec	min	h	days
If you want to change these units:	sec		÷ 60	÷ 3,600	÷ 86,400

	min	× 60		÷ 60	÷ 1,440
	h	× 3,600	× 60		÷ 24
	days	× 86,400	× 1,440	× 24	

sec = second

min = minute

h = hour

days = days

G) Measurements for Weights

		to these:			
		mg	g	kg	t
If you want to change these units:	mg		÷ 1,000	÷ 1,000,000	÷ 1,000,000,000
	g	× 1,000		÷ 1,000	÷ 1,000,000
	kg	× 1,000,000	× 1,000		÷ 1,000
	t	× 1,000,000,000	× 1,000,000	× 1,000	

mg = milligram

g = gram

kg = kilogram

t = tonne = metric ton

H) Measurements for Temperatures

Conversion formulas:

$$^{\circ}\text{F} = \frac{9}{5}^{\circ}\text{C} + 32 \quad ^{\circ}\text{F} = \text{degree Fahrenheit}$$

$$^{\circ}\text{C} = (^{\circ}\text{F} - 32) \times \frac{5}{9} \quad ^{\circ}\text{C} = \text{degree Celsius}$$

Conversion table (approximate):

°C	°F
----	----

-18	0
-10	14
0	32
10	50
20	68
30	86
40	104
50	122
60	140
70	158
80	176
90	194
100	212

°F	°C
0	- 17.8
10	- 12.2
20	- 6.7
30	- 1.1
32	0
40	4.4
50	10
60	15.6
70	21.1
80	26.7
90	32.2
100	37.8

110	43.3
120	48.9
130	54.4
140	60
150	65.6
160	71.1
170	76.7
180	82.2
190	87.8
200	93.3
210	98.9
212	100

Conversion scale:

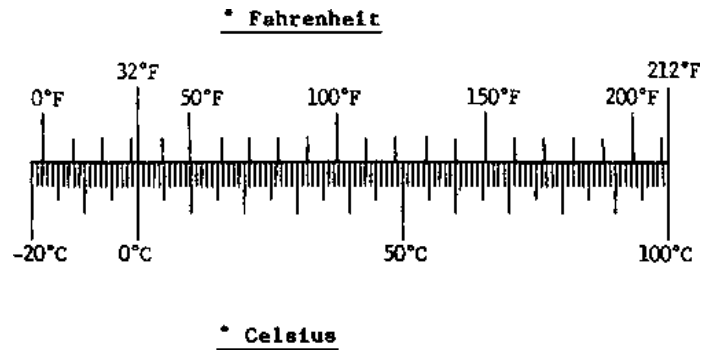

5.4 Basic Geometry

The most basic terms and definitions of geometry necessary for technical work are compiled here:

A) Point

or ×

A point is a very small area. For example the crossing of 2 straight lines is a point.

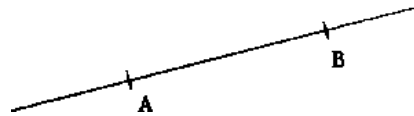
B) Straight Line

A straight line is indefinitely long and indefinitely thin. Any 3 points on the line mark a 180° angle. Two points define a straight line. A straight line is the shortest distance between 2 points.

Examples for straight lines:

- the edge of a table
- a measuring tape
- the string of a plumb bob

C) Plane

A plane is indefinitely long and broad and indefinitely thin. Straight lines can be fitted into the plane in any direction. Three points define a plane.

Examples for planes:

- a piece of paper
- the straight surface of a table
- the surface of a lake

D) Angle

An angle is formed between two intersecting lines.

The angle between the lines AB and BC is called $\angle ABC$.

$\angle ABC$ is the rotation required to turn the line AB on to the line BC: the centre of the rotation is point B.

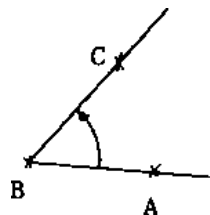

If AB is rotated about point B, each point on the line describes a circle. An angle is measured in degrees

If **AB** is rotated about point **B**, each point on the line describes a circle. An angle is measured in degrees.

The complete rotation is 360°.

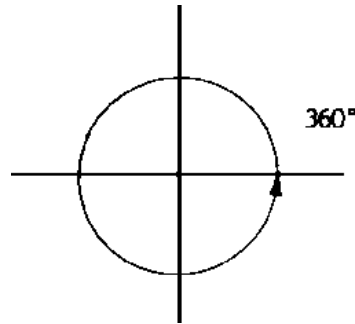

One degree is $\frac{1}{360}$ of a complete rotation.

Examples for angles:

- the angles between trusses of a roof

$\frac{3}{4}$ of a complete rotation is 270°.

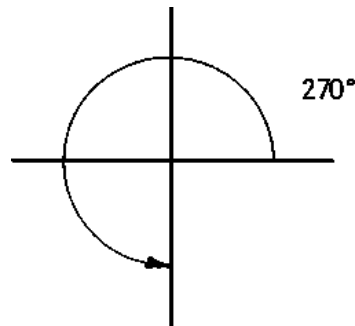

$\frac{1}{2}$ of a complete rotation is 180°.

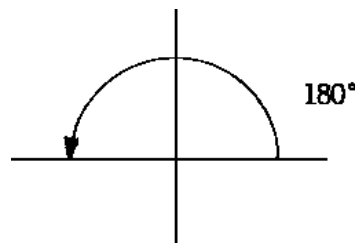

$\frac{1}{4}$ of a complete rotation is 90° ; this is known as "right angle".

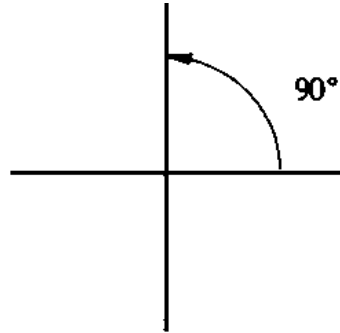

Examples for right angles:

- the corner of a table
- the corner of a window
- the corner of a house
- the corner of a sheet of paper
- the corner of a latrine slab

E) Parallel Lines

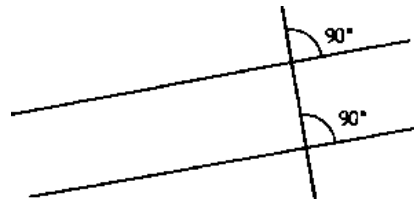

Parallel lines are lines which never meet. They always remain the same distance apart, no matter how far they are extended.

Examples for parallel lines:

- two opposite sides of a table
- two opposite edges of sawn timber

- two opposite edges of a sheet of paper
- railway tracks
- two legs of a ladder

F) Symmetry about an Axis

Shapes in a plane are symmetric about an axis (= straight line) if folded about that axis, one half can be superimposed on the other. Each part has a corresponding part the same distance from the axis of symmetry.

Examples for symmetry about an axis:

- a sheet of paper
- a rectangle
- a circle
- a blackboard
- the surface of a table

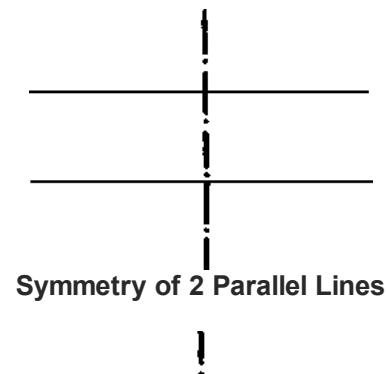
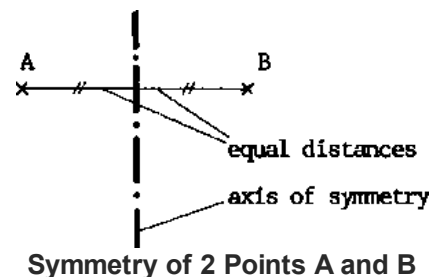



Symmetry of 2 Parallel Lines

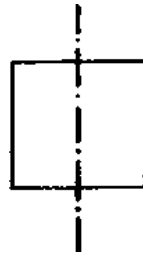

Symmetry of Square

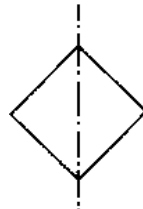

Symmetry of Square

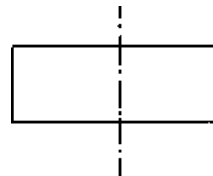

Symmetry of Rectangle

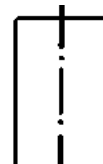



Symmetry of Rectangle

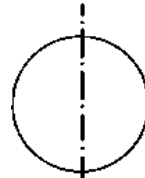

Symmetry of Circle

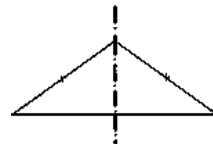

Symmetry of Equilateral Triangle

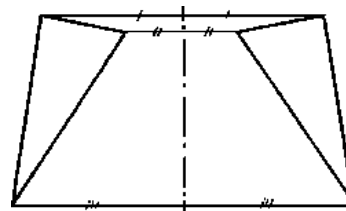

Symmetry of 2 Triangles



Symmetry of 2 Irregular Shapes

G) Symmetry about a Plane

3-dimensional solids are symmetric about a plane if each part has a corresponding part the same distance from the plane of symmetry. That means that

3- dimensional solids are symmetric about a plane if each part has a corresponding part the same distance from the plane of symmetry. That means that they can be divided (= cut) into two equal, exactly similar parts.

Examples for symmetry about a plane:

- rectangular solids
- cylinder
- screwdriver
- hammer
- shovel

- pipe
- fruits like papaya

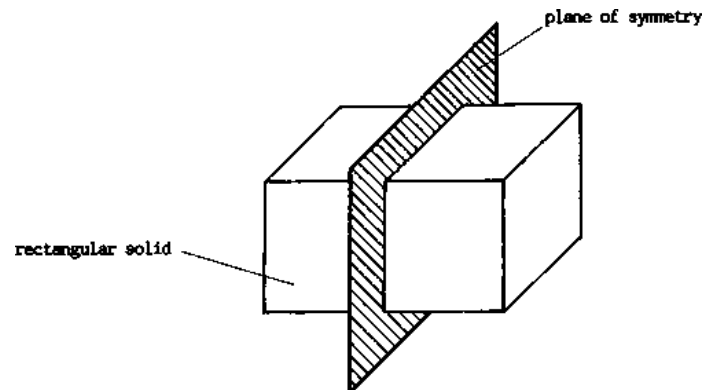

H) Rotational Symmetry about an Axis

3-dimensional rotational symmetric shapes can be produced by rotating any plane shape around an axis. They can be turned around their axis and always look the same.

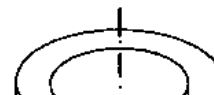
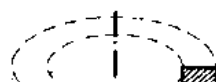

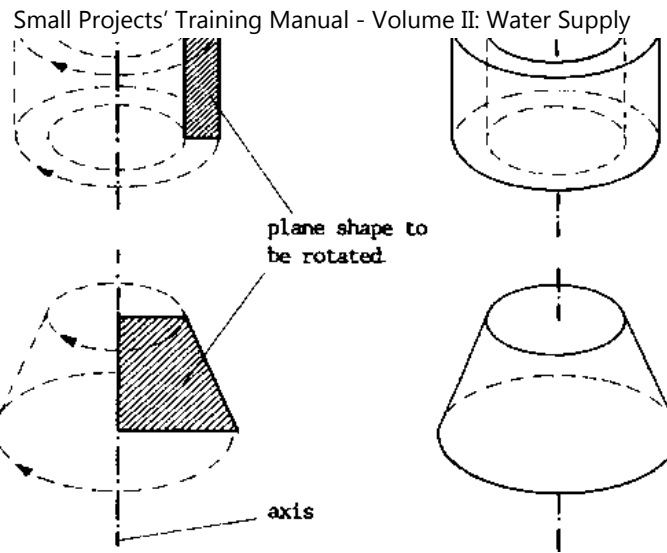

Rotational symmetric items are symmetric about any plane through the axis (that are indefinitely many planes of symmetry). Any plane vertical to the axis cuts the rotational symmetric shape in a circle.

Examples for rotational symmetry:

- pipes
- wooden items produced by lathing
- clay pots produced on a potter's wheel
- bowls

- bottles
- nails
- concrete rings
- tyres

1) Triangle

Three points connected with straight lines form a triangle.

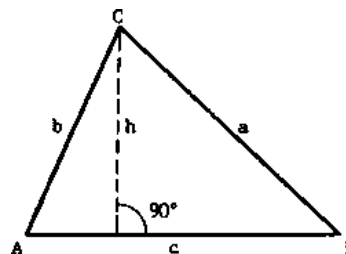

Area:	$A = \frac{1}{2}hc$
Perimeter:	$P = a + b + c$

J) Quadrilateral

Four points connected with straight lines form a quadrilateral. It is also called polygon of 4 sides.

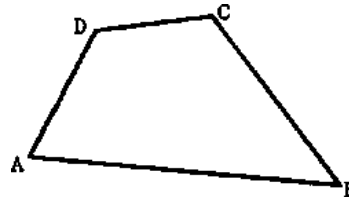
**K) Parallelogram**

A parallelogram is a quadrilateral with both pairs of opposite sides parallel and equal in length.

Connections:	$a \parallel c$
	$b \parallel d$
	$a = c$
	$b = d$
Area:	$A = a h$
Perimeter:	$P = 2(a+b) = 2(c+d)$

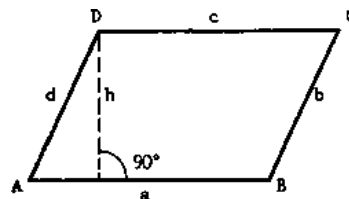
**L) Rectangle**

A rectangle is a parallelogram with right angles. A rectangle is symmetric about 2 axis. The diagonal is the connection of two opposite corners by a straight line.

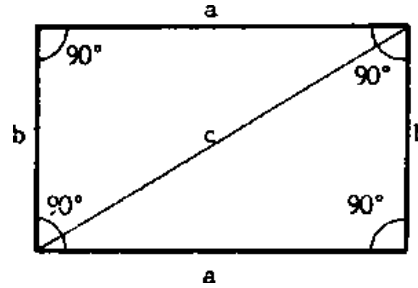

Connections:	all four angles: 90°
Area:	A = a b
Perimeter:	P = 2(a+b)
Diagonal:	$c = \sqrt{a^2 + b^2}$

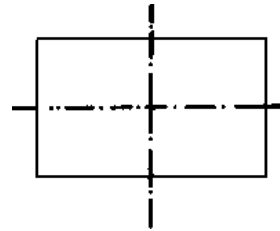

Examples for rectangles:

- sheet of paper
- blackboard
- door
- latrine slabs

M) Square

A square is a rectangle with all sides equal. A square is symmetric about 4 axis.

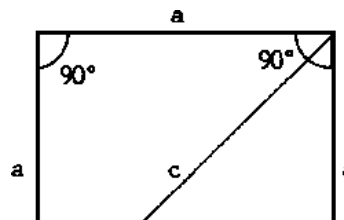

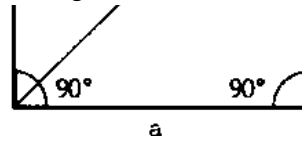

Area:	$A = a^2$
Perimeter:	$P = 4 a$
Diagonal:	$c = \sqrt{2 a^2}$

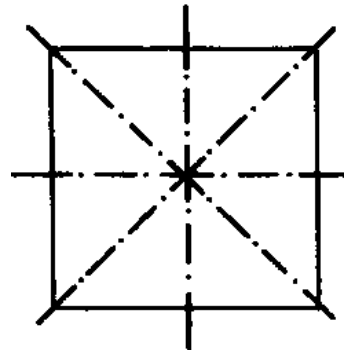

Examples for squares:

- childrens' squatting slab
- manhole in well cover

N) Circle

Points in a plane with the same distance from a fixed point form the circumference of a circle. The fixed point is called the centre of the circle, the constant distance the radius. A straight line through the centre is called the diameter.

A circle is symmetric about all straight lines through the centre.

Radius:	$r = \frac{d}{2}$
Diameter:	$d = 2 r$
Circumference:	$C = 2 \pi r$

Area:	$A = \pi r^2 = \frac{1}{4} \pi d^2$
	$\pi = 3.14$

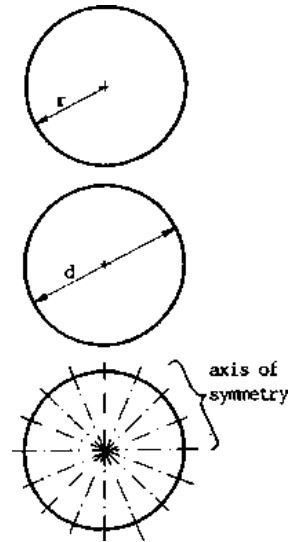

0) Hollow Circle

Two circles with the same centre form a hollow circle.

A hollow circle is symmetric about all straight lines through the centre.

Inside radius:	r	
Outside radius:	R	
Inside Diameter:	d	
Outside Diameter:	D	
Area:	A = $\pi (R^2 - r^2)$	
	$= \frac{1}{4} \pi (D^2 - d^2)$	
	= $\pi (R + r)(R - r)$	



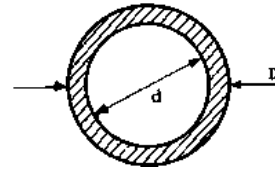
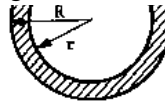

Examples for hollow circles:

- washers
- rubber seatings

P) Cylinder

A rectangle rotating around its axis forms a cylinder. A cylinder has the same circle as base and top. A cylinder is rotational symmetric.

Radius:	r
Diameter:	$d = 2 r$
Height or length:	h or l
Volumes:	$V = \pi r^2 h$
Total surface area:	$SA = 2 \pi r h + 2 \pi r^2$

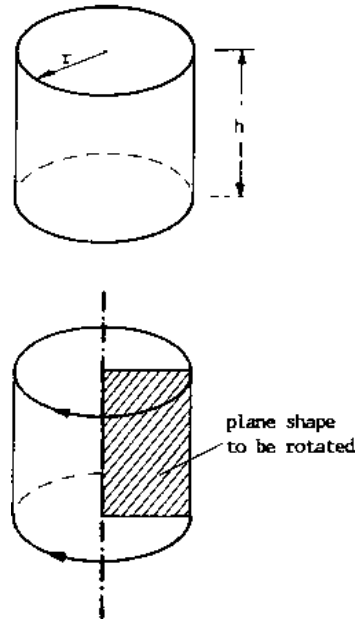

Examples for cylinders:

- reinforcement rod
- tins
- poles
- axles

Q) Hollow Cylinder

Two cylinders with the same centre form a hollow cylinder. A hollow cylinder is rotational symmetric.

Inside radius:	r
Outside radius:	R
Inside diameter:	$d (= ID)$
Outside diameter:	$D (= OD)$
Height or length:	h or l
Volume:	$V = \pi (R^2 - r^2) h$

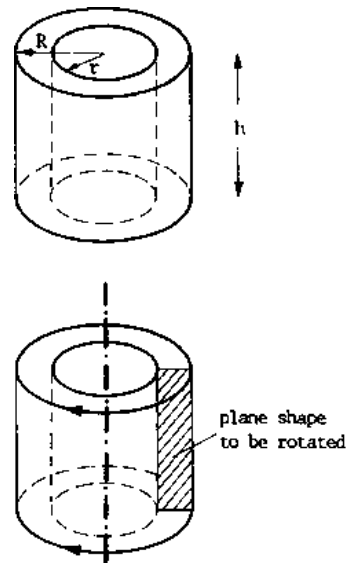

Examples for hollow cylinders:

- pipes
- concrete rings

R) Rectangular Solid (= Cuboid)

A rectangular solid is a solid confined by 6 rectangles. It is symmetric about 3 planes.

Volume:	$V = a b c$
Total surface area:	$SA = 2(ab+ac+cb)$

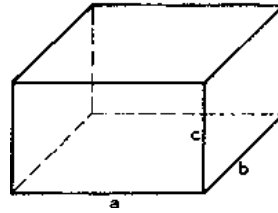

Examples for rectangular solids:

- sawn timber
- box

S) Cube

A cube is a special case of a cuboid. All its sides are equal.

Volume:	$V = \ell^3$
Total surface area:	$SA = 6 \ell^2$

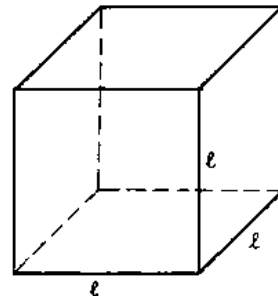

T) Sphere (= Ball)

A sphere is a 3-dimensional body. All its points have the same distance from a fixed point which is the centre. It is rotational symmetric about any axis through the centre.

Volume:	$V = \frac{4}{3} \pi R^3$
Surface area:	$SA = 4 \pi R^2$

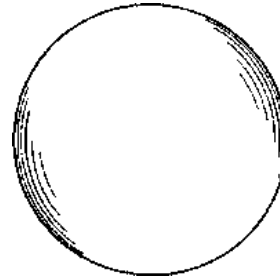

Examples for spheres:

- ball
- ball bearings

5.5 Calculation of Diagonal

For marking a rectangular layout plan (rectangle), we need to know the diagonal. It can be calculated in the following way:

given: 2 sides of a rectangle, a and b

asked: diagonal c

According to Pythagoras theorem, in a right angled triangle the square on the hypotenuse (= longest side) is equal to the sum of the squares on the two other sides.

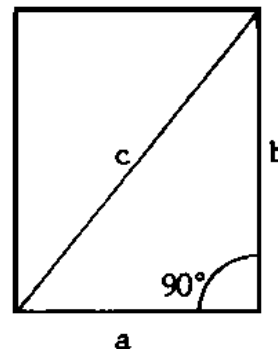

$a^2 + b^2 = c^2$

Steps of Calculation

1. Calculate a^2 .
2. Calculate b^2 .
3. Add up $a^2 + b^2$.
4. Estimate c. Calculate c^2 . Compare c^2 with $a^2 + b^2$.
5. Make a new and better estimation for c. Calculate c^2 . Compare c^2 with $a^2 + b^2$.
6. Repeat step No.5 until you have a value for c exact enough.

Draw the rectangle and check if the calculated value for c is correct.

Alternatively, you can calculate $c = \sqrt{a^2 + b^2}$.

Example:

given: rectangle with the sides 2.30 m and 3.50 m

asked diagonal

1. $a = 2.30$	→	a^2	=	5.29		
2. $b = 3.50$	→	b^2	=	12.25		
3.		$a^2 + b^2$	=	17.54		
4. $c \stackrel{?}{=} 4$	→	4^2	=	16	→	4 is too small
		$c \stackrel{?}{=} 5$	→	$5^2 = 25$	→	5 is too large
						} → try a number between 4 and 5
5. $c \stackrel{?}{=} 4.2$	→	4.2^2	=	17.64	→	4.2 is too large
		$c \stackrel{?}{=} 4.1$	→	$4.1^2 = 16.81$	→	4.1 is too small
						} → try a number between 4.1 and 4.2
		$c \stackrel{?}{=} 4.18$	→	$4.18^2 = 17.47$		
		$c \stackrel{?}{=} 4.19$	→	$4.19^2 = 17.556 \approx 17.54$		
6. $c = \underline{\underline{4.19}}$						
	m					

7.

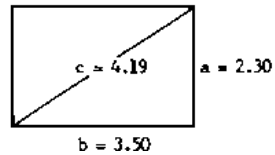

Scale 1:100

5.6 Calculation of Volumes

The volume of a solid is the amount of space it occupies. It can be expressed in cm^3 , $\text{dm}^3 = \text{lit} = \text{litre}$, $\text{gal} = \text{gallon}$, drum or m^3 . The transformation table for changing these units is found at 5.3/4.

The volume of a rectangular solid (= cuboid) and of a cylinder and of a hollow cylinder (= tube) are the three most important ones for technical purposes (see also 5.4/9-10). Their calculation is shown here with examples.

A) Volume of a Rectangular Solid (= Cuboid)

volume of a cuboid = length \times breadth \times height

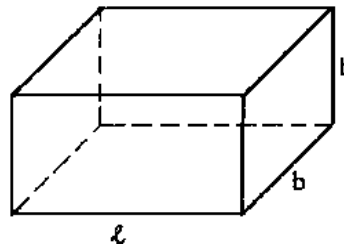

$V = l \times b \times h$

Take care to multiply only figures with the same units!

Example:

A water tank is 1.50 m long and 1.20 m broad and 80 cm high. How much water can it hold?

given: $l = 1.50 \text{ m}$, $b = 1.20 \text{ m}$, $h = 80 \text{ cm}$

asked: volume

$h = 80 \text{ cm} = 0.80 \text{ m}$

(The units of length are not the same, therefore we have to change them.)

$V = l \times b \times h = 1.50 \text{ m} \times 1.20 \text{ m} \times 0.80 \text{ m} =$

$$\begin{aligned}
 &= \underline{1.44 \text{ m}^3} \\
 &= 1.44 \times 1,000 \text{ lit} = \underline{1,440 \text{ lit}} \\
 &= \frac{1440}{4.55} \text{ gal} = \underline{316.5 \text{ gal}} \text{ (for transformation see 5.3/4)} \\
 &= \frac{1440}{220} \text{ drums} = \underline{6.55 \text{ drums}} \text{ (for transformation see 5.3/4)}
 \end{aligned}$$

B) Volume of a Cylinder

volume of a cylinder = $\pi \times (\text{radius})^2 \times \text{height}$

$$V = \pi \times r^2 \times h \quad \pi = 3.14$$

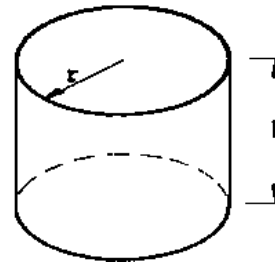

Example:

The inside diameter of a concrete ring is 1.20 m, the height is 92 cm. How much water can be stored inside the concrete ring?

given: $d = 1.20 \text{ m}$, $h = 92 \text{ cm}$

asked: volume

$h = 92 \text{ cm} = 0.92 \text{ m}$

$r = d \div 2 = 1.20 \text{ m} \div 2 = 0.60 \text{ m}$

$V = \pi \times r^2 \times h = 3.14 \times (0.60 \text{ m})^2 \times 0.92 \text{ m} = \underline{1.0399 \text{ m}^3}$

$= 1.0399 \times 1,000 \text{ lit} = \underline{1040 \text{ lit}}$

$= \frac{1040}{4.55} \text{ gal} = \underline{228.5 \text{ gal}}$ (for transformation see 5.3/4)

$= \frac{1040}{220} \text{ drums} = \underline{4.7 \text{ drums}}$ (for transformation see 5.3/4)

C) Volume of a Hollow Cylinder (= Tube)

$\text{volume of a hollow cylinder} = \pi \times [(\text{outside radius})^2 - (\text{inside radius})^2] \times \text{height}$

$V = \pi \times [R^2 - r^2] \times h$

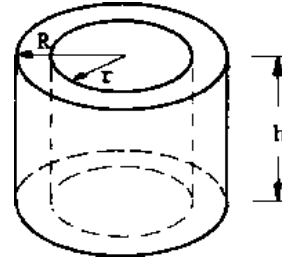
Example:

The outside diameter of a concrete ring is 1.40 m, the inside diameter 1.20 m, the height is 92 cm. How many liters of concrete are needed to cast this ring?

given: $D = 1.40 \text{ m}$, $d = 1.20 \text{ m}$, $h = 92 \text{ cm}$

asked: volume

$h = 92 \text{ cm} = 0.92 \text{ m}$

$R = D \div 2 = 1.40 \text{ m} \div 2 = 0.70 \text{ m}$

$r = d \div 2 = 1.20 \text{ m} \div 2 = 0.60 \text{ m}$

$V = \pi \times [R^2 - r^2] \times h = 3.14 \times [(0.70 \text{ m})^2 - (0.60 \text{ m})^2] \times 0.92 \text{ m} =$

$= 3.14 \times [0.49 - 0.36] \times 0.92 = \underline{0.3755 \text{ m}^3} = \underline{375.5 \text{ lit}}$

5.7 Calculation of Weights

It is important to learn to calculate the weight of simple items like concrete rings, timber, water, etc., in order to know if they can be lifted by the available equipment or by the number of people present and transported by the available car.

The weight of a homogenous item (= an item consisting of one material throughout) is calculated as follows:

weight	= density	× volume
W [kg]	= d [kg/dm ³]	× V [dm ³]
W [t]	= d [t/m ³]	× V [m ³]

The density is the weight of one dm^3 (=1 lit = one litre) of a certain material.

It can be expressed in kg/dm^3 or t/m^3 . You must multiply the unit of density by the appropriate unit of volume, e.g. $\text{kg}/\text{dm}^3 \times \text{dm}^3$ or $\text{t}/\text{m}^3 \times \text{m}^3$.

The most important densities are (in approximate values):

steel	8	$[\text{kg}/\text{dm}^3 = \text{t}/\text{m}^3]$
concrete	2.5	$[\text{kg}/\text{dm}^3 = \text{t}/\text{m}^3]$
water	1	$[\text{kg}/\text{dm}^3 = \text{t}/\text{m}^3]$
timber, hardwood	0.7	$[\text{kg}/\text{dm}^3 = \text{t}/\text{m}^3]$
timber, softwood	0.55	$[\text{kg}/\text{dm}^3 = \text{t}/\text{m}^3]$

Any item floating on water has a density smaller than 1, any item which sinks in water has a density bigger than 1.

Example 1:

How heavy is the concrete ring of chapter 5.6?

given: $V = 0.3755 \text{ m}^3 = 375.5 \text{ dm}^3 = 375.5 \text{ lit}$

asked: weight

$$W = d \times V = 2.5 \text{ kg}/\text{dm}^3 \times 375.5 \text{ dm}^3 = 938.8 \text{ kg}$$

or:

$$W = d \times V = 2.5 \text{ t}/\text{m}^3 \times 0.3755 \text{ m}^3 = 0.9388 \text{ t}$$

Example 2:

Sawn timber from hardwood is loaded on a lorry in a pile 2.50 m broad, 4.50 m long and 1 m high. How heavy is the load?

given: rectangular solid from hardwood,
 $l = 4.50 \text{ m}$, $b = 2.50 \text{ m}$, $h = 1 \text{ m}$

asked: weight

$$V = l \times b \times h = 4.50 \text{ m} \times 2.50 \text{ m} \times 1 \text{ m} = 11.25 \text{ m}^3$$

$$W = d \times V = 0.7 \text{ t}/\text{m}^3 \times 11.25 \text{ m}^3 = 7.88 \text{ t} = 7880 \text{ kg}$$

This weight needs to be compared with the loading capacity of the lorry. See also 3.13/1.

5.8 Calculation of Time

A) Indication of Time

We start to count the hours of a day at midnight. According to the British way we count the hours from 0.00 to 12.00 which is midday. These hours are marked with a.m. which stands for the latin words "ante meridiem" and means "before noon". After midday the hours are counted from 1.00 to 12.00 which is midnight. These hours are marked with p.m. which stands for "post meridiem" and means "after noon".

According to the international way the hours are counted from midnight 0.00 to midnight 24.00 in one go.

International Time Indication	British Time Indication
0.00	0.00 a.m.
1.00	1.00 a.m.
2.00	2.00 a.m.
.	.
.	.
.	.
12.00	12.00 a.m.
13.00	1.00 p.m.
14.00	2.00 p.m.
15.00	3.00 p.m.
.	.
.	.
.	.
23.00	11.00 p.m.
24.00=0.00	12.00 p.m.

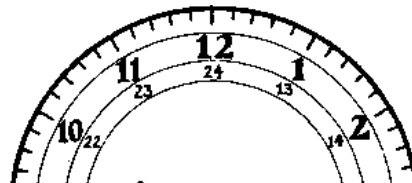

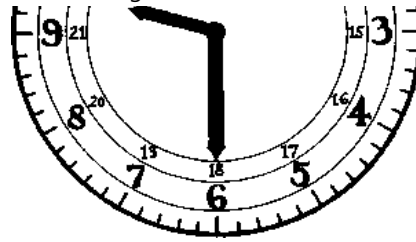

The same indication on the clock can mean two different times and can be expressed in different ways:

No.	Type	Expression	1. Possibility	2. Possibility
1.		on the clock		
2.	international	on a digital watch	09 30	21 30
3.		in figures with point	9.30	21.30
4.		in figures with dash	9 ³⁰	21 ³⁰
5.		in words	nine thirty	twenty-one thirty
6.		in words	half past nine	half past twenty-one
7.	british	in figures with point	9.30 a.m.	9.30 p.m.
8.		in figures with dash	9 ³⁰ a.m.	9 ³⁰ p.m.
9.		in words	half past nine in the morning	half past nine in the evening
10.		in words	nine thirty in the morning	nine thirty in the evening

Full hours can also be expressed like 11 o'clock.

B) Calculation of Periods

Remember:

Indications of time like 9.30 are not decimal numbers!

because an hour has 60 minutes and not 100 hundredth ($= \frac{100}{100}$).

When calculating a period of time:

1. Count the minutes from the starting time to the next full hour.
2. Then count the hours to the full hour before the ending time.

3. Then count the remaining minutes.
4. Add up the times.

Example:

starting time		8.35	
ending time		13.48	
60 min	- 35 min	= 25 min	
13 o'clock	- 9 o'clock	= 4 hours	
48 min	- 0 min	= 48 min	
4 hours	+ (25 + 48) min =		
= 4 hours	+ 73 min =		
= 4 hours	+ 60 min	+ 13 min =	
= 4 hours	+ 1 hour	+13 min =	
= <u>5 hours</u>	+ <u>13 min</u>		

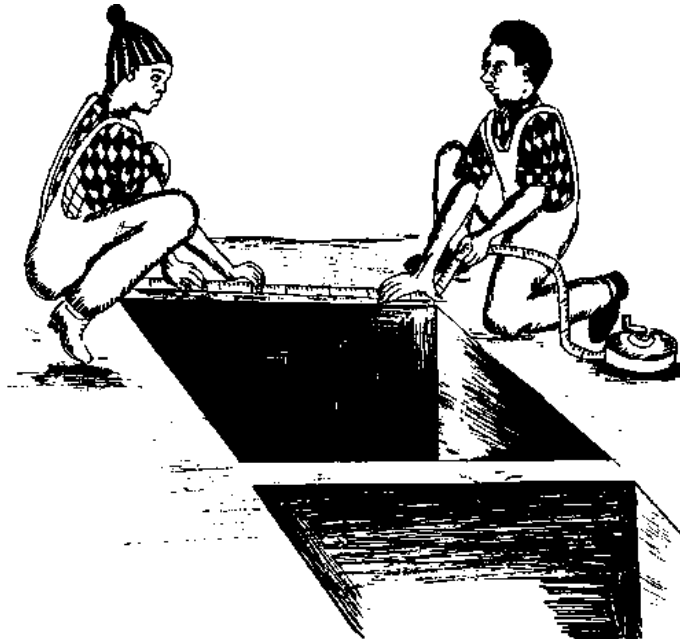
6. Basic Technical Knowledge

01 Basic Technical Drawing

The most basic features of technical drawing are explained in this chapter. Knowledge of these features is necessary in order to enable the technicians to read drawings and manuals. When reading technical drawings, try to identify each line with the corresponding detail on the object. When studying technical drawings, use models or simple objects like a matchbox, a box or a tin, to clarify and to understand the different views. To be able to read technical drawings, you must practise drawing yourself. Practise by drawing objects around you: tools, furniture, houses, wells, latrines. Ask somebody experienced to correct your drawings.

A) Overview of the Different Views

This chapter will explain the following views:

- isometric view,
- cross-section,
- layout plan (= plan),
- front-view (= front elevation),
- side-view (= side elevation),
- exploded diagram, side-view,
- exploded diagram, isometric view,
- cut-away view with hidden inside details.

One view alone does not show the complete information about all details of the object. At least two different views, normally three, sometimes more are necessary to describe all details.

The arrows in the following drawing show from what angle you have to look at a building to obtain the different views. They are explained in the following sections, supplemented by conventions for technical drawing and technical signs.

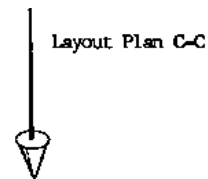

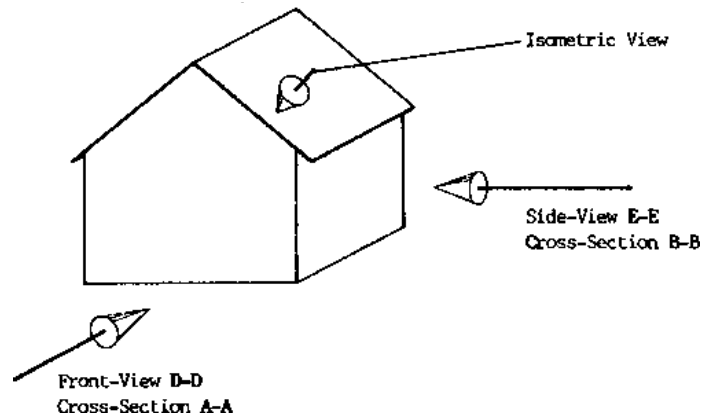

B) Isometric View

The isometric view shows a view comparable to what can be seen with the eye if you look at the object from a particular angle; it resembles what a photograph shows. This way of drawing is used to clarify what the object looks like, but it is not used for plans.

Lines which are parallel in reality also appear parallel in the isometric view (e.g. the sides of the cube). The angles shown in the isometric view are not the same as the angles in reality (e.g. the angles between the sides of the cube are not right angles in the isometric view).

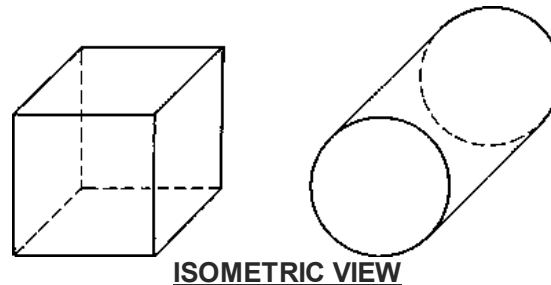

C) Cross-Section A-A

In a cross-section drawing, the object is cut by a plane, usually through windows, into two parts. You look orthogonally to the cutting plane (= vertical to the cutting plane = from the side) and draw what you can see. This is called a cross-section A-A as shown below. A thick chain, with arrows, marked A-A, in the layout plan (see 6.1/5) shows how the building is “cut” to obtain the cross-section A-A. The chain (interrupted at the drawing) shows how to cut, the arrows show in which direction to look, the letters near the tip of the arrows indicate the “name” of the view:

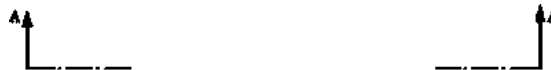

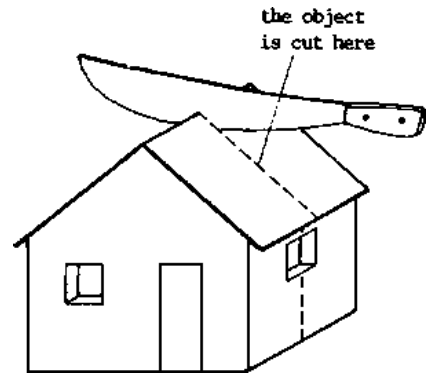

ISOMETRIC VIEW of the whole part

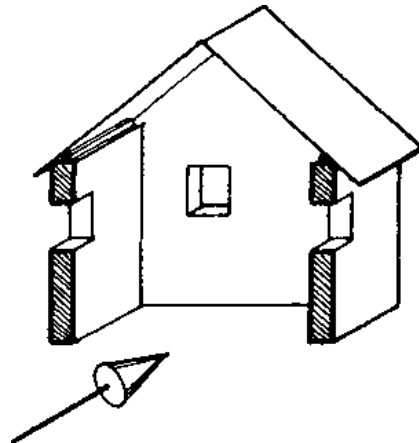

ISOMETRIC VIEW of the remaining part; this is not called "cross-section"!!!

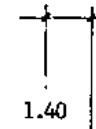
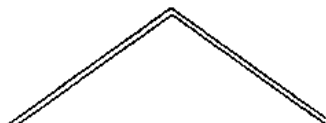

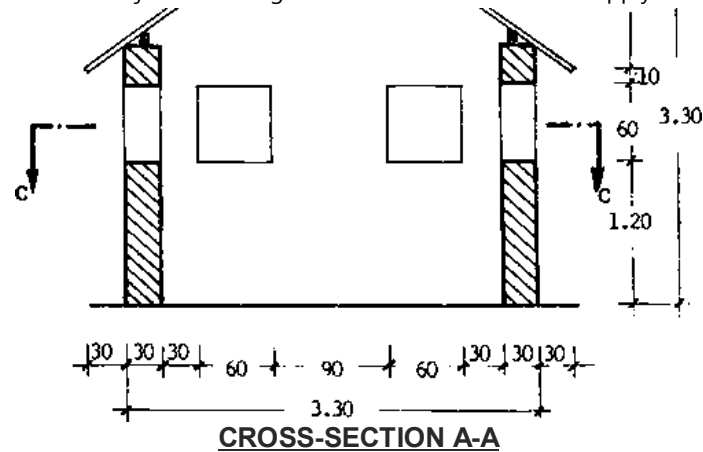

Scale 1:50

The cut parts are drawn with thick lines and are hatched. The dimensions are given outside the cross-section.

In a cross-section, the planes orthogonal (= vertical) to the cutting plane “disappear” and are shown as lines. For example, you see the floor as a line.

All angles, especially right angles, in a cross-section appear as they are in reality. The thick chain with arrows, marked C-C, shows how the building is “cut” to obtain the layout plan C-C (see 6.1/5).

D) Cross-Section B-B

The building can be cut also in the other direction, parallel to the short side. A thick chain with arrows, marked B-B, in the layout plan (see 6.1/5) shows how the building is “cut” to obtain this cross-section. This cross-section B-B is differentiated from the previous one by the capital letters (B-B instead of A-A).

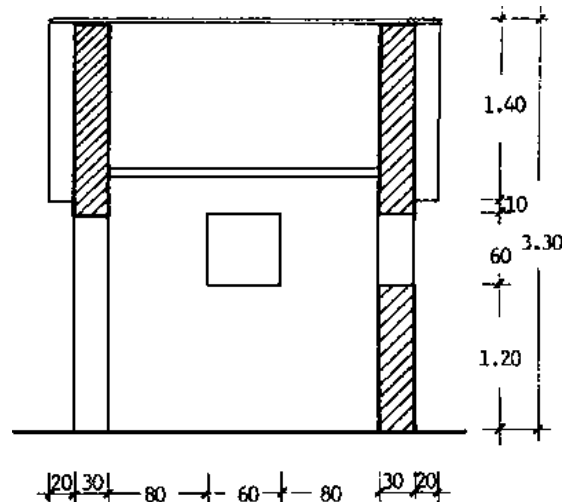

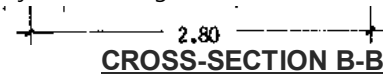

SCALE 1:50

E) Layout Plan C-C (= Plan C-C)

The layout plan is a horizontal “cross-section” (e.g. a house built half way, up to the bottom-half of the windows). You look orthogonally to the cutting plane (= vertically to the cutting plane = from above) and draw what you can see. A thick chain with arrows, marked C-C, in the cross-section shows how the building is “cut” to obtain the layout plan C-C (see 6.1/3).

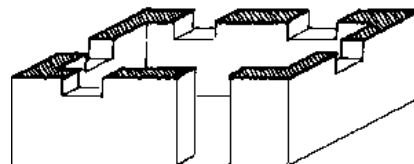
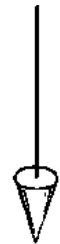
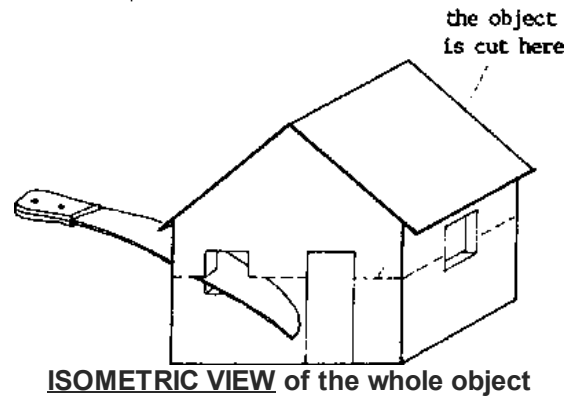

ISOMETRIC VIEW of the bottom half; this is not called “layout plan”!!!



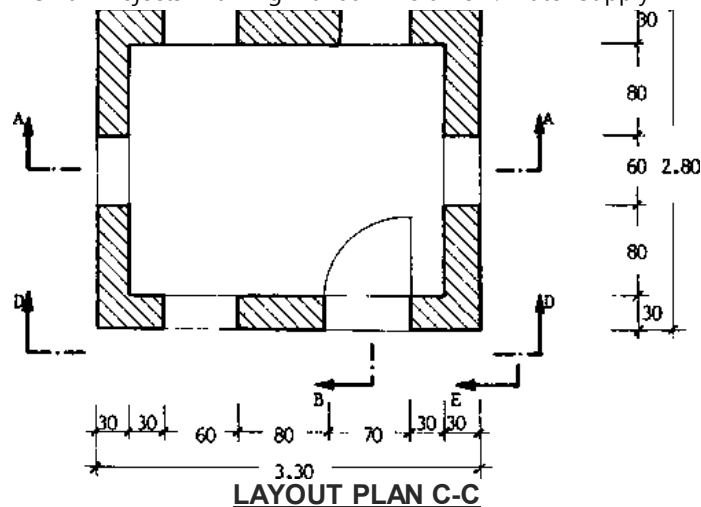

Scale 1:50

The dimensions are given beside the layout plan. In a layout plan, the planes orthogonal to the cutting plane “disappear” and are shown as lines, e.g. all vertical walls. All angles, especially right angles, in a layout plan appear as they are in reality.

The thick chain with arrows, marked A-A, shows how the building is “cut” to obtain the cross-section A-A. The thick chain D-D shows how to obtain the front-view D-D. The views B-B and E-E are indicated in the same way. For some objects it does not make sense to cut them for obtaining the layout plan. In this case, the layout plan is an orthogonal view from above (examples see 6.1/10-15, 17, 18).

F) Front-View D-D (= Front Elevation D-D)

The front-view is an orthogonal view of the object without cutting. A thick chain with arrows, marked D-D in the layout plan (see 6.1/5) shows how to look at the building to obtain the front-view D-D. Hidden lines are sharp edges within the object, but they cannot be seen from outside. They can be shown by dashes. However, avoid showing too many hidden details for the sake of clarity.

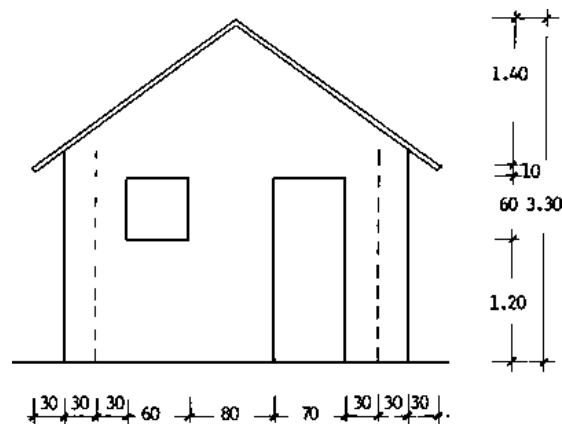

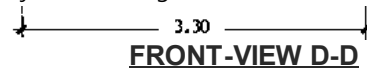

Scale 1:50

The dimensions are given beside the front-view.

In a front-view, the planes orthogonal to the cutting plane “disappear” and are shown as lines (e.g. the outside wall on the short side of the building).

All angles, especially right angles, in a front-view appear as they are in reality.

G) Side-view E-E (= Side Elevation E-E)

The side-view is an orthogonal view of the object without cutting, similar to the front-view. You have to decide which of them to call front-view and which side-view. Usually, the view at the longer side of the building is called front-view.

A thick chain with arrows, marked E-E in the layout plan (see 6.1/5) shows how to look at the building to obtain the side-view E-E. Hidden lines can be shown with dashes.

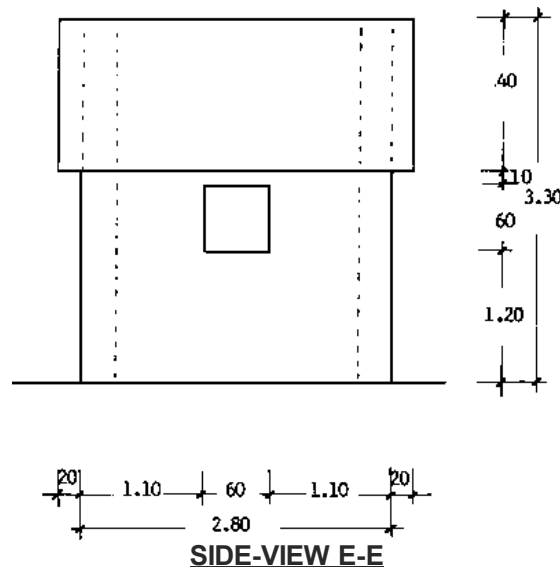

SCALE 1:50

H) Variation of Cross-Section

If the location of windows, etc. makes it necessary, the object can be “cut” in two different places. A thick chain with arrows, marked F-F, shows where the building is “cut” to obtain the cross-section F-F.

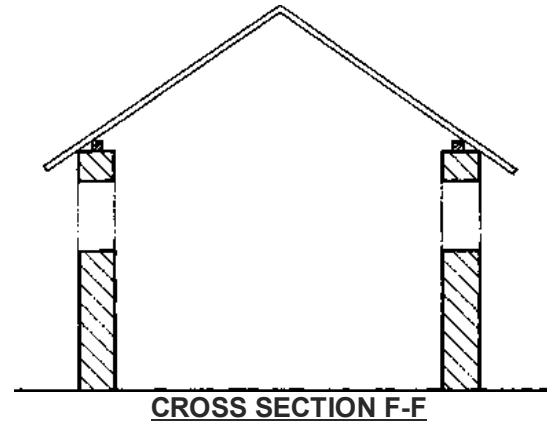
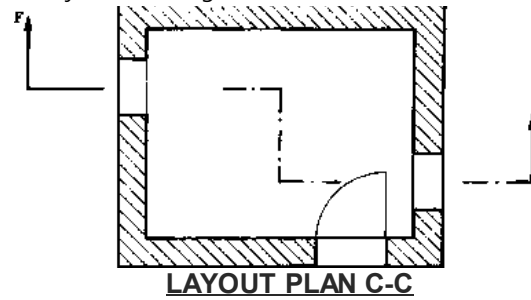

SCALE 1:50

I) Arranging Different Views on a Plan

If a plan is big enough to accomodate several views, they are arranged exactly above and beside each other (see the thin lines! = projection lines) and on one sheet.

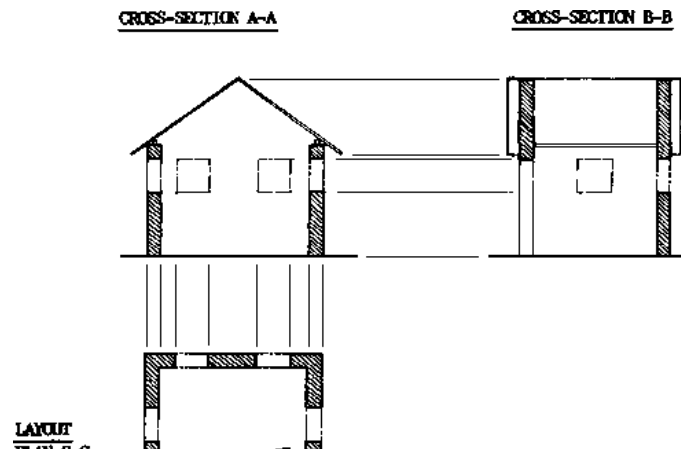



Scale 1:100

Front- and side-views are arranged like this:

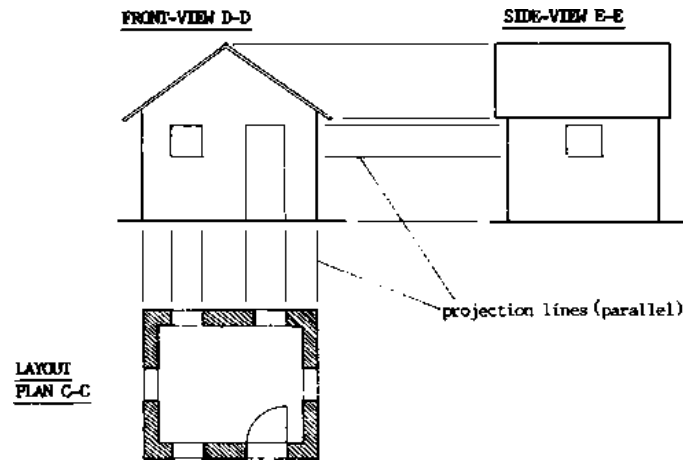

Projection lines connect the different views and show that the different parts of the object have the same width or height in the different views- They are a help while drawing, but normally do not show up in the final picture; here they are added for illustration.

Scale 1:100

If not all views are to be drawn, a different combination of views can be arranged on the sheet.

J) Examples of the Different Views

Several objects are shown in the following in the different views for illustration of the drawing principles (for mere examples see especially 7.10/5; 8.14; 8.18; 8.19; 8.30; 9.14 and many others);

1. Cylinder

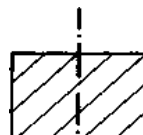
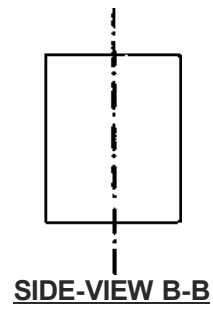
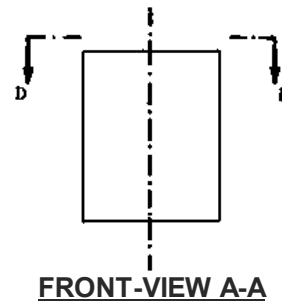
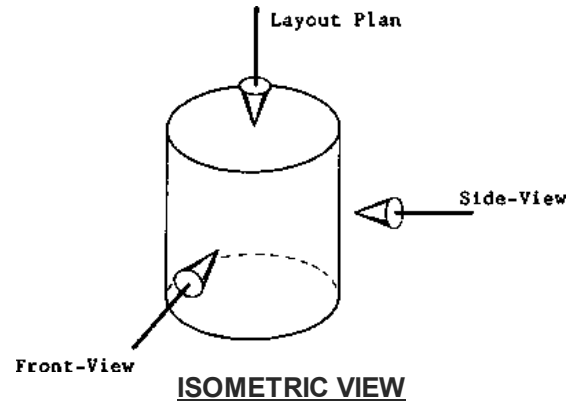

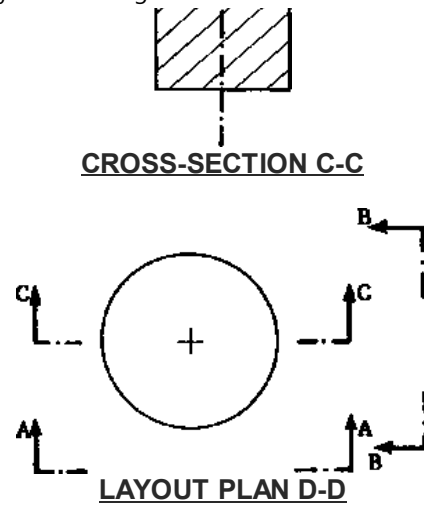

4. Concrete Ring

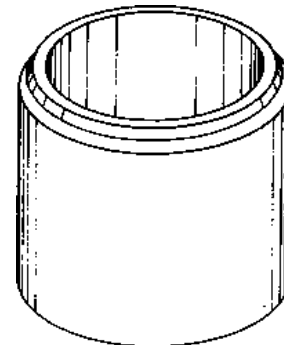

ISOMETRIC VIEW of object

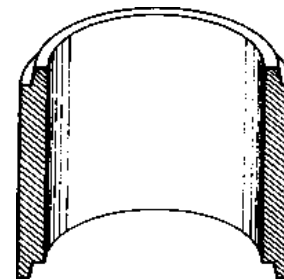

ISOMETRIC VIEW of half

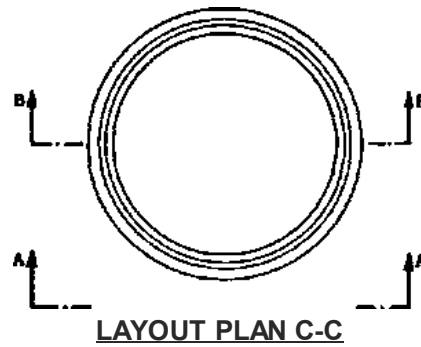
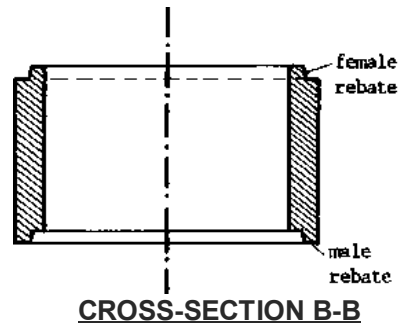
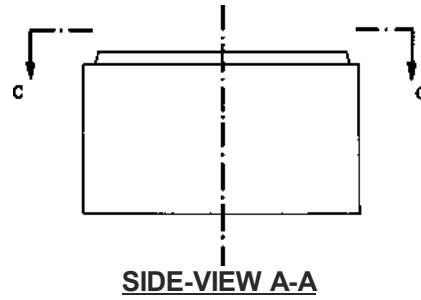

2. Two Cuboids

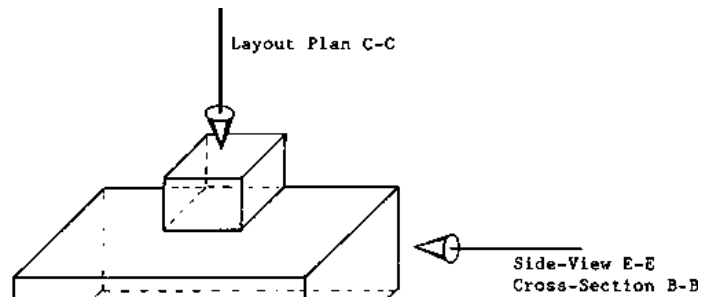

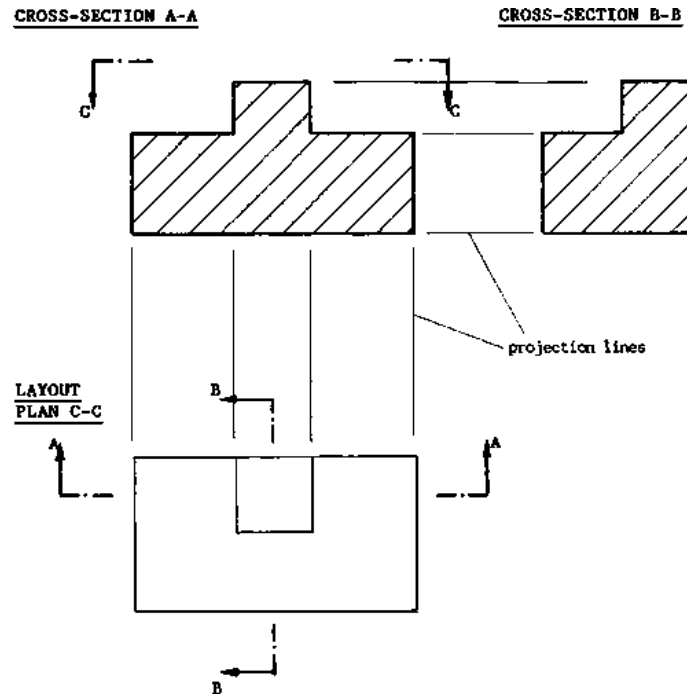
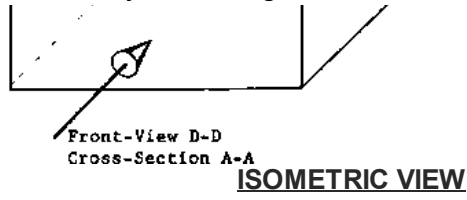

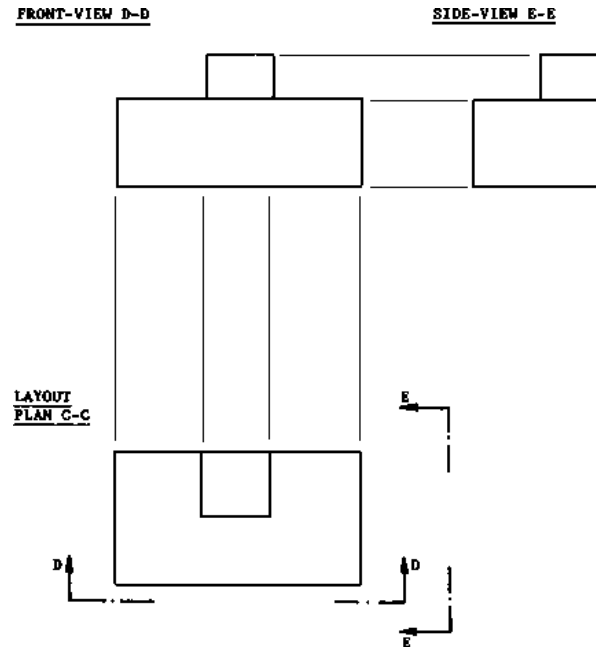

3. Two Cuboids with Cut-Out

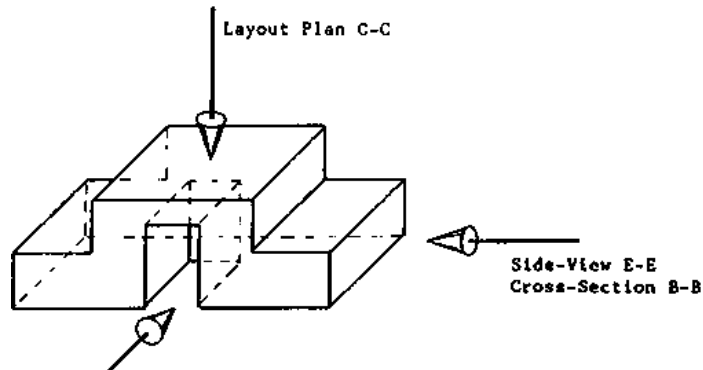

Front-View D-D
Cross-Section A-A

ISOMETRIC VIEW

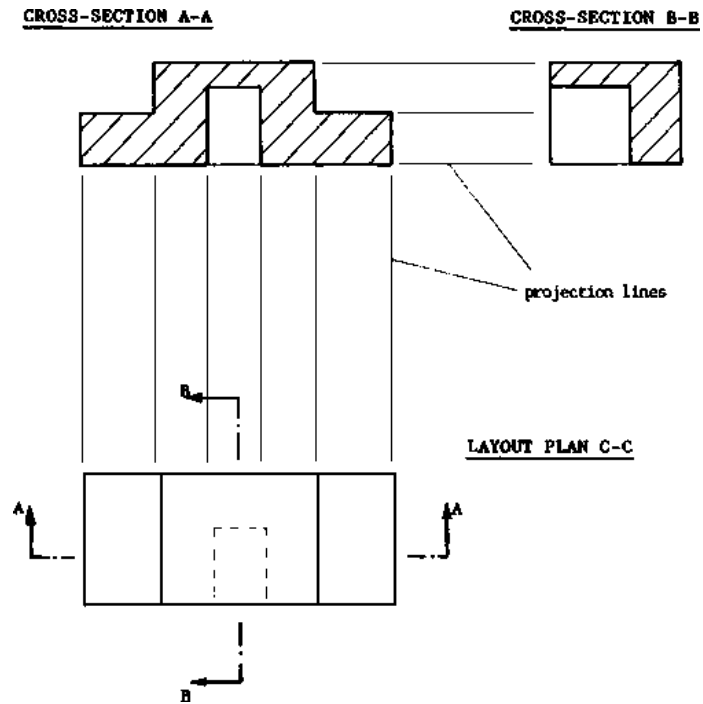

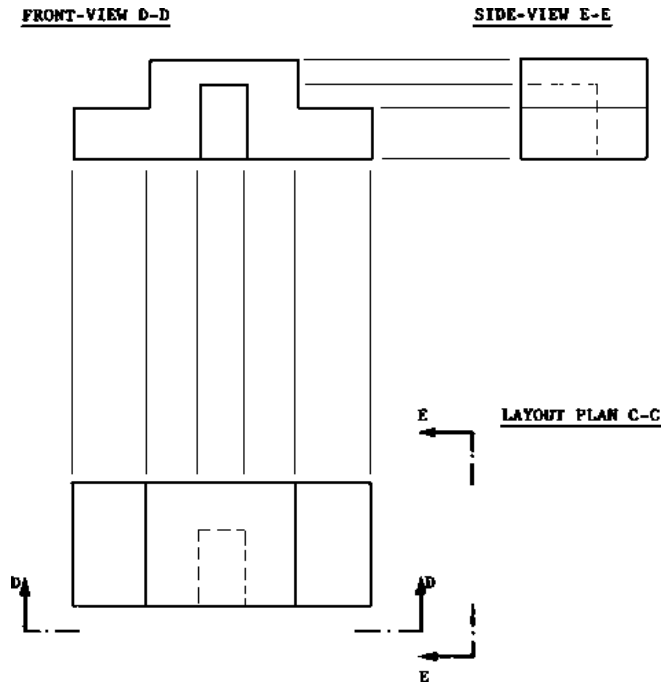

5. Diverse Steel Profiles

Profile	Isometric View	Cross-Section A-A	Cross-Section B-B	Side-View C-C
rod				
pipe				
square pipe				

steel channel				
equal angle steel				
I-steel				
Tee steel				

What do the different profiles look like in a layout plan D-D?

6. Ball

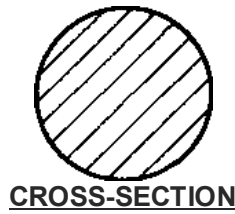
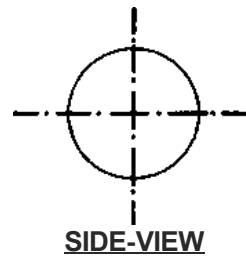

7. Bolt and Nut and Washer

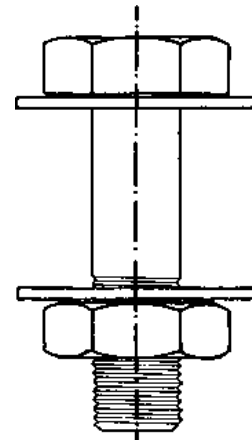

SIDE-VIEW A-A

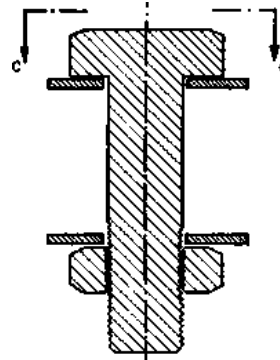

CROSS-SECTION B-B

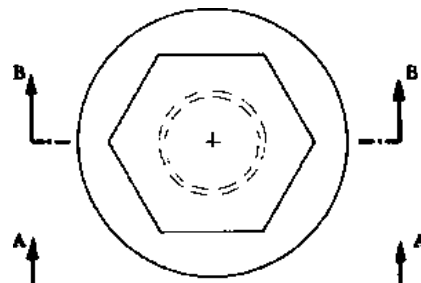

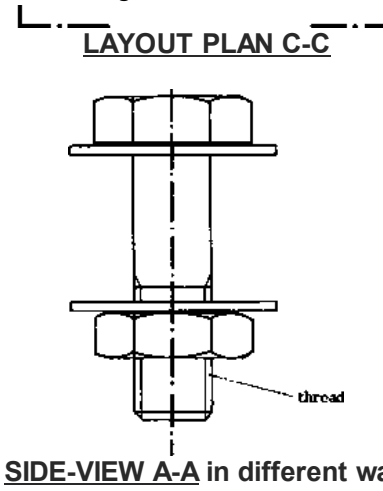

8. Reinforced Beam

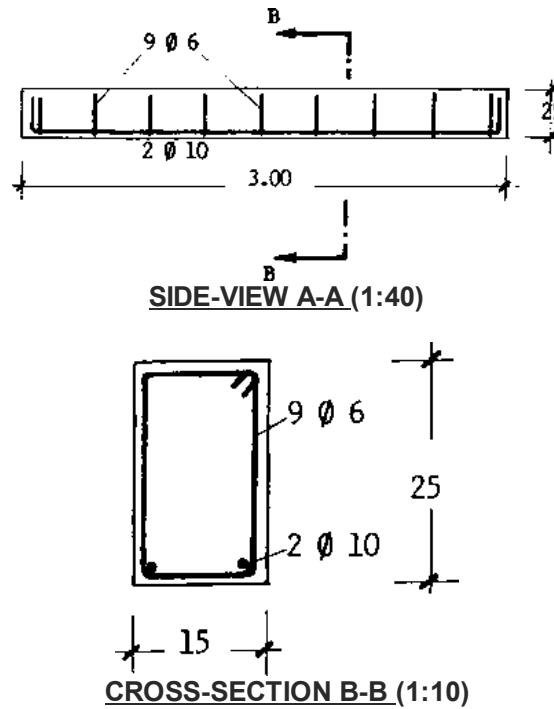

The cross-section is not hatched in order to show the reinforcement clearly.

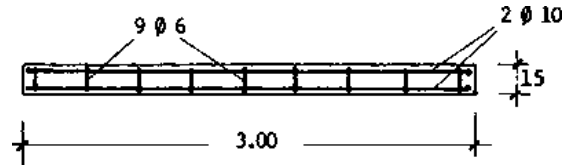

LAYOUT PLAN C-C (1:40)

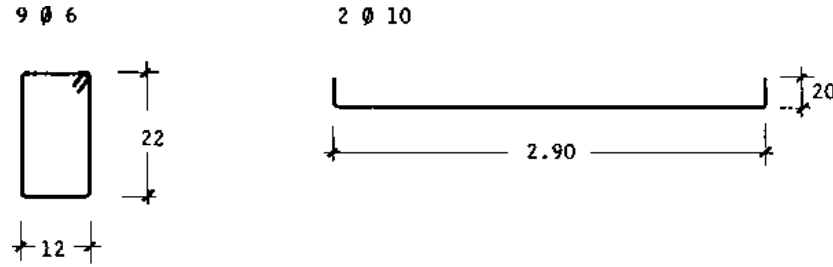

1:10

REINFORCEMENT (1:10)

9 Ø 6 stands for 9 pieces reinforcement, diameter 6 mm.
 2 Ø 10 stands for 2 pieces reinforcement, diameter 10 mm.

K) Drawing of Rotational Symmetric Parts

For rotational symmetric parts side-view and cross-section are often united in one drawing, taking half of each. This saves drawing work and space, but still provides complete information. See the following examples.

1. Bolt and Nut and Washer (compare with 6.1/17)

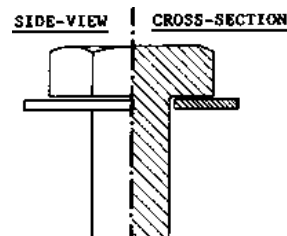

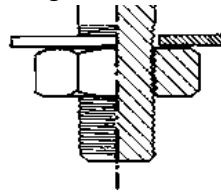

The nut itself is not rotational symmetric but still can be drawn like this, because it is clear what a nut looks like.

2. Concrete Ring (compare with 6.1/11)

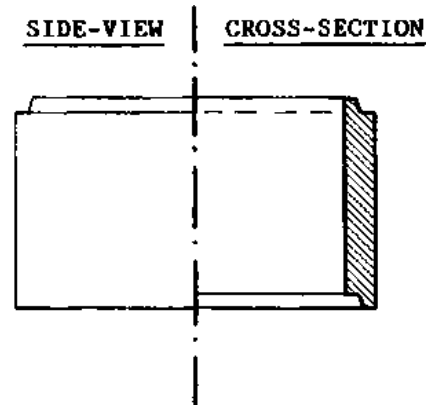

3. Pump Piston

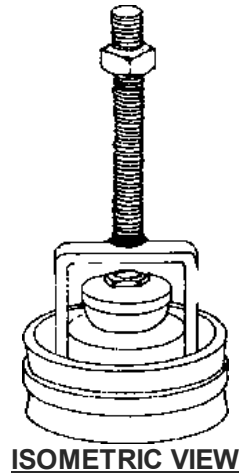

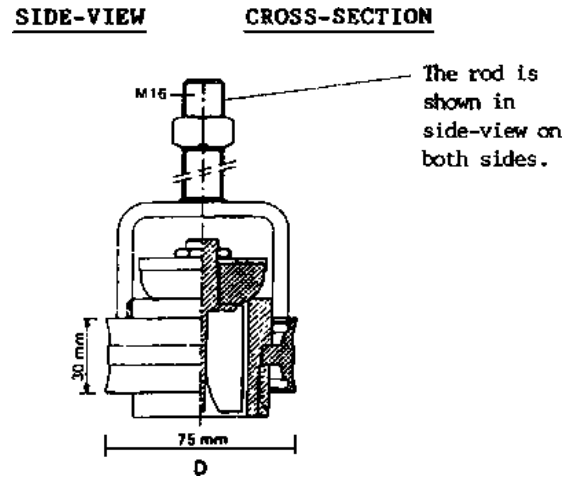

L) Exploded Diagram

Exploded diagrams are mainly used in installation manuals and spare part drawings of pumps and other machinery. They show exactly how parts, bolts, nuts and washers have to be assembled. All the parts are drawn as if moved apart by an “explosion”. Thus each part can be clearly seen.

Thin, long chains _____ indicate where the part needs to be attached.

Exploded diagrams can be drawn as side-views or as isometric views.

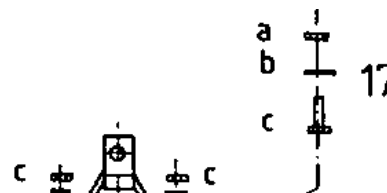

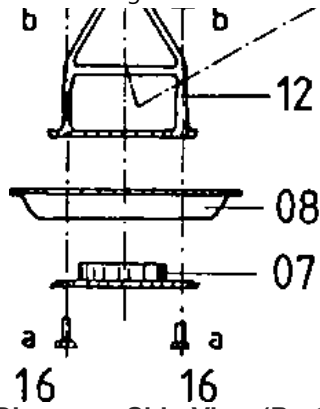

1. Exploded Diagram - Side-View (Part of Diaphragm Pump)

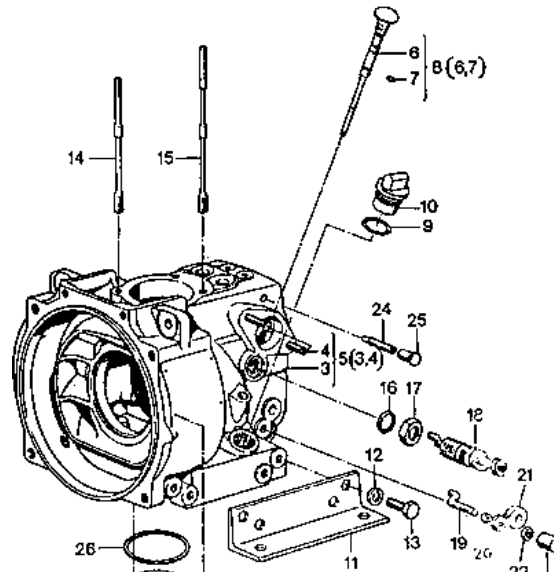
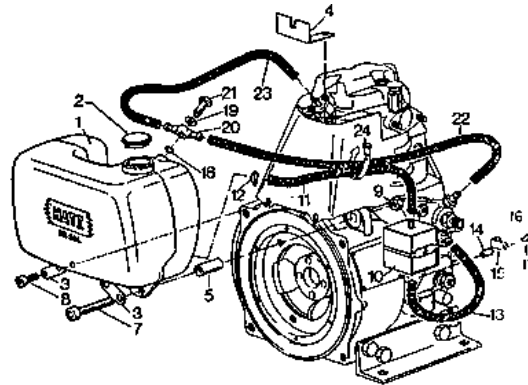

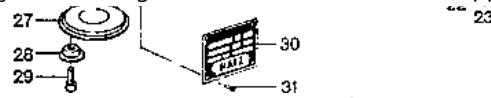

2. Exploded Diagram - Isometric View (Parts of Transportable Generator)

M) Cut-Away View with Hidden Inside Details

Sometimes the outside view of an object (side-view or isometric view) is used to show hidden inside details as well. To show these, part of the outside “skin” is shown as if removed. Imagine a banana being partly peeled, and you can see both outside skin and parts of the inside of the banana. The edges of the removed “skin” are usually drawn irregular.



Example: Household Sand Filter

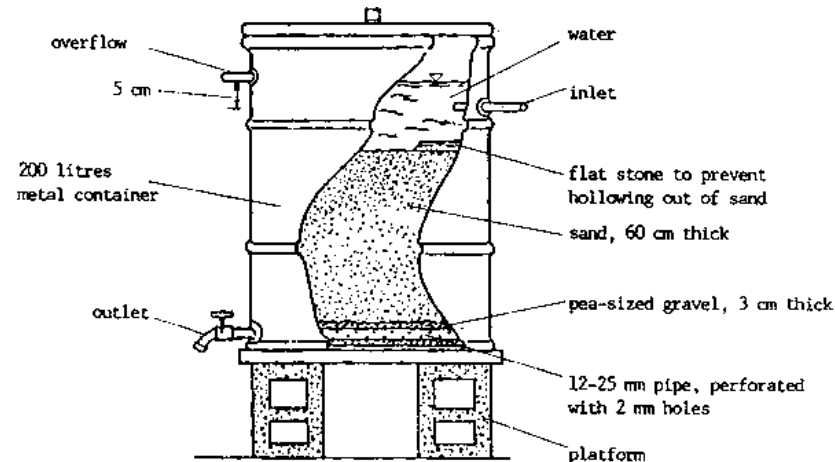

Cross-Section, Side-View, and Layout Plan of the same filter see 8.37/5

N) Conventions for Technical Drawing and Technical Signs

Conventions for technical drawing are fixed, agreed-upon signs used in technical drawings.

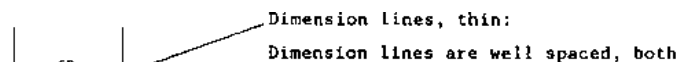

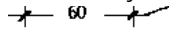

from outside lines and from other dimensions.

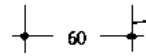

Projection lines, thin:

Each projection line commences after a small, but distinct gap from the feature indicated. Numbers can be read from the bottom or right hand side of the drawing.

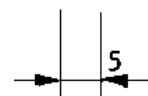
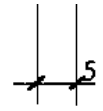
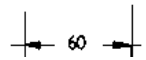

Small dimensions, thin

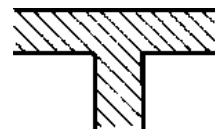

Cut wall, thick line, hatched

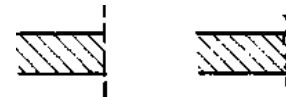

Boundaries, drawing not continued



Welding in cross-section

CROSS-SECTION

SIDE-VIEW



Connection of two pieces with bolt

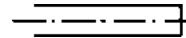

End of pipe in side-view



or :

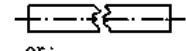

or :



Interruption



Long chain, thick: Cutting planes for sections



Edges, thin



Short dashes, thin:

Hidden details, edges not to be seen. The first and the last dash of a hidden detail line should always touch the lines between which it is drawn.



Centre line of a rotational symmetric part:

Centre lines must project for a short distance beyond the outline of the feature to which they refer.

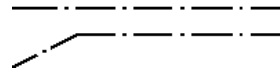

Thin, long chain: Direction of part on exploded diagram



lid



slab

Line, indicating name or part No.

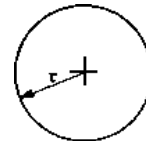

Radius and centre

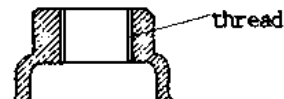

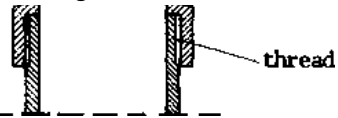

Two parts threaded together



Concrete (in cross-section)



Brickwork (in cross-section)

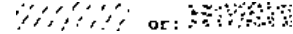

Sand or clay (in cross-section)

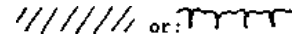

Rock (in cross-section)



Timber (in cross-section)



Insulation (in cross-section)



Water table



Diameter



Equal angle steel



Square pipe



is roughly equal to

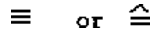

represents



is not equal to



is bigger than



is smaller than



Light

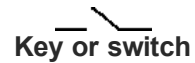

Key or switch



Socket and plug connected



Plug with two connections



Plug with three connections



Plug with five connections

O) Measurements and Scales

Always indicate on the bottom of your plan: "All measurements in m." or "All measurements in mm." Write only the figures into the dimension lines, without the unit. Commonly, steel construction and machinery is measured in mm; concrete, brick and timber work in m and cm. In this case 60 means 60 cm, not 60 m; and 1.60 means 1.60 m and not 1.60 cm.

The measurements in this manual are mostly indicated like the latter, in cm and m.

Indicate also the scale on the bottom of your plan.

The most common scales are:

1:10 means: 1 cm on the plan = 10 cm in reality = 0.10 m in reality

1:20 means: 1 cm on the plan = 20 cm in reality = 0.20 m in reality

1:50 means: 1 cm on the plan = 50 cm in reality = 0.50 m in reality

1:100 means: 1 cm on the plan = 100 cm in reality = 1.00 m in reality

1:200 means: 1 cm on the plan = 200 cm in reality = 2.00 m in reality

You can calculate the scales as follows:

$$\text{scale} = \frac{\text{length on plan}}{\text{length in reality}}$$

1. Example

How long do you draw 5 m in scale 1:20?

$$\frac{1}{20} = \frac{x}{5\text{m}}$$

$$x = \frac{5\text{m}}{20} = 0.25\text{m} = 25\text{cm}$$

2. Example

2.5 cm on a plan in scale 1:50 represents which distance in reality?

$$\frac{1}{50} = \frac{2.5\text{cm}}{x}$$

$$x = 2.5\text{cm} \times 50 = 1250\text{cm} = 1.25\text{m}$$

6.2 Marking Rectangular Layout Plan

Many buildings are planned to be rectangular. It is very important that they are built in true rectangular shape with 90° angles at each of the four corners. If the walls are out of the rectangular shape, you will face difficulties when placing slabs, roof trusses, zinc sheets, roofing sheets, floor tiles, etc., later on. If the walls are rectangular, these parts will fit without any further adjustment. If not, lots of tiresome cutting or other manipulations will be necessary. Therefore, it saves time in the long run to spend efforts on the correct layout. The walls must be laid out correctly in the first place and the shape must be checked regularly.

There are two ways to mark a rectangular layout plan:

A) 3-4-5 Method

This method is based on the Pythagoras theorem (see 5.5/1)

$$a^2 + b^2 = c^2$$

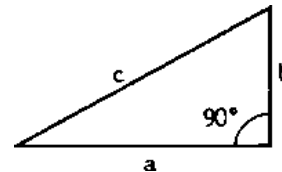

The numbers 3,4 and 5 fulfil the Pythagoras theorem:

$$3^2 + 4^2 = 5^2$$

$$9+16 = 25 \checkmark$$

This equation can be multiplied by any number on both halves of the equation and still fulfil the theorem, e.g.

$$(3^2 + 4^2) \times 4 = 5^2 \times 4$$

$$3^2 \times 4 + 4^2 \times 4 = 5^2 \times 4$$

$$(3 \times 2)^2 + (4 \times 2)^2 = (5 \times 2)^2$$

$$6^2 + 8^2 = 10^2$$

$$36 + 64 = 100 \checkmark$$

or

$$(3 \times 0.50)^2 + (4 \times 0.50)^2 = (5 \times 0.50)^2$$

$$1.5^2 + 2.0^2 = 2.5^2$$

$$2.25 + 4.0 = 6.25 \checkmark$$

Any triangle with the sides 3,4,5 or any multiples of 3,4,5 is a right angled triangle.

This connection is applied for marking a rectangular layout plan as follows:

1. Place "corner profiles" outside the four corners of the planned building.

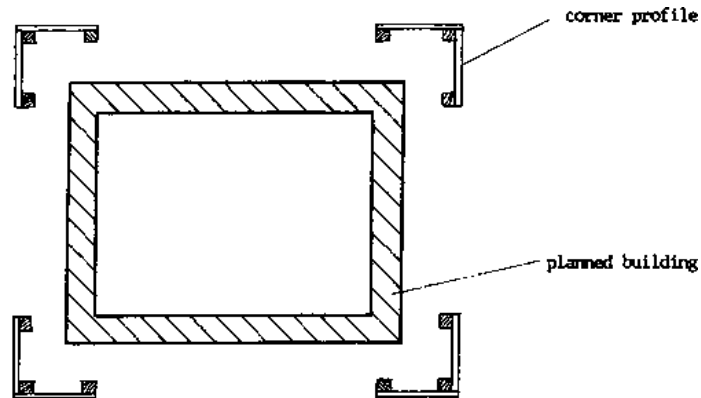

Make the corner profile itself right angled with the help of a carpenter's square.

2. Put the corner posts of the profile into concrete to prevent movement.
3. Mark the first side of the building by connecting a line between a nail on one corner profile to a nail on the opposite corner profile.

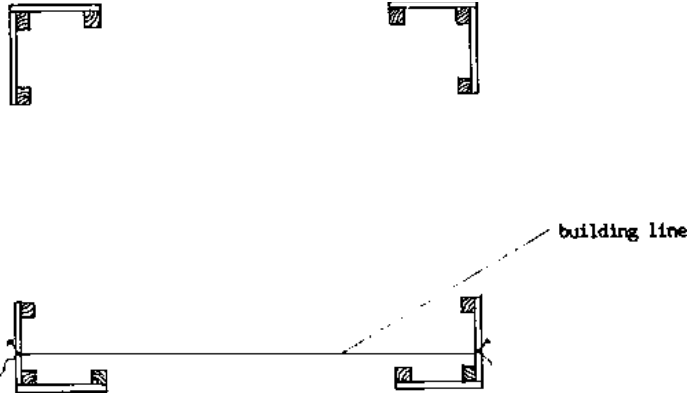

4. Create a second line crossing the first one using the 3,4,5 method. Mark 3 units (e.g. $3 \times 0.50 \text{ m} = 1.50 \text{ m}$) along one side with a string, mark 4 units (e.g. $4 \times 0.50 \text{ m} = 2.00 \text{ m}$) along the other side. The angle is 90° if the distance between the two marks is 5 units (e.g. $5 \times 0.50 \text{ m} = 2.50 \text{ m}$). Fix the line with nails.

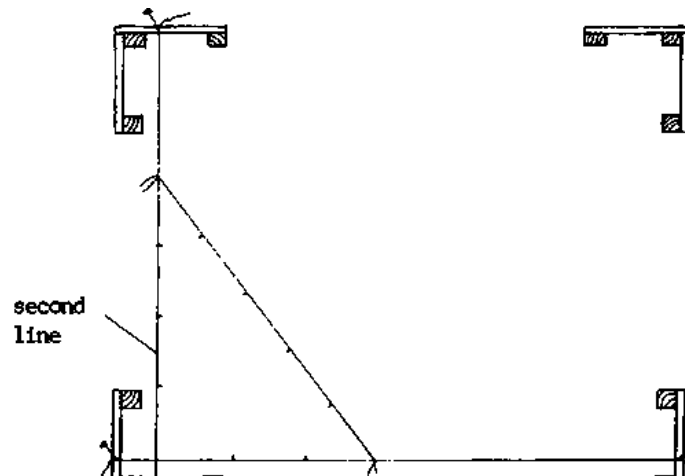

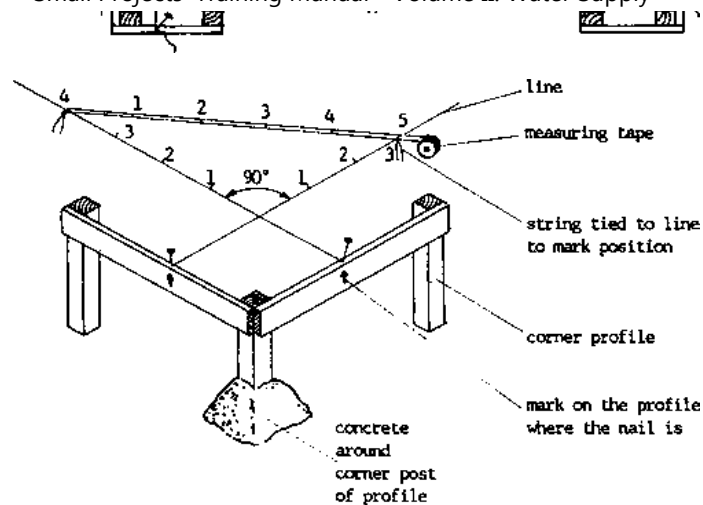

5. Connect all four sides like this taking care that the length of the sides is according to plan.
6. Check to see if the sides of the rectangle are according to plan and if the two diagonals are equal.
7. Mark the nails which indicate the layout plan to avoid confusion.
8. Plumb the layout on the ground with a plumb bob.
9. Remove the lines during construction and connect them again whenever you need measurements.

B) Method Using Diagonal

This method is useful for marking on level ground or on a cast (= poured) concrete floor. For example, you may mark the layout on cleaned and level ground and erect corner profiles afterwards (see A). The method is to be used as follows:

1. Calculate the diagonal of the rectangle with the given sides (see 5.5/1).

Example:

long side 1.90 m
 short side 1.60 m
 diagonal 2.485 m

2. Mark the long side of the rectangle (1.90 m) with nails (A) and (B).
3. Use a measuring tape stretched from corner (A) to create a diagonal that is 2.485 m long. This diagonal now becomes the radius of a circle drawn around (A) with a nail on the ground.

4. Repeat the method in number 3., using a radius that is 1.60 m long (the short side of the rectangle) around corner (B).
5. The intersection (= crossing point of the lines) of the two circles is the third corner (C). Mark it with a nail.
6. Repeat the method in number 3., using a radius that is 1.90 m long (the long side of the rectangle) to draw a circle around the third corner (C).
7. Draw a circle with the short side (1.60 m) around the first corner (A).
8. The intersection of the two circles is the fourth corner (D). Mark it with a nail.
9. Check if all the sides have the correct size.
10. Check if both diagonals are equal.

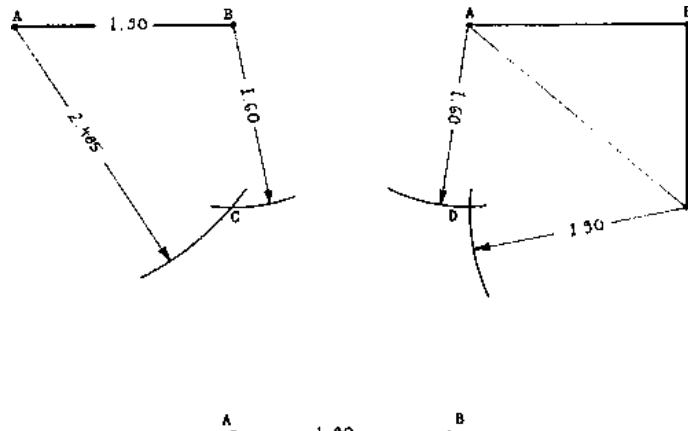

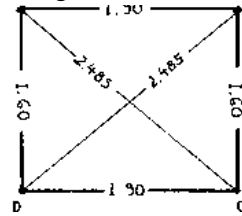

This method is very quick once the diagonal is known, and saves you difficult trial and error and corrections.

C) Checking the Rectangular Shape during Construction

The rectangular shape of the walls must be checked regularly (at least every metre). Always check the following two points:

1. Check if the length of the sides is correct.
2. Check if the two diagonals are equal.

The shape is rectangular only if both conditions are fulfilled. If not, make corrections; it may be tolerated if the diagonals differ by 1 cm, but not if they differ by 4-5 cm.

6.3 Tools

Tools are essential for good craft work. The technician must have a basic knowledge about tools in order to be able

- to select the suitable tools when purchasing,
- to use the correct tools for each purpose,
- to handle each tool in the right way to ensure optimal work and to avoid unnecessary damage,
- to maintain each tool properly to ensure its long life.

The most basic information about these points is collected in the chapter for the following kinds of tools (used in well construction and latrine building):



- general tools,
- special tools for concrete and brickwork,
- special tools for wood work,
- special tools for metal work.





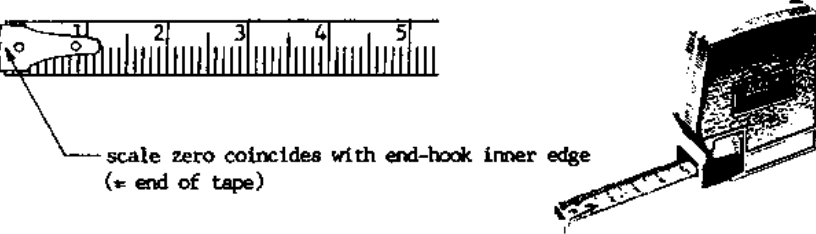
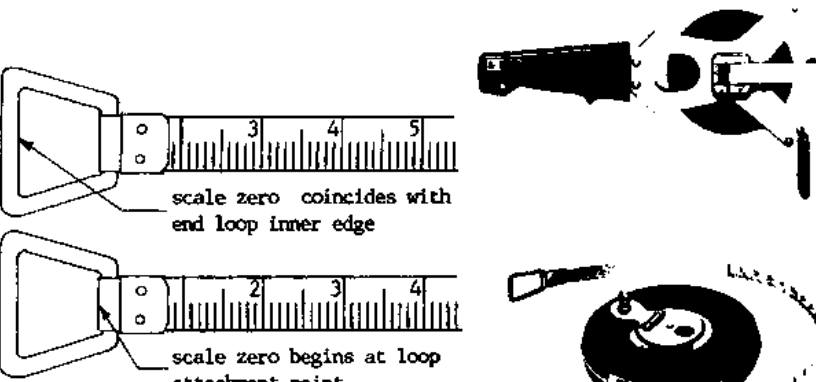

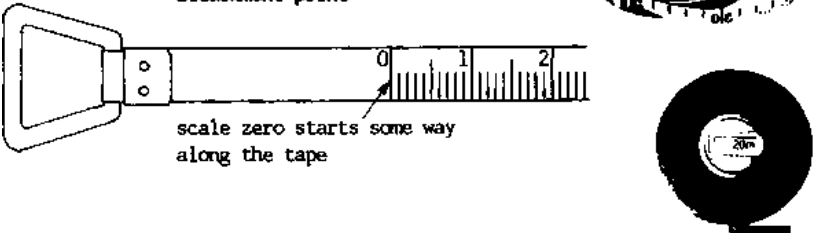
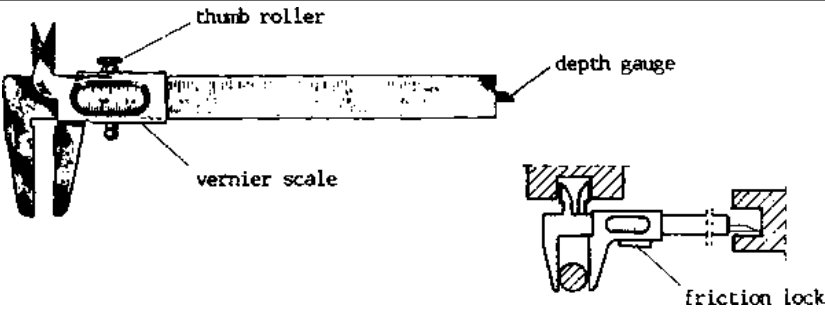

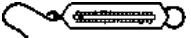
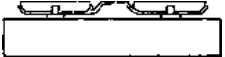

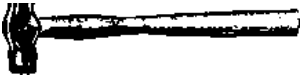
Only the most basic tools of these groups are compiled here, because the purpose of the chapter is to give a first introduction about tools for a technician trainee, completely new in the field. She/he is introduced into the new vocabulary and has to learn the names, functions and proper handling. Add the local names by yourself. When the technician is acquainted with the tools compiled here, she/he needs to deepen her/his knowledge by further studies in tools' catalogues and literature and by asking experienced people.



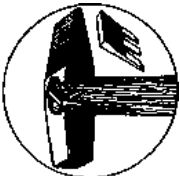





The full names and, if existing, several ones are listed. These names are not necessarily the suitable ones for recording in the store. For example, a “square file”, as listed here, is better recorded in the store as “file, for metal, square”; a “triangular file” is recorded as “file, for metal, triangular”; etc. Thus, the stock cards of all different files will be close to each other according to the alphabetical order (see also 7.9/1).





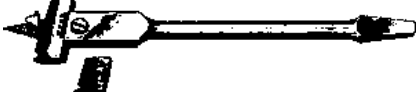

A) General Tools for Different Purposes



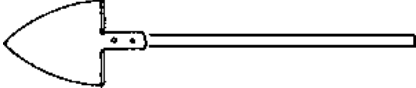
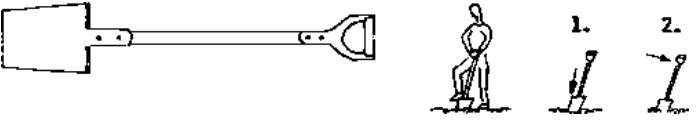

No.	Drawing	Name(s)	Description	Function	Remarks
1		measuring tape 2m, 5m = tape measure 2m, 5m = meter 2m, 5m = pocket measuring tape	with steel tape in enclosed metal case with spring return; graduation metric and inch	for measuring short distances in carpentry and concrete work or brickwork	for reading the meter see 6.4/5f; prevent tape from getting wet; if wet, dry immediately and oil it; prevent folds
2	<p>Different alternatives for tape zero positions</p> 	measuring tape 10m, 20m, 50m = tape measure 10m, 20m, 50m = meter 10m, 20m, 50m	steel, glass fibre or cotton tape in plastic frame with grip or in capsule with fold-away rewinding handle; sometimes plumb-loaded	for measuring long distances; for marking layout plans; for measuring well depth	rewind accurately; never rewind tape when it is wet; for reading the meter see 6.4/1ff

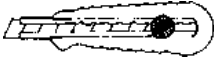
					
<p>3</p>		<p>caliper = vernier caliper</p>	<p>from polished steel, with knife-edged jaws for internal/external measurements and depth gauge; graduated in mm with vernier scale to read 1/10 mm; with thumb roller or friction lock</p>	<p>for measuring inside/outside diameters of pipes and internal/external measurements and depth of grooves</p>	<p>for measuring, hold the caliper against the object as shown in the drawing; use the vernier scale if you want to read 1/10 mm</p>
<p>4</p>		<p>spirit level = carpenter's level</p>	<p>from wood or steel, with two vials, one level and one plumb; the vials are from glass filled with ether; a bubble can be seen</p>	<p>for levelling and plumbing short distances; see 6.4/9f</p>	<p>steel spirit levels are more sensitive on sun; <u>never</u> leave a spirit level in the sun!, once spoilt by heat, it cannot be repaired; check the spirit level for its accuracy on every possible occasion</p>
<p>5</p>		<p>plumb bob = engineering bob</p>	<p>from iron with brass knob and plumb line</p>	<p>for plumbing, especially in deep wells</p>	<p>for using the plumb bob see 6.4/11; never knot the plumb line!</p>
<p>6</p>		<p>spring balance</p>	<p>Tandy scale, with hook and spring</p>	<p>for rough measuring of kg</p>	<p>hang the weight to be measured on the hook and read the scale; might not be exact after some time</p>
<p>7</p>		<p>balance</p>	<p>with two bowls, to be used with weights</p>	<p>for exact measuring of weights</p>	





8		blacksmithing hammer	one end rounded, the other flat	for blacksmithing	for all hammers: if loose, fix the head immediately with handle wedges (see No.12,6.3/6)
9		carpentry hammer	with round, crowned face and split neck	for carpentry work	the neck is suitable to extract nails
10		bricklayer's hammer	square face, the other end sharp for cutting bricks	for bricklaying	
11		sledge hammer	square face and sharp end or double square face, differentiated according to weight	for heavy duty work	the handle must be fixed well
12		handle wedges = hammer bolsters	three-pronged wedges from steel	to fix the handle of a hammer	the handle must tightly fit the hole; additionally, hammer the wedge into the handle from above
13		breast drill = drill brace = carpenter's brace	with four jaws; with eight-tooth ratchet and ball bearing head	for drilling holes in wood	for square shank bits; lean against the breast drill to improve drilling
14		hand drill	with three-jaw chuck, handles, two gears	for drilling holes in metal, wood, etc.	for round shaft bits
15		drilling machine = rotary drill = portable drill	electrical machine with three-jaw chuck, with key for opening the chuck, electrical cable and plug	normal drilling for wood, metal, etc., marked with  ; percussion drilling for stone, concrete, marked with  ; percussion means	for round shaft bits; start the machine before touching the object; drill straight







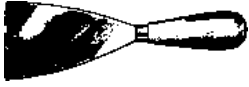

				that the bit drills <u>and</u> taps against the object	
16		drilling bit for stone = masonry drill = concrete drill	with round shank for hand drill or electrical drilling machine; the tip has a hard metal or carbide edge	for drilling brick, stone, concrete, glass, etc.	never use lubricants! the drill should be withdrawn regularly to avoid overheating
17		drilling bit for metal = twist drill	with round shank for hand drill or electrical drilling machine	for drilling metal	avoid blue coloured metal chips by reducing drilling speed; blue colour indicates overheating
18		drilling bit for wood = lamp base drill	with centre tip and side cutters, with round shank for hand drill or electrical drilling machine	for drilling small diameter holes in wood	first press the tip against the wood, then start to drill
19		centre bits	with round shank for hand drill or electrical drilling machine	for drilling large diameter holes in wood	see above
20		expansive bits	with square or round shank for all types of drills	for drilling large diameter holes in wood	see above; the bit is adjustable to any diameter
21		drilling bits for wood = solid centre auger bits	with square shank for breast drill, screw tip and feed screw	for drilling wood	see above
22		pickaxe	From steel, with one broad sharp and one pointed end and wooden handle	for loosening hard soil when digging	the handle must not move in the pickaxe
23		crowbar	thick iron bar with one pointed and one split or sharp flat end in different sizes	for digging pits or wells	keep the edge sharp

24		shovel	metal shovel with tip and long wooden handle	for lifting sand, earth, gravel, concrete, etc.	wash the shovel always immediately after work
25		spade	shovel-like tool, but with straight edge	for cutting and digging into soft soil with additional help of the foot	put your foot on the spade and press it into the soil with the help of your body-weight; then take the cut soil out using the spade as a lever
26		wheelbarrow	with one tyre (full rubber or with inner tube), strong frame and two handles	to move loads	keep the wheelbarrow clean and well greased; can be made locally from timber
27		whitewash brush = chalk broom	soft nylon brittles in square wood with handle	for quick painting of large areas with whitewash	wash immediately after use
28		flat paint brush	light bristles with wooden handle; in different sizes, sometimes with bucket rest	for painting with all kinds of paints	never allow paint to dry on the brush, but clean it immediately after use
29		universal knife = break-off blade knife	pocket knife with sliding blade with plastic cover; the blade has perforations	for cutting nylon sheets, carton, etc.	break off the tip of the blade when not sharp; the new tip will be sharp
30		funnel	from plastic or metal, sometimes with sieve	for pouring fuel, etc. into small openings	

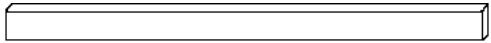
31		safety helmet	from plastic with rain gully; textile fittings, leather sweat-band, tape fastening	to reduce the risk of injuries from falling objects	always wear a safety helmet inside the well see 8.21
32		safety belt	with broad belts from nylon around chest and shoulders	for lifting and catching a person	use in all risky situations; see 8.21, 8.22
33		pulley = pulley block	with single or double or triple roll from steel, eye and hook; sometimes with hinged snatch for easy removal of a cable with a swivel	for pulling ropes, steel cables, etc.	see 8.17/19; never use a pulley which is broken in any of its parts; grease regularly; avoid friction between rope and frame
34		rope	hook on the end from sisal, hemp or nylon, with different diameters	for pulling loads	for details see 8.23

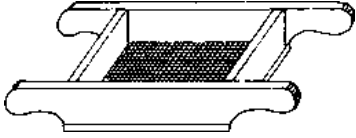

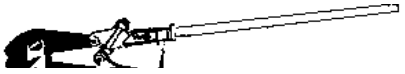

B) Special Tools for Concrete and Brickwork

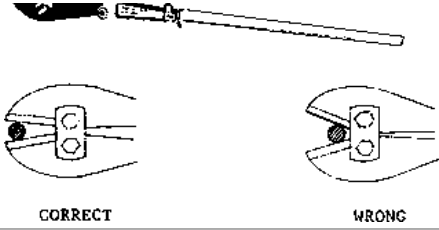



No.	Drawing	Name(s)	Description	Function	Remarks
35		trowels	from forged steel with wooden handle, in different shapes and sizes	for brick and concrete work; for spreading mortar; for rough cutting of bricks	for using the trowel see 6.7/10f; never allow mortar to get hard on the trowel
36		pointing trowel	thin trowel	for pointing and other fine work	see above
37		plasterer's trowel	triangle trowel	for plastering	see above
38		finishing trowel	square trowel	for smoothing and finishing	see above

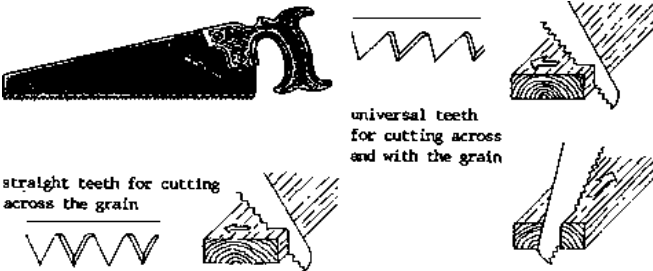



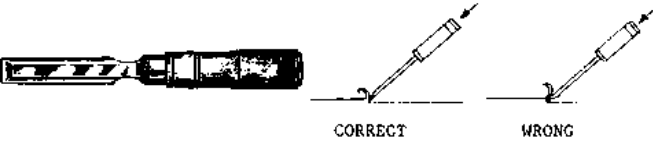
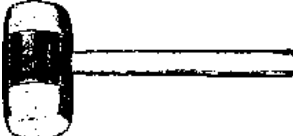

		trowel		plastering	
39		float	wooden smoothing trowel	for rough smoothing of (concrete) surfaces	can be manufactured locally
40		spatula	flat metal with handle in different sizes and shapes	for filling holes with gypsum and smoothing surfaces	
41		bricklayer's line	nylon thread	for building a straight line	
42		straight edge	from dry timber or steel	for making level floors	check the straight edge by looking along it; do not leave it in sun or rain
43		earth pan	locally made flat bowl from metal	for carrying mortar	never allow mortar to get hard on it, because it will increase its weight
44		bucket	from zinc or plastic	for carrying material	never use buckets with worn handles in wells
45		sieve	with wire mesh in different sizes in wooden frame	for sieving sand and gravel; see 8.20/1	sieve with two people
46		wrecking bar	from a steel bar; one end bent with a slot, the other end sharp	to be used as lever arm; for removing nails, shutters from concrete; for rough work	make full use of the lever arm
47		wire brush = steel	brush with wire bristles and wooden handle in	for dry cleaning of tools and equipment	keep the brush dry
48		hand-brush nylon brush = panel brush	different sizes brush with nylon (synthetic fibre) bristles in a wooden frame	for wet cleaning of tools and equipment	always clean tools immediately after work
49		bolt cutter	with clipper cut jaws and exchangeable blades	for cutting reinforcement rods	place the bolt to be cut at the end of the blade to make full

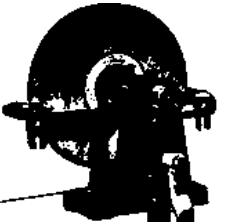

				use of the lever arm
--	--	--	--	----------------------

C) Special Tools for Woodwork

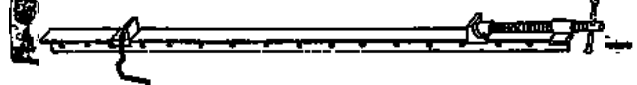

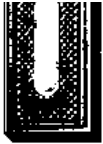

No.	Drawing	Name(s)	Description	Function	Remarks
50		cross-cut saw	long saw with big teeth and two wooden handles to be used by two people	for cutting logs into sawn timber	for all saws: never use force, but saw with speed instead and avoid bending the saw
51		bow saw	made of oval steel tubing in the shape of a bow; the blade can be exchanged; with tensioning arm to put the blade under tension	for cutting logs, poles, rough work	cut by drawing and pushing motion but with very little pressure downwards
52		turning saw = joiner's bow saw	wooden frame with blade, handles, wire for tightening the blade	for cutting sawn timber; for exact work	fix the blade; tighten the wire and the blade by turning the adjusting nut
53	 <p>universal teeth for cutting across and with the grain</p> <p>straight teeth for cutting across the grain</p>	land saw	with straight teeth or universal teeth; with wooden or plastic handle; in different sizes	for cutting timber	see bow saw
54		tenon saw = dove-tail saw	with square blade and wooden or plastic handle	for cutting deep grooves into timber	
55		compass saw = keyhole	very thin blade with handle	for cutting small holes into timber	

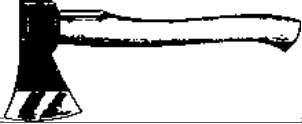





		saw			
56		plane	from steel or wood with handle and knob, smooth sole, blade and screw for adjusting depth of the cut	for smoothing wooden surfaces	always clean the surface of the timber to be planed; the blade must be sharp and straight; never use the plane with force
57		rebate plane	plane with a special blade for a rebate	for cutting rebates	see above
58		spokeshave	with cap and single cutter	for smoothing and rounding curved surfaces	see above
59		wood chisel	with sharp edge, a chamfered (= bevelled) blade and wooden handle	for cutting holes into wood	use a wooden mallet, never an ordinary hammer; sharpen the chisel often; do not use it as a lever arm; hold it as shown in the drawing
60		wooden mallet	special hammer from wood	for working with wood chisels	see above
61		rubber mallet	special hammer from solid rubber with wooden handle	for hammering without damaging the object	
62		sharpening oil stone = hone stone	stone fixed in wooden box; combination stones are coarse on one side and fine on the other	for sharpening tools	sharpen with long, even movements; always use with oil; sharpen your tools often (after every half hour)
63		table grinder = bench grinder	hand operated grinder with grinding wheel	for sharpening tools	hold the tool to be sharpened against the turning grinding wheel, it must lay parallel and flat against the wheel; never use force





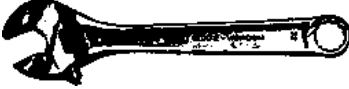

					
64		screw auger	auger with screw tip and opening for a handle	to drill large holes into wood without a machine	fix a handle in T-form and drill
65		wood rasp	with a series of pointed, individual teeth	for rasping wood, for coarse work in soft material	keep the rasp dry and clean
66		sand paper = flint paper = abrasive paper	strong paper coated with flint	for manual sanding of wood	put the sand paper around a piece of wood for proper grip
67		clamp	with bar of steel, strong jaws, a screw with plastic-ball jointed shoe and wooden handle, or steel T-handle; with short or long bar	for fixing a piece to the working bench or for pressing wooden frames together after gluing	push the jaws together on the pieces to be fixed, then screw the handle tight
68		sash clamp	long clamp	for pressing door frames or other large objects together	push the jaws together on the piece to be fixed, place the pin into the next hole, then screw the handle tight
69		work bench	with built in vices; with wood spindles	for carpentry work	locally made work benches can be equipped with a vice
70		trysquare = square	metal square with right angle; with stock and blade	for marking right angles or 45° on timber	the stock must be well pressed against the timber when marking





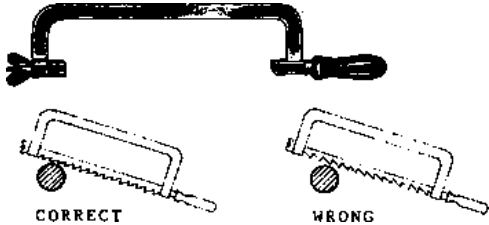

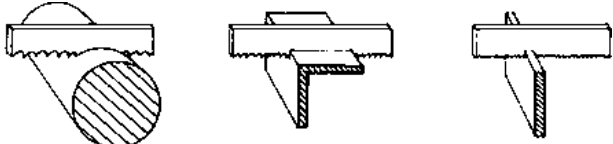
					
71		marking gauge	with scribing bar, graduated in mm	for marking carpentry work	
72		axe	with broad edge and wooden handle	for splitting wood, cutting trees, preparing poles, etc.	keep the axe sharp



D) Special Tools for Metalwork

No.	Drawing	Name(s)	Description	Function	Remarks
73		pliers = combination pliers	with single joint, pipe jaws, serrated gripping surfaces and two plastic covered handles	for all kinds of work	
74		pincers	with single joint and two handles	for tying reinforcement with wire, for cutting wire, for extracting nails	for tying reinforcement do not press the pincers too much; for extracting nails use the lever arm (see drawing)
75		self-grip wrenches = vice-grip pliers	with serrated (= toothed), adjustable jaws with pipe grip; can be locked on the job and stay locked with hands removed; with quick-release lever (spring loaded)	for different kinds of work	adjust by end-adjusting screw until jaws slip over the work, then snap handles shut and jaws will engage with powerful grip; release with release lever
76		zinc cutter = hand snips = hand shears	with snips and two handles	for cutting zinc or other metal sheets	sharpen the snips from time to time
77		punch	with sharp tip	to mark a point on a piece of metal or make a	

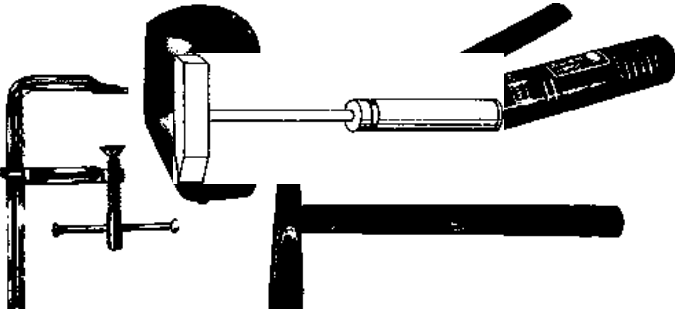
				start for a twist drill (No.17, 6.3/8)	
78		screwdriver	with wooden or plastic handle, sometimes with hexagonal shaft which facilitates the use of spanners for tightening	for screwing screws with slot head	never use a screwdriver as lever arm; take care not to damage the tip
79		cross-screwdriver = Phillips screwdriver	with wooden or plastic handle	for screwing screws with Phillips head	a cross-screwdriver does not slip away easily
80		open-ended spanner = open-ended wrench	double ended, with jaw angles 15°, in different sizes, often in sets	for locking and tightening bolts and nuts	only use fitting spanners; carefully fit them on the nuts; do not damage the jaws
81		ring spanner = box wrench	double ended with 12-faced rings, in different sizes	for loosening and tightening bolts and nuts; more force can be inserted than with open ended spanners	only use fitting spanners; place the spanner carefully on the nut
82		adjustable spanner = adjustable wrench = crescent wrench	with movable jaws, adjusted by a screw	for loosening and tightening bolts and nuts of any size	adjust the jaws so that they grip the nut exactly
83		alien keys = alien wrench	hexagonal rod in L-shape; in different sizes; often in sets	for hexagonal socket heads	use the long end as a lever arm
84		socket sets	with bi-hexagonal sockets in different sizes and ratchet handle	for loosening and tightening bolts and nuts	fit the socket on the nut and tighten with the ratchet handle; quicker work than with ring spanners; more force can be applied

					
85	 <p>cold chisel, mushroom shaped</p> 	cold chisel	made from specially treated steel	for cutting metal pieces or cutting holes into brickwork and concrete	keep the tip sharp; never allow the other end to become mushroom shaped
86	 <p>CORRECT WRONG</p>	hacksaw frames	steel frame with handle and blade holders	for sawing metal parts	the blade must always be tight; do not apply force when sawing; always mount blade so that teeth will cut on the push stroke, see drawing; see also 8.32/12
87	 <p>Choice of suitable blade for different materials: At least three teeth should be in contact simultaneously.</p>  <p>18 teeth/inch, coarse 24 teeth/inch, medium 32 teeth/inch, fine</p>	hacksaw blades	steel blade with teeth	for sawing metal parts	do not try to saw with worn-out blades, but replace them; never replace a blade in the middle of a cut, because this would spoil the new blade; see also 8.32/12
88		angle grinding machine = angle grinder	electrical machine for cutting and grinding discs	for cutting and grinding	hold the machine firmly; always use eye-protectors
89		cutting disc = cutting-off wheel	consisting of cutting medium and bonding agent according to the material to be cut	for angle grinder	use only for cutting, never for grinding; tighten the disc safely; never use force; touch the object to be cut vertically and without pressure

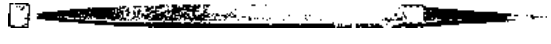
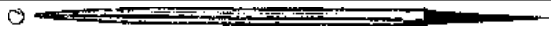
90		grinding disc = grinding wheel	consisting of grinding median and bonding agent according to the material to be ground	for angle grinder	use only for grinding never for cutting; tighten the disc safely; grind without pressure
91		shrubbing disc	from soft material	for angle grinder	use only for smoothing the surface
92		eye protectors = safety goggles	plastic glasses with front and side protection	for protecting the eyes	always use eye protectors when cutting and grinding
93		set of welding equipment	consisting of welder's screen, 2 cables with connections, 1 electrode holder, 1 earth clamp, 1 wire brush, 1 chipping hammer	for welding	the cable area Ø must fit the welding generator's specification
94		soldering iron	with square copper section and wooden hand grip	for soldering	warm up in open fire and solder
95		anvil	with plane work surface	for blacksmithing	the anvil must be mounted on a wooden block to absorb vibration
96		flat file	of rectangular shape, one edge uncut, with double cut	for sharpening flat metal surfaces and	for all files: keep them dry and clean

				sharp corners and blunts	
97		three-square file = triangular file	double cut sides, uncut top	for finishing inside corners, slots, etc.	
98		square file	double cut on all four sides	for filing grooves, rectangular holes and inside shoulders	
99		round file	double cut	for round and concave surfaces	
100		half round file	double cut, all around	for finishing concave and plane surfaces and larger holes	
101		file brush = file card	fine and flat wire inrush	for cleaning files	keep the brush dry

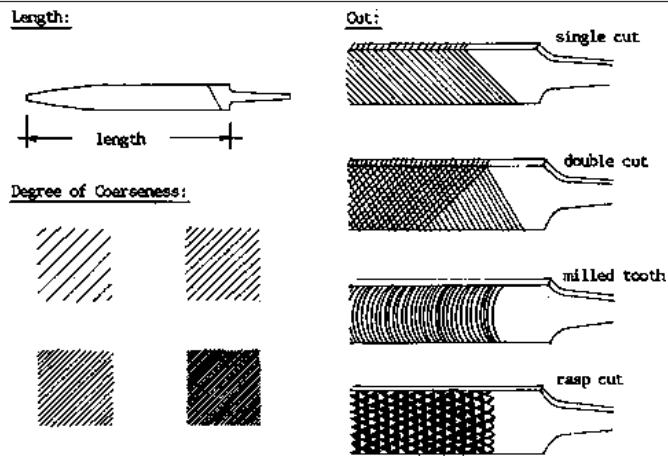

Length:

The length of the file does not include the tang (= the projecting part by which the blade is held in the handle). The length of the file should be chosen according to the size of the workpiece: the larger the workpiece, the larger the file. It is better to choose a file that is too long than one that is too short to ensure stability when working.

Degree of Coarseness:

Files are divided into the following degrees of coarseness: rough, bastard, median-fine, fine.

Fine files are used for hard material where a good finish is required, while coarse files are

Cut:







Files are divided into four cuts: single, double, milled tooth, and rasp.



Single cut files are for filing steel and metals with normal working pressure.

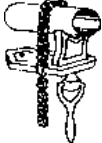
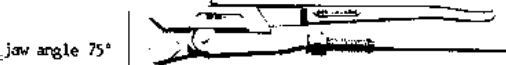

Double cut files consist of two diagonal cuts. They are used at higher working pressure than single cut files for iron, steel, but also plastics, wood, etc.



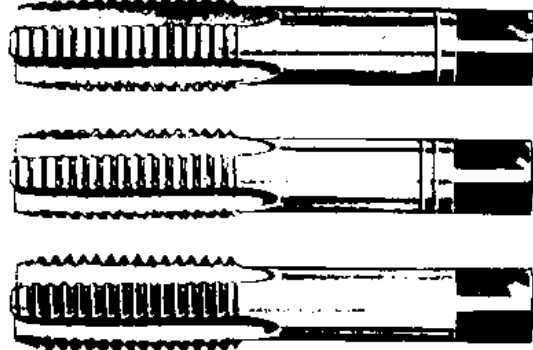

Milled tooth cut files are used for smoothing the surface in car-body repair work. The teeth form curves over the surface of the file.

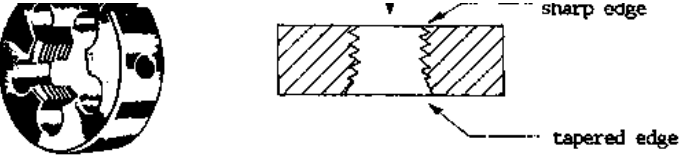
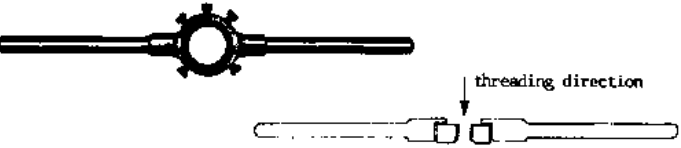
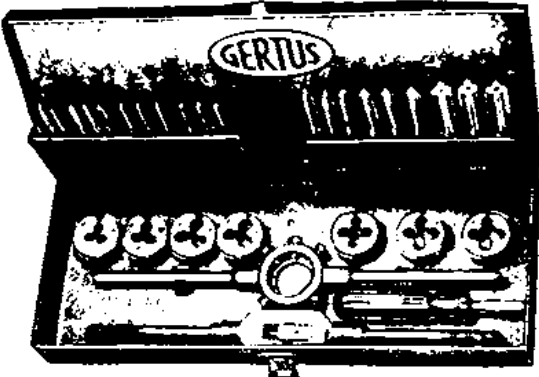

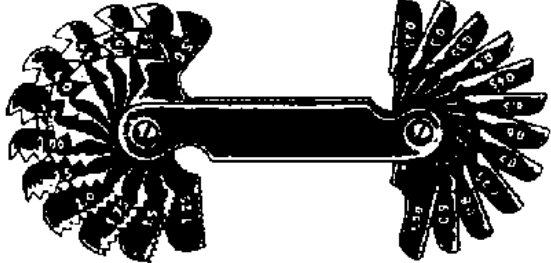

Rasp cut files have a series of pointed, individual teeth. They are used for coarse work in soft

			used on soft material where a rough surface can be tolerated.	material, e.g., wood, plastic, aluminum, leather, etc.	
102		vice	with steel jaws and spindle; sometimes, pipe jaws under the smooth jaws	for holding items firmly	keep the vice well greased; do not use force
103		pipe vice	with pipe support and ringed jaws	for holding pipes firmly	keep the vice well greased
104		chain pipe vice	the pipe is held all around with a chain	for holding pipes firmly	fix the chain as firmly as possible, then screw the handle
105		pipe wrench Swedish type	with two serrated jaws, adjusted with a positioning screw; the jaw angle can be 90° or 75°; with two handles; in different sizes	for fixing threaded pipe joints	for handling pipe wrenches see 8.32/14f; optimal grip only in one direction
106		pipe wrench British type	with two serrated jaws, adjusted with a positioning screw; with a spring; only one handle	for fixing threaded pipe joints	grip only in one direction
107		chain wrench	with chain, double toothed, reversible jaws and one handle	for fixing and holding pipes or irregularly shaped objects	fix the chain as firmly as possible, then move the handle; grip in both directions possible
108		pipe cutter	with cutting wheel, two guiding wheels and adjustable handle	for cutting pipes	never use force; fit the cutter on the pipe, screw the handle until the cutting wheel touches the pipe cut one round, screw the handle, cut one round, etc.;

					always use cutting oil; see 8.32/12
109		thread tap	with straight flutes to deliver the swarf (= chips) out of the hole; with square shank	for tapping (= cutting) internal threads for bolts and pipes; the tap must fit to the specifications of the thread (for threads, see 8.32)	always use with thread cutting oil; never apply force
110		series taps	for pre-cutting, medium cutting and fine cutting	for tapping internal threads with very good finish	the three taps have to be used one after the other
111		tap wrench	adjustable for different taps, with two handles	for holding taps	
112		threading dies = threading dice	round dies	for threading external threads of bolts, pump rods, etc.; the	check for starting point by noting the tapered side (not the sharp side); use the dies always with thread cutting oil; never apply force

				<p>tools, etc., the dies must fit to the thread specifications (for threads see 8.32]</p>	<p>never apply force</p>
<p>113</p>		<p>die stock</p>	<p>for different dies with two handles</p>	<p>for holding dies</p>	<p>fix the die in the stock as shown in the drawing</p>
<p>114</p>		<p>tap and die sets</p>	<p>contain tap and dies of different sizes, complete with tap wrench and die stock in a box</p>	<p>for cutting internal/external threads of bolts; the taps and dies must fit to the thread specifications (for threads see 8.32)</p>	<p>the taps and dies are well protected and complete in a set, however, some diameters wear out quicker than others</p>
<p>115</p>		<p>pipe thread die stock (with chaser dies) = pipe threader = thread cutter for pipes</p>	<p>with ratchet; automatic centering; right and left hand threading possible; chaser dies can be exchanged Ear taper or cylindrical threads; one set of chaser dies suitable for different pipe diameters, because the diameter can be adjusted</p>	<p>for cutting external pipe threads; one die stock can be used for different threads</p>	<p>always insert the chasers in the indicated order; suitable also if the pipe \varnothing is different from the specifications; open the chaser dies after threading, screwing back on the thread is necessary; the ratchet allows to turn the handle conveniently back and forth instead of screwing continuously</p>

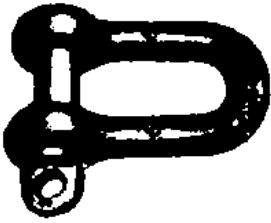
116		chaser dies	4 chaser dies in one set, suitable for different pipe diameters, because the diameter can be adjusted	for fitting into pipe thread die stock	replace the chaser dies if worn out or chipped (= part broken off)
117		pipe thread die stock (with separate screw heads)	separate screw heads for each diameter; with right or left hand ratchet	for cutting external pipe threads; the screw heads must fit to the thread specifications (see 8.32)	quick change between various thread sizes; the pipe diameter must fit exactly to the specification
118		thread gauge = screw pitch gauge	folding blades with gauges for different threads	for measuring internal and external threads	hold the gauge against the thread; if it fits read the specification
119		cutting oil = thread cutting oil	there are two types: 1. on biological base for threading drinking water pipes 2. on mineral base for all other threads	for lubricating and cooling while threading	continuous lubrication is necessary; this will ensure better threads and increased life of the threading tools
120		oil can	with reservoir, spout and pressure pump	for oiling tools, etc.	keep the spout clean
121		lifting hook = swivel	from forged steel with safety catch	for lifting weights	the safety catch must be intact and the load must hang inside

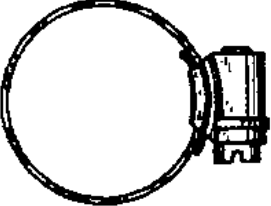
		hook			the safety catch; see also 8.17/20
122		thimble	drop-shaped, from galvanized steel	for permanent eyes of steel cables	tighten the wire rope grip closely to the thimble; see also 8.17/16
123		shackles = D-shackle	U-shaped with bolt, different sizes for different weights	for connecting the eye of a steel cable with other elements	see also 8.17/19
124		connecting links	eye from steel rod which can be opened; alternatively with screwed connection	for quick connection of steel cables, ropes	see also 8.17/19
125		wire rope grip = wire rope clamp = cable clamp	the cables to be connected are inside a U-bolt and a cross piece is pressed against them by nuts	for fixing two wire ropes (= steel cables) together	for lifting devices use 3 wire rope grips for each connection; see 8.17/16
126		hose clips	from steel band with rolled-up band edges to prevent the band from cracking, tightened with bolt	for tightening hoses on a fitting	use 2 hose clips for each connection

6.4 Using Measuring Tools

Correct measuring is essential for good quality technical work. Many mistakes happen due to incorrect use of measuring tools. The technician needs to learn and practise the correct use of measuring tools.

The most basic measuring tools such as measuring tape, spirit level and plumb bob are explained here.

A) Measuring Tape

The tool for measuring distances is called “measuring tape”, “tape-measure”, or “meter”.

Note:

meter = measuring tool
metre = unit of length in metric system

Measuring tapes are supplied in different length: 2m, 5m, 10m, 30m, 50m, etc.

Note that all illustrations in this chapter are not to scale!

1. Reading Measuring Tapes 10m, 30m, 50m (see also 6.3/2f)

Long measuring tapes are normally from flexible material like plastic. The tape is wound up into a round box. Often metric measurements are on one side of the tape, and British measurements are on the back.

The tape is marked with short lines and long lines crossing the whole width of the tape. Only the long lines are marked with numbers. If the number consists only of one figure, the figure stands left from the line. If it consists of two figures (or a figure and a letter), they are left and right from the line:



a) Measuring Tape in Metric System

The tape in the metric system measures m, dm, cm.

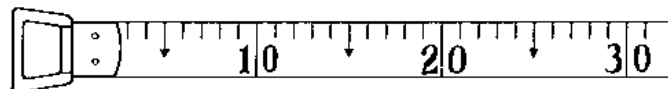

The short lines indicate cm. Every fifth cm is indicated with a longer line with arrow for better orientation. No numbers are given for cm. You have to count them yourself. Every tenth line is a long line and is indicated with the appropriate length.

For example:

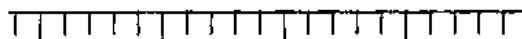

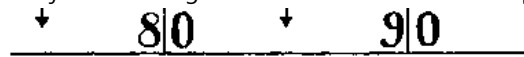

These numbers in black (the two figures left and right of the long line) indicate cm.

For measuring a length between two numbers:

- Read the previous cm indication.
- Count the cm.
- Add the two.

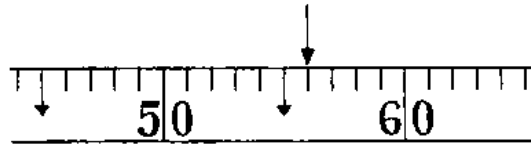

Previous cm indication: 50 cm

cm counted: 6 cm

length measured: 56 cm

Full metres are indicated as 1 M; 2 M; ... 9 M; 10,11,..., and are printed in red for differentiation. Any black number for cm beyond 1 m is marked with a small red number indicating the metres.

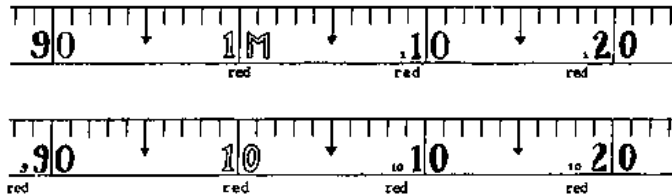

Read measurements bigger than 1 m as follows:

- Read the previous small read number as m.
- Read the previous number in black.
- Count the cm.
- Change all into one unit (e.g. m). For transformation see 5.3/1.
- Add the three.



Previous m indication: 20 m = 20.00 m

previous cm indication: 10 cm = 0.10 m
 cm counted: 8 cm = 0.08 m
 length measured: 20.18 m

Take special care immediately after a m indication:

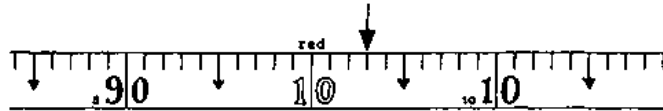

previous m indication: 10 m = 10.00 m
 previous cm indication: - -
 cm counted: 3 cm = 0.03 m
 length measured: 10.03 m !!

For comparison:

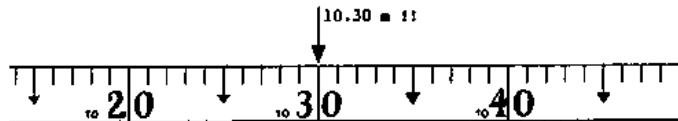

b) Measuring Tape in British System

The tape in British system can measure inch (= ") and feet (= '). The short lines indicate half inches. The long lines indicate inches; the numbers are given in black. If the number consists of two figures, one is left, the other right of the relevant line. Inches are numbered from 1 to 11. The twelfth inch completes a foot which is indicated in red as 1 F, 2 F,... 9 F, 10,11, etc.

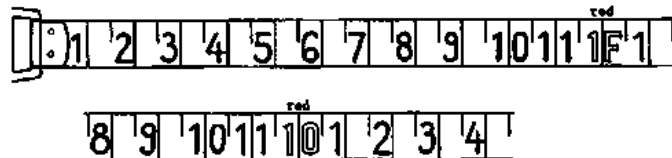

Read measurements as follows:

- Read the previous red figure as foot.
- Read the previous black figure as inch.

- Read $\frac{1}{2}$ -inch.
- Add up the three.

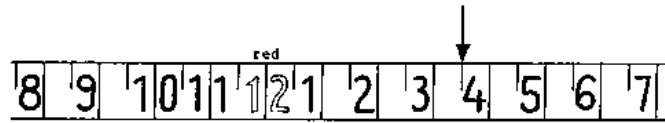

previous foot indication: 12'
 previous inch indication: 3"
 half inch: $\frac{1}{2}$ "
 length measured: 12'3 $\frac{1}{2}$ "

2. Reading Measuring Tapes 2m, 5m (see also 6.3/2f)

Short measuring tapes are usually made from a stiff metal strip, wound up by a spring into a small, handy round or square box. Often the tape shows British measurements on the top half and metric measurements in the bottom:

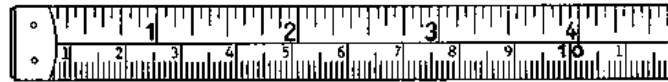

Read either of them, but keep them strictly apart, especially the numbers, and be careful not to get mixed up.

a) Metric Side

On the metric side you can measure cm and mm. The short lines indicate mm without numbers. You have to count them yourself. Every fifth mm ($=\frac{1}{2}$ cm) is indicated with a middle size line for easier counting. Every tenth line is a long line marked with a number which indicates cm from 1 cm to 9 cm. Every tenth cm is indicated with a fat number: 10, 20,...90. After each of these, the cm are marked again from 1 to 9. 1 m is indicated as 100 cm.

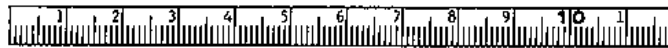

Read the measuring tape as follows:

- Read the previous fat number (with 2 or more places) as cm.
- Read the previous single number as cm.
- Count the mm.
- Change the mm into cm. For transformation see 5.3/1.
- Add all three.
- Change to m, if necessary.

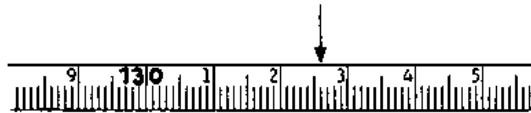

previous fat number: 130 cm = 130.0 cm
 previous single number: 2 cm = 2.0 cm
 mm counted: 6 mm = 0.6 cm
 length measured: 132.6 cm = 1.326 m

Take special care immediately after a m indication:



previous fat number 100 cm = 100.0 cm
 previous single number: 3 cm = 3.0 cm
 mm counted: 2 mm = 0.2 cm
 length measured: 103.2 cm = 1.032 m

For comparison:

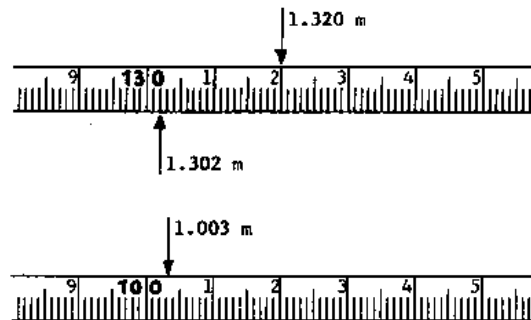

b) British Side

On the British side you can measure inches, $\frac{1}{2}$ " , $\frac{1}{4}$ " , $\frac{1}{8}$ " , $\frac{1}{16}$ ". The short lines indicate $\frac{1}{16}$ "; every second short line is a bit longer and indicates $\frac{1}{8}$ "; every fourth line is middle size and indicates either $\frac{1}{4}$ " or $\frac{1}{2}$ " all of them without numbers. Every long line indicates an inch with its number

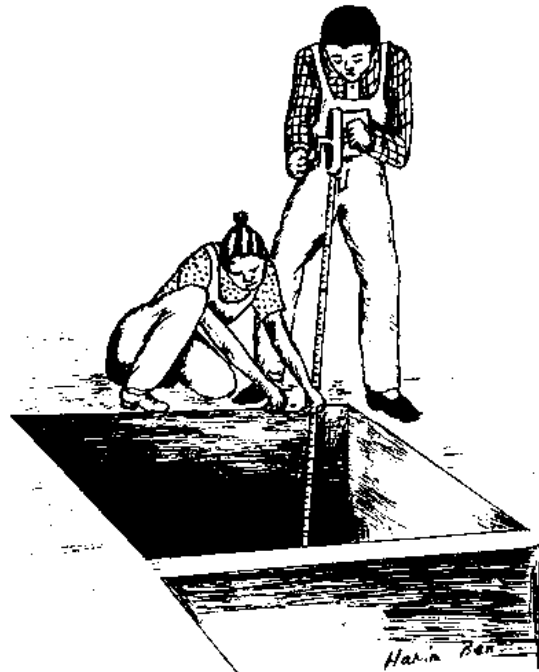

B) Spirit Level (see also 6.3/4f)

A spirit level (= plumb level) can measure whether a floor is level (= horizontal) or a wall is plumb (= vertical).

For levelling, use it like this:

- Lay the spirit level on the object to be levelled.
- Wait until the bubble has settled in the tube.
- The object is level if the bubble is in the middle between the 2 marks on the tube:

tube (= vial) for levelling

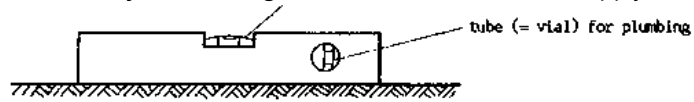

- Turn the spirit level like this:



If the indication is the same, the spirit level is functioning well.

For plumbing use it like this:

- Press the spirit level flat against the wall. There must be no gap between the spirit level and the wall.

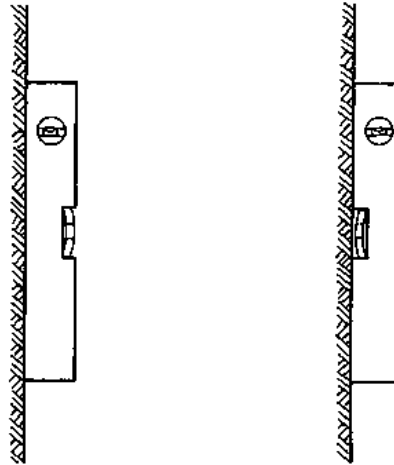

- Wait until the bubble has settled in the tube.

- The wall is plumb if the bubble is in the middle between the two marks on the tube.

- Turn the spirit level with its other edge against the wall. If the indication is the same, the spirit level is functioning well. (see drawing above).

C) Plumb Bob (see also 6.3/4f)

A plumb bob (= engineering bob) measures whether a wall, a well, etc., is plumb (= vertical) or not. For a deep well a plumb bob is more practical than a spirit level.

Use it as follows:

- Hold the wooden peg of the plumb bob against the wall.
- Slowly allow the plumb to move downwards by releasing the line. Avoid swinging movement.
- If there is a gap between plumb and wall, the wall is not plumb.
- If the plumb is resting against the wall, the wall is not plumb.
- If the plumb freely hanging just touches the wall, the wall is plumb.
- If the line is torn, replace it with a new line - never knot it.

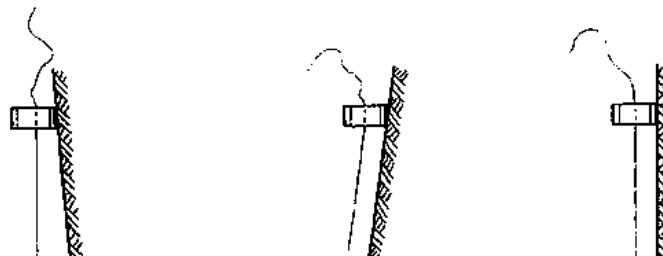
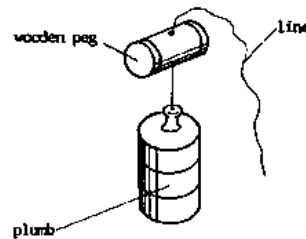

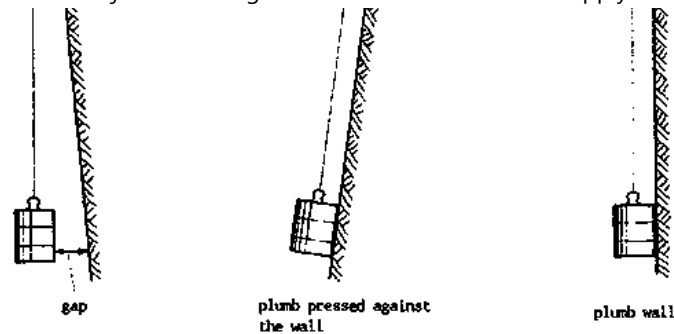

6.5 Building and Other Materials

Mt 7,24-27

The main features and properties of building and other materials are listed below in brief form.

A) Materials for Walls, etc.

1. Concrete

see chapter 6.6

2. Brick

- made from fired clay,
- lots of firewood needed and, therefore, deforestation encouraged,
- good strength,
- good resistance against weathering,
- fire resistant,
- good heat insulation,
- good sound insulation,
- allows moisture movement in the wall,
- recycling possible.

3. Mudblocks (see also 6.8)

- produced as sun-dried clay brick
- better quality if about 30% sand and 5 to 30% clay/silt,
- durable if wall protected from rain, ants and soil movement (by foundation and ant course),
- recycling possible.

4. Stabilized Mudblocks (= Mud Bricks)

- produced in block-making machine (Cinva Ram, Bre-Pack) and then air-dried,
- consisting of clay with 7 to 10% cement or lime added,
- partial hydration takes place,
- curing necessary,
- high durability,
- good resistance against rain,
- recycling possible.

B) Mortars and Plasters

1. Cement

see chapter 6.6

2. Lime

- 2 types of lime:

- * hydraulic = capable of setting under water,
- * non-hydraulic = not capable of setting under water,

- produced from heated (to 1,000°C) and ground limestone,
- water to be added before use (= "slaking"),
- slow hydration (over decades),
- durable,
- used for brick and stone walls,
- also used as whitewash for painting,
- expensive in Sudan,
- recycling possible.

3. Mud Mortar

- used for fired bricks and mudblocks,
- durable if protected against rain,
- inexpensive,
- recycling possible.

C) Locally Available Materials**1. Sand**

- fine sand suitable for water filters and plastering,
- coarse sand suitable for concrete,
- sand without silt and impurities needed for concrete.

2. Gravel

- gravel without silt and impurities needed for concrete,
- broken rock with rough surface stronger than smooth pebbles.

D) Timber**1. General Properties**

- strong; has compressive and tensile strength,
- light,
- durable if protected from moisture and ants,
- weak when wet, and strong when dry,
- strength 30 to 40 times greater along the grain than across it,
- great loss in strength at knots,
- recycling possible.

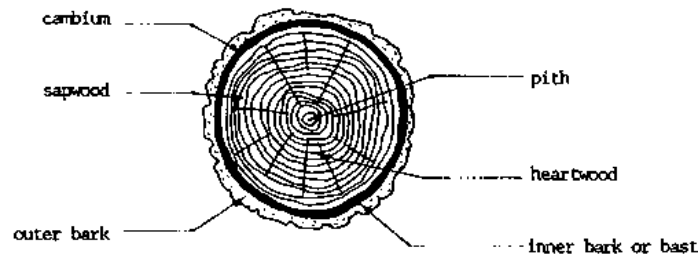
**2. Production**

- planting trees,
- cutting logs in dry season,
- drying logs (= seasoning),
- cutting logs into sawn timber,
- drying timber (correct way of storage see 7.10/3),
- ready for use, replanting trees.

3. Decay

- by weathering (sun, rain),
- by fungus attack (in wet and warm atmosphere),
- by insect attack, especially termites.

4. Protection

- by using well seasoned timber,
- by building in such a way that timber parts can dry easily and are not continuously wet,
- by ensuring ventilation,
- by ant courses,
- by painting,
- by avoiding painting before woodwork is dry,
- by painting with chemicals,
- by painting with old engine oil,
- by soaking in tar.

5. Softwood

- very soft,
- easily workable,
- grows quickly,
- no resistance against termites.

6. Hardwood

- the slower the growth, the harder the wood,
- difficult to work,
- very durable,
- termite resistant.

E) Roofing Materials

1. Zinc

- galvanized iron (= iron coated with zinc),
- very much energy needed for production,
- rust prone,
- fireproof,
- light, 
- durable,
- easy to install,
- very hot, no insulation,
- expensive,
- not locally produced,
- no recycling possible,
- rainwater catchment possible.

2. Tiles

- produced from fired clay,
- lots of firewood needed for production, therefore, deforestation encouraged,
- heavy,
- fireproof,
- no corrosion,
- can break,
- durable,
- cool,
- locally manufactured,
- relatively expensive,
- good appearance,
- recycling possible,
- rainwater catchment possible.

3. Grass (see also 6.8)

- produced by nature,
- light,
- not fireproof,

- durable only if attached in a special way and with sufficient grass,
- prevention from ants by ant course or by separation of wall and roof structure necessary,
- locally available,
- cool,
- skilled thatchers locally available,
- reasonable costs,
- recycling possible,
- not optimal for rainwater catchment.

4. Asbestos Cement Sheets

- made of cement mortar and asbestos fibres in the shape of zinc sheets,
- mining of asbestos and production causes sickness and death of many workers,
- not corrosive,
- light,
- fireproof,
- relatively durable, however, rain washes asbestos fibres into the groundwater (can cause cancer),
- hot,
- easy to install,
- expensive,
- not locally produced,
- no recycling possible,
- no rainwater catchment possible because of asbestos fibres.

5. Fibre Reinforced Cement Sheets (see also 6.6/3 and 6.6/13)

- made of cement mortar and fibres (like sugar cane, coconut, or sisal fibres) in the shape of zinc sheets.

made of common metal and metal (like galvanized, copper, or steel) in the shape of zinc sheets,

- no danger to humans,
- not corrosive,
- light,
- fireproof,
- relatively durable,
- hot,
- easy to install,
- expensive,
- eventually locally produced,
- no recycling possible,
- rainwater catchment possible.

6. Aluminium Sheets

- aluminum sheet with sharp edged profile: 
- very much energy needed for production,
- corrosion prone,
- light,
- not fireproof,
- moderately hot (because of high reflection of sun rays),
- not durable,
- easy to install,
- very expensive,
- not locally produced,
- recycling eventually possible,
- rainwater catchment possible.

F) Ferrous Metals

1. General Properties

- all made from the raw material iron ore.

all made from the raw material iron ore,

- density (= weight per unit volume in kg/dm^3 , see 5.7/1): all ferrous metals have a high density, i.e., they are heavy,
- elasticity (= the capability of metal to recover its size and shape after deformation by forces),
- plasticity (= the lack of capability of a metal to recover its size and shape after deformation by forces; the capacity for being molded or altered; the ability to retain a shape attained by pressure deformation),
- ductility (= the capability of metal of being drawn into fine wire),
- malleability (= the capability of metal of being shaped by hammering or rolled into sheets without fractures),
- hardness (= the ability of metal to withstand scratching and wearing),
- corrosion resistance (= the ability of metal to resist corrosion from water, air or acid),
- electric conductivity (= the ability to transmit electricity),
- thermal conductivity (= the ability to transmit heat or cold).

2. Wrought Iron

- less than 0.1% carbon,
- wrought (= formed by application of mechanical force) in either hot or cold state,
- almost pure iron,
- easily formed by blacksmithing,
- used for chains, crane hooks, doors, gates.

3. Steel

- 0.1 to 1.5% carbon,
- made from iron by melting,
- easily formed by blacksmithing,
- weldable,
- cannot be hardened,
- high elasticity,

limited ductility (compressive)

- **limited durability (corrosive),**
- **used for reinforcement, steel bars like equal angle steel, etc., drums for fuel, parts of cars, pipes.**

4. Stainless Steel

- **high durability (not corrosive),**
- **weldable,**
- **very expensive,**
- **used for pots, knives, watches, measuring instruments, special machinery parts.**

5. Cast Iron

- **2 to 4.5% carbon,**
- **cast (= pouring the molten metal into a mould),**
- **blacksmithing not possible,**
- **not weldable,**
- **can be hardened,**
- **brittle (= can crack and break),**
- **sparking red when ground,**
- **deep sound,**
- **used for cast parts like motor block, main part of diaphragm pump, etc.**

G) Other Metals

1. Aluminium

- **bluish silver-white metal,**
- **high strength compared to weight (low density),**
- **low hardness: soft on the surface,**
- **easy to work,**
- **no blacksmithing possible,**
- **welding only with inert gas welding,**
- **corrosion prone,**
- **surface gets grey through oxidation which protects against corrosion,**
- **easily attacked by salty water,**
- **high reflectivity,**
- **high ductility and malleability,**
- **used for tins, aluminium foil, airplanes, etc.**
- **cast aluminium used for base plate of pipe moulds.**

2. Copper

- reddish colour,
- low hardness: soft,
- high durability: no corrosion,
- high ductility and malleability,
- easily workable; also cold workable without cracking,
- can be soldered,
- green surface through oxidation,
- high conductivity for heat and electricity,
- used for electric cables, cooking pots, etc.

3. Brass

- yellow copper and zinc alloy (= molten mixture),
- workable in cold state,
- soldering possible,
- used for coating metal sheets, bearing surface, jewelry and decorations, etc.

H) Paints

1. General Properties

- preserve (= keep from decay),
- protect surfaces,
- decorate surfaces,
- enable the surface to be cleaned easily.

2. Components

- pigment (= base), a powdered substance, gives colour and provides opacity (= the quality of being impervious to the rays of light),
- liquid (= vehicle), carries the pigment and consists of binder, thinner and drier,
- binder, fixes the pigment to the surface to be painted,
- thinner (= solvent), reduces the viscosity of the paint and helps the paint to penetrate into the surface,
- drier, increases the speed of drying.

3. Oil Paints

- paint with oil as vehicle,
- for priming coats,
- for under-coats,
- for finishing coats,
- dries by evaporation of the solvent and oxidation.

4. Synthetic Paints

- paint produced by chemical synthesis,
- has a better flow than oil paint, therefore, easy to apply,
- sets quicker than oil paint, dries by evaporation of the solvent, oxidation and chemical change.

5. Metal Paints

- paint with powdered metal as pigment,
- used for primer coats to prevent corrosion.

6. Whitewash

- paint from lime and water,
- not water proof,
- used mainly for whitewashing inside walls.

7. Water Paints

- paint using water as vehicle with chemical additions,
- cement paint with white or coloured portland cement as pigment, watertight, for outside paints.

8. Varnishes

- liquid preparation forming a transparent coating when dry,
- oil varnishes,
- spirit varnishes.

6.6 Cement and Concrete

Cement and concrete are very important materials in construction, especially in water supply and sanitation. Only the most basic knowledge, important for the day-to-day work, is compiled here.

A) Cement

Cement is an adhesive substance in powdered form with the ability to bond aggregates together to form concrete.

1. Manufacture of Cement

Cement is manufactured according to the procedure shown on the next page.

The main constituents of cement are:

1. Calcium Oxide (CaO) in the limestone
2. Silicon Oxide (SiO₂) in the clay

During manufacturing and heating, carbon dioxide is removed. The final product, cement, consists of 3 CaOSiO₂. The substance produced has completely different properties from the parent substances.

If salty water is used for making concrete, the salt reacts with the cement and, therefore, less cement is left for hydration. Salt can also appear on the surface. Salt will also enhance corrosion of the reinforcement.

Therefore:

Avoid using salty water for concrete, if possible. Otherwise, add more cement.

Procedure for Manufacturing Cement:

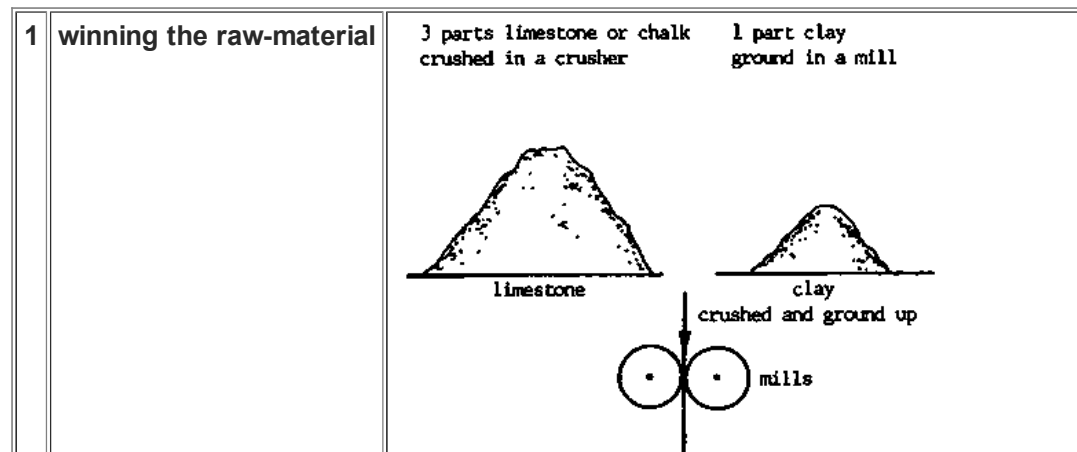

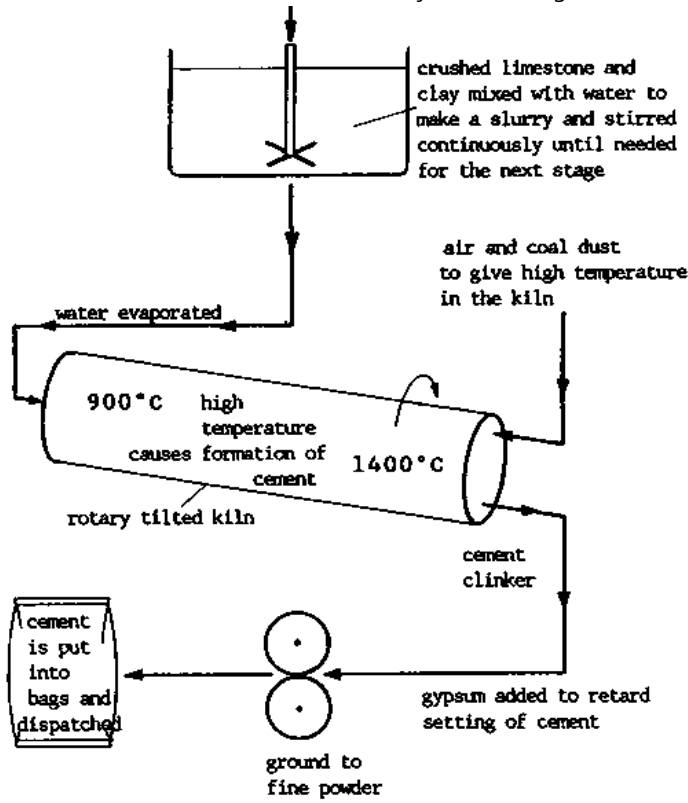

2	mixing	
3	firing	
4	grinding and treatment	

2. Hydration of Cement

The setting of cement is a chemical process called "HYDRATION". It is a chemical reaction, not just a drying process. Complete hydration takes about one year. Heat is released in the beginning of the process.



The hydration of concrete is an irreversible process. Comparison between mud and fresh concrete shows that no hydration takes place in mud mortar; the process is reversible.

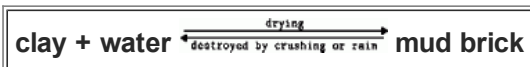

If cement comes in contact with water, hydration starts to take place

if cement once touches water, hydration starts to take place.

Therefore:

Take care that the cement never gets wet before use! Crushing hardened cement into powder never produces cement again.

B) Different Types of Concrete and Mortar

Concrete is an artificial stone made by mixing aggregates, water, and cement as adhesive substance. These components form a new body.

Mortar is a pasty substance made by mixing fine aggregates (like sand) with an adhesive substance (cement or lime or silt).

We differentiate the following types:

Type	adhesive substance	aggregates	water	reinforcement
(plain) concrete	= cement +	sand + gravel +	water	
reinforced concrete	= cement +	sand + gravel +	water +	steel
mudblocks	= silt +	sand + clay +	water	
stabilized mudblocks	= cement +	sand + clay +	water	
cement mortar	= cement +	sand +	water	
mud mortar	= silt +	sand + clay +	water	
ferrocement	= cement +	sand +	water +	chicken wire + welded mesh
fibre reinforced concrete	= cement +	sand +	water +	fibres

The different mixtures look like this:

1. Concrete (cement, sand, gravel), for example 1:3:4

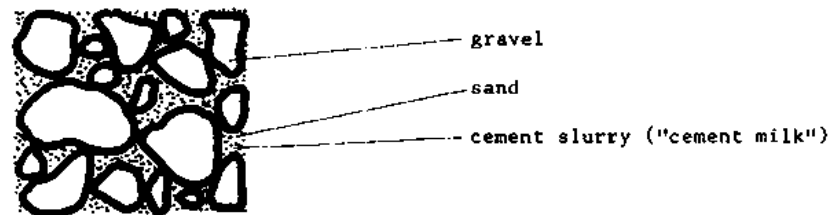

The stones have great strength themselves and contribute to the final strength of the concrete. The voids between the big stones are filled by smaller ones. All the stones are connected with each other ("glued together") with mortar (cement + sand + water) and, thus, form the final concrete.

2. Concrete with only Big Gravel

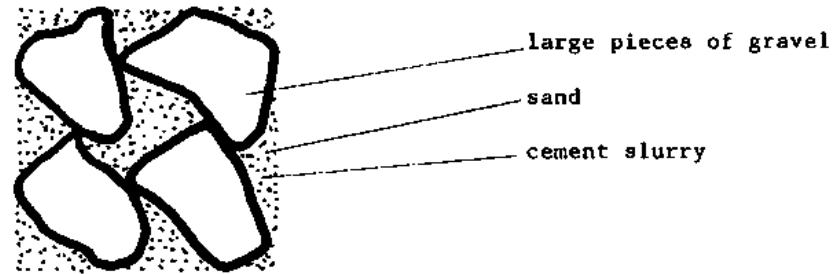

There is no middle-sized gravel to fill the voids. Such concrete is weaker. Therefore, all sizes of aggregate are needed for good concrete, such as big stones, small stones and sand. They are all embedded in "cement milk". The hardening cement milk connects all the aggregates.

Therefore:

The correct proportion of the aggregates is very important.

3. Concrete with too Much Water

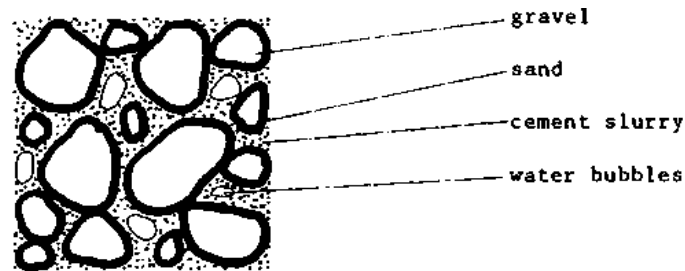

Only a certain amount of water is needed for the hydration process. The rest forms bubbles. Gradually the water in the bubbles evaporates and leaves air bubbles behind which weaken the concrete.

Concrete which is not well compacted also has air bubbles which weaken the concrete.

Therefore:

Too much water and air in the concrete reduce the strength. Mix with just the necessary amount of water and compact properly.

4. Porous Concrete, for example 1:0:4

Porous concrete is concrete without sand for filter rings, permeable for water.



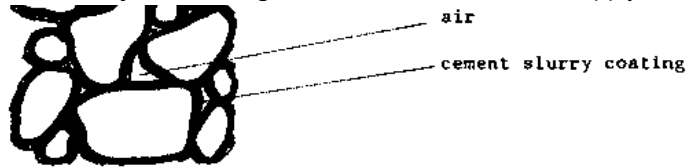

The gravel is surrounded by a thin layer of cement slurry which also connects the different stones. The voids remain empty and, later, allow the water to pass through the concrete. Obviously, porous concrete has less strength than ordinary concrete.

5. Mortar, for example 1:8

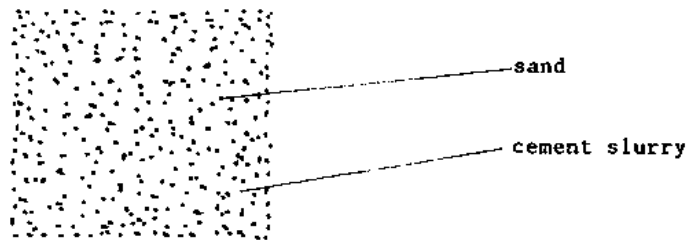

The aggregate which in the case of mortar is only sand is connected by the cement slurry.

C) Strength of Concrete

The strength of concrete grows gradually, as shown in this graph:

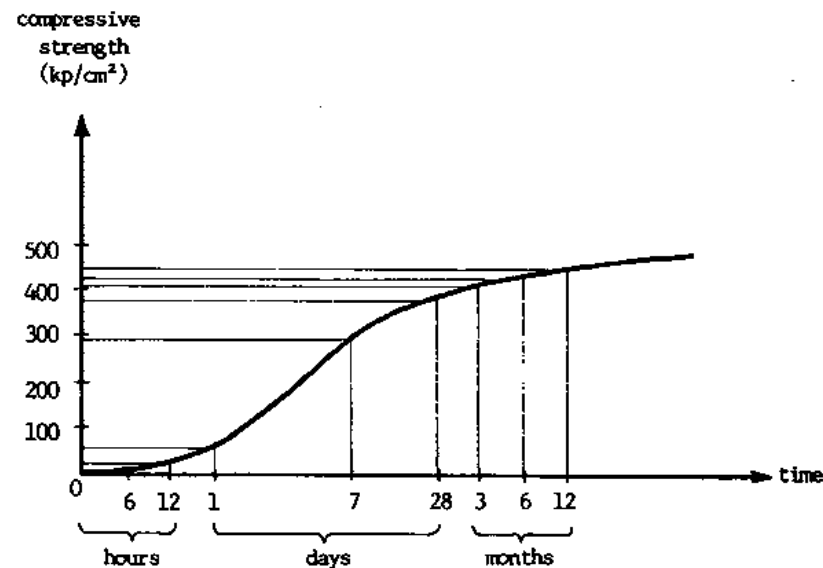

After one day, concrete is still very weak and can be easily broken. After seven days, it already has about half of its final strength, but not enough, for example, for a beam or slab to be loaded or for a hand pump platform to be used. After 28 days the concrete has almost all its final strength, and there is no need to wait for a further increase in strength. The concrete can be fully used.

Too early loading of concrete may cause inward cracks which are not visible outside but which greatly reduce the strength of the concrete and invite further destruction.

The concrete has no strength in the first days. If it is allowed to dry too quickly or is even exposed to sun, it will shrink and develop cracks. These cracks will never close again. If the concrete is kept wet, cracking is avoided until the strength has developed. Afterwards the concrete will develop no cracks (or fewer cracks). Cracks lead to further destruction: Water will enter and cause corrosion of the reinforcement, and the concrete will start to break and crumble further with time.

Therefore:

- Do not step on fresh concrete on the first day.
- Shutters can be removed after 6 to 12 hours from the side.
- Slabs or beams need to be supported from underneath for 3 weeks!
- Turn over concrete rings after 48 hours, at the earliest.
- Do not lift slabs before 7 days.
- Do not load slabs or beams before 3 weeks.
- Do not lower a concrete ring before 3 weeks.
- Do not pump on a handpump platform before 3 weeks.

- Keep the fresh concrete wet for 3 to 7 days.

D) Making Good Concrete

Two different pieces of concrete work might look the same immediately after completion, but the difference shows later. Making good concrete requires a lot of effort and hard work. The result will be a very durable concrete. Concrete can also be made carelessly. This concrete will later crack and spoil. Although the workers have seemingly saved work and time in the beginning, eventually it will turn out that both work and material were wasted.

For making good concrete, keep the following rules:

1. Use clean, sieved sand (silt content less than 0.5%).
2. Use clean, washed gravel.
3. Remove all organic material like grass, leaves, and mud. Organic material disturbs the chemical process of hydration.
4. Use the materials in the correct proportion (= mixture).
5. Use enough water for good workability, and no more. Too much water reduces the strength.
6. Use clean water and, if possible, not salty water.
7. Mix the concrete very well to ensure that every grain of the aggregate is coated with the binding material so that maximum strength is assured. First, mix sand and cement while still dry. Turn the heap over at least three times until it has an even, grey colour. Add water. Do not pour the water from high, but slowly and gently. Turn over again three times. Add gravel. Turn over again.
8. Pour the concrete gently, not from high, and compact it well. All air bubbles, which weaken the concrete, must be removed.
9. Keep the concrete wet for three to seven days depending on the climate. This is called "curing". Cover the concrete with wet sand about three hours after pouring and with nylon sheets, or with wet sacks. Pour water over it daily.

E) Properties of Concrete

Good concrete has the following properties:

- It is easy to cast into any form.
- It is very strong.

It has a high compressive strength (= strength to resist compression or being pressed together).

It has a very low tensile strength (= strength to resist tension or being pulled or stretched).

- It is very durable.

- It is a bad insulator, because it has no air bubbles. Concrete houses are very hot.
- Concrete walls do not “breathe”, that is they do not allow any exchange of air and, therefore, concrete creates an uncomfortable atmosphere for human beings.
- It has bad sound insulation.
- It is very difficult to break down concrete and discard it when it is no longer needed. It cannot be recycled.
- It needs little maintenance.
- Concrete is not fireproof. Concrete cracks in fire and reinforcement melts.

These properties qualify concrete as the optimal building material for some purposes (e.g. well rings, latrine slabs, etc.) and not the optimal material for others (e.g. walls for accomodation, etc.).

F) Reinforced Concrete

1. Concrete Reinforced with Steel

Non-reinforced concrete is used where only compressive strength is required; that is, in all parts which are continuously supported, like foundations, floors, etc., where the concrete is only pressed.

Reinforced concrete is used where both compressive and tensile strength are required, because the parts are not continuously supported, i.e., in beams, slabs, ventpipes.

The “tasks” are distributed as follows:

- Concrete, cheap and light, takes the pressure.
- Reinforcement, heavy and expensive, takes the tension.

The concrete protects the reinforcement from corrosion, because it prevents air and water from reaching the reinforcement. This protection can only work if the rods are well embedded in the concrete and if there are no (or few) cracks.

Therefore:

Reinforcement must never be seen on the outside surface of the concrete. There must always be 1-2 cm concrete between the surface and the reinforcement.

2. Position of Reinforcement

Correct positioning of the reinforcement is essential. If the reinforcement is put into the wrong position then the beam, slab, etc., will have no strength to carry their load. The correct position of the reinforcement is determined by the planning engineers.

Therefore:

Place the reinforcement exactly into the location where indicated on the plan.

The position of the main reinforcement of some parts is explained here for better understanding.

First, imagine how the part would bend under load and where it would start to crack. The reinforcement is placed on the side where the part would be stretched. The reinforcement shall prevent the cracks by holding the part together.

Example 1: Supported Beam (or Slab)

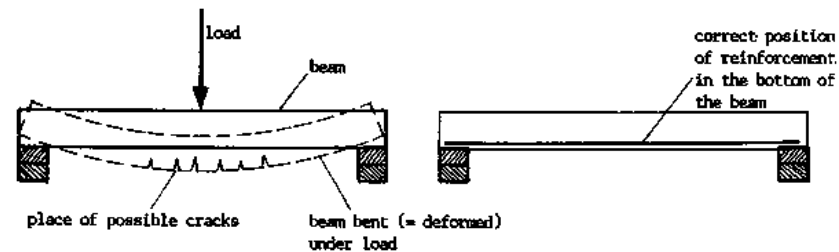

Note: The deformation (= bending) of the part is exaggerated in this and all following drawings!

Example 2: Cantilever

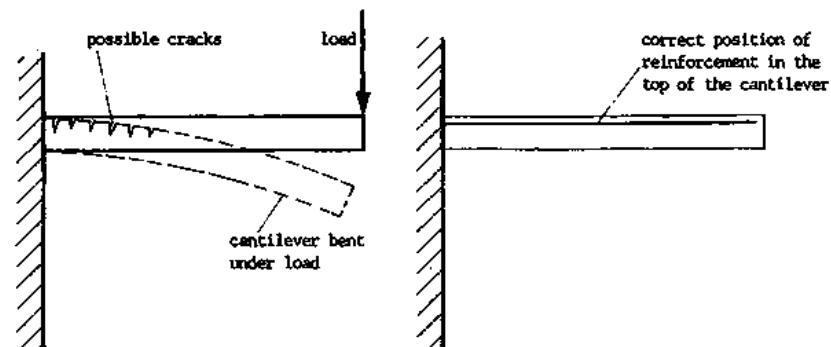



Example 3: Concrete Ring (when rolled on the ground or used as culvert)

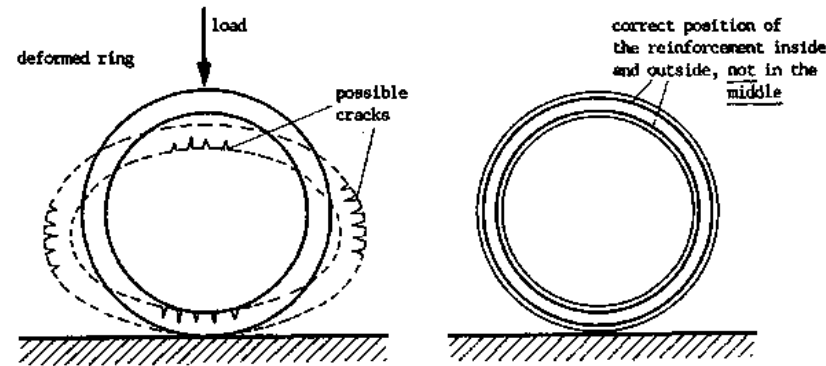

Example 4: Concrete Ring (in the well)

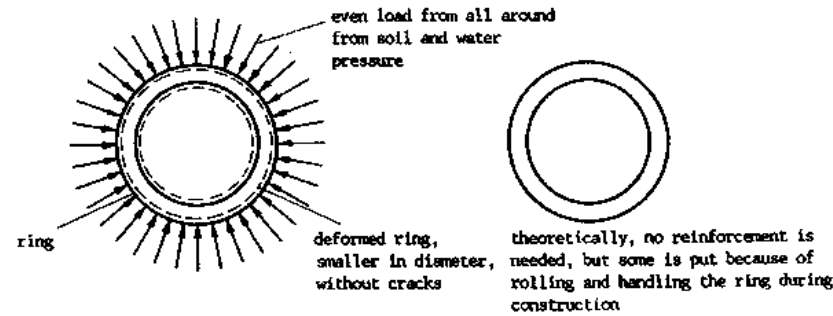

Example 5: Foundation Slabs for Buildings on Black Cotton Soil

Black cotton soil contracts and expands seriously according to the water content and develops big cracks in dry season. It can cause foundations and buildings to crack. Therefore, foundations for buildings on black cotton soil need to be reinforced.

The soil can make the foundation bend in two ways:

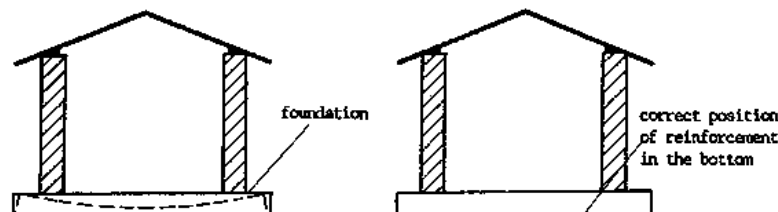

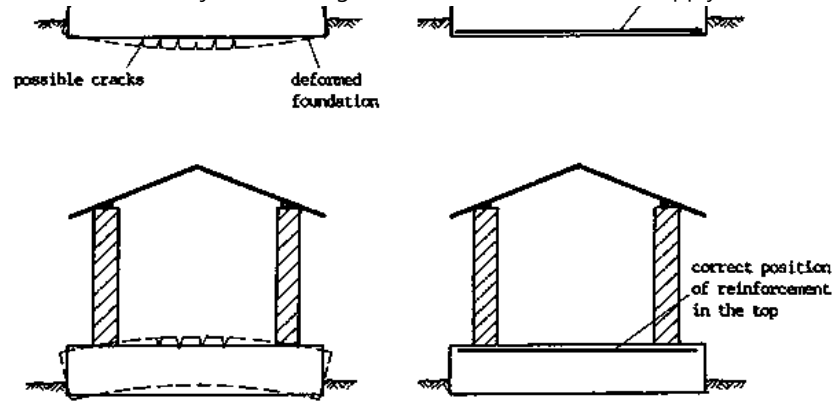

Therefore, reinforcement is needed in the top and the bottom of the foundation: not in the middle.

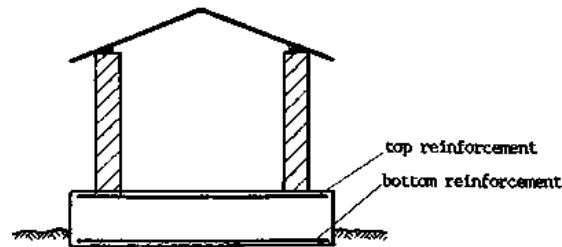

Example 6: Columns (can be bent into any direction; therefore, they need reinforcement in all corners)

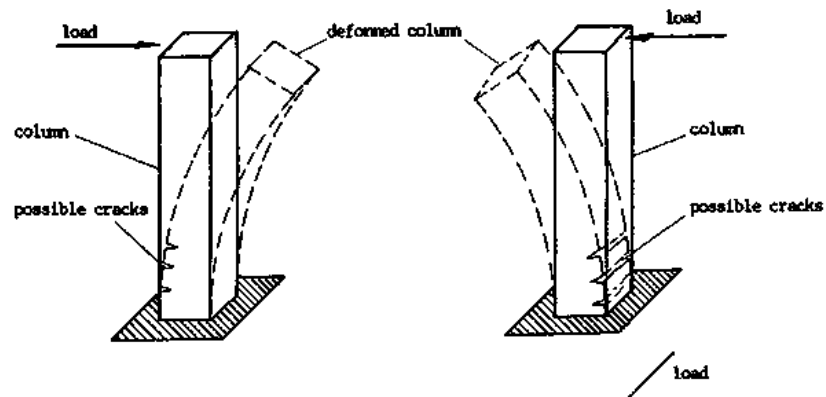

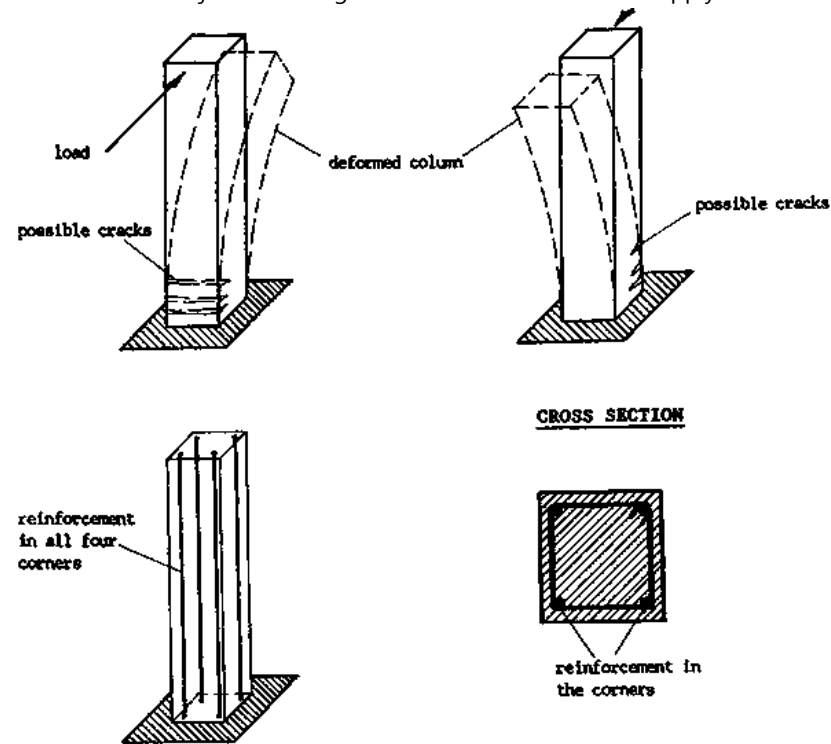

Example 7: Water Catchment Tanks

Water catchment tanks are continuously supported. Therefore, they do not need reinforcement to carry loads (to prevent bending). However, they are reinforced with welded mesh or chicken wire to prevent any cracks and ensure they are watertight.

3. Ferrocement

Ferrocement is cement mortar reinforced with chicken wire (or sometimes welded mesh). This reinforcement gives strength and ensures water tightness. The smaller the meshes of the reinforcement the better they prevent cracks in the mortar and, thus, ensure water tightness.

4. Fibre Reinforced Concrete

Fibre reinforced concrete is cement mortar reinforced with fibres. Short fibres which provide the tensile strength are mixed with cement mortar. Then the mixture is formed into diverse shapes like roofing sheets, pipes, etc.

The fibres used can be fibres from plants, like sugar cane, coconut, or sisal, or asbestos fibres. Asbestos is found in underground deposits. The mining and production of asbestos is very harmful to the health of the workers involved. Therefore, the use of asbestos should be avoided.

G) Mixtures

For good concrete, the ingredients must be in the right proportions. For example,

cement : sand : gravel = 1 : 3 : 4

That means:

Mix one part cement with three parts sand and four parts gravel.

We say that the amounts are in the ration 1 to 3 to 4.

Cement is always given as the first figure with 1.

Accordingly, if you need more concrete, you can mix:

$$1 \times 2 = 2 \text{ buckets cement} \quad 1 \times 1\frac{1}{2} = 1\frac{1}{2} \text{ buckets cement}$$

$$3 \times 2 = 6 \text{ buckets sand} \quad \text{or} \quad 3 \times 1\frac{1}{2} = 4\frac{1}{2} \text{ buckets sand}$$

$$4 \times 2 = 8 \text{ buckets gravel} \quad 4 \times 1\frac{1}{2} = 6 \text{ buckets gravel}$$

and still have the same proportion (= ratio).

The most important mixtures are:

Ratio	Concrete/Mortar	for
1 : 2 : 4	watertight concrete	water tank
1 : 3 : 4	very strong concrete	concrete rings for wells
1 : 4 : 3	easily workable concrete	latrine slabs
1 : 4 : 6	ordinary concrete	foundation, etc.
1 : 0 : 4	porous concrete	filter rings
1 : 2	very strong mortar	ferrocement
1 : 4	strong mortar	surface of well platform
1 : 8	ordinary mortar	plastering



6.7 Bricklaying

The most basic skills of brickwork, necessary for a water supply technician, are compiled here. They consist of building “half brick walls” and “one brick walls” necessary for compost latrine construction. Obviously, a fully trained bricklayer needs to know much more than is presented here.

A) Bricks

Bricks are made from fired (= burnt) clay. Clay soil is mixed with sufficient water; the mould is wetted; the clay is pressed into the mould; the surplus is removed, then the mould is removed. When dry, the brick is fired in a kiln.

The quality of hand-made bricks can vary a lot. It depends on the type of clay, the quality of manufacturing, the curing and the firing. The quality can be affected in the following ways:

1. **Size:** great variations in size
2. **Shape:** curved bricks
3. **Strength:** easily breaking or crumbling bricks

It is an art to build straight and strong walls even with bricks of poor quality.

B) Mortars

Mortar is a composition of certain materials, used for the bedding and connecting of bricks in a wall. Mortar consists of the “body” (= aggregate), which is sand, the “binding” material, which is lime or cement or silt, and water.

1. Type of Sand

There are two varieties of sand: sharp and loamy. “Sharp” sand has sharp-cornered or angular grains, like this:



Mortar from sharp sand alone has great strength, but is not easy to work with.

“Loamy” or “soft” sand has rounded grains like this:



Mortar from loamy sand alone is weaker than mortar from sharp sand.

It is sticky and tends to hang to the trowel like glue. Sometimes, loamy sand tends to be clayey (i.e. has a clay content), and this type must not be used.

The best aggregate for a bricklayer’s mortar is a mixture of sharp and loamy sand.

2. Proportion of Mixture

If hard, dense bricks of very low porosity and high crushing strength are to be used, then a dense mortar (1:3) is suitable. If porous bricks of low crushing strength are to be used, then a lower grade mortar is suitable. (If a dense or strong mortar is used in conjunction with a porous type of brick, the mortar bed tends to shrink away from the bricks, leaving cracks.)

3. Amount of Water

The amount of water needs to be determined by experience, taking the temperature of the day into account. The mortar needs to be sufficiently fluid to allow the spreading on an even bed. Too much water, however, reduces the strength of the mortar.

C) Terminology

Special vocabulary is used in the bricklaying trade. Some words are explained here:

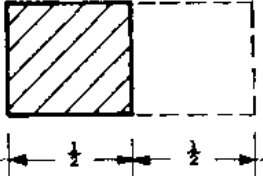
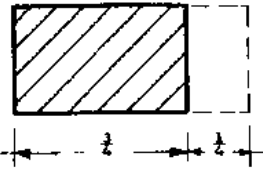
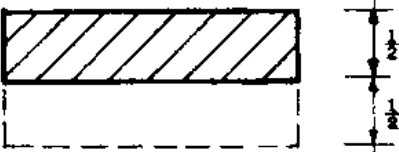
stretcher:	brick which is laid parallel to the wall	
header:	brick which is laid across the wall	
half-brick wall:	wall with the thickness of half of the length of a brick, built from stretchers only	
one-brick wall:	wall with the thickness of the length of a brick, built from stretchers and headers.	
$\frac{1}{2}$ bat:	cut brick of this shape:	
$\frac{3}{4}$ bat:	cut brick of this shape:	
closer:	cut brick of this shape:	

D) Measurements

In Sudan, you find bricks of many different sizes. However, the standard size is:

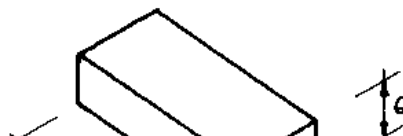

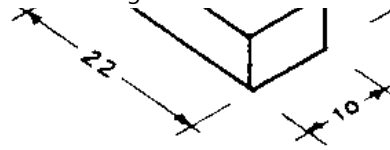

220 mm x 100 mm x 60 mm
or
22 cm x 10 cm x 6 cm

20 mm are allowed for the thickness of the vertical mortar joint, 15 mm for the horizontal mortar joint. The space the brick occupies in a brickwall including the mortar joints is called nominal size. It is:

240 mm x 120 mm x 75 mm
or
24 cm x 12 cm x 7.5 cm

The size of bricks is standardized in such a way that stretchers and headers can easily form a one-brick wall. Two stretchers in a wall with mortar in between are as wide as one header:

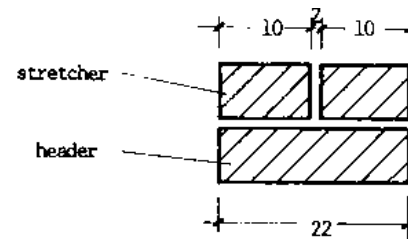

width of one brick: 10 cm

width of one brick: 10 cm

width of mortar joint: 2 cm

length of one brick: 22 cm

In height, 4 rows (= courses) of bricks must equal 30 cm. Each course must equal 7.5 cm.

Measure always from/to the top of a brick in a course.

Four courses to 30 cm!

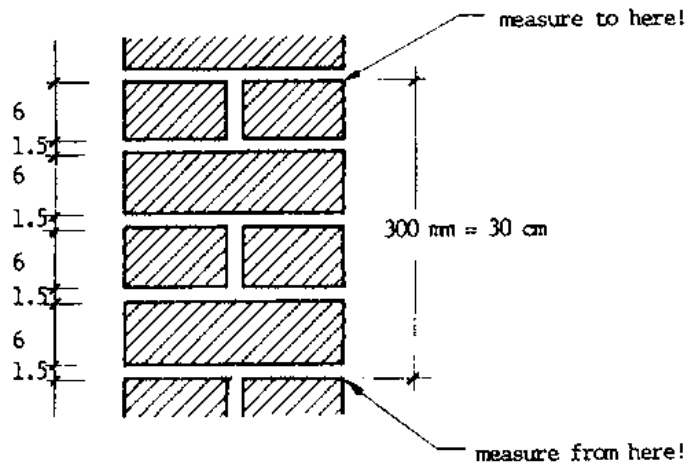

4 x 6 cm = 24 cm

4 x 1.5 cm = 6 cm

30 cm

Along the wall, 5 stretchers with their joints must equal 120 cm = 1.20 m

Five stretchers to 120 cm!

measure from here!

measure to here!

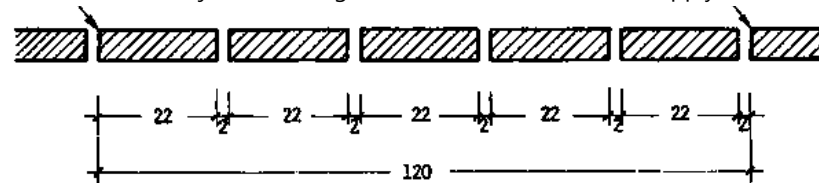

$$5 \times 22 \text{ cm} = 110 \text{ cm}$$

$$5 \times 2 \text{ cm} = 10 \text{ cm}$$

$$120 \text{ cm}$$

To determine how many bricks make up a wall, divide the length of the wall by the nominal length of the brick. Small differences can be balanced by increasing or decreasing mortar joints sizes. These measurements are valid for bricks which keep more or less to the standard size and shape. For high quality bricks which keep more exactly to the standard size, the mortar joint may be only 1 cm thick.

D) Bonding of Brickwork

To maintain strength, bricks must be lapped one over the other in successive courses. A quarter-brick lap is called “quarter-bond”, a half-brick lap is called “half-bond”. If the lap is greater or smaller than these, both appearance and strength are affected. If bricks are so placed that no lap occurs, then the “cross joints” (= vertical joints) are directly over each other, and this is called “straight joint”. An “external straight joint” appears on the face of the wall; an “internal straight joint” occurs inside the wall.

Half-Brick Wall

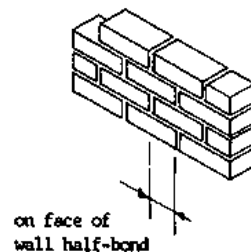

One-Brick Wall

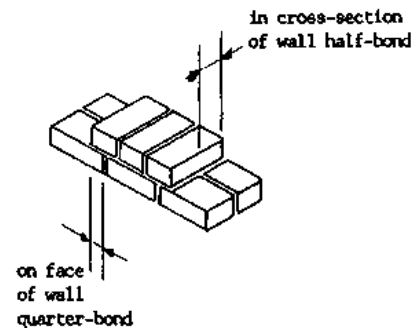

If no closer is inserted, straight joints, either internal or external, occur:

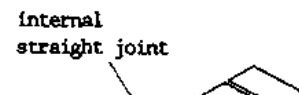

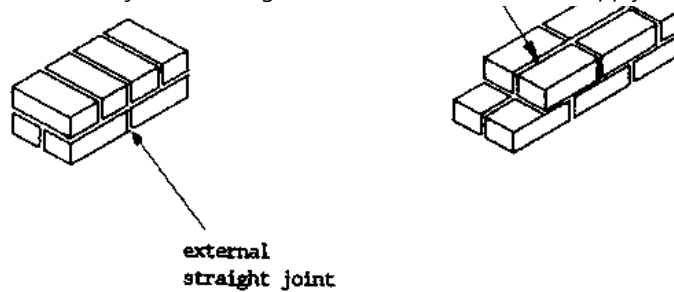

In the following, the bonding of half-brick wall (= stretcher bond) and one-brick wall (= English bond) shall be discussed only. These two types are mostly used in hot climates. The bonding of a one-and-a-half-brick wall (occurring in cold climates) is much more complicated.

For each type of wall we need to know how to build

- the straight wall,
- a stopped end (for doors and windows),
- a corner,
- a T-joint (= cross wall).

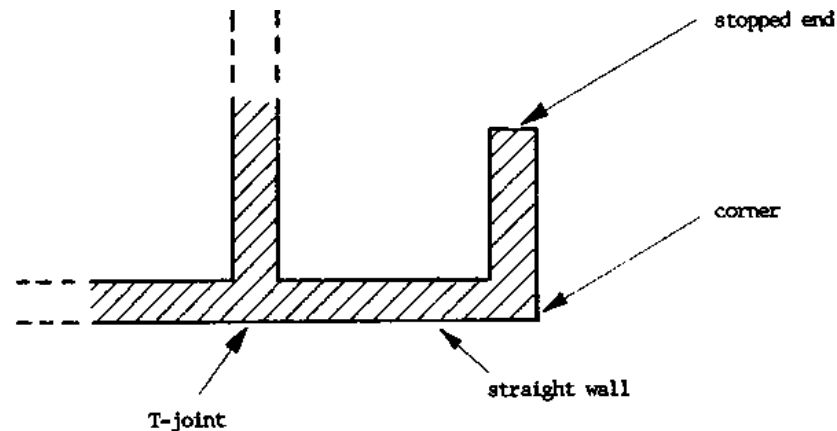

The basic rules of bonding are:

1. Avoid external straight joints at all times and
2. Avoid internal straight joints wherever possible.
3. Use whole bricks wherever possible.

Applied to the different types of bonds and walls this leads to specific rules:

1. Half-Brick Wall in Stretcher Bond

Half-brick walls are built in stretcher bond, consisting entirely of stretchers. Keep to the following rules:

1. Maintain half-bond at all times (except T-joints).
2. No bats are necessary for a corner.
3. Use half-bats for a stopped end.
4. Use 2 three-quarter bats for T-joints.

First Course

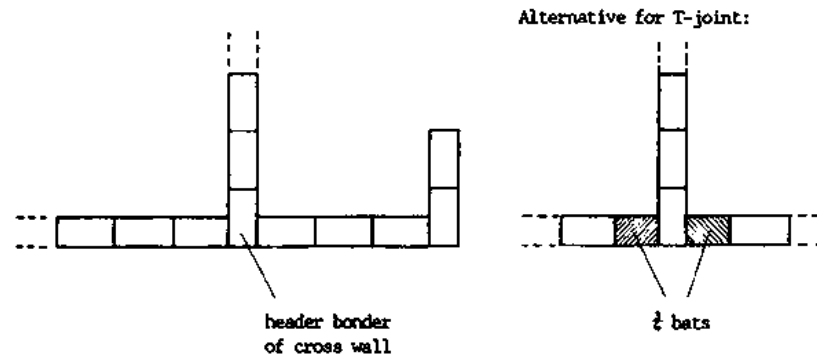

Second Course

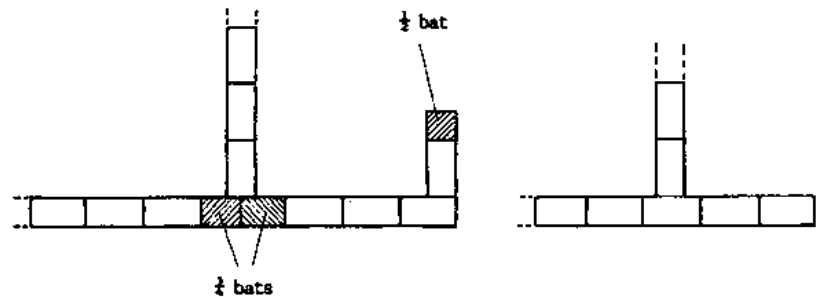

Front View



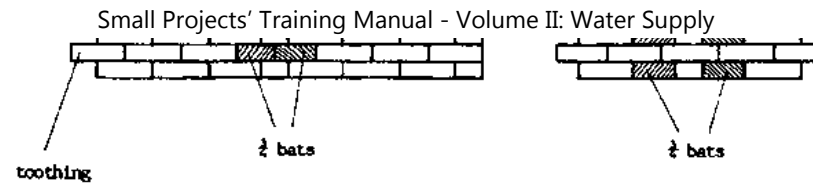

Isometric View

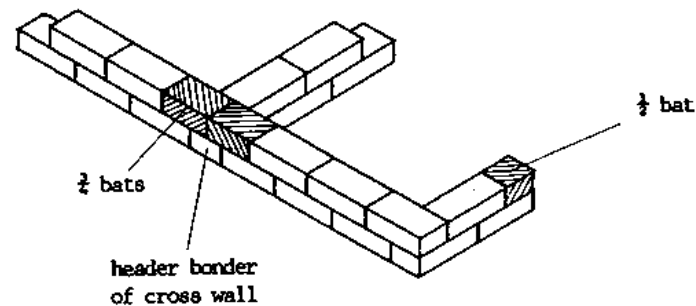

If the first two courses have been set out correctly, they repeat themselves, and the vertical joints in every other course will be upright or “plumb”. The bricklayer checks this by plumbing the vertical joints at every 90 cm or so, along the wall.

2. One-Brick Wall in English Bond

One-brick wall can be built in English or Flemish bond. The latter will not be discussed here. English bond consists of alternate courses of headers and stretchers. It is a very strong bond without any straight joints.

Keep to the following rules:

1. Maintain quarter-bond at all times.
2. A closer (= a brick cut half along its length) must follow the corner header.
3. A closer must follow the last header of a stopped end.
4. A closer must follow the stretcher of a T-joint.
5. In every change of direction on the same course the bond changes from stretcher to header and the other way round.

First Course

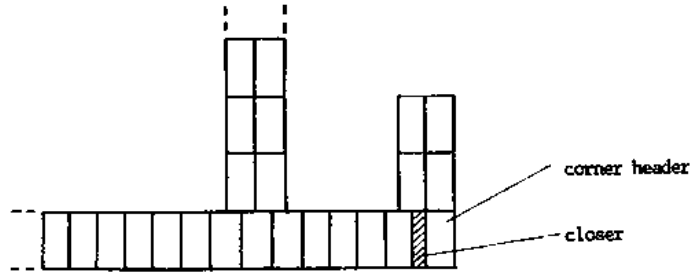

Second Course

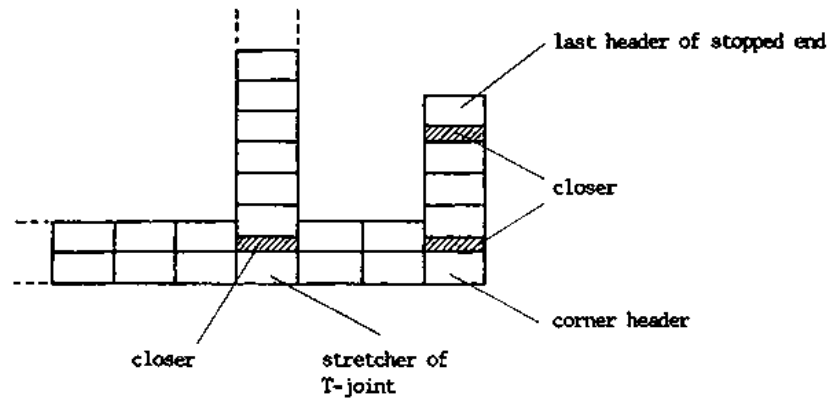

Front View

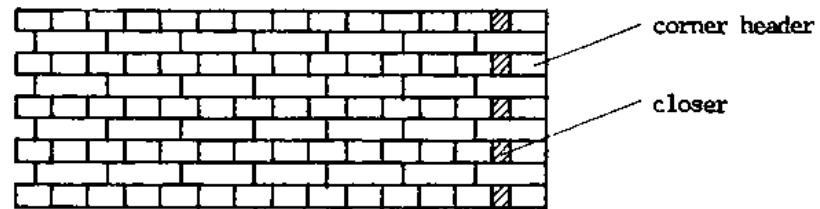

Isometric View

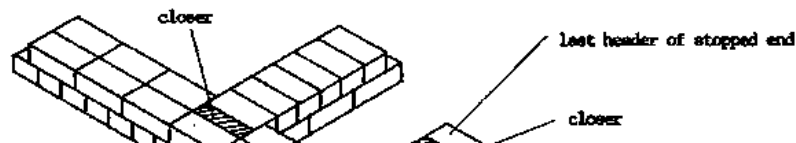

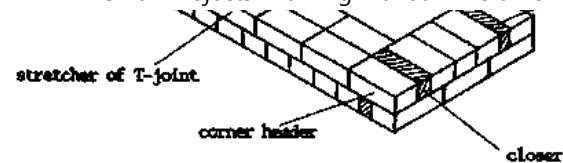

The first two courses repeat themselves when you continue to build the wall.

3. Broken Bond

If the length of a wall does not fit to brick size, a cut brick must be inserted somewhere in the length of the wall to make up its size. The cut brick should not be less than half-brick. The usual procedure is to set out the correct bond from each end of the wall, placing the broken bond as near the centre as possible. However, if there is little difference, the increasing or decreasing of mortar joint sizes will often allow complete bricks to be used.

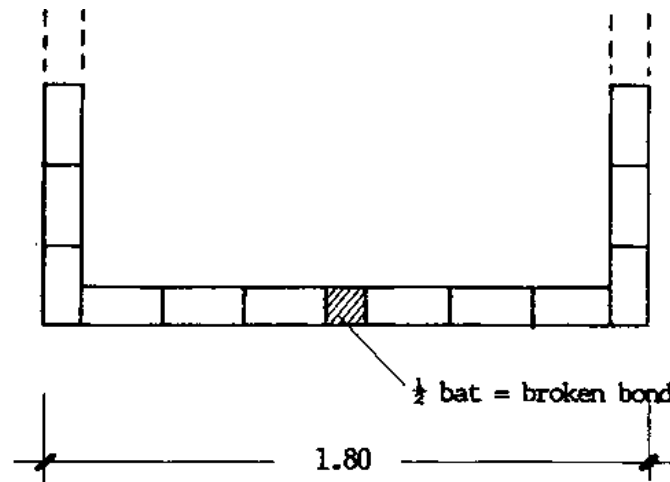

E) Craft Operations

Some techniques on how to do good brickwork are explained here.

1. Basic Principles

Two basic principles help to do good brickwork:

1. Never allow quality to be sacrificed for speed.
2. Maintain general cleanliness.

Especially the beginner should never allow quality to be sacrificed for speed which will be attained by constant practice. Never allow brick rubble and mortar

droppings to collect under your feet. A clean working place, clean mortar board and general cleanliness are important. Mortar should never be allowed to harden on the blade of the trowel, as this creates a rough surface and prevents free and easy movements when picking up and spreading mortar. Clean all tools after work. Your working place should be organised: piled bricks and mortar at a convenient distance.

2. Operation

The main bricklaying operation is spreading the mortar to an even bed. This needs practice and a keen eye. Always wet bricks before laying them by dipping them into a bucket of water. This will wash off surplus dust and prevent undue absorption of moisture from the mortar bed. Do not grasp the trowel as if clenching the fist, but place the thumb on the handle lightly so that a flexible wrist action is possible. Pick up the mortar with an easy sweeping motion and spread it on the wall sufficiently thick to allow the brick to be placed by pressure of the hand. Do not place too much mortar under the brick, because this will require considerable hammering before the brick reaches its final position.

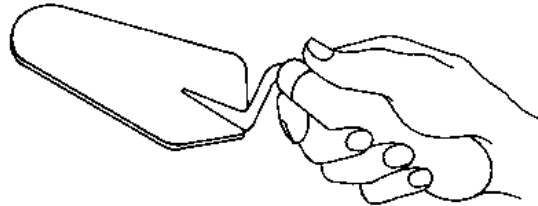

Method of grasping the brick-trowel

If bricks are curved, it is difficult to keep a flat surface of the wall and to prevent "hatching and grinning".

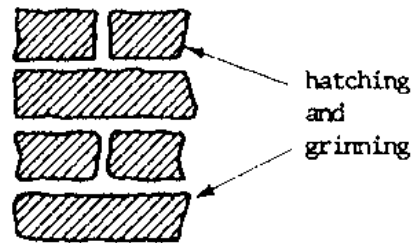

If bricks are curved, lay them always with the curve upwards like this:

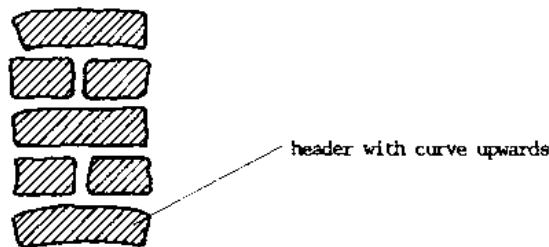

Never lay them with the depression upwards, because this makes the laying of the next course difficult:



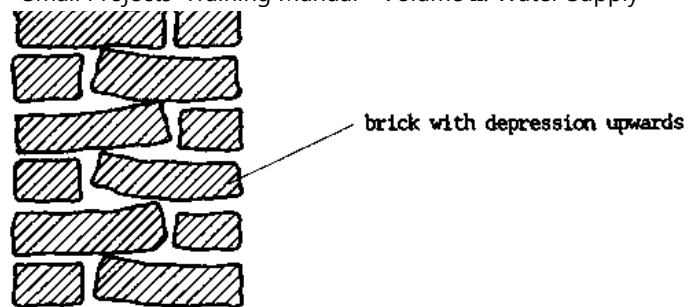

3. Keeping to Measurements

Normally, corners are erected ahead of time before building the walls. First, erect approximately six courses of brickwork at the corners. Make sure that the corner is plumb by using the spirit level or plumb bob. Use a straight edge to make sure that the wall is in alignment. Make sure that the thickness of the courses is kept by a gauge peg. The wall itself is to be racked back.

Building for level:

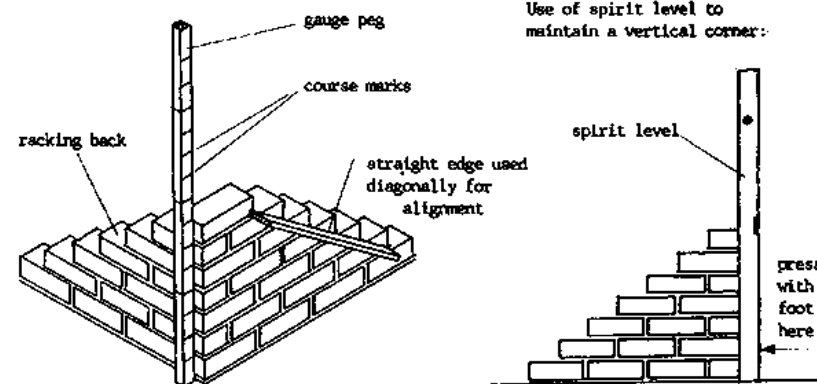
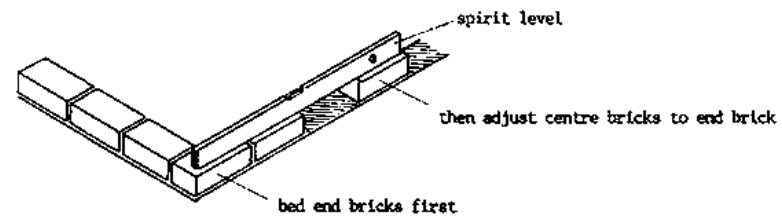

Then use a line and pin for building the straight walls or use two wooden corner blocks.

Use of line and pin:

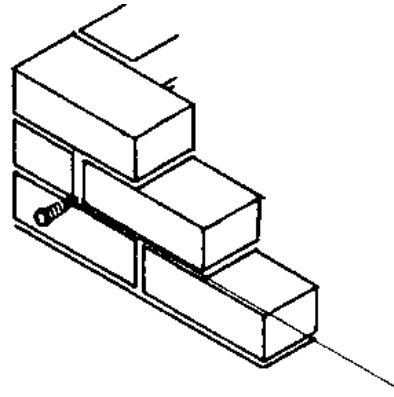

Use of wooden corner blocks: wooden corner block

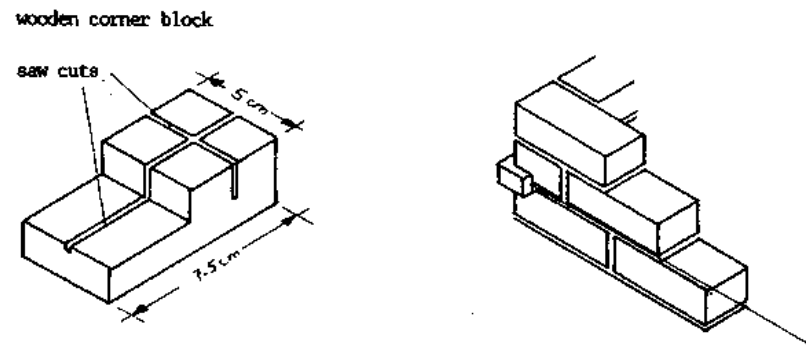

When laying bricks along a line, always ensure that a trace of daylight can be seen between the line and the brick. This prevents the laying of the bricks too hard to the line. To keep the wall flat (= to prevent hatching and grinning), imagine laying the outside surface of the brick parallel to the line and the edge of the last course. Watch out for this even if it means that the surface of the course is not level.

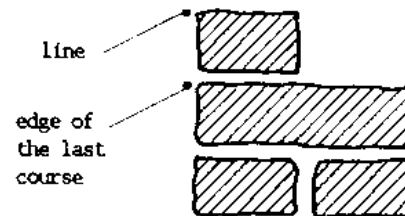

If the bricks are of uneven shape, only one side of the wall can be built flat, either inside or outside.

6.8 Improved Local Building

The technologies on how to build with local materials like poles, earth, bamboos, grass, etc. are widely known and are not to be described here. However, some suggestions for improvements are compiled here, both for a house constructed from poles and earth, and for a mudblock house. Select the suggestions which are possible and suitable for your conditions.

A) Measures without Additional Costs

1. Build your house, especially a two-room house, in an East-West direction. The rising and the setting sun should shine on the smaller walls. The sun should never shine on the longer walls. This will make your house cooler.

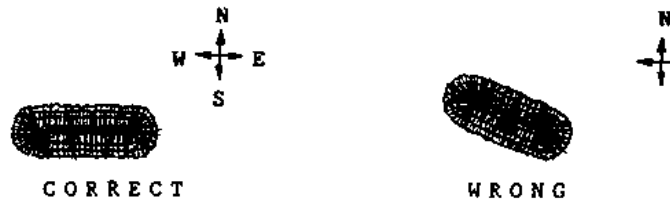

2. If possible, build your house with a shade-giving tree on the eastern and/or western side of the house

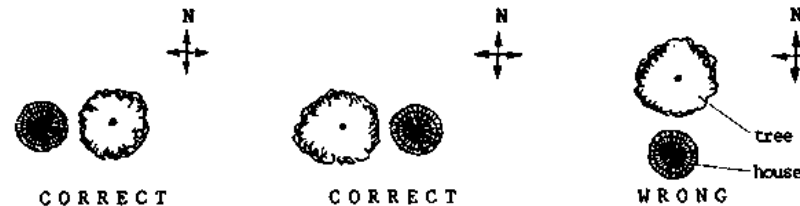

3. Plant trees on the east and west sides of your house.

4. Cut the poles and bamboos in dry season.

5. Choose ant-resistant types of wood.

6. Store them in an elevated place, not directly on the ground.

7. Before building, check the mud with the following tests:

a) Sedimentation Test

- Take a transparent glass jar of one litre or more with a sufficiently wide top opening; it must be cylindrical with a flat bottom.
- Fill the jar upto one quarter of its height with the soil to be used for building.
- Add clean water up to the top of the jar

Fill clean water up to the top of the jar.

- Close the jar with your hand and shake it well until water and soil are thoroughly mixed.
- Put the jar on a level surface.
- After one hour, shake the jar well and put it on a level surface again. Now the jar must be left untouched without any movement.
- After 45 minutes, you can measure the thickness of each of the different layers and compare each with the total thickness of all the soil in the jar. This gives you the percentage of the amount of gravel, sand, clay, and silt in the soil.
- Soil suitable for building should consist of at least 33% sand and between 5% and 30% clay/silt. If the soil is not suitable, add sand or clay accordingly. A good mixture for example would be

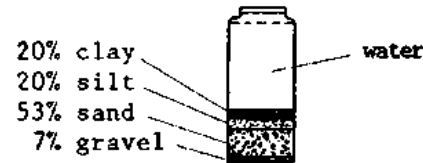

b) Compaction Test

- Take a handful of dry, screened (= sieved) earth and moisten it until it is damp enough to form a ball. It should not be so damp that it will leave more than a slight trace of water on your hand.
- Drop the ball from the height of your shoulders onto hard ground. If the ball breaks into a few smaller pieces, the mixture is all right. If it breaks into many pieces, it contains too much sand. If it does not break into any pieces, it contains too much clay and silt for building.

8. Build with mudblocks, if possible.
9. If you build with mudblocks, build a foundation either of mudblocks or of stones.
10. Build the inside floor 10 cm higher than the ground level outside.
11. Mix sand or the soil of anthills or cow dung or merissa residue into the mud for smearing floor and walls.
12. Plaster the walls and use a trowel to smear the floor.
13. Keep all fresh mud work out of the sun.
14. Provide enough ventilation.
15. Leave sufficient space between wall and roof in order to be able to clean the termites away.
16. Fix old tires between the wall and the roof truss to hinder the termites.

16. Fix old tins between the wall and the roof truss to hinder the termites.

17. Protect the wall bottom from being washed out as illustrated in this drawing:

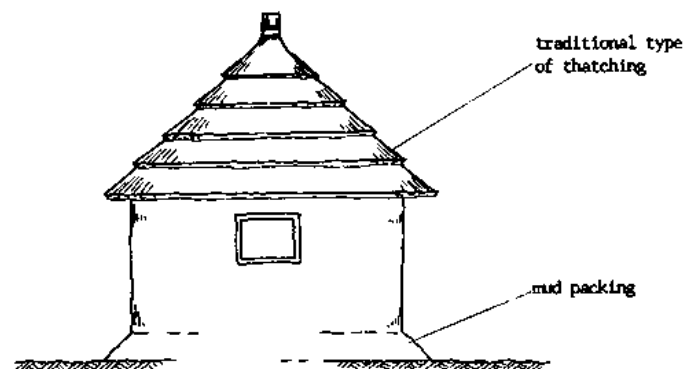

18. Dig a drainage ditch around your house, if necessary.

19. Smear and repair the house frequently. Especially, repair cracks immediately, if possible.

B) Measures with Additional Costs

1. If you build with poles and earth, build the structure for the roof separately from the walls. The poles should not touch the walls at any point in order to control termites.

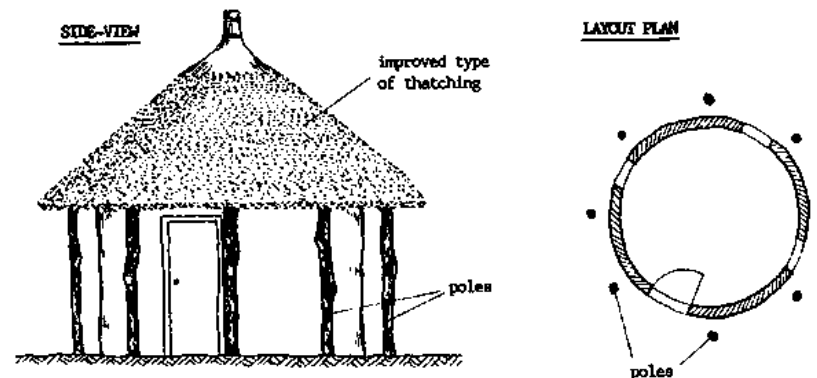

2. If you build with mudblocks, build an ant course from concrete with two layers chickenwire, 5 cm thick. It is extremely important, to keep the concrete wet for 7 days to prevent cracks which would allow termites to penetrate (see 6.6/7).

Alternatively, you can use bituminous foil or flattened zinc sheets for an ant course. They must be 10 cm above floor level and folded at the joints.

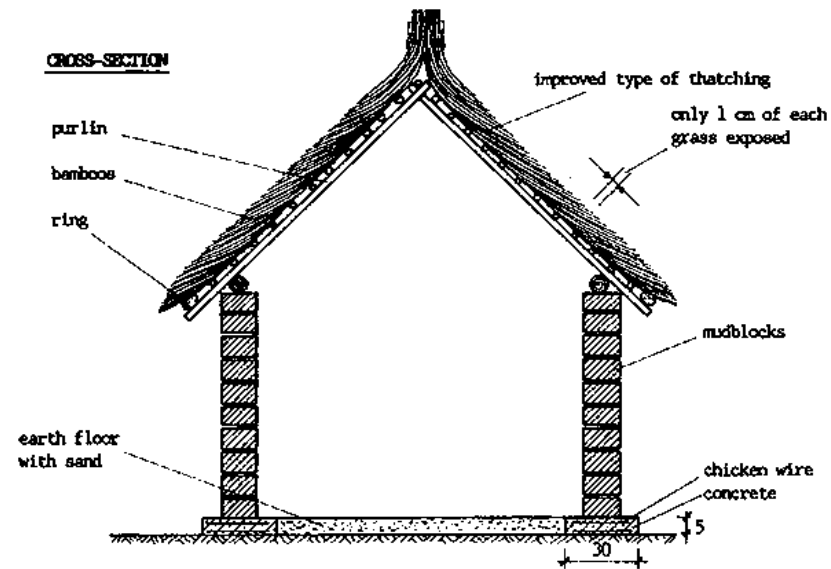

3. Build the walls higher than in the traditional way.
4. Build big windows with shutters on the opposite side of the building.
5. Fix mosquito screening between walls and roof.
6. Thatch with the improved thatching method which builds a roof with a continuous surface without steps. This method requires about 50% more grass, but lasts many years longer. More information is available from the Support Unit, Community Development Department, Juba, or from the literature.
7. Building Administration





7.1 Planning

Realistic planning is essential for properly organizing the work and to avoid confusion and disappointment of communities and owners. Planning helps to streamline one's efforts, to prepare everything in time for the work, and to avoid unnecessary delays. However, planning should be a helpful tool, not a rigid principle to enforce. Therefore, plans should be made and, if necessary, altered according to circumstances. Having to alter your plans should not discourage you from doing any planning at all. The benefits of regular planning will show in the long run.

Planning of construction work is best done in four steps: checking the resources needed, timing, filling the diary, and preparing lists of materials and equipments.

A) Checking the Resources Needed

When you plan practical construction work, always use the following check list:

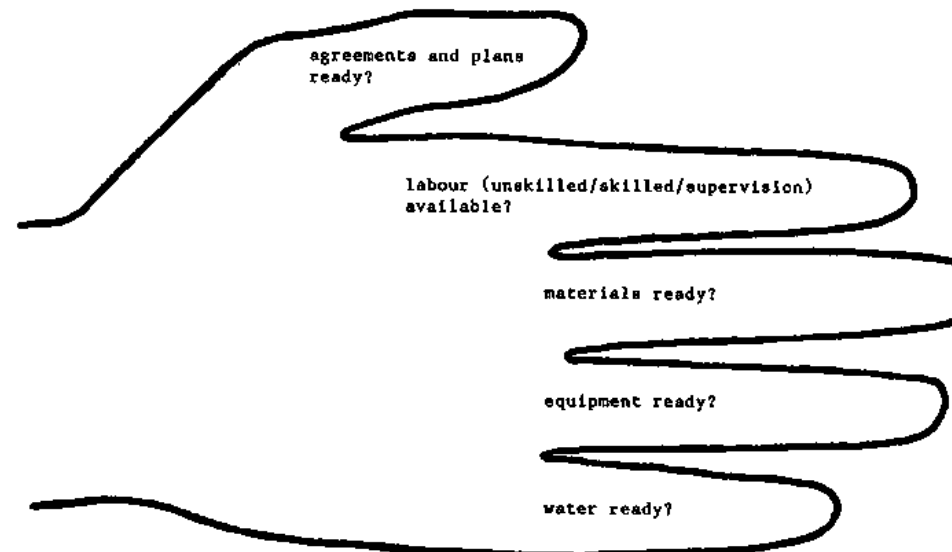

Carefully check all these points:

- Did all parties agree on the work to be done?
- Are the technical plans (drawings etc.) ready?
- Is skilled labour available?
- Is unskilled labour available?
- Is supervision possible?
- What materials are needed? Are storage facilities available on-site?
- What equipment is needed? Are storage facilities available on-site?
- Is water available and ready?

If any of these elements is not available in sufficient quantity, the work can not run smoothly.

B) Timing

The timing of building work is done mostly with what is called a “bar chart”. The sequence of work mostly depends on the first two “fingers”, i.e. “Are agreement and technical plans ready?”, and “Is the labour available?”

The form, “WORKPLAN”, is for bar chart planning for the whole project for one month. It is to be used as follows:

WORK PLAN	Fill in the department, month and year.
DATE	Check on which day the first of the month falls; if it is a Wednesday for example, write 1 below We, 2 below Th and 3 below Fr. Sa and Su would be the 4th and the 5th, so write 6 below Mo, 7 below Tu and so on. Cross out any public holiday.
WORK	Write the different work to be done, e.g. latrine No.12, latrine No.13, well No.7, work in the workshop, etc. Only work which takes several days to complete should be recorded.
PLANNING	Mark the days planned for working on latrine No.12 with crosses in pencil, e.g. XXX. If you have two teams who can work parallel, work can overlap. Otherwise, the work on the next latrine, No.13, can only start after No.12 has been finished. In the bar chart, it will look like this: XXXXX XXXXX XXXXX

The time needed for certain work to be completed is to be estimated according to experience. Plan sufficient time for cleaning and for working in the store, etc.

RECORDING It is advisable to use the same form for recording actual work done as well. For example, mark the days on which work on a certain latrine actually took place with red boxes:



The work records have to be entered daily. Thus it will become clear whether or not the timing and the estimated duration of work were

correct.

The planning and the filling in of the **WORK PLAN** is done by the project management team. A copy can be given to the foreman or to the technicians, to be fixed on a noteboard in the workshop.

C) Filling in the Diary

After the overall timing has been fixed, the work is to be planned in detail. Check the last three “fingers” - that is, materials, equipment, and water - and decide when you have to make them available on site according to the bar chart.

Fill in your diary under the appropriate date; for example,

- transport of 5,000 bricks to site,
- transport of six drums water to site,
- transport of building box, etc. to site,
- (instruct, tell) labourers to report to site tomorrow,
- etc.

D) Preparing List of Materials and Equipment

Write lists of materials and equipment needed, either directly into your diary or on separate sheets. The list shall contain all materials and equipment with their quantities.

E) Planning Work for a New Site

Beside the planning as described in A to D, specific planning is necessary before starting work on a new site. Consider the following aspects:

- Where can materials be stored on-site or as near as possible?
- Where can equipment be stored on-site or as near as possible?
- Where can the staff get accommodation (for far-away sites)?
- Which means of transport can the staff use (for near sites)?
- What are the arrangements for feeding?
- How shall communication be kept up between the staff and the office?

For a big building task it is necessary to draw a site plan containing the following:

- the boundaries of the construction site,
- the connection to roads,
- location and size of existing buildings,
- vegetation on site (trees, etc.),
- storage facilities for materials,
- storage facilities for equipment

- storage facilities for equipment,
- staff accomodation,
- feeding place,
- the north direction,
- the slope of the area,
- eventually necessary drainage channels.

Sudan Council of Churches/Munuki Water and Sanitation Project

WORK PLAN

Department/Area: WATER SUPPLY

Month: JULY

Year: 1987

Work	Day	Mo	Tu	We	Th	Fr	Mo	Tu	We	Th	Fr	Mo	Tu	We	Th	Fr	Mo	Tu	We	Th	Fr	Mo	Tu	We	Th	Fr										
	Date		1	2	3	4	5	6	7	8	9	10	11	12	13	14	15	16	17	18	19	20	21	22	23	24	25	26	27	28	29	30	31			
CL No. 12			X	X	X	X	X	X	X	X																										
CL No. 13											X	X	X	X	X	X	X	X	X																	
Cleaning Store																				X	X	X	X													
Well No. 7																										X	X	X	X	X	X					

7.2 Work Records

Daily work records are essential, for the following reasons:

1. for the final cost calculation after completion of the well, latrine, etc.;
2. for future estimations of the number of labourers and amount of materials necessary;
3. for deciding if the concrete has already cured enough for further steps;
4. for settling any disputes that may develop with the community or the owner.

Keeping the Work Records

The work records are to be kept by the foreman or technician responsible on site. He/she has to keep the "WORK RECORDS" form (preferably in a protecting plastic envelope) on site with the tools, and has to enter records daily. After completion of the on-site work, the work records are to be handed in to the office for filing.

The work records are to be filled in as follows (see 7.2/3f; 7.4/5f):

WELL No. or LATRINE No.	The number of the well or latrine and the name of the community or owner and location need to be recorded.
DATE	There is one entry for each day.
SCC STAFF	The project staff are to be listed with the abbreviations of their names.
LABOURERS COMMUNITY	The total number of the labourers in the community or the owner present during the whole working day in accordance with the leader of the community workers is to be recorded, including the people caring for food.
WORK	The type of work is to be put into numbers, if possible, e.g. casting <u>1</u> concrete ring, \varnothing 1.07 m, filter type; digging <u>0.6</u> m; etc.
CEMENT	Can be recorded in number of buckets or bags.
SAND/GRAVEL	To be estimated in number of buckets.
MIXTURE	The ratio of the concrete or mortar mixture is to be recorded; e.g., 1 : 3 : 4 (Cement: Sand: Gravel) (see 6.6/13f).
OTHER MATERIALS	All other materials are to be quantified; e.g., 6 m reinforcement \varnothing 6 mm, 1 pc welded mesh, 1 handpump body, 400 bricks. Do not forget small materials like padlocks, handles, etc. Do not forget materials provided by the community, like poles, etc.
WATER TABLE	Each morning, the water table should be recorded, in metres from ground level, in order to check the yield of the well during the night.
WELL BOTTOM	The records kept of the depth of the well indicate the progress of the digging work.
SOIL	The soil type (like whitish clay, sand, clay with gravel) along with all changes in the soil type, need to be recorded. This helps for later evaluation of the soil conditions. For recording the soil conditions in a well you can also use the form, "SOIL PROFILE", on 8.13/9.
REMARKS	Special events can be recorded here, especially damage to equipment, technical problems, conflicts with the community or owner, etc.



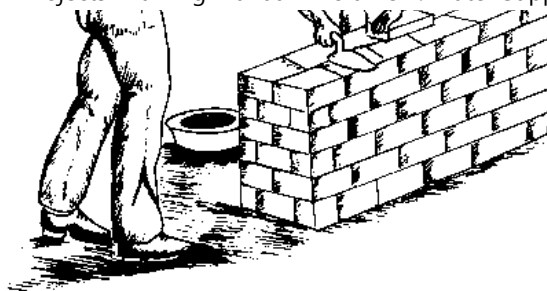

Sudan Council of Churches/Munuki Water and Sanitation Project

WORK RECORDS - WELL NO ...

Date	SCC Staff	Labourers Community	Work	Cement Buckets	Sand Buckets	Gravel Buckets	Mixture	Other Material	Water Table	Well Bottom	Soil	Remarks

Sudan Council of Churches/Munuki Water and Sanitation Project

WORK RECORDS - COMPOST LATRINE NO ...

Date	Staff	Work	Cement Buckets	Sand Buckets	Gravel Buckets	Mixture	Drums of Water	Other Materials	Remarks

7.3 Records of Materials

The materials needed for the construction of a well (or any other construction) should be summarized after completion of the work. This is the task of the foreman or technician responsible on site-Records of materials are not necessary for standard compost latrine construction, because the materials needed are always the same.

The following principles should be observed:

- Evaluate the daily work records, add up all materials consumed and fill in the sum on the “COST CALCULATION” form (see 7.3/2; 7.4/1).
- Start with the bulky items like cement (to be recorded by number of bags), reinforcement, sand and gravel (to be recorded in lorry loads or m³).
- End the list with the smaller items like padlocks, handles, manhole covers, etc.
- Fill in whether the materials were contributed by the community or by the project (SCC).
- Do not forget local materials contributed by the community.

- After filling in, hand the form to the storekeeper. The storekeeper has to check to see if the recorded materials are in accordance with his/her records in the store. The storekeeper fills in the prices according to the stockcards. The price of small items with unknown value can be estimated.
- Afterwards, the records of materials are handed to the office for final check, final cost calculation and filing.

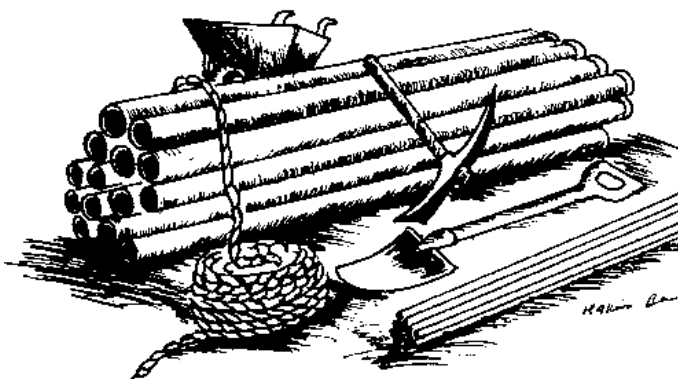

Sudan Council of Churches * Munuki Water and Sanitation Project

COST ESTIMATION/CALCULATION FOR

No.	Quantity	Unit	Item	Unit Price	Total	Contributed by

7.4 Cost Calculation for Community Work

Lk 14,28-30

After the completion of a construction work such as a well, compost latrine, etc., a final cost calculation needs to be made for assessment of the work done and for paying the bills.

A) Form for Cost Calculation

For any cost calculation the form, "COST ESTIMATION/CALCULATION", should be used. It should be filled in as follows:

COST ESTIMATION/COST CALCULATION

The form can be used either for cost estimation before the work has started, or for cost calculation after the work has been completed. Underline, which purpose you will use the form for and cross out the other.

FOR

Give the full information about the well/latrine with its number, location, owner or community.

NO

Number the items 1,2,3,...

QUANT

Record here the quantity, i.e. only the figures without the unit. If the item cannot be quantified, write "div." (= diverse).

UNIT

Record here the unit. Possible units are:

bags

for cement

m

for reinforcement, rope etc.

pcs

for pipes

kg

for nails

gal

for fuel

working days

for labour

km

for transport

ITEM

Record here the items clearly and unmistakably.

Write for example:

reinforcement Ø 6 mm

instead of "reinforcement"

metal pipe Ø 2", 3 m

instead of "pipe"

nylon rope Ø 10 mm

instead of "rope"

nails $2 \frac{1}{2}$ "

instead of "nails"

diesel, petrol

instead of "fuel"

unskilled or skilled labour

instead of "labour"

transport with Toyota pickup

instead of "transport"

UNIT PRICE

Record the price of one unit in £S; i.e., the price of one bag of cement, one kg of nails, one working day unskilled labour, one km driven by the Toyota pickup, etc

TOTAL CONTRIBUTED BY

Multiply the QUANTITY by the UNIT PRICE. This gives the TOTAL for the particular item.
Record whether the item has been contributed (i.e. paid or provided) by the community or by the project (SCC), or by another agency, government office, etc.

After filling in all the items, draw a line under the column "TOTAL" and add up all the TOTALs. The sum is the GRAND TOTAL, the whole amount spent on the work.

B) Steps of Cost Calculation

The cost calculation itself should be done according to the following steps (for example see 7.4/4-11):

1. Collect the "WORK RECORDS" from the foreman or technician in charge on the site.
2. Collect the "RECORDS OF MATERIALS" from the storekeeper.
3. Divide the expenses into:
 - A) MATERIALS
 - B) LABOUR
 - C) TRANSPORT
 - D) PLANNING AND SUPERVISION
 - E) DEPRECIATION OF EQUIPMENT

4. Record first the material costs:

Write the heading "A) MATERIALS" on the form "COST CALCULATION" under "ITEMS". Start by recording the materials below. Record local materials like sand, gravel, and poles. Include the price for transportation and loading if you have paid for "lorry load delivered at site". If you have paid separately for transport and loading, record these costs under "TRANSPORT" and "LABOUR". Record also materials which were not paid for but contributed freely. Estimate their costs and record who contributed them. If work was done in the workshop on some material, record it here also and estimate the costs, e.g. "welded adjustment on handpump body". These costs belong to the material itself. Record all store materials like cement, reinforcement, etc. Do not forget small items. After recording all materials, add them up for a "TOTAL for MATERIALS".

5. Next, record the labour costs:

Write the heading "B) LABOUR COSTS" on the form under "ITEMS". Count the number of working days from the WORK RECORDS. Record unskilled and skilled labour separately. The "UNIT PRICE" for daily paid labourers is their daily wage; for permanently employed staff it is their gross salary divided by 20 (Each staff works about 20 days per month if we take into consideration absences due to sickness, leave and holidays).

Record also unskilled labour provided by the community (to be counted from the WORK RECORDS), including the time spent for cooking for the staff, etc. Estimate the "UNIT PRICE" according to the market price for unskilled labour.

After recording all labour, add them up for a "TOTAL for LABOUR."

6. Record the transport costs:

Write the heading "C) TRANSPORT" on the form under "ITEMS". Check in the logbook to see how often the car went to the particular site and then add up the km. For example, record them as "350 km, Toyota pickup". The "UNIT PRICE" for each km driven is to be found in the annual report of the previous year. In the annual report the total costs including depreciation, fuel, maintenance, insurance and driver of the vehicle are calculated and drawn down to each km:

In the annual report the total costs including depreciation, fuel, maintenance, insurance and driver of the vehicle are calculated and drawn down to each km; for example, the price per km for a Toyota pickup is presently £S 1.750 m/ms (1987). For calculation of the cost per km see 3.4. If a lorry was hired on a daily basis from Logistics Department, record the hiring costs per day; for example: "3 days lorry", the "UNIT PRICE" being the hiring cost per day.

After recording all transport costs, add them up for a "TOTAL for TRANSPORT:"¹

7. Record the costs for planning and supervision:

Write the heading "D) PLANNING AND SUPERVISION" on the form under "ITEM". These costs cover the planning work in the office and the supervision on site. They can be either roughly estimated as a fixed sum (no "QUANTITY", "UNIT", "UNIT PRICE" given, just the "TOTAL"), or as a percentage of the total costs. Alternatively, the working days of the senior staff can be counted.

Add up all the costs for a "TOTAL for PLANNING AND SUPERVISION."

8. Record the costs for depreciation of the equipment:

Write the heading "E) DEPRECIATION OF EQUIPMENT" on the form under "ITEM". This will cover damages and losses of equipment, and the fact that all equipment needs to be replaced after a certain time. Normally these costs are estimated as a fixed sum and this is then recorded as the "TOTAL for DEPRECIATION OF EQUIPMENT."

9. Summarize all the expenses in the form, "SUMMARY OF COST CALCULATION FOR COMMUNITY WORK" (see 7.4/11).

Fill in the costs of material, labour, etc. Add up all the costs. The sum, called "TOTAL COSTS", is the real complete costs of the well/latrine which was built.

Calculate the percentage of the total spent on each heading, from A) to E).

Add up all the percentages. The sum must be 100%; otherwise, look for a mistake.

10. Add up all the contributions of the community/owner in your cost calculation and enter it into the summary. Add up all contributions of the project (SCC). However, if SCC has received cash payment, that means that part of the expenses of SCC has been replaced and that only the remainder is the real contribution of SCC. Therefore, the sum of all amounts contributed by SCC is the expenses of SCC. The cash paid to SCC should be deducted. The result is the contribution of SCC. Enter it into the form. Add up and fill in eventual contributions from others.

Now add up all the contributions. The sum must be equal to the TOTAL COSTS of step no.9, otherwise look for a mistake. Calculate, what percentage each contributor has given. Add up all percentages, the sum of which must be 100%; otherwise look for a mistake.

11. Present the summary to the PMT, the Finance Department, the Programmes Department and the owner or community, if necessary. These summaries are important for comparison purposes and for future decision-making.

12. If there are still payments outstanding, write a bill or payment request to the concerned party and hand it over attached to the cost calculation.

C) Example for Cost Calculation (simplified)

1. Task

Do a complete cost calculation for a well which was built by the neighborhood community Munuki and SCC Munuki. The well is located in Munuki West at the open space beside the planned cinema. The details of the work are recorded on the attached form "WORK RECORDS". The prices of the different

open space beside the planned cinema. The details of the work are recorded on the attached form 'WORK RECORDS'. The prices of the different commodities are as follows:

2. Prices of Commodities Provided by SCC

1 pc	concrete ring Ø 1.07 m	£S 311.500 m/ms
1 pc	filter ring Ø 1.07 m	£S 311.500 m/ms
1 pc	well cover Ø 1.07 with manhole	£S 700.000 m/ms
1 bag	cement	£S 115.000 m/ms
1 working day	skilled labour	£S 10.000 m/ms
1 day	hiring of lorry	£S 200.000 m/ms
1 km	Toyota pick-up	£S 1.750 m/ms

3. Prices of Commodities Provided by the Community

1 m ³	sand	£S 35.000 m/ms
1 m ³	gravel	£S 65.000 m/ms
1 drum	water	£S 2.000 m/ms
1 bundle	bamboo	£S 15.000 m/ms
1 pc	pole	£S 15.000 m/ms
1 kg	nails 2"	£S 15.000 m/ms
1 pc	door for fence	£S 100.000 m/ms
1 pc	padlock	£S 15.000 m/ms
1 working day	unskilled labour	£S 5.000 m/ms
1 meal	breakfast for one person	£S 2.000 m/ms

4. Additional Information

Breakfast was provided for all SCC workers and community workers on all working days. According to the logbook, 60 km were driven by the Toyota pickup for transport of equipment and supervision. Planning and supervision costs £S 600.000 m/ms. The well siting before the construction of the well costs £S 100.000 m/ms. The depreciation of equipment (tripod, pump and tools) costs £S 1,000.000, m/ms.

5. Cross Section of the Completed Well



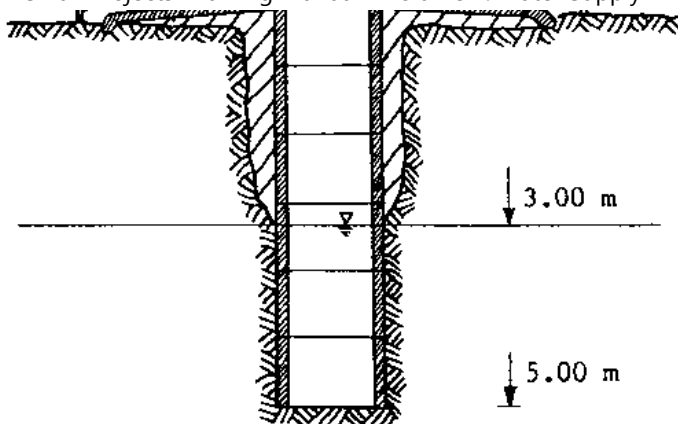

Sudan Council of Churches * Munuki Water and Sanitation Project

WORK RECORDS - WELL NO...15

Date	SCC Staff	Labourers Community	Work	Cement Buckets	Sand Buckets	Gravel Buckets	Mixture	Other Material	Water Table	Well Bottom	Soil	Remarks
30.1	-	6	<i>digging</i>	-	-	-	-	-	-	1.80	clay	-
31.1	-	6	<i>digging</i>	-	-	-	-	-	-	3.00	clay	-
2.2	Jo/Si/GI/P	4	<i>transport of rings, cover, equipment</i>	-	-	-	-	-	3.00	3.00	clay	<i>lorry hired for 1 day</i>
3.2	same	4	<i>lowering ring + digging</i>	-	-	-	-	1 filter ring \emptyset 1.07	3.00	3.50	sandy clay	
4.2	same	4	<i>same</i>	-	-	-	-	same	3.00	4.00	same	
5.2	same	4	<i>same</i>	-	-	-	-	same	3.00	4.30	same	<i>lot of water</i>
6.2	same	4	<i>digging</i>	-	-	-	-	-	3.00	4.60	same	<i>Honda pump used</i>
9.2	same	4	<i>digging and lowering one ring</i>	$\frac{1}{4}$	1	-	1:4	1 fully concrete ring \emptyset 1.07	3.00	5.00	same	same
10.2	same	4	<i>lowering two rings</i>	$\frac{1}{2}$	2	-	1:4	2 above	3.00	5.00	same	
11.2	same	4	<i>backfill, cover placed platform</i>	2 bags	18	24 b. + 2m ³	1:3:4	1 cover 1 drum water	3.00	5.00	same	
12.2	same	4	<i>platform and drainaeg</i>	3 baas	27	36	1:3:4	1 drum water	3.00	5.00	same	

Sudan Council of Churches * Munuki Water and Sanitation Project

WORK RECORDS - WELL NO...15

Date	SCC Staff	Labourers Community	Work	Cement Buckets	Sand Buckets	Gravel Buckets	Mixture	Other Material	Water Table	Well Bottom	Soil	Remarks
13.2	Jo/Si/GI/P	-	<i>transport of all equipm. to workshop and curing</i>	-	-	-	-		3 drums water			<i>transport by Toyota pickup</i>
16.2	-	3	<i>build fence</i>	-	-	-	-		18 poles 1 door 1 lock			
17.2	-	3	<i>build fence</i>	-	-	-	-		20 bdl bamboos 4 kg nails 2 "			
		Total	6 bags	1.5 m³	3 m³							

Sudan Council of Churches * Munuki Water and Sanitation Project

COST ESTIMATION/CALCULATION FOR WELL NO 15 Neighborhood Community Munuki West

No.	Quantity	Unit	Item	Unit Price	Total	Contributed by
			A) MATERIALS			
1	6		<i>concrete rings Ø 1.07 m (3 filter, 3 fully)</i>	<i>311.500</i>	<i>1,869.000</i>	<i>scc</i>
2	1	<i>pc</i>	<i>cover with manhole</i>	<i>700.000</i>	<i>700.000</i>	<i>scc</i>
3	6	<i>bags</i>	<i>cement</i>	<i>115.000</i>	<i>690.000</i>	<i>scc</i>
4	1.5	<i>m³</i>	<i>sand</i>	<i>35.000</i>	<i>52.500</i>	<i>comm.</i>
5	3	<i>m³</i>	<i>gravel</i>	<i>65.000</i>	<i>195.000</i>	<i>comm.</i>
6	5	<i>drum</i>	<i>water</i>	<i>2.000</i>	<i>10.000</i>	<i>comm.</i>
7	18	<i>pcs</i>	<i>poles</i>	<i>15.000</i>	<i>270.000</i>	<i>comm.</i>
8	20	<i>bdls</i>	<i>bamboos</i>	<i>15.000</i>	<i>300.000</i>	<i>comm.</i>

9	4	kg	nails	15.000	60.000	comm.
10	1	pc	door for fence	100.000	100.000	comm.
11	1	pc	padlock	15.000	15.000	comm.
			TOTAL OF A) MATERIALS		4,261.500	
			B) LABOUR			
1	40	days	skilled labour	10.000	400.000	scc
2	54	days	unskilled labour	5.000	270.000	comm.
3	94	pcs	breakfast	2.000	188.000	comm.
			TOTAL OF B) LABOUR		858.000	
			C) TRANSPORT			
1	1	day	big lorry	200.000	200.000	scc
2	60	km	Toyota Pickup	1.750	105.000	scc
			TOTAL OF C) TRANSPORT		305.000	
			D) PLANNING AND SUPERVISION			
1			planning and supervision	600.000	600.000	scc
2			well siting	100.000	100.000	scc
			TOTAL OF D) PLANNING AND SUPERVISION		700.000	
			E) DEPRECIATION			
1			depreciation of equipment	1,000.000	1,000.000	scc

			TOTAL OF E) DEPRECIATION		1,000.000	

Contributions:

Contributions of SCC	Contributions of Community
1,869.000	52.500
700.000	195.000
690.000	10.000
400.000	270.000
200.000	300.000
105.000	60.000
600.000	100.000
100.000	15.000
1,000.000	270.000
	188.000
5,664.000	1,460.500
5,664.000	1,460.500

Sudan Council of Churches * Munuki Water and Sanitation Project

SUMMARY OF COST CALCULATION FOR COMMUNITY WORK

Well/Latrine No.:	15
--------------------------	-----------

Community/Owner:	<i>Neighborhood Community Munuki West</i>
Site:	<i>Munuki West, open space beside planned cinema</i>

1. Costs Differentiated According to Type

A) Materials	£S	<i>4,261.500</i>	= 60 %
B) Labour	£S	<i>858.000</i>	= 12 %
C) Transport	£S	<i>305.000</i>	= 4 %
D) Planning and Supervision	£S	<i>700.000</i>	= 10 %
E) Depreciation of Equipment	£S	<i>1,000.000</i>	= 14 %
Total Costs	£S	<u><i>7,124.500</i></u>	= 100%

2. Costs Differentiated According to Contribution

A)	Contribution of Community/Owner			
	= Expenses of Community/Owner + Cash paid to SCC	=		
	= £S <i>1,460.500</i> + £S <i>500.000</i>	= £S	<i>1,960.500</i>	= 28 %
B)	Contribution of SCC			
	= Expenses of SCC - Cash paid to SCC	=		
	= £S <i>5,664.000</i> - £S <i>500.000</i>	= £S	<i>5,164.000</i>	= 72%
C)	Contribution of	£S	= ... %
D)	Contribution of	£S	= ... %
	Total Costs	£S	<u><i>7,124.500</i></u>	= 100%

7.5 Cost Calculation for Contract Work

Cost Calculation for contract work is basically done in the same way as the cost calculation for work on a community basis. However, there is no need for differentiation according to the contributors, as all work is done by the contractor and the owner's contribution is the payment.

Follow these steps for calculation:

1. to 8. see 7.4, B)

9. Summarize all the expenses on the form "SUMMARY OF COST CALCULATION FOR CONTRACT WORK". Fill in the costs for materials, labour, etc. Add up all the costs. The sum is the total of the expenses which were spent by the SCC as a contractor. Calculate what percentage of the total was spent on each heading, A) to E). Add up all the percentages. The sum must be 100%, otherwise look for a mistake.

10. Compare the expenses of SCC with the payments of the owner to SCC. Find out about the payments from administration. If the expenses are higher than the payment, SCC has worked at a loss. Fill in the difference under "LOSS". Supplementary payments may be requested from the owner. If the expenses are less than the payments, SCC has worked with profit. Fill in the difference under "GAIN". If the payment and the expenses are equal, there is no loss or gain.

Cost estimations for future contracted work are done in the same way. However, the amounts need to be roughly estimated. If the cost estimation was done on a realistic basis and no items were forgotten, the total should be very close to the final cost calculation.

Sudan Council of Churches * Munuki Water and Sanitation Project

SUMMARY OF COST CALCULATION FOR CONTRACT WORK

Well/Latrine No.:
Owner:
Site:

Expenses of SCC

A)	Materials	£S =	... %
B)	Labour	£S =	... %
C)	Transport	£S =	... %
D)	Planning and Supervision	£S =	... %
E)	Depreciation of Equipment	£S =	... %
	Total Expenses	£S =	100%

Expenses of SCC £S

Payment of Owner to SCC £S

LOSS (or subsidy) of SCC £S

GAIN (or profit) of SCC £S

7.6 Purchasing Locally

To keep to a certain procedure of purchasing items from the local market will help to save time and efforts and money and to prevent losses.

Follow these steps:

1. Write a complete, quantified and exact purchase list and discuss it with colleagues and the storekeeper who may add something-It is very annoying to have to repeat the whole purchasing procedure when a single item has been forgotten.

The list needs to be sorted; that is, items to be purchased from the same shop should be listed together (e.g., tools together, stationary together, etc.).

Fill in all the items on the following list:

No.	Quant.	Unit	Item	Unit Price				Total
				Shop1	Shop 2	Shop 3	Shop 4	

Alternatively, the "COST CALCULATION" form can also be used for the purchase list (see 7.3/2).

2. Collect pro forma invoices for the items in the desired quantity. If the item is expensive, collect invoices for the same item from several shops, if possible. Fill in the given prices on the list.

3. Choose the cheapest source or the best quality, underline it on the list and calculate the totals using that figure. Add up the totals.

4. Write a payment request for the total amount, get it approved by the chairperson of the PMT and present it to the accounts office with the pro forma invoices attached.

5. Collect the money. Sign for receiving it (for your own protection). Keep the money in a safe place; for example, in a closed bag. Do not mix it with private money.

Alternatively, you can collect money from the petty cash of the project if you need only a small amount. Take care that the amount, the date and your name are recorded.

6. Purchase the items in the respective shops. Check the quality (e.g., tools operating?, bags not torn?, parts not broken?, timber straight?) Do not accept the item if it is not of good quality. Check the quantity. Count all pieces by yourself. Ask for appropriate packing. Load everything carefully.

7. Pay for the items against an invoice (= receipt). Check to see that the amount is the same as on the pro forma invoice. Carefully count the change. Record any payment immediately on a prepared sheet of paper; that is, as soon as you leave the shop. It is very easy otherwise to forget a payment and to get confused. If you cannot get a receipt (e.g. at an open market), write a receipt yourself in the receipt book and let the shopkeeper sign, if necessary with a finger print. If you have no receipt book at hand and the amount is small, record it and the receipt can be written in the office.

Calculate the balance. The balance must be equal with the money left with you. Thus you can check the money at any time.

Money received:		£S 300.000 m/ms
Shop	Payment	Balance

Shop	Payment	Balance
First shop	25.000	275.000
Second shop	107.000	168.000
....		

8. Put all the receipts immediately together into a separate envelope (not just into your pocket).

9. Transport all the items to the store and hand them over to the storekeeper.

The items need to be recorded on the stock cards including the prices. It is important to record the prices at this point, because the receipts are going to be handed to the accounts office.

10. In the end of every purchasing day, count the money left with you and compare it with the balance according to your records. If it does not fit, look for a mistake.

11. If receipts are written in Arabic, write the quantity, item and amount on the receipt in English.

12. When you have finished purchasing and have spent all, or almost all, of the money, number all the receipts 1,2,3, etc. Write on each receipt the budget No. under which the receipt shall be recorded. Summarize the receipts on a separate sheet of paper as follows:

Cheque No: 47812

Date: 3.2.87

Amount: £S 300.000 m/ms

No	Date	Receipt No.	Budget No	Item	Amount	Balance
1	5.2.	1	4.2	hammer	25.000	275.000
2	6.2.	2	3.2	stationary	107.000	168.000
3	...					

For the budget numbers see 2.9/1.

13. Collect all the receipts and an eventual balance and hand it over to the administration, so that they can register it in the finance book and hand it over to the accounts office.





7.7 Purchasing from Khartoum

Purchases inside Sudan, especially from the capital, can be arranged through the Logistics Department of SCC.

The procedure is as follows:

1. Write a complete, quantified and exact purchase list. Each item needs to be described unmistakably. Mention the quantity, the unit, the item itself, the material, the measurements (like 0, length, etc.). If necessary, add pictures or refer to a catalogue. Discuss and decide upon the purchase list with your colleagues and the storekeeper.

No.	Quantity	Unit	Item	Remarks

Let this purchase list be typed in three copies. Check afterwards thoroughly for spelling and typing errors.

2. Write a letter to the Logistics Department in Khartoum, requesting them to purchase and send the items according to the attached purchase list. Send the original to Khartoum, Logistics Department, and a copy to the Finance Department with a note that they should kindly make the money available.

The third copy remains with the project and is to be filed in the respective paper file (e.g., “tools”, “pump”) or in the paper file “RUNNING ORDERS”.

3. Fill in the order on the chart “RUNNING ORDERS” hanging in the office. This helps to follow up outstanding orders.

4. From time to time, inquire about the order by radio message or letter.

5. When receiving the items, compare the waybill and the purchase list and the items actually received. If everything is correct, sign the waybill. Note missing or damaged items on the waybill (all copies).

6. Put all the items into the store and hand them over to the storekeeper. The items need to be recorded on the stock cards.

7. If there is any difference between the purchase list and the items received, write a new list headed "ITEMS RECEIVED".
8. Send the list "ITEMS RECEIVED" and an accompanying letter to Logistics, acknowledging receipt of the items and thanking them. Ask for the invoices and transport costs.
9. Alternatively, inquire from the Finance Department about payments made.
10. After receiving the information about payments, tell the administration to record them into the finance book.
11. Divide the transport costs accordingly on each item.

Example:

No	Quant	Unit	Item	Unit Price Khartoum	Total Khartoum	Unit Price Juba
1	20	pcs	zinc sheets 8'	60.000	1,200.000	86.400
2	5	gal	oil paint, green	55.000	275.000	79.200
3	30	pcs	buckets	15.000	450.000	21.600
			PURCHASE COSTS		1,925.000	
			Transport by air Khartoum -Juba		800.000	
			Loading/unloading		40.000	
			TOTAL COSTS		2,765.000	

The **TOTAL COSTS** are the **PURCHASE COSTS** plus all other costs of transport, handling, loading, etc.

The **TRANSPORT FACTOR** is used to include all additional costs, thereby finding the real cost of each item.

$$\text{TRANSPORT FACTOR} = \frac{\text{TOTAL COSTS}}{\text{PURCHASE COSTS}} = \frac{\text{£}2,765.000}{\text{£}1,925.000} = 1.44;$$

Multiply each "Unit Price Khartoum" by the **TRANSPORT FACTOR**. The result is the "Unit Price Juba" which includes all transport and other additional costs.

Note, that the price including transport, etc., is considerably different from the purchase price.

12. Record the "Unit Price Juba" on the stock cards.

7.8 Purchasing from Abroad

Some items are not available within the country and, therefore, need to be purchased from abroad. Purchases from abroad differ considerably from purchases within the country, because foreign currency payments and customs clearance are necessary.

Some items from abroad can be purchased by the Logistics Department. In this case the procedure is similar to "Purchases from Khartoum". However, the purchasing of special technical items, like specific tools, pumps, hand augering equipment, etc., require special technical knowledge and information about the project's needs. Therefore, these orders need to be handled by the project staff themselves in cooperation with the Logistics Department.

The procedure is basically as follows, but it may vary on different occasions:

1. Write a complete, quantified and exact purchase list and discuss it with colleagues and the storekeeper.
2. Write a letter to the supplier(s) requesting a pro forma invoice. Describe the items you want exactly. If possible, request pro forma invoices from several suppliers.
3. Upon receipt of the pro forma invoices, check them and select the most suitable.
4. Discuss in the PMT and check with the administration whether the money is available in the budget. If necessary, get approval from the Deputy General Secretary or the Finance Director.
5. Write a letter to the supplier ordering the items according to his or her pro forma invoice. Indicate how the items should be packed and transported to your end (by air, by ship, etc.), by which route and by which transport company, if known.

Send copies of this letter to the Deputy General Secretary, Finance Director, Logistics Department in Khartoum/Juba, and to the transport company. One copy remains in the project and is filed in the respective paper file (according to subjects, with a separate file for each type of equipment).

6. Write an accompanying letter to Logistics Department in Khartoum requesting them to obtain an import license for this order.
7. Fill in the order on the chart "RUNNING ORDERS", hanging in the office.
8. From time to time, inquire about the order by telex or letter.
9. After notice that the items have arrived, ask Logistics Department for assistance in customs clearance.
10. Check the items and compare them with the waybill, with the order, and with the pro forma invoice. If everything is correct, sign on the waybill. Note items missing or damaged on the waybill (all copies).
11. Assemble all machinery, like generators, pumps, etc., and test their operation. If they are not operating properly, write to the supplier.
12. Put all the items into the store and hand them over to the storekeeper. The items need to be recorded on the stock cards.
13. If there is any difference between the order and the items received, notify the supplier in written form immediately.
14. After receiving the bill, compare it with the pro forma invoice. Check to see that transport costs are reasonable. Send a copy of the bill with a request for payment to the Finance Department for settling.
15. Enter payment into the finance book of the project. If in foreign currency, calculate in £S at the official exchange rate.
16. Divide the transport and packing costs accordingly on each item and transform the amount into £S. Consider all transport costs as well as any handling costs that may have been charged.

Example:

No.	Quant	Unit	Item	Unit Price Supplier US \$	Total of Supplier US \$	Unit Price Juba US \$	Unit Price Juba £S
1	2	pcs	diaphragm pump	700	1,400	1,330	4,655
2	4	pcs	hose, 10 m, Ø 2 $\frac{1}{2}$ "	160	640	304	1,064
3	10	pcs	spare membrane	40	400	76	266
		PURCHASE COSTS			2,440		
		Packing			350		
		Air Transport EUR - NBI			1,250		
		Road Transport NBI-Juba			400		
		Handling by Transport Company/Loading/Unload.			200		
		TOTAL COSTS			4,640		

The "TOTAL COSTS" are the "PURCHASE COSTS" plus all other costs for transport, handling, etc.

The TRANSPORT FACTOR is used to include all additional costs, thereby finding out the real cost of each item.

$$\text{TRANSPORTFACTOR} = \frac{\text{TOTALCOSTS}}{\text{PURCHASECOSTS}} = \frac{4,640}{2,440} = 1.9;$$

17. Multiply each "UNIT PRICE SUPPLIER" by the TRANSPORT FACTOR.

The result is the "UNIT PRICE JUBA, US \$", which includes packing, transport, handling, etc.

Inquire about the official exchange rate between US \$ and £S and transform the "UNIT PRICE JUBA, US \$" into the "UNIT PRICE JUBA, £S".

Example:

If US \$ 1.00 = £S 3.500, then multiply all unit prices in US \$ by 3.5. The result is the unit price in £S.

Note that the price including transport, etc., is considerably different from the purchase price. Knowing the real price is important for future budgeting and eventual sales.

18. Record the real prices (the "UNIT PRICE JUBA, £S") on the stock cards.

19. Write a letter to the supplier, acknowledging receipt of the order and thanking him or her.



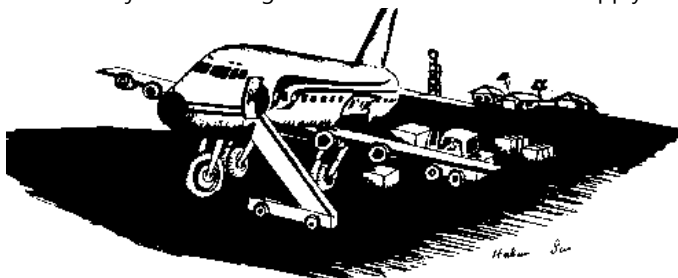

7.9 Storekeeping - Recording

Correct records are essential for storekeeping. They are done on stock cards, which are to be filled in as follows (example see 7.9/3)

ITEM Write a separate stock card for each kind and size of item. Therefore, separate cards for 'nails 2"', 'nails 3"', etc. Write under "ITEM" the exact specification. Start with the general name, followed by the material, followed by the size. For example:

pipe, metal, Ø 2"

not metal pipe

bits for wood

not wood bits

Put spare parts under the main item. For example:

hacksaw blades

not blades, hacksaw

diaphragm pump, spares

not spares for diaphragm pump

Use always the same and only one name for one kind of item. For example:

measuring tape, 2 m

not tape measure 2 m

measuring tape, 5 m

not tape measure 5 m

measuring tape, 10 m

not measuring tape 10 m

measuring tape, 50 m

not meter 50 m

Complete tool boxes are one item like handpump box, building box, well-digging box, etc. Write the name of the box under "ITEM" with the remark "Contents on a separate list". This list is to be kept with the stock card. A copy of the list of contents remains in the box itself for on-site checks.

ALPHABETICAL ORDER The stock cards are stored in a box in alphabetical order. They are sorted according to the first word under "ITEM", then the second, and so on. Identical items differentiated only by size are sorted according to the size with the smallest first.

Therefore, the following cards will be in this order:

jerrycan, metal,

4 gallons

jerrycan, plastic,

1 gallon

~~ierrycan. nlastic.~~

~~4 gallons~~

timber, green,

or:

timber, hardwood, 2 x 2" , 3 m

timber, hardwood, 2 x 4" , 3 m

timber, hardwood, 3 x 4" , 3 m

timber, softwood, 2 x 2" , 3 m

timber, softwood, 2 x 2" , 6 m

The stocktaking list of the previous year is attached to the box of the stock cards and can help you find the relevant cards.

UNIT

Indicate in which unit the item will be counted. For example:

kg	nails
pcs	hammer, welded mesh, timber, pipes
m	rope, reinforcement
bag	cement, whitewash
set	drill bits, spanners of different sizes
lit	oil
gal	engine oil, fuel, paint
rolls	binding wire

The figures in the stock card below are always counted in the units mentioned above.

UNIT PRICE

Record the unit price in £S. If the same item is purchased later at a higher price, cancel the old price and replace it with the new one.

ON

Record the date when the price was valid.

NUMBER RECEIVED

Record the quantity received here. Fill a new line each time you receive or issue an item.

NUMBER ISSUED

Record the quantity issued here. When tools are put into any of the tool boxes, they count as "issued".

BALANCE

Add the number received to the balance of the line above and fill in the result on the same line under "BALANCE". Subtract the number

issued from the balance of the line above and fill in the result on the same line under "BALANCE". The "BALANCE" must equal the actual quantity in the store.

TO/FROM

Record to whom the item was issued (e.g. well No.4, latrine No.5, office, handpump box, name of person).

Record from whom you received the item (e.g. market Juba, Khartoum, Nairobi, building department).

DATE

Record the date of receiving or issuing.

REMARKS Note any irregularity like "items spoilt", etc.

SIGNATURE The storekeeper needs to sign here. Thus it is clear, who is responsible for issuing or receiving this particular item.

It is important to record all movements immediately. If that is not possible, due to lack of time, never allow any item to leave the store without a notice on a piece of paper, which is to be recorded later as soon as possible.

Sudan Council of Churches * Munuki Water and Sanitation Project

STOCK CARD

ITEM ___ UNIT ___ UNIT PRICE £S ___ ON ___

Number Received	Number Issued	Balance	To/From	Date	Remarks	Signature

Sudan Council of Churches * Munuki Water and Sanitation Project

STOCK CARD

ITEM *CEMENT* UNIT *bag* UNIT PRICE £S *115.000* ON *1.7.87*

Number Received	Number Issued	Balance	To/From	Date	Remarks	Signature
<i>600</i>		<i>600</i>	<i>Nbi</i>	<i>1.7.</i>	<i>12 broken</i>	<i>Ry</i>
	<i>25</i>	<i>575</i>	<i>CL No.17</i>	<i>3.7.</i>		<i>Ry</i>
	<i>7</i>	<i>568</i>	<i>CL No.21</i>	<i>7.7.</i>		<i>Ry</i>
	<i>10</i>	<i>558</i>	<i>CL No.21</i>	<i>8.7.</i>		<i>Ry</i>

	<i>10</i>	<i>558</i>	<i>WS</i>	<i>9.7.</i>	<i>tor rings in workshop</i>	<i>14</i>
	<i>5</i>	<i>553</i>	<i>- -</i>	<i>11.7</i>	<i>spoilt by rain</i>	<i>14</i>
<i>50</i>		<i>603</i>	<i>SCCBuild</i>	<i>15.7.</i>	<i>returned loan of 1.3.87</i>	<i>14</i>

7.10 Organising a Store

A well-kept store contributes to correct storing and the easy finding of items. It keeps us aware of the amount of material in stock and helps to prevent losses. A good store is the foundation of any project work and a mirror of the quality of work.

A) Principles of Storekeeping

Good storekeeping is based on the following principles:

1. The systematic structure according to which the items are stored must be easily understandable for anyone at first glance. Thus, anyone using the store is much more likely to place the items in the correct location without messing up.
2. Every item should be easily accessible without moving other items or climbing over them. Thus, people are less likely to place items anyhow, maybe just in front of the door, or to move items without putting them back in their right places. This also saves time and efforts.
3. The store should be clean, dry and orderly. It is much more likely that people mess up a dirty place than a clean one.
4. Spoiling of items must be prevented and spoilt items need to be removed in order not to occupy needed space.

B) Rules of Storekeeping

For implementing these principles, observe the following basic rules:

1. Store identical items at the same place.

For example, do not store timber of the same size in different places.

2. Store related items near to each other.

For example, store timber of different sizes or nails of different sizes near to each other. Store different kinds of tools near to each other, and separate them from building materials, etc.

3. Always store the same items in the same place.

Write the name and/or draw a picture of the item on the shelf, wall, etc. Write the contents on boxes or packed material. Do that even if it seems obvious, since you might forget later. Especially, write difficult names on the shelves (like D-shackle, with drawing).

5. Always store lengthy boxes or other items with the short side facing the outside of the shelf. Thus you can see the side of many boxes instead of few. Store the boxes with the label of their contents facing the outside.

6. Store boxes, timber, etc., of the same kind above each other instead of beside each other with other items on top.

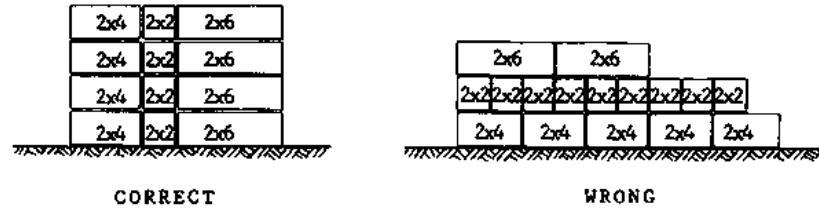

Thus, each size/type is easily accessible without moving others.

7. Store items so that they are easily countable. For example, store cement, etc., in piles of 5 or ten above each other and 5 or ten piles beside each other. Always remove from one pile until it is finished, then from the next.

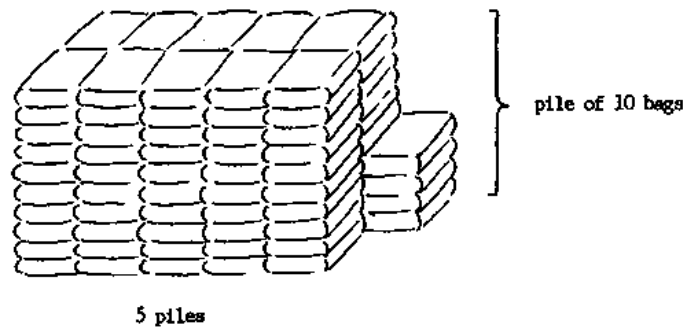

easy to count: 104 bags



3 piles

difficult to count: 24 bags

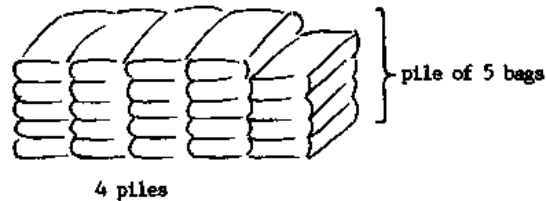

easy to count: 24 bags

Store nails in 1-kg boxes. Thus it is easier to determine how many are left, as compared with, say, a single container containing 20 kg of nails.

8. Store as few items as possible on the floor. Provide sufficient shelf space. Hang whatever possible on the wall or on the shelves. More can be stored on shelves than spread on the ground.

That way, moving about in the store and cleaning will be made easier.

9. Put small items like nails, bolts, pins, etc., into labelled boxes.

10. Store rope and wire on a roll or hanging in rolls on a lever arm, or store rope in a box. Thus any length can be easily cut off.

11. Store items in a stable way. Always store heavy items on the lower shelves. Turned-over shelves or collapsed piles are a nuisance and are dangerous.

12. Take care that the store is airy, has ventilation openings and is dry. Immediately repair any leaks in the roof or from below.

13. Store cut timber on a straight ground on at least three logs, never directly on the ground.

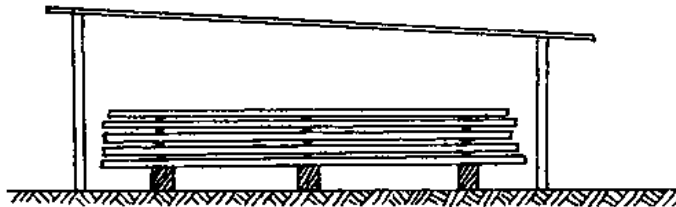

Optimal way of storing timber: each log is surrounded by air.



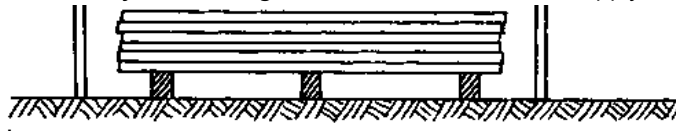

Possible way of storing timber: the air cannot reach all pieces.



Wrong way of storing timber: it gets wet, dirty and twisted, and ants can attack it easily.

14. Never store cement and fuel together. They will spoil each other.

15. Inflammable materials must be stored separately from other combustible materials in an area especially protected from fire.

16. Materials, such as cement, which deteriorate with the passage of time, must be kept constantly moving by using the earliest arrivals first.

17. Clean the store regularly. Clean all returned items before putting them back into their place.

18. Keep the store carefully locked, even if you leave it only for a short time.

C) Equipment of a Store

- shelves,
- boxes,
- table,
- chair,
- stock cards in a box,
- file "LOANS",
- file "SALES",
- forms "WORK PLAN",
- forms "WORK RECORDS LATRINE",
- forms "WORK RECORDS WELL",
- forms "TOOLS ON SITE",
- forms "COST ESTIMATION/CALCULATION",
- calculator,
- ruler,
- pens,
- pencils,
- marker pens.

- punch,
- stapler,
- string,
- glue,
- cellotape,
- lined paper,
- plain paper,
- carbon paper,
- jar 1 litre,
- jar 1 gallon,
- stocktaking list,
- balance scales,
- one copy of these chapters about storekeeping.

D) Example of Store Layout Plan

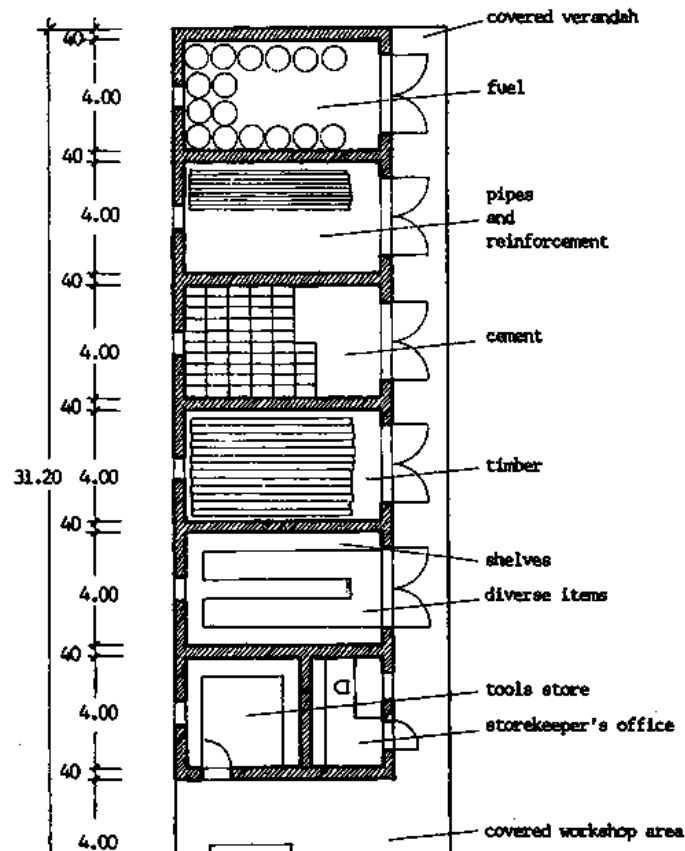

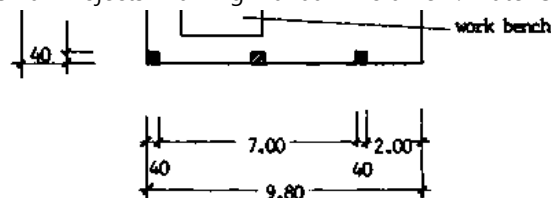

Scale 1:200

7.11 Storekeeping - Procedures

The task of the storekeeper is to implement the basic storekeeping procedures.

A) Issuing Tools for a Site (see 7.11/4)

Record tools to be issued to a site: first on the stock card, secondly on the form, "TOOLS ON SITE", which is to be filled out in two copies. Give one copy to the foreman/technician responsible for the site; she/he has to account for any losses while on site. Let her/him sign for the tools issued. The other copy remains in the store for the storekeeper to check the tools as they are returned. Record complete boxes with their names (i.e., hand pump box, building box, etc.), without listing each tool.

B) Issuing Materials for a Site (see 7.11/5; also 7.3/1f; 7.4/1,7ff)

Record materials to be issued to a site: first on the stock card, secondly on the form, "COST ESTIMATION/CALCULATION", which is to be filled out in two copies. Give one copy to the foreman/technician responsible for the site. The other copy remains in the store. This is needed for the final cost calculation.

Record materials for standard compost latrine construction, which are always the same amount, only on the stock card.

C) Receiving Items

Check tools coming back from a site according to the form, "TOOLS ON SITE", and enter the receipt into the stock card. Check to see if the tools are in good condition.

Check items from the market according to the purchase list and enter them into the stock card, including the prices.

Check items arriving from outside according to the waybill. Note missing or damaged items on the waybill and sign all copies of the waybill. Enter the items into the stock card. Request the prices from the office and enter them into the stock card as well.

D) Sale of Items

Issue items on sale, like latrine slabs, ventpipes, children's squatting slabs, etc., only when the buyer brings a receipt from the accounts office with a note from the senior staff. Record the item in the stock card and fill in under "REMARKS": "paid, receipt No...., date of receipt". Write on the receipt "Issued" with the date and your signature and give the receipt back to the buyer. File the note into the paper file "SALES".

E) Loans of Items

Items (equipment or tools) can be loaned only in exceptional cases. Issue the item only upon a written approval from senior staff and file the approval in the

items (equipment or tools) can be loaned only in exceptional cases, and the loan only upon a written approval from senior staff and the approval in the paper file, "LOANS". Enter the loan into the stock card.

Write a list of all outstanding loans at the end of each year and present it to the office for follow-up.

F) Purchase List

Note down any items which have been depleted, soon will be depleted, or are missing, on a purchase list. Present these suggestions for re-purchasing to the concerned staff at the time of purchasing.

G) Cost Calculations

When the work on a well or latrine is finished, the foreman or technician on site completes the records of materials on the form "COST ESTIMATION/CALCULATION", including the materials contributed by the community. She/he hands the list to the storekeeper. The storekeeper adds the prices according to the stock cards and hands the list to the office (for a detailed description, see under 7.3 and 7.4).

H) Prevention of Loss and Misuse

A project store is a great asset but can create danger of loss and misuse. Additionally, the question of misuse can cause founded or unfounded accusations, mistrust, and disturbance in staff cooperation. The following suggestions may help to minimize such disturbances and to prevent or reduce losses and misuse.

1. Suggestions for Senior Staff

- Normally, store keys should be handled by only one person. However, this might cause a lot of inconveniences in the daily running of a project (especially for a small project with no specially assigned storekeeper). The assignment of two people holding store keys is only possible, if there is trust between them and if they keep strictly to recording each item issued and received immediately. Otherwise, insist that only one person be responsible for the store keys.
- In the case of very valuable items stored, provide the store with two padlocks and let two different people hold the keys. Thus the store can be only used during the presence of both.
- Assign one person to be responsible for tools on site or for a specific store, etc., and let her/him sign when taking over. This strengthens the feeling of responsibility among staff.
- If staff members want to take items home (e.g. tools for use, scraps), insist that they keep to the procedures, i.e. ask permission which should be granted whenever reasonable and possible. If not, explain why. The staff should feel that they are treated reasonably and justly.
- Pay a reasonable salary to storekeeper and technicians. Project properties are a great and unfair temptation to underpaid staff with hungry children at home.
- In case of losses, make an inquiry. Do not blame anyone unless guilt is clearly proved. In that case, take whatever steps are necessary. Otherwise, improve your supervision and spend more time on regular checks. In case of proof misuse, dismissal is the only possible action.

2. Suggestions for the Storekeeper

- Keep to the storekeeping procedures, especially, insist on authorizing documents when issuing items.
- Keep the store in order. This helps to keep an overview.
- Label the shelves. Draw pictures of each tool on the wall on the place where you hang it. Thus you realize immediately when it is missing.
- Store items like nails in packed quantities.
- Store items in an easily countable way. Thus you can check the number easily any time.
- Keep your records in order and up-to-date.
- In case of any suspicion against you, insist on the presence of a second person when handling the store.

Sudan Council of Churches * Munuki Water and Sanitation Project

TOOLS ON SITE

Well/Latrine No Community/Owner: Site:

Quantity	Unit	Item	Date Issued	Signature Storekeeper	Signature Foreman	Date Returned	Remarks

Sudan Council of Churches * Munuki Water and Sanitation Project

COST ESTIMATION/CALCULATION FOR

No.	Quantity	Unit	Item	Unit Price	Total	Contributed by

7.12 Stock-Taking

The annual stock-taking is essential in order to determine the assets of the project and to check if anything is lost. The stock-taking report is part of the annual report of the project. The stock-taking is done at the end of the year and is connected with general cleaning of the store and maintenance of equipment.

Stock-taking and cleaning of a big store takes time. Plan on taking several days with sufficient staff. Follow these steps:

1. Collect all tools and equipment from outside sites.
2. Clean the whole store and put it in good order.
3. Go through all the stock cards. Count the quantity of all items available in the store and compare it with the last balance in the stock card. Tick it if they

3. Go through all the stock cards. Count the quantity of all items available in the store and compare it with the last balance in the stock card. Tick it if they correspond. If items are missing, consider whether they may be on outside sites or on loan to somebody. If anything else is missing and somebody is responsible for the loss, she or he should be made to pay for it. Record unaccountable losses or losses due to normal spoiling as follows:

Put the quantity missing under "ISSUED" and write "lost" or "spoilt" under "REMARKS".

4. Write the stock-taking list. Preferably this should be done in a quiet place with a desk.

The stocktaking list looks like this:

Stock-taking List

Year:

Project:

Store:

Quant	Unit	Item	Unit Price	Total	Total Depreciated

Fill in for each stock card one line.

Fill in under "QUANTITIY" the number of the last "BALANCE" on the stock card. Fill in "UNIT", "ITEM", and "UNIT PRICE" according to the stock card.

Multiply "QUANTITY" with the "UNIT PRICE" and fill in the result under "TOTAL".

Calculate the "TOTAL DEPRECIATED" for each item.

Do not depreciate material, equipment and tools, which have not been used, but just stored in stock. For these items the "TOTAL" and "TOTAL DEPRECIATED" are equal.

Depreciate all equipment and tools which were used as shown in the following example:

Depreciate an equipment and tools which were used as shown in the following example:

Year	Depreciation	To get the "TOTAL DEPRECIATED" multiply the "TOTAL" by the factor
1.	25% from original price	x 0.75
2.	50% from original price	x 0.50
3.	75% from original price	x 0.25
4.	100% from original price	The "TOTAL DEPRECIATED" = 0

The first year is the year following the purchase.

Example:

Pipe moulds purchased in 1985

Year	Quant	Unit	Item	Unit Price	Total	Total Depreciated
1985	3	pcs	pipe moulds	4,000	12,000	12,000
1986	3	pcs	pipe moulds	4,000	12,000	9,000
1987	3	pcs	pipe moulds	4,000	12,000	6,000
1988	3	pcs	pipe moulds	4,000	12,000	3,000
1989	3	pcs	pipe moulds	4,000	12,000	

Fully depreciated items are recorded in the stock-taking list (they are still around and may still be used), but the "TOTAL DEPRECIATED" (= the depreciated value) is recorded as nil.

After filling in all items on the stock-taking list, add up all "TOTAL DEPRECIATED". The result will be the "GRAND TOTAL".

The work of filling in the stock-taking list can be drastically reduced if a photocopy of last year's stock-taking list is used and the changes are filled in. Afterwards the new stock-taking list can be typed.

5. Hand the stock-taking list to Administration. There, vehicles and office assets will be added. The final stock-taking list is attached to the annual report (see 2.6/3).

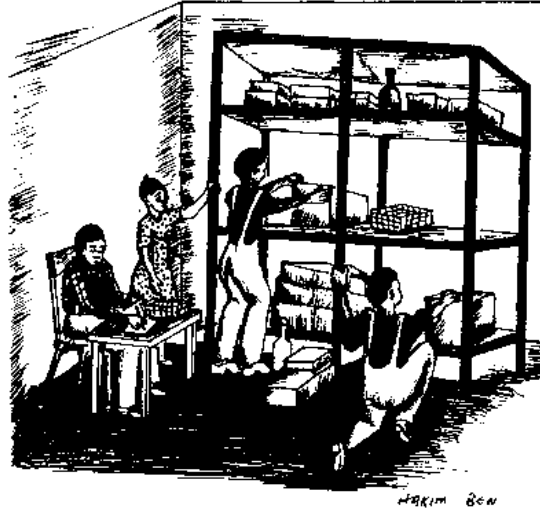

8. Water Supply



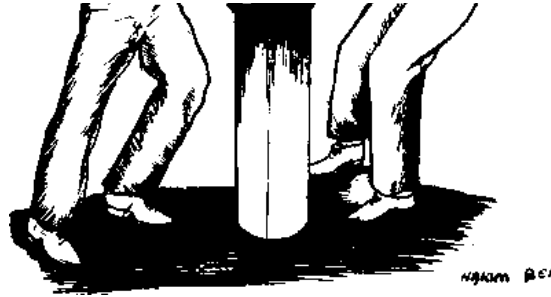

8.1 Story about Good Water Supply

Jam 3,11

The following chapters mainly tackle the technical aspects of water supply. However, the technical aspects are only one element of a successful, good water supply. The social and educational aspects are at least as important, but not the main topic of these chapters. A story about good water supply is recorded here as an example which can be used in the educational work with the community.

THE FOOLISHNESS OF MAN

God had created everything: the cattle, the goats, the dura, the fire, and the water. So one day he called the creatures: lion, hyena, bird, hippo, and man. God told them to ask for one of the things he had created. The lion choose the cattle. The hyena wanted the goats. The bird asked for the dura. And the hippo took the fire. Then man was left with only water and he complained: "I wanted the cattle!" But God told him to take the water, that it was a good gift.

So, the lion went away with his cattle and ate one of them. Then he rested. When he woke up, he was very thirsty. When he came to the water, the man said: "Go away. The water belongs to me." "But I am very thirsty. I will give you a cow." "That is not enough," said the man. So the lion gave man all the cattle, and man let the lion drink.

...and the same thing happened with the hyena, the bird, and the hippo...

And so man had everything: the cattle, the goats, the dura, the fire, and the water. But sometimes the lion or the hyena or the bird or the hippo would sneak up and steal one of these things from man because they had nothing.

One day God looked down at this man who had the water and the cattle and the goats and the dura and the fire. And he saw that man drank water from the river and that he bathed in the same place and that the cattle came into the water to drink. And other people used the river as a place for urinating. And God was unhappy. He looked again at man. Man was crying with indigestion, diarrhea with blood and bilharzia every day. So God called the fox. "Go! Talk to the foolish man. I have given him all the water and he does not know how to keep it safe. Man cannot drink the water where man and cattle bathe. Man cannot bathe in water which is a place for urine and stool. Man will have to find the hidden water I have given him."

So fox went to man. "Oh, foolish man! You have spoiled this big gift of water and now you have many sicknesses. Do you want these sicknesses always?" "Oh, fox! How can these things truly go away?" And fox told man to dig a hole for the hidden water and to put a cover on the top to keep dirt and germs from getting in. Then the fox told man to buy a pump to draw the water out so that no unclean bucket would touch the water.

And man did as fox suggested. And man had healthy water and the diseases stopped. And man was happy again. And God looked down and shook his head and said: "What kind of foolish man!"

8.2 Connection of Water Supply with the Community

Gen 26,12-21; Ex 17,1-7; Num 20,1-13; Dtn 6,11; Js 41,17-20; Jer 14,3 Ez 29,3; Jn 4,5-30

Water supply is not a private, but a community facility. Therefore, the whole community needs to be involved in

1. Decision taking (about price, location, construction, caretaking),
2. Construction,
3. Correct handling,
4. Control of use,
5. Maintenance and repair.

The community is not in need of any water point, but of a water point,

1. considering social connections, to be used by any citizen irrespective of religion, tribe and race,
2. at a suitable location,
3. under control of the proper people,
4. with water in sufficient quantity (the aquifer not being completely exhausted),
5. with water of good quality,
6. easy to operate, especially for children,
7. easy to maintain,
8. with the appropriate infrastructure (spare parts available, etc.).

See also 8.29/1f.

8.3 Process of Community Development - Water Supply Cooperation

Water supply measures without community involvement are a common practice in many places, however, community involvement has invaluable advantages, although difficult, tiresome and slow. Therefore, community involvement should always be pursued.

A community development process with several meetings needs to take place before and during the start of the technical work.

Ideally, the community contributes whatever it is able to contribute depending on the situation, such as:

- unskilled labour,
- local materials,
- feeding of project staff on site,
- cash,
- participation in the operating instruction,
- selection of caretakers for operation and maintenance.

The project contributes whatever the community is not able to provide, such as:

- know-how,
- skilled labour,
- equipment,
- materials from outside,
- transportation,
- supervision,
- operating instruction,
- training for the caretakers.

The form on 2.5/6f is an example of an agreement between a project and a community about the construction of a well.

See also 8.29/1f.

8.4 Cooperation of Water Supply Technicians with the Community

Dtn 6,11b

For successful cooperation between the technical staff and the community, the technicians have to act in certain ways and keep to certain working principles.

The following attitudes need to be observed:

1. Community cooperation is voluntary. If the community wants to achieve its aim, i.e. a well, they need to bring their contribution. If not, no well is going to be built. It is up to them. The project staff should not try to persuade the community or to put pressure on them.
2. The project staff needs to act with great respect towards the members of the community and their capabilities.
3. The project staff needs to be clear and consistent in its relationship with the community.

The following working principles need to be kept:

1. Inform the community ahead of time about your coming.

2. **Keep tools, equipment, files, behind when you arrive until people are ready to accept them. At first, they might be frightening.**
3. **Always greet everybody upon your arrival.**
4. **Behave in a polite manner, quietly and patiently, with respect.**
5. **Assemble all people of the community and project before starting work on a new site. This is the time for greetings, explaining the work, discussing questions, and prayer.**
6. **Talk in an understandable language. Avoid difficult, especially technical expressions. Make sure that everything is translated.**
7. **Consider women equally.**
8. **Avoid embarrassing illiterates by handing them written documents. If necessary, ask for somebody from the community who knows to read (normally the secretary of the well committee).**
9. **Accept anything offered to you with kindness (chairs, drink, food). You may ask, but do not request.**
10. **If you bring your own clean drinking water, do not boast with its cleanliness and do not belittle the water of the village. Share your water, if asked.**
11. **Do not implement any water supply work if the community did not meet its contribution.**
12. **For necessary communication approach the members of the committee rather than individuals.**
13. **Give priority to solve relationship problems and social conflicts during the process of work.**
14. **Do not let yourself get involved in inner organisational problems of the community.**
15. **Call for a community meeting in case of any community related problems instead of trying to solve them on your own.**

8.5 Importance of Adequate Water Supply

Human beings need water

directly for (in order of their priorities)

1. **Drinking,**
2. **Cooking,**
3. **Taking bath,**
4. **Washing kitchen utensils and cleaning,**
5. **Washing laundry;**

indirectly for

6. Cultivating their food (rainwater or irrigation),
7. Watering their animals and thus producing food,
8. Fishing,
9. Building,
10. Generating electrical power,
11. Exstinguishing fire,
12. Running machines,
13. Recreation,
14. Cooling,
15. Flushing latrines,
16. Industries and others.

Water is needed (in order of their priority)

1. in sufficient quantity,
2. in good quality.

Inadequate quantity of water affects the health of people by

1. not enough water to drink → dehydration,
2. not enough water to cook, therefore not enough food → malnutrition,
3. not enough water for cleaning kitchen utensils → transmission of diseases,
4. not enough water for taking bath → development of skin and eye diseases,
5. not enough water for the laundry → skin diseases,
6. not enough water for cultivation → malnutrition,
7. not enough water for animals → malnutrition.

Bad quality of water affects the health of people by

- transmitting water related diseases.

See also 8.29/1f.

8.6 Water Related Diseases

Most diseases in Sudan are due to one of the following reasons:

1. Lack of sufficient water,

2. Lack of clean water,
3. Lack of sufficient sanitation,
4. Lack of preventive health care (immunizations etc.),
5. Lack of curative health care (personnel, facilities, etc.),
6. Relying on (traditional) medicine without consulting medical personnel,
7. Unbalanced diet,
8. Poverty,
9. Distribution of land,
10. Difficult life conditions in parts of the country,
11. Great number of household members,
12. Certain values and beliefs.

A great number of the diseases are related to inadequate water supply. They can be differentiated according to five groups:

Name	Description	Diseases	Help
water borne diseases	carried by water, infecting consumers	cholera dysentery typhoid hepatitis amoeba giardia diarrhea polio	provide clean (safe) water
parasitic diseases	organisms causing the disease spend part of their life cycle in an aquatic host	guinea worm bilharzia filariasis	provide clean (safe) water
filth born diseases = diseases of dirt	caused by insufficient water for washing and hygiene	scabies tropical ulcer trachoma eye infections	provide sufficient quantities of water
water associated diseases	spread by insects breeding in water	malaria river blindness sleeping sickness yellow fever	remove pools, flooded la- trines and other breeding places
diseases by polluted water	caused by drinking chemically polluted water	cancer ...	prevent chemical pollution of water

kidney trouble mottling teeth skeletal fluorosis
--

WATER RELATED DISEASES

Sickness	Other Names	Cause	Vector	Transmission	Preventive Measures	
					before sickness	during sickness
Cholera		toxin, released in gut by bacteria	people, flies	contaminated water and food, incl. ice and cold drinks, uncovered faeces	good hygiene, latrines, safe water	isolation, good hygiene, safe water, disinfect or burn the clothes and blankets, boil plates and cups, disinfection of stools
(bacterial) Dysentery	shigella, shigellosis	bacteria (several different ones)	people, flies	contaminated water or food	good hygiene, safe water, clean and well prepared food, latrines	isolation, separate plates and cups
Typhoid	enteric fever	bacteria	people, flies	contaminated water and food, faeces to mouth	good hygiene, safe water, latrines	isolation, disinfection of stools, wash hands after latrine
Hepatitis A Hepatitis B		virus	people, flies, monkeys	A: faeces to mouth B: blood - using needles of other people	good hygiene, safe water, latrines, sterilized medical equipment	isolation, separate plates and cups, extremely good hygiene
Polio	poliomyelitis	virus	people, flies	contaminated food or water, close contact	good hygiene, safe water, vaccination, latrines	isolation, good hygiene, safe water
Amoeba	amoebiasis, amoebic dysentery	parasite	people, flies	contaminated food or water, poor sanitation	good hygiene, safe water, latrines, keep flies off food	wash hands after de-faecation and before meals
Giardia	giardiasis	parasite	people, flies	see under dysentery	see under dysentery	see under dysentery, papaya seeds protect
Diarrhea	gastroenteritis	bacteria	people, flies	see under dysentery	see under dysentery	see under dysentery
Guinea worm	dracunculiasis	parasite	cyclops in standing water (well or pond)	infected person stands in water or muddy place, warm lays larvae into the water, people drink contaminated water	safe water supply, drainage of standing water	cleanliness, roll worn slowly on small stick (may take a week, do not break the worm), do not go into water

Bilharzia	schistosomiasis - Mansoni - Haematobium	parasite	snail (releases parasite into water)	swimming or walking in infected water (parasite penetrates the skin)	avoid swimming, walking, bathing in infected water, e.g. the Nile, control snails, latrines	urinate and defaecate only in latrines
Scabies	7-year itch	parasite	scabies mite	close skin contact with infected person	avoid contact with infected person, good hygiene	wash all clothes and furniture with hot water and soap
Tropical Ulcer		bacteria		filth, friction, trauma	good hygiene, safe water	daily cleaning of the ulcer
Trachoma	chronic conjunctivitis	bacteria	people, flies	by flies or touch by contaminated fingers	good hygiene, safe water, early treatment	wash left and right eye separately
Eye infections	conjunctivitis	bacteria	people, flies	see trachoma	see trachoma	see trachoma
Malaria		parasite (plasmodium)	mosquitoes	mosquito bites	mosquito net, screening, shut doors and windows in the evening, cut grass short fill in pools	early treatment to prevent anaemia
River blindness	onchoceriasis	parasite	black fly	fly bites	control of black fly	control of black fly
Sleeping sickness	trypanosomiasis	parasite	tse-tse fly	fly bites	protecting clothes, clear bush	
Yellow fever	jungle fever	virus	mosquitoes	mosquitoes living in areas with monkeys	vaccinations, drain breeding places	isolation, mosquito net
Filariasis	- Wuckeria Bancrofti - Loa Loa	worms	- people to mosquito - people to fly	mosquito and fly bites	clearing bush and grass, drain water	mosquito net, insect repellants
Cancer		chemicals in water, and others		drinking polluted water	drink chemically clean water	early treatment
Kidney troubles	kidney stones	water with too much salts		drinking polluted water	drink water with low salt content	drink plenty of water
Mottling of teeth Skeletal		fluorides in drinking water		drinking polluted water	defluoridation of water supply	early treatment

fluorosis

compiled by Inga Andersson

8.7 Basic Facts about Water

Ez 34, 18-19

A) Distribution of Water

No.	Location	Name	Volume (approx.)	Percentage
1	Water in vegetation, animals, human beings	water in biosphere	1,000 km ³	0.00007 %
2	Water in the air (clouds, rain)	water vapour	14,000 km ³	0.001 %
3	Water in lakes, ponds, rivers, swamps	surface water	135,000 km ³	0.01 %
4	Water in the soil underground	groundwater	8,400,000 km ³	0.6 %
5	Ice caps, glaciers, snow	frozen water	29,350,000 km ³	2.1 %
6	(salty) water in seas and oceans	seawater in oceans	1,362,100,000 km ³	97.3 %
	TOTAL		1,400,000,000 km³	100.00 %

Water in the air, in the biosphere, frozen water and seawater are not readily available for water supply. Therefore, water supply for humans mainly relies on groundwater and surface water. Surface water is not available in all locations, whereas groundwater is available in many locations and is the main source of water supply.

Distribution of Groundwater

75 % less than 50 m deep

25 % deeper than 50 m

Hand dug wells are usually constructed up to 50 m depth (depending on the conditions). That means that the majority of groundwater is within the scope of hand dug wells.

See also 8.11.

B) Properties of Water

Some properties of water are listed in the following:

- It consists of hydrogen and oxygen; the chemical formula is H₂O.

- It is transparent.
- It is colourless (with a blue tinge in large bodies).
- It has no taste.
- It exists in three physical stages:
 - * solid = ice
 - * liquid = water
 - * gas = vapour
- The ratio between the weight of water and the weight of (dry) air is 830:1; therefore, water falls in air.
- The ratio between the weight of vapour and the weight of (dry) air is 1:133; therefore, vapour moves upwards in air.
- The freezing point of water is 0°C.
- The maximum density of water is at 4°C.
- The boiling point of water is at 100°C (changing with atmosphere pressure).
- The ratio between the weight of ice and the weight of water is 1:11; therefore, ice floats on water.
- Water is practically incompressible.
- It has capillarity, that is the ability to move upwards in small diameter openings because of cohesion (= the ability to stick together) and adhesion (= the ability to stick to a surface).
- It is an universal solvent; therefore, natural water contains gases and mineral salts in solution.

C) Movement of Water

1. Hydrological Cycle

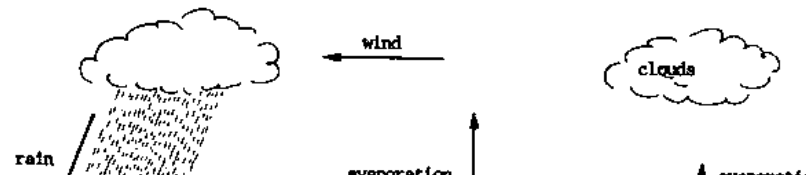

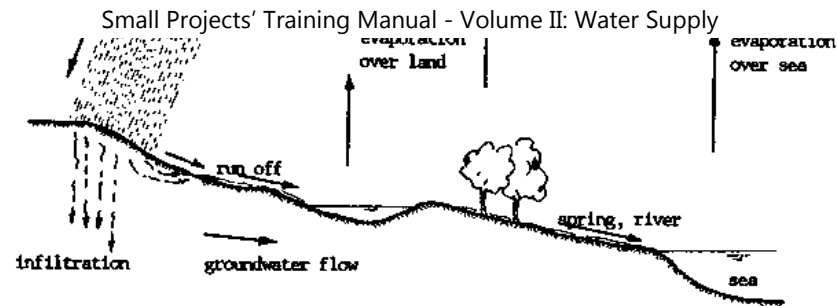

2. Transportation of Water from the Sea into the Continent

Water

- evaporates over the sea,
- travels by cloud several 100 miles,
- rains on forest,
- evaporates from forest,
- builds new clouds,
- travels to next forest several 100 miles away.

That means that water travels in “jumps”. Therefore, forests are essential for the transportation of water into the continent.

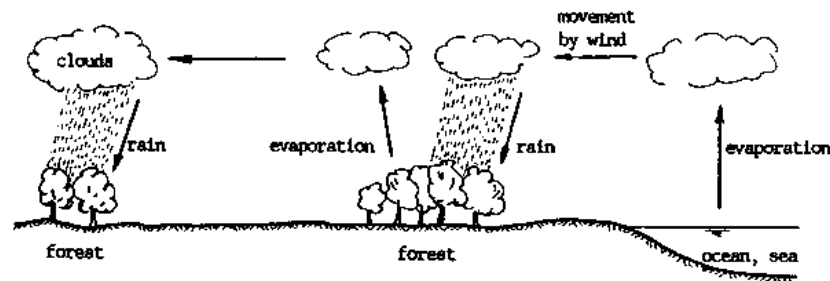

D) Dangers for Water

Our groundwater is a most valuable resource essential for life. It is in danger in many ways:

1. Water Is in Danger of Bacteriological Pollution

Flooded latrines, latrines too close to wells, leaking septic tanks, overflow seepage wells of septic tanks, and defaecation in the open pollute the water with disease transmitting bacteria and viruses. Bacteriological pollution can be cleaned through filtering and disappears by itself with time passing (see also 9.8).

Therefore:

- Do not construct latrines which will be flooded!
- Do not construct latrines near to wells!

2. Water Is in Danger of Chemical Pollution

Flooded latrines increase the nitrate and nitrite concentration in the water (nitrate and nitrite are produced in the decomposition process and are then dissolved in the water).

Poisons like DDT, artificial fertilizers and pesticides, spilled engine oil, diesel or petrol, acids, etc. pollute the water chemically. It is very difficult, mostly impossible, to remove chemical pollution from water (see also 3.11/2; 9.13/2f; 9.16/2; 9.22).

Therefore:

- Avoid the use of poisons like DDT, pesticides, etc.!
- Be careful not to spill engine oil, diesel, petrol, etc.!
- Never pour old engine oil on the ground!

3. Water Is in Danger by Removing Vegetation

Rainwater falling on barren soil will run off quickly and will have no time to infiltrate into the ground and, therefore, to add to the ground-water. (Beside that, winds will carry away the top soil which is fertile.) Soil with vegetation retains the rainwater and allows it to infiltrate into the soil (see also 8.9).

Therefore:

- Do not burn the grass on the fields! If burning is absolutely necessary, do it just immediately before planting the new crops and make sure that the area is limited.
- Do not overcultivate and do not allow overgrazing!

4. Water Is Endangered by Cutting Trees

Trees transport water from the groundwater through their roots up to the leaves. They form clouds through their evaporation. Therefore, forests are essential for creating rain.

People cut trees for clearing fields (and building houses without planting young trees. Tree seeds and young trees are killed by agricultural fires. People contribute to the reduction of rains by neglecting the trees.

Therefore:

- Plant young trees and protect them!
- Cut only as many trees as absolutely necessary! For each tree cut, plant three young ones!
- Do not burn grass!

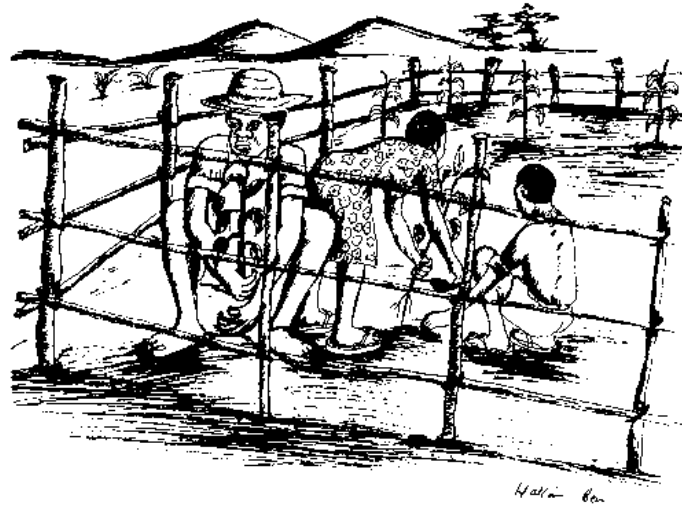

8.8 Groundwater

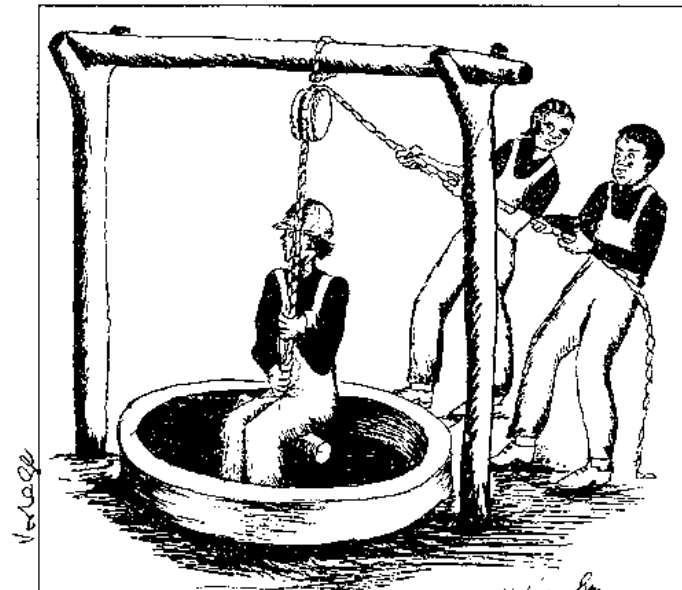

A) Water Storage

The ground soil normally contains air in its pores and is able to store water instead of air in the pores. The water content can be differentiated as follows (see also 8.8/4):

The Soil Is	The Soil Contains	Name	Suitable for Well Intake
dry	air, but no water	soil layer without water	no
wet	air and water	capillary zone or unsaturated zone	no
saturated	water, but no air	aquifer or saturated zone	suitable

B) Properties of Ground Soil

The soil has the following properties regarding water:

- It stores huge amounts of water.
- It prevents evaporation of the water.
- It preserves the quality of water.
- It cleans the water from bacteriological pollution.
- It enriches the water with minerals, etc.
- It makes the water available for trees, wells, springs, etc.
- It balances changes in the climate (dry season - rainy season, droughts).
- It allows vertical transportation (= infiltration).
- It allows horizontal transportation ("underground streams", horizontal seepage).
- It releases water to wells, springs, etc.
- It preserves the water temperature.
- It can make water dirty if the soil is polluted by poisons, old engine oil, fuels, etc.

C) Properties of Aquifers

Two main properties are essential for aquifers (= water bearing layers):

1. porosity = measure for the ability to store water
2. permeability = property of permitting the through-flow of water

Soil	Porosity	Permeability $m^3/day \times m^2$
clay	54 to 557.	0.00005 to 0.1
sand	35 to 407	5 to 150

sand	50 to 407.	5 to 100
gravel	30 to 407.	50 to 750
sandstone	10 to 207.	0.005 to 2.5

D) Types of Aquifers

Often there are different soil layers above each other. They can constitute the following types of aquifers:

1. (Open) Aquifer (= unconfined aquifer = open groundwater)

An aquifer is a saturated porous soil layer containing and transporting water. There can be several aquifers above each other, divided by impermeable layers.

An impermeable layer contains no or little water and does not allow water to infiltrate through it. However, impermeable layers are seldom continuous, therefore, water can pass through the discontinuities.

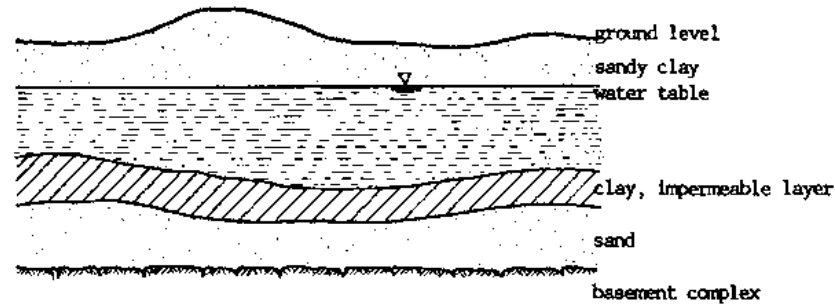

2. Artesian Aquifer (= confined aquifer)

An artesian aquifer is confined by an impermeable layer. If tapped by a well, the water table raises in the well up to the “piezometric surface”. See also 8.35/3.

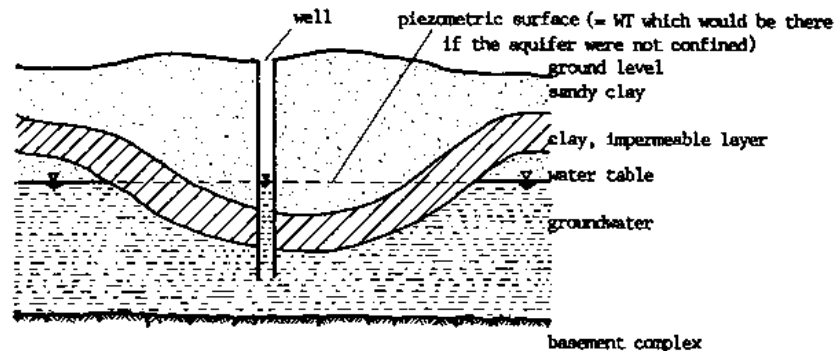

3. Trapped (or Perched) Aquifer

A trapped aquifer is a limited aquifer surrounded by impermeable layers. The recharge is limited; therefore, a well tapping a trapped aquifer can be exhausted and dry out (see also 8.29/1).

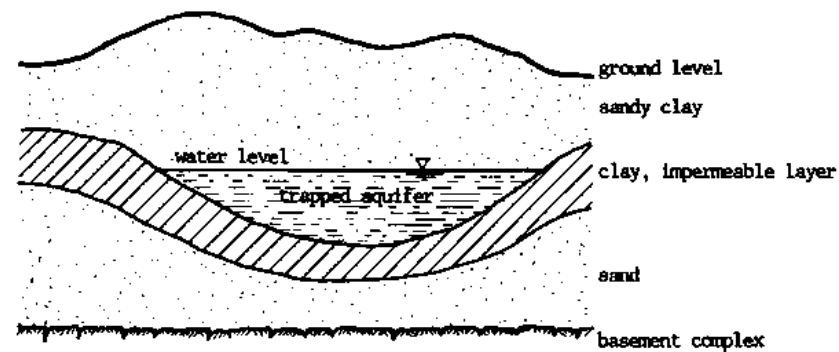

E) Movement of Groundwater

Groundwater can move in two different directions (or mixtures of the two):

1. Vertical Movement

Rainwater infiltrates vertically into the ground by gravity. Also, strong pumping in a well can force the water to move vertically downwards through different layers. Vertical movement is the main movement of groundwater.

The infiltration of water into the ground is influenced by the following factors:

- Steep slopes cause quick run-off, and there is little infiltration into the groundwater.
- Gentle slopes hold the water longer and favour infiltration. They often offer more favourable conditions than completely flat areas.
- Flat areas often develop a tight surface which hinders infiltration.
- Moderate rainfall over an extended period favours infiltration.
- Heavy rains saturate the surface quickly and most water is running off. They compact the soil and reduce its ability to absorb water.

In a vertical cross-section, the ground can be divided into different zones according to their water content:

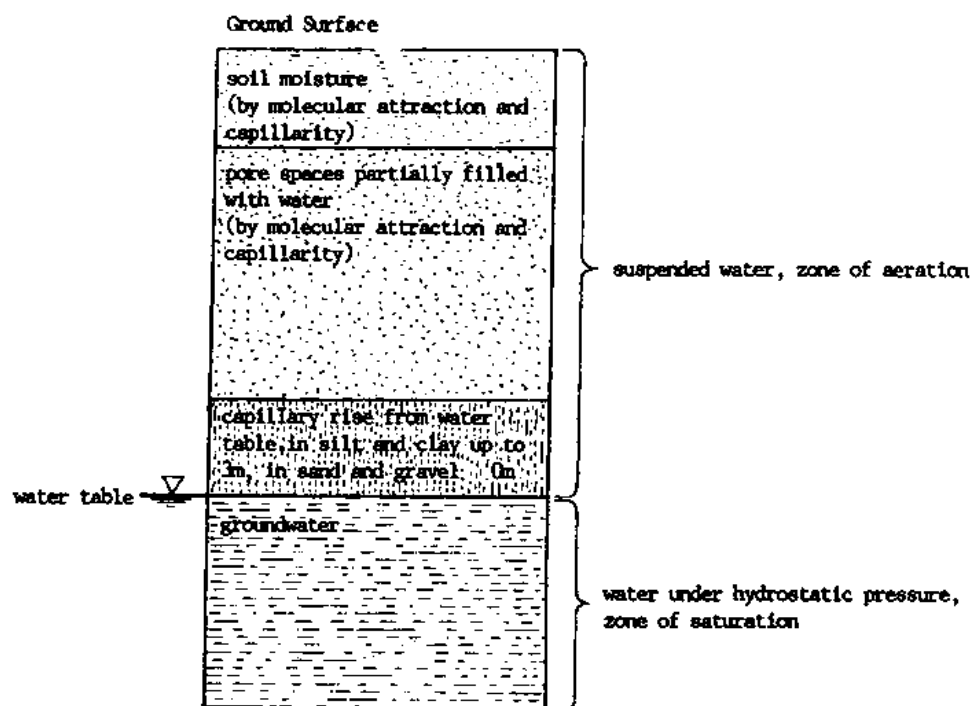

2. Horizontal Movement

The groundwater moves horizontally into a well. Water also can travel horizontally through an aquifer, especially, if the aquifer is sloping. However, this movement is very slow and very limited in distance.

Therefore:

Do not draw more water from a well than is recharged by rain nearby! See also 8.29/1.

F) Connection between Rivers and Groundwater

A river and the groundwater can be connected in different ways:





Influent Stream: looses water to the aquifer

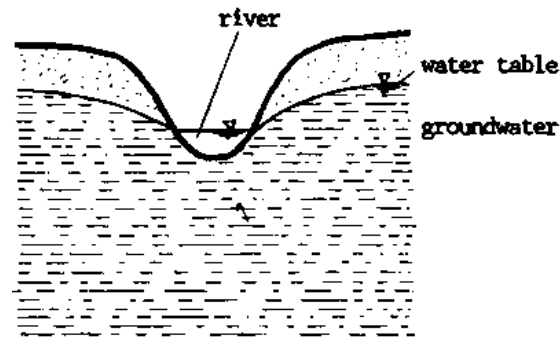

Effluent Stream: gains water from the aquifer (the sane stream may have influent and effluent sections)

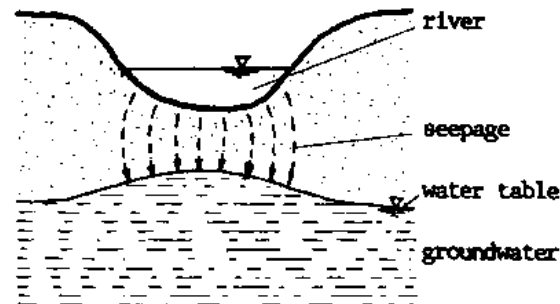

Stream only Flowing Periodically: dry during drought

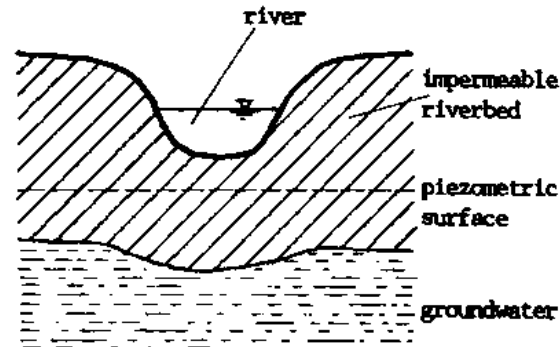

Stream Isolated Hydraulically: from an artesian aquifer below it

G) Types of Soils as Aquifers

Type of Soil	Porosity	Permeability	Difference betw. Unsaturated and Saturated Zone	Cleaning Capability	Rechargeability	Quality of Aquifer	Possible Problems
clay	good, can store lot of water	limited or impermeable, however, no continuous layers	several meters	good	fair	fairly good	slow intake, limited recharge
sand	good, can store lot of water	very good	no	very good	very good	very good	quicksand, collapsing
gravel	very good can store lot of water	very good	no	no	good	very good	collapsing, easily polluted
weathered rock	good	good	no	bad	very limited	good if nothing else available	only limited layers, therefore, limited amount of water
rock (= basement complex)	no except in cracks	no, except in cracks acting as pipe	no	no	very limited	good if nothing else available	difficult to hit the cracks, difficult to dig, limited storage water can be salty because of dissolved minerals
mixtures of soil types	properties differ from site to site						

8.9 Desertification

Is 41,17-20; Jer 6,8; Mi 7,13

Sudan is in danger of becoming a desert. The desert in the North approaches the South by 6 km every year. That means, if nothing changes, the desert may reach Juba in 100 years time, that is just four generations.

The following contributes to desertification

- less rain,
- less forests through cutting of trees and burning of grass,
- less fertile soil because the soil is stripped off its vegetation and thus blown and washed away,
- big agricultural schemes (through digging by tractor, cutting of trees, pesticides and artificial fertilizers),

- Jonglei Canal,
- bombing, spraying of herbicides in war, atomic bomb,
- too many animals and, thereby, overgrazing,
- overpopulation and, thereby, overcultivation,
- exporting timber and charcoal,
- boreholes with water tanks in remote areas (attracting many people and animals).

What can people do to stop desertification?

- **Stop burning grass!**
- **Plant and care for trees!**
- **Plant hedges around fields!**
- **Slow down the run-off of rainwater by small dams and ditches across the run-off direction in your gardens!**
- **Minimize firewood, charcoal and paper consumption!**
- **Reduce the number of animals!**
- **Do crop rotation!**

- Manure your fields!**8.10 Wells****A) Tapping Groundwater**

A hole dug or drilled into a saturated soil layer and lined to prevent collapsing is called a well.

The static water table (= undisturbed water table) is the level of groundwater if no water is pumped from the well.

The draw-down of a well is the difference between the undisturbed water table and the water table in the well while pumping (= disturbed water table).

If more water is pumped from the well than enters from the surrounding groundsoil into it, the water table will sink.

If less (or no) water is pumped than entering the well, the water table will rise (but, of course, never above the static water table). If the same amount of water is pumped as enters the well, the water table remains constant. This water table is called “dynamic water table”. The amount pumped is equal to the yield of the well (which is the capacity of the groundsoil to fill the well). The yield of a well can be measured by test pumping. The pump’s yield is gradually increased. When the water table remains constant, the pump’s yield is equal to the well’s yield.

Summarizing, we differentiate three different types of water tables:

No.	Name	Description
-----	------	-------------

1	static = undisturbed water table	water table without pumping
2	disturbed water table	water table while pumping at <u>any</u> rate, either sinking or raising
3	dynamic water table	water table while pumping with a <u>specific</u> rate equal with the water entering the well; water table remains constant

During pumping the water is drawn from an extended area around the well. By pumping we do not only empty the volume inside the well, but also a space in the shape of a funnel around the well (also called “cone of depression” or “draw-down line”). The volume pumped from outside the well can be as big or even much bigger than the volume pumped from inside the well, depending on the diameter and the draw-down. The greater the draw-down, the more water needs to be pumped from outside, and the more difficult it is to lower the water table further.

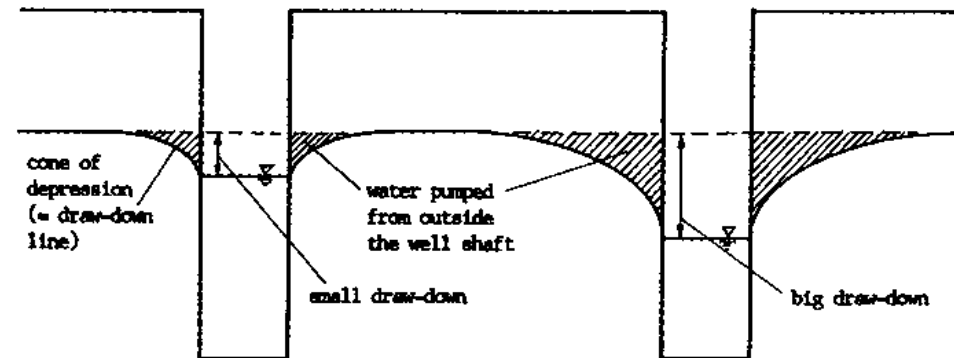

Big diameter well and small diameter well (borehole) with the same draw-down:

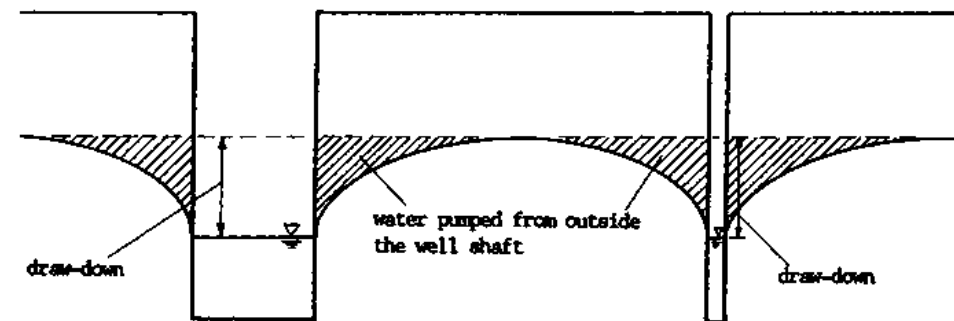

The cone of depression differs in shape and size depending upon

1. pumping rate

1. pumping rate,
2. length of pumping period,
3. aquifer characteristics,
4. slope of water table,
5. recharge within the zone of influence of the well.

B) The Elements of a Well

Each well consists basically of the following elements:

Name	Function	Construction
intake = bottom section	- allows water to enter from the ground into the well excluding the soil - provides storage reservoir	- lining with seepage holes, or - porous lining (filter rings), or - filter pipes for casing
shaft = middle section	- provides access to the well bottom - prevents pollution by surface water - prevents collapsing	- lining with concrete rings, or - brick lining, or - casing pipes
well head = upper section	- prevents or reduces pollution - provides facilities for drawing water	- preferably sealed (concrete cover, apron, drainage) - hand pump, engine pump, or bucket system
well surroundings	- prevent pollution by animals - control use	- cleaned, fenced area

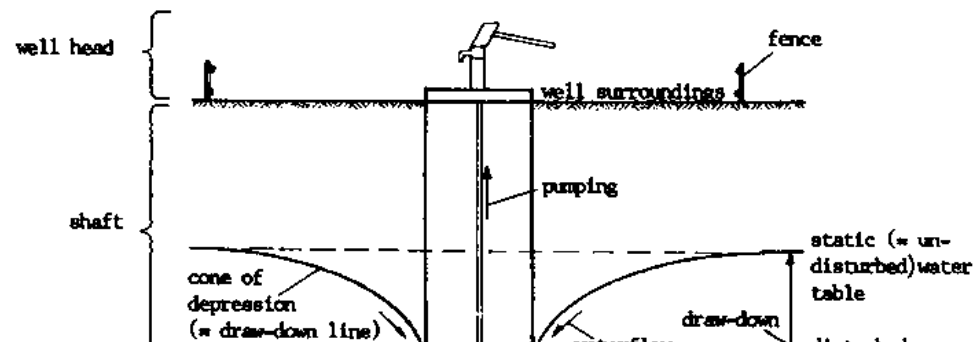

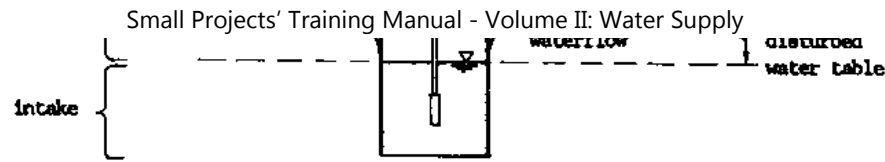

C) Influence of Diameter

The diameter of a well has the following influence on the function:

Influence on	Increasing Diameter	Reducing Diameter
water	<ul style="list-style-type: none"> - increase in yield - more storage capacity 	<ul style="list-style-type: none"> - less yield - less storage capacity
construction	<ul style="list-style-type: none"> - more digging - thicker lining necessary - more materials needed - more difficult to pump during construction - more space during construction for 2-3 people - more danger of collapsing - better ventilation 	<ul style="list-style-type: none"> - less digging - less lining - less materials - easier to pump during construction - narrow for digging (only one person can dig) - more stable - danger of ventilation problems
suitability	<ul style="list-style-type: none"> - in aquifer with low permeability (slow intake) - in not too deep wells 	<ul style="list-style-type: none"> - in aquifer with high permeability (quick intake) - in deep wells

It is important to choose the correct diameter suitable for the particular location. Huge diameters (up to 10 m) are suitable for aquifers with very slow seeping in.

Big diameter wells (\varnothing 1.40 to 4.00 m) are suitable where the permeability of the soil is limited and the water enters slowly into the well. In these cases a big filter surface and a big storage capacity are necessary.

Medium diameter wells (\varnothing ca. 1.10 m) are suitable where the groundwater is deep.

Small diameter wells (boreholes) are suitable in rock, in case of very deep water tables. The soil must be permeable, because the storage capacity of boreholes is very little.

For diameters of concrete rings, used for well construction, see also 8.16/4ff.

D) Increasing the Yield of a Well

The yield of a well can be attempted to be increased by one or several of the following measures:

1. Increase the depth of the well.
2. Increase the diameter of the well.

3. Clean cracks in the intake area.
4. Clean away collapsed clay around the lining and replace it by gravel.
5. Increase the porosity of the intake lining (i.e. by additional holes).
6. Pump the well for few days as much as possible (This opens ways in the groundsoil).

However, the yield of a well can only be influenced to a certain degree. It depends on the location chosen, the soil conditions, and the quality of the aquifer. Even a limited yield of a well can be useful in a certain location, and the conditions given by nature need to be accepted.

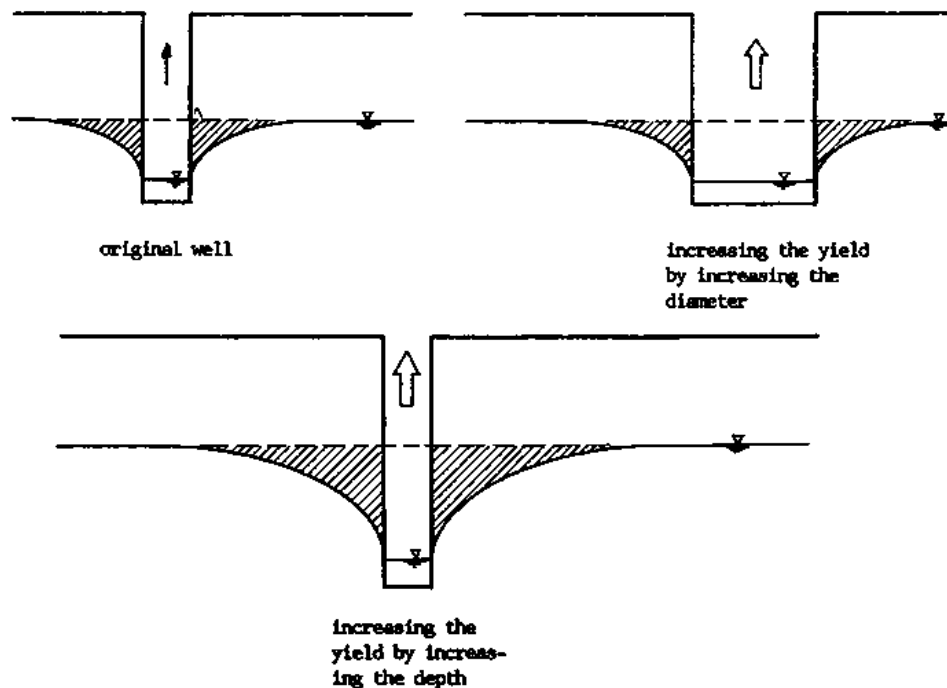

8.11 Comparison of Borehole and Hand Dug Well

Boreholes and hand dug wells can be differentiated according to the following features:

No	Feature	Borehole	Hand Dug Well
	Drawing		

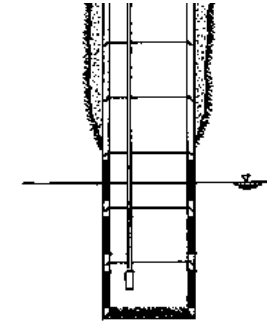
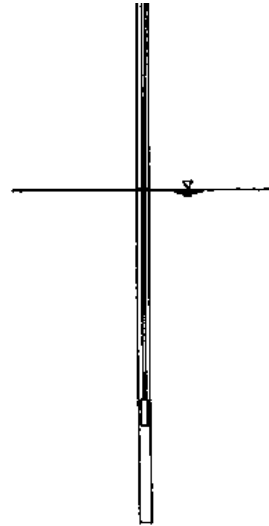

1	Definition	well excavated with equipment from the surface	well dug by people enter-ring the well
2	Depth	deep: 10 to 200 m see 8.7/1	shallow: 3 to 50 m (in exceptional cases up to 150 m)
3	Diameter	small: 5 to 20 cm	big: 1 to 4 m (a person can enter)
4	Form	round	round or square
5	Intake	only from the side through filter casings	from the side through filter rings and from the bottom
6	Storage capacity	relatively small because of small diameter	large because of big diameter
7	Well shaft	casing from steel or PVC pipe or no lining in rock	lining from brick wall or stone wall or concrete rings or no lining in rock
8	Well head	pump with platform see 8.19/3f	open with platform or closed with concrete slab and pump; see 8.19/5f
9	Drawing of water	by handpump or by engine pump or by bailer see 8.24	by rope and bucket or by winch or by handpump or by engine pump; see 8.24
10	Digging	drilled by drilling rig, sometimes by hand	dug by hand
11	Labour needed	high-skilled labourers in small numbers	some skilled and many unskilled labourers needed (= labour intensive)

12	Time needed	relatively fast	time consuming
13	Material needed	casing pipes, cement, sand, gravel, water, pump, etc.	cement, sand, gravel, reinforcement, pump, etc.
14	Equipment needed	highly sophisticated machinery (= capital intensive)	hand-tools like pick axe, shovel, bucket, rope, etc.
15	Energy needed	fuel, engine oil	human energy
16	Space needed	large area needed for rig	large area needed for excavation
17	Accessibility required	for heavy lorry	for pick-up, eventually only for people footing
18	Transport needed	lot of transport needed	little transport needed
19	Risks involved	common dangers of working with lorries and heavy machinery	danger of working inside a well
20	Costs	very expensive	moderately expensive
21	Availability of resources	most resources from abroad (rig, fuel, casing, highly skilled labour)	most resources from with in the country
22	Community participation	very limited	community can easily participate in construction
23	Water quality	safe if surroundings clean, platform intact, groundwater not polluted	safe if closed and surroundings clean and groundwater not polluted
24	Yield	depending on conditions, often limited, esp. in rock	depending on conditions, often quite high
25	Maintenance	maintenance of pump, daily cleaning of surroundings	inside cleaning yearly, daily cleaning of surroundings, maintenance of pump, if installed
26	Rehabilitation if yield drops	hardly possible	cleaning and digging deeper possible
27	Life time	limited by corrosion of casing, clogging of filter casing, break-down of pump	limited by eventual dropping of water table
28	Beneficiaries	well users, few local labourers, foreign companies	well users, local labourers, local manufacturers and suppliers

The above mentioned factors determine whether a borehole or a hand dug well is suitable for a particular situation. Under certain conditions, a hand dug well is not suitable, but a borehole can be drilled. Under certain conditions, a borehole is not suitable, but a hand dug well can be constructed. Under certain conditions, both borehole and hand dug well are possible (see 8.7/1).

When both borehole and hand dug well are possible, governments, development agencies and many people tend to favour boreholes. In many countries facilities and training are readily available for boreholes, but neglected for hand dug wells. This is a bias towards foreign resources and technology.

techniques and training are readily available for boreholes, but neglected for hand dug wells. This is a bias towards foreign resources and technology.

SCC's water and sanitation project pursues a different policy: Wherever construction of hand dug wells is possible, they should be favoured because of maximum utilization of local resources and possible community involvement. The resources for boreholes shall be utilised where hand dug wells are not possible.

8.12 Selection of Well Sites

Gen 26,32

The selection of a suitable well site is essential for the success of a well.

A) General Requirements

A suitable well site has to meet the following requirements:

1. It should be within walking distance (1-2 km) from the relevant village.
2. It should be accessible by pick-up/truck during the construction phase, and accessible for the villagers throughout the year.
3. It should not be within 100 m of cattle pools, latrines or other health hazards (like septic tanks, workshops, etc.), and preferably upstream of these. The distance depends on the soil conditions. However, 100 m lies on the safe side. 50 m distance can be acceptable under certain conditions. Closed compost latrines require a distance of 6 m to the next well.
4. It should be safeguarded against flooding. Especially near rivers, the location has to be chosen so that the well is not threatened by any meandering of the river. Furthermore, the danger of flooding of low-lying areas should be taken into account.
5. The subsoil should not render the construction of a well impossible. It is difficult to make hand dug wells in rocky materials, even if these contain sufficient quantities of water in cracks.

B) Geological Guidelines

1. Layers of sand and gravel are the best aquifers.
2. In karstified limestone, the danger of pollution of groundwater from the surface is very great.
3. In granite areas, weathered rock may contain good aquifers.
4. In mountainous areas, the best aquifers are found along the edges of the valley.



deposit of gravel and sand,
promising place for a well



5. Good aquifers can be found under the riverbed and in the river banks (i.e. in “buried” rivers) or at lake sides.

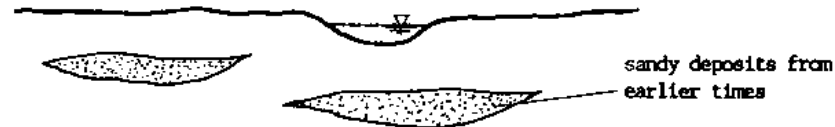

6. Outcropping granite hills in connection with small dry valleys and depressions are promising areas.

7. Crushed zones at fault lines (fractures, folds) are very good water bearing layers.

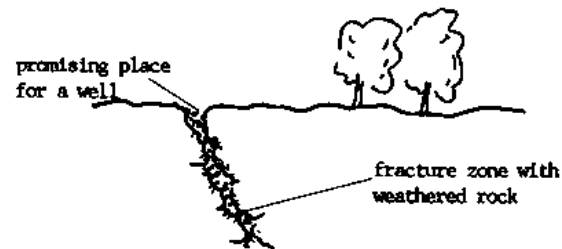

8. Vegetation such as banana trees, date palms, sugar cane, ever green areas, indicates shallow groundwater (0-5 m).

9. Vegetation such as mango trees, nim trees, etc., indicate deeper groundwater.

10. Certain vegetation (certain trees, grasses, salty taste of sugar cane) indicates salty groundwater.

11. Deposits of clay suitable for making pots can indicate near ground-water.

C) Methods for Well Siting

The following methods can be used for well siting:

1. Gathering information from existing wells
2. Gathering information from local well diggers
3. Hand augering
4. Divining
5. Well siting with instruments like resistivity meter, seismograph, etc.
6. Evaluating groundwater maps
7. Evaluating aerial photographs

8. Evaluating satellite photographs

The first three methods will be mostly available for small water projects. Good water supply technicians continuously gather information when they come across wells and, thus, gradually develop a feeling for soil and groundwater conditions, geology and vegetation. We also need to build up a respectful relationship with local well diggers and thus share knowledge and benefit from their rich experience.

8.13 Site Survey by Hand Augering

Hand augering is drilling a small diameter borehole by hand. It is a helpful tool amongst others for selecting a suitable location for a hand dug well (see also 8.12/2). The method is comparatively cheap and simple. It can be learnt quickly and does not require complicated equipment.

Hand augering is not possible under all circumstances. The limits depend on the hardness of the soil, the depth of the water table, and the perseverance of the technicians.

If the water table cannot be reached by hand augering, it might still be possible to construct a good hand dug well - the water table might be just below the reach of the hand auger.

A) Purpose of Hand Augering

Hand augering can be used for gathering the following information:

1. Presence or Absence of Groundwater (within the reach of the augering);
2. The Depth of the Water Table;
3. The Thickness of the Aquifer (= water bearing layer);
4. The Nature of the Aquifer: the type of soil of the aquifer, its content of gravel, sand, clay, and silt, and, thus, the permeability of the soil;
5. The Possible Recharge Rate (= yield) of the well, concluded from the permeability of the aquifer soil;
6. Water Quality (salty or not salty, etc.);
7. Possible Movements of the Water Table, concluded from the colours of the augered material;
8. Minimum Depth of the Well, concluded from the depth to hard rock or the first impermeable (= impervious) layer.
9. Possible Storage Capacity of the well, concluded from the depth to hard rock or the first impermeable layer;
10. Suitable Construction Method for the well, concluded from the thickness of the soil layers and their stability; (Is temporary lining or caissoning necessary? How thick is an eventual sand layer?); see also 8.14;
11. Presence of Single, Invisible Rocks Underground: in some areas single blocks of rocks are dispersed above and underground - if you hit such an underground rock, a well site suitable for digging might be just a few metres away;

12. Investigation of an Extended Area, like a river bank by augering a number of holes in a systematic way;

13. Presence of Water Table below a Dry Well by drilling inside the already dug and so far dry well.

B) Selecting Location and Time for Hand Augering

We will waste energy if we just start to drill holes without previous planning. Consider the following:

1. Collect all available information (see 8.12).
2. Study the map and see where there would be the best sites for augering.
3. Have a careful look at the area on site before you start augering.
4. Preferably drill when the soil is wet. Drilling in completely dry clay is very difficult.
5. If necessary, drill a systematic net of holes over a certain area, e.g. every 100 m:

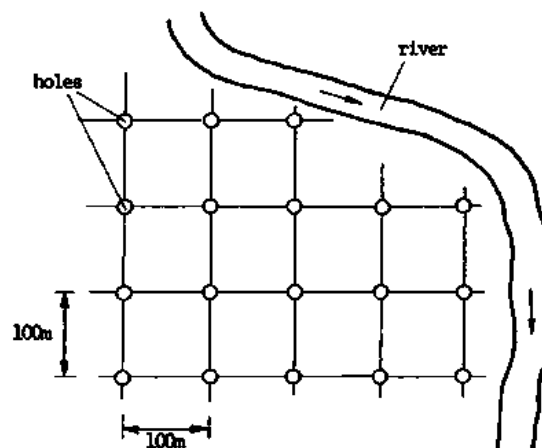

C) Hand Augering Equipment

Light weight hand augering sets can drill small holes of 5 or 7 cm diameter. Heavy weight sets can drill larger holes up to 10 cm diameter or even more. These types differ in the diameter of the bits, the thickness and strength of rods, handles, the type of couplings, and the number of people required; but they consist of the same elements and are to be handled in the same way.

A set of hand augering equipment consists of the following elements:

1. Handle

The handle can be extended by short pipes to increase the lever arm. The heavy weight set can be drilled by two or more people.

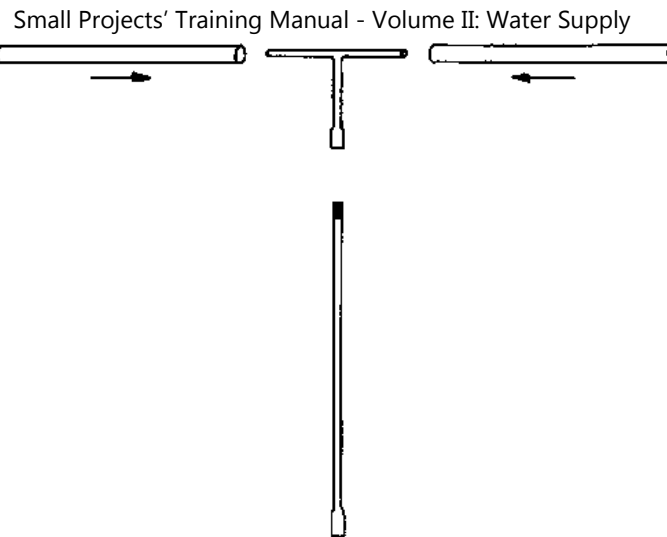

2. Extension Rod

Usually, extension rods are 1 m long. A sufficient number is required. The rods can be connected either by a bayonet coupling for light weight sets or threaded couplings for heavy weight sets. The threads are protected by thread protectors when stored.

Bayonet Coupling:



Threaded Coupling:



3. Open Clay Auger

The auger body of the open clay auger (= combination bit = combination auger) consists of two blades, the ends of which are forged into the auger's end. Upwards the blades diverge gradually up to the desired diameter. Depending on the width of the blades, the auger is suitable for clay, sand or coarse sand if the soil is very soft.

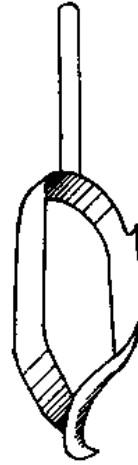

4. Flight Auger

This bit is made of a steel strip wound around the central rod in a spiral form. It is suitable for soft soils.





5. Stone Auger

The stone auger resembles the open clay auger, but the blades are longer. The bit is suitable for weathered rock.

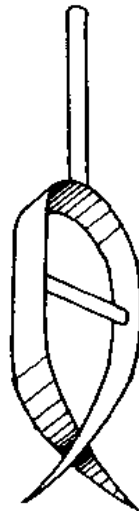

6. Stone Catcher

The stone catcher is made from a strong rod, curved in spiral form. It is suitable to catch stones and gravel embedded in clay soil.

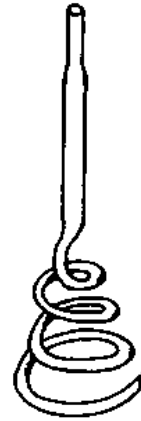

7. Screw Auger (= Spiral Auger)

This bit is made of a steel strip, forged in a spiral form. The diameter is smaller than the one of the other bits. With this bit hard layers can be broken loose and the material brought out with other auger types afterwards.





8. Riverside Bits

The auger body of these bits is a tube with two blades welded at the bottom. The sharp extremities of the blades point at an angle downwards, a little outside the tube. The blades are spoon-shaped so that the soil is steadily pushed into the tube. This bit is suitable for use in hard, stiff soils and in all kinds of materials below water level.



9. Bailer (= Pulse Auger)

The bailer is a 60 cm long tube fitted with a valve at the bottom. It is used for penetrating saturated layers by moving it up and down or for dewatering the hole for test purposes



10. Auger Cleaner

The auger cleaner resembles a knife and is used for cleaning the augers.

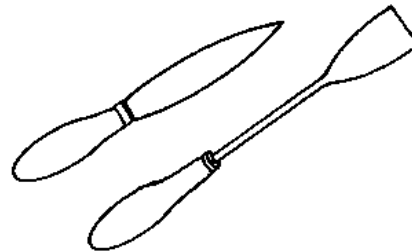

11. Meter

A water level meter has a plumb with a small cave in the bottom which produces a sound when reaching the water table in the borehole.



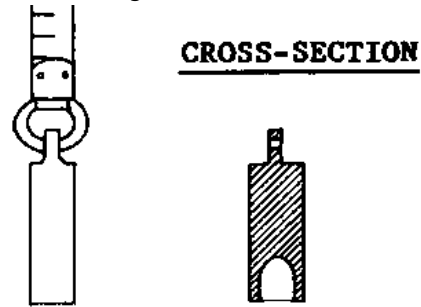

12. Diverse Tools

such as spanners, hammer, wire brush, nylon brush, oil, grease, etc.

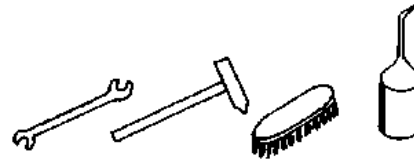

13. Equipment for Recording

such as writing pad, paper, pencils, forms, etc.

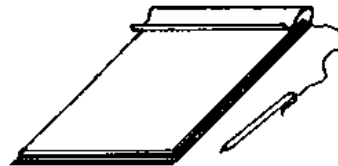

14. Tool Box

big enough for all parts of the equipment, including list of the contents of the tool box.

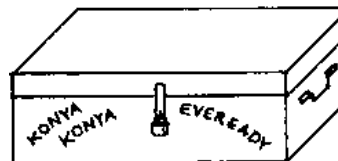

15. Sample Box

A sample box is a coverless, long and narrow wooden box, divided into a number of compartments. During the drilling, a sample of each 50 cm is placed in the box to prevent mistakes in the description.





D) Step-by-Step Procedures of Hand Augering

For hand augering, follow these steps:

1. Connect the handle, a rod and a bit.
2. Drill by one or several people (for heavy weight set).
3. When drilling becomes hard, remove the auger and clean it.
4. Drill again. Continue in this way.
5. When the rod has almost disappeared into the hole, add another extension rod. Continue in this way.
6. Change the bits according to the soil type.
7. Never force the auger; if it will not turn with ease, change to a more suitable bit, e.g. the screw auger for breaking the material loose, and remove the soil with another auger.
8. Keep the threads always clean and greased. For storing, always protect them with a thread protector.
9. Put samples into the sample box every 50 cm.
10. Record any changes in the soil in a log (example for a well log see under E).
11. Try to drill as deep into the water table as possible.
12. If pumping equipment is available, make a test pumping.
13. Otherwise, dewater the hole with a bailer (= bail out the hole). Record the number of times the hole needs to be bailed and, thus, the number of litres you have bailed out.
14. If the hole goes dry, measure the depth of the water in the hole at 5 minutes intervals to gain the recharge rate.
15. After finishing augering, clean, dry and oil the equipment.
16. Record the water table after few hours.
17. Complete the records.

E) Hand Augering Log

Keeping careful records is much easier with the help of forms: Fill the form, "1. General Information", immediately after augering. Fill the form, "2. Soil Profile", during augering. Whenever there is a change in the soil, measure the depth. Draw a horizontal line on the form, "Soil Profile", at the measured depth. Note down all the information about the soil above this level also above the horizontal line. When you take a soil sample, record its number. Cross which type of soil you found, cross which colour it has, and cross if it is permeable or impermeable. Record all the information about the next soil layer below the horizontal line. Continue in this way for all the layers in the borehole.

Sudan Council of Churches * Munuki Water and Sanitation Project

HAND AUGERING LOG

Well No.	:
Community/Owner	:
Location	:

1. GENERAL INFORMATION

Auger hole No.		Test bailing	does not go dry
Location of the hole			goes dry
Date of augering		Number of bailers	
Season	rainy season	Volume of bailer	litres
	dry season	W. Table after 5 min	m
Time started		10 min	m
Time ended		15 min	m
Total time needed		20 min	m
Vegetation	no vegetation	25 min	m
	grass land	30 min	m
	grass and bushes	WT after... hours	m
	thin forest	Water	clear
	thick forest		turbid
			no smell

Special vegetation			bad smell
Bits used	open clay auger		not salty
	flight auger		slightly salty
	stone auger		very salty
	stone catcher	Damages of equipment	
	screw auger		
	riverside bits	Number of people	
first wet soil	m	Technician resp. Signature	
first water table (WT)	m		

2. SOIL PROFILE

Auger hole No.

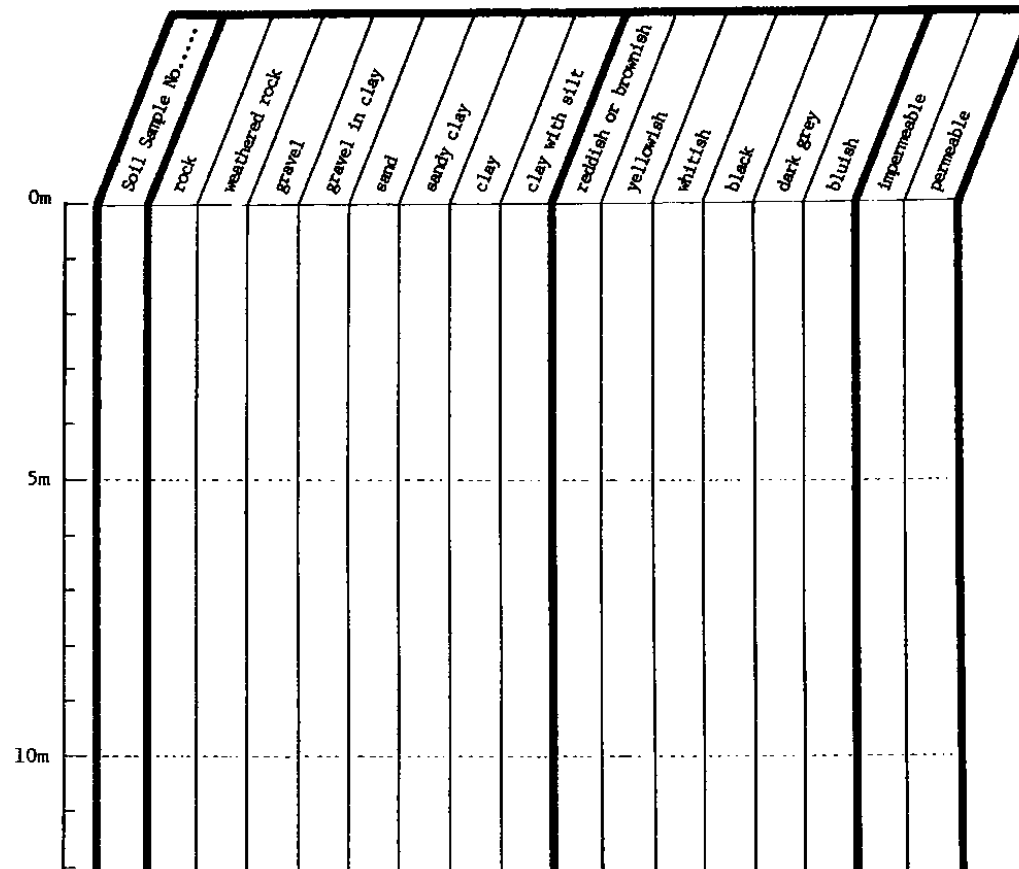

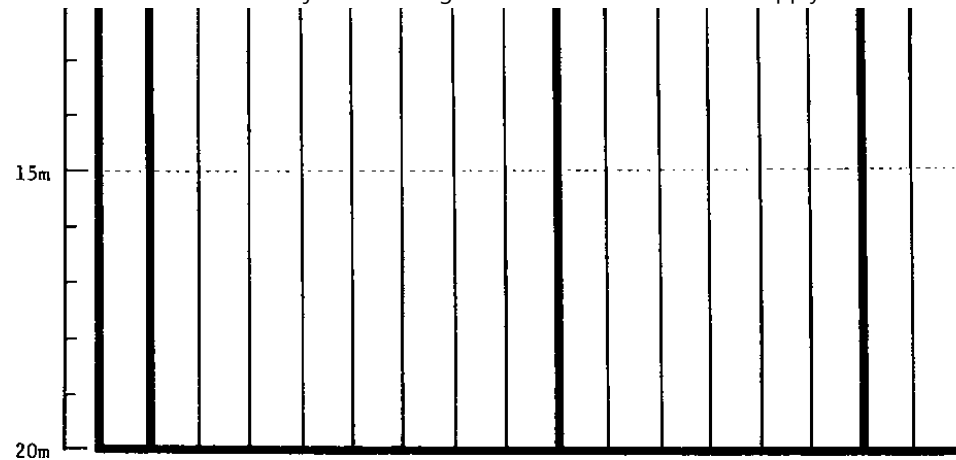

F) Evaluation of Hand Augering

The evaluation of hand augering requires experience. However, consider the following aspects when filling in the form, “HAND AUGERING EVALUATION” (see 8.13/12):

1. If you have drilled several holes for locating one well, choose the hole with the thickest aquifer as well site.
2. The water table measured after few hours is the static water table for the season at the time of augering.
3. Conclude from the colour of the augered material on the expected change of the water table between the seasons:
 - Reddish soils are well drained and well aired. Such layers are most likely not below the water table at any time.
 - Yellowish soils indicate that the soil is full of water for long periods. Such layers might be below water table for a part of the year (during rainy season).
 - Bluish colours in dark grey soil indicate that the soil is water-logged most of the time - similar to the yellowish soils.
 - Black and dark grey soils are usually badly drained and, therefore, likely to be permanent below the water table.

Also, consider your knowledge about the change of the water table during the seasons in the area; generally, the deeper the water table, the less is the seasonal change. Seasonal changes of several metres are more likely in shallow wells (but they must not necessarily be as great).

4. Conclude from the aquifer's soil type and the thickness the expected recharge rate. The coarser the material, the easier it will release its water content.
5. Judge whether the water is expected to be drinkable or not, considering the salt content.
6. Conclude from the depth of hard rock or the first impermeable layer how deep the well must be. It is advantageous to dig 0.50 m or 1.00 m into these layers, if possible. Add about 0.40 m for the well head. Divide the minimum depth by 0.85 cm, the nominal height of a concrete ring, to get the

required number of rings. Add one or two rings to be on the safe side.

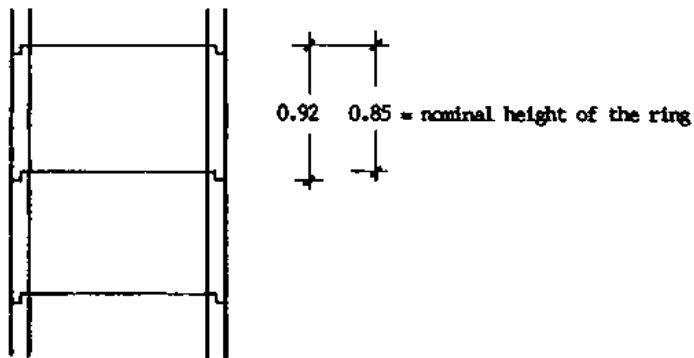

7. Determine the required number of filter rings by looking at the expected height of the water column in the well.
8. Decide which diameter is suitable (see also 8.10/4 and 8.16/6).
9. Suggest a suitable construction method according to the stability of the soil in shaft and intake (see 8.14).
10. Suggest a suitable water lifting device according to the expected depth, recharge rate and the social circumstances (see 8.29 and 8.24).

Sudan Council of Churches * Munuki Water and Sanitation Project

HAND AUGERING EVALUATION

Well No.	:		
Community/Owner	:		
Location	:		
Auger holes No.		expected stability of well shaft	good
Well location suggested at hole No.....			medium
Static Water Table	... m dry season		low
	... m rainy season	expected stability below water table	good
Aquifer soil type			medium
			low
Aquifer thickness	m	construction method suggested	
Recharge rate expected	high		

	medium		
	low		
Water quality expected	drinkable		
	not drinkable		
minimum depth of well	m	water lifting device suggested	
total No. of rings	pcs		
fully concrete rings	pcs	Remarks:	
filter rings	pcs		
diameter suggested	m		
expected water storage capacity	... m or... rings $V = \dots m^3$		
prepared by:		Date:	Signature:

8.14 Construction Methods for Hand Dug Wells

There are many different ways to construct a hand dug well. The following overview should help to select the suitable method for a specific situation. You might be forced to use different methods for wells within the same area.

A) Types of Lining

The lining of a well is a layer of material added to the inside surface of a well. The lining serves the following purposes:

- It prevents the well from collapsing.
- It protects people working inside the well.
- In the bottom section (= intake), it allows water to enter the well.
- In the top section (= shaft) it prevents contaminated surface water from entering the well.
- It serves as a foundation for the well head.

The most important types of well lining are:

1. No Lining at All

No lining at all is, of course, the cheapest and simplest possibility, but only under suitable soil conditions like hard rock or, above the water table, in very

hard clay.

2. Lining with Masonry

Masonry lining can be

- from bricks
- from stones.

Masonry lining is advisable if bricks or stones are easily available near by, and cheap. However, more cement is needed for masonry than for concrete rings which, again, increases the cost. A very important factor in the decision might be if masons are available locally who are able to do brick lining, but no technicians for constructing a concrete lining are available. A masonry lining is not as strong as a concrete ring lining. It also requires a soil which is temporarily stable on its own until the lining is built up. In soft, sandy soil a masonry lining is excluded for the above reason. The depth possible for masonry lining is limited because the transport of materials gets much more difficult with increasing depth.

3. Lining with Concrete Rings

Concrete ring lining can be

- cast outside the well and lowered into the well later on;
- cast in situ (= inside the well).

Concrete lining is suitable in any soil condition. However, the equipment, the materials (cement, sand, gravel, reinforcement) and the skilled labourers must be available at reasonable distance and price. Lowered concrete rings are the best option for very deep wells.

Other types of lining, e.g. timber shuttering, are of no importance.

B) Constructing a Collar

A collar is a short wall around the mouth of the well. It serves the following purposes:

- It protects the well mouth from being washed out and widened by rain.
- It protectes the well mouth from collapsing due to the work on top.
- It protects the well shaft during digging.
- It provides a firm and safe working place for the labourers at the well mouth.

It is advisable to build a collar whenever the well is expected to be deep and digging will need a long time (for all methods described under C, except No. 5 and 7).

Construct the collar as follows:

1. Dig a pit wider than the well diameter:



2. Build the collar from bricks or stones in cement mortar:



3. Continue digging inside the collar:

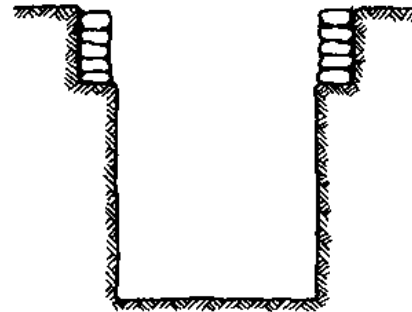

SCALE 1:50

4. If there is a rock layer near, use it as foundation for the collar:

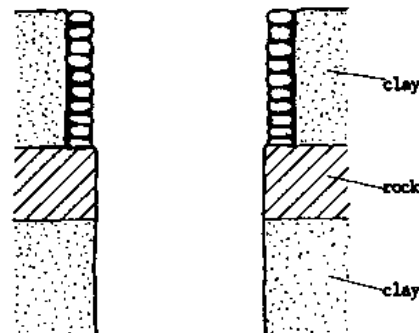

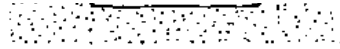

SCALE 1:50

C) Different Construction Methods

When constructing a hand dug well, different types of lining can be used separately or can be combined. Different methods are briefly described and compared in the following (incomplete) list:

1. Caissoning below Water Table and Concrete Ring Lining

For this method, follow these steps:

- Build a collar.
- Dig until the water table is reached. Stop at the first signs of water.
- Lower a ring.
- Dig into the water table inside the ring while the ring slides down.
- Lower more rings on top whenever necessary.
- Dig into the water table as far as possible.

- Line the whole well with concrete rings and backfill it.

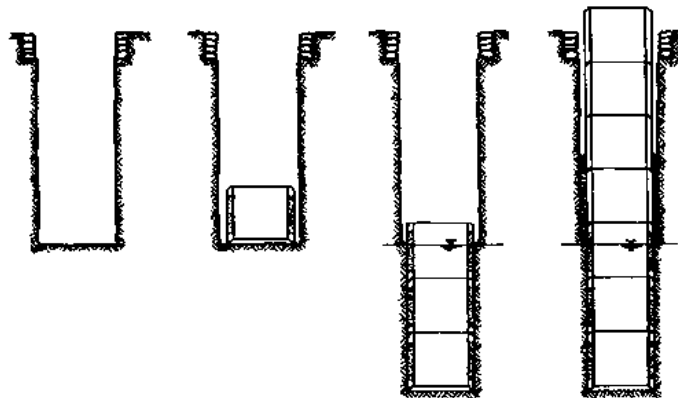

SCALE 1:80

This method is suitable for soil types which are stable above the water table, but unstable below the water table (such as clay, sandy clay, etc.). This method is very handy because it allows easy and quick digging above the water table, but provides protection below the water table. It allows for easily digging deep enough into the water. Constant observation is necessary because of the risk of collapsing. It is most important to stop digging before entering the water table because the soil becomes immediately soft and muddy when saturated. It is very difficult to correct a ring askew in mud, rather than digging in a straight, proper way from the beginning.

2. Lining after Digging

For this method, follow these steps:

- Build a collar.
- Dig the well until its bottom is sufficiently below the water table.
- Lower concrete rings to line the well below and above water table and backfill them.

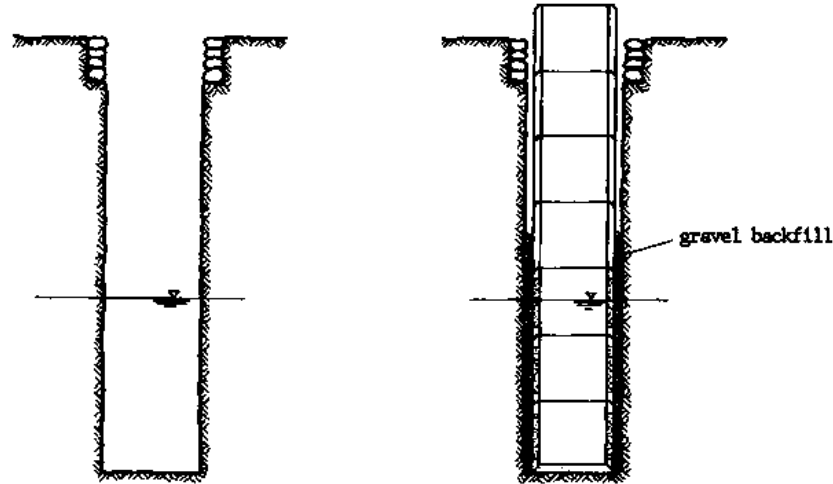

This method is only suitable in soil types which are also stable below the water table. This is the case, for example, for rock or weathered rock which is stable for the time being, but needs a lining in the long run because of cracks or mud fill-ins. The method is very handy.

3. Completely without Lining

This method consists only of two steps:

- Build a collar.
- Dig the well until its bottom is below the water table.

This method is only suitable in pure hard rock, without major cracks or mud fill-ins. You have no work with the lining, but digging itself will be very difficult and slow.

4. Caissoning with Two Rings and Brick Lining

For this method, follow these steps:

- Build a collar.
- Excavate 90 cm deep.
- Cast a ring in the hole with pipe moulds (see 8.16/7).

- Cast a second ring on top.
- Dig the well inside the rings while the rings slide down (= caissoning).
- Dig as deep into the water table as possible.
- Build a brick or stone lining on top of the rings and backfill it.

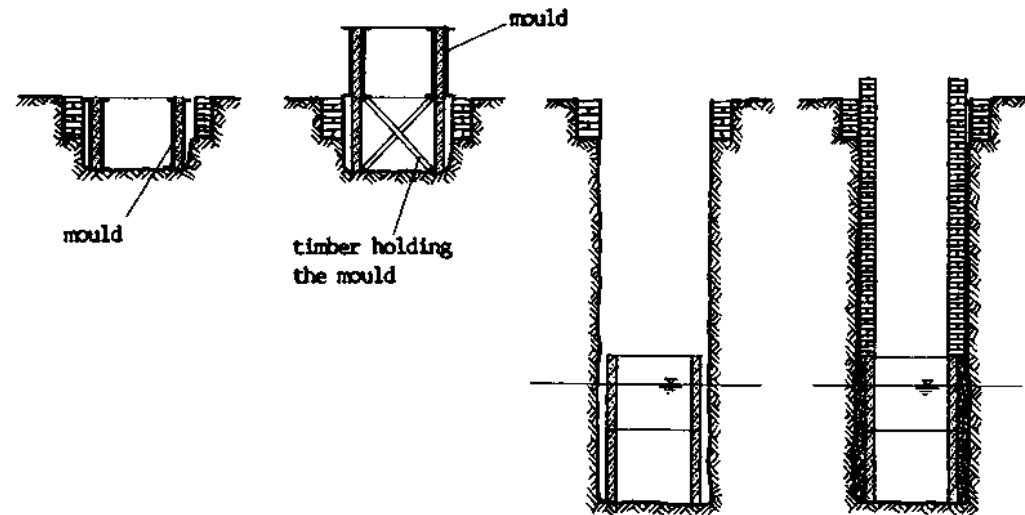

SCALE 1:80

With this method, it is easy to dig deep enough into the groundwater. No lowering equipment for rings is required, only a wooden scaffold and a pulley and a mould for the rings. Therefore, the method has advantages for very remote areas. Digging the full length of the well with two rings caissoning is not very handy, but helps to dig straight. The method is only suitable in soft, but stable soils, not in weathered rock or rock, because the rings tend to get stuck at the slightest protrudings of rock.

5. Caissoning the Complete Length of the Well

For this method, follow these steps:

- Cast the necessary number of concrete rings.
- Place the first ring with cutting edge on ground level.
- Dig inside the ring until the ring has almost disappeared into the ground.
- Roll the second ring near by.
- Turn it over until it sits on top of the first ring.
- Continue to dig until the second ring has almost disappeared into the ground.
- Place the next one on top, etc.
- Continue until you are deep enough into the water table.

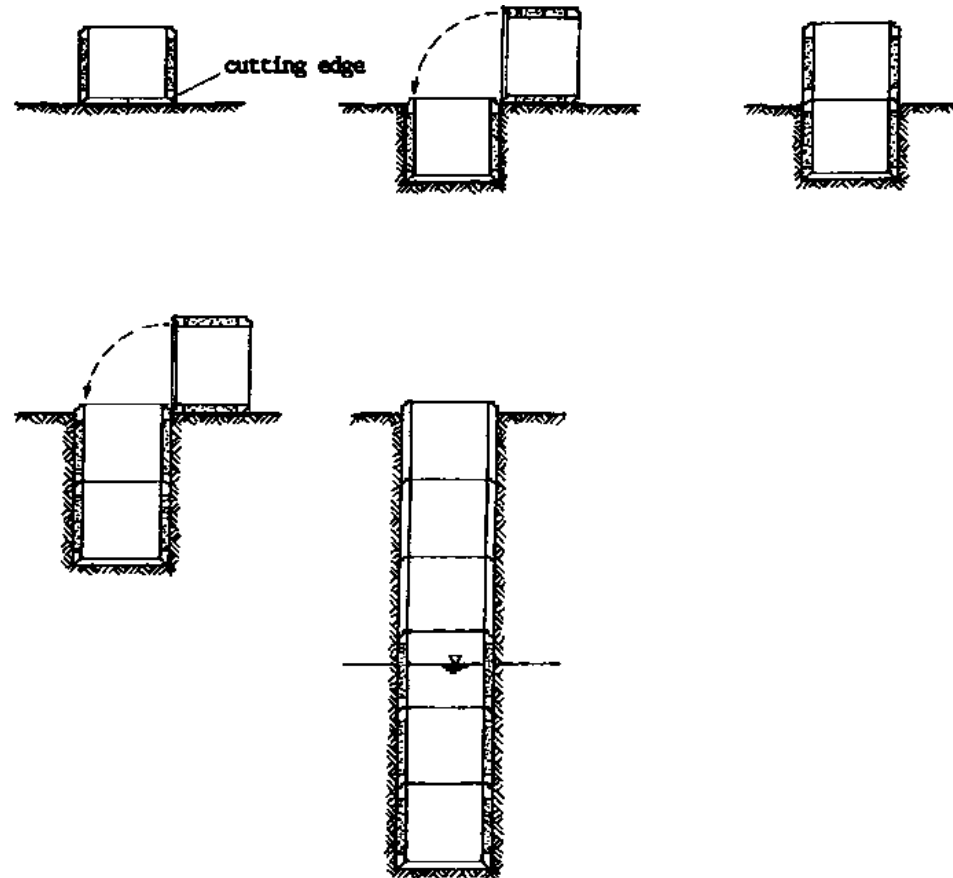

SCALE 1:80

With this method, it is easy to dig deep enough into the groundwater. No lowering equipment for rings is required. The method is only suitable for wells up to about 6 m deep, in soft soil, because the friction between rings and soil becomes too great and the rings would just not move downwards anymore.

6. Telescoping

For this method, follow these steps:

- Build a collar

- Build a collar.
- Dig inside the collar 15 to 20 m deep.
- Build a foundation in the bottom from concrete or stones in cement mortar.
- Line this section by lowering concrete rings of large size (or by masonry).
- Dig inside the lining until the water table is reached.
- Build a foundation in the bottom.
- Line the second section with concrete rings of medium size (or masonry).
- Lower rings of small size.
- Dig into the water table while caissoning.

Drawing see next page.

This method is suitable for very deep wells because it enables us to dig deep and it provides more safety for the technicians. If there are rock layers in between, they can be used as foundation. The method is obviously quite laborious. The diameter of the well below the water table is narrow.

Telescoping can also be used for deepening an already existing well in order to increase its yield, e.g. because the water table has dropped (see also 8.16/4).

Telescoping:

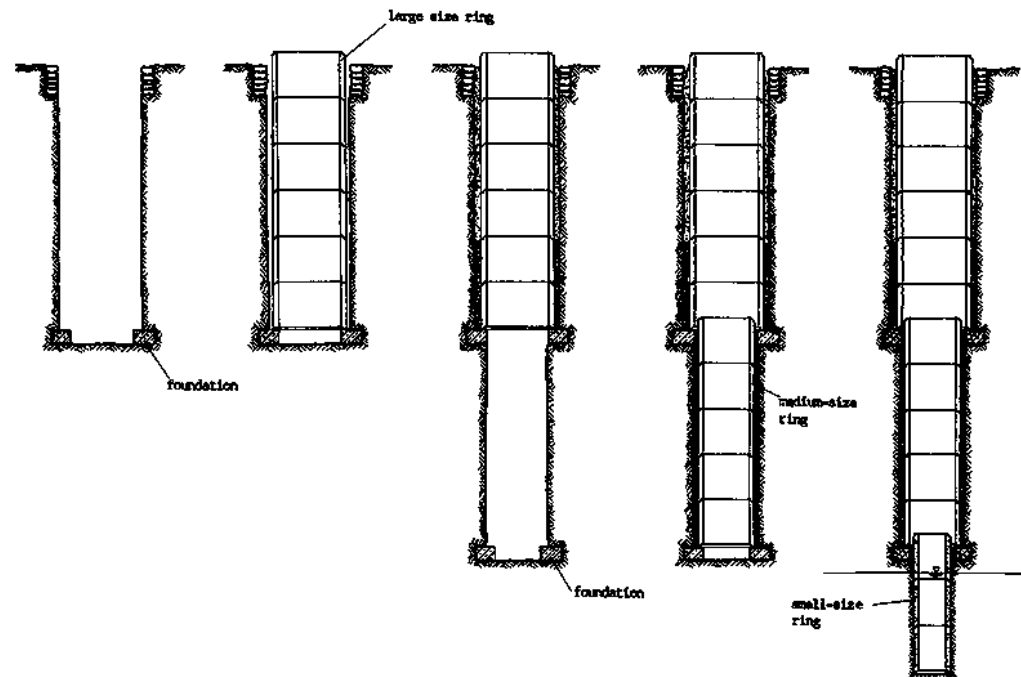

7. Digging and Lining in Sections

For this method, follow these steps:

- Dig one section deep.
- Line the section with brick lining or concrete lining cast in situ (= concrete poured between an inside mould and the well wall).
- Dig the next section (The lining above is held by friction.).
- Line it.
- Continue like this to the well bottom below the water table or dig into the water table by caissoning concrete rings.

Drawing see next page.

This method is suitable in very unstable types of soil (e.g. sand). Sandy soil can be provisionally stabilized by making it wet. The length of a section depends on the type of soil and can vary between 50 cm and several metres. Digging in sections below the water table can be continued if the water inflow into the well is slow and it is easy to keep the well dry during construction. Otherwise, caissoning with concrete rings is advisable. The method is not very handy, but might be necessary under certain circumstances.

For more details see No. 17 in the bibliography.

8. Selecting the Suitable Construction Method

The selection of the suitable lining and construction method depends on

- the soil conditions,
- the depth of the well,
- the materials available,
- the equipment available,
- the skills available,
- the prices.

However, the first two are the really decisive factors. Carefully select the suitable method according to these criteria and the information given above.

Brick Lining in Sections:



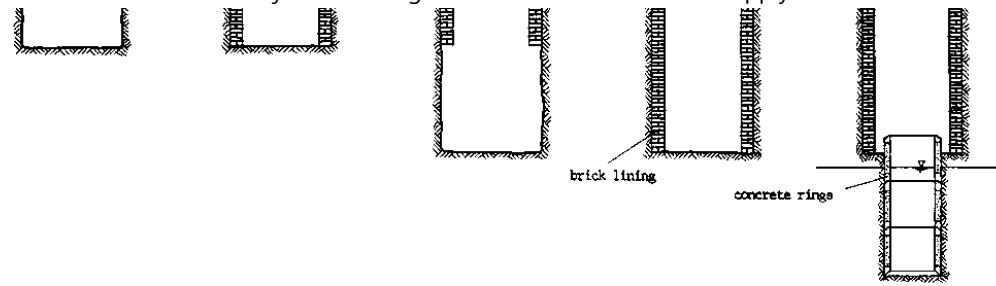

Concrete Lining in Sections

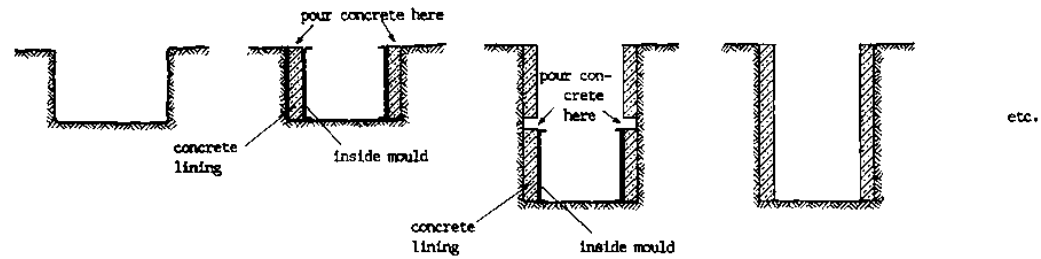

SCALE 1:80

8.15 Well Digging Techniques

A carefully dug well

- is exactly round,
- has the same diameter everywhere,
- has exactly vertical walls.

Careful and exact digging has the following advantages:

1. An exactly vertical and cylindrical well is more stable and is in less danger of collapsing.
2. No unnecessary extra material has to be dug out and pulled out of the well.
3. Lining or lowering concrete rings is easiest if the well is vertical and cylindrical.
4. No unnecessary material has to be backfilled.

A) Digging without Lining

The following techniques will help you to dig a straight well:

1. Keeping the Measurements while Digging

It is advisable to set pegs in concrete in the ground or into the collar before starting digging (see drawing below). Place a piece of timber with two holes on the pegs. Screw a hook into the middle of the timber to mark the well centre. Use two sets of wooden crosses while digging. First, dig roughly according to the short set; then trim the edges exactly according to the long set. Example for big size rings: Short set 1.30 m; long set 1.45 m.

Alternative:

Drive a peg in the centre of the well bottom. Turn a measuring rod around it. Measure the centre from the top with the plumb bob.

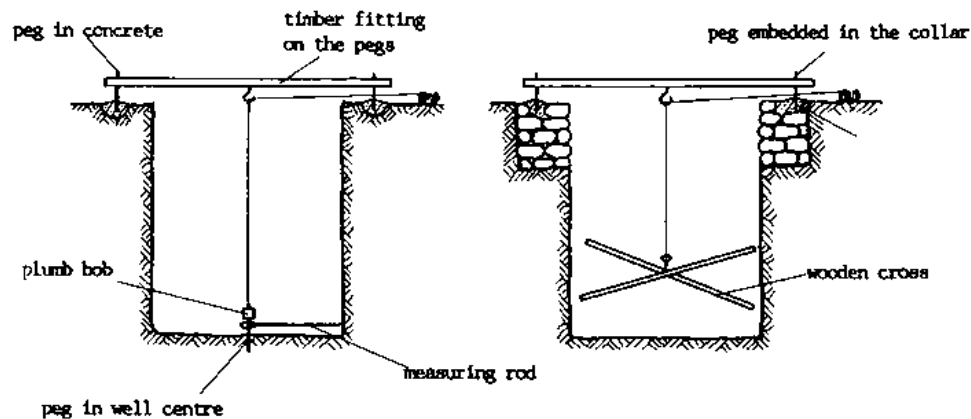

2. Digging the Well Shaft

When digging the well shaft, first roughly excavate a hole about 10 cm smaller than the diameter of the well and about 50 cm deep. In a second step, trim the walls to reach the exact diameter.



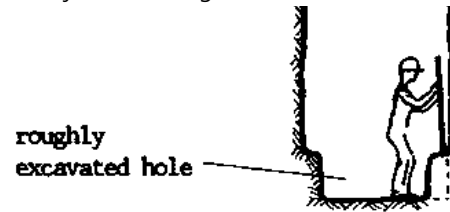

B) Digging with Concrete Rings

Digging inside concrete rings and allowing them to slide downwards during digging is called “sinking a caisson”. It is done according to the following technique:

1. Steps of Digging

First dig a rough hole inside the ring, about 10 cm smaller than the inside diameter of the ring. Dig it about 50 cm below the bottom edge of the ring. This can be done by unskilled labourers.

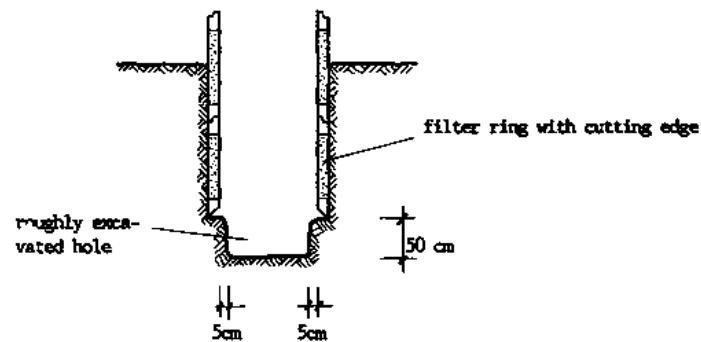

In a second step, cut back in layers all around to the outside diameter of the ring. However, do not start at one point and dig around clockwise, because this would cause the ring to sink askew.

Cut small pieces always opposite to each other in this order:



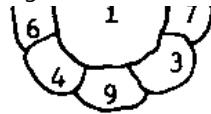

Do not cut much beyond the outside diameter of the ring.

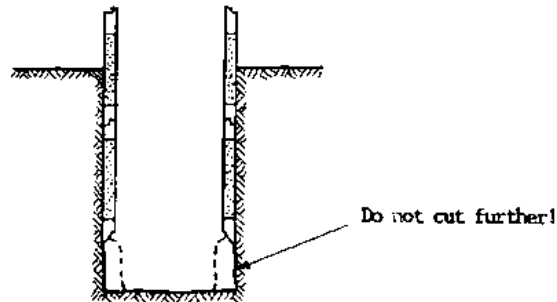

You can also cut like this:

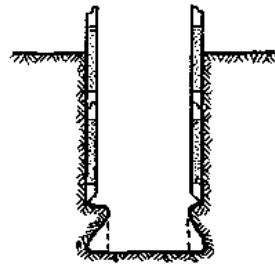

When the weight of the ring is greater than the friction, the ring will slide down the whole section. Before it slides, it announces itself by slight movement or a sound. Pay attention that your feet or hands or a tool are not underneath the edge of the ring.

2. Checking the Position of a Ring

Whether a ring is askew or not can be checked either by checking whether the ring-wall is plumb, or by checking whether the ring-top is level. We select the method according to the circumstances. Plumbing is suitable if the top of the ring is occupied by equipment (like a beam, sling, etc.; see 8.17/22) or if a column of several rings is to be checked. Levelling is suitable whenever the top of the ring is free. For reading spirit level and plumb bob see 6.4/9ff).

When using either method, always look first for the “neutral points” which lay opposite each other. The neutral points are where the spirit level or plumb bob are vertical along the ring wall. A long spirit level laid on top of the ring through the two neutral points is level. Mark the two neutral points with chalk or charcoal or mud. The lowest and the highest points lie in the middle of the two neutral points on opposite sides. A spirit level laid across the top of the ring

through the lowest and the highest points shows the greatest slope.

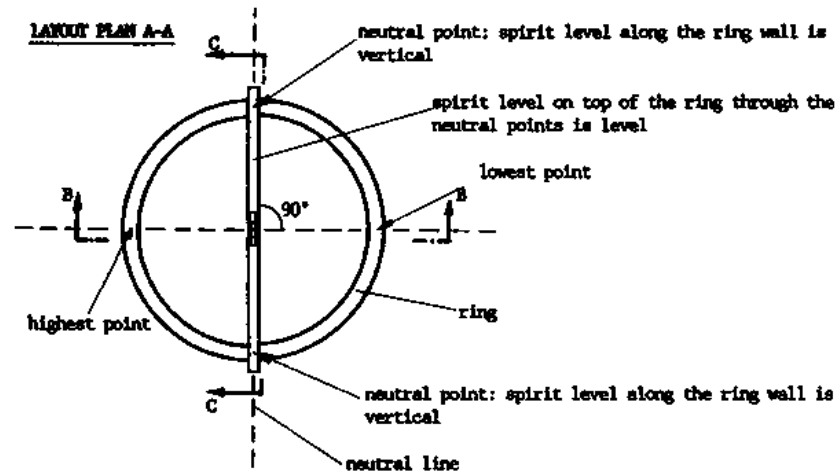

Check the distance d which indicates by how many cm (or "fingers") the spirit level is out of level:

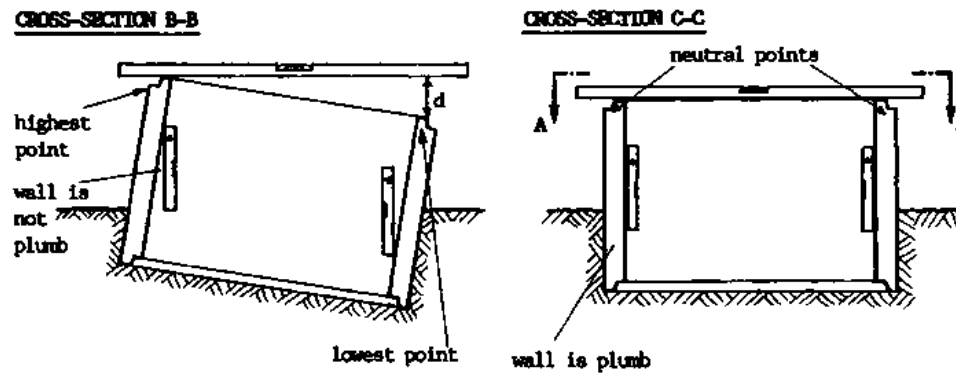

Mark the lowest point with a big arrow:





3. Straightening Askew Rings

When you know where the highest and the lowest points are, remove soil from beneath the lowest point (up to the neutral points). Dig underneath and beyond the outside edge of the ring. Then carefully dig soil away from underneath the highest point, but do not dig further out from the ring than necessary. Such rings can gradually sink again into vertical position. This is the case if the spirit level is vertical all around the ring.

Alternatively, you can check it with the plumb bob.

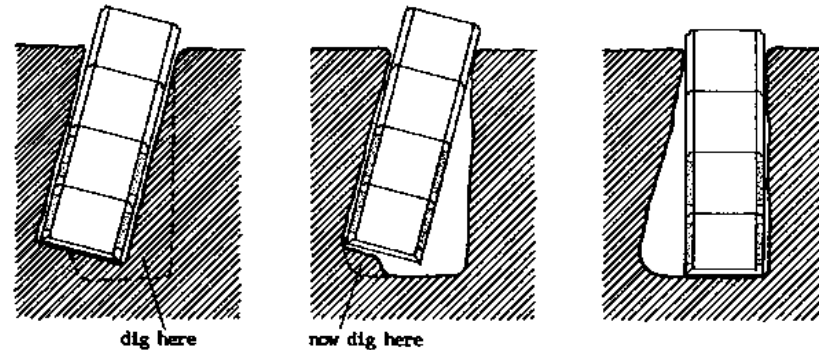

C) Possible Complications during Digging

Different complications can occur while digging a well. Two common ones are described in the following.

1. Rock

The appearance of rock makes digging much more difficult. There are different possibilities how to continue:

- to continue digging with heavy crowbars and drastically reduced speed;
- to leave the site and start new;
- to use more sophisticated methods like a compressor or blasting with dynamite; these need special skills.

2. Quicksand

Water and sand entering the well in great speed is called quicksand. It is very dangerous because it can hold your feet so that you are unable to pull them out. Additionally, it can fill the well quickly or/and cause collapsing of the surrounding area. If you encounter quicksand, leave the well immediately and remove all tools. It might be necessary to leave the site and dig a new well nearby, planned in such a way as to caisson through the sandy layer as quick as possible. Never enter a well with quicksand without safety belt and rope connection to the top.

8.16 Manufacturing Concrete Rings

Lining wells with ready made concrete rings has the following advantages:

1. It is very stable.
2. It protects the diggers while "caissoning" into the groundwater.
3. It is thin and, therefore, requires less excavation.
4. The rings are easily prefabricated outside the well.
5. Finishing the well (i.e. lowering the rings) can be completed within short time.
6. Less cement is needed than for other lining like brick lining or stone lining.

The Disadvantages are:

1. Moulds and other equipment are needed for casting the rings.
2. Special equipment is needed for lowering the rings.
3. Skilled labour is necessary for lowering and caissoning.

A) Types of Concrete Rings

The following three types of concrete rings are needed to construct ordinary wells:

1. Fully Concrete Ring

- rebate on top and in bottom
- to be used in well shaft above water table
- prevents water from entering the well

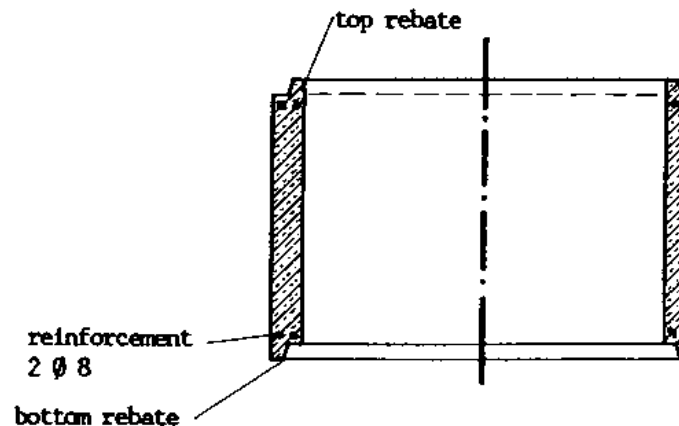

4. Filter Ring

- rebate on top and in bottom
- to be used in well shaft under the water table
- allows water to enter the well

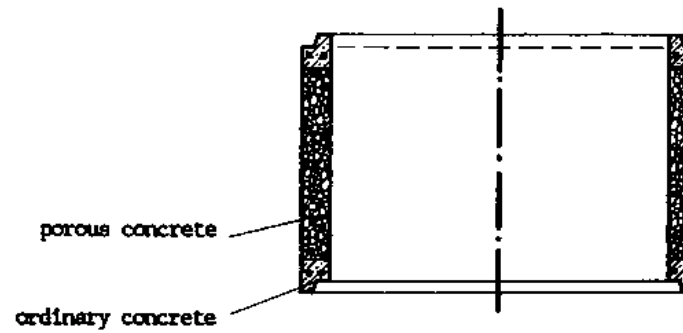
**3. Filter Ring with Cutting Edge**

- rebate on top, cutting edge in bottom
- to be used as the first ring in the well
- allows water to enter the well
- cutting edge makes digging easier

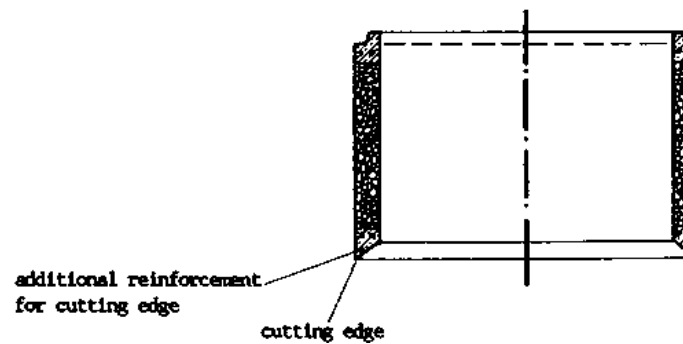
**B) Application of the Different Ring Types**

The different types of rings are to be utilized in a well as follows:

Five different types of rings are to be utilised in a well as follows:

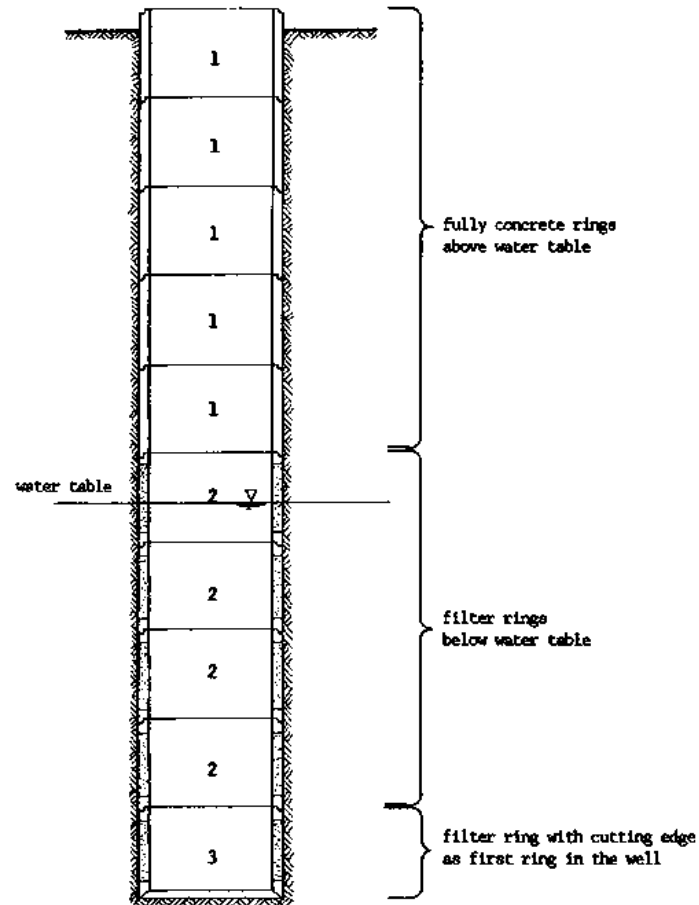

SCALE 1:50

The rings have rebates on the top and in the bottom edges. A rebate is a step-shaped channel along the edge of the ring to receive the corresponding edge of another ring. On the top edge of the ring, the channel is outside. This corresponds to the bottom edge of another ring where the channel lies inside.

The rings have to be stacked on top of each other in such a way that no surface water can enter the well through the rebates. They have to slope outwards. The moulds described in D) produce rings which can only be stacked in the correct way if the first ring in the well is one with a cutting edge.

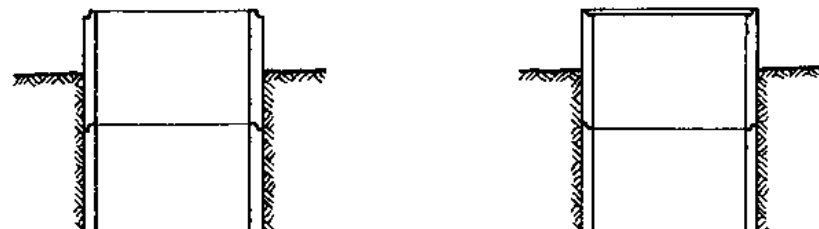

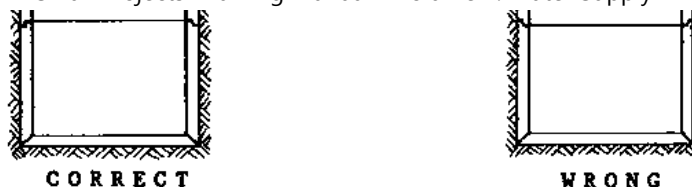

The filter rings below the water table are just stacked on top of each other without mortar. The rebates provide the connection. The fully concrete rings above the water table are connected with cement mortar to make a watertight joint.

C) Sizes of Concrete Rings

It is advisable in a project to have moulds of different sizes for different purposes. The dimensions should be chosen in such a way that the next smaller ring can be used inside a previous ring when deepening the well becomes necessary later on. This is called “telescoping” (see also 8.14/7f).

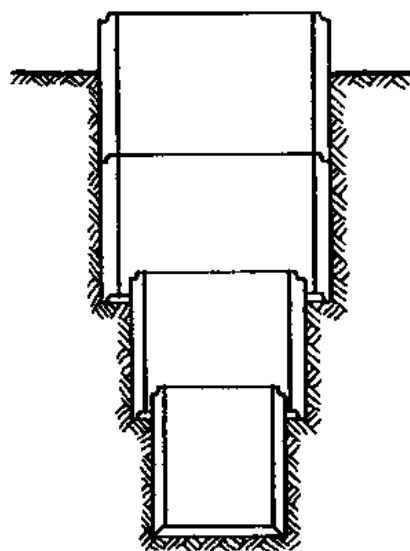

SCALE 1:50

The advisable height of the concrete rings depends on the equipment available for lowering them into the well. Rings 50-60 cm high are light and, therefore, can be lowered with light weight equipment. Small rings also cause fewer problems during transportation if manufactured in a central workshop. But they require more reinforcement. The work progress during lowering is slower and more joints need to be constructed. For very deep wells small rings are not advisable.

Concrete rings 90-100 cm high are heavy and require strong, more expensive and heavier lowering equipment. If this equipment is available, high concrete rings are preferable, because of the easy manufacturing process and quicker work progress during lowering. If rings are to be manufactured on site, this height is advantageous. Rings higher than 100 cm are not advisable at all.

The thickness of the wall of a concrete ring should be between 6 and 10 cm, depending on the diameter of the ring. A wall thinner than 6 cm cannot

The thickness of the wall of a concrete ring should be between 6 and 10 cm, depending on the diameter of the ring. A wall thinner than 6 cm cannot accommodate the reinforcement properly and will break easily; a wall thicker than 10 cm makes the ring too heavy without adding to the strength accordingly and is, therefore, a waste of material.

The following sizes for concrete rings are suggested for a water project:

(All rings are 0.92 cm high.)

1. Large Size:

- big water reservoir can store large quantities of water
- more digging is necessary
- 2 or 3 people can dig in the ring at the same time
- it is suitable in soft soil and if the water table is not too deep

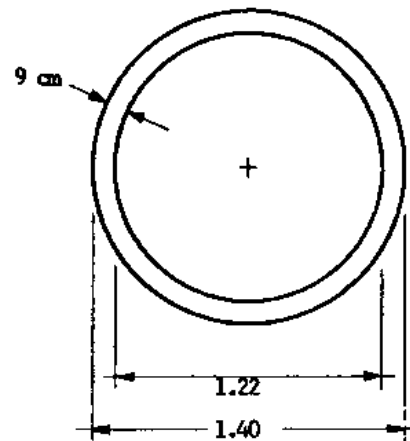

2. Medium Size:

- a moderate water reservoir
- less digging is necessary
- 1 to 2 people can dig in the ring at the same time
- usually used
- suitable also in deep wells and in rock
- suitable for telescoping within a large ring

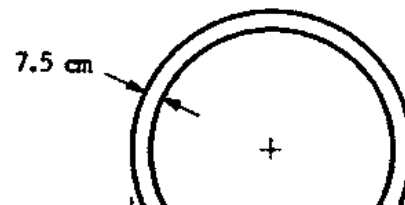

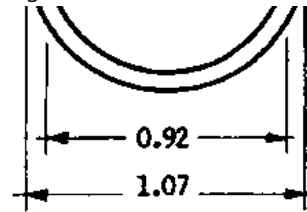

3. Small Size:

- small water reservoir
- little digging is necessary, but digging is difficult due to little space
- only one person can dig in the ring
- suitable only in special cases
- suitable for telescoping within a middle size ring

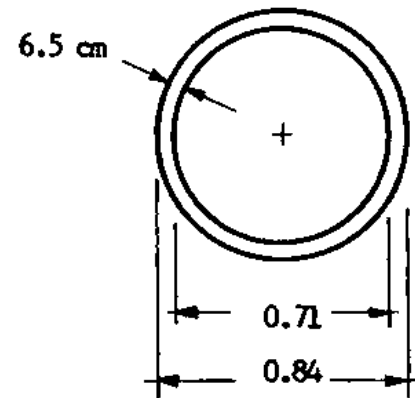

SCALE 1:30

D) Pipe Moulds

Pipe moulds are steel forms for casting concrete rings. They are very durable, can last for a long time, and produce rings which always have the same size and shape. However, they need to be handled with great care.

Pipe moulds consist of the following parts:

1. Inner Mould (with two pieces and wedge)

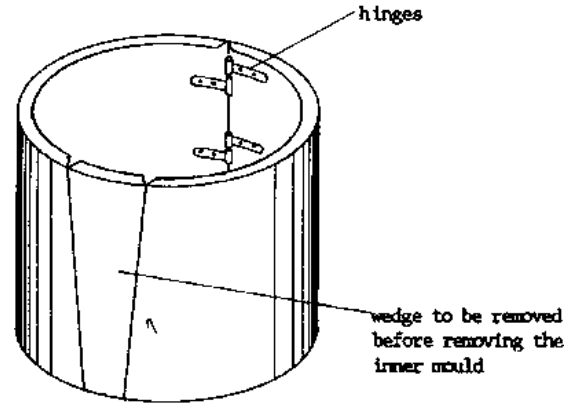

Inner mould without wedge:

LAYOUT PLAN:

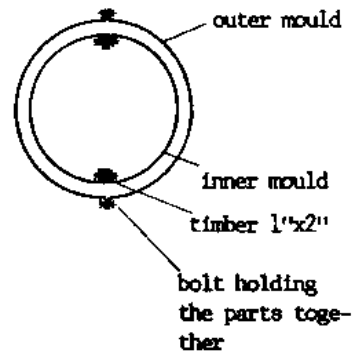

If the inner mould has no wedge, but consists of two pieces similar to the outer mould, you must place a piece of timber 1"×2" in between the parts of the inner moulds. Otherwise, you will not be able to remove the inner mould after casting the ring without breakage.

2. Outer Mould (two pieces)

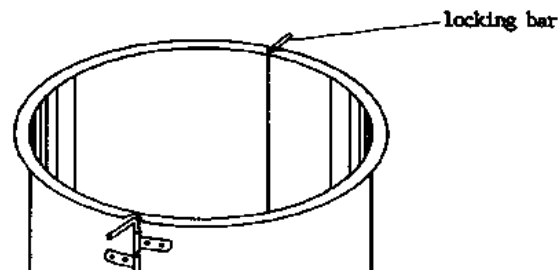

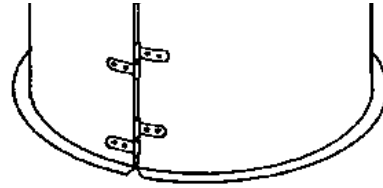

design: Hartz & Bell, Nairobi

SCALE 1:25

3. Base Plate for Rebate

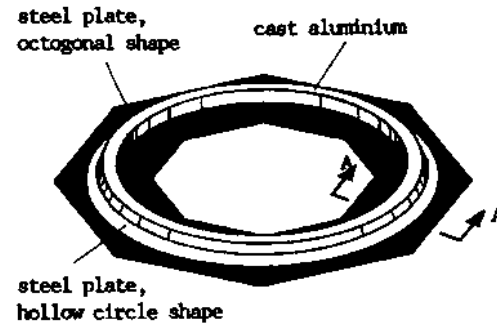

Cross-section A-A
through
base plate

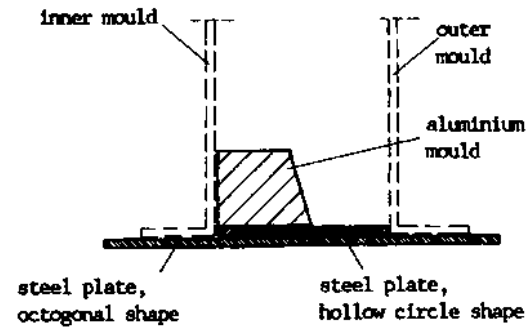

4. Base Plate for Cutting Edge

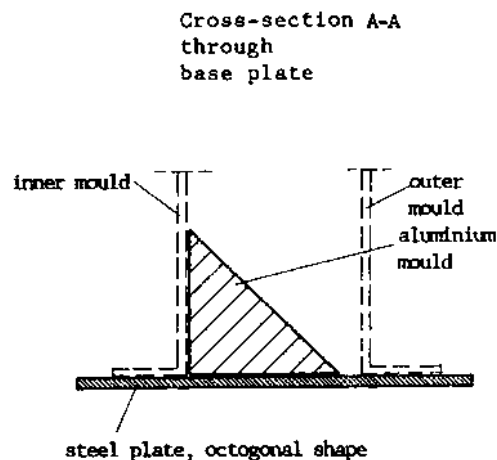
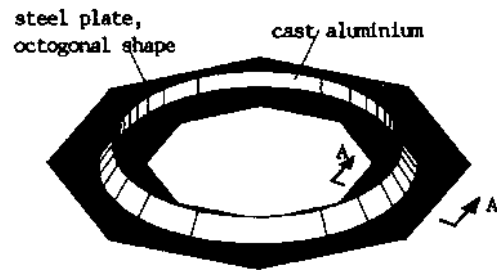

5. Cutting Cross (for cutting rebate on the top of the ring)

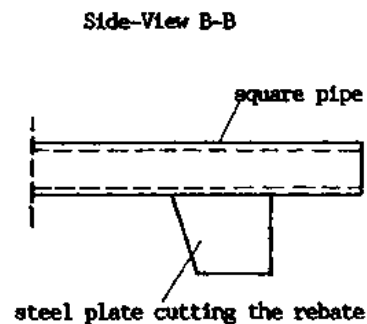
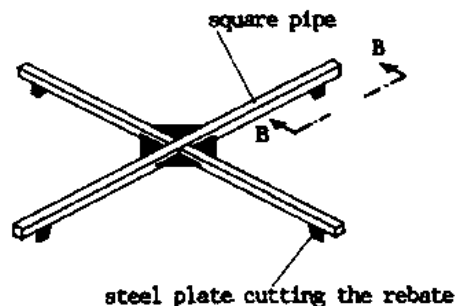

E) Casting Concrete Rings

Manufacture concrete rings according to the following steps:

No.	Step	Reasons
1	Load and unload the moulds very care fully. Avoid dropping them and bending them out of shape.	Out-of-shape moulds produce rings which are not round. They do not fit into each other when lowered into the well.
2	Place the base plate on level, clean ground.	This ensures easy compaction and minimizes movement.

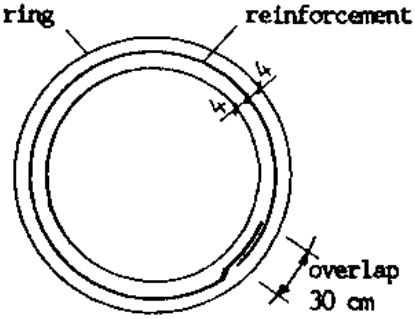
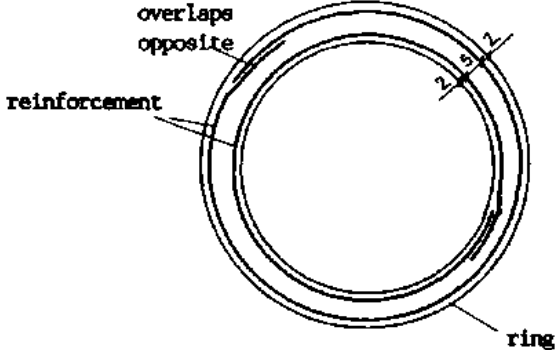
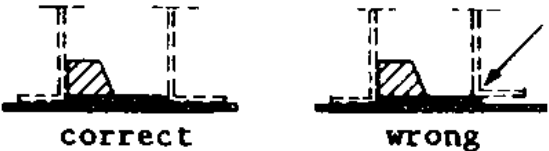
3	<p>Place the inner mould inside the base plate. Check if the wedge can be pulled out easily; otherwise, clean and grease it. Check if the mould can be easily hinged inwards.</p>	<p>After concrete is cast, the moulds are much more difficult to move.</p>
4	<p>Bend the reinforcement around the mould; cut it and tie it using the appropriate diameter:</p>	<p>The reinforcement should never touch the moulds but be well covered by concrete from all sides. Concrete prevents steel from corroding. See 6.6/8ff.</p>
	<p>One reinforcement in one layer for rings Ø 1.07 m:</p> 	<p>Two reinforcements in one layer for rings Ø 1.40 m:</p> 
5	<p>Take the reinforcement out.</p>	<p>It will be needed later on.</p>
6	<p>Paint the base plate, the inner mould (outside), and the outer mould (inside) with <u>old</u> engine oil.</p>	<p>Engine oil prevents the concrete from sticking to the steel mould (like oil when baking bread).</p>
7	<p>Place the outer moulds and connect them with locking bars. Check if the mould is in correct position all around.</p> 	<p>The correct position on the base plate assures that the mould is really in a round shape. It should not sit on the hollow circle shaped steel plate.</p>
8	<p>Place the cutting cross on the mould and check if you can easily turn it.</p>	<p>The round shape of the mould can be checked with the cutting</p>

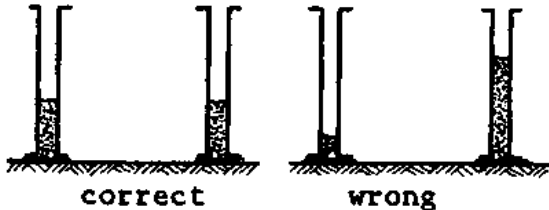
		cross.
9	Wash the gravel if necessary.	Soil particles make the concrete weaker. See 6.6/7.
10 11	Sieve the gravel if necessary. Mix the concrete thoroughly. For mixtures see F). Mix cement and sand dry. Then add water and mix thoroughly. Add as little water as possible. Add gravel, and mix thoroughly. The water content is correct if the concrete is just workable for pouring and compacting. The concrete should look dry. If compacted a little, water needs to appear on the surface.	The biggest parts shall not exceed 20 mm diameter. Only a well mixed concrete is strong. The cement needs to be evenly distributed inside the concrete. The concrete is weaker if there is too much water in it. See 6.6/7
12	Pour a little concrete into the mould evenly all around. Compact it with wooden stampers.  <p style="text-align: center;">correct wrong</p>	This ensures that the concrete is compacted evenly. All air bubbles need to be removed, because they make the concrete weaker.
13	Fill to about 10 cm high all around. Place the reinforcement. Take care that the reinforcement does not touch the moulds.	The top and bottom reinforcement prevent the rings from breaking.
14	Fill the mould, layer by layer, and compact each layer.	The ring must be well compacted throughout for high strength.
15	When the mould is filled 80 cm high, place the reinforcement.	see No. 13
16	Fill the rest of the mould. Compact it well. Cut the top rebate with the cutting cross. Remove the surplus concrete.	The top and bottom rebates are corresponding and ensure a strong connection between the rings.
17	Fill in some cement mortar 1:4. Cut again with the cutting cross.	The rebate becomes smoother if cement mortar is used.
18	Write the date into the fresh concrete.	If the date is recorded, you know if the ring is hard enough for lowering. See 6.6/6f
19	Wash away all concrete spilled outside on the moulds.	Otherwise the concrete will get hard on the mould. It will be difficult to clean it later. Old concrete makes the mould heavier.
20	Cover the mould.	Fresh concrete becomes stronger if kept wet (= cured).
21	Remove the moulds (without the base plate) 3 hours after casting at the earliest. Lift the wedge of the inner mould. Hinge the inner mould inwards and carefully remove it. Open the outer moulds and remove them. Clean the moulds immediately.	Take care not to damage the fresh concrete. The outer mould still protects the ring when removing the inner mould first. The concrete is of good quality if the surface is smooth without air

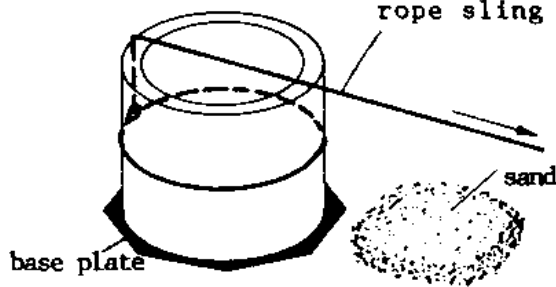
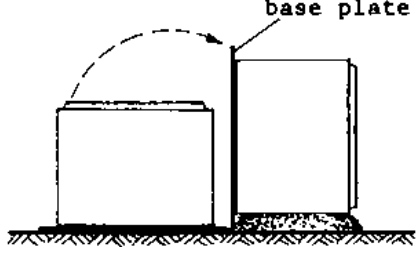
		bubbles. It is easier to clean the moulds immediately when they are still wet.
22	Cover the ring with wet sackcloth and nylon (or wet grass). Or water it continuously. Keep it wet for at least 3 days, better for 7 days.	Curing the concrete by keeping it wet prevents cracks and makes it strong.
23	Remove the base plate after 2 days (48 hours) at the earliest. Place a "cushion" of sand beside the ring. Pull the ring over on its side by a sling. Remove the base plate. Clean it. Let the ring down again. Cover the ring again.	If 48 hours have not yet passed, the rebate is not hard enough and could easily be damaged. If you pull over the ring before time, it would crack or break.
		
24	After three to four weeks the rings are hard enough to be lowered into a well.	To lower them before is a danger to the workers and can cause heavy losses of time and material. See 6.6/6f.

F) Mixtures and Reinforcement

Use a strong mixture of 1:3:4 for fully concrete rings to compensate for ingredients of variable quality and mistakes in work. Even if cement is very expensive, the safety of the workers is much more important than minimizing cement costs. Breaking of rings at any stage (during moving, lowering or digging) can easily cause bad injuries.

The same mixture 1:3:4 is used for the bottom and the top of filter rings. Together with the reinforcement this gives strength to the filter ring. In spite of that, the filter ring is weaker than the fully concrete ring and, therefore, needs to be handled with even more care. The filter part consists of a mixture 1:0:4 (one part cement, no sand, four parts gravel). The voids between the gravel make the concrete porous and allow the water to enter through the filter ring. Alternatively, a mixture of 1:1:4 could be used. When mixing concrete for the filter part, mix the cement with water first and add the gravel afterwards.

For medium size rings, 2 reinforcement rods, 0 8 mm, all around the ring, one in the bottom, one on the top, are sufficient, both for fully concrete and for filter rings. Add another ring of reinforcement in the cutting edge.

If reinforcement is not available, it can be substituted by one layer of chicken wire all around the ring. This is only possible for fully concrete rings; it also makes compacting more difficult.

To substitute the reinforcement by welded mesh all around the ring is very expensive. Alternatively, you can cut 2 stripes of welded mesh:



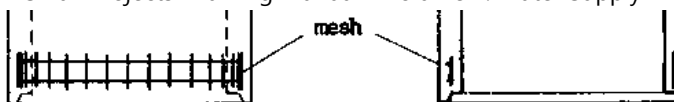

Middle size rings might also be manufactured without any reinforcement at all (only fully concrete rings!), although it is not advisable. In that case, the mixture must be stronger, the curing must be continuous for seven days, and rolling the ring is very delicate. Casting rings without reinforcement should only happen in emergencies. You run the great risk of losing the whole cement through breakage of the ring.

For large size rings, 4 reinforcement rods, Ø 8 mm, are necessary, 2 in the top, 2 in the bottom. Add another reinforcement in the cutting edge. The reinforcement can be substituted by 2 layers of chicken wire or 1 layer of welded mesh all around the ring. Large size rings cannot be manufactured without reinforcement.

The above instructions are valid only for rings which are to be turned over, rolled and lowered into a well. Rings cast in situ (on the site), for example for water tanks, which are never to be moved, can be cast without reinforcement. See also 6.6/10.

On the other hand, rings to be used as culverts (= channel carrying water under a road) need much stronger reinforcement. They have to bear the load of cars and lorries driving over them. The reinforcement depends on the type of cars using that road and the thickness of soil between the culvert and the road. The reinforcement must be at least one layer of welded mesh, but could be as much as 1 reinforcement Ø 10 mm every 10 cm. See also 6.6/10.

Mixtures, approximate quantities and reinforcement for well rings are compiled in the following table:

Ring Size	Type of Ring		Mixture	Cement Buckets	Sand Buckets	Gravel Buckets	Reinforcement Rings
Ø 1.40	fully concrete ring		1:3:4	5	15	20	4 Ø 8
	filter ring,	top and bottom	1:3:4	1	3	4	4 Ø 8
		filter part	1:0:4	5	0	20	--
	filter ring with cutting edge	top and bottom	1:3:4	1	3	4	5 Ø 8
		filter part	1:0:4	5	0	20	--
Ø 1.07	fully concrete ring		1:3:4	3	9	12	2 Ø 8
	filter ring	top and bottom	1:3:4	$\frac{1}{2}$	$1\frac{1}{2}$	2	2 Ø 8
		filter part	1:0:4	3	0	12	--
	filter ring with cutting edge	top and bottom	1:3:4	$\frac{1}{2}$	$1\frac{1}{2}$	2	3 Ø 8
		filter part	1:0:4	3	0	12	--

1 bucket is about 10 lit. 1 bag of cement is about 54 buckets.

8.17 Lowering Concrete Rings into a Well

Concrete rings are heavy; the middle size weighs about 540 kg, the large size weighs about 940 kg. Lowering them into a well is a delicate work and requires skilled technicians and reliable equipment. See also 5.7.

A) Methods of Holding a Concrete Ring

Concrete rings can be held for lifting and lowering by different methods:

1. Tying the Ring with Rope

Step-by-step procedures:

- Sling a rope underneath the ring and tie it around the ring walls.
- Do this on 3 or 4 spots around the ring.
- Lift the ring.

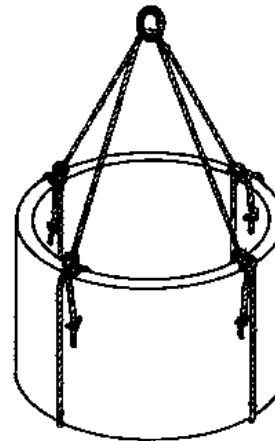

Advantages:

- Nothing else other than rope is needed.

Disadvantages:

- The method is not very handy.

- The ropes wear out very quickly.
- The ropes are difficult to remove once the ring is placed on top of another ring.
- It is not easy to balance the rings horizontally.

2. Tying to Hooks in the Ring

Step-by-step procedures:

- Tie 3 or 4 hooks made from steel \varnothing 10 mm to the reinforcement before pouring the concrete into the ring moulds.
- Cast the hooks into the concrete.
- When you want to lower the rings into a well, tie ropes to the hooks.
- Lift the ring.

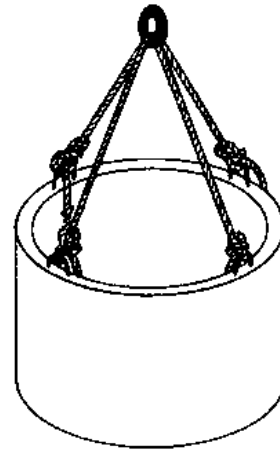

Advantages:

- The connection is strong.

Disadvantages:

- Extra work is needed when casting the rings.
- Rebates are not possible.
- The next following ring will not sit properly on the previous one because of the hooks. More mortar is necessary.
- If the hooks are to be bent inwards after lowering, the concrete can break easily.

If the hooks are to be bent inward after lowering, the concrete can break easily.

3. Holding by Steel Hooks

Step-by-step procedures:

- Manufacture three steel hooks from reinforcement $\text{Ø } 20 \text{ mm}$.

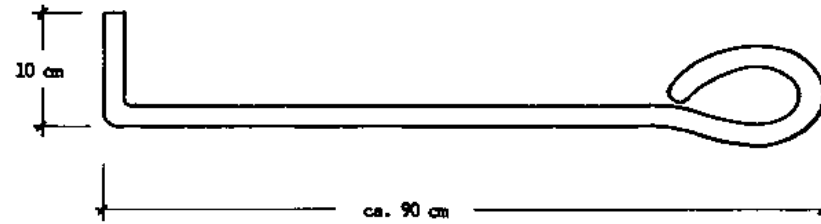

- Grasp the bottom edge of the ring with the three hooks.
- Tie the eyes of the hooks together and lift them at a go.

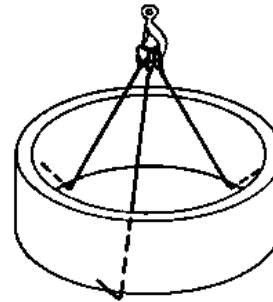

Advantages:

- The equipment is simple and can be manufactured locally.
- The method is relatively handy.
- Little space is needed outside the ring.
- No hooks have to be cast into the concrete.

Disadvantages:

- The method is only suitable for small, light weight rings (up to $\text{Ø } 1.10 \text{ m}$ and 60 cm height).

- It is difficult to balance the ring during lowering.
- The bottom rebates can be easily damaged by the hooks.
- It is difficult to get the hooks out, once the ring is placed on top of another.
- There is little working space for the technician on top of the ring.

4. Holding by Steel Cable

Step-by-step procedures:

- Prepare a strong hook from double flat iron, 60 x 8 mm, (or from car springs) by blacksmithing and welding.

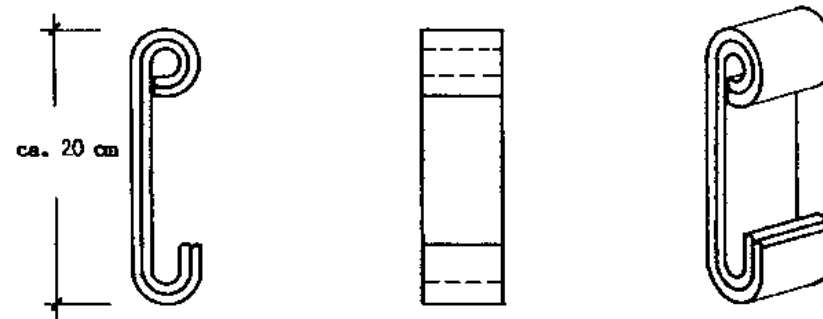

- Prepare a steel cable with an “eye” on one end and the hook from flat iron on the other as follows:

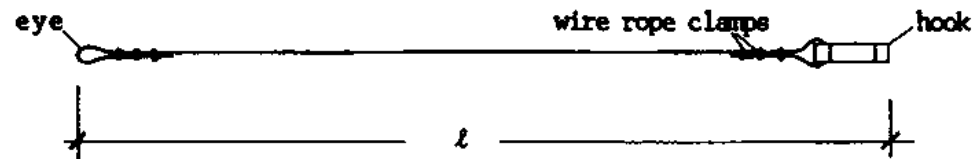

The total length (including the hook and the eye) should be about

$$\ell = h + \pi \times D + 1.41 \times D = h + 4.55 \times D$$

h = height of concrete ring
 D = diameter of concrete ring
 $\pi = 3.14$

Cut the steel cable. Weld its ends by gas welding to prevent splitting and injury to people. Fix the hook and the eye, each with two wire rope clamps.

- Prepare a piece of timber 2" x 4". The length should be:

$$l = D + 3 \text{ cm}$$

Cut a slight groove into its ends and reinforce it with iron band as shown:

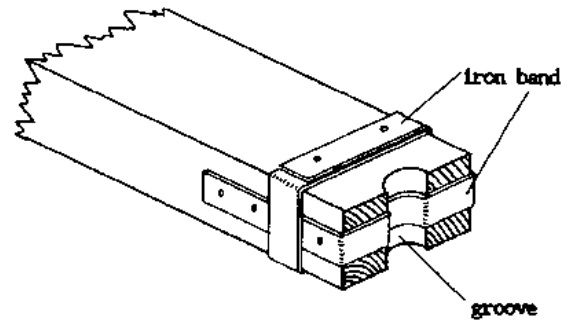

- Once the steel cable and the piece of timber (= "beam") are made, they can be used many times.

- Fix the steel cable with the beam around the ring like this:

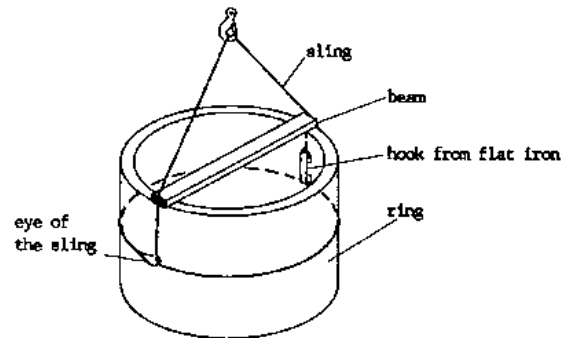

The beam prevents the cable from cutting and damaging the concrete. The cable should be at the middle of the ring or below.

- Lift the ring with a swivel-hook. The sling is able to lift the heavy concrete ring through friction between cable and concrete.

- If not balanced, put down the ring again and move the swivel-hook accordingly until the ring is balanced.

Advantages:

- The equipment can be produced locally.
- No hooks have to be cast into the concrete.
- Any type of ring can be lifted, with or without rebates.
- The ring is held in the middle and all around.
- The method is very handy, quick and safe.

- The rings are easily balanced and directed during lowering.
- Only little space is occupied outside the ring.
- There is nothing underneath the ring; the ring can be placed directly on top of another ring.
- There is enough working space for the technician on top of the ring.
- The equipment is long lasting.

Disadvantages:

- Steel cable and iron hook are needed.

(In emergency cases triple rope can be used instead of steel cable.)

5. Holding by Self-Locking Lifting Clamps

Special lifting clamps are industrially available for lifting concrete rings. They consist of three clamps attached to chains. When pulling the chains, the clamps automatically tighten and hold the ring by friction. They are “self-locking” when pulled.

Step-by-step procedures:

- Place the three clamps on the ring at equal distances.
- Lift the ring by the chain.

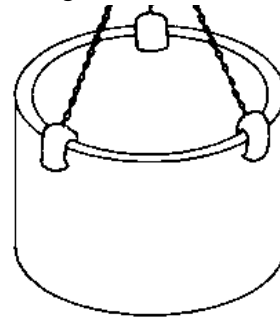

**Advantages:**

- The method is very handy and quick.
- Any type of ring can be lifted.
- The rings are easily balanced.
- There is nothing underneath the ring.

Disadvantages:

- The special lifting device is not easily available and cannot be produced locally.
- The clamps require space outside the ring.
- The ring is held only on three small spots; if the concrete is of weak quality, it can break and the method is not safe.
- There is little working space for the technician on top of the ring.

6. Selecting the Suitable Method

The selection of the suitable method depends on the circumstances and the equipment available. whenever possible it is advisable to use method No. 4.

B) Methods of Lowering a Concrete Ring into a Well

Concrete rings can be lowered into a well by different methods:

1. Lowering with Local Equipment

The equipment necessary for this method should be available locally and/or within the country.

Step-by-step procedures: see also drawing 6.17/9

- Erect 4 strong Y-shaped poles (“shebas”) around the well and fix them in concrete.

- Lay 2 strong metal pipes, $\text{Ø } 2\frac{1}{2}$, or strong poles, across them and tie them to the shebas.

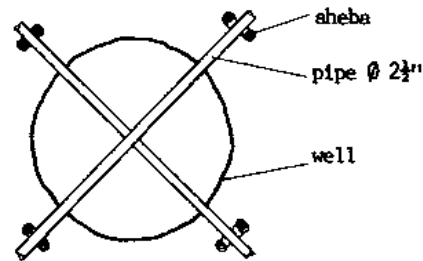

- Lay three strong, long poles, or pipes $\text{Ø } 2\frac{1}{2}$, across the mouth of the well.

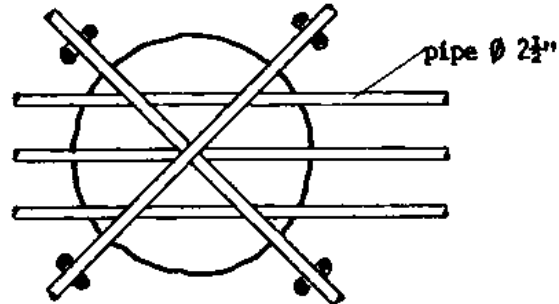

- Place the ring on top of these poles or pipes outside the well mouth.

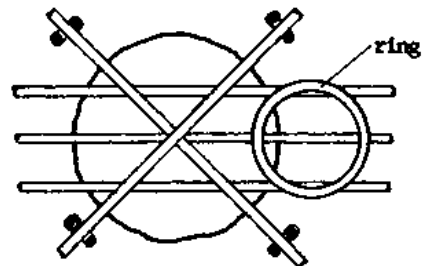

- Tie four pulleys on the crossing pipes.
- Pull four long sisal ropes $\text{Ø } 25$ mm through the four pulleys.
- Tie the ring with the four ropes by method 1 or 2 as described under A).
- Let about 8 to 10 people pull at each rope.



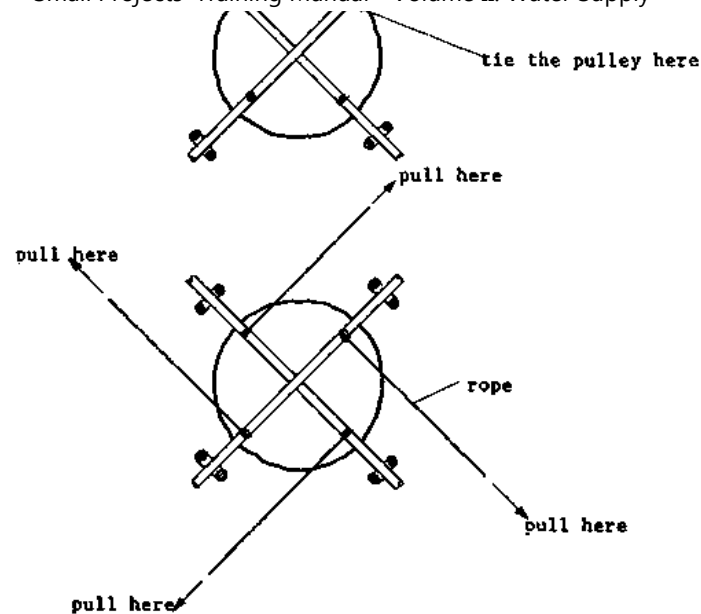

- Lift the ring and let it slide into the middle above the well.
- Remove the poles from underneath.
- Lower the ring into the well.

Advantages:

- No sophisticated equipment is necessary; most of it is available in the village. Pulleys, pipes, ropes should be available within the country.

Disadvantages:

- Very much rope of good quality is required. The rope wears out quickly during lowering. New ropes are required for each well which is very costly.
- Many people (about 40) are needed for lowering rings. It is difficult to get the required number of people (adults!) continuously for the necessary period of time and it is also difficult to coordinate such a number of people. Some will be redundant in between while the technicians work in the well.
- Precise lowering and balancing of the ring is difficult with this method.
- Rings cannot be lowered deeper than 15 m by this method.

Lowering a Concrete Ring with Local Equipment

ISOMETRIC VIEW

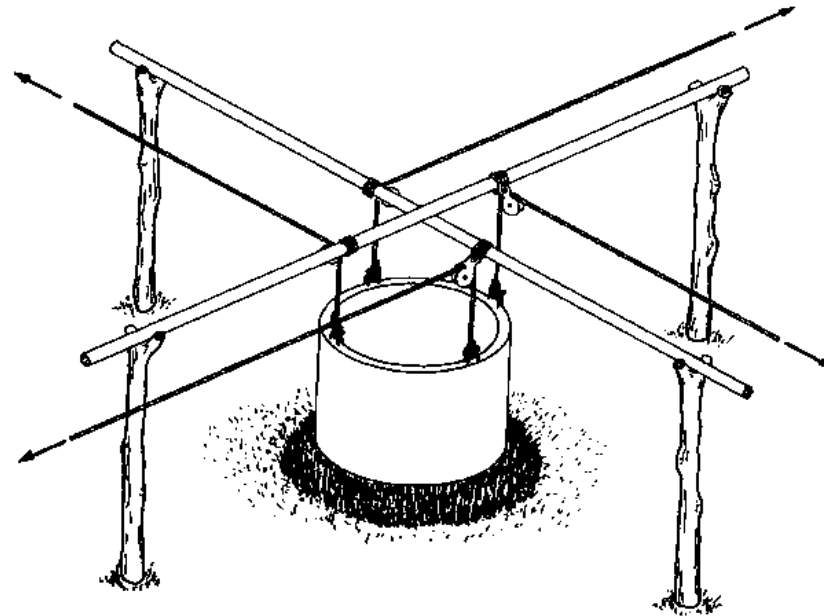

2. Lowering with Light Weight Tripod and Pulleys

Only light concrete rings (maximum \varnothing 1.10 m, height 60 cm) can be lowered with a light weight tripod consisting of three metal pipes, \varnothing 2", 3 m long, connected with a steel cable. The weight of the ring is lifted by a tackle.

Tackles

A tackle (= "block and tackle" or "pulley system") is an assemblage of ropes, pulleys, and hooks to lift weights, arranged to gain mechanical advantage for hoisting and pulling. For tackles, four different parameters (= features, characteristics) are to be considered:

l = lift or distance the item has to be lifted:

d = distance the rope is to be pulled to gain the lift (ℓ);
W = weight of the item to be lifted;
F = force needed to pull the rope in order to lift the weight

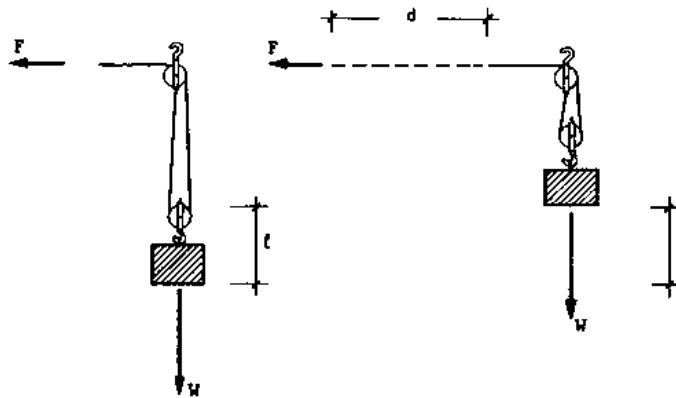

They are connected as follows:

If the distance you pull the rope (d) is a multiple of the lift (ℓ) by the factor (a), then you need to pull with a force (F) which is the weight (W) divided by the same factor (a):

$$d = \ell \times a$$

$$F = W \times \frac{1}{a} = W \div a$$

Check how many rope connections there are between the two pulley blocks. This number is the factor (a), because each rope connection has to be shortened by the lift (ℓ).

Applied to the three most simple tackles, this means:

One Pulley Block

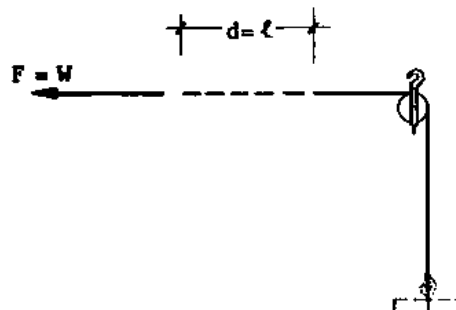

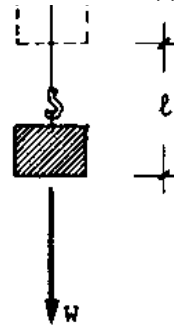

$d = l$
 $F = W$

You pull the same distance as you lift an item.
 You pull with a force as big as the weight of the item.
 No mechanical advantage.

Two Single Pulley Blocks

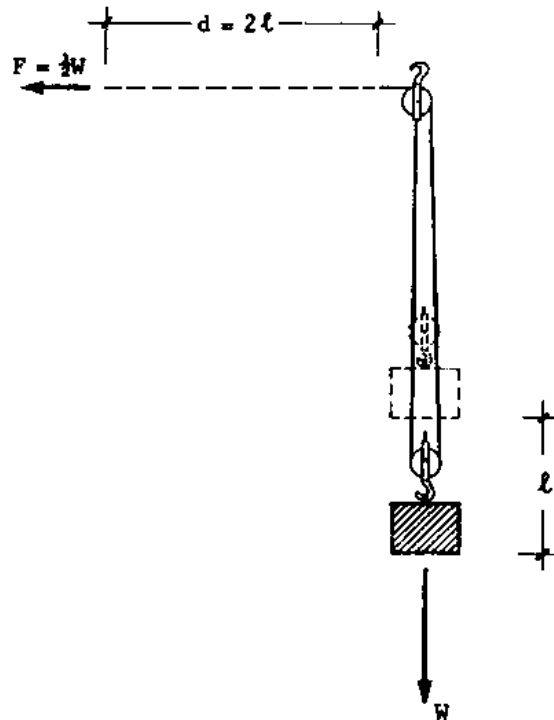

$d = 2 \times l$

$$F = \frac{1}{2} \times W$$

There are 2 rope connections between the two pulley blocks.
 You pull twice as long as you lift the item.
 You pull with a force half of the weight of the item.

Two Double Pulley Blocks

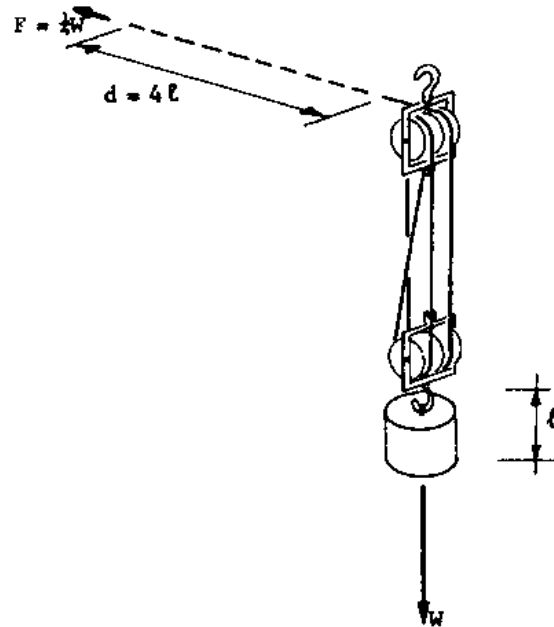

$$d = 4 \times l$$

$$F = \frac{1}{4} \times W$$

There are 4 rope connections between the two pulley blocks.
 You pull four times as long as you lift the item.
 You pull with a force a quarter of the weight of the item.

Use this information for calculating the length of rope needed and the number of people requested for a certain task.

Example:

A 400 kg heavy ring should be lowered into a 6 m deep well by a tackle with 2 double pulley blocks.

factor of the tackle	$a = 4$
distance between ground level and pulley	2 m
lift + distance to head of tripod	$\ell = 6 \text{ m} + 2 \text{ m} = 8 \text{ m}$
length of ropes in the tackle	$p = 4 \times 8 = 32 \text{ m}$
extra rope from pulley to people	10 m
length of rope required	$L = 32 \text{ m} + 10 \text{ m} = \underline{42 \text{ m}}$
weight	$W = 400 \text{ kg}$
force for pulling rope	$F = \frac{1}{4} \times 400 \text{ kg} = 100 \text{ kg}$
approximate pulling capacity of one person	25 kg
number of people required	$\frac{100 \text{ kg}}{25 \text{ kg}} = 4 \text{ people}$

Note:

The lift of a tackle is not unlimited! Beyond a certain length, the item lifted tends to turn along its axis, thus twisting the ropes of the tackle around each other. This danger is even greater if the rope is new. Once the ropes are twisted, it is hardly possible to unwind them and they might even break.

Step-by-Step Procedures for using light weight equipment:

- Place the tripod over the well. All three legs must be in equal distance from each other:

$$a = b = c$$

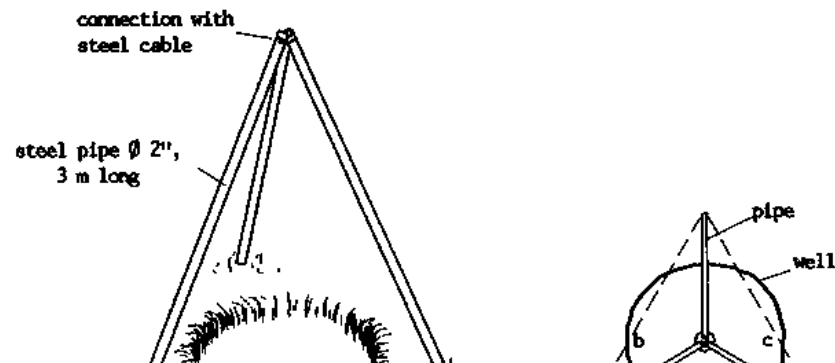

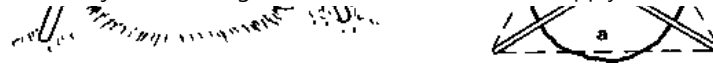

Check with a measuring tape.

- Fix a tackle with two double pulleys on the tripod.
- Connect the rope with the ring with method 1, 2, 3 or 4 of A (see 8.17/1ff).
- Lift the ring and pull it to the centre of the well mouth.
- Lower the ring.

Advantages:

- The equipment is very simple and can be manufactured locally.
- The equipment can be transported from site to site easily.
- The equipment can be erected quickly and with few people.
- The method is handy.

Disadvantages:

- The method can lift only light weight rings.
- This method can be used only for wells up to about 15 to 20 m deep. Below this, there is great danger of twisting the tackle cables.
- The method cannot be used if the mouth of a well is completely washed out (because such a small tripod cannot span a big opening).
- Very long rope is required.
- The rope wears out quickly.

3. Lowering with Heavy Duty Tripod and Winch

Concrete rings can also be lowered with a heavy duty tripod and a hand operated winch with steel cable. The equipment is described in detail under C (see 8.17/15ff).

Step-by-step procedures

see under D (see 8.17/20ff).

Advantages

- Any type of ring, even large ones, can be lowered.
- Rings can be lowered into wells up to 50 m deep.

- The method can be used even if the mouth of a well is completely washed out and wide.
- The method is very handy, quick and precise.
- It is easy to direct the rings inside the well.
- The number of people required is only about 10.
- The steel cable is durable and will not wear out quickly.
- The method is safer than methods 1 and 2.
- Part of the equipment can be manufactured locally.

Disadvantages

- A pick-up with roof-carrier is needed for transporting the equipment.
- Erecting the tripod and fixing the winch is rather time consuming and requires about 10 people.
- It is costly and difficult to purchase the equipment.
- If even only one part of the equipment does not function, the method cannot be used.

4. Selecting the Suitable Method

The selection of the suitable method depends on the number of wells to be constructed, the average depth, the size of the rings and the availability of equipment. Whenever several wells are to be constructed, a permanent tripod from metal pipes is advisable (method 2 or 3).

Method 2 is suitable in an area with shallow wells (up to 20 m) and with good roads. In that case, small rings can be manufactured in a central workshop, transported to the site and lowered there with light weight equipment.

In an area with bad roads, central manufacturing of rings is not suitable-Large rings can be produced on site and lowered by method 3. For deep wells beyond 20 m and rehabilitation of wells which have been washed out very much on top, only method 3 is possible. This method is suitable for most conditions and is advisable if the size of the project and the financial possibilities allow; it is described in more detail under C and D.

C) Heavy Duty Equipment for Lowering Rings

Heavy duty equipment for lowering concrete rings into a well consists of the following elements:

1. Tripod

A heavy duty tripod consists of the following elements:

- 2 single legs, $\text{Ø } 2 \frac{1}{2}$ " or $\text{Ø } 3$ ", 6 m long
- 1 double leg from the same pipes, with steps
- head of tripod, connecting the legs, with an eye to hold the pulley
- device to take up the winch

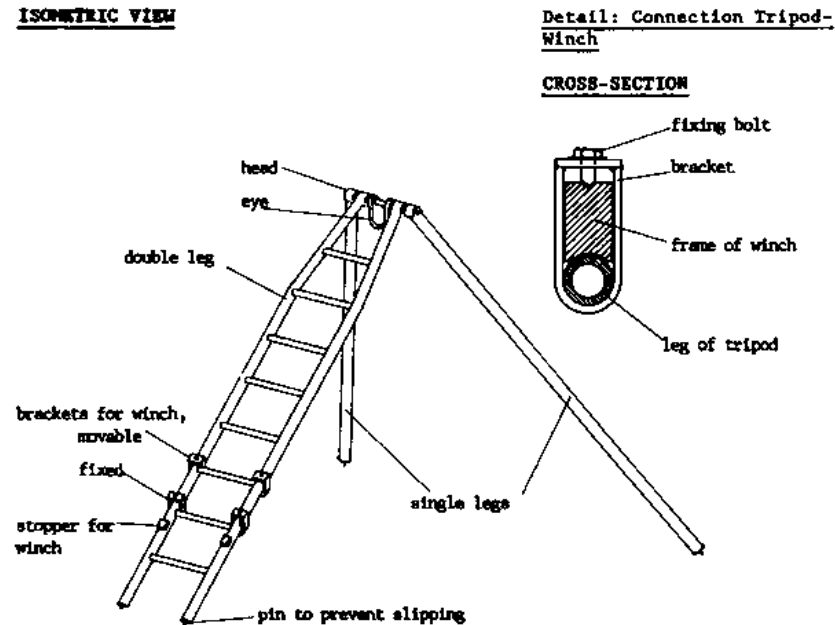

Design: Van Reekum Materials, Netherlands

Check the connection between the legs regularly for damage.

Never load the tripod if one of the legs has even a slight bend!

Watch the tripod when you put it under load.

Tripods can be manufactured locally in a welding shop or purchased ready-made.

2. Steel Cable

Steel cable of $\text{Ø } 10$ nun is suitable for lifting concrete rings. It has a soft core with several thinner steel cables wound around it.



If handled carefully, steel cable is very strong and durable.

Steel cable must always be wound up “under tension”. If necessary, provide the tension by pulling the cable by hand while winding up. Never attempt to fold steel cable.

Steel cable is only strong if all parts are intact.

Never use steel cable for heavy loads if even one of the parts is split or broken.

After lowering several rings, the cable might be more twisted than usual due to the turning movements of the ring. In this case, the cable tends to fold itself while not under tension:



In the long run, this spoils the cable at the fold. Never try to straighten the cable by force, but untwist it carefully. Prevent folds by untwisting the cable from time to time.

Protect the ends of steel cables by gas welding. Otherwise, the cable will unwind itself and get weak. The split ends of a steel cable can also badly hurt people.

Use two wire rope clamps (= cable clamps) and a thimble for the ends of a steel cable.

Tie the wire rope clamp firmly, but do not squeeze the cable. Tie the clamps in opposite direction. See also 6.3/40.

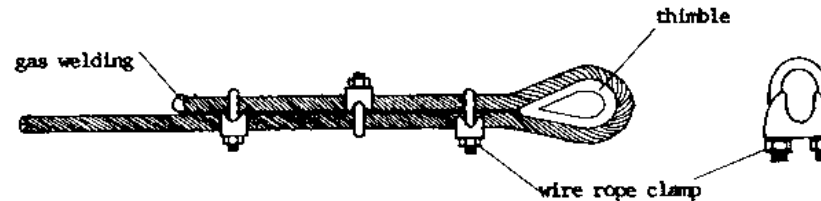

3. Winch

A hand-operated winch for lifting concrete rings consists of the following elements:

- a drum for winding up the steel cable,
- a gear,
- two winding handles,
- a safety device which blocks if the load is suddenly released (= ratchet),
- a lever brake

- a level brake,
- a connecting device to the tripod (see 8.17/15).

Operate the winch with great care. There should be always at least one person at the winch who is familiar with its operation.

Be alert that the safety device is operating at all times. You hear it by the continuous tak-tak-tak sound while lifting.

The safety device is to be suspended only during the actual lowering by a special handle. The person holding this handle must be prepared to release it at any time in case of danger and to brake at the same time. This handle must move freely and fall against the ratchet by its own weight.

Make Sure that the gear is properly engaged.

The pin holding the cover must be well closed. If the cover gets loose, the gear can suddenly disengage and release the load.

Sudden release of a load like a concrete ring is extremely dangerous. The well can collapse; the ring will break; parts of the equipment may break; the handles of the winch will turn with terrible speed and can hurt somebody very badly.

Do not load the winch suddenly. Use the brake to make the movements smoother and to assist controlling the load when lowering.

For details of the winch see the picture next page.

Winch

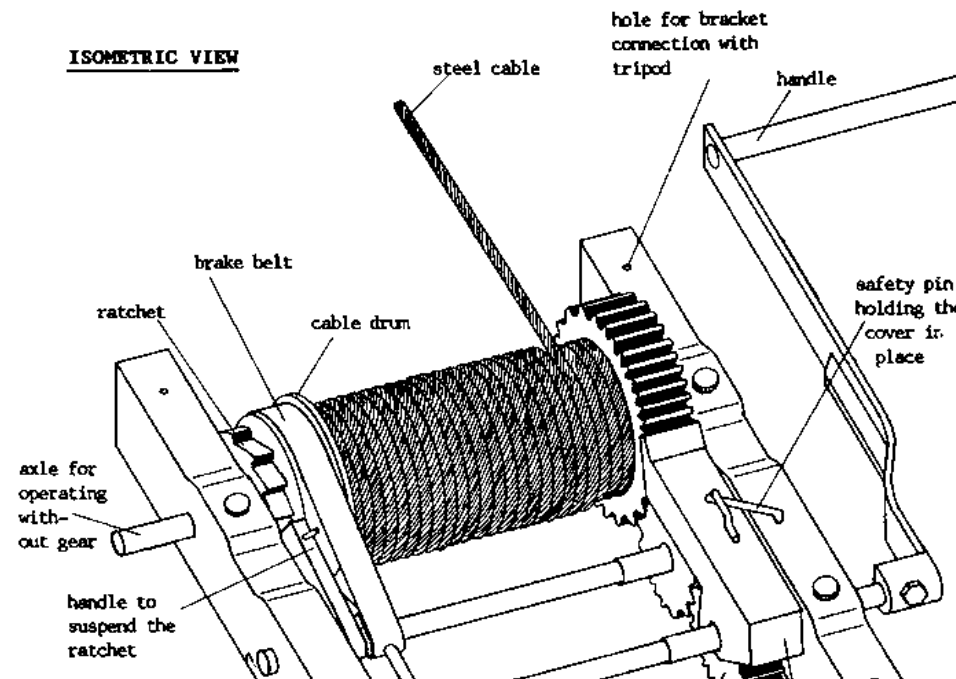

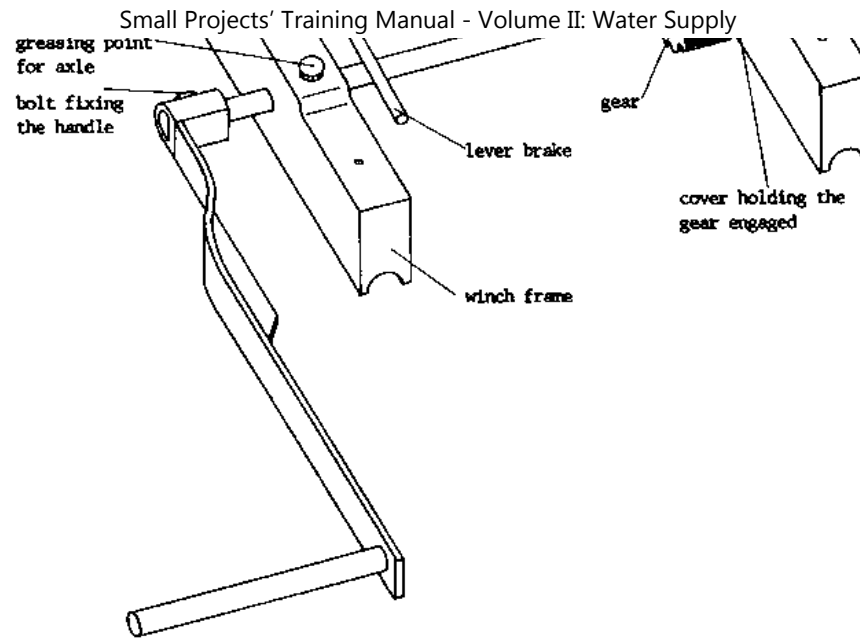

Design: Van Reekum Materials, Netherlands

4. Shackles

The eye of a steel cable can be connected to a swivel-hook, a pulley, another steel cable, or a load by the help of a D-shackle or a connecting link.

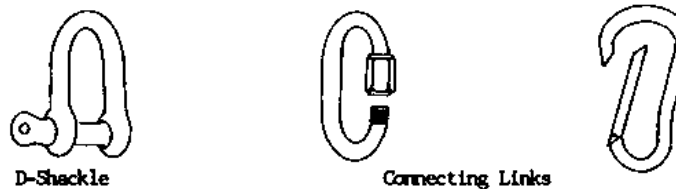

These connections are safe and can be quickly assembled and disassembled. The shackles and connecting links are available in different sizes. The size has to be selected according to the cable diameter and the load. See also 6.3/40.

5. Pulleys

Pulleys consist of the following elements:

- a wheel with a grooved rim to hold the cable or the rope
- an axle
- a frame holding the axle
- a swivel hook
- an eye

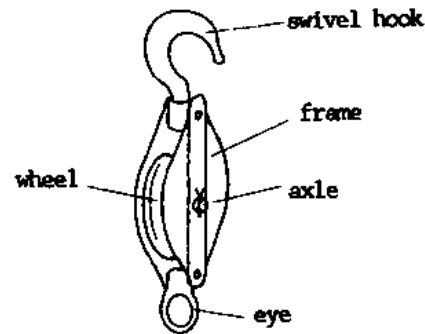

Clean and grease the pulley regularly. Check the hook and the eye. Make sure that the pulley is carefully tied on the tripod and the cable is running smoothly on the wheel without rubbing against other parts. See also 6.3/10.

6. Swivel Hook

A swivel hook (= lifting hook) is a hook from forged steel to lift a given load. Good swivel hooks always have a safety catch. See 6.3/40.

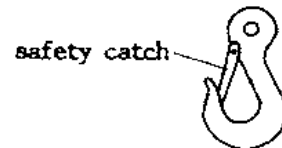

D) Steps of Lowering Rings with Heavy Duty Equipment

When lowering rings with heavy duty equipment, follow these steps:

1. Erecting the Tripod

No	Step	Reasons
1	Erect the tripod. The top shall be exactly over the centre of the hole. The angle between the tripod legs and the ground level should be about 45°. Both single legs must stand at the same distance to the double leg. The distance between the feet of the single legs should be about 4 m. Measure the distances between the legs with a measuring tape. Dig holes for the feet of the legs.	If the tripod is not properly erected, it can tip over during the work and cause damage and danger.
<p>A diagram showing a tripod structure. A vertical dashed line represents the center of a hole. Two solid lines represent the legs of the tripod, meeting at a point above the hole. The angle between one leg and the horizontal ground is marked as 'a'. A label 'a = b' is placed to the right of the diagram, indicating that the distances from the center of the hole to the feet of the two single legs are equal.</p>		

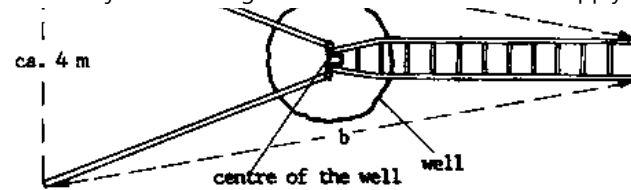

- 2 Fix the winch on the double leg and a pulley at the top of the tripod. Standing behind the winch, the cable must be seen hanging exactly between and parallel to the legs of the double leg. From the other side, the tackle cable must be in the centre of the well.

Thus the centre of gravity of the ring hanging on the tripod will be within the three legs and will not pull the tripod over.

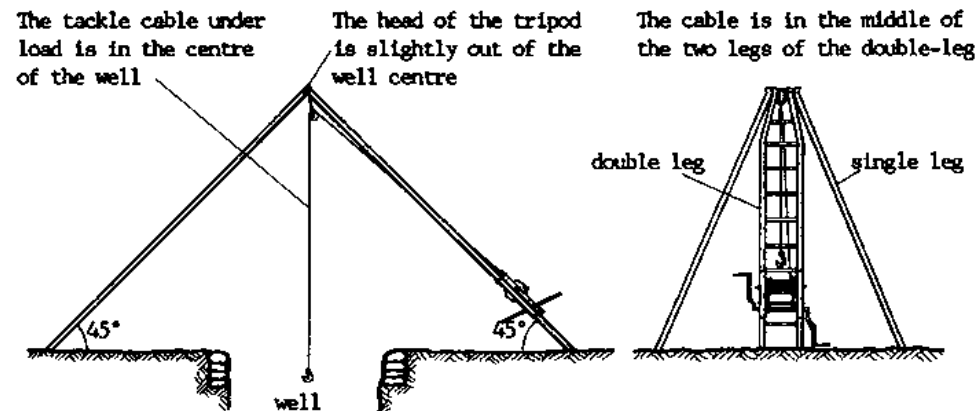

2. Lowering the First Ring

- | | |
|---|---|
| 1 Level the bottom of the well. Check with a spirit level. | The bottom must be level so that the first ring will be level, too. |
| 2 Lay three pipes $\text{\O} 3''$ across the hole, parallel to the double leg. Role the ring near to the hole (position No. 1) and turn it over into horizontal position (No. 2) with the help of a rope sling and enough people. Be very careful. The ring should stand between the two single legs. | If the ring rolls into the well, it will break and damage the well. |

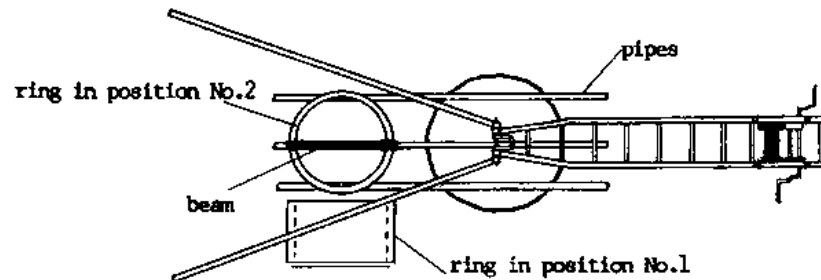

<p>3 The cable sling is fastened around the ring with the beam by method No. 4 in A. and attached to the tackle cable. The beam shall be parallel to the double leg. For middle size rings, a tackle with one pulley block and one cable is sufficient. For deep wells, lowering is only possible with <u>one</u> tackle cable. For very shallow wells up to 8 m and large rings, a tackle with two cables and two pulley blocks should be used.</p>	<p>The beam prevents the top of the ring from being crushed. The sling provides safe lifting. In deep wells the ring is bound to turn. Two cables would twist around each other and block.</p>
<p>4 Pull the cable gently upwards and push the ring on the pipes into the centre of the hole. <u>Nobody must ever be underneath a ring.</u> Nobody should put a hand or foot underneath a ring.</p>	<p>The ring moves into the middle of the hole in a controlled way. <u>Safety first.</u> In case of an accident the ring can kill somebody underneath.</p>
<p>5 Re-adjust the sling. Lift the ring and check if it hangs horizontally.</p>	<p>If the ring does not hang horizontally, it can lose balance and it can get stuck in the well.</p>
<p>6 Pull the pipes away from the hole.</p>	<p>They are not needed for lowering, but in the way.</p>
<p>7 Pay out (= release) the tackle cable and lower the ring into the well until it reaches the bottom of the well. <u>Nobody</u> must sit on the ring while lowering.</p>	<p>In case of any failure, a person sitting on the ring while lowering would be in great danger.</p>
<p>8 Lower a technician into the well by a second pulley, rope, and piece of wood (see 8.21/2). Check the position of the ring with the spirit level (see in detail 8.15/4). If not exactly level, lift the ring slightly and remove some soil from underneath until the ring is exactly level.</p>	<p>A well is less stable if the walls are not vertical. In a deep well, the top rings will not fit, but touch the wall, if the first ring is not level. To straighten the rings later on is much more difficult.</p>
<p>9 Remove the sling from the ring and wind up the steel cable.</p>	<p>The swivel hook is heavy enough for winding up the cable under tension.</p>

3. Lowering the Rings below Water Table

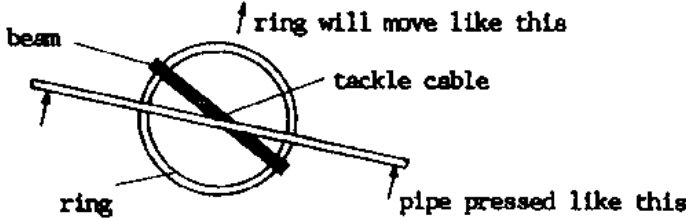
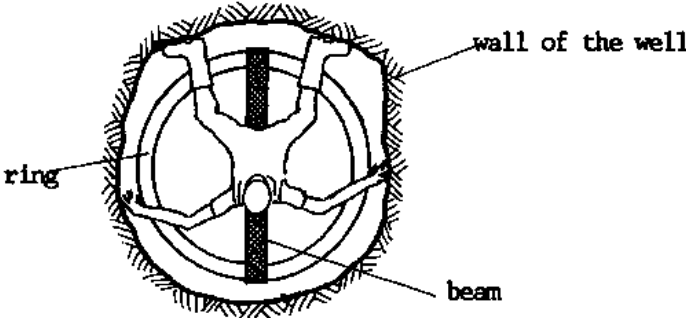
1	Lower the next ring in the same way (repeat No. 2, steps 2 to 6)	All rings are lowered in the same way.
2	Pay out (= release) the tackle cable and lower the ring until the ring has reached the previous ring. You can direct the ring from the top by pressing a pipe against the tackle cable in the desired direction.	Sometimes the ring must be directed because the well is narrow at some spots.
		
3	Lower a technician into the well. She/he should sit on the beam with the legs on both sides of the beam against the walls of the well. The hands should also lean against the wall. Lift the ring by about 5 cm. While being lowered again, the technician can direct the ring so that it is placed exactly on the previous one, with the rebates fully attached.	In most cases the ring will not get placed automatically in the correct position, but it must be directed. The described position keeps the ring in balance and enables the technician to direct the ring easily.
		
4	Check if the ring is level. Remember the direction of the neutral line (= connection between the two neutral points). If necessary, correct by putting sand or mortar between the rings on the lower side.	It is acceptable if the ring is out of level by 0.5 to 1 cm, especially, if the direction of the neutral line changes with each ring.
5	Remove the sling from the ring and wind up the steel cable.	
6	Continue to lower rings in the same manner. In between you might need to dewater the well.	For dewatering wells during construction see 8.25, 8.26, 8.27, 8.28.
7	If the cable is too much twisted after lowering some rings, untwist it.	See 8.17/16
8	Backfill after stacking maximum 4 to 5 rings above each other. Fill clean	The backfill prevents the rings from horizontal movement and bears part of

gravel between the rings and the wall all around. This work becomes much easier if you use plastic pipes Ø 4" and a funnel and pour the gravel directly from the top evenly all around. Take great care that the pipes are properly connected and suspended and no gravel misses the funnel.

the rings' weight through friction. 6 or more rings put on top of each other, without horizontal support, is a very unstable and dangerous construction. It might cause breakage, uneven sinking or tilting to the side. Gravel backfill below the water table allows the water to enter the well. A single stone, missing the funnel, is a great danger for the technician below.

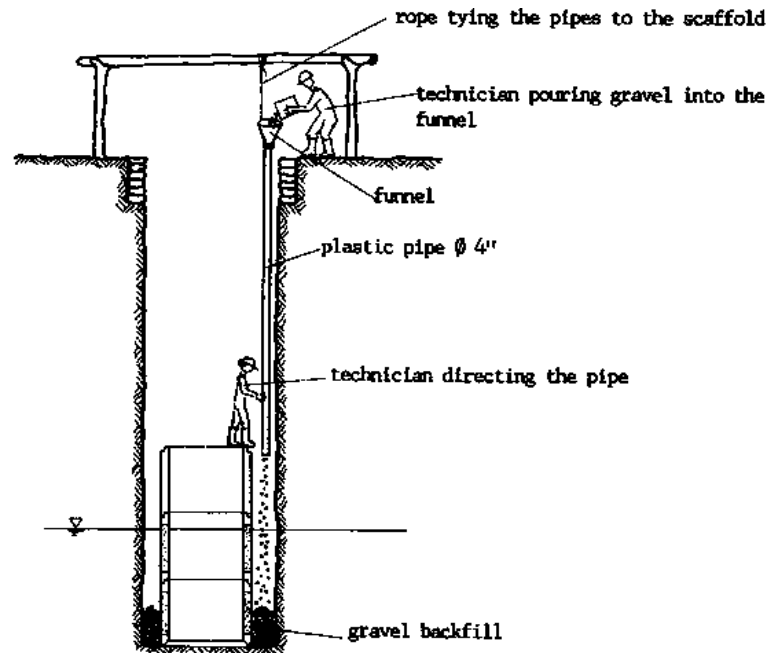

4. Lowering the Rings above the Water Table

1	For rings above the water table, spread mortar on the rebate before lowering the next ring.	Above the water table, the joints should be watertight to prevent surface water from entering the well (8.16/4;
2	Lower the ring. Repeat No. 2, step 2 to 9.	
3	Lower a technician sitting on a bosun's chair. She/he should close the joint between the two rings with cement mortar.	The joints between the rings should be smooth from inside.

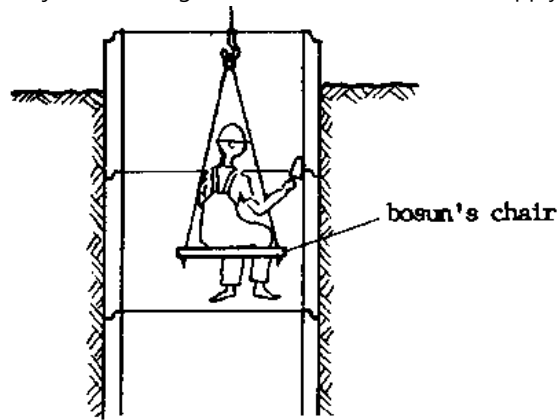

4 Backfill the rings above water table with clay. Compact it well.

Clay backfill is an additional protection to prevent surface water from entering the well.

8.18 Manufacturing a Well Cover

A well cover is a cover made from concrete to be placed on top of the lining. The purposes, the types and the manufacturing procedures of a well cover are described in this chapter.

A) Purposes of a Well Cover

A well cover serves the following purposes:

1. It prevents (or reduces) possible pollution of the water in the well.
2. It holds the pump or any other water lifting device.
3. It provides an emergency opening in case of pump break-down.
4. It is removable in case major maintenance or deepening the well becomes necessary.

B) Well Covers for Different Water Lifting Devices

The well covers differ according to the water lifting device to be used.

1. Well Covers for a Bucket

Lifting water by bucket and rope is appropriate wherever maintenance of more sophisticated systems cannot be ensured. In this case, any well cover is already an improvement on wells without.

These are possible well covers for buckets:

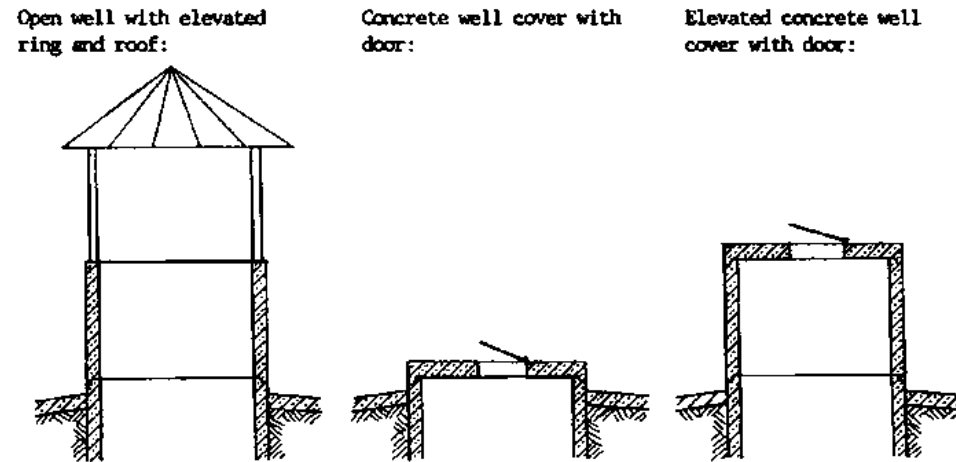

The elevated concrete well cover provides most protection from pollution.

2. Well Cover for a Hand Pump

If a hand pump is to be installed, the well cover must be from reinforced concrete in order to withstand the movements and vibrations of the hand pump. The hand pump body can be either cast directly into the cover, or bolts are cast into the cover and the pump is later fixed with nuts. The former is a very strong, watertight connection, the latter has the advantage that the pump can easily be replaced by another type. However, if the seal is not intact, the connection might not be watertight.

Hand pump cast into the well cover:

Hand pump fixed with bolts to the well cover:

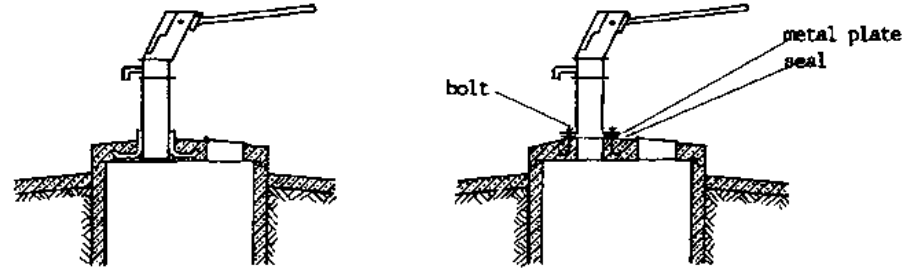

3. Well Cover for Electrical Pump

The installation of an electrical submersible pump requires only a cylindrical opening of 10 to 20 cm Ø. The electrical cable and the delivery pipe will enter the well through this opening. However, the opening must be sealed watertight by a metal sheet or rubber cut to fit exactly to prevent pollution.

Well cover for electrical pump:

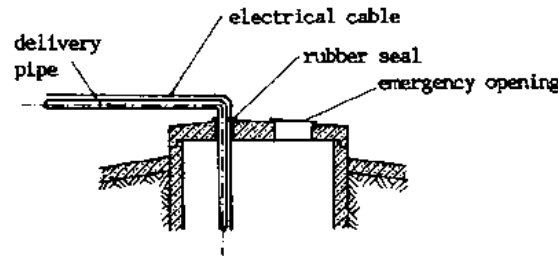

C) Emergency Openings on Well Covers

The advantage of a large diameter hand dug well is that the cover is big enough for an emergency opening. This is to be used whenever the pump breaks down, cannot be repaired immediately, and people need the water, or when cleaning of the well bottom becomes necessary. The emergency opening can be constructed in three different ways: a manhole with metal door, a man hole with concrete lid, or a cover cast in two sections, one of them being removable.

CROSS-SECTION

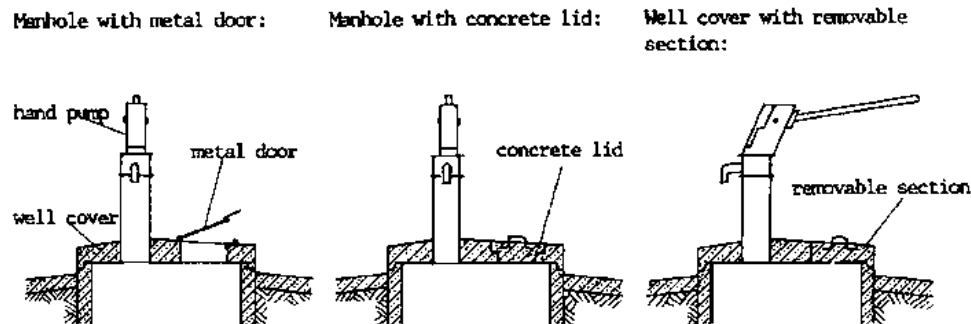

LAYOUT PLAN

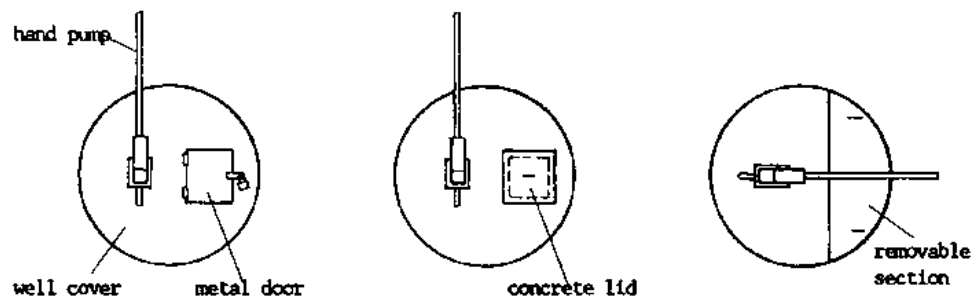

Having an emergency opening is one of the advantages of a hand dug well over a borehole and, therefore, it is not at all advisable to build a well cover without an emergency opening.

D) Moulds for Making Well Covers

A well cover should fit properly on the top of the lining. Different moulds can be used:

1. Mould from Timber for Well Cover on Top of Brick Lining

A simple mould can be made from timber for an octagonal (= having eight sides) well cover instead of round shape. Only the corner pieces have to be cut to size. An octagonal cover is lighter than a square cover.

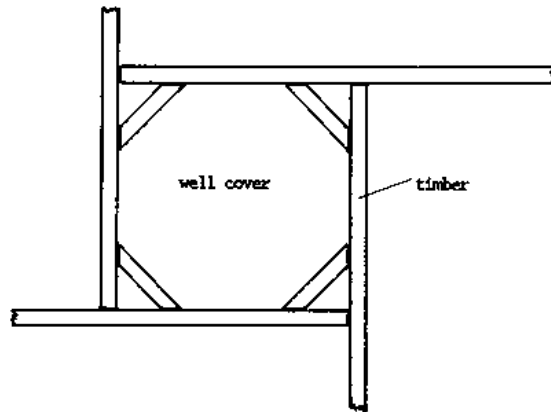

2. A Hole as Mould for a Round Well Cover

A hole dug into the hard ground can serve as a mould, but only once.

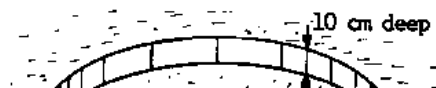

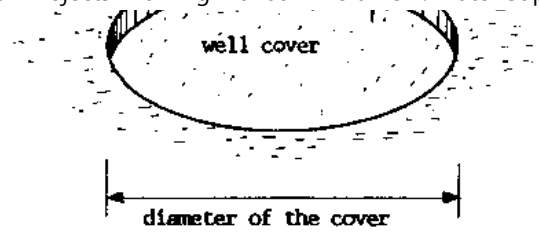

3. Outside Mould for Concrete Rings

The outside mould for rings can be used to manufacture an exactly fitting well cover. This method, described under E), is not very handy, because the big mould hinders the work, but it should be used if a special mould for well covers is not available.

4. Special Mould for Well Covers

A special mould for well covers looks exactly like the outside mould for a ring, although the height is only 15 cm.

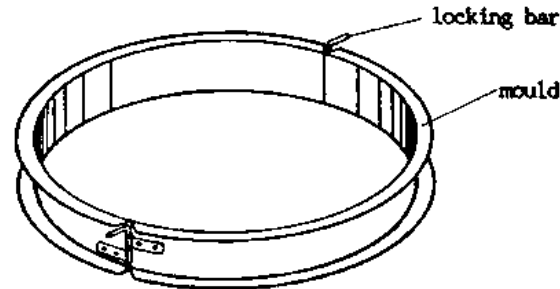

Manufacturing a Well Cover:

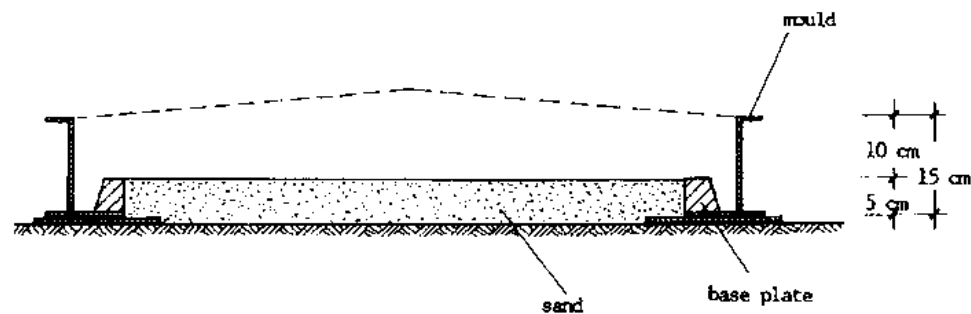

SCALE 1:10

The Finished Well Cover:



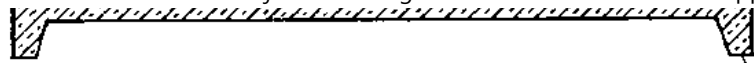

This rebate ensures that the cover fits exactly on top of the last concrete ring. Water is prevented from entering the well.

E) Casting a Well Cover

Casting a well cover is explained here for an India Mark II hand pump which is cast into the cover, and has a manhole with metal door. An outside ring mould is used. The other types can be manufactured in a similar way with minor modifications. The different parts of the pipe mould are explained in 8.16/7f.

The described well cover with its reinforcement is strong enough to withstand the dynamic load of a hand pump and will not develop cracks if well made.

Step-by-Step Procedures

No	Step	Reason
1	Cut a triangle from each of the legs of the pump body. Bend them into horizontal position and weld the cut.	The pump body suitable for boreholes needs to be adjusted for a hand dug well cover.
2	Provide the metal door of the man hole with locking facilities (e.g. iron bar with hinge for padlock) and anchors ("dastours"). Nail a wooden frame as shuttering for the man hole.	A man hole is necessary for cleaning the well bottom or for drawing water when the pump is broken. It must be lockable in order to prevent contamination.

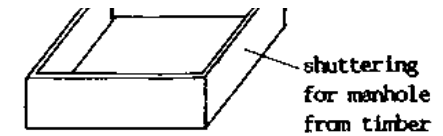
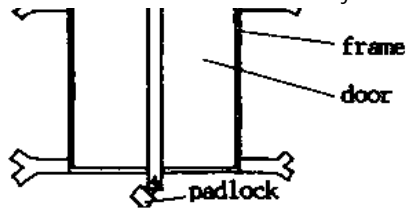

3 Place the base plate of the pipe mould horizontally and fill it with wet sand up to the brim.

The base plate needs to lay horizontally because the position of the pump body and the slope of the slab need to be measured from horizontal ground.

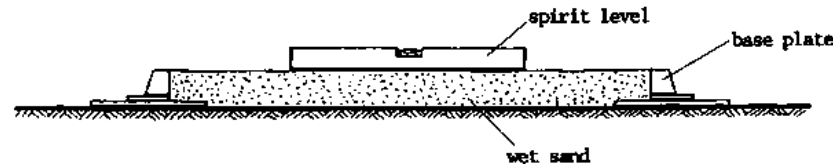

Scale 1:15

4 Make a ring from reinforcement (8 6 mm laying 2 cm inside the edge of the base plate. Cut welded mesh into round shape slightly smaller than the pipe mould.

The reinforcement ring \varnothing 6 mm shall reinforce the edge of the cover. The welded mesh prevents the cover from bending and breaking.



Scale 1:15

5 Place the pump body and the man hole shuttering and door on the welded mesh in correct position. One leg of the pump body must be in direction of the spout. Cut openings into the welded mesh accordingly. Cut reinforcement \varnothing 16 mm and place the bars under the tip of the legs of the pump body. Fix additional reinforcement \varnothing 6 mm outside the man hole. Fix all reinforcement with wire.

If the different parts are too near to each other, the legs of the pump will not be properly embedded in the concrete. The reinforcement bars \varnothing 16 mm carry the pump body and take up the movements.

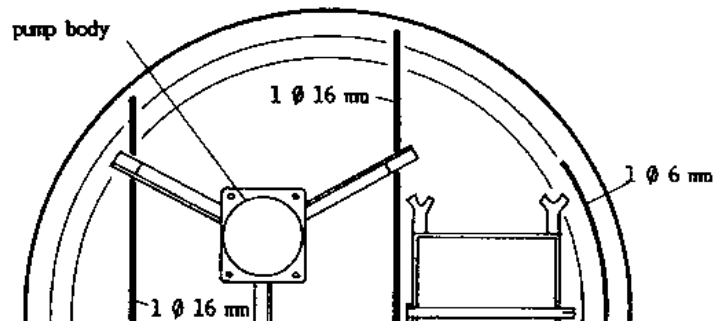

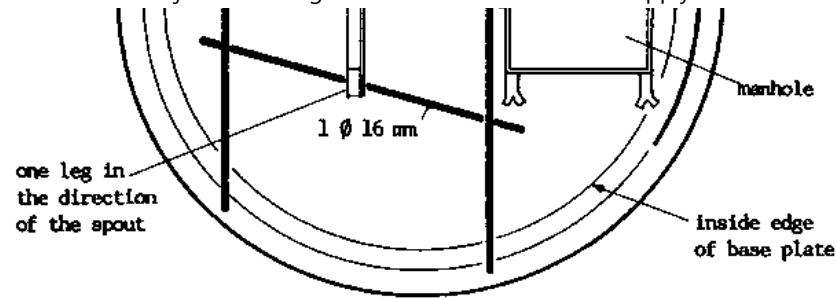

Scale 1:15

6 A ring from zinc is placed in the position of the pump body, the shuttering in the position of the manhole, and both are filled with sand. All other parts are taken away. The outside pipe mould is placed on the base plate. Paint mould and base plate with old engine oil. Pour 2 cm concrete (mixture 1:3:4) into the edge and compact it. The reinforcement rod Ø 6 mm is placed on top.

The base plate and the outside mould ensure that the cover will fit exactly on top of the last ring. The zinc ring prevents concrete from pouring through the gap below the pump body. The shuttering will provide the manhole opening.

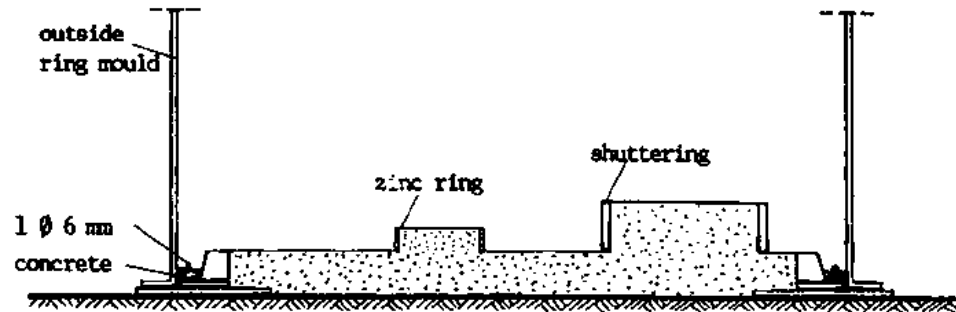

Scale 1:15

7 Pour concrete 2 cm thick all over the cover and compact it well. Place welded mesh, reinforcement bars Ø 16 mm and the pump body on top. Check the position of the pump body with the spirit level (in all directions).

Concrete 2 cm thick must be underneath the reinforcement in order to prevent it from corroding. The pump body's top needs to be horizontal so that the riser main pipes will hang vertically.

8

Pour concrete into the cover and compact it until the legs are almost covered. Place small pieces of welded mesh above the tips of the pump legs. Place the manhole door with a slight slope outside.

Welded mesh above the tips of the pump legs prevents the surface of the slab from cracking due to pump movements. The water should run quickly over the manhole instead of entering.

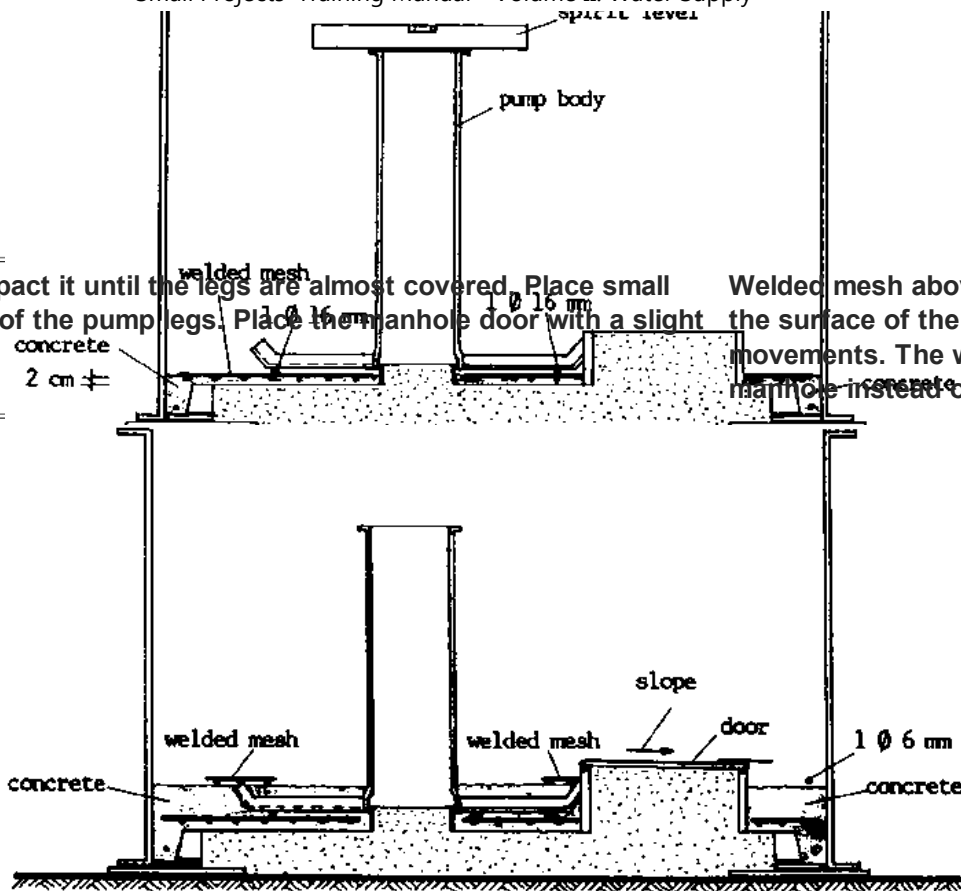

Scale 1:15

Scale 1:15

9

Pour concrete up to the brim of the door frame. It should well cover the pump legs (the slab will such become 10 to 12 cm thick). Cover the slab with cement mortar (mixture 1:4). It should have a slope in all directions, however, a bigger slope under the spout. Smooth the surface with the trowel and sprinkle cement on top with a small sieve.

The pump legs needs to be well covered in order to prevent cracking and corroding. The slope ensures that rain water and spilled water runs away quickly. A smooth finish is slippery and dangerous. A rough finish is not slippery and strong.

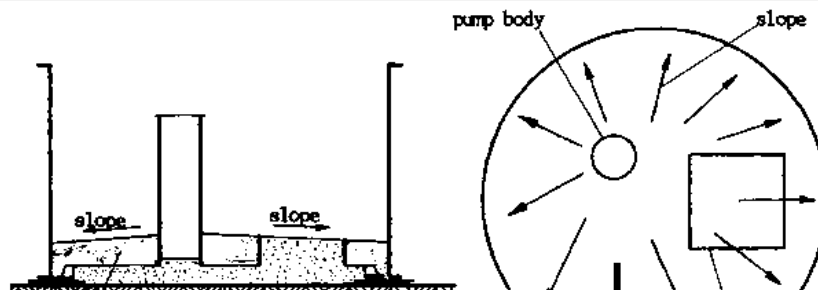

finished well cover

strong slope

manhole

Figure
Scale 1:25

10	Write the date into the fresh concrete. Cover the slab three hours later with wet sand. Keep it wet for one week.	Curing the concrete (= keeping it wet) makes it very strong and prevents cracks. This is especially necessary because the cover will be subjected to dynamic load.
11	Place the cover on the well only <u>after two weeks at the earliest</u> .	Before that the cover is not yet strong enough. See 6.6/6f.
12	Install the pump <u>after three weeks at the earliest</u> .	Dynamic loads must not be exerted earlier because they are heavier than static loads. If cracks have once developed, they will widen through the pump movement.

8.19 Well Head with Hand Pump

For the users, the well head is the only visible and most important part of a well. It is as important for the functioning of a well as the parts below. The elements of a good well head are explained here, both for a borehole and a hand dug well, as they are almost alike. For other types of water-lifting devices, the well head is basically the same except for the pump parts.

It is a completely false economy to try to save money by making a smaller platform or by using a weak cement mixture, or to save time by installing the pump before curing is complete. Such measures will certainly lead to cracks in the platform, which subsequently leads to quick pump break-down and pollution of the water. To repair a cracked platform means having to destroy it completely and to replace it by a new one. This, obviously, is much more expensive than making a proper platform in the first place. To repair the hand pump repeatedly without repairing the cracks is a waste of money because cracks allow the pump body to move and to shake, and the constant unnecessary vibration is bound to wear out the hand pump parts quickly.

How to construct a good well head is described in 8.20.

A) Elements of a well head

A well head with hand pump (or a water point with tap) consists of the following elements, both for borehole and hand dug well:

No	Part of the Well Head	Description	Function	Pay Attention at	Work of
1	pump body	body with three legs	to hold the whole hand pump incl. pipes and pump head	one leg in the direction of the spout, positioned level	WS
2	pump foundation	concrete block 0.80 × 0.80 × 0.80 m or well cover	to prevent pump from moving	pump legs well covered with concrete	WS
3	platform	concrete slab 0.10 m thick with	to prevent dirty water from entering the well	slight slope towards drainage channel	WS

3	platform	concrete slab 0.10 m thick, with elevated edges	to prevent dirty water from entering the well	slight slope towards drainage channel, a jerrycan must fit under spout	WS
4	pumping stand	elevated concrete slab	to give the user a firm stand	located at the end of the handle	WS
5	drainage channel	ditch made of concrete	to drain spilled water far away from the well	slope from the pump away	WS
6	soak-away Pit	dug pit 1.00 x 1.00 x 0.80 m filled with stones/gravel	to prevent the place from becoming muddy and to prevent mosquito breeding	at the end of the drainage channel	WS
7	fencing	fence around the platform with door	to keep animals away from the well	can also be a hedge	WS +CD
8	lock	lock for door or chain and padlock for the hand pump	to control the use of the pump, to lock when damaged, to prevent further damage	dismantling the chain daily spoils the pump	CD
9	clean surroundings	not muddy, free of rubbish and high grass	to prevent containers, people and groundwater from getting dirty	continuous cleanliness is necessary	CD
10	a good caretaker	duties and behaviour see 8.33	to ensure proper use and implement the wishes of the community	the caretaker has technical and social duties	CD +WS

WS = Water Supply Department; CD = Community Development Department

If only one of these elements is missing or not well functioning, there will be problems in the daily operation of the hand pump.

B) Well Head of a Borehole

LAYOUT PLAN A-A

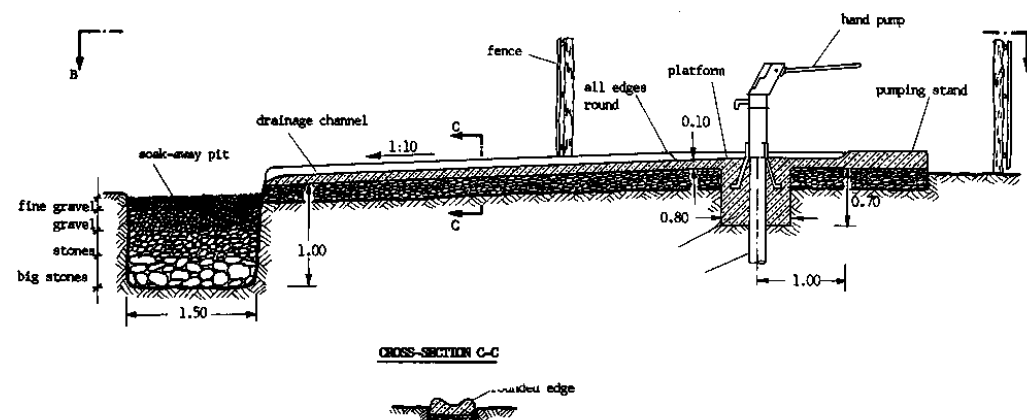

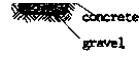

SCALE 1:50

LAYOUT PLAN B-B

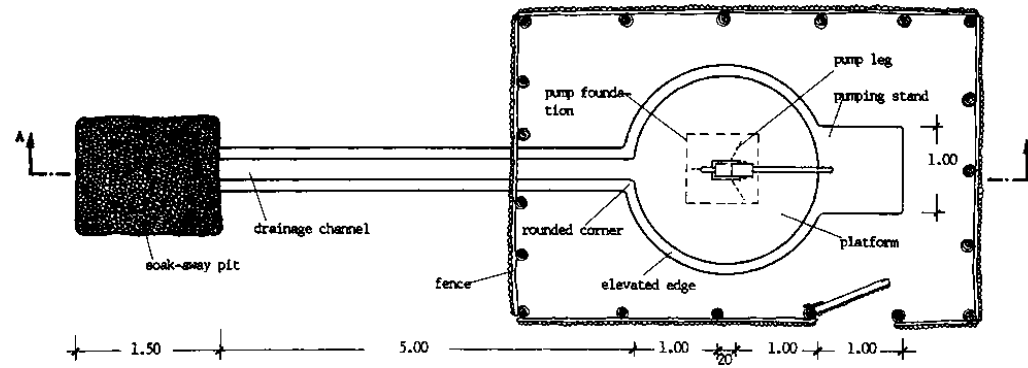

SCALE 1:50

C) Well Head of a Hand Dug Well

LAYOUT PLAN A-A

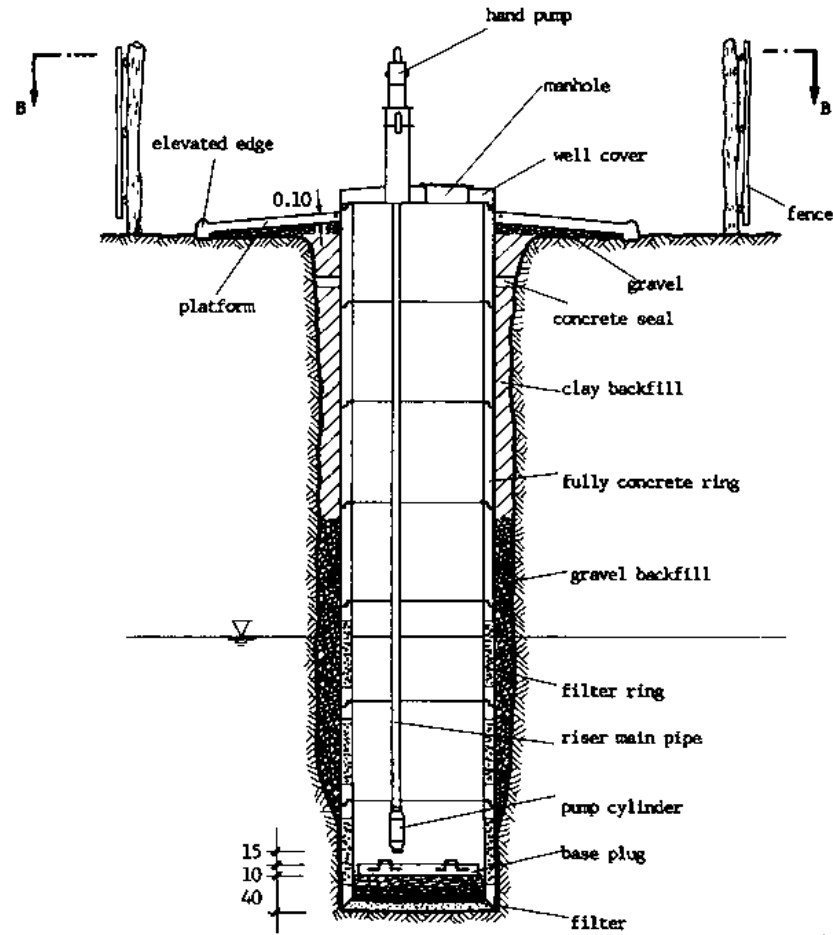

SCALE 1:50

LAYOUT PLAN B-B

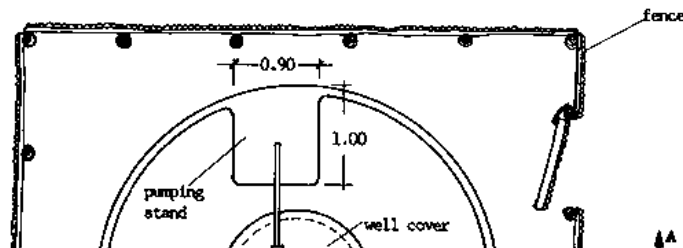

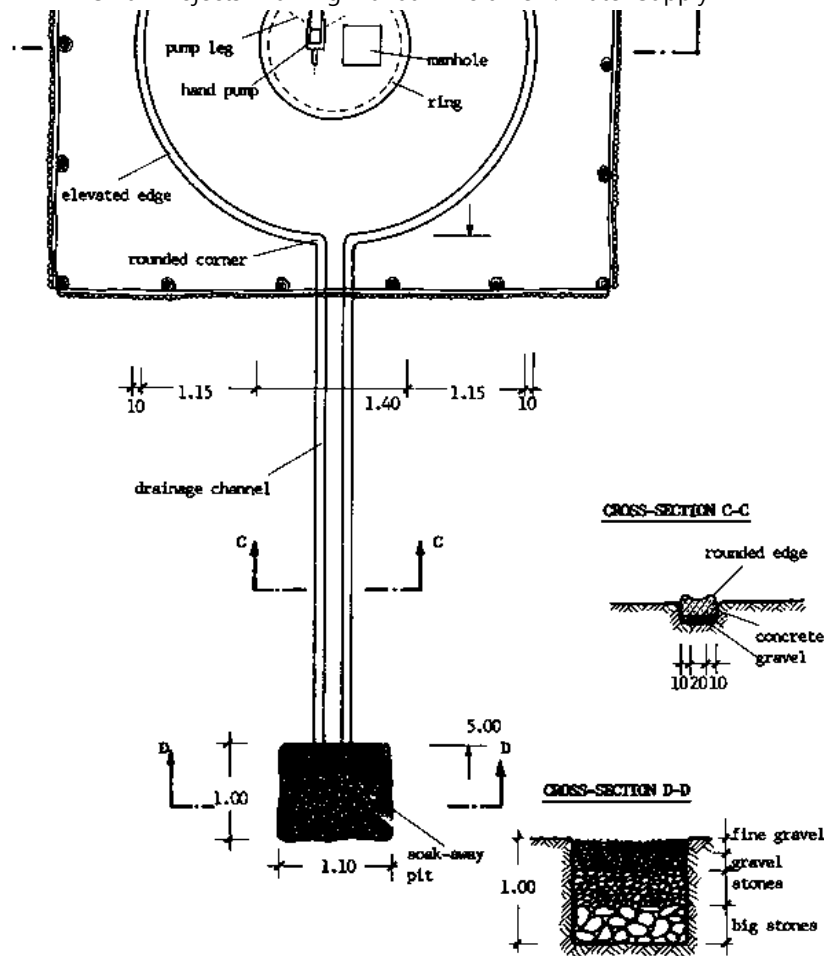

SCALE 1:50

8.20 Completion of a Well

After lowering the rings, the well still needs to be completed. A completed well is shown on 8.19/5f. For completing a well, follow these steps:

Step-by-Step Procedures:

No	Step	Reasons
1	After the well has been dug deep enough into the water and all the rings have been lowered, check if the rings are horizontal. If not, dig until the rings are horizontal, or balance the difference with mortar in the joints of the rings.	The rings need to be horizontal so that the cover will be placed horizontally as well.
2	Wash the rings inside and outside if necessary.	Mud and rests of old engine oil spoil the

		groundwater.
3	<p>Backfill the rings with gravel in the bottom and clay in the top. Compact the backfill well layer by layer. A simple method for backfilling is described in 8.17/23f. See also 8.19/5.</p>	<p>Gravel backfill in the bottom allows the water to enter the well. Clay backfill in the top prevents contaminated surface water from entering the well. Not properly compacted backfill will settle later on and cause the platform to crack.</p>
4	<p>Sieve filter material (sand, fine gravel Ø 3-5 mm, rough gravel Ø 10-15 mm, and stones Ø 20-25 mm) and wash it. Use three sieves from mesh of different sizes.</p>	<p>Organic material in the well spoils the water.</p>

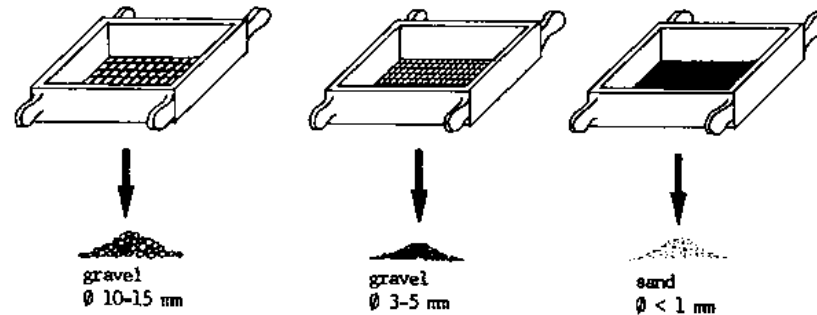

5	<p>Clean the bottom of the well from all mud and organic material and level it. For this work, dewatering of the well might be necessary. Pour one layer of sand evenly over it, afterwards a layer of fine gravel, then a layer of rough gravel and then a layer of stones. If the well has a very great yield, place a base plug on top. A base plug is a round slab with two handles from filter type concrete (mixture 1:1:4), slightly smaller than the diameter of the ring.</p>	<p>Rotting organic material spoils the water quality. For dewatering a well during construction see 8.25-28. The filter prevents sand and mud from entering the well and thus makes the water clear. A base plug is only necessary where the inflow is so strong that it might wash out the sand.</p>
---	--	---

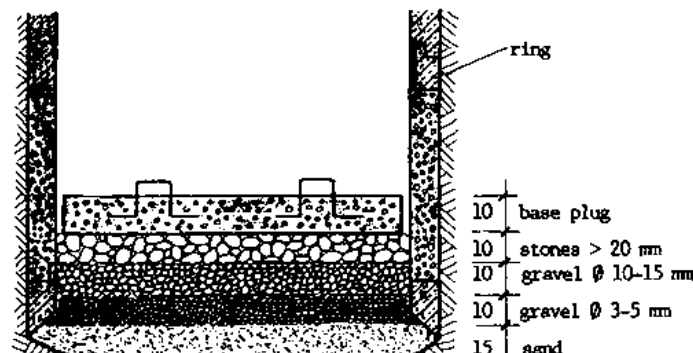

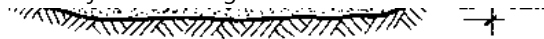
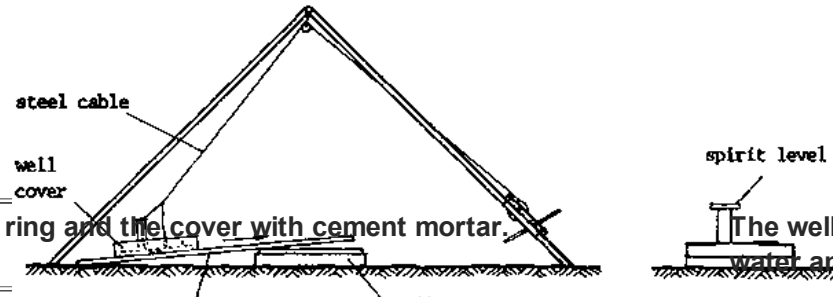
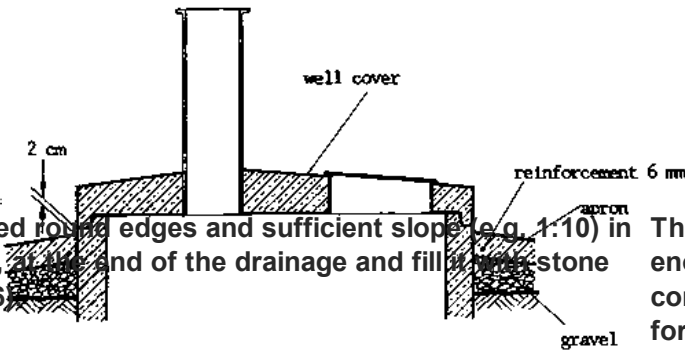

Figure
Scale 1:20

6	Remove all dirt, like grass, animals, etc. from the water.	Animals left in the well will die and decay, also grass and other dirt, and spoil the water.
7	Pump the well as much as possible.	Pumping eventually removes still dirty water and allows clean water to enter the well.
8	Place cement mortar on the rim of the top ring. Lift the well cover by a steel cable through the pump body and the man hole and let it slide over strong pipes until it is on top of the well. Place it on the top ring and adjust it until the top of the hand pump body is level into all directions.	The well cover seals the well from contamination and supports the hand pump. If the top of the hand pump body is level, the riser main pipes will hang vertically.



9	Carefully smear the space between the top ring and the cover with cement mortar.	The well must be properly sealed against dirty water and animals.
10	Pour a 10 cm thick layer of gravel around the well, Ø 3.00 m. It shall have a slight slope outwards.	The gravel is the foundation for the well apron.
11	Put one ring of reinforcement 0 6 mm around the top ring at 2 cm distance from it.	The reinforcement shall prevent cracks in the immediate neighbourhood of the well cover.
12	Pour concrete (mixture 1:3:4) over the gravel in a 10 cm thick layer as an apron of 3 to 4 m diameter. Compact it well. It shall have an outside slope. The top of the apron must be 2 cm lower than the lowest edge of the well cover. Build an elevated round edge of concrete around the apron. Cover the slab with cement mortar (mixture 1:4) and smooth the surface with the trowel. Sprinkle cement on top with a small sieve. All corners shall be rounded, because sharp edges and corners are more easily damaged than rounded ones.	The apron prevents spilled water from entering the ground and polluting the well. Also it prevents the surroundings of the well from becoming muddy. Thus the water containers will remain cleaner. The elevated edge helps collect spilled water and direct it to the drainage channel. It is easily possible to remove the well cover at any time because the apron is not connected to it.

		
13	<p>Construct a drainage channel with slightly elevated rounded edges and sufficient slope (e.g. 1:10) in front of the spout. Dig a soak-away pit, 1 m deep, at the end of the drainage and fill it with stone layers in the opposite way as the filter (see 8.19/6).</p>	<p>The drainage channel transports spilled water far enough away from the well to prevent contamination. The spilled water can also be used for gardening or watering animals.</p>
14	<p>Cover the apron and drainage channel 3 hours after construction with wet sand. Keep them wet for one week.</p>	<p>Curing the concrete (= keeping it wet) makes it strong and prevents cracks.</p>
15	<p>Fence the area around the well (at least an area of 10 m × 10 m) and construct a door. Alternatively, you can plant a hedge. Clean the well compound properly.</p>	<p>A fence prevents animals from polluting the area around the well and it makes the well easier to be controlled. The fence must be built <u>before</u> hand pump installation.</p>
16	<p>Install the hand pump. See 8.31.</p>	<p>Pulling water by a hand pump from a hand dug well prevents pollution of the water.</p>
17	<p>Disinfect the well. See 8.36</p>	<p>The well has been contaminated during construction. This needs to be eliminated before handing the well over to the community.</p>
18	<p>Conduct the operating instruction for the whole community where the importance of water, proper use, running and maintenance are discussed. See 8.39.</p>	<p>As water supply is a technical <u>and</u> social issue, community structures need to be built beside the construction</p>

8.21 Safety Measures

Well construction is a dangerous work. We need to take great care to prevent risks as much as possible. Therefore, keep strictly to the following safety measures.

A) Safety through Stability of the Well

No	Safety Measure	Reasons
1	Watch the walls of the well constantly.	Slight changes in the appearance may suggest collapse.

2	Make dry sand in the well wet before digging.	Wet sand is more stable than dry sand.
3	Below water table, always work in the protection of a ring.	The soil below the water table is always much more unstable than above.
4	Never step on the very edge of a well without collar.	You could loosen a part of the soil and induce partial collapsing, endangering yourself and somebody working down in the well.
5	Dig drainage channels around the well head and cover the well with zinc sheets over nights.	Rain water entering the well increases the danger of collapsing.

B) Safety through Good Equipment and Cleanliness

No	Safety Measure	Reasons
1	Check all equipment daily, like buckets, ropes, knots, pulleys, scaffold. Replace them if they show signs of old age or damage.	First signs of damage can easily develop into major breaks when under load. The scaffold must be very stable and well embedded into the ground soil.
2	Inspect tripod and winch before using them. Brake and safety device <u>must</u> work (see 8.17/17f).	Sudden release of load causes the winch handles to turn with terrible speed and can cause bad injuries. Failure of the tripod can cause bad injuries or kill somebody, too.
3	Tie the pulleys properly to the scaffold.	The pulley can get untied under load.
4	Keep the area around the well free from gravel, stones and unnecessary tools. Clean each day.	Small items can fall accidentally into the well and harm the diggers.

No	Safety Measure	Reasons
1	Always wear a safety helmet when entering the well.	The helmet prevents small particles falling down from damaging your head.
2	Enter a well on a sitting wood, a bosun's chair, or over a ladder. Sit properly on the sitting wood.	Other methods of entering are unsafe because you can easily slip.

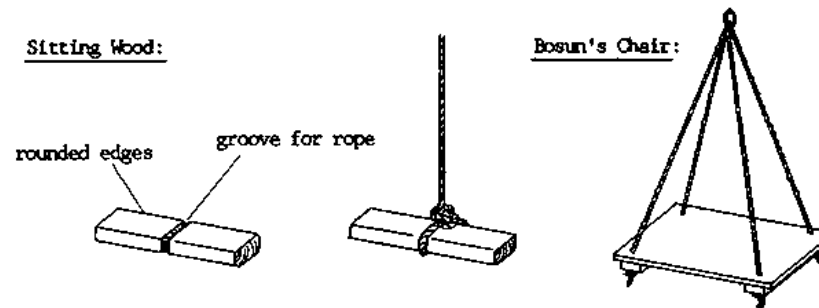

3	Check the bottom of the well with a stick for snakes before you enter the water. Keep the surroundings of the well free from vegetation. When meeting a snake, do not panic, but move slowly.	Sometimes there are snakes in the well.
---	---	---

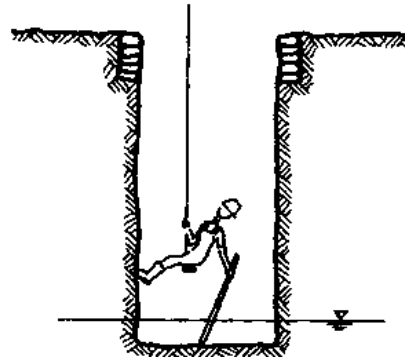

Pull the rope evenly with enough people. Avoid bumping against the walls.

Abrupt pulling can cause swinging of the bucket and puts a bigger load on the rope. Enough people prevent accidents if one of them fails during pulling. Buckets bumping against the wall can cause collapse and result in spilling the contents.

5 Tie shovels, crowbars, etc. properly when lowering them with a bucket according to the drawing.

Otherwise heavy tools can make the bucket tip over.

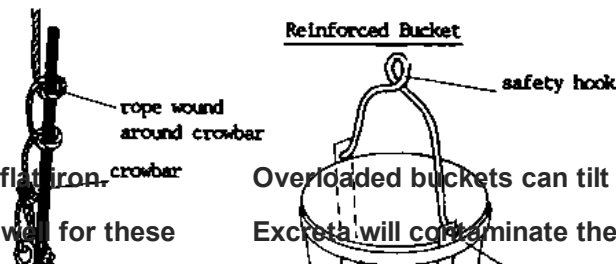

6 Do not overload buckets. Use buckets reinforced with flat iron.

Overloaded buckets can tilt easily and the rope wears out quicker.

7 Never urinate or defaecate inside the well, but exit the well for these purposes.

Excreta will contaminate the water of the well.

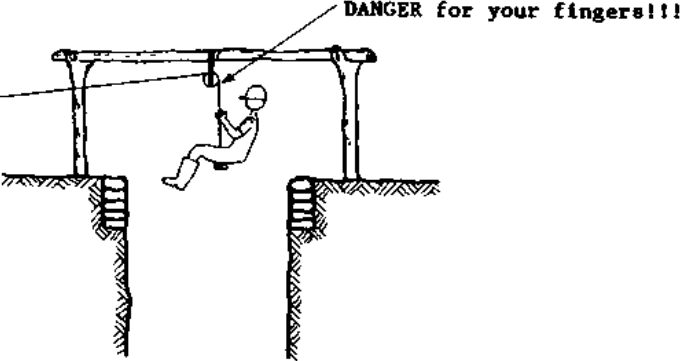
	purposes.	
8	Do not let your fingers enter the pulley when being pulled up.	The pulley can hurt your hand badly.
		
9	If you get wet during work in the well, immediately take off the wet clothes after leaving the well and put on dry ones. Take an extra set of clothes with you for this purpose. Drink enough water. Women should take special care.	Wet clothes on the body, especially if exposed to wind or draft, can cause sicknesses of the kidneys, urinary tract and female reproductive organs. The bad effects are not felt immediately, only later.
10	Keep the danger of bad air in mind.	See 8.22
11	Use the safety belt in any dangerous situation like bad air, work under water, etc.	See 8.22

D) Safety through Good Communication

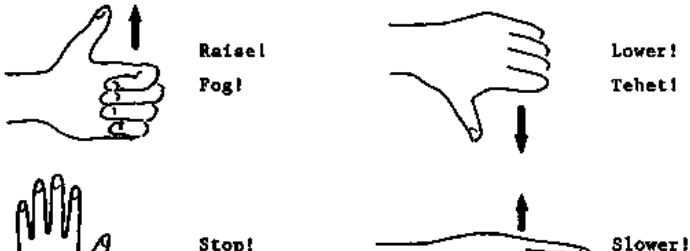
No	Safety Measure	Reasons
1	Solve any quarrels between labourers before continuing work.	Unsettled quarrels make people careless and inattentive and cause danger.
2	Somebody at the well head must be assigned to constantly watch the diggers down, to communicate between diggers and labourers above, and to direct the work.	The diggers at the bottom are helpless in the face of problems unless somebody can hear them.
3	Use clear signals according to the drawing:	Clear signals, known to everybody, prevent misunderstanding.
		



4	Keep passers-by and children away from the well (if necessary by an improvised fence).	Curious people want to watch, but do not know the dangers. They can endanger themselves and the workers
----------	---	--

8.22 Ventilation in Wells

Air is the first priority physical need of any human being. Without air human beings suffocate and die within a few minutes. Therefore, it is most important to take care that the workers down a well have a sufficient supply of air. There are cases where several people have died in a well because of bad air.

A) Possible Reasons for Bad Air Conditions in a Well

The following reasons can cause bad air conditions in a well:

1. The ground soil releases dangerous gases (suffocating, explosive or poisonous gases).
2. The well is very deep and narrow and the natural ventilation is not sufficient.
3. The well dried out and no natural ventilation through evaporation takes place.
4. The workers stayed long time down in a deep well and, thus, consumed the oxygen and increased the carbon dioxide content by exhalation.
5. Fumes from the exhaust pipe of a generator, car or pump descend into a well.
6. The well is closed by a cover and has only a small man hole.
7. Something was burnt in a well.
8. Rotting organic material can cause dangerous gases.

Be very careful in any of these cases!

B) Methods to Check the Air Conditions in a Well

1. Check the air with the candle test. Fix a candle in a bucket, light it and gently let it down the well shaft. If the candle burns until the bottom, the air conditions can be expected to be reasonable. The air is bad if the candle extinguishes. Carry out the candle test before starting work on the site in any well deeper than 10 m. Carry out this test daily in any well deeper than 30 m.
2. Check the air for bad, foul smell (but not all kinds of bad air have a bad smell!).
3. Check the air with specialized instruments. These might not be available.

Use any of the methods available at the site.

C) Possibilities to Improve the Air in a Well

To improve the air in a well, you may use one or more of the following methods:

1. Use an airblower with a hose, pumping fresh air into the well. The hose shall reach until 1-2 m above the workers to avoid catching a cold.
2. Use a small compressor with hose to blow air into the well. The hose shall end high above the workers.
3. Use a blacksmith's fan with a hose.
4. Sprinkle water into the well.
5. Raise and lower a basket or a bundle of twigs quickly and several times.
6. Make sure that the well has always a bit of water.

Use the method(s) available and appropriate and check the air afterwards again. Repeat if necessary.

D) Other Precaution Measures

1. In case of any doubt about the air conditions, tie the worker entering the well to the rope. Even if she/he falls unconscious, she/he can be pulled out before serious damage. Do not fear people laughing about such precautions, because you are just protecting your live. You can tie somebody with ordinary rope or use a safety belt.

How to Tie the Rope:

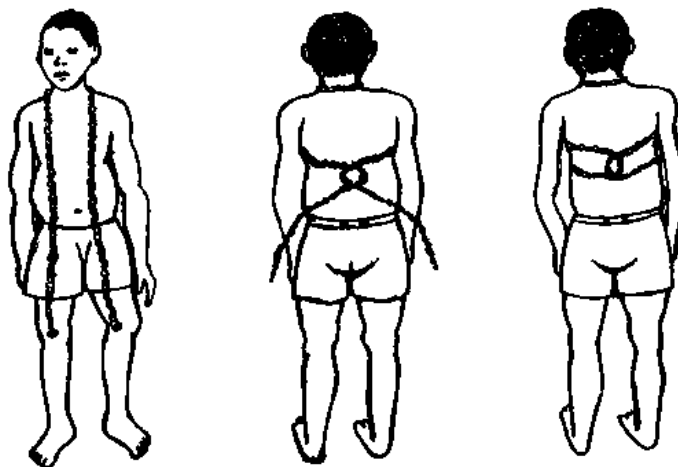

How to Wear the Rope



How to Wear the Safety Belt



2. Somebody at the well mouth has to watch the workers at the bottom constantly and carefully.

3. Allow workers to work only for short periods (1 to 2 hours, maximal 3 hours) down in the well. Exchange them afterwards.

4. Place a generator, car or another machine as far from the well as possible, preferably downhill. The exhaust pipe should point away from the well.

4. Place a generator, car or another machine as far from the well as possible, preferably downhill. The exhaust pipe should point away from the well. Exhaust fumes are heavy and, therefore, easily descend into a well.

5. For respiratory emergency see 1.7/3.

8.23 Ropes and Knots

A rope can transmit tension, but not compression. In other words, you can pull with a rope, but never push. Ropes are flexible and can be wound up for storage.

A) Types of Ropes

Three different kinds of ropes can be used in well construction:

No	Type of Rope	Usual Ø for well constr.	Pulled by	Strength	Protection of Rope End	Maintenance	Used for
1	steel rope or steel cable	10 mm	winch, difficult to pull by hand	very strong	welding (gas welding) or braiding	- always roll the cable properly - prevent it from remaining wet - inspect it regularly	heavy loads like rings in permanent installation
2	nylon rope	10 mm	by hand, however, it gets hot and is slippery and difficult to hold	strong	burning (melting) and knot	- carefully roll it - inspect it regularly	any quick work in between
3	manila or hemp or sisal rope	25 mm	by hand, does not get hot	strong	tying with string and knot	- let it dry if it gets wet - carefully roll it - inspect it regularly	lowering and lifting people and buckets into the well

Handle ropes according to these guidelines:

- New ropes tend to twist when first loaded. Pay attention!
- Provide the ends of ropes with some protection before you start to use them. The rope loses strength when untwisted.
- The strength of ropes is reduced by about half when they get old.
- Avoid friction between rope and pulley or any other item.
- Check the ropes every morning for weak spots.

- If one of the three fibres of a rope is broken at one spot only, the rope must not be used any more for heavy loads.
- Store rope in a dry, airy place, rolled up or in a box and protected from rats.
- Steel cable is a special kind of rope. How to handle it is explained in detail in 8.17/16.

B) Types of Knots

Nylon and sisal ropes are connected with knots. Use the following kinds of knots which are quick to make, safe to use, and easy to untie. Practice them until you know them by heart.

1. Bowline

for tying buckets, etc.

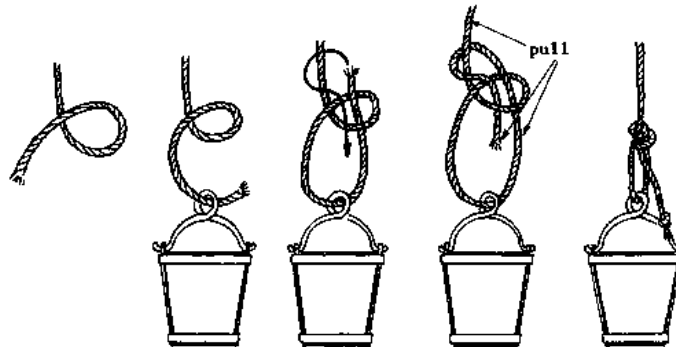

2. Square Knot

for connecting ropes

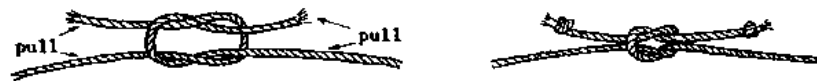

Steel cable cannot be connected with knots. The ends of steel cable have to be provided with eyes; the eyes are then connected with D-shackles or connecting links. For details see 8.17/16.

8.24 Types of Pumps and Other Water Lifting Devices

This chapter gives a rough overview about the diversity of pumps and other water lifting devices.

A pump is a device capable of transporting a fluid (or gas) by using energy supplied from outside.

A) Distinction of Water Lifting Devices and Pumps

Pumps and other water lifting devices can be distinguished according to

1. source of energy used,
2. principle of transporting the fluid,
3. type of fluid transported,
4. maximum lift.

1. Source of Energy Used

Examples (see 8.24/6ff)

- human power No. 1 to 14, 16, 17, 18, 19, 22;
- animal power donkeys pulling water from a well
- solar energy solar pump
- wind energy No. 15;
- water energy No. 21, 26;
- electrical energy No. 30, 31;
- fossil fuel energy (combustion engine) diesel and petrol pumps such as No. 20, 23, 24, 25, 27, 28, 29, 32;

2. Principle of Transporting the Fluid

- bucket No. 1 to 5;
- continuous rope and bucket system No. 6 to 8;
- piston pump (positive displacement) No. 9 to 15, 18, 28;
- membrane pump (positive displacement) No. 16, 17, 19, 20; blacksmith's belly;
- centrifugal pump No. 29 to 31; airblower; "fan";
- impulse pump No. 21;
- ejector pump No. 32;
- helical rotor pump No. 22 to 24;
- coil pump No. 26;
- rotary pump No. 25, 27;

3. Type of Fluid Transported

- clear, clean water No. 1 to 32;

- dirty water No. 1 to 8, 16, 17, 19 to 26, 29, 30;
- mud No. 24 and special pumps;
- fuel or oil fuel or oil pump in the car;
- air airblower;

4. Maximum Lift (=Head)

The head is the vertical distance between the intake level and the discharge level:

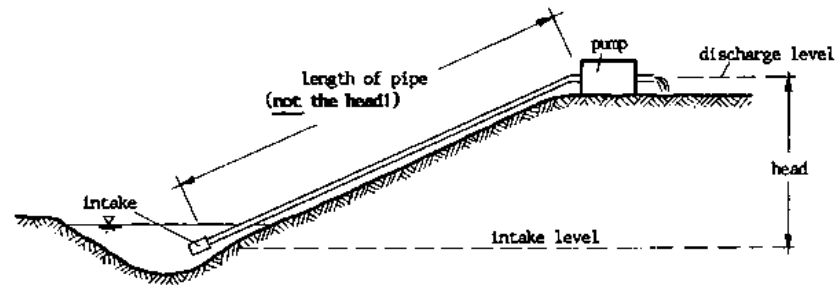

- shallow well pump = suction pump No. 2, 9, 19, 20, 24, 25, 26, 29;
(head: 0 to 7 m)
- deep well pump = lift pump No. 1, 3 to 8, 10 to 18, 21, 22, 23, 27, 28, 30, 31, 32;
(head: 0 to 7 m and deeper)

B) Work of a Pump

A pump has to overcome

- the gravitational forces of the water,
- the friction in the pump and the pipes,
- the inertia of the moving parts of the pump.

C) Possible Reasons for Poor Performance of a Pump

There are many different reasons why a pump is not performing well in a certain situation. It is important to identify the exact reason.

Possible reasons are listed below:

- The pump is of poor quality.

- The pump is of poor design.
- The pump is not suitable for the given situation.
- The pump does not work in its optimal range (e.g., the head is too high after the water table has dropped).
- The pump is not being used properly.
- The pump is not maintained regularly (cleaning, greasing, etc.).
- The pump is unduly exposed to sun, rain, dust, etc.
- The pump is overused.
- The pump was not repaired properly after a break-down.
- Supply of spare parts is difficult because there are too many different types of pumps in the region.

D) Criteria for Selecting the Right Pump

To avoid poor performance, it is important to select the right type of pump for a specific task. The following questions will help you to identify the specifications for the pump you need for a specific purpose. First, answer them all, then check if the proposed pump fulfils these requirements.

1. Which head do you want to pump the water (in metres)?
2. What yield do you require (in m³/h or l/sec)?
3. What type of water should be pumped (clear, sandy or muddy water)?
4. What source should the water be pumped from (hand dug well, borehole, river)?
5. For how long should water be pumped subsequently: How many hours a day; the whole day; sometimes; daily; for how many months?
6. What kind of energy is available and should run the pump (human, animal, diesel, petrol, electricity, etc.)?
7. What kind of spare parts are available and where?
8. What kind of maintenance facilities are necessary and available?
9. What kind of operating skills are necessary and available?
10. Do you require that the pump ensures that the water is not polluted?
11. What level of technology is suitable?
12. Where can you get the required pump from?

12. Where can you get the required pump from?

13. What kind of pump would be accepted by the future users?

14. How much money are you able and ready to invest in the pump (including running and maintenance costs)?

E) Comparison of Different Pumps

In the following table a number of pumps are compared. The necessary information is compiled to answer the questions asked under “D) Criteria for Selecting the Right Pump”. The drawings under F illustrate the different pumps.

COMPARISON OF DIFFERENT PUMPS

Pump	Drawing No.	Source of Energy	Principle of Fluid Transport	Type of Fluid	Lift from Water to Pump	Lift from Pump to Higher Level	Yield in m ³ /hour	Well Ø required	Possibility of Contamination	Costs	Operation and Maintenance	Suitable Areas
unprotected bucket system	1, 5	human, animal	pulling by rope	clean or dirty water	0-50 m	-	0.05-1	large Ø (100 cm)	yes	low	very simple	remote areas
shaduf	2	human	pulling by counterweight	clean or dirty water	0-5 m	-	“	“	“	“	simple	with simple maintenance facilities
protected bucket system	3, 4	“	pulling by rope	clean water	0-10 m	-	“	“	avoidable	“	“	“
chain, rope and washer pump, bucket pump	6, 7, 8	“	“	“	0-10 m	-	2-3	“	“	reasonable	“	“
suction hand pump with piston	9	“	piston, pos. displacement	“	0-7 m	-	2	borehole or large diameter	“	“	reasonable	where maintenance secured
suction hand pump	9	“	“	clean or dirty	0-7 m	-	8	large Ø (100 cm)	yes	“	“	“

for irrigation with piston direct action hand pump	10	“	“	water clean water	0-25 m	-	2	borehole or large diameter	avoidable	“	“	“
piston hand pump	11, 12, 13, 14	“	“	“	0-80 m	only No 14	1	“	“	“	“	“
diaphragm hand pump	19	human	membrane	clean or dirty water	0-7 m	-	10	large Ø (100 cm)	yes	reasonable	simple	where maintenance secured
hydraulic ram	21	water	impulse	clean water	0	60-80 m	depending on ram	not used in wells	avoidable	“	“	in small river with dam
helical rotor pump	22, 23	human, fuel	helical rotor	water	0-30 m	-	depending on pump	large Ø or boreholes	avoidable	high	skilled attention	where fuel and maintenance available
coil pump	26	water	compression of air	clean or dirty water	0	6-7 m	1-2	not used in wells	yes	reasonable	simple	on big rivers (for irrigation)
centrifugal pump	29	fuel	centrifugal	depending on pump	0-7 m	20-30 m	high, depending on pump	borehole or large diameter	avoidable	high	skilled attention	where fuel and maintenance available
submersible pump	30, 31	electrical	“	“	0	8-300 m	“	“	“	“	“	“
jet pump	32	“	centrifugal, ejector	clean water	0-50 m	0-20 m	“	borehole	“	“	“	“

F) Drawings of Different Pump Types

In the following, drawings are given of a number of pumps, compiled as teaching material. They shall give an impression about the diversity of pump types. Some of them will need further explanation by a teacher or further study in the literature (see in the bibliography especially No. 18 from which many pictures were taken). A few pump types are described in more detail in later chapters.

Illustrations are given for the following pumps and water lifting devices:

1. Unprotected Bucket System

1. **Unprotected Bucket System**
2. **Counterweighted Bailer (=Shaduf)**
3. **Protected Bucket System with Trough**
4. **Protected Bucket System with Hose**
5. **Bailer for Boreholes**
6. **Bucket Pump**
7. **Chain and Washer Pump**
8. **Rope and Washer Pump**
9. **Suction Hand Pump with Piston**
10. **Direct Action Hand Pump with Cylinder**
11. **Piston Hand Pump with Chain Link**
12. **Piston Hand Pump with Uganda Type Handle**
13. **Piston Hand Pump with Fly-Wheel**
14. **Force Pump**
15. **Wind Pump**
16. **Vergnet or Mengin Pump**
17. **Petro Pump**
18. **Blair Pump**
19. **Diaphragm Hand Pump**
20. **Diaphragm Engine Pump**
21. **Hydraulic Ram**
22. **Helical Rotor Hand Pump**
23. **Helical Rotor Engine Pump**
24. **Archimedean Water Screw**
25. **Water Wheel**
26. **Coil Pump**
27. **Rotary Pump**
28. **Piston Engine Pump**
29. **Centrifugal Pump**
30. **Submersible Pump for Dirty Water**
31. **Submersible Pump for Clean Water**
32. **Jet Pump**

1. Unprotected Bucket System

rope and bucket alone, or with wooden roller, or pulley, or windlass.

Rope and Bucket alone:

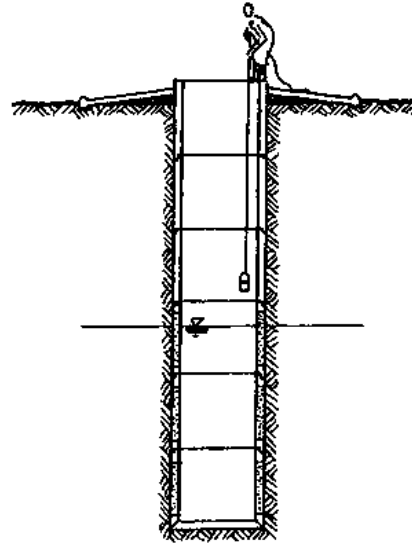

Wooden Rollers:

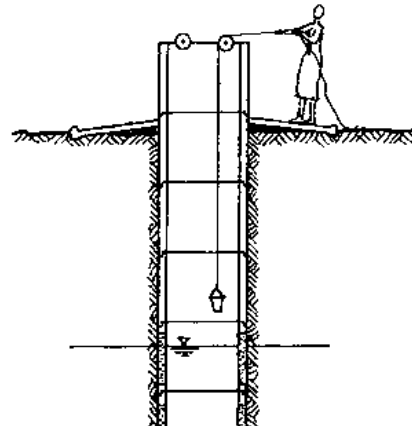

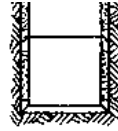

Pulley:

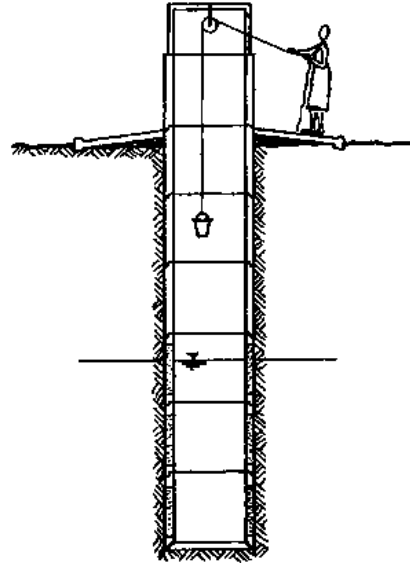

Windlass:

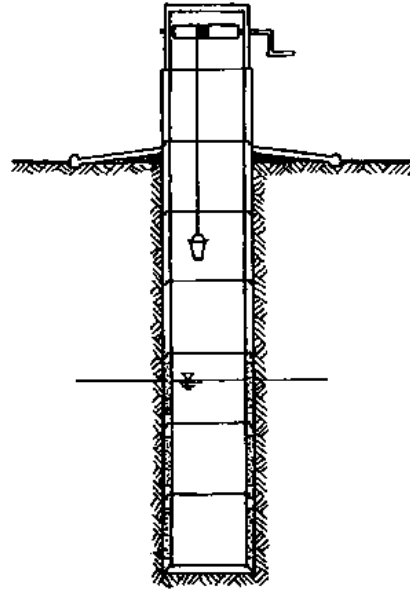

SCALE 1:80

2. Counterweighted Bailer (= Shaduf)

with scaffold, counterbalance weigh, rope and bucket.

CROSS-SECTION

SIDE-VIEW

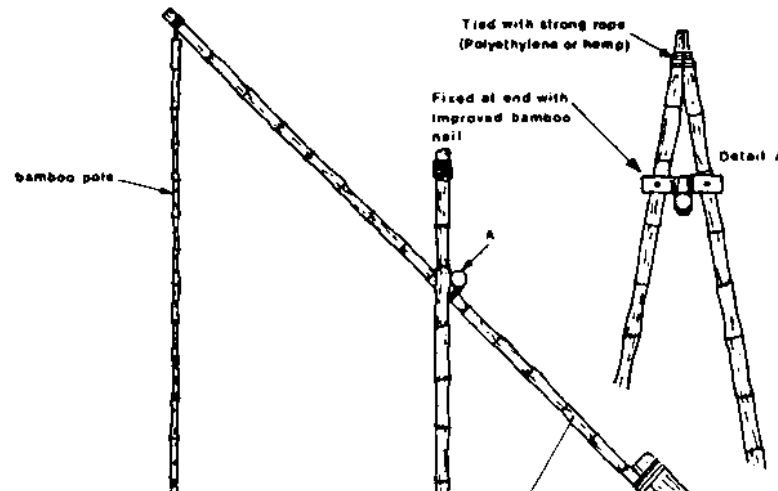

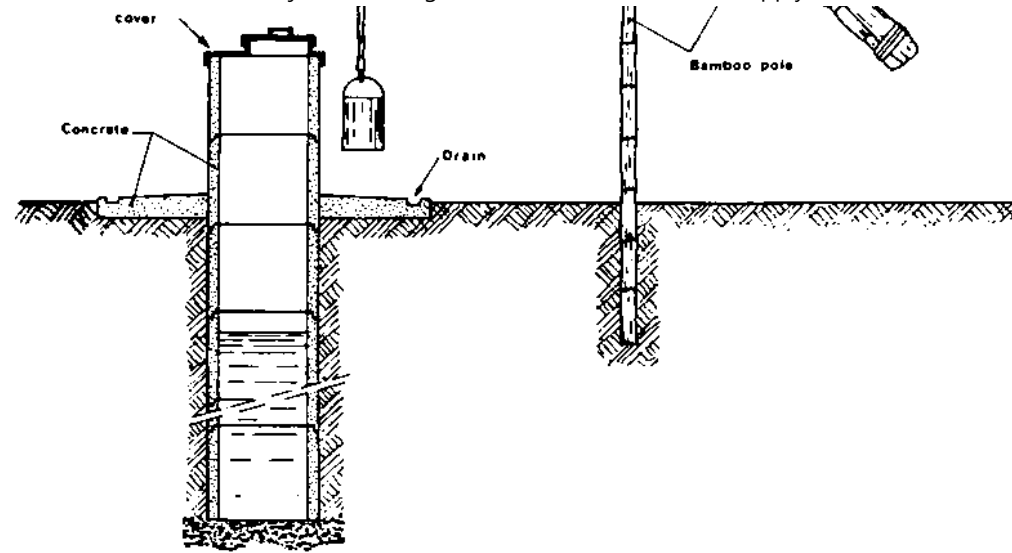

LAYOUT PLAN

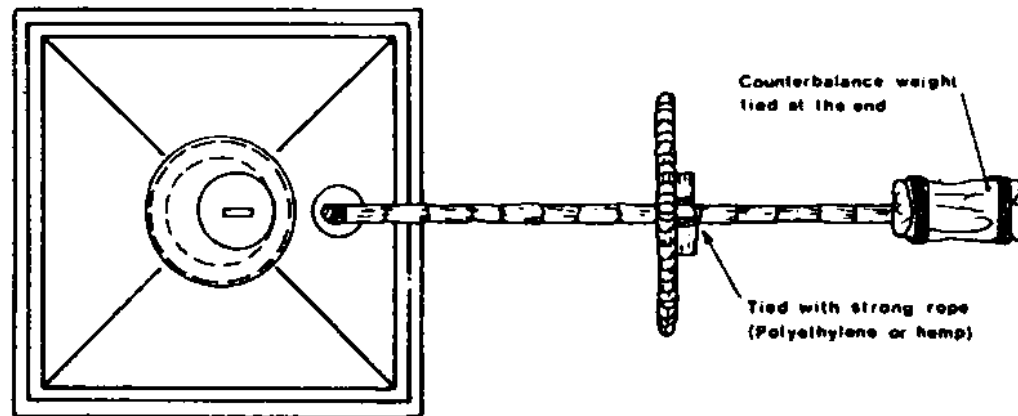

3. Protected Bucket System with Trough

with windlass, rope, bucket, trough, outlet, and protection against contamination.

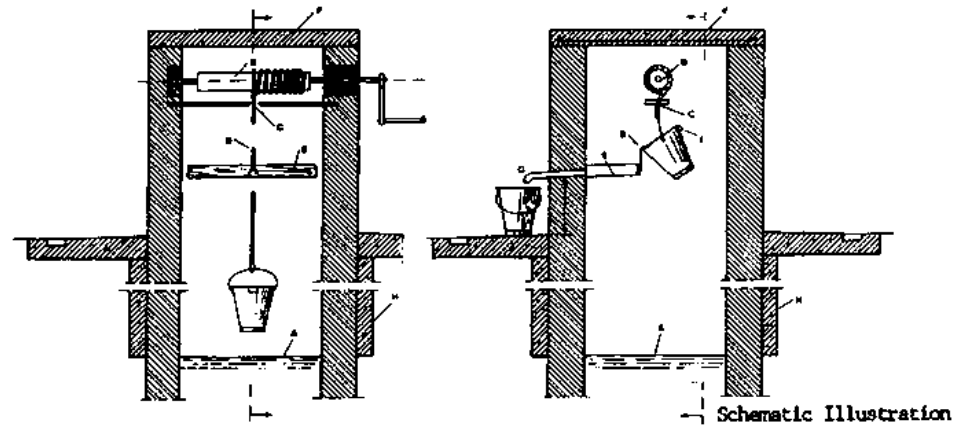

- | | | |
|-------------------------|--------------------------------------|---|
| A = water level in well | E = trough | I = weight attached to top side of bucket to make it tilt when lowered onto water surface |
| B = windlass | F = tight cover, removable | |
| C = guide hole for rope | G = discharge opening | |
| D = stop hook | H = compacted clay or concrete grout | |

4. Protected Bucket System with Hose

with windlass, rope, bucket, hose, outlet and protection against contamination.

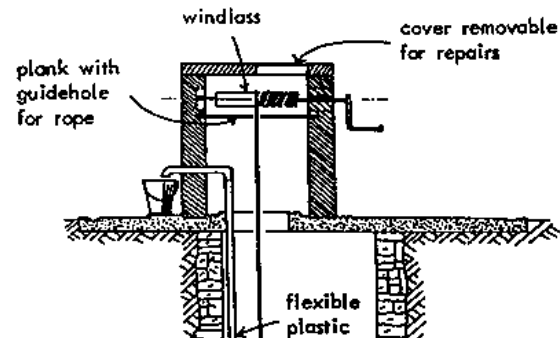

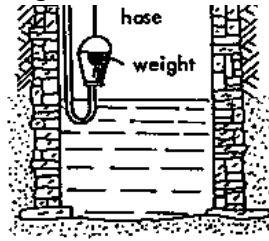

Schematic Illustration

5. Bailer for Boreholes with windlass, chain, bailer and holder to release the valve; see also 8.13/5.

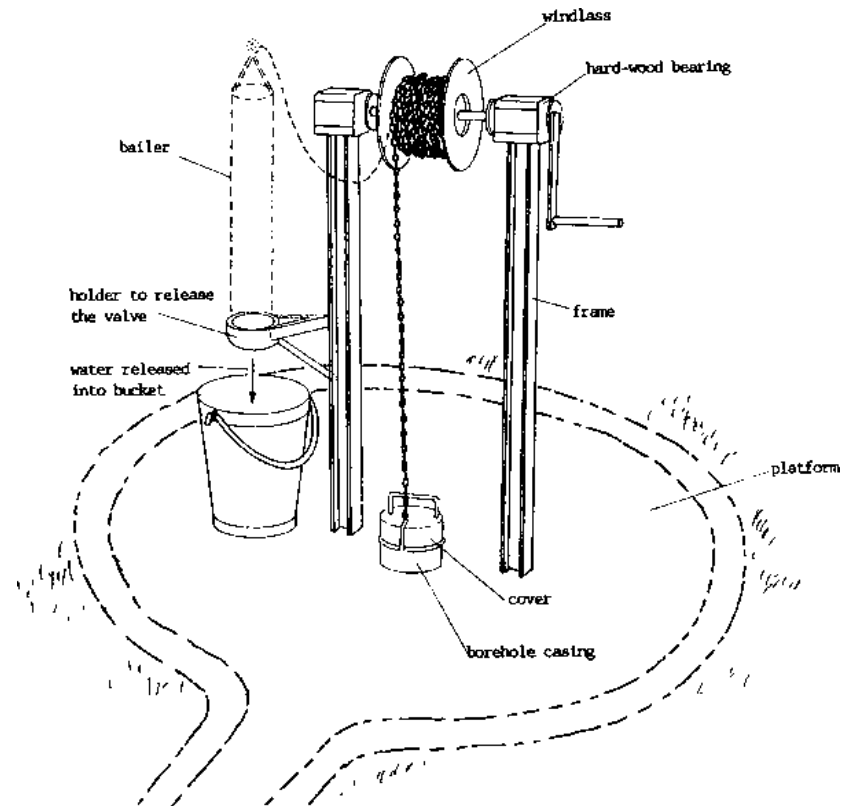

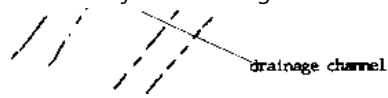

6. Bucket Pump with windlass, buckets attached to rope, outlet and protection against contamination.

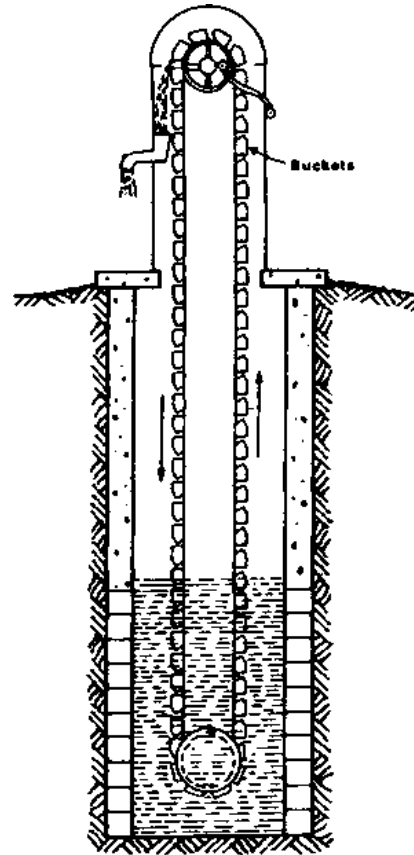

7. Chain and Washer Pump with windlass, riser main pipe, rubber washers, water tank, outlet, and protection against contamination.

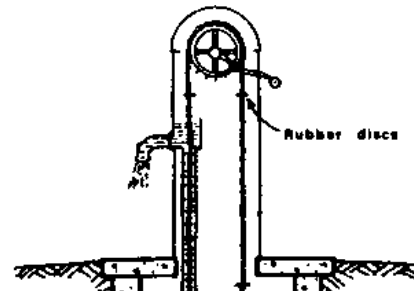

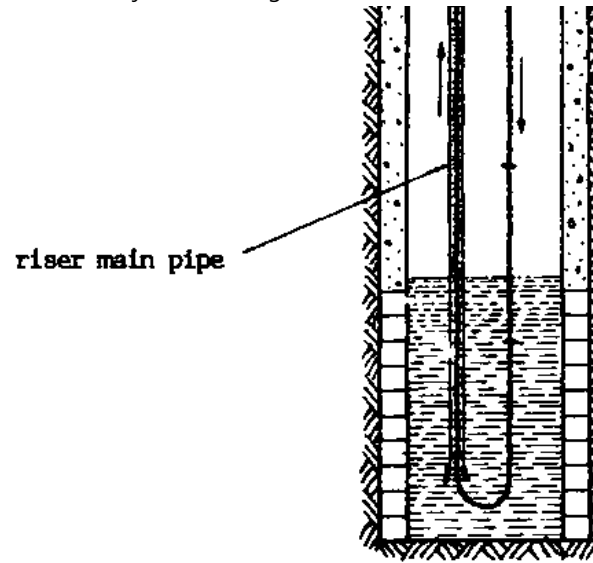

8. Rope and Washer Pump with windlass, riser main pipe, rope and rubber washers, basin from chicken wire and cement mortar, outlet, and protection against contamination.

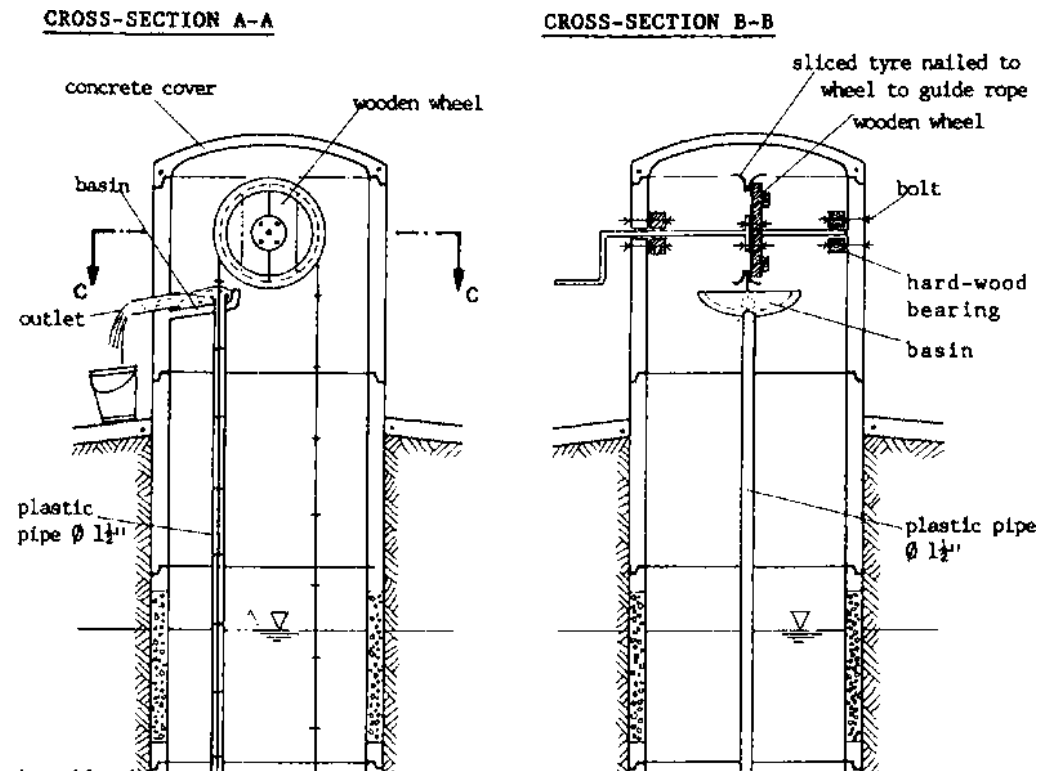

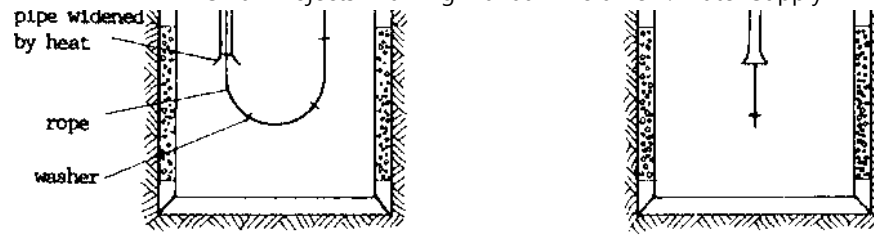

LAYOUT PLAN C-C

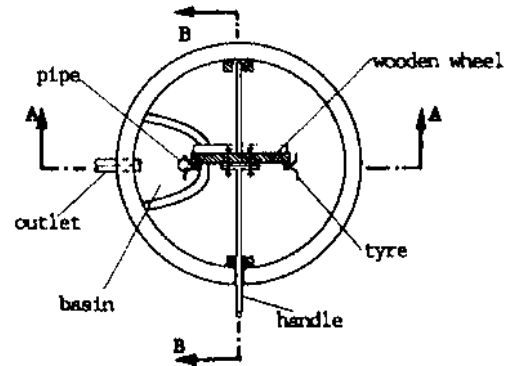

DETAIL: ROPE AND WASHER

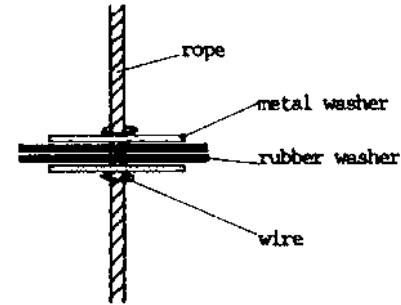

9. Suction Hand Pump with Piston with riser main pipe, two valves in the pump body, plunger, outlet, and handle; with all moving parts above ground; for wells up to 7 m.

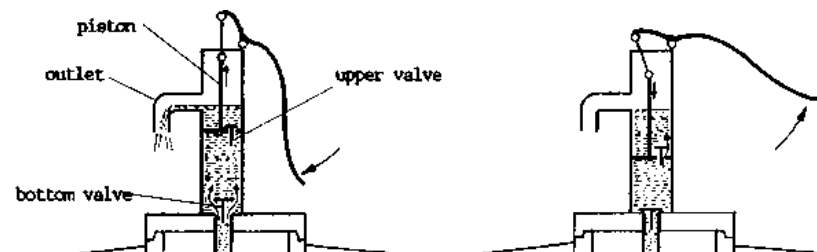

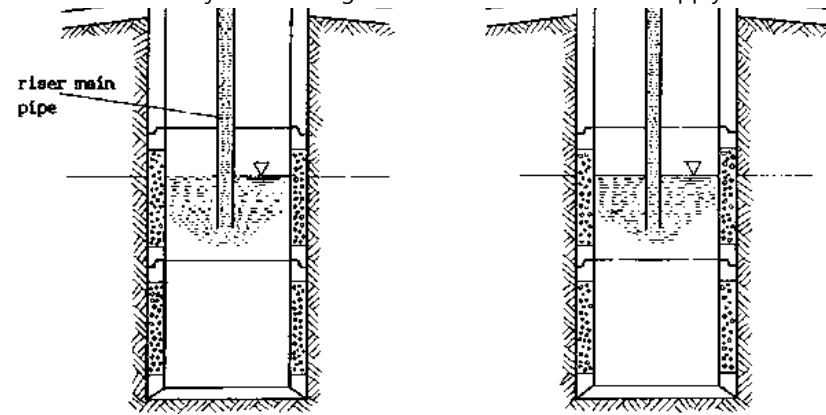

Schematic Illustration

10. Direct Action Hand Pump with Cylinder with riser main pipe, rod, and handle directly connected to the rod; for wells up to 30 m.

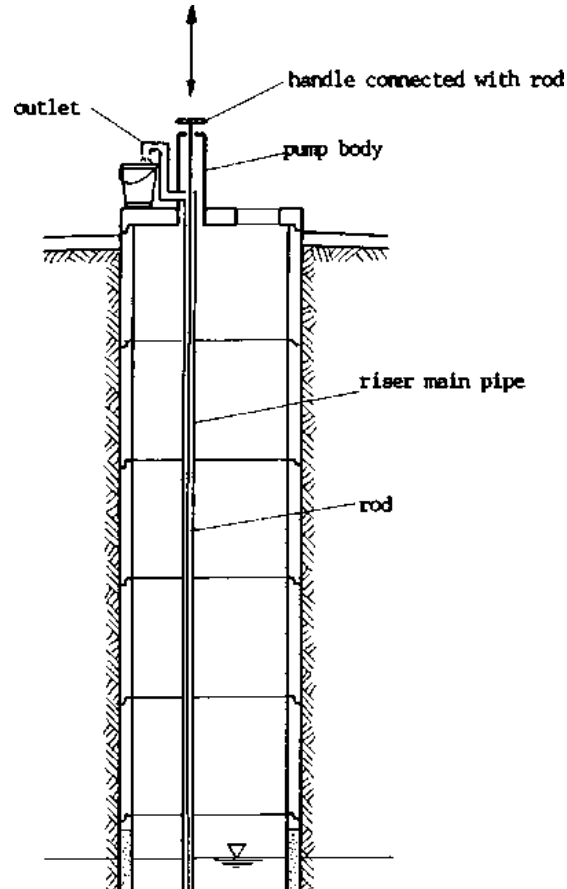

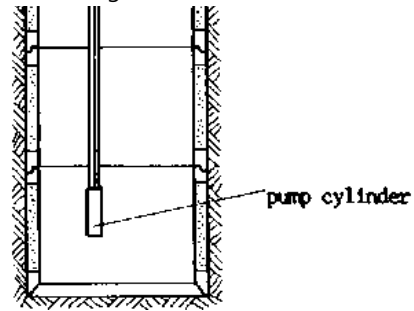

Schematic Illustration

11. Piston Hand Pump with Chain Link (India Mark II) with cylinder, riser main pipe, rod, water tank, outlet, chain link, and handle; for deep wells; see also 8.19, 8.31, 8.33.

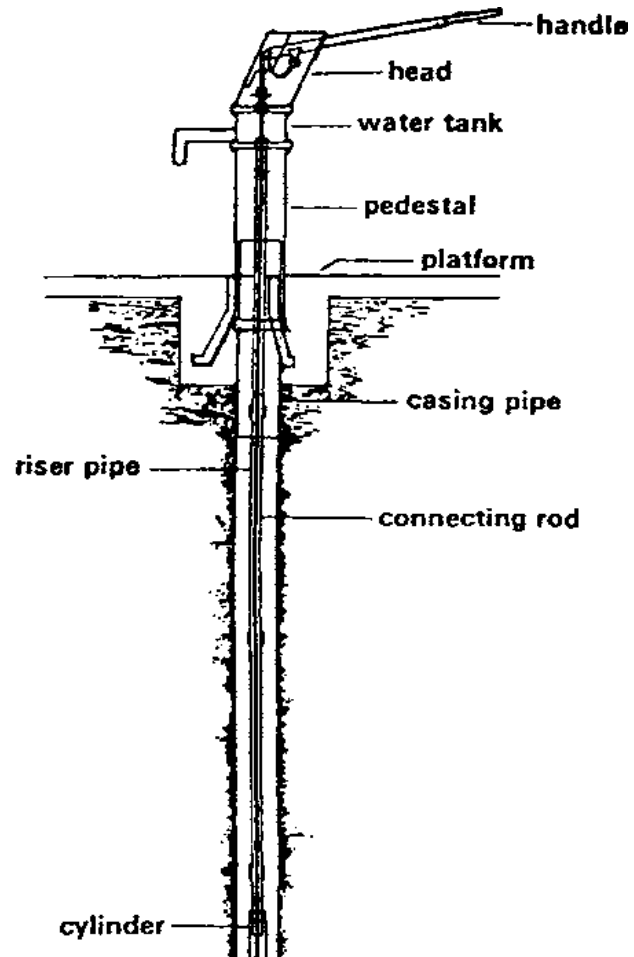

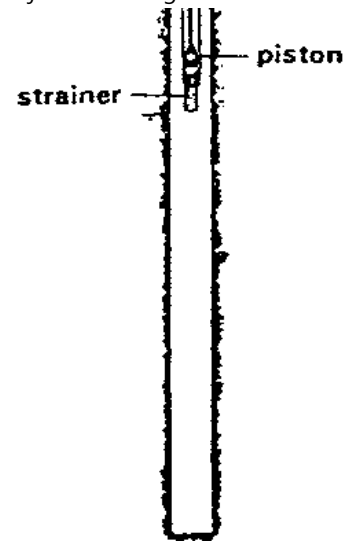

12. Piston Hand Pump with Uganda Type Handle with cylinder, riser main pipe, rod, outlet, and wooden handle; for deep wells.

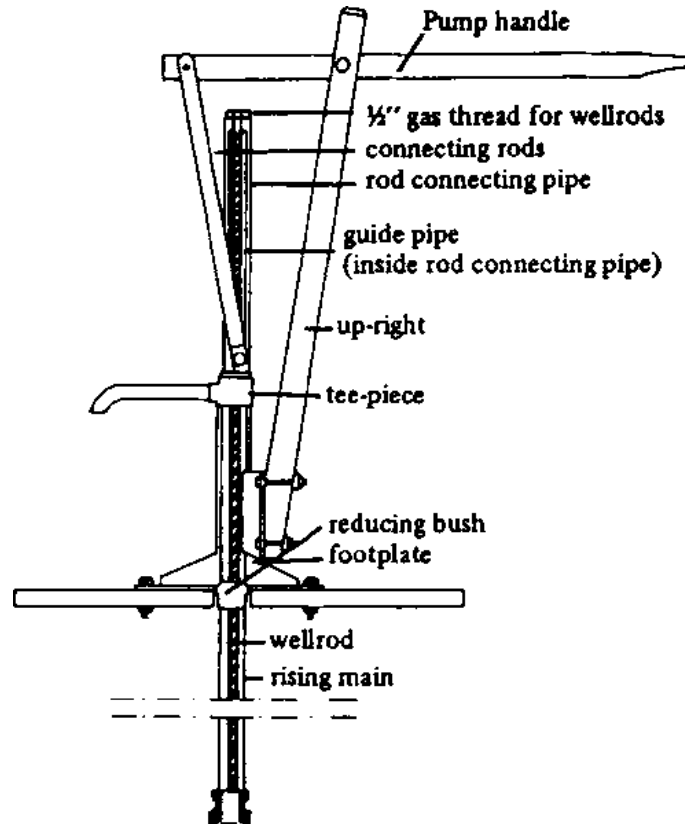

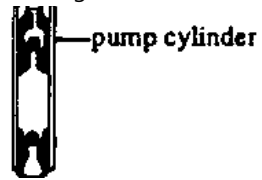

13. **Piston Hand Pump with Fly-Wheel** with cylinder, riser main pipe, rod, outlet, fly-wheel moving the rod by rotary crank (transmitting the rotation of the fly-wheel into up-and-down movement of the rod); for deep wells.

Crank Mechanism:

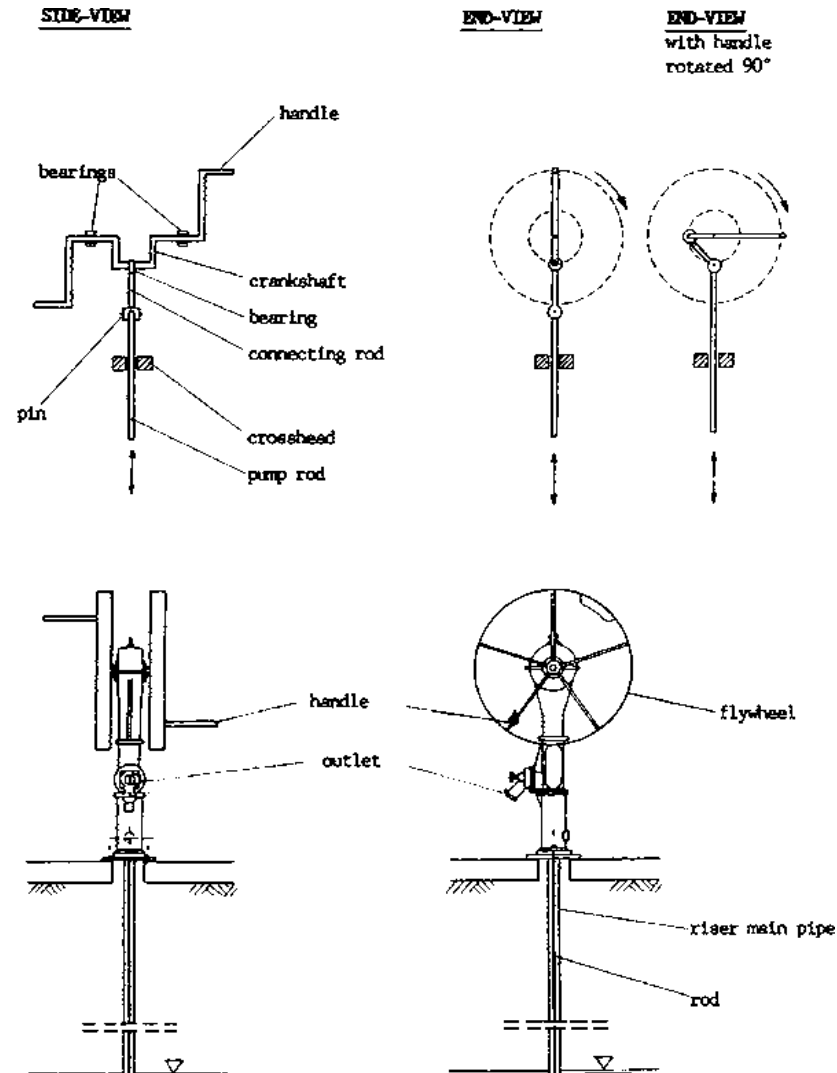



14. Force Pump either suction type (like No. 9) or with cylinder (like No. 11) for pumping water from a well to an elevated tank.

Force Pump Suction Type

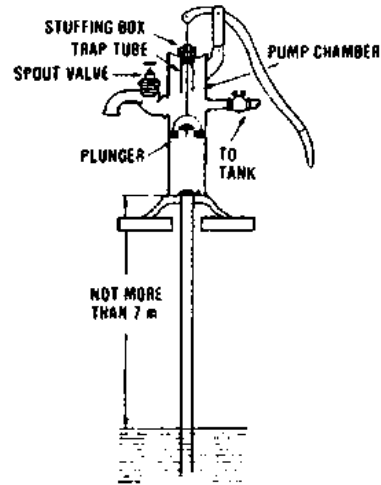

Force Pump with Cylinder

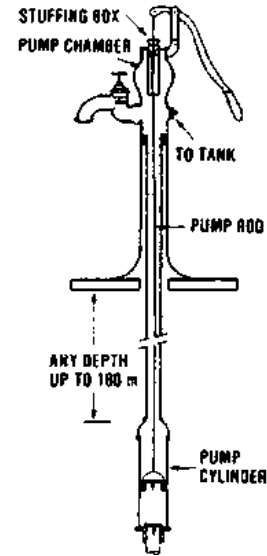

15. Wind Pump with cylinder, riser main pipe, rod, connection to water tank, and wind-wheel moving the rod by rotary crank; for deep wells.

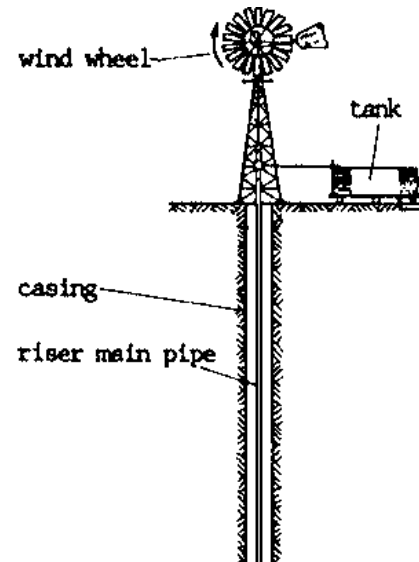

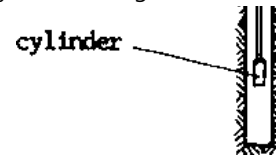

16. Vergnet or Mengin Pump with pilot cylinder, pilot pipe, rigid cylinder (with three valves), discharge pipe and outlet, foot-operated.

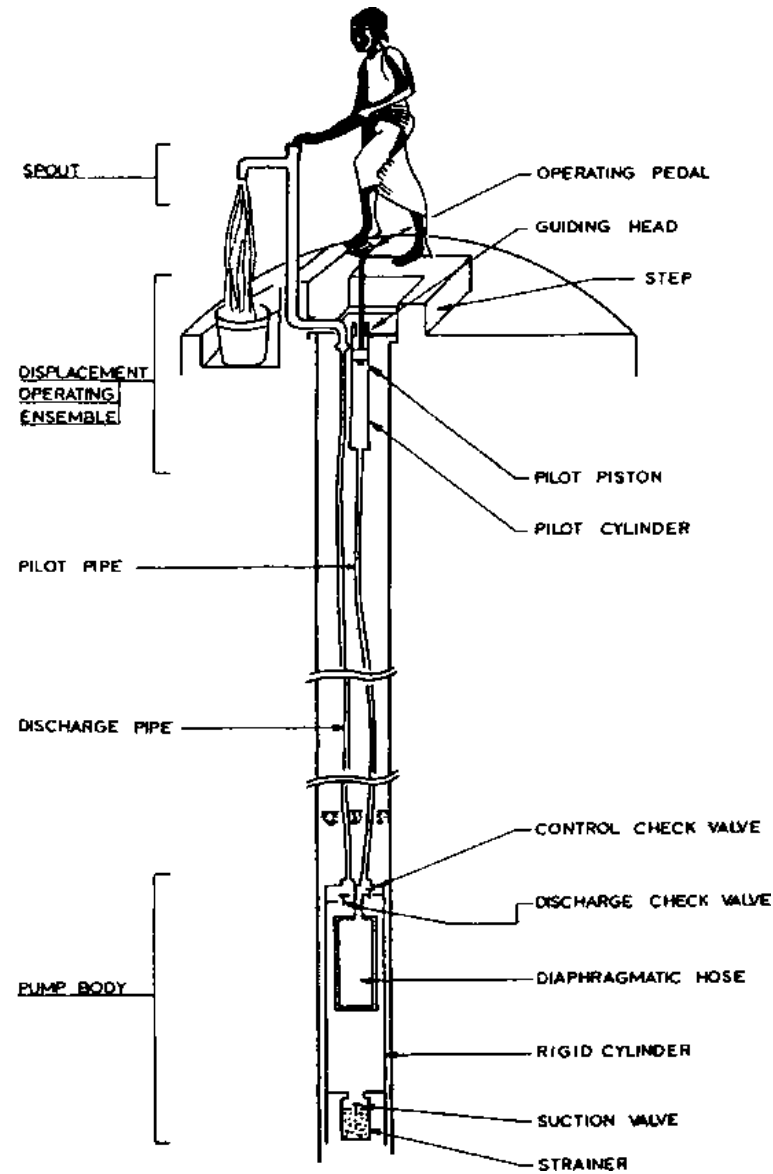

17. Retac Pump with counterweight holding the lower end of pump in position, a pumping base from flexible membrane creating the suction, two valves, rigid

17. **Petro Pump** with counterweight holding the lower end of pump in position, a pumping nose from flexible membrane creating the suction, two valves, riser main pipe moving up and down, outlet moving up and down, and handle.

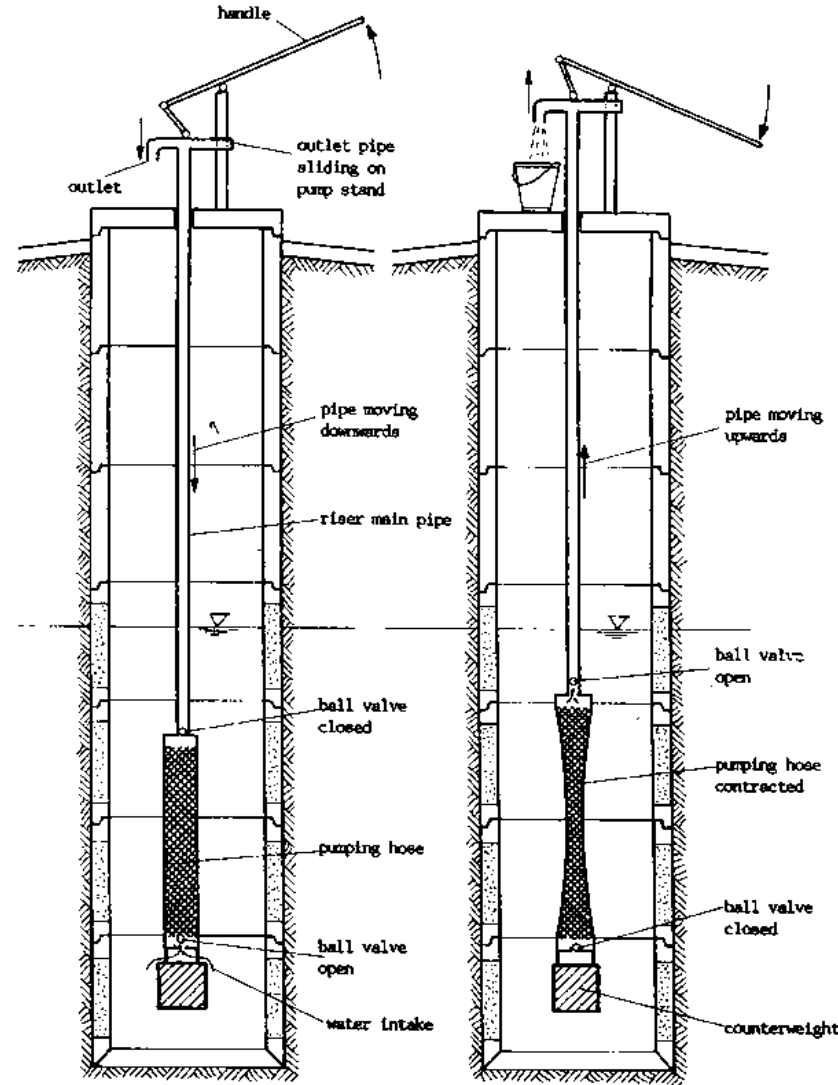

Schematic Illustration

18. **Blair Pump** with stationary cylinder, foot valve, riser main pipe which is at the same time pump rod and plunger with a valve, with bent end of riser main pipe as outlet, and handles.



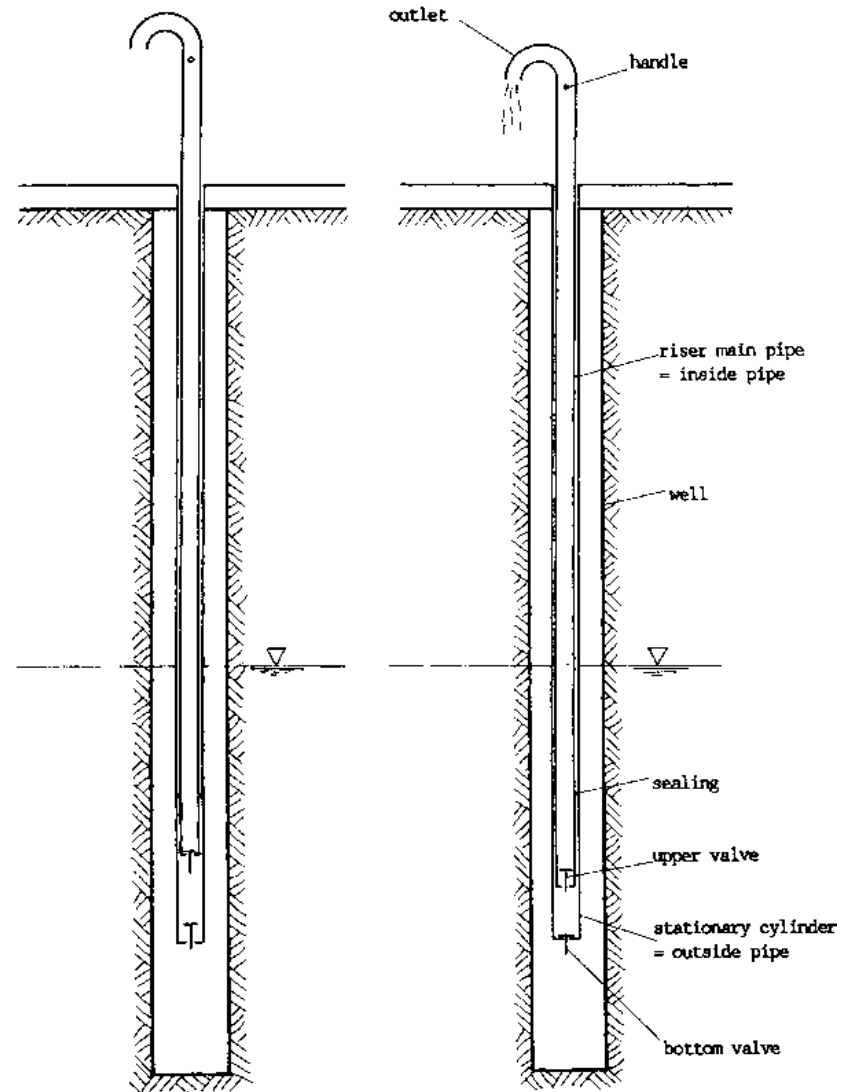

Schematic Illustration

19. Diaphragm Hand Pump with foot valve (= suction sustainer), suction hose, pump body with two valves, rubber membrane (= diaphragm), handle, outlet; for wells up to 7 m; see also 8.26 for operation.

ISOMETRIC VIEW



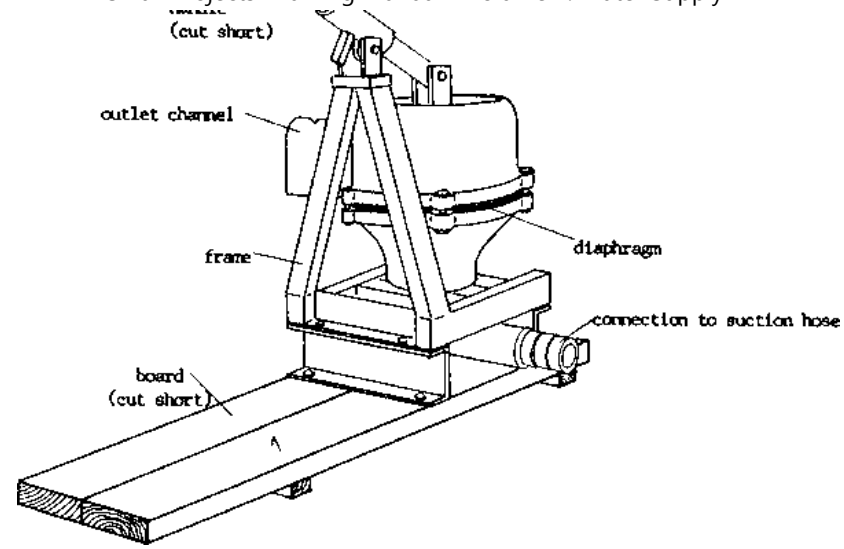

CROSS-SECTION (not in operation)

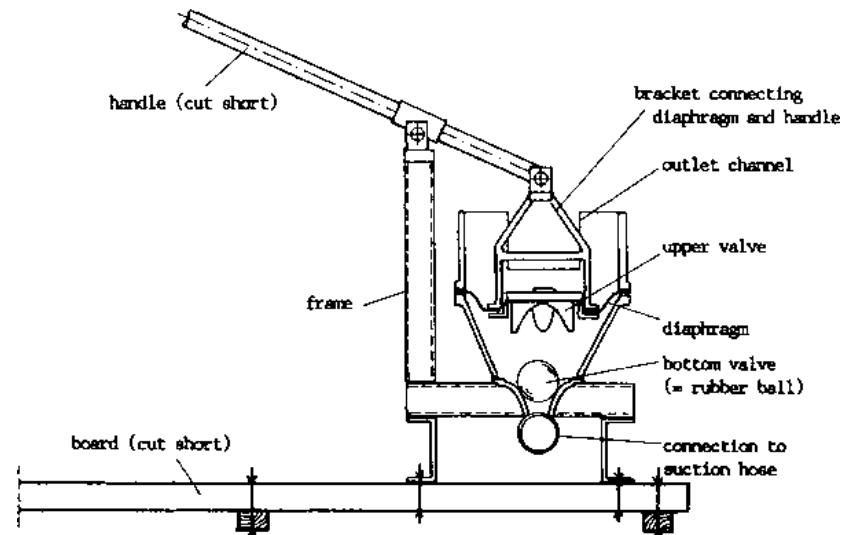

20. **Diaphragm Engine Pump** with foot valve, suction hose, pump body, membrane moved by engine; for wells up to 7 m.

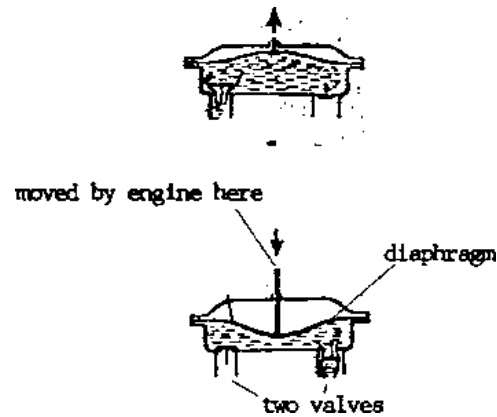

21. **Hydraulic Ram** with water storage higher than the ram, supply pipe (= drive pipe), check valve, air chamber, discharge pipe (= delivery pipe), return spring, waste valve, outlet for waste water; requires a constant flow from the storage and pumps a small part of this flow to a higher level.

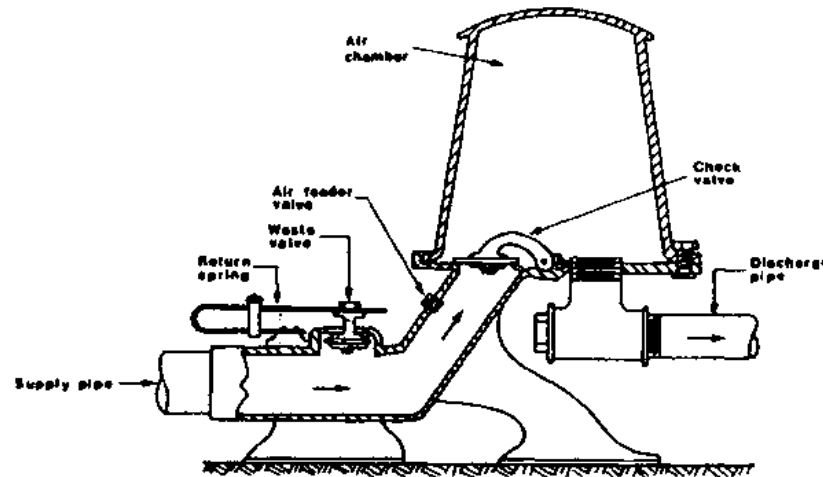
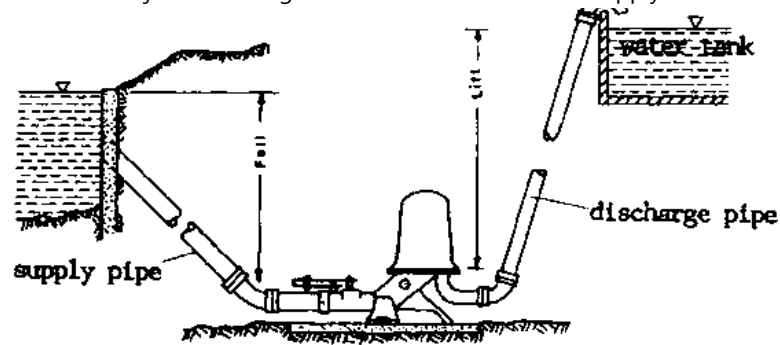

22. Helical Rotor Pump, Hand-Operated with check valve, helical rotor in a fixed stator, riser main pipe, drive shaft (= rod transmitting the rotation from the pump head to the helical rotor), outlet, gears (transmitting the rotation of the handles into rotation of the drive shaft), gear box and handles; for deep wells.

CROSS-SECTION

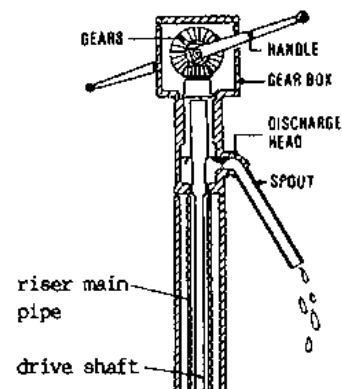

CUT-AWAY SIDE-VIEW

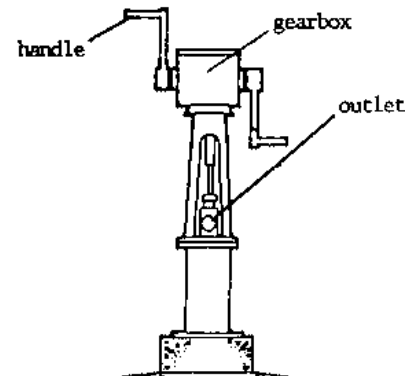

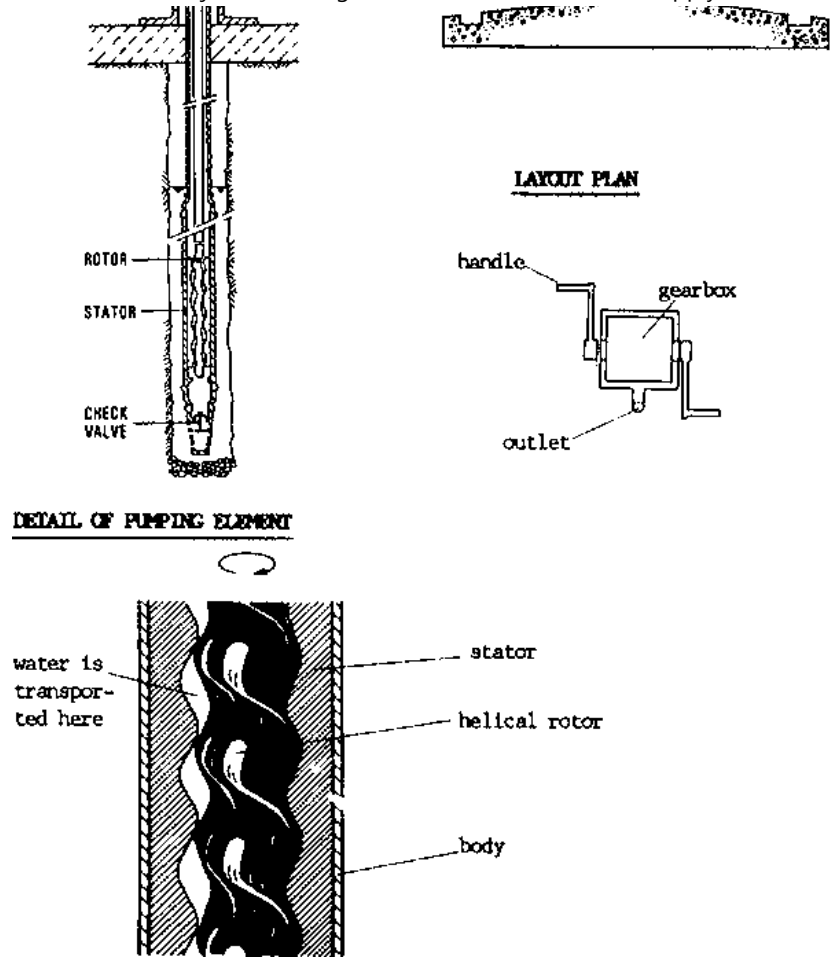

Taken from leaflet, Mono Pump

23. Helical Rotor Pump, Engine-Driven with helical rotor in a fixed stator, riser main pipe, gears, gear box, engine; for deep wells.

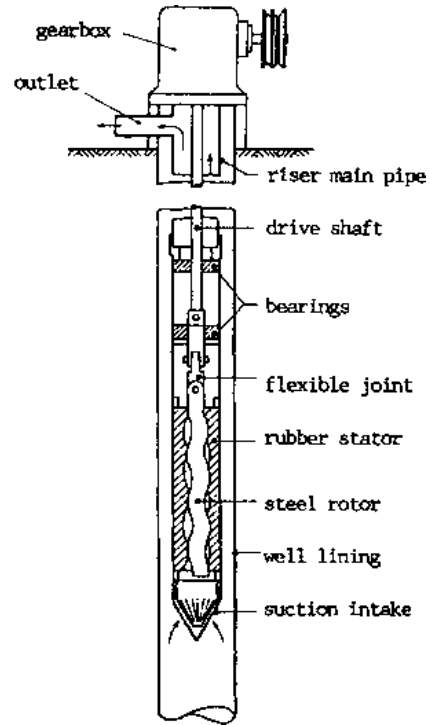

24. Archimedean Water Screw with an inclined rotor rotating in a fitting bed (in the shape of a half cylinder), engine driven; for water or mud

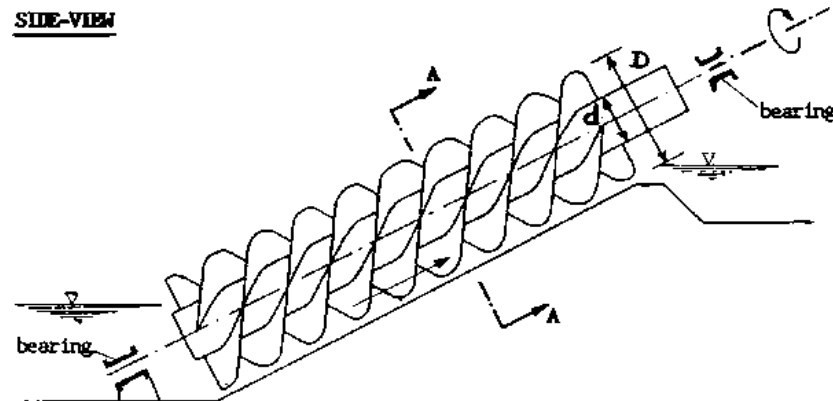

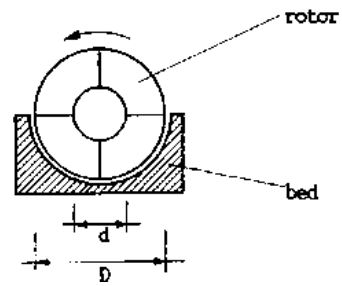
CROSS-SECTION A-A

25. **Water Wheel** with a rotating water wheel lifting the water; engine driven; for low lifts.

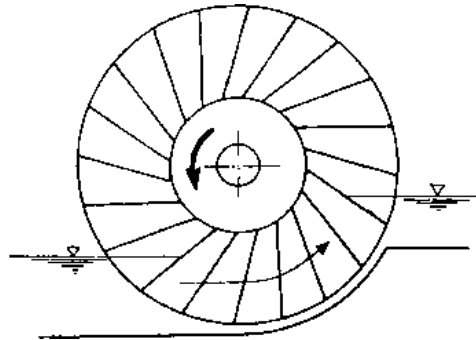

26. **Coil Pump** with plastic pipes coiled around a frame work rotating by the action of the river current on paddles; pump floating on drums; delivery hose to elevated tank; for small lifts from a river.

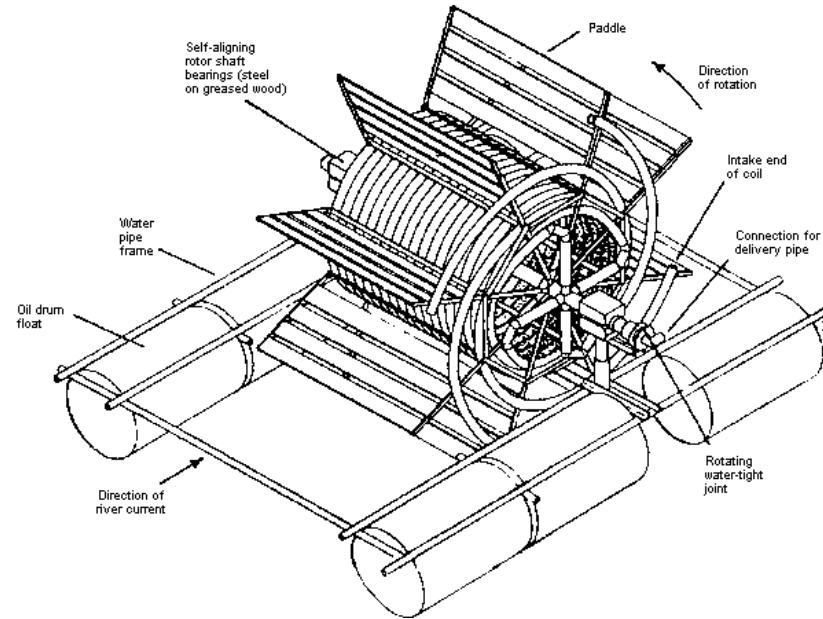

27. Rotary Pump with rotors within a fixed casing (= stator).

CROSS-SECTION

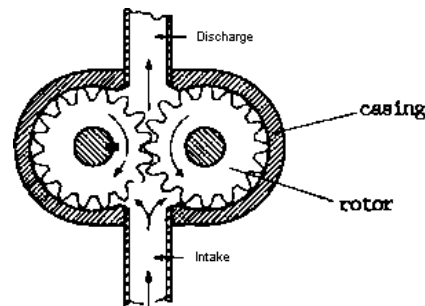

28. Piston Pump with a piston moved by an engine to create suction for pumping.

CROSS-SECTION in two stages of operation

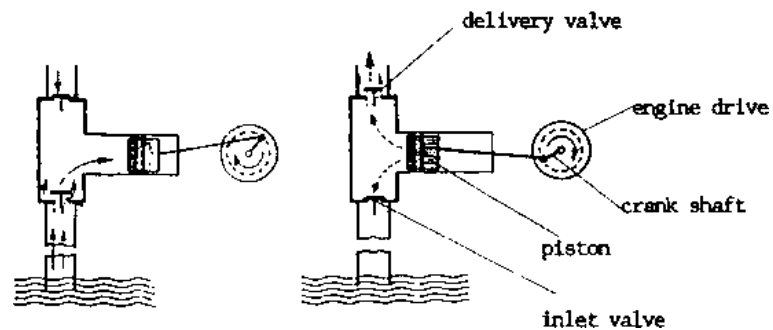

29. **Centrifugal Pump** installed on ground level; with rotating impeller within a casing, suction pipe and delivery pipe; for suction heads up to 7 m and delivery heads up to 30 m; see also 8.27

CROSS-SECTION

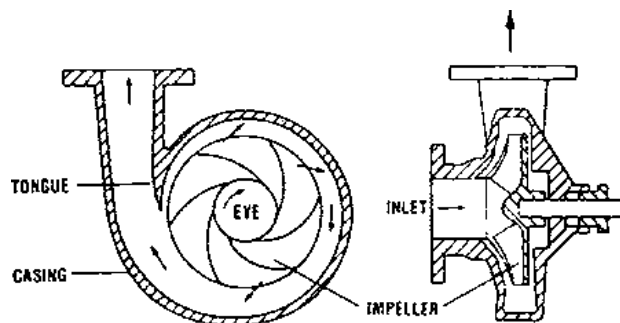

30. **Submersible Pump for Dirty Water** with electrical motor and pump within a pump body submersed into the water, with power supply supplied by electrical cable, and a delivery hose; for deep wells; see also 8.28.

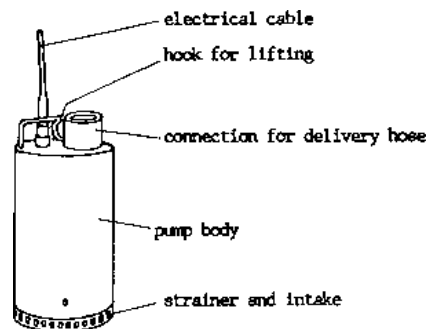

31. **Submersible Pump for Clean Water** used in boreholes; with slim shape especially designed for boreholes; for clean and not salty water and deep wells.

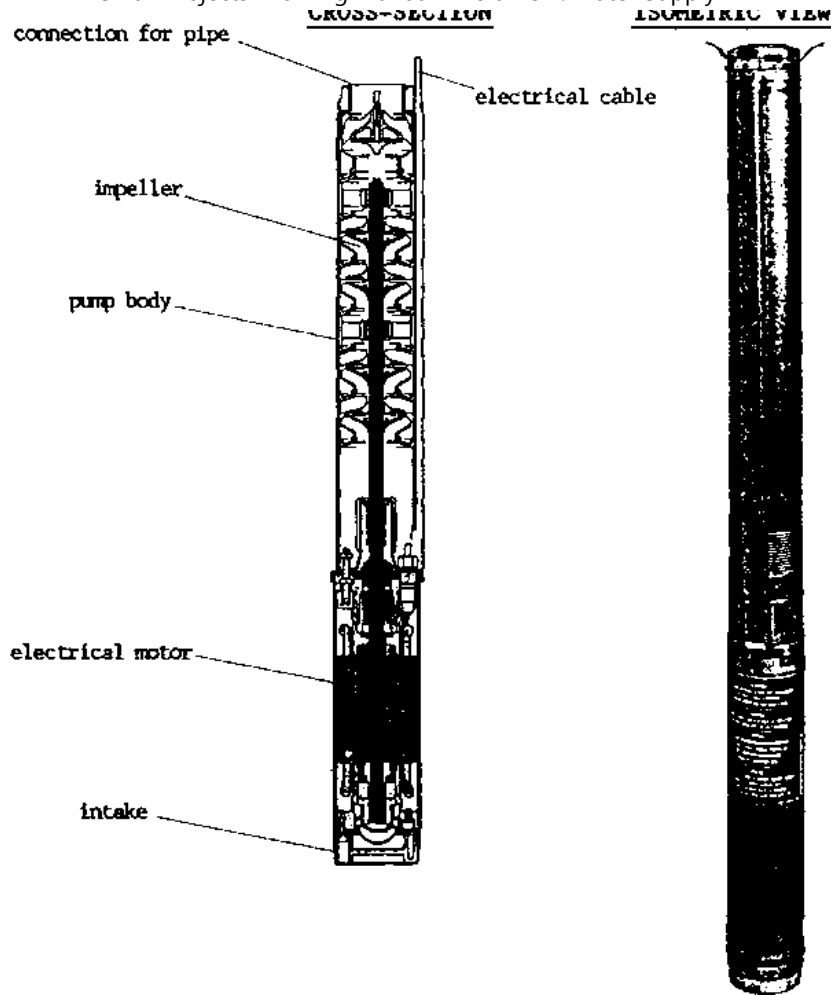

Taken from leaflet, Homa Pump

32. Jet Pump with centrifugal pump installed on ground level, pressure pipe, jet body with jet nozzle, mixing chamber, return pipe, delivery pipe, and elevated tank; pumps water into the well through pressure pipe, the flow speed is increased by the nozzle and, thus, water sucked in from the well; the water moves up through the larger diameter return pipe to the pump; a part is delivered to the tank, the other part is pumped again into the pressure pipe, etc.; no moving parts in the well

CUT-AWAY SIDE-VIEW

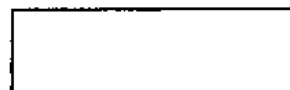

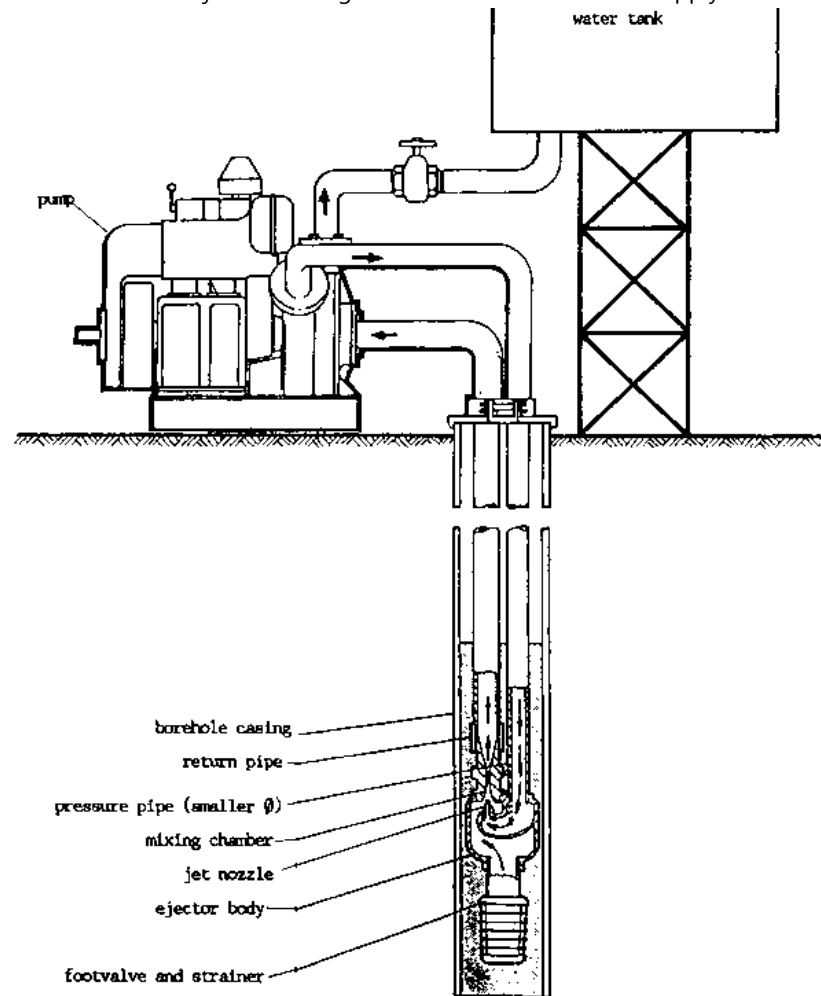

Schematic Illustration

Taken from leaflet, Jet Pump

8.25. Dewatering Wells during Construction

When digging below the water table, dewatering of the well becomes necessary in order to enable the technicians to continue the work. Dewatering can be done by the following different means. Concerning the yields of different pumps see 8.34 or 8.24/4f.

A) Dewatering with a Bucket, Rope and Pulley

Small amounts of water can be extracted with the bucket used for excavating the soil.

B) Dewatering with a Jet Pump, Rope and Pulley

B) Dewatering with Jerrycan, Rope and Pulley

A jerrycan, cut open at its top, pulls in one go twice as much as a bucket, and is light-weight. Therefore, it is quite suitable for dewatering wells during construction by hand. However, many people are required. They have to work in shifts. Two jerrycans can be used parallel on two pulleys.

C) Dewatering with a Large Bucket, Steel Cable, Pulley and Winch

A large bucket, both for dewatering and lifting excavated soil, can be manufactured locally from a metal drum. Cut off one third of the drum and reinforce it with three rings of flat iron. A reinforcement rod \varnothing 10 mm must go all around the bucket to bear the weight and to serve as a handle.

Such a large bucket can be filled half way with soil, or completely with water. It is to be pulled by steel cable and winch. The method empties a well quickly, but requires a number of people to work in shifts as the work is very heavy.

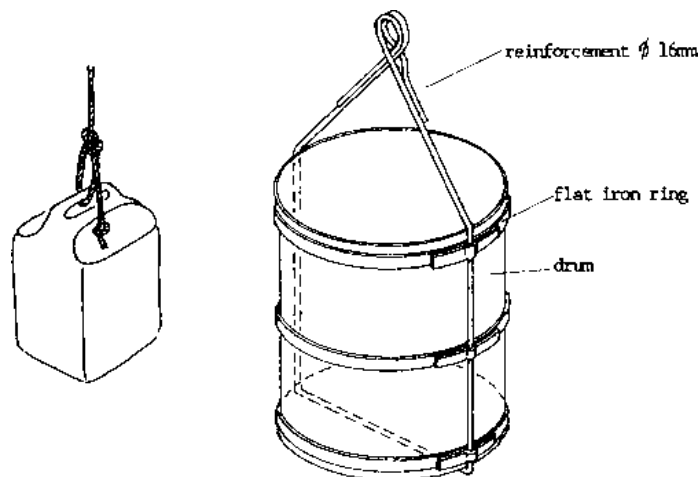
**D) Dewatering with Hand-Operated Diaphragm Pump**

The method is described in detail in 8.26. It can be used only for wells up to 8 m deep, because a diaphragm pump is a suction pump. It requires heavy manual labour, but no fuel, few spare parts and little skill. If the yield of the well is not extremely high, this is a very good method for dewatering a well.

E) Dewatering with a Fuel Powered Suction Pump

The method is described in detail in 8.27. It can be used only for wells up to 8 m deep. It requires fuel, spare parts and skilled labour. The method is appropriate if the yield of the well is very high.

F) Dewatering with Submersible Pump

The method is described in detail in 8.28. It can be used for deep wells, too, depending on the pump selected. It requires a transportable generator, fuel, spare parts, and skilled labour. The yield is normally less than for fuel powered suction pumps. The method is suitable if dewatering by hand becomes too tiresome, especially in deep wells.

G) Selecting the Suitable Dewatering Method

G) Selecting the Suitable Dewatering Method

The method suitable for a particular well has to be selected according to the available manpower and equipment. Sometimes, two or three of the above methods can be used at the same time (= in parallel = simultaneously) or one after another (= consecutively).

Often, the dewatering facilities determine how deep a well can be dug into the water table. If the water returns into the well more quickly than you can dewater it with the available facilities, digging cannot be continued any more.

It is very important to dig as deep into the water table as possible in order to have some reserve for dry years. With careful planning you can reach the maximum depth possible with the given facilities:

1. Plan the work so that you combine all available people and dewatering facilities. Work overtime for a short period until digging and lining below the water table are finished.

An example for bad planning would be: You start dewatering on Friday morning. Up to 14.30, the end of the working hours, you have just managed to empty the well and the actual work could start. During Saturday and Sunday, the well fills up again. On Monday, you again dewater until 14.30, and stop work. On Tuesday, you dewater until 13.30 and dig for one hour. On Wednesday, you dewater until 13.30 and dig for one hour... - with completely demoralized staff.

2. Keep careful record of all your activities including the time, water table, number of pumps, buckets, etc. used. Keep track of how quickly the water returns into the well over night (how many cm per hour).
3. Plan the work so that digging into the water table will take place at the end of the dry season when the water table is at its lowest.

8.26. Diaphragm Pumps

Diaphragm pumps suck up the water through up-and-down movement of a flexible rubber membrane called a diaphragm.

A) Types of Diaphragm Pumps

Diaphragm pumps can be differentiated according to the type of energy which drives them:

1. Engine driven diaphragm pumps pump very high yields and are not discussed here.
2. Hand operated diaphragm pumps are designed for irrigation purposes in order to lift a big amount of water with a small head. This type of pump is also very suitable for dewatering shallow wells during construction and will be discussed in the following.

B) Range of Use

Being a suction pump, the possible lift of a diaphragm pump is limited to 8 m.

C) Elements of a Pumping System with a Diaphragm Pump

A pumping system with a diaphragm pump consists of the following elements:

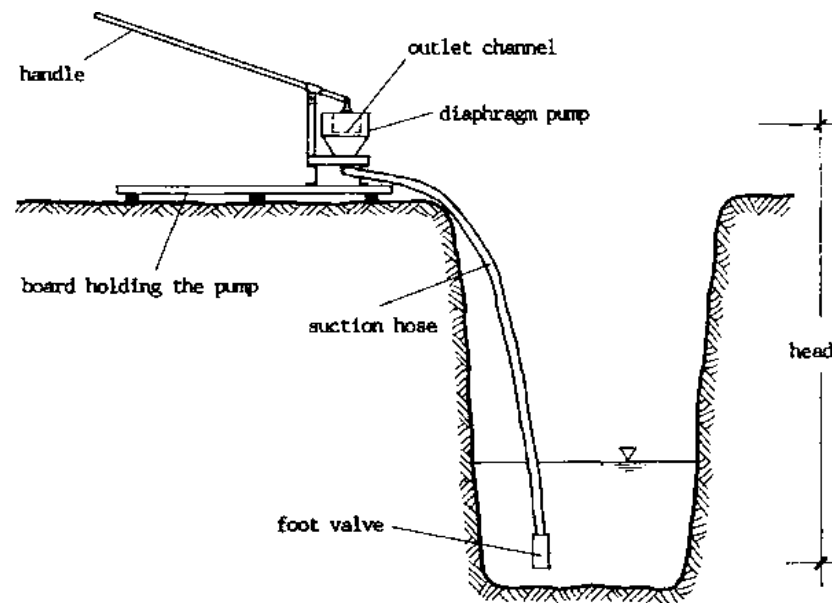

D) Description of the Diaphragm Pump

A diaphragm pump consists of a metal body holding the flexible rubber membrane, the diaphragm. The membrane has a round opening in the middle, reinforced with a steel ring. The ring is connected to the handle and also holds the upper valve. The bottom valve, made of a rubber ball, is placed at the inlet of the suction pipe.

The operation of a diaphragm pump has two distinct and alternative phases:

1. Phase

- The handle moves downwards.
- The membrane moves upwards.
- The upper valve closes by its weight.
- The membrane creates suction and opens the bottom valve.
- Water is sucked in through the suction pipe.



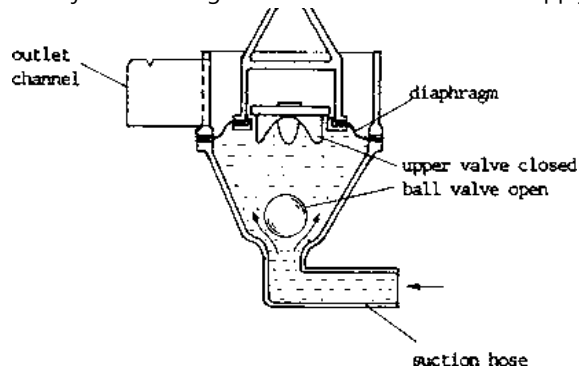

Schematic Illustration Diaphragm assembly turned by 90° for clarity; see also 8.24/22.

2. Phase

- The handle moves upwards.
- The membrane moves downwards.
- The backflow of water closes the bottom valve.
- The water wants to escape and opens the top valve.
- The water is delivered in an open outlet.
- The water in the suction hose does not move.

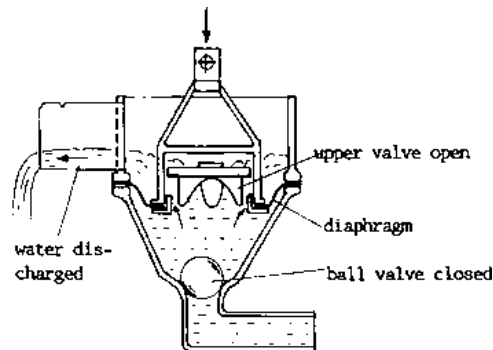

The two valves open and close alternately and, thus, the water is lifted in steps (not continuously). The foot valve at the bottom of the suction hose (the third valve!) is indispensable. It allows the water to be primed, i.e. to be gradually lifted until the hose is full. The foot valve also makes it possible to rest during pumping without having to prime all over again.

E) Advantages and Disadvantages

The advantages of a hand operated diaphragm pump are:

- It is very simple.

- It is sturdy (= strong, not easily damaged).
- Its operation is very simple.
- It does not require fuel.
- The yield is high.
- It can pump sandy water because there are no sensitive parts which can wear out quickly.

The disadvantages are:

- The pump can only pump up to 8 m depth.
- Pumping is hard work and requires enough people to work in shifts.
- The suction hose can wear out quickly.
- The membrane needs to be replaced from time to time.

F) Operation of a Diaphragm Pump

The operation of a diaphragm pump is extremely simple:

- Assemble pump, suction hose and foot valve.
- Pump.

However, take care of the following points:

- The pump must be fixed on a board of 2 pieces of timber 2" × 8", 2 m long. The board must stand on level and stable ground and should not move.
- Handle the suction hose with great care to avoid damage. Do not pull it over the rough edge of the well. The suction hose must be airtight (without the slightest hole), otherwise, the pump cannot suck.
- Tighten all bolts firmly.
- Two or three people can pump, but they should move the handle from the highest possible to the lowest possible position in an even rhythm. They should not jump with the handle.
- After work, do not leave the membrane exposed to sun, but cover it. This prolongs its lifetime.

8.27 Fuel-Powered Suction Pumps

The most common type of fuel-powered suction pump is a centrifugal pump with suction and discharge hose or pipe.

A) Types of Fuel-Powered Suction Pumps (Centrifugal Pumps)

Suction pumps can use diesel or petrol as fuel:

1. Diesel powered suction pumps are heavier and, therefore, more suitable for permanent installation. They will not be discussed here.
2. Petrol powered suction pumps are usually light-weight and, therefore, transportable and very suitable for dewatering wells during construction. They will be discussed in the following with the HONDA WA 30 X as an example.

B) Range of Use

Fuel powered suction pumps are, like all suction pumps, limited to a depth of 8 m.

C) Elements of a Pumping System with a Petrol Suction Pump

A pumping system with a petrol powered suction pump consists of the following elements:

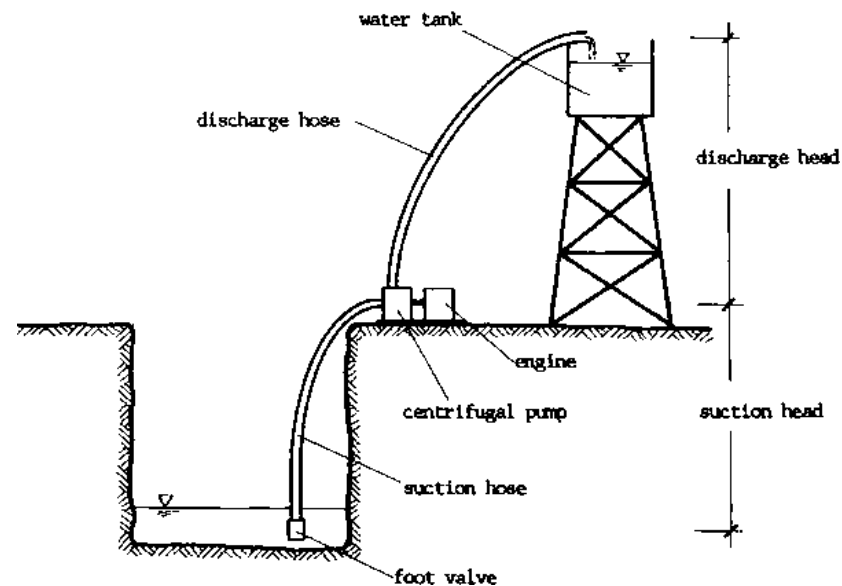

D) Description and Specifications

A petrol engine produces rotational movement and directly turns the axle of the attached centrifugal pump. The rotating blades suck water through the

A petrol engine produces rotational movement and directly turns the axle of the attached centrifugal pump. The rotating blades suck water through the suction hose and press it through the discharge hose to a higher level. As the energy of the fuel is directly converted into mechanical energy which turns the pump, there are small losses and the pump has a high efficiency.

The pump is started mechanically by a recoil starter. A foot valve (= suction sustainer) at the bottom of the suction hose makes priming much easier. The centrifugal pump is cooled by the water pumped and, therefore, must never run dry.

The specifications and the performance curve of the HONDA WA 30 X pump are given here as an example:

Specifications		Remarks
pump type	centrifugal, self priming	a suction sustainer helps priming
suction hose	Ø 3"	
discharge hose	Ø 3"	
suction head	8 m	
discharge head	20 m	
total head	28 m	
max. capacity(yield)	1100 ℓ/min = 66 m ³ /h	
direction of rotation displacement	counter clockwise 144 cm ³	= the volume displaced by the piston in a single stroke
engine	4 stroke overhead valve, air cooled single cylinder	
maximal output	5.0 HP	= horse power (Engl.) = PS (German)
	3,600 rpm	= revolutions per minute
fuel tank capacity	3.6 ℓ	
fuel	petrol	
fuel consumption	230 g/HPH -> 1,150 g/h =1.5 ℓ/h	
aircleaner	semidry	
starting system	recoil starter	battery starter is heavier
cooling system	forced air	
dimensions	620 × 410 × 485 mm	
dry weight	35 kg	easily transportable; diesel engines are heavier

self priming time	120 sec at 5 m head	after that the engine runs too hot, therefore stop.
continuous running time	2 h 40 min	

Performance Curve

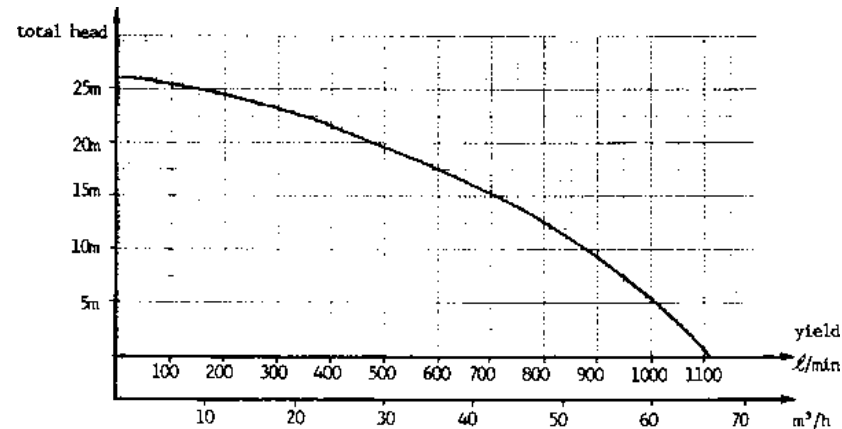

Example:

Water is to be pumped from a well 5 m deep and discharged into a container 7 m above ground level.

Total Head	=	Suction Head	+	Discharge Head	
	=	5 m	+	7 m	=12 m

According to the curve, the yield is to be expected about 820 ℓ/min or 49 m³/h (for transformation see 8.34/1).

E) Advantages and Disadvantages

The advantages of a petrol suction pump are:

- The pump is light-weight and easily transportable.
- Only a hose is lowered into the well which leaves enough space for the technicians in the well.
- Technicians can work in the well during pumping.
- The pump is able to pump dirty, sandy and muddy water.
- The pump has a high yield.

The disadvantages are:

- The pump can only pump up to 8 m depth.
- The pump needs fuel.
- The equipment is relatively sophisticated and can break down easily.
- Spare parts are difficult to get.
- The pump requires great care during operation.
- The hoses wear out quickly.

F) Step-by-Step Procedures for Operating the Pump

For dewatering a well with a petrol suction pump, follow these steps:

No	Step	Reasons
1	Place the pump near the well in the shade on a level surface. The exhaust pipe must direct away from the well.	Otherwise the pump easily gets overheated. On a sloping area the fuel will spill. Exhaust fumes are poisonous and heavy and can easily descend into the well(8.22/lff)
2	Connect foot valve, suction hose, pump and discharge hose. If you have no foot valve, use a strainer. Place the suction hose into the well, and the discharge hose far away. The strainer should be well submersed, but not stand on the ground.	Gravel sucked into the pump will cause serious impeller damage.
3	Check engine oil level.	Running the engine without sufficient oil can cause serious damage.
4	Check the fuel level. Do not spill fuel when refilling.	Spilled fuel might ignite.
5	Check the air cleaner element.	Clean, if necessary.
6	Pour water into the priming water filler plug.	Otherwise the pump will overheat. Extended dry operation will destroy the pump seal.
7	Turn the fuel valve "ON".	
8	Close the choke lever (only in cool climate).	The choke is not to be used if the engine is warm or the surrounding temperature high.
9	Turn the engine switch to the "ON" position.	
10	Move the throttle lever slightly to the left.	
11	Pull the starter grip lightly until resistance is felt, then pull briskly. Return it gently to the starter.	

12	As the engine gradually warms up, gradually open the choke.	
13	Set the throttle lever at the desired speed.	
14	Watch if the pump is operating properly and yielding water.	Continuous watching is necessary to avoid running dry.
15	Stop the pump immediately when it runs dry.	Otherwise the pump will overheat and break down.
16	Move the throttle lever fully to the right (i.e. close it).	
17	Turn the engine switch to the "OFF" position.	To stop the engine in emergency, just turn the engine switch to the "OFF" position
18	Turn the fuel valve "OFF".	
19	After pumping muddy, sandy or salty water, always pump clean water through the pump before storing.	Sediments settling in the pump spoil the impeller.
20	Do not allow the pump to run continuously longer than 2 to 3 hours.	After 2 to 3 hours, the pump needs to cool down, because it has no cooling system with ventilator.
21	Store the pump in a dry, clean place in the shade.	Sun overheats the pump. Rain causes corrosion.

8.28. Submersible Pumps

A submersible pump is a unit consisting of an electrical engine and a centrifugal pump submersed into the water to be pumped.

A) Types of Submersible Pumps

Submersible pumps can be differentiated according to their size, from tiny ones to huge models requiring a very strong power supply. They can also be differentiated according to the type of water they pump. In wells they can serve two purposes:

1. Permanent installation for pumping clean drinking water after the construction is completed (often used for boreholes).
2. Temporary pumping of dirty water for dewatering wells during construction.

The two purposes are different and require different pumps. The first will not be discussed here, because, in rural areas, hand pumps are more appropriate for drinking-water supply in most cases. The second is described in the following.

B) Range of Use

Submersible pumps can be designed for heads between 5 and 150 m. For dewatering wells during construction, they are suitable if the water table is 8 m or deeper.

C) Elements of a Pumping System with two Submersible Pumps

A pumping system with a transportable generator and two submersible pumps consists of the elements shown in the drawing next page.

A pumping system with a transportable generator and two submersible pumps consists of the elements shown in the drawing next page.

D) Description and Specifications

In the generator, a diesel engine produces rotational movement and turns the axle of the attached generator part. Here, the mechanical energy is converted into electrical energy. The electricity is transported through the electrical cable to the pump in the well. The electrical engine of the pump converts the electrical energy into rotational movement and turns the blades of the attached centrifugal pump. The rotating blades suck in the water through the inlet and press it through the delivery pipe to a higher level (out of the well). As the energy is converted several times and transported through the electrical cable, there are a great number of losses and the efficiency of the system is low. (There are four conversions of energy: fuel -> mechanical energy = rotation of the generator axle -> electrical energy -> mechanical energy = rotation of pump axle -> water pressure).

Elements of a Pumping System with two Submersible Pumps

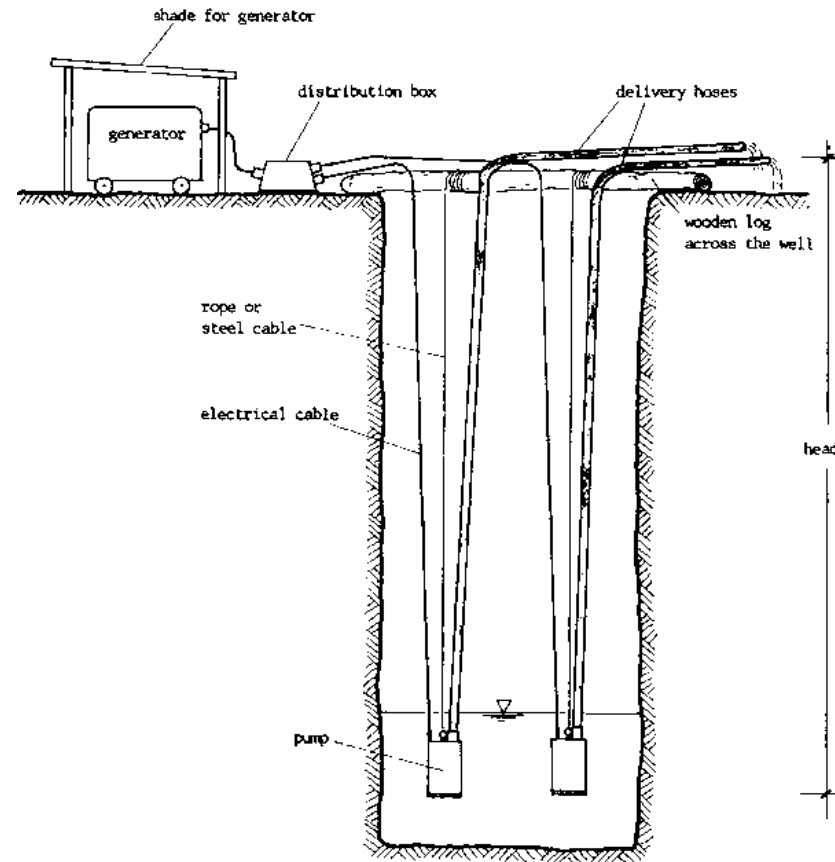

Schematic Illustration

The pump in the well always has three connections to the well head:

1. a rope or steel cable bearing the weight of pump and hoses;
2. an electrical cable supplying the energy;
3. a delivery hose or pipe for the water.

When purchasing a submersible pump check the specifications and pay attention to the following aspects:

- The pump must be designed to pump dirty, sandy and muddy water because the water in a well is never sand-free during construction.
- The generator for running the pump must be transportable and strong enough for the pump.
- The pump should be as light as possible for easy handling.
- The diameter of the outlet should be reasonable (between 1" and 2"), otherwise, the delivery hose will be very heavy and difficult to handle.

E) Advantages and Disadvantages

The advantages of a submersible pump for dewatering wells are as follows:

- It is suitable for deep wells.
- It is small and can easily be lowered into the well.
- It is able to pump dirty, sandy and muddy water.

The disadvantages are:

- It needs fuel.
- The efficiency is low.
- The equipment is relatively sophisticated and can break down easily.
- Spare parts are difficult to get.
- It requires great care during operation.
- It occupies space in the well.
- Nobody can work in the well while the pump is operating.

In spite of the disadvantages, the submersible pump is often the only option for dewatering (deep) wells.

F) Step-by-Step Procedures to Operate Submersible Pumps

For dewatering wells with two submersible pumps, follow these steps:

No	Step	Reasons
1	Put the generator into the well with the shade exhaust away from the well	Otherwise the generator runs too hot and gets spoiled

1	Put the generator into the well with the shade exhaust away from the well.	Overheat the generator fans too hot and gets opened. Exhaust fumes are dangerous (see 8.22/1,3)
2	Check engine oil and fuel.	If not full, engine oil and fuel need to be refilled.
3	Lower pumps hanging on rope or steel cable connected with the hoses. The pumps should be well submersed, but not stand on the ground. Connect the electrical cables to the distribution box of the generator.	The hose and its joints are not strong enough to carry the pumps' weight. If standing on ground, the pump will dig itself into the sand and get blocked.
4	Measure and record well diameter and water table.	This is necessary for calculating the discharge of the pump (see 8.34).
5	Start the generator with the crank handle. Remove the handle immediately after the generator has started. Let it run for 3 minutes.	The generator should be warm before loaded with pumping work.
6	Record the time.	see No. 4
7	Switch on the first pump. Listen for a slight change in the sound of the generator. Watch if the pump makes a sudden rotational movement when starting.	If you hear a change of the sound, the generator supplies electricity to the pump. If the pump makes a sudden movement, the impeller started to rotate.
8	Watch if water comes. Switch off if no water comes.	The pumped water has to cool the pump. If running dry, the pump will become hot and can be broken within three minutes.
9	Switch on the second pump.	The generator should not be overloaded with starting both pumps at once, because the pumps need more power during starting than during running.
10	Watch if water comes. Switch off if no water comes.	see No. 8.
11	No people should be in the water during pumping.	If the pump has a short circuit, the person in the water is in danger.
12	If the top of the pump appears above the water table, lower the pump further.	see No. 8
13	Switch off immediately when water stops to flow. Therefore, watch the pump continuously.	see No. 8
14	Record time, water table and well diameter.	see No. 4
15	Store pumps and generator in dry clean place in the shade and handle them with care.	Sun overheats the machines; rain causes corrosion.

8.29. Drawing Water from a Well for Human Consumption

There are many different ways to draw water from a well for human consumption. Which is the best water drawing device?

There is no "best pump" for all conditions everywhere.

Instead, the most suitable solution must be selected for each area, even for each well, again and again, considering not only technical, but also social

aspects.

In the following section, we give suggestions on how to select the suitable method of drawing water for certain conditions. These suggestions are subjective and based on the given criteria and priorities.

A) Criteria for Selecting the Suitable Method

We suggest that the following criteria (= guidelines) should guide our choice of the water-lifting device (in the order of their priority):

1. Protection of groundwater in the long run.
2. Durability, maintenance and repair.
3. Protection of health.
4. Provision of water for the majority of the population.
5. Acceptability by the community.
6. Economic suitability.

On No. 1.:

Protection of groundwater in the long run, i.e. preventing the aquifer from being exhausted, is the first priority. To install a water supply system which draws more water from the aquifer than is recharged by rain or from other sources, means to deceive the users. They will get used to the abundant water supply and plan their activities accordingly, only to get into great trouble when the water table drops. Such installations are also irresponsible for the future generations. The aquifer might not be able to provide a large water supply in the long run, but a limited water supply might be possible for generations. See also 8.8/3f.

On No. 2.:

To consider durability, maintenance and repair is essential, too. The water supply installation must have a realistic chance of being kept-up for years. It is easier to reach a remote place with high-level technology for the short construction period, than to reach it continuously with middle-level technology for running and maintenance. We need to look honestly into the question of whether the infrastructure, the fuel supply, the spare parts' supply and the skilled labour are available to run and maintain the proposed water supply system. Often, the local people in the village are more realistic about the issue than planning personnel and politicians. See also 8.24/2-6.

On No. 3.:

To provide clean and safe water is an obvious criterion (= guideline), although not the first priority. It comes after the two already mentioned. To provide clean water for a short period only is no real improvement for the health situation of the users. The water supply in large areas and for many people is in such a state that the people struggle to get any water rather than good water. This is a sad, but true fact. Under these circumstances, provision of easily available and sufficient quantities of any water is already an improvement, even an improvement in health (enough water for cleaning and washing, less efforts spent on securing the water supply). Providing clean water alone is not sufficient as well, because the general situation, poverty and the level of

knowledge might prevent the users from keeping the water clean after taking it from the supply. Therefore, stressing the cleanliness of the water, while the other factors remain untackled, is not enough. See also 8.5 and 8.6.

On No. 4.:

We have to examine exactly who is to benefit from the proposed water system. We suggest as a guideline to try to supply water to the majority of the population, rather than to a minority. It is questionable spending lots of money and resources on high level water supply for a privileged minority, rather than a lower level water supply for many. See also 8.2.

On No. 5:

The chosen water supply system must be understood and accepted by the users. However, this depends very much on, and can be influenced by, relevant education and community development work. See also 8.38 and 8.39.

On No. 6.:

The system should be within the economic means of the users; if not the installation, then at least the running costs. See also 8.3.

B) Methods of Drawing Water for Human Consumption from Wells

The diverse water-lifting devices are described in 8.24. Those devices suitable for drawing water for human consumption can be arranged into three main groups with variations. These three groups also represent different levels of sophistication:

C) Water-Lifting with Bucket and Rope

The simplest way to lift water with a bucket or another container and rope (see 8.24, No. 1, 2).

1. Advantages

Its advantages are:

- The equipment can be completely local, if necessary, consisting of gourds and ropes from local fibres.
- No outside input is required.
- No maintenance structure is required.
- The method is very reliable.
- No water is going to be wasted because the amount of water pulled is limited.
- Large numbers of animals cannot be watered.(This could also count as a disadvantage). Therefore, overgrazing due to availability of water cannot occur.

2. Disadvantages

The disadvantages are:

- The water is not protected from pollution.
- The amount of water which can be pulled is very limited.
- The depth from which the water can be pulled is limited.
- The method is tiresome and time consuming.

3. Suitability

Drawing water with bucket and rope fulfils guidelines No. 1, 2, 4, and 6. Guideline No. 5 is fulfilled in many cases. Guideline No. 3 is not fulfilled in most cases and improvements are advisable.

Drawing water by bucket and rope is suitable if the infrastructure for hand pump installation, operation and maintenance is not available in the long run. In that case, improve the situation within the given circumstances by

- providing enough wells;
- constructing the wells with a lining and, thus, digging deep into the water table;
- providing an elevated well mouth with a lid;
- providing a proper concrete apron;

- conducting a health education campaign.

D) Water-Lifting with a Hand Pump

Hand operated pumps or other simple devices are the next level of technology for lifting water (see 8.24, No. 3-14, 16-18,22).

1. Advantages

The advantages are

- The well can be sealed and protected from pollution.
- The maintenance is relatively simple and local people might be able to learn it.
- No fuel is required.
- The method is less tiresome for the users than C).
- No water is going to be wasted because the amount of water pumped is limited.
- Large numbers of animals cannot be watered.(This could also count as disadvantage). Therefore, overgrazing due to availability of water cannot occur.

- Greater depth can be reached than with the method under C).

2. Disadvantages

The disadvantages are

- The pump might be available only from abroad.
- The spare parts' supply must be secured. It might require foreign currency and an organisation to acquire it.
- People able to repair the pump must be available.
- A higher degree of organisation within the community is required than for the method under C).
- The method is more expensive than C).
- Only one person can draw water at a time.
- The depth is limited to 70-80 m, in exceptional cases up to 110 m.
- Some people can try to get control and make private profit from a hand pump on cost of the community.

3. Suitability

Drawing water with a hand pump fulfils the guidelines No. 1 and 4. Guideline No. 2 is fulfilled if the infrastructure for maintenance is available. Guideline No. 3 is fulfilled if the well is properly constructed and the platform has no cracks. Guideline No. 5 depends on information and health education. Guideline No. 6 depends on the resources of the community.

To achieve water supply by hand pump is a goal for all rural communities and many urban communities.

Install a hand pump only if

- operation and maintenance can be secured in the long run;
- the community is organised to take the responsibility of the pump;
- women are being trained for hand pump caretaking and repair;
- there are enough resources to construct the well head properly;
- the hand pump can be installed properly; When installing a hand pump, take care
- to provide enough wells;
- to conduct a health education campaign;

Do not install a hand pump if maintenance cannot be secured in the long run.

Water-Lifting with Fuel Powered Pumps into an Elevated Tank

This method is considerably more sophisticated than the two before. The water is pumped into an elevated tank from where it is supplied in pipes either directly to households or to public taps (see 8.24, No. 20, 23, 27-29, 31,32).

1. Advantages

The advantages are

- The well can be protected from pollution.
- Water can be pumped from greater depths than by methods C) and D).
- Piped water supply becomes possible.
- The method is less tiresome for the users than methods C) or D).

2. Disadvantages

The disadvantages are

- The pump and other parts of the installation most likely come from abroad.
- A constant supply of fuel is required.
- The spare parts' supply must be secured, most likely from abroad.
- Highly skilled people are required for installation and maintenance.
- Skilled labour is required for the daily running.
- A structure is required to organise installation, supplies and maintenance.
- The costs are very high.
- Waste of water is very likely.
- There is a danger of exhausting the aquifer and of lowering the water table in the long run.
- Overgrazing and desertification are possible if a large number animals are attracted by the well.

3. Suitability

Water supply by fuel powered engine pump and elevated tank should fulfil guideline No. 3. Whether the method fulfills the other guidelines, depends on the situation and has to be questioned.

Water supply by fuel powered engine pumps and elevated tanks is not a reachable goal for all rural communities, and is a reachable goal for some urban

water supply by fuel powered engine pumps and elevated tanks is not a reachable goal for all rural communities, and is a reachable goal for some urban communities.

Install such a system only if

- it does not exhaust the groundwater in the long run;
- operation and maintenance can be secured in the long run;
- fuel supply can be secured in the long run;
- no flush latrines are to be supplied by the system and, thereby, large amounts of water wasted; see also 8.37/7 and 9.8/2;
- the community is organised to take responsibility for the system;
- women are being trained for operation and maintenance;
- the community can afford the system;
- the system is safeguarded against being exploited by a few people;
- you have to supply densely populated town areas with public taps

When installing this system, take care to conduct a health education campaign. Do not install this system at all in scarcely populated rural areas with many animals because of the danger of overgrazing and desertification.

8.30. Hand Pump Parts and Functions

It is very important for a technician to know the names of the parts of a hand pump and to understand their functions. This background knowledge will enable her/him to understand why the hand pump has to be installed and repaired in a certain way.

The parts and functions are explained here for the INDIA MARK II hand pump; other hand pumps of a similar type consist of principally the same parts. The different types of handpumps are explained in detail in No. 18 of the bibliography.

A) Parts of Pump Head Assembly

For learning about the parts of a hand pump, disassemble a pump and get familiar with the parts.

CROSS-SECTION

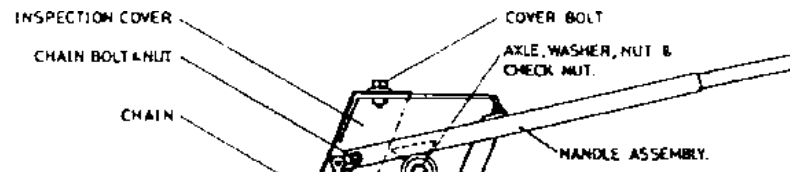

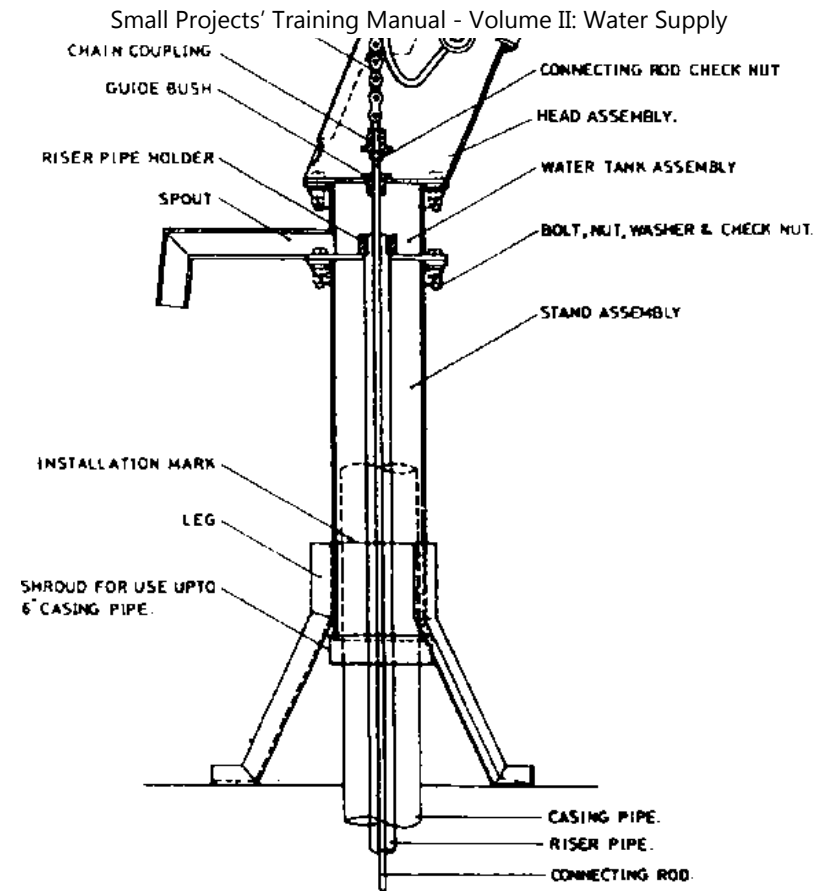

B) Function of Pump Head Assembly

The operation of a hand pump has two distinct and opposite phases:

1. Phase

- handle moving downwards
- rod moving upwards

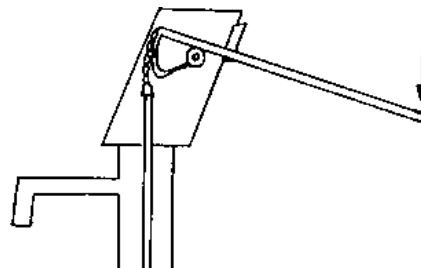



2. Phase

- handle moving upwards
- rod moving downwards

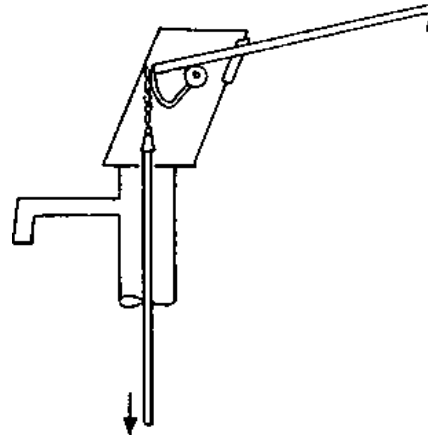

UP and DOWN movement of handle
results in
DOWN and UP movement of rod.

The pump head assembly, as shown here, has a chain link. The rod is lifted by an active downwards stroke of the handle. The rod moves downwards and, thus, lifts the handle by itself because the weight of all the rods together overcomes the friction and the weight of the handle. This is the case if the pump cylinder is installed at about 20 m or deeper.

If the cylinder is installed in a depth less than that, the weight of the rods is not enough, and the flexible chain cannot push the rods down. In that case, a solid link is required between the handle and the rod so that the upward movement of the handle can push the rod downwards. The disadvantage of the solid

link connection is that there will be a slight lateral (= horizontal) movement of the rod with each stroke. The pump head with solid link is suitable for wells up to 20-25 m depth.

C) Parts of the Cylinder Assembly

Disassemble a pump cylinder and get familiar with its parts:

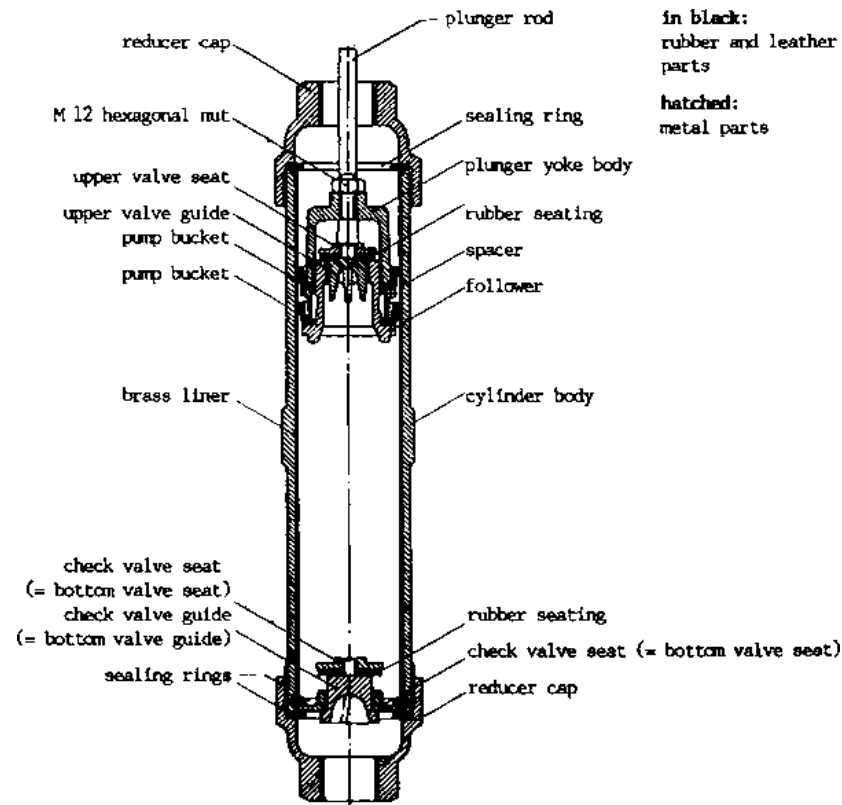

D) Function of the Cylinder Assembly

The cylinder operates in two distinct phases as well:

1. Phase

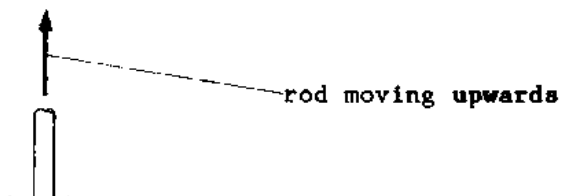

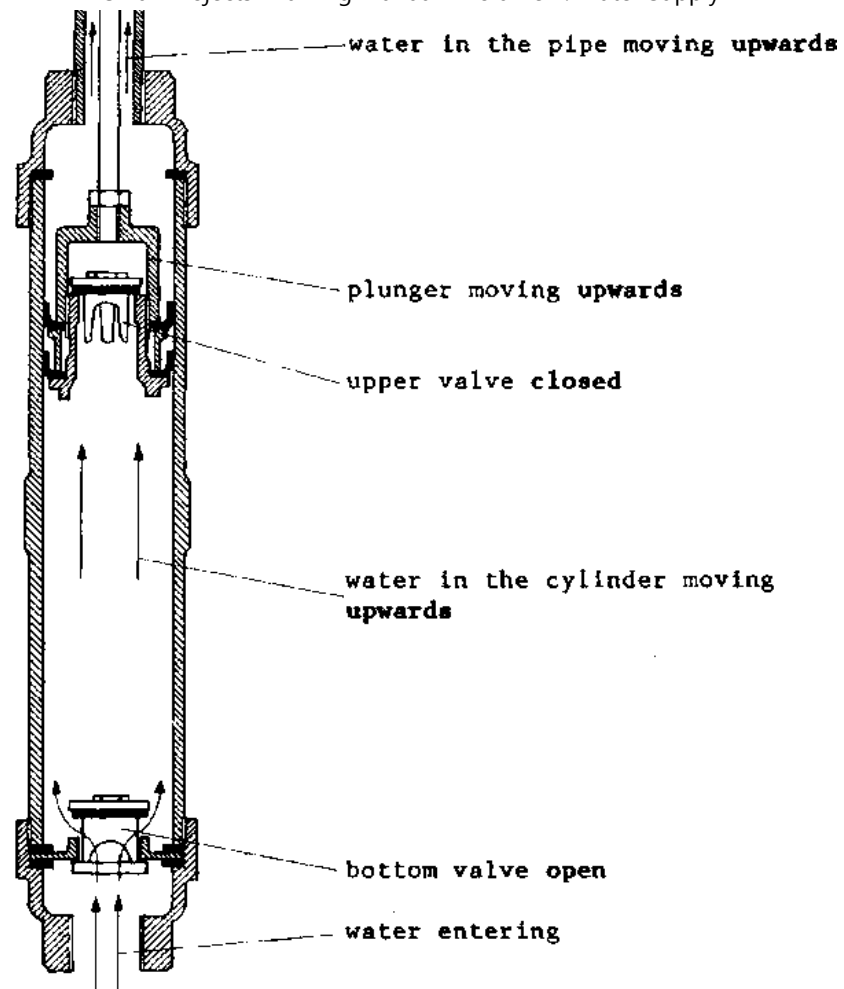

Schematic Illustration; some details left for sake of clarity; valves in side-view.

How do the valves open and close?

1. The water in the pipe tries to move downwards by gravity → This closes the upper valve.
2. The plunger moving upwards creates suction → This opens the bottom valve.

2. Phase

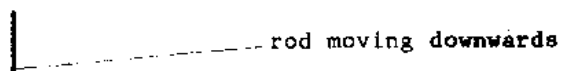

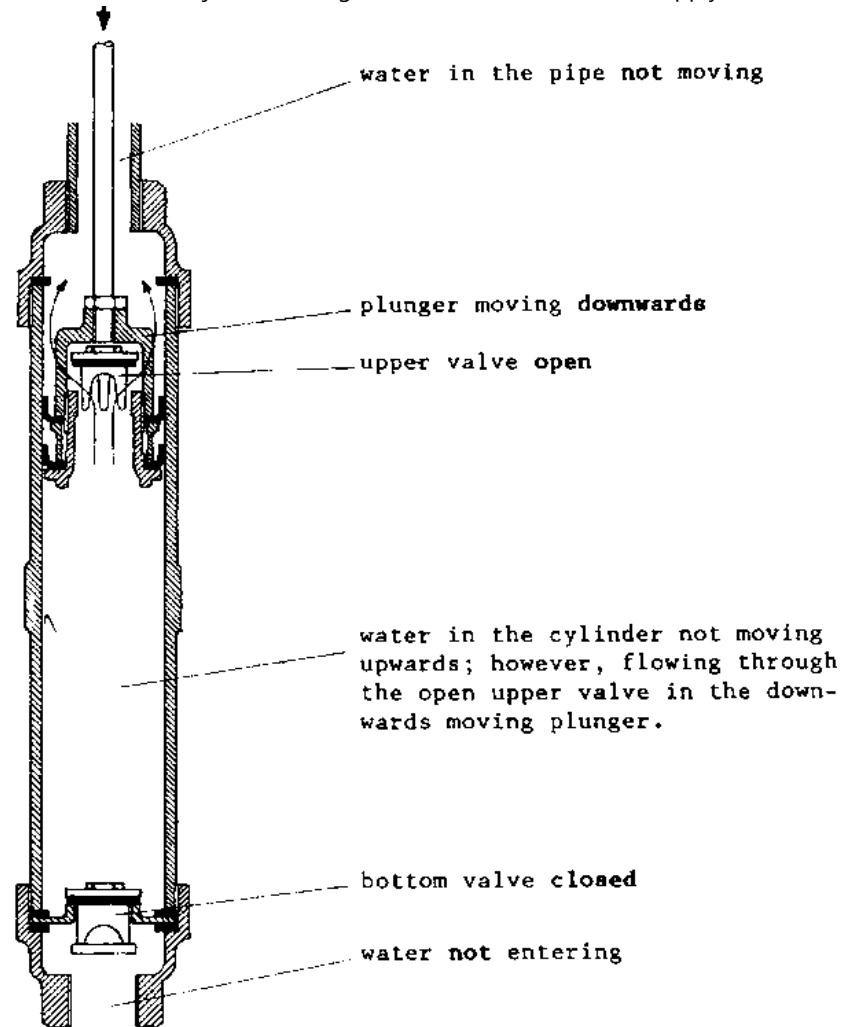

Schematic Illustration: sane details left for sake of clarity; valves in side-view.

How do the valves open and close?

1. The water in the cylinder tries to move downwards by gravity → This closes the bottom valve.
2. Rod and plunger are moving downwards → The resistance of the water in the cylinder opens the upper valve.

The two valves open and close alternately and, thus, the water is lifted in steps (not continuously!). The valve (consisting of seat, rubber seating, and valve guide) moves up and down (open and closed). It is essential that the valves close watertight. This is ensured by the rubber seatings of the valves which must

guide), move up and down (open and close), it is essential that the valves close watertight. This is ensured by the rubber sealings of the valves which must be intact.

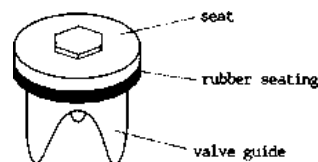

The pump buckets (= leather cups) provide the watertight sealing between the plunger moving up and down, and the inner wall of the cylinder (with a brass liner). Although the pump buckets seal, they allow the plunger to move. If the pump buckets are worn out, the sealing will not be complete and the yield of the pump will decrease. The pump buckets are the parts which usually wear out the quickest, especially, if there is sand in the cylinder due to improper installation. They need to be replaced regularly.

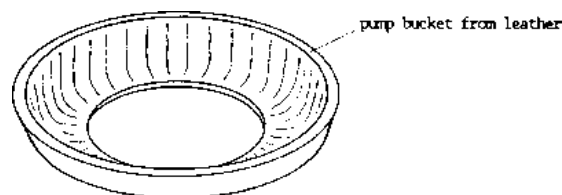

8.31. Hand Pump Installation

There are specific manuals for each type of hand pump, published by the manufacturers (e.g. No. 22 in the bibliography for the India Mark II hand pump). Follow the steps of the manual when installing or repairing a hand pump. Some general principles, valid for all kinds of different pumps, are compiled here.

A) Lowering and Lifting the Riser Main Pipe

During installation and repair the riser main pipe (= rising main = = rising pipe) has to be lowered into and lifted from the well. This can be done in different ways depending on the depth of the well.

1. Blocking the Riser Main Pipe

While lowering the riser main pipe, one must stop in between to join the next following pipe. For this operation, the riser main pipe must be blocked temporarily. This can be done

- by a special self-locking clamp,

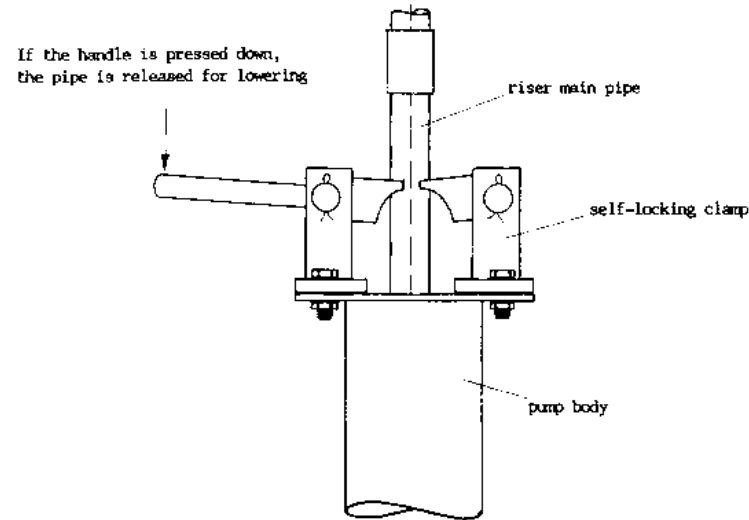

- by an ordinary pipe vice (see 6.3/34), laid across the pump body,
- by pushing a socket (9 3" over the two handles of a pipe wrench (6.3/34)

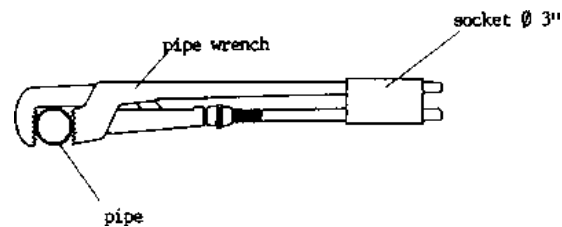

In any case, make sure that a socket is fixed to the top end of the riser main pipe. This is an extra precaution.

The lowering itself can be done by one of the following methods:

2. Lifting by Hand

For very shallow wells (up to about 10

m) the riser main pipe (together with the cylinder and the rods) can be lifted by hand directly. Enough and well coordinated people are necessary for that.

3. Lifting by Lifting Spanners

For medium depth wells (up to 35-40 m), the pipes can be lifted with 3 to 4 lifting spanners which hold the pipe by friction and provide an advantageous lever arm.

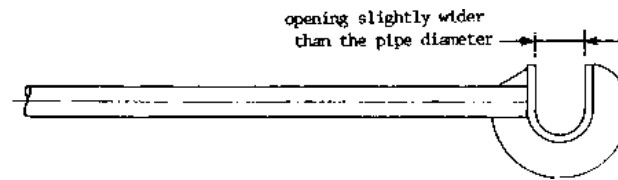

Lifting spanners can also be manufactured locally from metal pipe Ø 1"

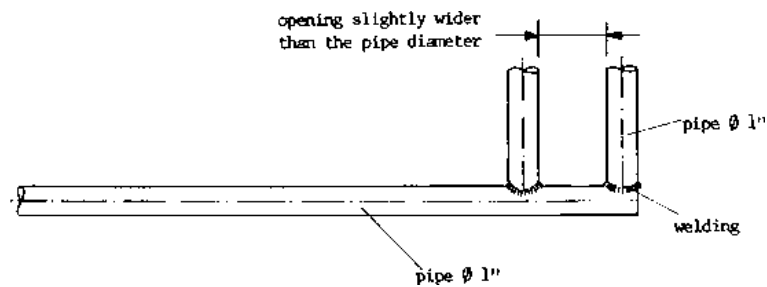

The technicians place the lifting spanners around the riser main pipe and get hold of it by pressing the handle upwards. They must be well coordinated.

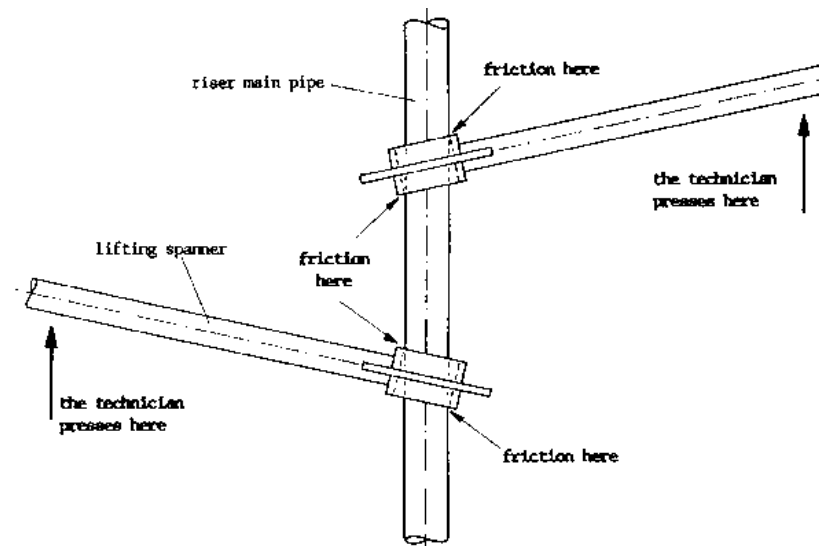

4. Lifting with Lifting Spanners and Simple Scaffold

For deep wells, lifting with lifting spanners can be made easier with a scaffold made from a pipe $\varnothing 2''$ with steps. This scaffold is fixed to the pump body with U-bolts. A technician at the top can easily direct the pipes while lowering or lifting.

Design: Norwegian Church Aid - Sudan Programme, Torit, Sudan

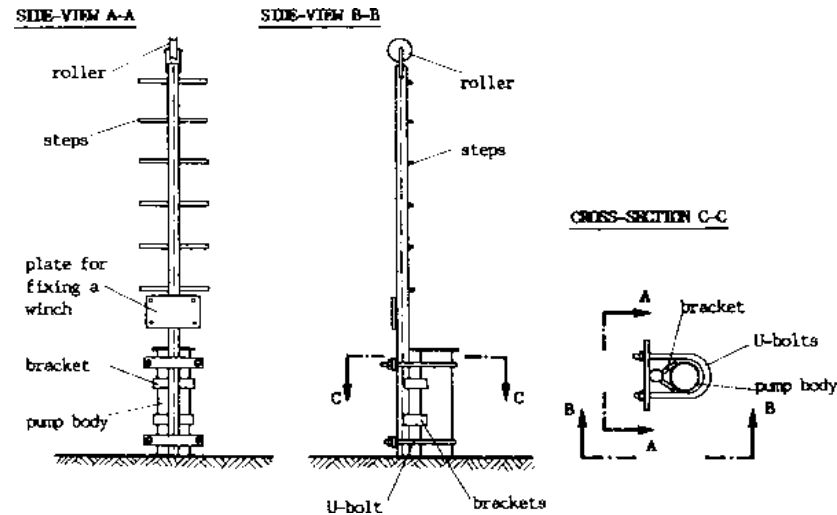

Additionally, a small winch can be fixed on the scaffold and the steel cable directed over a roller on the top.

5. Lifting with Tripod, Winch and Steel Cable

It is difficult to lift pipes from depths more than 40 m. In this case a light weight tripod (see 8.17/13) and a small winch can help. The riser main pipe is fixed to the steel cable with a chain pipe vice (see 6.3/34).

B) Tightening the Joints of the Riser Main Pipe

Watertight joints of the riser main pipe are essential, otherwise the yield of the pump will decrease. Tight joints can be achieved with the following measures:

1. Clean all threads with a wire brush and lay the pipes on two pieces of timber, not directly on the ground. The threads must be completely sand-free when you join them. Sand on the thread prevents the thread from fully closing, and thus causes leakage. Constant leakage causes corrosion, and the pipe is likely to break sooner at the thread.

CROSS-SECTION TROUGH JOINT WITH SAND

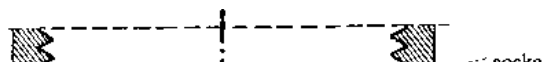

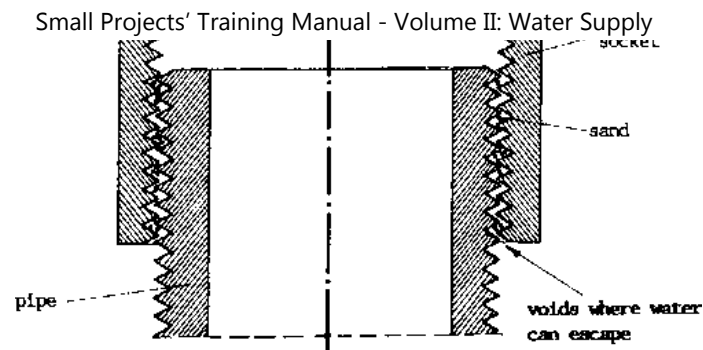

2. Smear jointing compound on the thread or cover the thread by thread-tape before tightening. This materials fill the tiny voids between the threads and make the joint watertight.

3. Tighten all joints properly, but do not overdo it. Handle the pipe wrenches as described in 8.32/14.

C) Handling the Pump Rods

Handle the pump rods as follows:

1. Clean the threads of all pump rods.
2. Grease the threads if they are corroded.
3. Take great care not to bend a pump rod.
4. Do not install any bent pump rod.
5. Tighten the joints of the rods properly.
6. Hold the rod by a rod-vice when you cut it to length, to avoid bending.
7. When threading the pump rod, prevent cuttings from falling into the riser main pipe by a piece of cloth (cuttings quickly wear out the pump buckets).

D) Handling the Pump Cylinder

Handle the pump cylinder as follows:

1. Check it before you install it even if it is new.
2. Open the cylinder and the plunger and tie all elements properly.
3. Tighten the valve seats, but do not squeeze the rubber seatings.

E) Handling the Pump Head

Handle the pump head as follows:

1. Only untie the pump head as much as necessary for installation. Do not dismantle axle and handle unnecessarily.
2. Grease the chain properly.
3. Grease the threads of all outside bolts and nuts to prevent corrosion due to rain. Thus it will be easy to open them any time.

F) Locating the Pump Cylinder

The cylinder must be installed at different positions in a borehole and in a hand dug well.

1. Pump Cylinder in a Borehole

The bottom of a borehole is not closed with a filter. Therefore, never install a cylinder in a borehole less than 6 m from the bottom of the borehole. Apart from that, install in a borehole a number of full length (3m) pipes, because it does not matter if the cylinder is higher or lower by 1 or 2 m as the water column is normally high. Join an extra pipe to the bottom of the cylinder. This forces the water to enter through the pipe. Eventually, sand would settle and clean water will enter the cylinder.

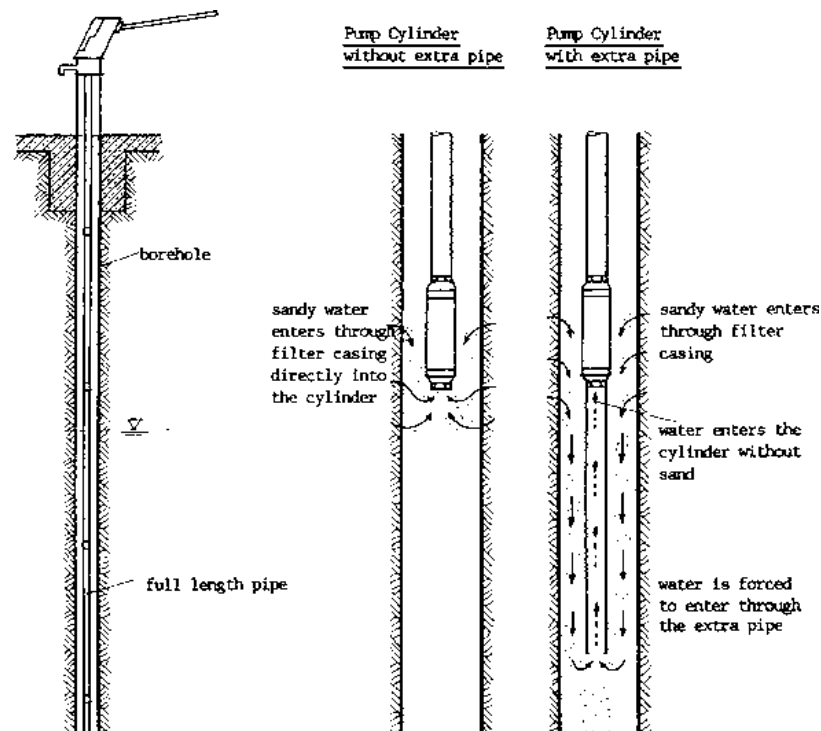

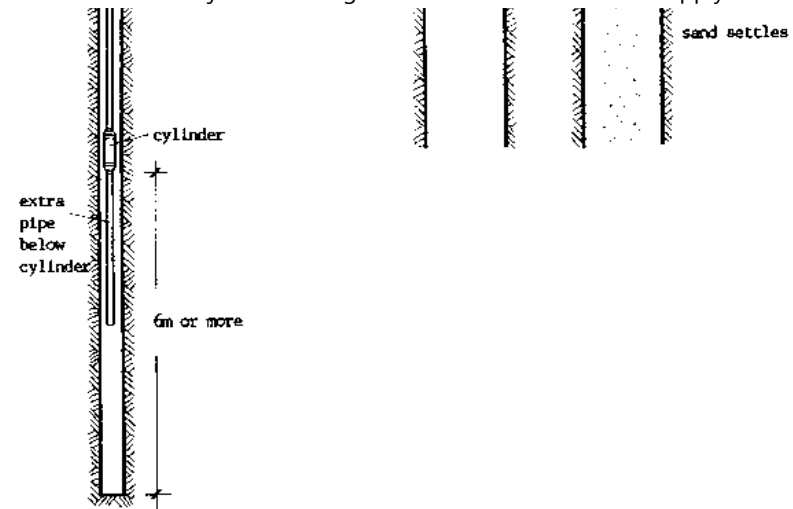

Schematic Illustration

2. Pump Cylinder in a Hand Dug Well

The water column in a hand dug well is limited and, therefore, the cylinder has to be installed as deep as possible to utilize the water reservoir fully.

There must be a filter in the well bottom (see 8.20/1f). Install the cylinder so that its bottom is about 15-20 cm above the top of the filter. This will most probably require cutting and threading of one riser main pipe. To get the correct length, you can proceed as follows:

- Measure the distance between the top of the pump body and the top of the filter with a plumb loaded measuring tape.

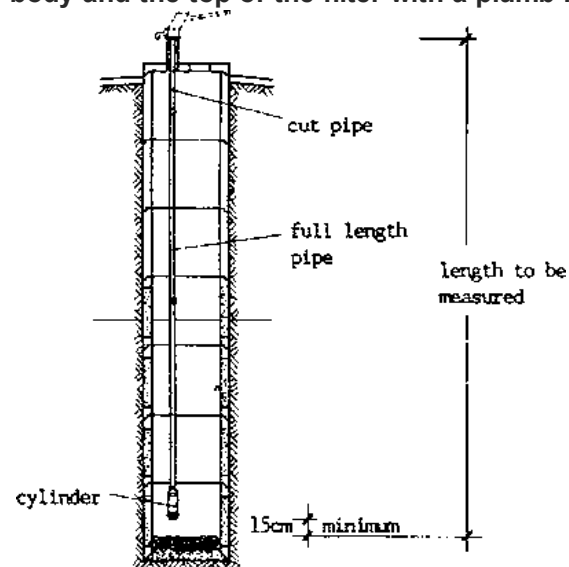

- Lay the measuring tape on flat ground. Lay the pump cylinder and the pipes with sockets beside it. Overlap them according to how they will be tightened. Leave 15 cm for the gap between filter and cylinder. Add 3 cm for the thread connection with the water tank.

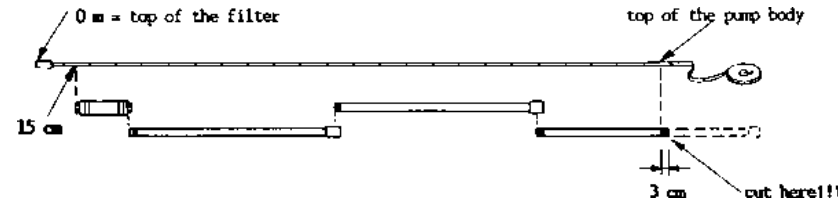

Not to scale!

- Mark where you have to cut the last pipe.

Be very careful when determining the length of the last pipe. Too short means that you waste a part of the water reservoir and the pump might unnecessarily run dry during dry season. Too long means that the cylinder might sit on the filter. By the method above you are less likely to make mistakes than by calculation.

8.32. Basic Plumbing

Plumbing is the installation and repair of pipe systems for water supply (or other purposes), like a hand pump or the water distribution system in a house. The most basic knowledge about plumbing is compiled here.

A) Threads

The different types of threads for both bolts/rods and pipes are described and compared in the following chapters.

1. Thread Types

Threads can be differentiated according to six pairs of opposites:

a) Internal/External Threads

Name(s)	Internal Thread = Female Thread	External Thread = Male Thread
drawing		
thread cutting operation	to cut a thread = to tap a thread	to cut a thread
tool for thread cutting	tap	die

tool for thread cutting	tap	die
handle of thread cutter	tap wrench	die stock = die handle

Internal and external threads of the same size fit together and can be screwed together to form a joint.

b) Right Hand/Left Hand Threads

Right hand threads are tightened clockwise, left hand threads opposite (= anti-clockwise). Right hand threads are usually used, left hand threads are not common.

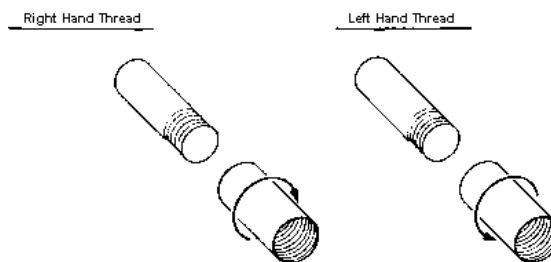

c) Parallel/Taper Threads

A parallel thread (= cylindrical thread = straight thread) has the same diameter from beginning to end. The threads look clearly cut all over.

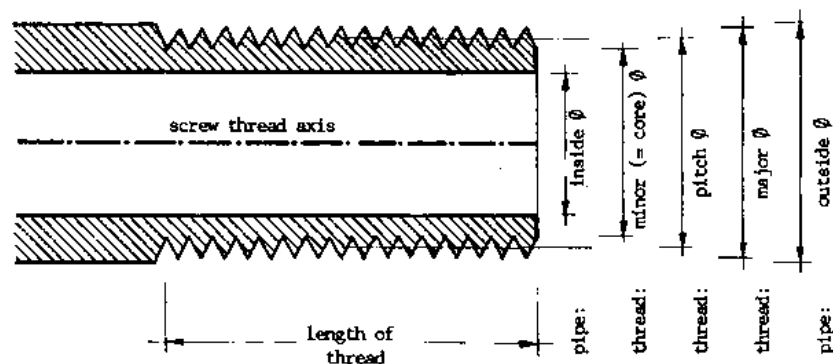

A taper thread (= tapered thread = conical thread) is growing gradually smaller towards one end like a cone. The slope of the thread is the taper/length of thread, e.g. 1:16. A taper thread can easily be recognized because it looks imperfect at the end.

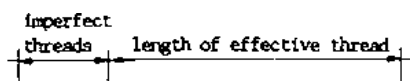

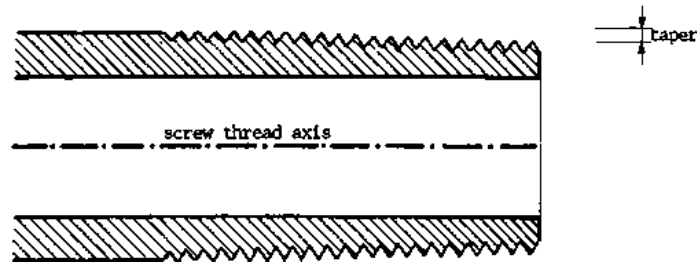

Bolts and nuts have always parallel threads to ensure maximum transmission of force along the full length. Pipes can have parallel or taper threads. Tapered pipe threads are much more common, because they are easily tightened watertight to avoid leakage. Tapered pipe threads do not have a high resistance against bending. In emergency cases, a tapered thread can be screwed to a parallel thread of the same size, but the joint will not fit exactly.

d) Coarse/Fine Threads

Coarse threads have fewer threads per inch than fine threads. Coarse threads are more common, fine threads can transmit more force. Whether a thread is coarse or fine is indicated either by the pitch or the number of threads per inch (= TPI).

The pitch is the distance between two threads and indicates how dense the total thread is (see drawing next page).

Metric threads are marked by their pitch:

$$\text{pitch(inmm)} = \frac{1}{\text{No. of threads per mm}}$$

For threads in inches, the following is valid:

$$\text{pitch(ininch)} = \frac{1}{\text{No. of threads per inch}} = \frac{1}{\text{TPI}}$$

For threads in inches, the TPI is indicated.

e) Threads with Sharp Edged Profile/Threads with Rounded Edged Profile

Threads can be cut with either sharp edges or with rounded edges:

Sharp Edges

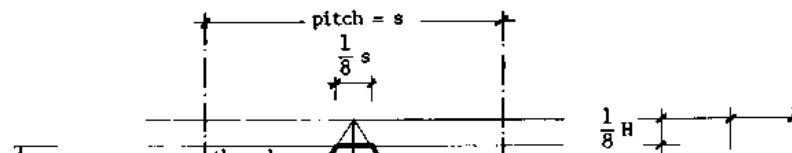

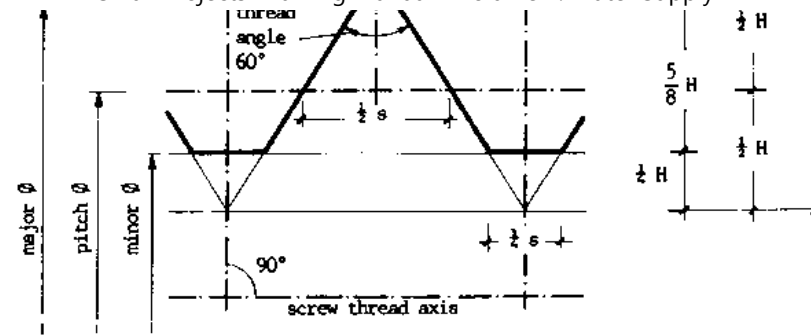

Rounded Edges

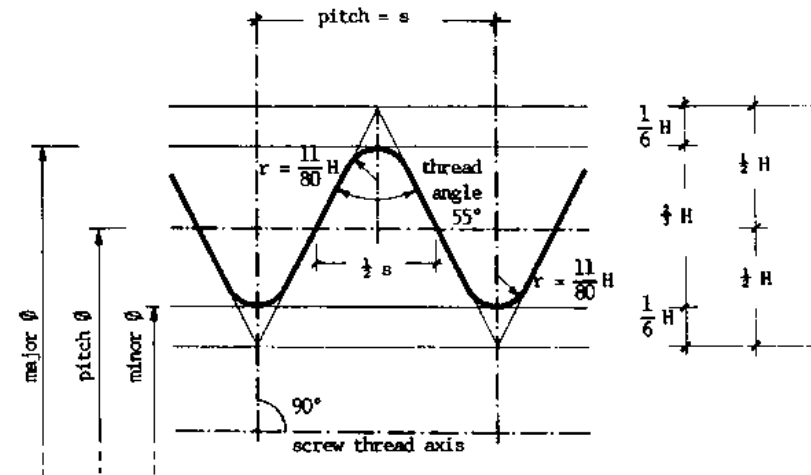

Sharp edges are more common. Threads with rounded edges are stronger, but uncommon.

f) Threads for Bolts and Nuts/Threads for Pipes

Threads can be categorized in two main groups: threads for bolts and nuts (and rods), and threads for pipes. Within the two groups a variety of different threads exists according to different countries and traditions. The main thread types are listed on the following pages.

2. Thread Standards for Bolts and Nuts

The purpose of a bolt is to press the objects between the nuts together and to connect them thus by friction. A bolt has to transmit force.

The two parts joined together are shown in Cross-Section, bolt and nut are shown in Side-View;

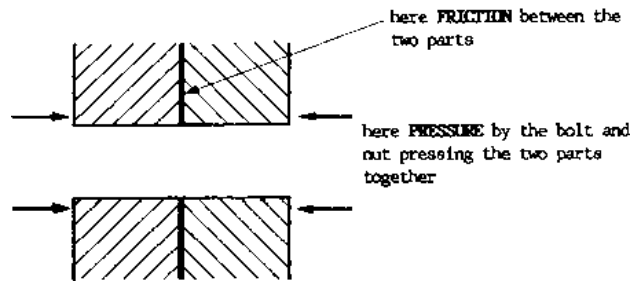
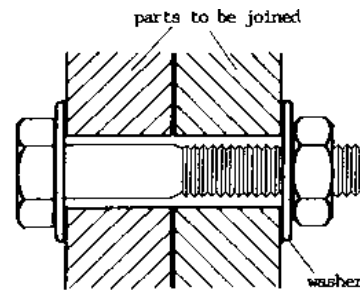

Sometimes, the following signs are used for a bolt and nuts:

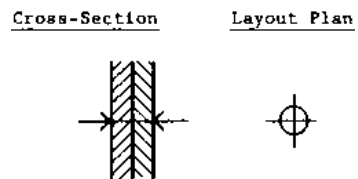

See also 6.1/17,19,23.

The function of the washer is to prevent the nut from getting loose.

Threads for bolts and nuts are both internal (on the nut) and external (on the bolt). Threads for bolts and nuts are mostly right hand, but left hand threads can be found, too.

Threads for bolts and nuts are always parallel.

Thus, maximum force can be transmitted along the full length of the thread; the thread is exactly fitting.

Threads for bolts and nuts can be coarse or fine; they can have sharp or rounded edges.

The following thread types are used for bolts and nuts (for sizes see thread tables):

a) Metric Coarse Threads M

- thread for bolts and nuts;
- measured in metric system in mm;
- specification (example):

M 10 × 1.5 (= major Ø in mm × pitch in mm)

- both internal and external threads;
- mostly right hand threads; left hand threads uncommon;
- always parallel thread;
- coarse thread;

- sharp edged profile with 60°: 
- common in Sudan and on the European continent; uncommon in USA and Britain.

b) Metric Fine Threads M

- thread for bolts and nuts;
- measured in metric system in mm;
- specification (example):

M 10 × 0.75 (= major Ø in mm × pitch in mm), or **MF 10 × 0.75**

Note that some diameters can possibly have different pitches, e.g. there are three different fine threads with Ø 10:

M 10 × 0.75

M 10 × 1

M 10 × 1.25

M 10 × 1.25

- both internal and external threads;
- mostly right hand threads; left hand threads are uncommon;
- always parallel thread;
- fine thread;
- sharp edged profile with 60°: 
- common in Sudan and on the European continent; uncommon in USA and Britain.

c) Unified Coarse Threads UNC

- thread for bolts and nuts;
- measured in inches;
- specification (example):
 - UNC No. 12 7/32 × 24, or
 - UNC $\frac{1}{2}$ × 13 (= thread Ø in inch × thread per inch [TPI])
- both internal and external threads;
- mostly right hand threads; left hand threads uncommon;
- always parallel thread;
- coarse thread;
- sharp edged profile with 60°: 
- common in USA and Britain; less common in Sudan; uncommon on the European continent.

d) Unified Fine Threads UNF

- thread for bolts and nuts;
- measured in inches;
- specification (example):
 - UNF No. 12 7/32 × 28, or
 - UNF $\frac{1}{2}$ × 20 (= thread Ø in inch × thread per inch [TPI])
- both internal and external threads;
- mostly right hand threads; left hand threads uncommon;
- always parallel thread;

- always parallel thread,

- fine thread;

- sharp edged profile with 60°:



- common in USA and Britain; less common in Sudan; uncommon on the European continent.

e) Whitworth Coarse Threads W

- thread for bolts and nuts;

- measured in inches;

- specification (example):

$$W \frac{1}{2} \times 12 \text{ (= thread } \varnothing \text{ in inch } \times \text{ thread per inch [TPI])}$$

Note that the diameters are the same as for UNC, but the TPI can differ sometimes;

- both internal and external threads;

- mostly right hand threads; left hand threads uncommon;

- always parallel thread;

- coarse thread;

- round edged profile with 55°:



therefore very strong;

- up to very large diameters (4");

- common in Britain; uncommon in other places.

3. Thread Standards for Pipes

The purpose of a pipe thread is to join two pieces of pipe in such a way that the transported fluid or gas does not leak. Watertightness or airtightness are more important than strength.

Pipe threads are both internal (in the socket) and external (on the pipe). They are mostly right hand, left hand only in exceptional cases.

Pipe threads can be both parallel and taper. Tapered pipe threads are much more common because of their water tightness and they are required for water and gas installations. When buying thread cutting tools, you have to indicate if you want parallel or taper pipe threading tools.

Pipe threads are mostly coarse, fine pipe threads are very rare. Pipe threads can have sharp edged and round edged profiles.

The following pipe threads are most common (for sizes see thread tables):

a) Whitworth Parallel Pipe Threads BSP

- thread for pipes;
- measured in inch;
- specification (example):

BSP R $1\frac{1}{4} \times 11$, parallel (= nominal \emptyset in inch \times thread per inch [TPI]), or

BSP R $1\frac{1}{4}$, parallel, or

R $1\frac{1}{4}$, parallel, or

R $1\frac{1}{4}$, DIN 259 z (= German specification)

BSP stands for British Standard Pipe. The figure given is the nominal diameter in inch; it is neither the internal nor the external diameter of the pipe. The number of threads per inch (TPI) needs not to be indicated, because for each nominal diameter only one TPI is possible.

- both internal and external threads;
- mostly right hand threads, left hand threads only in exceptional cases;
- coarse thread;
- round edged profile with 55°: 
- common in Sudan and Europe, but less common than tapered pipe threads.

b) Whitworth Taper Pipe Threads BSP

- thread for pipes;
- measured in inch;
- specification (example):

BSP R $1\frac{1}{4} \times 11$, taper (= nominal \emptyset in inch \times thread per inch [TPI]), or

BSP R $1\frac{1}{4}$, taper, or

R $1\frac{1}{4}$, taper, or

R $1\frac{1}{4}$, DIN 2999 k 1:16 (= German specification)

see also 8.32/9;

- both internal and external threads;
- mostly right hand threads; left hand threads only in exceptional cases;
- coarse thread;
- round edged profile with 55°: 
- very common for pipe threads in Sudan and Europe?

c) (American) National Parallel Pipe Threads NPSF

- thread for pipes;
- measured in inch;
- specification (example):

NPSF $1\frac{1}{4}$, or

NPSF $1\frac{1}{4} \times 11.5$ (= nominal \varnothing in inch \times threads per inch [TPI])

see also 8.32/9; the TPI of the NPSF pipe thread is different from the TPI of a BSP pipe of the same diameter;

- both internal and external threads;
- mostly right hand threads; left hand threads only in exceptional cases;
- parallel thread;
- coarse thread;
- sharp edged profile with 60°: 
- common in USA.

d) (American) National Taper Pipe Threads NPT

- thread for pipes;
- measured in inch;
- specification (example):

NPT $1\frac{1}{4}$, or

NPT $1\frac{1}{4} \times 11.5$ (= nominal \varnothing in inch \times thread per inch [TPI])

see also 8.32/9 and 10;

- both internal and external threads;
- mostly right hand threads; left hand threads only in exceptional cases;
- taper thread;
- coarse thread;
- sharp edged profile with 60°: 
- common in USA.

4. Pipe Measurements

Pipes are indicated by the diameter in inch. Note that this diameter is a nominal diameter and is neither the inside nor the outside diameter, e.g.

pipe $\varnothing 1\frac{1}{4}$ " = 31.75 mm
 outside \varnothing = 41.91 mm
 inside \varnothing = 34 mm

The diameter can be abbreviated as

$\varnothing 3$ " = nominal diameter
 $\varnothing 3$ " OD = outside diameter = external diameter
 $\varnothing 3$ " ID = inside diameter = internal diameter

Measure the outside and inside diameter of a pipe with a caliper (see 6.3/2).

Measure the thread type with a thread gauge (see 6.3/38).

B) Basic Operations of Plumbing

Some basic operations of plumbing are described in the following:

1. Cutting with a Hacksaw

When cutting a metal piece with a hacksaw, follow these steps:

- Fix the part to be cut in a vice.
- Select the right type of hacksaw blade according to the size of the part to be cut (see 6.3/28).
- Never change the blade in the middle of one cut. (A worn out blade cuts a narrower slot than a new blade. The new blade would be quickly spoilt in the narrow slot.) Take a new blade if the old one is not good enough for a full cut.

- Tighten the blade in the hacksaw frame.
- Mark where to cut.
- Hold the hacksaw straight.
- Use the full length of the blade in even movements.
- Press downwards when pushing the hacksaw forward. Do not press when pulling the saw back. The blade must be fixed to the frame accordingly. See also 6.3/26f.

Correct Use of Hacksaw

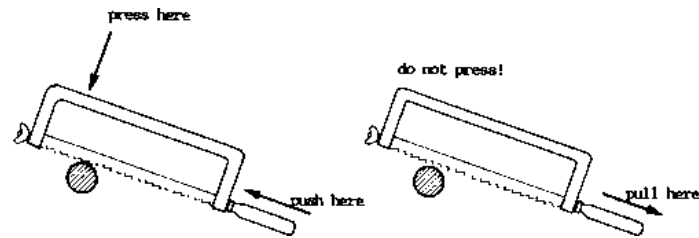

2. Pipe Cutting

It is very difficult to cut a pipe straight with a hacksaw. Instead, use a pipe cutter. Follow these steps:

- Fix the pipe in a pipe vice.
- Mark where to cut.
- Push the pipe cutter (see 6.3/36) onto the pipe.
- Tighten it until the cutting wheel touches the pipe.
- Oil the cut.
- Turn the pipe cutter one or two turns until slightly loose.
- Tighten the cutting wheel again.
- Cut another turn.
- Continue like this with constant oiling for cooling until the pipe is cut.
- Clean the chips away with a flat file.

3. Thread Cutting

Thread-cutting oil is needed for threading. There are two types of oil for thread cutting. Use the thread-cutting oil for drinking water (without any poison) for water supply systems and pump installation. Use the other type for all other threads.

Internal threads are normally cut in workshops and factories. For ordinary water supply work, external threads have to be cut. When cutting external

threads, follow these steps, both for bolts and pipes(see also 6.3/36-41).

- Cut the bolt or pipe straight, i.e. orthogonally to its axis. Cut a pipe with a pipe cutter.
- File the end conically(= with a tapered end):

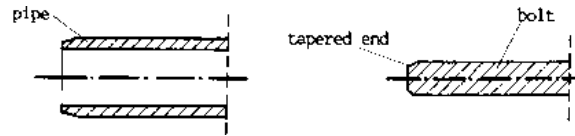

- Fix the bolt or pipe firmly in a vice.
- Take the die with the correct size and fix it in the die stock. The tapered end of the die has to start the threading (both for bolts and pipes).

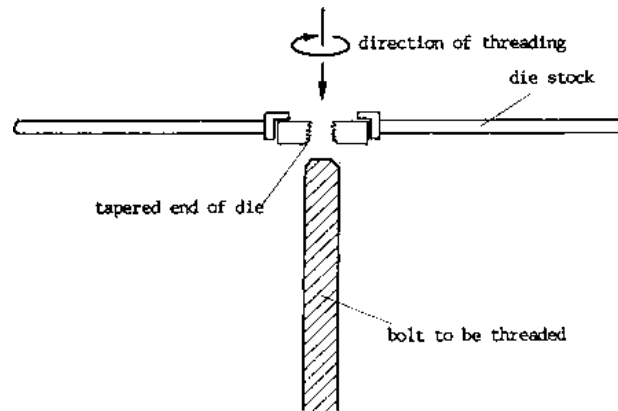

- Start cutting the thread(clockwise for right hand thread). Hold the handle vertical to the bolt/pipe. Oil continuously with thread-cutting oil.
- Turn one full turn (or until turning becomes difficult). Turn a quarter turn backwards to remove the chips. Turn another full turn forward and so on.
- Never use force.
- Continuously oil.
- When the thread is long enough, remove the chips, and turn the die loosely backwards until it is off the thread. When using a thread cutter with chaser die, open the dies and you can remove the tool without screwing back.

Clean the thread and the die

- Clean the thread and the die.

- The thread is of good quality if you can screw the nut or the socket easily onto the thread.

4. Using Pipe Wrenches (see also 6.3/34)

Pipe wrenches are used to tie or untie pipe connections. Use them like this:

- Take the pipe between the two jaws of the pipe wrench. The two jaws must be parallel, as well as the handles.
- Tighten the positioning screw.

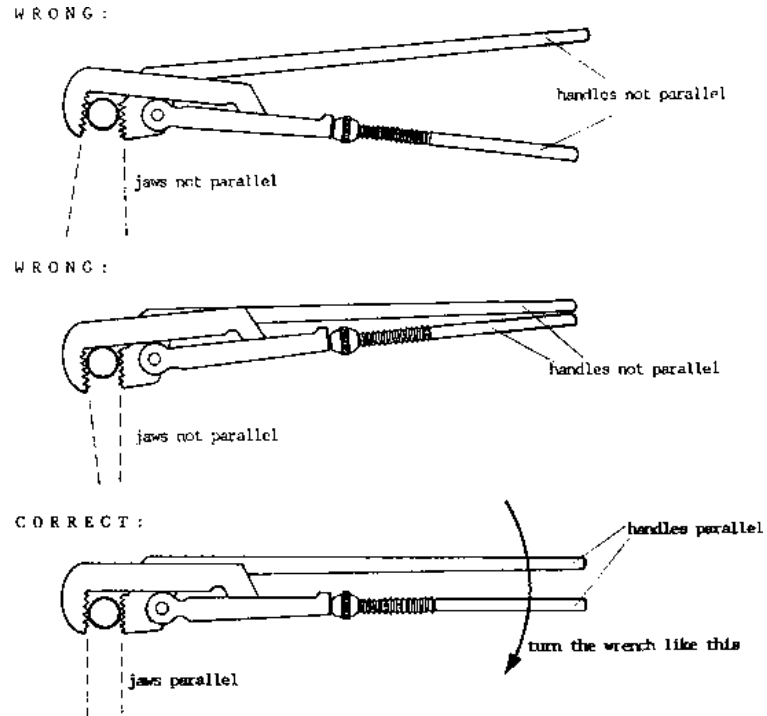

- Grip the two handles properly. If you have correctly adjusted the wrench, the two handles will be near enough to be easily pressed together, but not too near.

- Screw the pipe by turning the wrench as indicated in the drawing. For tightening a pipe and socket, the two wrenches must be held in the opposite way:

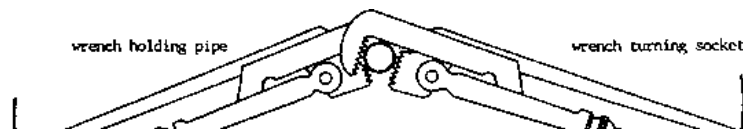



- When installing several pipes and sockets after each other, use always the same wrench for the socket and the other for the pipe. Thus, you will not have to re-adjust the wrenches every time.

- Never turn the serrated (= toothed) jaws of the wrench on the pipe, because this damages the teeth of the jaws as well as the pipe. The pipe will start to corrode at those spots. Good plumbing work leaves hardly any marks on the pipe.

C) Pipe Joints

Pipes can be joined together by different methods. The joining pieces are called fittings. Different types of pipe joints and other fittings are compiled here.

1. Male and Female Pipe Threads

Pipes with male and female threads can be joined directly.

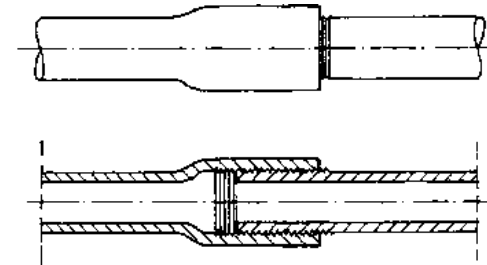

2. Socket (= Coupling)

for joining tapered pipe threads. You must be able to turn one of the pipes for connecting.

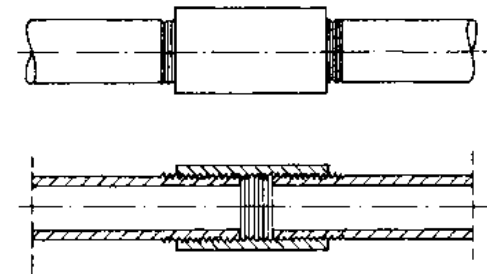

3. Socket with Backnut

for pipes with parallel threads. The backnut ensures water tightness.

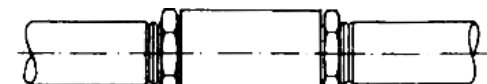

4. Nipple
for joining two pipes with internal threads.

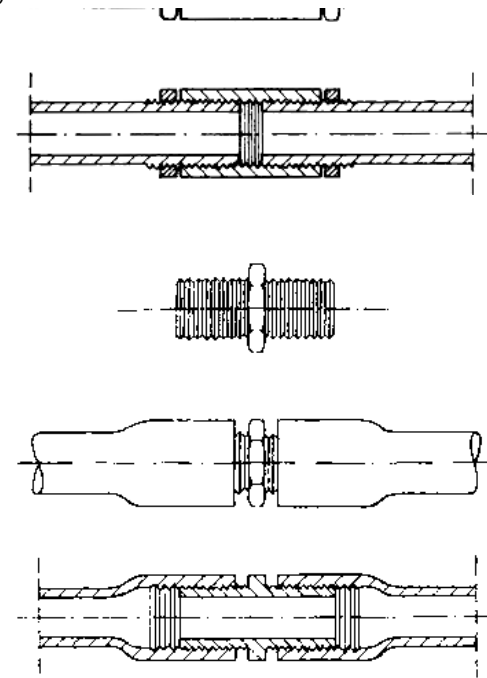

5. Reducer
for joining two pipes with different diameter and internal threads.

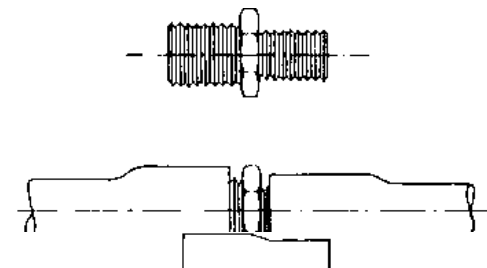

6. Reducer Socket

for joining two pieces with different diameter and external threads.

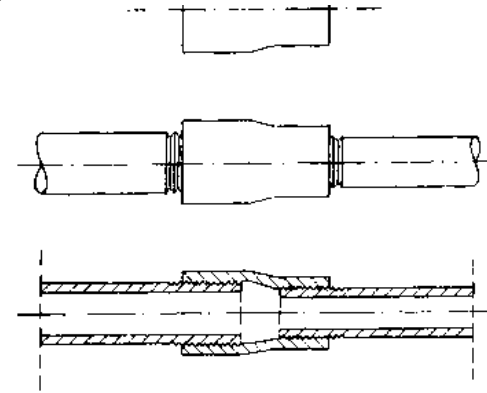

7. Tee-Joint (= Tee-Piece)
for branching pipes.

8. Elbow for corners.

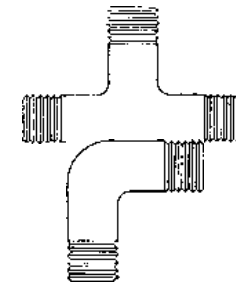

9. M & F - Elbow
male-female elbow, for corners.

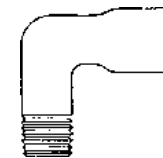

10. Pipe Cap
for closing a dead-end pipe with external thread.

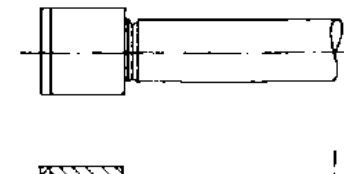

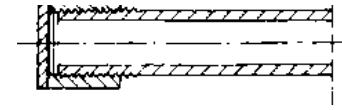

11. Plug
for closing a dead-end pipe with internal thread.

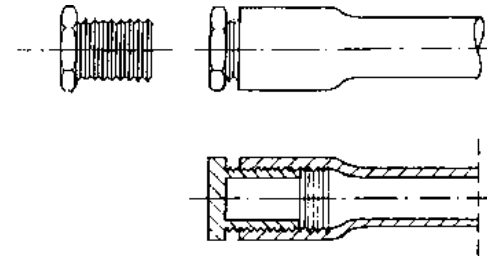

12. Union Joint
for connecting already installed pipes which cannot be turned.

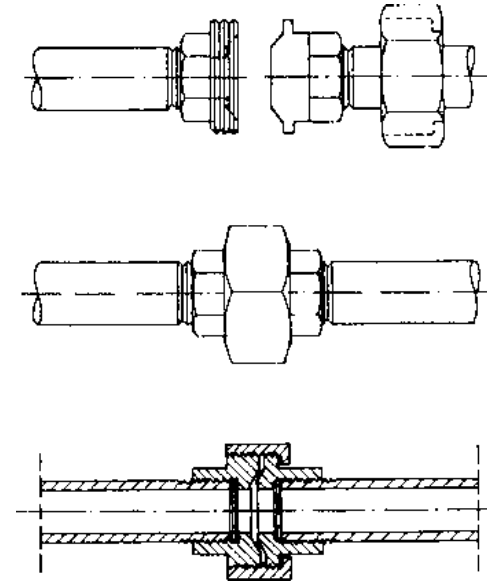

13. Flange Joint
for large diameter pipes ($\text{\O} 3''$ and more).

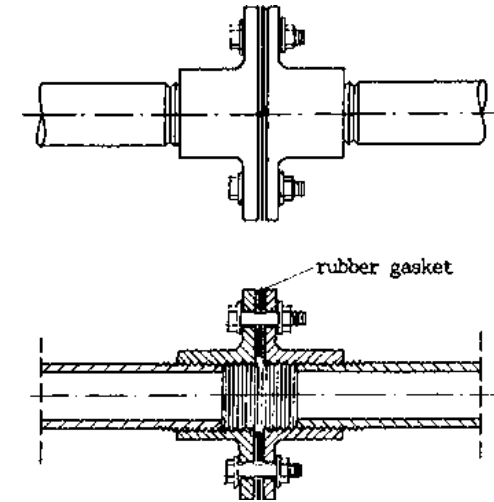

14. Welded Joint
for permanent installations.

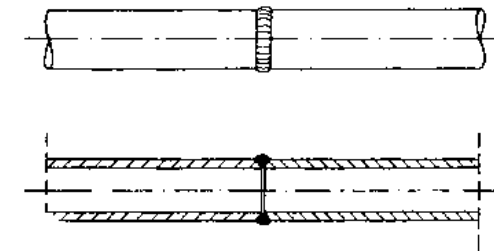

15. Hose Connection
for connecting a hose to a pump or a tap with thread.

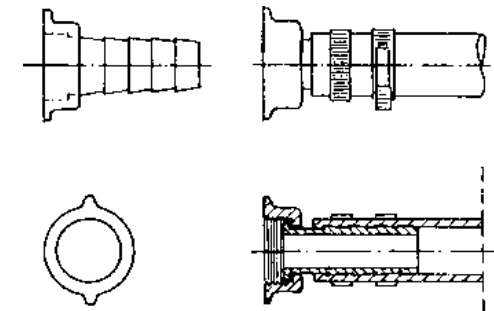

16. Dog Clutch

for quick connection of two pipes or hoses with dog clutches by a quarter turn, e.g. for fire brigade.

**8.33. Hand Pump Caretaking**

The crucial question in operating a water point is: Whom does the water point belong to? The caretaker? The Community? The contractor? The ownership will determine whom the water point will serve and who will be favoured.

A hand pump caretaker is essential for the functioning of a hand pump. She/he has technical and social duties and functions.

A) Daily Technical Duties

No.	Duty	Reasons
1	Sweep the platform and the surroundings. Keep the drainage free.	A water point needs to be clean in order to provide clean water.
2	Open and lock the pump according to opening hours.	The pump shall be used according to the regulations set up by the community.
3	Pump some water and check if operation and discharge are normal.	Any break-down is easier to repair if discovered immediately.
4	Report break-down of the pump immediately and lock the pump.	

B) Weekly Technical Duties

No.	Duty	Reasons
1	Grease the chain.	A greased chain lasts longer and makes operation easier.
2	Tighten all bolts.	Loose bolts cause unnecessary movement and lead to breakage.
3	Check if the platform has any cracks and repair it with cement mortar.	Cracks allow dirty water to enter the well.

C) Social Duties

No	Duty	Reasons
1	Be in time and keep to opening hours.	To be hand pump caretaker means to serve the community. People will appreciate and respect you if they see that you are reliable, honest and just.
2	Behave politely.	
3	Make sure that the queue is kept correctly, and nobody favoured.	

4	Do not allow people to pump if they do not join the queue.	
5	Collect the money for the water.	
6	Do not give water to anybody free of charge or for less than the community decided.	
7	Deliver the money collected correctly.	
8	Teach the users to operate the pump correctly.	
9	Prevent the users from dirtying the platform and surroundings.	
10	Be honest and just.	

If the above duties are fulfilled, the hand pump will serve the community members equally and justly. This is only possible if the community controls the hand pump and the caretaker by a functioning committee. In this case, the income can be used for maintenance and other community projects (e.g. building new wells or latrines), beside a reasonable “salary” for the caretaker.

At present, few caretakers in Juba act according to these principles. The reason is first, that somebody who has not paid for the well claims ownership over the hand pump (or is given it as a contractor by the government) and, thus, makes profit out of the users and even abuses them. Secondly, the users act individually and do not organise themselves as a community and accept the present situation without readiness for commitment and change.

See also questionnaire about water sources and hand pump use, 4.23/5-9.

8.34. Calculation of Pump Discharge

It is important to know the yield of every pump

- for observation (any decrease of the yield means technical problems in the pump and requires maintenance).
- for estimating the required time to pump a well empty;
- for comparing different types of pumps.

There are special devices to measure the waterflow in a pipe and, thus, the yield of a pump, but these are mostly not available. Therefore, we have to measure the yield of a pump by other, simple methods.

A) Units of Pump Discharge

The discharge or yield of a pump can be expressed in different units:

$$\underline{\quad} \quad \ell/\text{sec} = \ell \text{ ps} = \text{litre per second}$$

$$\frac{\ell}{\text{min}} = \ell/\text{min} = \ell \text{ pm} = \text{litre per minute}$$

$$\frac{\ell}{\text{h}} = \ell/\text{h} = \ell \text{ ph} = \text{litre per hour}$$

$$\frac{\text{m}^3}{\text{h}} = \text{m}^3/\text{h} = \text{m}^3\text{ph} = \text{cubic metre per hour}$$

$$\frac{\text{m}^3}{\text{min}} = \text{m}^3/\text{min} = \text{m}^3\text{pmin} = \text{cubic metre per minute}$$

The different units are connected as follows:

$$1 \ell/\text{sec} = 60 \ell/\text{min} = 3,600 \ell/\text{h} = 3.6 \text{ m}^3/\text{h} = 0.06 \text{ m}^3/\text{min}$$

$$1 \ell/\text{min} = 60 \ell/\text{h} = 0.06 \text{ m}^3/\text{h} = 0.001 \text{ m}^3/\text{min}$$

Use this transformation table to change one unit to another:

		to these:				
		ℓ/sec	ℓ/min	ℓ/h	m^3/h	m^3/min
If you want to change these units	t/sec		x 60	x 3,600	x 3.6	÷ 16.7
	ℓ/min	÷ 60		x 60	÷ 16.7	÷ 1,000
	ℓ/h	÷ 3,600	÷ 60		÷ 1,000	÷ 60,000
	m^3/h	÷ 3.6	÷ 16.7	x 1,000		÷ 60
	m^3/min	÷ 16.7	÷ 1,000	x 60,000	x 60	

How to use a transformation table is explained on 5.3/1.

B) First Method to Measure the Yield of a Pump

No.	Step	Example
1.	Record the time you start pumping and measure the water table.	$t_{\text{start}} = 9.31$, $WT_{\text{start}} = 12.05 \text{ m}$

2.	Record the time you stop pumping and measure the water table.	$t_{\text{end}} = 9.45$, $WT_{\text{end}} = 12.65$ m
3.	Measure the diameter of the well at the water table.	$\varnothing = 1.20$ m
4.	Calculate the time needed for pumping $t = t_{\text{end}} - t_{\text{start}}$ For how to calculate a period of time see 5.8/3.	$t = 45$ min - 31 min = 14 min
5.	Calculate the volume of water pumped from the well (see 5.6/2): d = diameter r = radius h = drawdown = $WT_{\text{end}} - WT_{\text{start}}$ $V = \frac{1}{4} \times \pi \times d^2 \times h = V \times r^2 \times h$ $\pi = 3.14$	$d = 1.20$ m $h = 12.65$ m - 12.05 m = 0.60 m $V = \frac{1}{4} \times 3.14 \times 1.20^2 \text{ m}^2 \times 0.60 \text{ m} = 0.678 \text{ m}^3$
6.	Calculate the yield: $\text{yield} = \frac{\text{volume}}{\text{time}} ; Q = \frac{V}{t}$	$Q = \frac{0.678 \text{ m}^3}{14 \text{ min}} = 0.0484 \text{ m}^3/\text{min}$
7.	Transform the result into m^3/h .	$Q = 0.0484 \times 60 \text{ m}^3/\text{h} = 2.90 \text{ m}^3/\text{h}$

If the diameter when starting pumping is not the same as the diameter when ending pumping, take the average diameter for an approximate calculation:

$$d = \frac{1}{2}(d_{\text{start}} + d_{\text{end}})$$

C) Second Method to Measure the Yield of a Pump

No.	Step	Example
1.	Record the time and start to pour the water discharged by the pump into an empty barrel.	$t_{\text{start}} = 8.06$, 0 sec
2.	Record the exact time in seconds when the barrel is full.	$t_{\text{end}} = 8.07$, 25 sec
3.	Calculate the time needed for filling the barrel (see 5.8/3): $t = t_{\text{end}} - t_{\text{start}}$	$t = 1$ min + 25 sec = 60 sec + 25 sec = 85 sec
4.	Determine, measure or calculate the volume of the barrel(see 5.6)	$V = 200$ ℓ
5.	Calculate the yield:	$Q = \frac{200 \text{ ℓ}}{85 \text{ sec}} = 2.35 \text{ ℓ/sec}$

	$\text{yield} = \frac{\text{volume}}{\text{time}} ; Q = \frac{V}{t}$	
6.	Transform the result into l/min with the transformation table.	$Q = 2.35 \times 60 \text{ l/min} = 141 \text{ l/min}$
7.	Transform the result into m ³ /h.	$Q = 2.35 \times 3.6 \text{ m}^3/\text{h} = 8.46 \text{ m}^3/\text{h}$

D) Yields of Some Pumps for Comparison

Average yields of some pumps are roughly estimated here and expressed in different units for comparison. It is advisable to memorize pump yields only in one chosen unit, e.g. m³/h.

No.	Pump	Average Yield (Approximately)			
		ℓ/sec	ℓ/min	ℓ/h	m ³ /h
1.	India Mark II hand pump	0.22	13.3	800	0.8
2.	submersible pump HOMA 725 DHD	0.83	50	3,000	3
3.	diaphragm pump, handoperated	2.22	133	8,000	8
4.	petrol suction pump Honda WA 30X	8.33	500	30,000	30

8.35. Spring Protection

This chapter compiles the most basic information about spring protection. For more details see in the bibliography No. 44, 45, 46.

A) Purpose of Spring Protection

A spring is a place where water is naturally issued from the ground by continuous flow. A spring protection is being artificially constructed to serve the following purposes:

1. It shall protect the spring from contamination.
2. It shall improve the accessibility of the spring for the users.
3. It shall increase the water flow, if possible.

B) Different Spring Types

Springs can be differentiated according to the shape of the opening the water flows from. We differentiate seepage springs, where the water comes out of many tiny openings, and springs with a single opening like a fracture or a round hole.

However, springs are mainly differentiated according to the type of aquifer (open or confined aquifer) and the form of the surface. So, we differentiate the following types:

OVERVIEW ABOUT SPRING TYPES

No	Spring Type	Construction	Type of Water Outlet
	Gravity Springs		
1	Gravity Depression Spring	- preferably as well	- for seepage spring or single opening
2	Gravity Overflow Spring	- without springbox, or - with springbox with open side, or - with seepage trench and spring box, or - as combination spring-well, or - as horizontal well	- for single opening - for single opening - for seepage spring - for seepage spring or single opening - for single opening
	Artesian Springs		
3	Artesian Depression Spring	- with springbox with open bottom	- for single opening
4	Artesian Overflow Spring	- with springbox with open sides, or - with seepage trench and springbox	- for single opening - for seepage spring

The different spring types are briefly introduced in the following:

1. Gravity Depression Springs

Gravity depression springs occur where groundwater emerges at the surface because an impervious (= impermeable) layer prevents it from seeping downwards. A gravity depression spring emerges in a sunk area (= depression). It usually has a very small yield and is difficult to seal against contamination. Its presence shows the level of the water table. Water can be extracted safely if a well is constructed nearby on a higher ground.

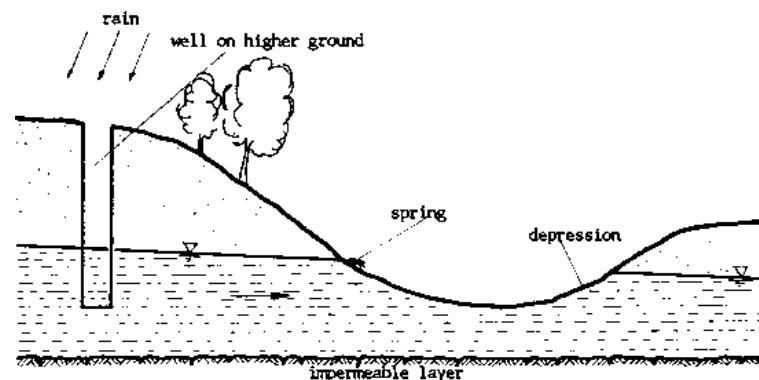

2. Gravity Overflow Springs

The gravity overflow spring usually occurs on slopy ground as a hillside spring. Its flow changes with variations of the water table during the different seasons.

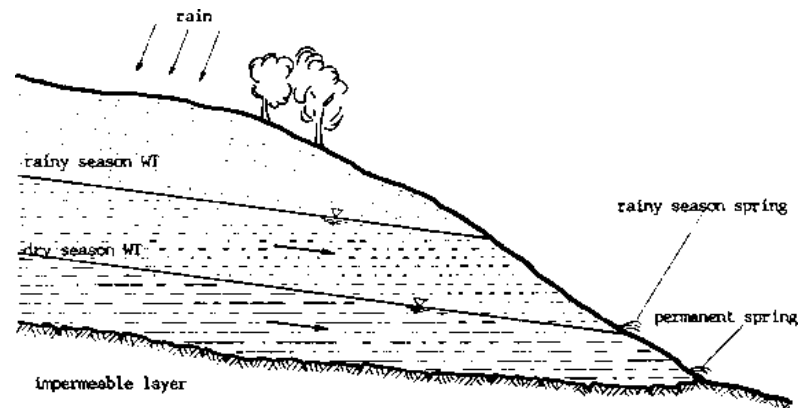

3. Artesian Depression Springs

Artesian depression springs occur where groundwater emerges at the surface after being confined (= shut up, kept) between two impermeable layers. The water emerges due to the internal pressure within the confined aquifer. The yield is usually very consistent and higher than of a gravity depression spring. An artesian depression spring emerges in a sunk area. A spring box with an open bottom is required for protection. See also 8.8/2.

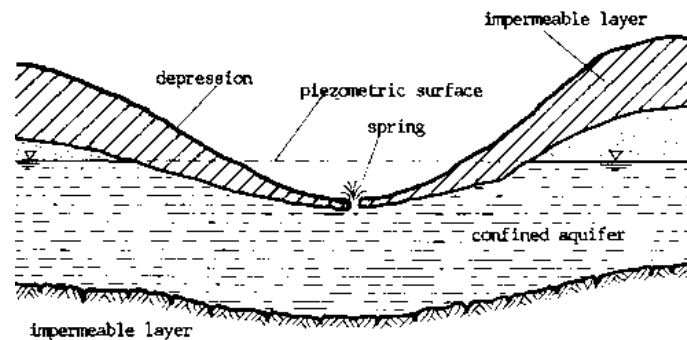

4. Artesian Overflow Springs

At an artesian overflow spring, the confined aquifer emerges at a hillside through a fracture in rock or an opening in the impermeable layer. The water flow is usually very constant. They are a very good source for community water supply, because they are protected from contamination by the overlying impermeable layer. If the spring flows through a single opening, a spring box with open side is suitable. If the water flows out through several openings, seepage trenches become necessary. See also 8.8/2.

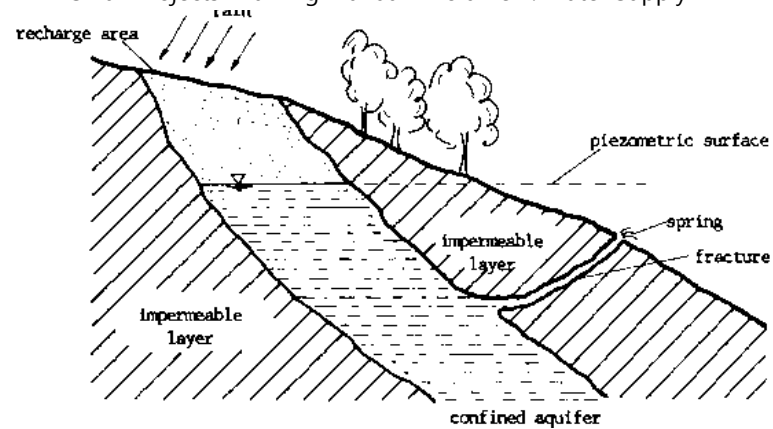

C) Different Spring Protection Designs

The different types of designs how to protect a spring are described in the following. Some designs are suitable for different types of springs.

1. Spring without Springbox

A spring without a springbox, but protected, consists of an impervious retaining wall with an outlet backfilled with stones and covered with puddled clay. It is suitable for gravity overflow wells with a single opening.

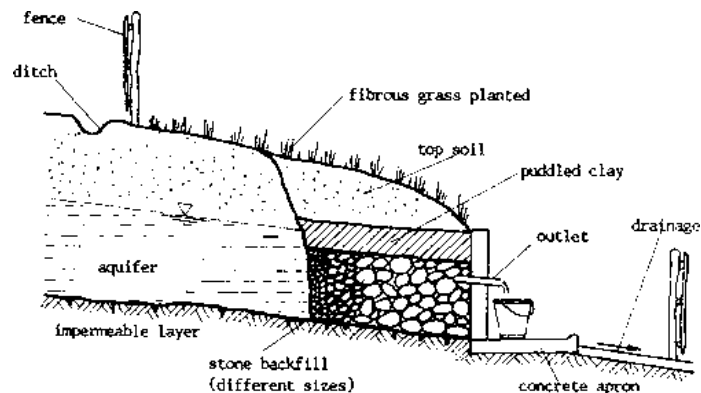

2. Spring with Springbox with Open Side

A springbox (= chamber = intake box = collection box) serves for collecting and storing the water. It can be built from concrete (with one side open), from masonry (with one side built without mortar), or from a concrete ring (with one side open or as filter). It has a removable, watertight, and lockable concrete lid. It is suitable for gravity overflow springs or for artesian overflow springs.

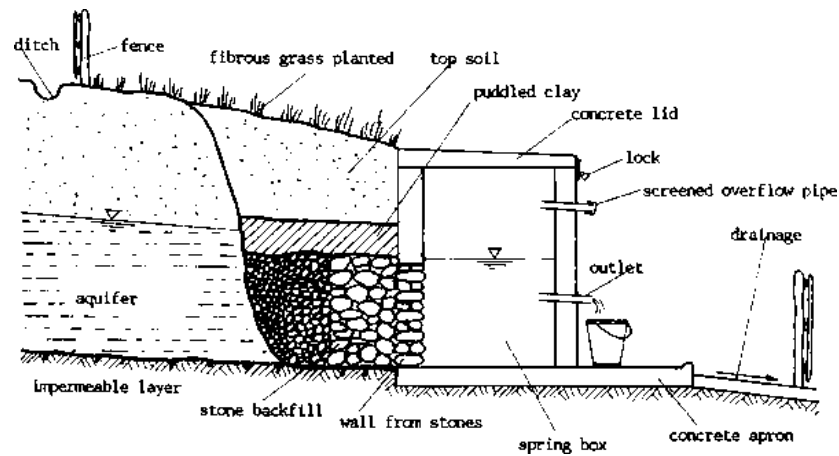

3. Spring Box with Open Bottom

If a spring flows from a single opening on more or less level ground, a springbox with an open bottom is suitable. This is the case for artesian depression springs. The box can be built on site from concrete or bricks, or a concrete ring can be used.

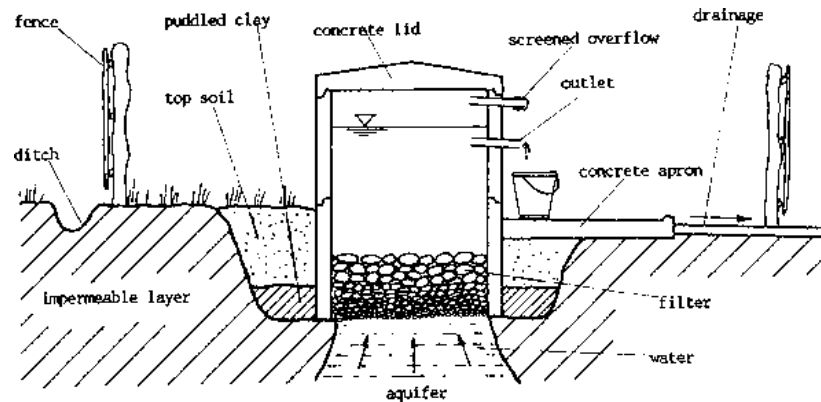

4. Spring with Infiltration Trenches and Springbox

If a gravity or artesian overflow spring occurs for a distance along the hillside, the water must be collected with infiltration trenches. They are dug deep into the hillside to contact the aquifer even in dry season. Slotted plastic pipes or short clay pipes surrounded with rocks and gravel collect the water and pipe it to the spring box. The pipes must have a slope. The openings on the pipes must be big enough to allow water to enter, but small enough to keep out sediments and to prevent blockage. Vertical clean-out pipes connected with elbows to the end of the collectors extend a little above ground and are capped. They can be used to clean the system by flushing it.

It is important to collect all water and to prevent the spring from flowing around or under the construction and wash it out. The anti-seepage wall (= cut-off wall) prevents loss of water due to underflow. It must reach into the impervious layer. Alternatively, it can be made from compacted clay which acts as a dam.

Spring with Infiltration Trenches and Springbox

LAYOUT PLAN

LAYOUT PLAN

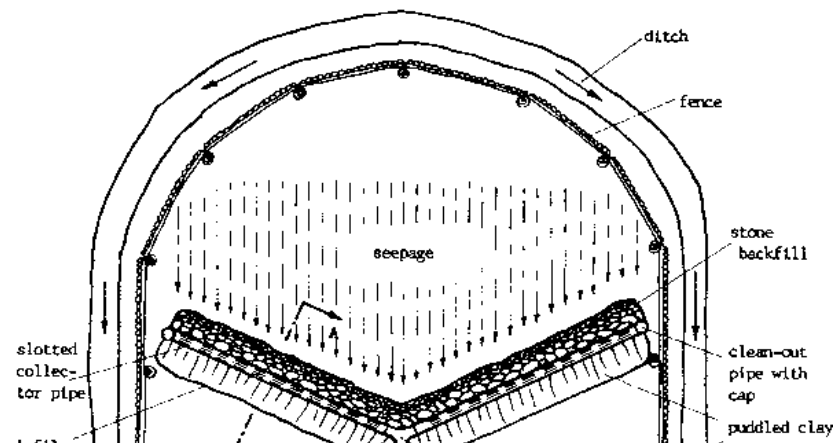

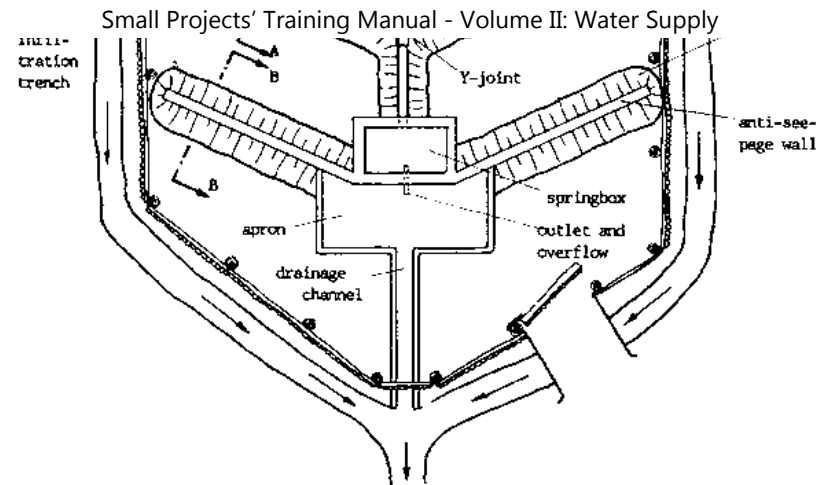

CROSS-SECTION A-A: INFILTRATION TRENCH

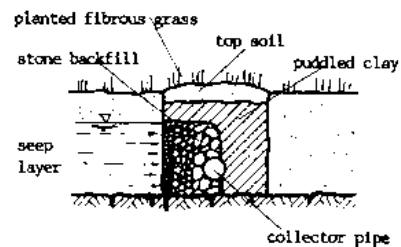

CROSS-SECTION B-B: ANTI-SEEPAGE WALL

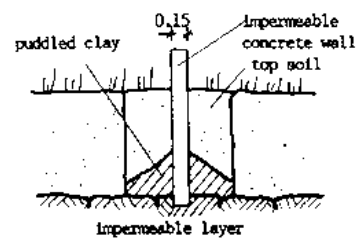

5. Horizontal Well

A horizontal well is suitable for a gravity overflow spring if the aquifer has a steep slope following the ground surface. A pipe with an open end or a perforated drive-point is driven into the aquifer horizontally and sealed all around.

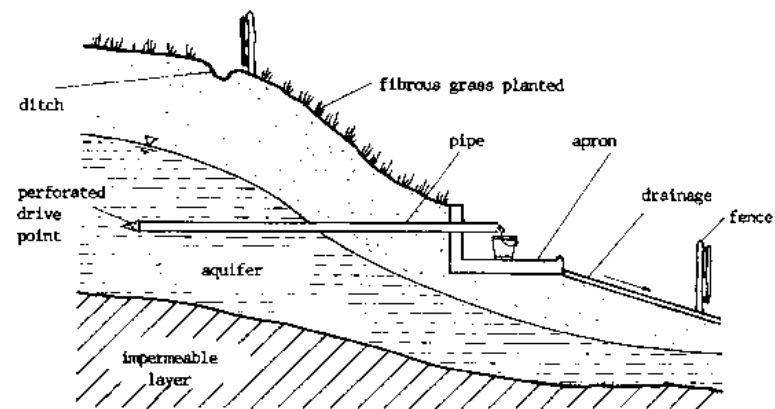

6. Combination Spring-Well

If a gravity overflow spring may dry up during dry season, then a well with a rainy season overflow (= water collection point) should be built. This is called a

combination spring-well.

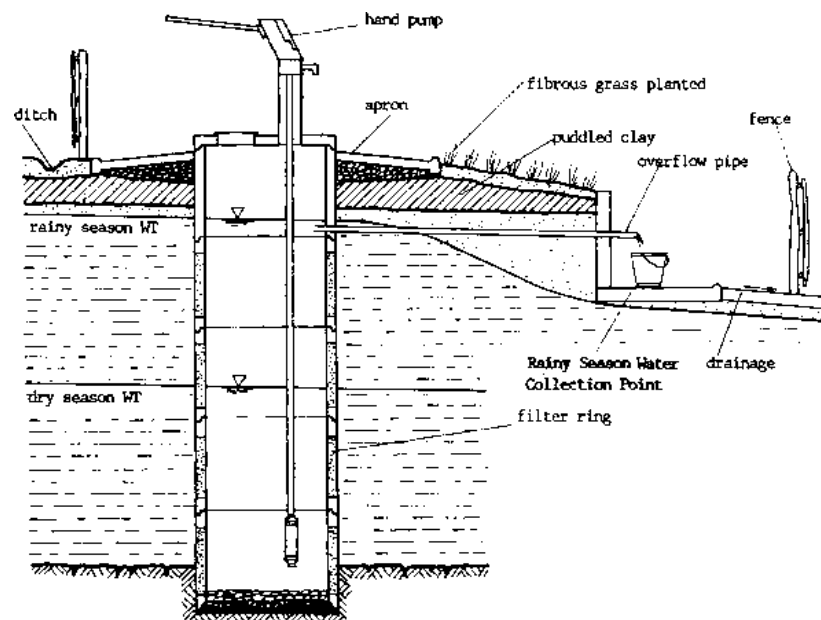

D) Essential Elements of a Spring Protection

A well protected spring has the following indispensable elements:

1. Springbox

It must be durable, impermeable on three sides, and permeable towards the spring.

2. Cover

The cover, preferably from reinforced concrete, must be heavy, lockable, and have a slope to drain the rainwater.

3. Overflow Pipe

The overflow pipe is installed at the highest water level to prevent building up of pressure inside the springbox. It must be screened with a non-corroding screen from copper or plastic to keep animals out. It can serve as air-vent at the same time.

4. Distribution Pipe (= Discharge Pipe = Outlet = Spout)

The distribution pipe supplies the water to the users. It can also lead to a separate storage tank downhill. If the yield of a spring is low, the distribution pipe can be equipped with a tap to allow water to collect inside the springbox.

5. Sealing with Puddled Clay

Different parts of the spring protection system have to be sealed with puddled clay. Puddled clay is clay which is worked while wet into a compact mass that becomes impervious to water when dry. It is the same type of "mudding" which is used to build a tukul. Puddled clay has to be smeared in 5 cm thick layers, to be compacted with the feet, and to be well compacted. An impervious layer must be at least 30 cm thick, i.e. it must be smeared in six layers.

6. Protective Planting

The area around the spring must be planted with a strong type of grass (fibrous grass) to prevent erosion (= the surroundings from being washed out).

7. Fencing

The spring must be fenced to prevent animals. Preferably, a hedge should be planted for easier maintenance and cheaper costs.

8. Surface Drainage Ditch (= Diversion Ditch)

A surface drainage ditch must be constructed around the spring to divert all rainwater. It should be about 8 to 10 m away from the spring-box. It should be lined with gravel or stones to increase flow and to prevent erosion of the sides.

9. Area Cleanliness

The area around the spring in a radius of 50 to 100 m must be free from latrines and other sources of pollution.

E) Planning a Spring Protection

For planning a spring protection, consider these steps:

1. Consult the local people where the springs are in the area. Ask which ones stop flowing during dry season.
2. Investigate around the area and check to see if the spring is not in reality a stream which has gone underground and is reemerging.
3. The springbox should not be built on swampy ground.
4. The springbox should not be threatened by flood or erosion.
5. Check if the water looks clear.
6. Check the flow of the spring. Measure it with buckets (l/min).
7. Check if there are possible sources of contamination nearby.
8. Identify what kind of spring you have (see B) and what type of design to use (see C).
9. Check if the water rights in the area allow the construction of a spring protection.
10. Get or draw a map of the area, including the spring site(s), the nearest houses, latrines, etc., the distances, the elevations, and important land

F) Constructing a Spring Protection

The construction of the different designs for spring protection shall not be discussed here in detail. However, some basic principles shall be listed here, valid for all designs:

1. Set the distribution pipe level first before the construction begins. Drive a large wooden peg into the ground outside the area to be excavated. Never disturb this reference peg.
2. While excavating, take care not to disturb the ground formations. Without care, the flow of the spring might be deflected into another direction. Careful digging around the eye of the spring might increase the flow.
3. The foundation of all parts of the spring protection must reach into the impermeable layer.
4. Dig a temporary drainage channel while building the springbox to be able to work in a relatively dry area.

G) Maintenance of a Spring Protection

A spring protection needs a small amount of maintenance in order to prevent water contamination, ensure long life and give optimum service to the users. How water distribution and maintenance are organised is up to the community (see also social duties of a hand pump caretaker 8.33). In the following we list only the technical steps of maintaining spring structures, which should be done regularly, at least once a year.

1. Check if water from the surface is likely to enter the spring and contaminate it.

Surface water is likely to enter the spring

- if the water temperature is higher during the day than at night;
- if the yield increases after a rain;
- if the turbidity increases after a rain.

2. Check if any water is seeping beside or underneath the spring structure. If water seeps out, seal the leak with clay or concrete.
3. Check the surface drainage ditch. Clean it, remove any obstacles and improve it, if necessary.
4. Check the fence and repair it, if necessary.
5. Check if the springbox and anti-seepage walls are solid or are washed out by erosion. If there are signs of erosion, fill the holes with earth and gravel, plant grass and improve the drainage ditches.
6. Clean the springbox from sediments.
7. If there are infiltration trenches, flush them with water through the clean-out pipes.

8. Check if the cover of the springbox is watertight.
9. Check the screening of the pipes and replace it, if necessary.
10. Disinfect the spring once a year (see 8.36).
11. Take periodically samples from the spring and let them be examined in a water laboratory, if possible.

8.36. Well Disinfection

Hand dug wells are contaminated by workers and equipment during construction.(Urinating and defaecating in the well during construction are strictly forbidden). Boreholes are contaminated by equipment and casings. Hand pumps are contaminated by pipes, rods and tools. Therefore, after completion of a well and after each hand pump maintenance a well needs to be disinfected in order to provide safe and uncontaminated water to the consumers.

There are different methods to clean the water of a well:

A) Chlorination

Chlorination is a way of chemical disinfection and is the most commonly used form of disinfection. Basic information about this method is compiled here.

1. Dosage

Different dosages are used. They are indicated in mg/ℓ or ppm. 1 mg/ℓ is the same as $1 \frac{\text{mg}}{\ell}$ and stands for 1 milligram per litre. 1 mg/ℓ means that there is 1 mg chlorine (the chemical chlorine available for disinfection) in 1 ℓ water. 1 ppm stands for 1 part per million and means 1 mg chlorine per 1 million mg water, as 1 ℓ water = 1 kg = 1,000 g = 1,000,000 mg (see also 5.3/5).

Dosage	Description
30 ppm	strong chlorination for disinfecting wells after construction or maintenance. Not drinkable.
5 ppm	moderate chlorination for disinfecting wells under use or water in the household. Not drinkable.
3 ppm	dosages above 3 ppm can cause diarrhea.
0.3 - 1.0 ppm	residual chlorine in drinking water. Drinkable.

Chlorine is available in different forms, as powder or as liquid.

Bleaching powder has 25-35% available chlorine, that means that only 25-35% of the powder is chlorine and is available for disinfecting the water.

Old bleaching powder has become weak and has lost most of its initial chlorine. Therefore, we assume only 5% available chlorine in it.

High strength calcium hypochlorite has 70% available chlorine; it is more expensive than bleaching powder and more difficult to get.

Liquid bleach is a chlorine solution, e.g. 5%. sodium hypochlorite. 5% solution means that 5% of the solution is the chemical, the rest is water. 1 ℓ of a 5%

solution contains (as 1 ℓ = 1000 g)

5% of 1,000 g = 50 g chlorine = 50,000 mg chlorine.

Thus a 5% solution is the same as 50,000 mg/ℓ or 50,000 ppm.

2. Handling Chlorine

Once a container with chlorine is opened, it fairly rapidly loses its initial chlorine content, especially, if exposed to air, moisture, heat and light. Also, chlorine is very corrosive.

Therefore:

Store chlorine in dry, close, dark, non-rusting containers in a cool place, like

- plastic jerrycan, painted black;
- nylon bag put into a closed tin;
- dark bottle well closed.

During chlorination take into account that the disinfectant may have lost strength and, in this case, add more.

It is essential to add sufficient chlorine to satisfy the chlorine demand of the water and to have a little spare chlorine left which is called “free active chlorine” or “residual chlorine”.

The water should be clear (that is without turbidity) before chlorination. Otherwise a higher dose is needed.

Treat chlorine powder and solution carefully. Do not touch the disinfectant. Never drink a chlorine solution. It is extremely dangerous because it eats up the stomach inwardly. Mind your eyes; if chlorine has touched your eye, rinse it with water immediately for 10 minutes.

3. Steps of Chlorination

For chlorinating a well after construction, follow these steps:

a) Calculate the volume of the water in the well (see also 5.6/2):

$$V = \pi \times r^2 \times h$$

Volume (m³) = inside diameter (m) × $\frac{1}{2}$ inside diameter (m) × 3.14 × depth of the water from the bottom to the water table (m)

Example:

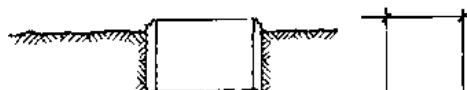

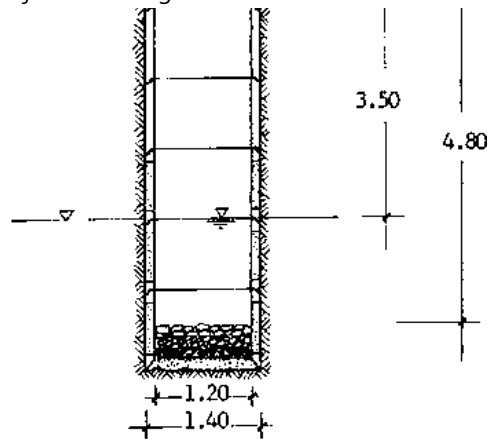

SCALE 1:80

$$h = 4.80 - 3.50 = 1.30 \text{ m}$$

$$r = 1.20 \div 2 = 0.60$$

$$\pi = 3.14$$

$$V = 0.60 \text{ m} \times 0.60 \text{ m} \times 3.14 \times 1.30 \text{ m} = 1.47 \text{ m}^3$$

b) Check what kind of disinfectant you have and its percentage of available chlorine.

c) From table 1 (see 8.36/4) find the amount of chlorine that will have to be added to the volume of water to produce a strong chlorine solution (30 ppm).

d) Dissolve the required amount of the chemical in a bucket of water before adding it to the well. This solution must have a strong chlorine odour (= smell); otherwise, it has less available chlorine content than you assumed and you must add more.

e) Pour the solution into the well. It is best to agitate the water to ensure that the chlorine is evenly mixed. Pump the hand pump a bit until the pipes are filled with chlorine solution.

f) The strong chlorine solution should be left in the well for at least 12 hours and preferably 24 hours; it must be stressed that this strong chlorine solution is not suitable for humans or animals.

g) After 12 to 24 hours contact time, the strongly chlorinated water should be pumped from the well until the residual chlorine level is below 1.0 mg per litre of water (with little chlorine taste). The pumping equipment to be installed on the well can be disinfected by using it to remove the excess chlorine. Choose a disposal place for the chlorine solution where it will have as little contact with plants and animal life as possible.

TABLE 1 FOR DISINFECTION OF WELLS AFTER CONSTRUCTION

The approximate dosage is 30 mg/ℓ (= 30 ppm). Do not drink this water after disinfection. Empty the well after 12 to 24 hours contact time until the residual chlorine is about 0.3 to 1.0 mg/ℓ (= 0.3 to 1.0 ppm) and the water has only slight chlorine odour and taste. Then you can drink it.

Water			Powders						Liquid				
			old (weak) bleaching powder 5%		bleaching powder 25-35%		high strength calcium-hypochlorite 70%.		liquid bleach 5%. sodium hypochlorite				
220 ℓ =	1	drum	132	g = $1\frac{3}{4}$ salsal	22 g =	$2\frac{1}{2}$	tablesp.	9 g =	1	tablespoon	132 ml =	$1\frac{3}{4}$	salsal
1000 ℓ =	1	m ³	600	g = 8 salsal	100 g =	$1\frac{1}{3}$	salsal	43 g =	5	tablespoons	600 ml =	= 8	salsal
	1.5	m ³	900	g = 12 salsal	150 g =	2	salsal	65 g =	7	tablespoons	900 ml =	= 12	salsal
	2	m ³	1.2	kg	200 g =	$2\frac{2}{3}$	salsal	86 g =	$1\frac{1}{4}$	salsal	1200 ml =	= 1.2	ℓ
	2.5	m ³	1.5	kg	250 g =	$3\frac{1}{3}$	salsal	110 g =	$1\frac{1}{2}$	salsal		1.5	ℓ
	3	m ³	1.8	kg	300 g =	4	salsal	130 g =	$1\frac{3}{4}$	salsal		1.8	ℓ
	3.5	m ³	2.1	kg	350 g =	$4\frac{2}{3}$	salsal	150 g =	2	salsal		2.1	ℓ
	4	m ³	2.4	kg	400 g =	$5\frac{1}{3}$	salsal	170 g =	$2\frac{1}{4}$	salsal		2.4	ℓ
	5	m ³	3.0	kg	500 g =	$6\frac{2}{3}$	salsal	215 g =	3	salsal		3.0	ℓ
	6	m ³	3.6	kg	600 g =	8	salsal	260 g =	$3\frac{1}{2}$	salsal		3.6	ℓ
	7	m ³	4.2	kg	700 g =	$9\frac{1}{3}$	salsal	300 g =	4	salsal		4.2	ℓ
	8	m ³	4.8	kg	800 g =	$10\frac{2}{3}$	salsal	340 g =	$4\frac{1}{2}$	salsal		4.8	ℓ
	9	m ³	5.4	kg	900 g =	12	salsal	385 g =	5	salsal		5.4	ℓ
	10	m ³	6.0	kg	1000 g =	1	kg	430 g =	$5\frac{3}{4}$	salsal		6.0	ℓ
	12	m ³	7.2	kg		1.2	kg	520 g =	7	salsal		7.2	ℓ
	15	m ³	9.0	kg		1.5	kg	650 g =	$8\frac{2}{3}$	salsal		9.0	ℓ
	20	m ³	12.0	kg		2	kg	860 g =	$11\frac{1}{2}$	salsal		12.0	ℓ

								2			
	30	m ³	18.0	kg		3	kg	1300 g =	1.3	kg	18.0 ℓ
	40	m ³	24.0	kg		4	kg		1.7	kg	24.0 ℓ
	50	m ³	30.0	kg		5	kg		2.2	kg	30.0 ℓ
	100	m ³	60.0	kg		10	kg		4.3	kg	60.0 ℓ

Comparative measurements see Table 2, 8.37/3; ml = millilitre

g = gram

ℓ = litre

} see 5.3/4 kg = kilogram } see 5.3/5

m³ = cubic metre

4. Further Information

The amount of chlorine in the table was calculated as follows:

for powders:

$$\text{amount of disinfectant (mg)} = \frac{\text{dosage (mg/ℓ = ppm)} \times \text{quantity of water (ℓ)}}{\text{percentage of available chlorine (\%)} \times \frac{1}{100}}$$

Example:

1 m³ water, 30 mg/ℓ (= 30 ppm), high strength calcium hypochlorite 70%;

$$\frac{30 \text{ mg/ℓ} \times 1,000 \text{ ℓ}}{70 \times \frac{1}{100}} = 43,000 \text{ mg} = 43 \text{ g}$$

for liquids:

$$\text{amount of liquid (ml)} = \frac{\text{dosage (mg/ℓ = ppm)} \times \text{quantity of water (ℓ)}}{\text{percentage of solution} \times 10}$$

Note that 1 ml of a 5% solution contains, as 1 ml = 1 g:

5% of 1 g = 5% of 1000 mg = 5 × 1000 mg = 5 × 10 mg (see also 8.36/2)

Example:

1 m³ water, 30 mg/ℓ (= 30 ppm), liquid bleach 5%;

1 m³ water, 30 mg/l (= 30 ppm), liquid bleach 5%;

$$\frac{30 \text{ mg/l} \times 1,000 \text{ l}}{5 \times 10} = 600 \text{ ml}$$

B) Pumping

If no disinfectant is available, clean the well first thoroughly by hand and then pump the well as much as possible. This will reduce the contamination, but it is not a 100% safe method.

C) Treatment with Sand Filters

Locally made sand filters may be used to treat drinking water. They are simple and provide clean water, but need maintenance. For further details see the literature, especially No. 44 in the bibliography.

8.37. Water Treatment at Home

It is very important to have safe drinking water in the household. Different methods to treat the water at home in order to get safe drinking water are discussed here. Choose what is available and appropriate under the given circumstances.

A) Water from Safe Sources

To get water from a safe source is the best solution and, in this case, no treatment is needed. Hand dug wells with hand pumps and boreholes can be safe sources if the groundwater is not polluted and the platform has no cracks. Inquire if the water was tested in a laboratory and is safe.

However, if you cannot get your drinking water from a safe source, you can treat it with the following methods.

B) Sedimentation

If the water is of brownish colour and not clear (= turbid), it has a lot of suspended matter. This is called "turbidity". Before any further disinfecting, the suspended matter must be removed. Let the water stand over night until the suspended matter settles. Carefully pour off the clear water. This will reduce the contamination; therefore, you should do it even if you cannot treat the water further. But the water is not safe after sedimentation only.

C) Coagulation with Alum

Mix alum (= aluminium sulphate) with the water and let it settle. The particles of the alum will combine with the suspended matter and form small lumps. The lumps will settle. This process is called coagulation. Treating water with alum is a clarification process. The higher the turbidity, the more alum you need. It removes the turbidity and reduces the contamination, but does not provide safe drinking water.

D) Coagulation with Plants

The seeds of certain trees (e.g. moringa olifera) act like alum when powdered and can be used for coagulation. For further details see the literature.

E) Pouring Water through Cloth

Pouring water through a clean cloth can reduce the turbidity, but it does not remove the contamination; it is a pre-treatment method. Wash the cloth after

Filtering water through a clean cloth can reduce the turbidity, but it does not remove the contamination, it is a pre-treatment method. Wash the cloth after each use.

F) Chlorination

Chlorination is a common and simple form of water treatment in the home. For detailed information about chlorine see 8.36.

For chlorinating drinking water in the home, follow these steps:

1. Clarify the water by one of the methods mentioned above before chlorination.

2. Determine the quantity of water you want to disinfect:

1 water jerryccan = 20 ℓ = 0.02 m³

1 drum = 220 ℓ = 0.22 m³

3. Check what kind of disinfectant you have (if possible, from the label of the package) and its percentage of available chlorine. Commonly available powders are mostly bleaching powder.

4. From TABLE 2 on the next page, find the amount of chlorine to be added to the water to produce a moderate chlorine solution.

5. Dissolve the disinfectant in a cup of water.

6. Pour the solution into the water and stir it well. This initial dose shall produce a 5 ppm solution; it must have chlorine smell. Otherwise the chlorine has lost its strength and you must repeat the dosage.

7. Let the water stand for at least 30 minutes. The chlorine reacts with the organic and inorganic matter present in the water. After 30 minutes, the chlorine concentration ought to be reduced to less than 1 ppm.

8. After 30 minutes (or more), check for the residual chlorine. The treated water should have a slight chlorine odour and taste. If not, repeat the dosage (Return to step 3). If the water has still no chlorine odour, the disinfectant is expired and useless. If the water has too strong a chlorine taste, allow it to stand for a few hours. Contact with the air removes the taste and smell of chlorine.

G) Treatment with Iodine

Iodine can be used for disinfecting water. The water must be clear; treatment with iodine is not suitable for water with a high turbidity.

1. Clarify the water with one of the above methods before treatment with iodine.

2. Pour 2 drops of iodine per litre into the water (e.g. 40 drops per jerrycan and 440 drops per drum). Double the dose if the water is highly polluted. Stir the water.

3. Let it stand for 30 minutes. Then you can drink.

TABLE 2 FOR DISINFECTION OF DRINKING WATER

The approximate dosage is 5 mg/ℓ (= 5 ppm). Do not drink the water immediately after disinfection. After 30 min contact time the residual chlorine should be about 0.3 to 1.0 mg/ℓ (= 0.3 to 1.0 ppm). The water should have a slight chlorine odour and taste. Then you can drink it.

Water			Powders									Liquid		
			old (weak) bleaching powder 5%			bleaching powder 25-35%			high strength calcium hypochlorite 70%			liquid bleach 5% sodium hypochlorite		
20 ℓ =	1	jerryc.	2 g =	1	teaspoon	0.3	g		0.1	g		2 ml =	1	teaspoon
220 ℓ =	1	drum	22 g =	$2\frac{1}{2}$	tablespoons	3	g = 1	teaspoon	1.6	$g = \frac{1}{2}$	teaspoon	22 ml =	$2\frac{1}{2}$	tablesp.
1000 ℓ =	1	m ³	100 g =	$1\frac{1}{3}$	salsal	14	$g = 1\frac{1}{2}$	tablespoons	7	$g = 2\frac{1}{2}$	teaspoons	100 ml =	$1\frac{1}{3}$	salsal
	1.2	m ³	120 g =	$1\frac{1}{2}$	salsal	17	g = 2	tablespoons	9	g = 1	tablespoon	120 ml =	$1\frac{1}{2}$	salsal
	1.5	m ³	150 g =	2	salsal	21	$g = 2\frac{1}{3}$	tablespoons	11	$g = 1\frac{1}{3}$	tablespoons	150 ml =	2	salsal
	2	m ³	200 g =	$2\frac{2}{3}$	salsal	29	$g = 3\frac{1}{3}$	tablespoons	14	$g = 1\frac{1}{2}$	tablespoons	200 ml =	$2\frac{2}{3}$	salsal
	2.5	m ³	250 g =	$3\frac{1}{3}$	salsal	36	g = 4	tablespoons	18	g = 2	tablespoons	250 ml =	$3\frac{1}{3}$	salsal
	3	m ³	300 g =	4	salsal	43	$g = 4\frac{3}{4}$	tablespoons	21	$g = 2\frac{1}{3}$	tablespoons	300 ml =	4	salsal
	4	m ³	400 g =	$5\frac{1}{3}$	salsal	57	$g = 6\frac{1}{3}$	tablespoons	29	$g = 3\frac{1}{3}$	tablespoons	400 ml =	$5\frac{1}{3}$	salsal
	5	m ³	500 g =	$6\frac{2}{3}$	salsal	71	g = 8	tablespoons	36	g = 4	tablespoons	500 ml =	$6\frac{2}{3}$	salsal
				$\frac{1}{2}$	kg		= 1	salsal		$= \frac{1}{2}$	salsal		$\frac{1}{2}$	ℓ

Comparative Measurements(approximately)

1 teaspoon, flat 1 tablespoon, flat 1 salsal tin = tin for tomato paste	= 3 g chlorine powder = 9 g chlorine powder = 75 g chlorine powder	= 8 tablespoons chlorine powder
1 teaspoon 1 tablespoon	= 3 ml = 9 ml	= 8 tablespoons

1 salsal tin = tin for tomato paste	= 75 ml
-------------------------------------	---------

ml = millilitre; ℓ = litre; m³ = cubic metre (see 5.3/4); g = gram; kg = kilogram (see 5.3/5)

H) Boiling

Boiling destroys all forms of disease organisms in water. However, boiling requires a lot of firewood or other fuels and is very expensive.

Bring the water to a rolling boil; the water must be bubbling rapidly. Let it boil for 2-3 minutes.

Store the water in the same container in which it was boiled to prevent new contamination.

To boil a large quantity of water for many people, the boiler can be built from a drum (see drawing):

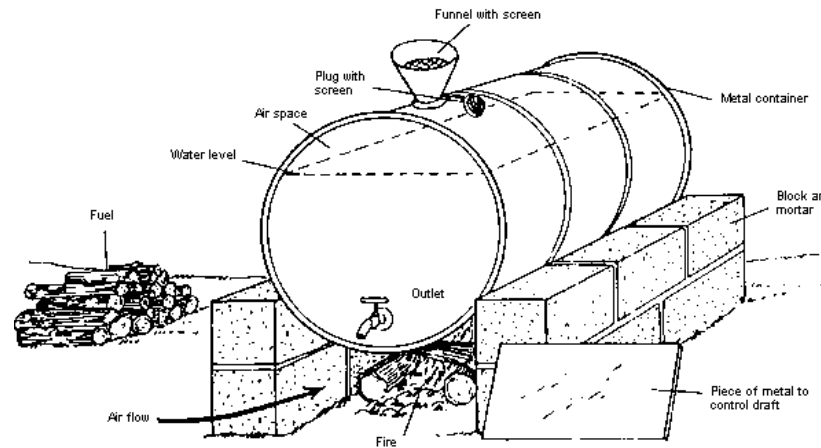

I) Filtering with Sand Filter

Household sand filters made from locally available materials can be used for cleaning the water.

Sand filters where the sand is not constantly covered by water clarify the water, but do not remove the bacteria. Sand filters where the sand is constantly

covered by water remove most of the bacteria.

For details see No. 44 in the bibliography and other literature.

A household sand filter is shown on the drawings next page. See also 6.1/22.

Household Sand Filter

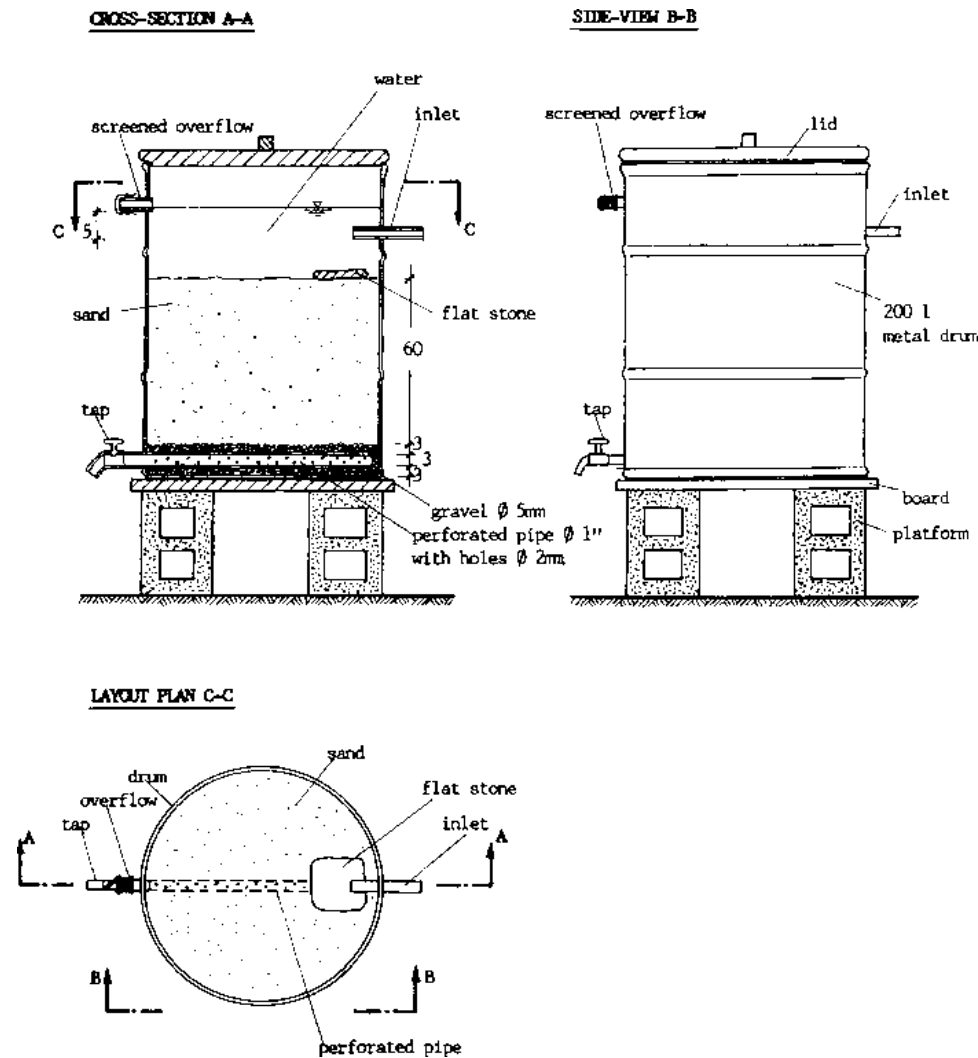

J) Filtering with Commercial Filters

Commercial filters with filter candles made from fired ceramics provide water free from bacteria, if maintained according to the instructions. They are relatively expensive and can filter only a limited amount of water per day.

relatively expensive and can filter only a limited amount of water per day.

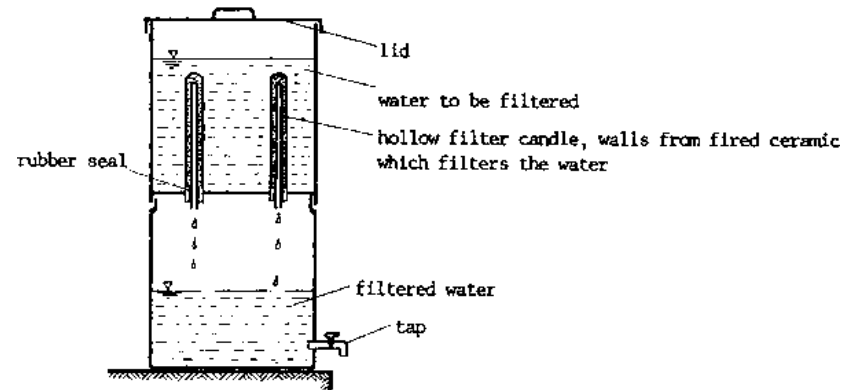

K) Storage

Five or six days water storage is enough to reduce the level of bacteria enough so that people can safely drink the water. If the water quality is poor, increase the length of storage.

Use two barrels with taps and covers. Fill both barrels and empty one completely before using water from the second. When use from the second barrel begins, refill the first barrel. Each time, clean the barrels carefully. Use the water from the barrels only for cooking and drinking.

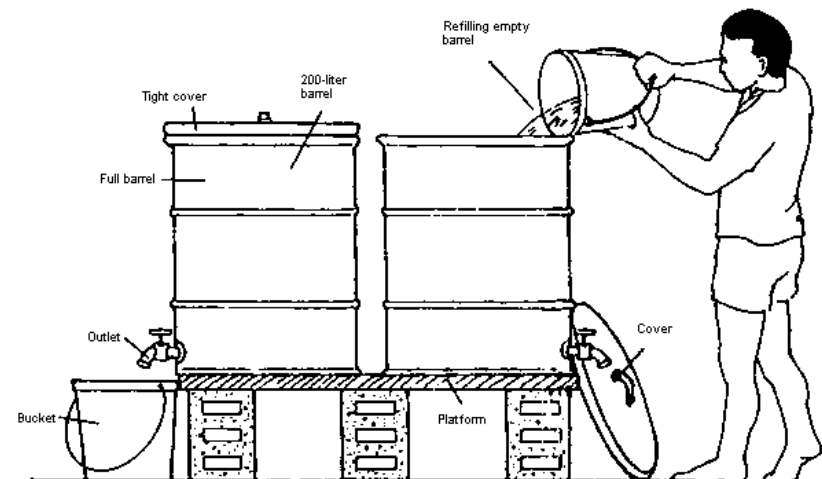

L) Heating

Expose jerrycans of water to the sun for one day. The water will be heated to 50-60°C. This will reduce organic contamination, but not remove it completely. See in the bibliography 46, July 1986.

M) Restriction of the Use of Safe Water

Restrict the use of the available safe water to basic needs like drinking, cooking, washing dishes, brushing the teeth. Use different water for bathing and washing the laundry.

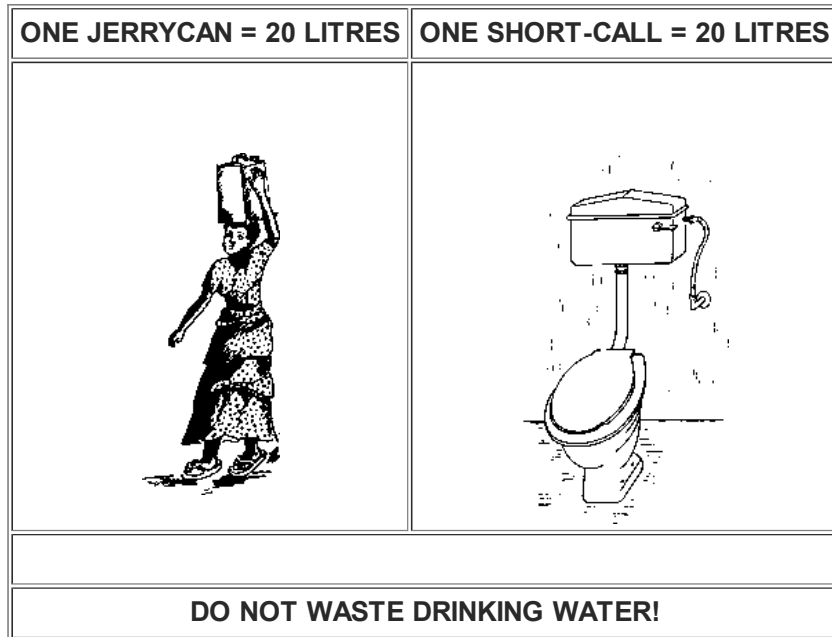

See also 8.29/5 and 9.8/2.

8.38. Handling Water at Home

A) Possible Ways of Contamination of Water from a Clean Source

Even if water is taken from a clean source which is safe for human consumption, we may afterwards still experience diseases. The reasons may be that the water is contaminated

- during collection and delivery to the home,
- during storage and use in the home.

This can happen in the following ways:

1. During Collection and Delivery to the House

- The container for fetching the water can be contaminated, e.g.

- * if it is not kept clean or has holes,
- * if people use their hands or other dirty items as a funnel to direct the water into the container,
- * if people wash hands and face, etc., while filling the container at the same time,
- * if the container is used for fetching drinking water from the borehole and then the same container is used for water for other purposes from an unsafe source,
- * if the container is left open at home and flies, cockroaches and other animals have access to it.

- The container is left without cover when fetching: animals may drink; the hand of the one carrying may go into the water while lifting and carrying the container.

- The cover used is not clean, e.g. the lid of the jerrycan is put on the ground or leaves are used as cover for a bucket or claypot.

- The water is put from the pump into an open barrel and then taken to the house by jerrycan. The wind can blow dirt into the barrel and the jerrycan will dirty the water when dipped into it for filling after standing on the ground.

2. During Storage and Use in the House (see also 9.5/3)

- The container for storage is contaminated, e.g.

- * It is not cleaned regularly.
- * Members of the family do not wash their hands after going to the latrine. Their hands remain dirty. The person is thirsty and takes water from the pot with a cup, but is not careful and reaches with their hand into the water. The germs enter the water and infect others drinking later on.
- * The pot has no lid or the lid does not close properly or is not relaced after each use. Dust and dirt can enter the pot; flies, cockroaches and other animals can contaminate the water, especially, if it is placed directly on the ground.

- The cup used for taking water from the pot is contaminated, e.g.

- * It is not washed regularly.
- * People use the same cup for dipping and for drinking. Saliva of a sick person enters the water and brings germs to it. Others drinking later get infected.
- * Many people use the same cup and infect the water and each other.

B) Possible Ways to Avoid Contamination

1. Generally

Never touch drinking water with your hands.

2. Container for Transport

- Clean your hands before fetching water.
- Clean the container before fetching water.
- Always use a closed container with a clean and fitting lid.
- Use separate containers for drinking water and other water. Do not use the container for drinking water for any other purpose. If you have only one container, wash it thoroughly with sand, soap and hot water and rinse it afterwards, each time before you fetch water for drinking.

3. Container for Storage

- Equip the pot with a tight lid and tap.
- Remove water from the pot only through the tap.
- If there is no tap, teach everybody in the home how to take water carefully not touching it with the hands, to pour water into another cup for drinking, and to replace the lid.
- Clean the pot regularly and do not keep water for more than 2 weeks.
- Put the pot on a stand to prevent algae and fungi growing into the pot, animals having access to it and small children touching the water.
- Insist that everybody in the home washes his/her hands with soap after going to the latrine.

4. Container for Drinking

- Clean the cups regularly.
- Ensure that everybody uses his/her own cup, if possible; at least ensure that somebody sick uses a separate cup for drinking.
- Never use the same container for dipping and drinking.
- If there is no tap, use a container with a long handle for dipping, stored inside the pot, below its cover.









C) How to Equip a Claypot with Tap and Lid

One possibility to prevent contamination of the water in the home is to equip the pot for storage with a tap and a lid. In the following, it is described how that

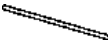
One possibility to prevent contamination of the water in the home is to equip the pot for storage with a tap and a lid. In the following, it is described how that can be done.

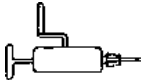



1. Instructions How to Fix a Tap

a) Materials and Tools Needed

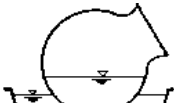
Quant	Item	Drawing
1	claypot (can be an old one, but it should not have any cracks)	
1	$\frac{1}{2}$ " tap with joining piece (should be joined together in the shop to see whether it fits properly)	
2	tablespoons of cement	
1	for drilling: reinforcement rod \varnothing 6 mm, 25 cm long (can be sharpened by cutting with a bolt cutter or with a stone)	
1	or 6" nail	
1	or hand-operated drilling machine with stone bits	
1	rasp (if available)	
1	big bowl for soaking the pot	
1 1	small bowl table spoon	
2	nylon bags	
	cloth or paper	
	sand and water (not salty)	

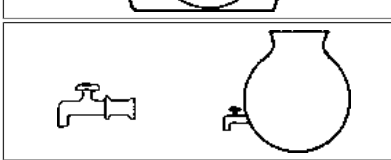
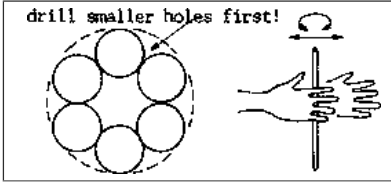
b) Step-by-Step Procedures

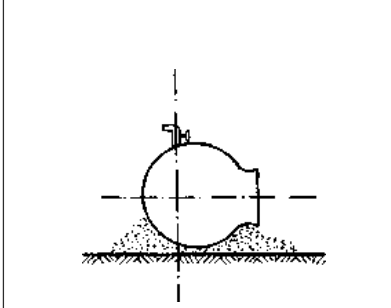

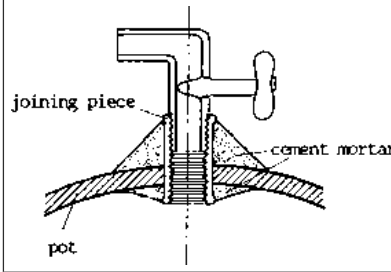
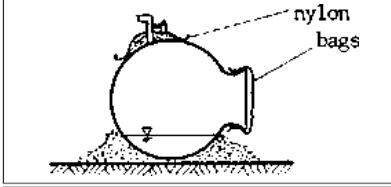



No	Step	Drawing
1	Mark the place you want to fix the tap on the pot. Soak the pot in water and also pour water into the pot. The location of the tap needs to be well soaked.	

2	The tap should be connected with a joining piece of pipe. This should be done in the shop where you buy the tap. Hold the tap with the joining piece against the pot at its future location and draw a circle around it. The location should be not too low or too high on the pot.	
3	Make a big hole for the tap by making first several small ones. Scratch the pot carefully with the 6" nail or reinforcement in the way you stir food until you have made a hole, or drill with a hand-operated drilling machine with a bit for stone. Never use a hammer. Smoothen the edge of the hole with a rasp; it shall be just big enough to push the tap in.	
4	Close both sides of the tap with a piece of cloth or paper.	
5	Choose a place where the pot can remain unmoved for 2-3 weeks. Put sand on the ground and position the pot in it so that the opening for the tap is on the top. The tap shall be in vertical direction.	
6	Mix in a small bowl 2 tablespoons of cement with <u>very, very little</u> water. The mixture must be very stiff, like asida (= ugali).	
7	Place the tap into the opening in such a way that it is horizontal in the final position. Make the place wet. Smear the cement mortar around the joining pipe from inside and outside. The mortar shall be as thick as a finger at the tap and smooth on the edge.	
8	Do not move the pot at all.	
9	Wait until the mortar is a bit hard. Then cover it with wet sand and a nylon. Pour some water into the pot and close the mouth of the pot with a nylon bag.	
10	Keep the sand wet continuously for five days. This is most important.	
11	After one week, the pot can be carefully moved and the lid can be manufactured. After a second week or later, the pot	

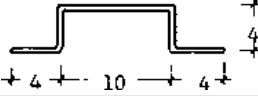
	can be used.	
12	Remove the cloth or paper from the tap and clean the pot carefully before use.	







2. Instruction How to Make a Lid

a) Materials and Tools Needed

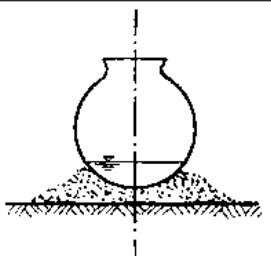
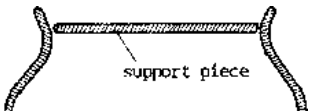
Quant	Item	Drawing
1	claypot	
1	handle, bent into shape from reinforcement rod or any other scrap metal.	
1	support piece, from hard carton, plywood, or an old plate	
2	nylon bags	
2	cups of sand	
1	cup of cement water (should not be salty)	
1	sieve (used for flour) or a piece of mosquito wire	
1	bowl	
1	tablespoon	
1	6" nail (for scratching a mark on the pot)	

b) Step-by-Step Procedures

No	Step	Drawing
1	Scratch two marks into the edge of the pot.	

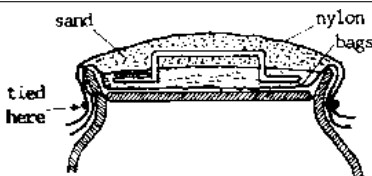
2	Position the pot vertically in sand and pour some water into the pot.	
3	Cut a support for casting the lid from carton paper or plywood, or use any fitting plate. Place it into the mouth of the pot) it should not fall in, but leave an edge of the pot free.	
4	Bend a piece of reinforcement into the shape of the handle.	
5	Place a nylon bag on top of the supporting piece on the mouth of the pot, hanging over the edge of the pot.	
6	Sieve sand. Mix 2 cups of sand with 1 cup of cement and a little water. The mortar should be very stiff like asida.	
7	Smear the mortar on the nylon as thick as your smallest finger. 8 Place the handle on top.	
9	Finish the lid with mortar. When completed, it should be as thick as two fingers. Smear the mortar tight on the edges of the pot. The edge of the lid shall not be too thin. Smoothen the surface.	
10	Scratch two marks on the lid, matching the marks on the pot.	
11	Wait until the mortar is a bit hard. Then put sand, soaked in water, on top of the lid. Cover it tightly with a nylon bag and and tie the bag around the mouth of the pot.	
12	Do not remove sand and nylon bag for one week. Afterwards remove the sand, nylon bags and support Clean the lid and the pot thoroughly. The pot is now ready for use.	

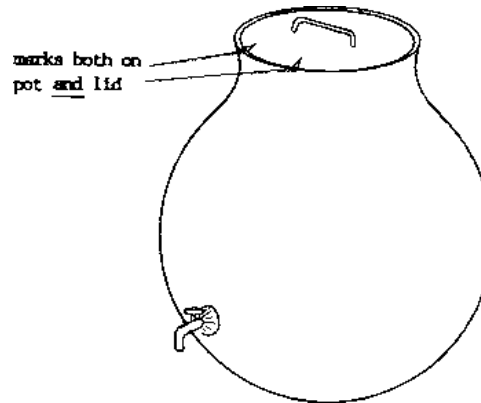

8.39. Health Education about Water/Operating Instruction for Wells

A) Health Education about Water

People need to be made aware about the facts concerning water and health in order to improve their situation and change wrong habits. Therefore, the aim of the health education about water in the project is

- to inform people about the importance of clean water and the connection with sanitation;
- to make people understand the importance of keeping the well properly and how to use it in a good way;
- to make people understand the importance of maintenance and continuous care for the well.

B) Connection of Water and Health

A change in the health situation can only happen if all people use good water and sanitation facilities and use them properly.

Water supply and sanitation are very closely connected; improvement can only happen if none of them is neglected. In this chapter, we deal with the water side, the sanitation side is mentioned in 9.5, 9.6, 9.21, 9.22.

Water must be sufficient, clean and safe in order to contribute to reducing disease, not only for drinking and cooking, but also for

- bathing, hand-washing and cleaning the teeth;
- cleaning vegetables, fruit and kitchen utensils;
- washing the laundry;
- watering animals(see also 8.5 and 8.6).

The problem is that one cannot see or easily know whether water is really clean and safe. Water which looks clean can still carry disease, and other water which may have a salty taste and not be liked by the people may be safe.

In order to have water which is really clean and safe, that means it contains nothing which can cause disease, we have to prevent contamination of water which we know is safe, that is normally groundwater. Contamination needs to be prevented

- at the water source,
- during collection and delivery } see 8.38
- during storage and use in the household } see 8.38

Water can be polluted at the source by	How to prevent/cure it
chemicals, like fuels, DDT, etc. washed into the ground by rain	<ul style="list-style-type: none"> - Do not use dangerous chemicals where water is used for human consumption. See 9.13/3; 9.16/2 - There is <u>no cure</u>.
poor sanitation facilities or wrongly constructed latrines or WCs and septic tanks, through germs and nitrates/nitrites	<ul style="list-style-type: none"> - Keep "safe" distances (at least 50m) between latrines and water source. See 4.15/6; 8.12/1; 9.8/3. - Never have a latrine reach into the groundwater. See 9.8/3. - Cure for germs: chlorination.(8.36) - <u>No cure</u> for nitrates/nitrites.
Dirty water around the well, seeping into it (surplus water from the pump or rainwater)	<ul style="list-style-type: none"> - Care for a proper platform, big enough, without cracks, and with a drainage channel and soak-away pit. See 8.19. - Care for a hedge or fence not to let animals come near and dirty the place. - Keep the area around the well dry and clean and without rubbish. - Do not wash laundry near the well but provide a place for that at a distance.
dirt or small animals falling into the well	<ul style="list-style-type: none"> - Care that the well cover is closing properly. See 8.20/3. - Care that there are no cracks in the platform. See 8.33/1.

C) Operating Instruction for a Well

In the project, handing over of a well to a community is used as a chance for health education. This is reinforced by regular follow up visits. The operating instruction takes place at the well site and is based on the knowledge people already have on the subject, e.g.

- It is bad to drink dirty water.
- Little rain will give little water in the well.
- If the well is misused, there will be no other nearby source of good water.

- If the well is open, it is dangerous for children and animals.
- If a pump breaks down, there will be no water.

The topics covered are the water cycle, keeping the well and its surroundings clean, taking care of the hand pump, and using it properly. The methods used are practical demonstration, drama and posters together with explanations. For hand pump caretakers this topics will be covered, together with the duties and technical information, in a small seminar.

The following posters are used for operating instruction of a well.



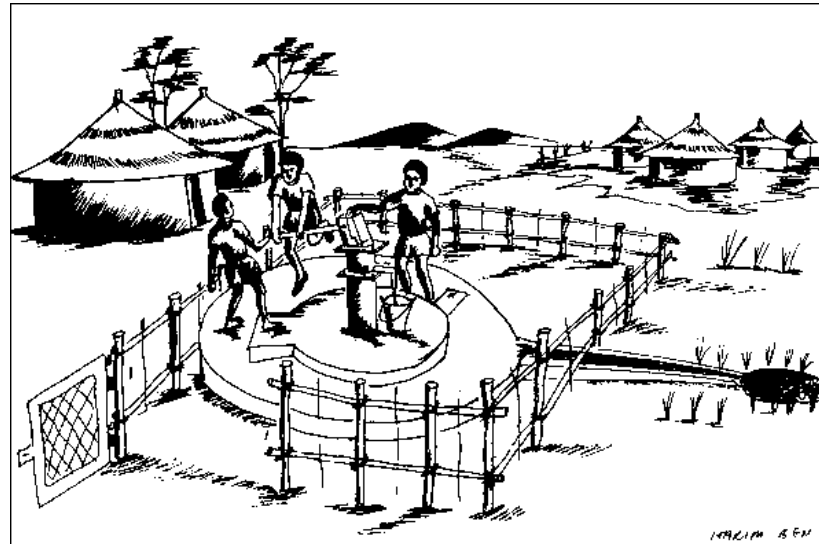
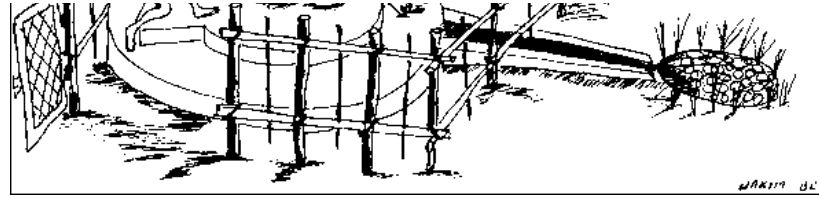



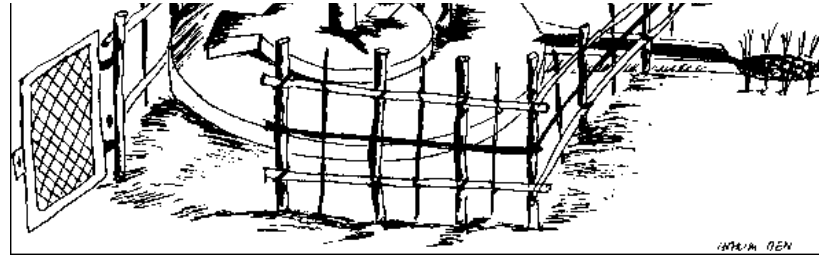

10. Appendix

10.1. List of Abbreviations

A/...	Assistant...
Adm.	Administration
BH	Borehole
ca.	circa = about
CD	Community Development
CDO	Community Development Officer
CL	Compost Latrine
c/o	care of
e.g.	exempli gratia = for example
etc.	et cetera = and so on
...f	... and the following page
...ff	... and the following pages
GW	Groundwater
HP	Hand Pump
ID	Inside Diameter
i.e.	id est = that is
L	Latrine
Log	Logistics
£S...m/ms	Sudanese Pounds... millimetres
OD	Outside Diameter

pc	Piece
pcs	Pieces
PMT	Project Management Team
San	Sanitation
SCC	Sudan Council of Churches
W	Well
WC	Water Closet
WS	Water Supply
WT	Water Table

Abbreviations for Measurements see 5.3

Abbreviations in Mathematics see 5.4 and 5.7

10.4. List of Illustrations (from literature)

References to illustrations page numbers and authors given in the table below reflect the printed version. In order to have the exact correspondence please consult the PDF version of this file.

All illustrations not mentioned in the following list as well as the adaptations were made by Márta Guóth-Gumberger.

Section	Illustration Page No.	Taken from/Made by
1	1.3/2; 1.6/6; 1.7/1	Ben Hakim
2	2.4/4; 2.7/2; 2.8/2; 2.12/1	Ben Hakim
	2.18/1-4; 2.18/6	bibliography No. 12; 27
3	3.1/2; 3.3/2; 3.6/1; 3.7/1; 3.8/1; 3.9/3	Ben Hakim
4	4.8/1-3; 4.19/3	Ben Hakim
	4.4/2; 4.8/5; 4.12/1f; 4.14/3-6; 4.18/4f	Mike Gogonya
	4.1/4	The Guardian Weekly
	4.6/1	The International Women's Tribune
	4.6/3 (below)	Sueddeutsche Zeitung
	4.6/3 (top); 4.8 (adapted); 4.12 (adapted); 4.14 (adapted); 4.16/2; 4.18 (adapted); 4.23/3 (below); 4.27 (partly adapted)	bibliography No. 20; 37; 48

6	6.4/8; 6.6/14	Ben Hakim
	6.3 (partly adapted)	catalogue 1986, Luna AB Sweden, and catalogue 1983, Mittermeyer, W-Germany
	6.1/20	manual diaphragm pump, Van Reekum Materials, Netherlands
	6.1/21	manual Hatz Generator, West Germany
	6.1/22 (bottom); 6.6/2 (adapted); 6.6/6; 6.7 (adapted)	bibliography No. 6a; 8; 44
7	7.2/2; 7.3/1; 7.6/3; 7.8/3; 7.12/3	Ben Hakim
8	8.7/5; 8.9/2; 8.37/7 (left); 8.39/3-7	Ben Hakim
	8.24/24 (adapted)	leaflet, Mono Pump
	8.24/29	leaflet, Homa Pump
	8.24/30	leaflet, Jet pump
	8.24/7-30 (partly adapted); 8.30 (adapted); 8.35 (adapted); 8.37/4,6	bibliography No. 18; 21; 22; 44; 46
	9.9/2; 9.19/2; 9.20/5; 9.21/2	Ben Hakim
	9.6/1,2(bottom), 3-10; 9.17/2-32	Mike Gogonya
	9.1/2; 9.2/2; 9.2/3; 9.6/2 (top),4 (bottom)	Stephen Hakim
9	9.3/1; 9.3/2; 9.3/5f; 9.5/2f (adapted); 9.6(adapted); 9.12/2; 9.12/3 (adapted); 9.12/4 (top, adapted); 9.20/1-4; 9.11/2; 9.22/3	bibliography No. 6; 23; 34; 48; 49
0 to 9	drawings title pages	Ben Hakim

10.5. Bibliography

Literature used and recommended for further studies:

1. A Growing Problem, by David Bull; OXFAM, 2 74 Banbury Road, Oxford OX 2 7 DZ, England
2. A Manual And Resource Book For Popular Participation Training, 4 Vol., UN-Publications ST/ESA/66 Vol. I-IV; UN Publications, 1211 Geneva, Switzerland
3. A Manual For Group Facilitators, by The Centre for Conflict Resolution; The Centre for Conflict Resolution, 731 State Street, Madison, Wisconsin 53703, USA
4. African Churches And People's Development, ccpd-document No. 4; WCC, P.O. Box 66, 1211 Geneva 20, Switzerland

5. Appropriate Building Materials, by Roland Stulz; SKAI, Varnbueistr. 14, 9000 St. Gallen, Switzerland

6. Biology, by Soper/Smith; MacMillan Publishers

6a. Brickwork For Apprentices, by J.C. Hodge; Edward Arnold

7. Bridging The Gap, by Save The Children; Save the Children, 54 Wilton Road, Westport, Conn. 06880, USA

8. Building Science And Materials, by John Elliot; MacMillan Publishers

9. Communicable Diseases, by Eshuis/Manschot; AMREF, P.O. Box 30125, Nairobi, Kenya

10. Communication, by C.S. Deverell; Gee & Co. Publishers

11. Communication Skills For Rural Development, by McDonald/Hearle; Evans Brothers Limited

12. Communications Guide for Extension Workers, by RSCTU/UNICEF; UNICEF, Eastern Africa Regional Office, P.O. Box 44145, Nairobi, Kenya

13. Community Development Workers Training Series, 7 volumes, by UNICEF; address see 12.

14. Development/Seeds of Change, diverse issues; SID, Palazzo della Civiltà del Lavoro, Roma 00144, Italy

15. Guidelines For Development, by CCIA; Christian Conference of Asia, 480 Lorong 2, Toa Payoh, Singapore 1231

16. Handbook For Development Workers Overseas, by Glynn Roberts; Returned Volunteer Action, 1 Amwell Street, London EC 1 R 1 UL, England

17. Hand Dug Wells And Their Construction, by Watts/Wood; ITDG Publications, 9 King Street, London WC 2 E 8 HN, England

18. Handpumps, by Eugene Mc Junkin; IRC, P.O. Box 5500, 2280 HM Rijswijk, Netherlands

19. Handpump Maintenance In The Context Of Community Well Projects, by Arnold Pacey; ITDG Publications, address see 17

20. Helping Health Workers Learn, by David Werner/Bill Bower; The Hesperian Foundation, P.O. Box 1692, Palo Alto, CA 94302, USA

21. How To Protect A Water Source And Why?, by Rogers/Kokole; OXFAM/UNHCR, South Sudan Water Team, Juba

22. India Mark II Handpump Installation Manual; Richardson & Cruddas, 23 Rajaji Salai, Madras 600001, India

23. Insecticides, by The Ross Institute; The Ross Institute, Keppel Street, London WC 1 E 7 HT, England

24. Learning From The Rural Poor, by Volken/Kumar/Kathathara; Indian Social Institute, Lodi Road, New Delhi 11003, India

25. Making The Links, Guidelines For Hygiene Education In Community Water Supply And Sanitation, by IRC; IRC, address see 18.

26. Maths For Living, by W.D. Wright; James Nisbet

27. Navamaga, Training Activities For Group Building, Health And Income Generation; Overseas Education Fund, 2101 L Street NW, Suite 916, Washington

DC 2003 7, USA

28. **Notes For Draughtsmen, by Neil Orton; Mac Donald**
29. **Ordinary Level Mathematics, by F.G.J. Norton; Heinemann**
30. **Organisational Techniques; Overseas Education Fund, address see 27.**
31. **People In Development, by John Staley; SEARCH, 256 First Block, Jayanagar, Bangalore 560011, India**
32. **People's Technologies and People's Participation, by Pascal de Pury; WCC, address see 4.**
33. **Sanitation And Disease, by Feachem/Bradley/Carellick/Mara; John Wiley**
34. **Sanitation Without Water, by Uno Wimblad/Wen Kilama; Mac Millan Publishers**
35. **Shallow Wells, by DHV; DHV Consulting Engineers, P.O. Box 85, Amersfoort, Netherlands**
36. **Small Excreta Disposal Systems, by Feachem/Cairncross; The Ross Institute, address see 23.**
37. **Teaching And Learning With Visual Aids; Educational Materials Unit, Program for International Training in Health, School of Medicine, University of North Carolina, Chapel Hill, North Carolina, USA**
38. **Technical Health Training Manual, 2 volumes; Peace Corps, Information Collection and Exchange, 806 Connecticut Avenue NW, Washington DC 20525, USA**
39. **The Expanded Programme On Immunization, Health Education Trainers' Manual For Extension Workers In Sudan; UNICEF, Juba, Sudan**
40. **The Programmer's Tool Kit; Overseas Education Fund, address see 27.**
41. **The Role And Training Of Development Activists, by Khamla Basin; FFHS/AD, FAO, 55 Max Mueller Marg, New Delhi 110003, India**
42. **Visual Aids; Peace Corps, address see 38.**
43. **WASH Technical Reports; WASH, 1611 N Kent Street, Room 1002, Arlington, VA 22209, USA**
44. **Water For The World Series; US-AID, Development Information Centre, Washington DC 20523, USA**
45. **Water Sources And Their Protection, by Rogers/Kokole; OXFAM/UNHCR, Southern Sudan Water Team, Juba**
46. **Waterlines, diverse issues; ITDG Publications, address see 17.**
47. **Well Construction, by Richard E. Brush; Peace Corps, address see 38.**
48. **Where There Is No Doctor, by David Werner; TALC, P.O. Box 49, St. Albans, Herts., AL 1 4 AX, England**

Please provide your feedback

[English](#) | [French](#) | [Spanish](#) | [German](#)