

Basic Vocational Knowledge – Lighting Installations

Table of Contents

Basic Vocational Knowledge – Lighting Installations	1
Preface.....	1
<u>1. General Remarks on Lighting Installations</u>	<u>2</u>
<u>2. Elements</u>	<u>2</u>
<u>2.1. Basic Terms in Lighting Engineering</u>	<u>2</u>
<u>2.2. The Eye and its Visual Capacity</u>	<u>14</u>
<u>2.3. Colour, Light and Space</u>	<u>17</u>
<u>2.4. Quality Characteristics of Lighting</u>	<u>19</u>
<u>3. Calculation of Illuminance</u>	<u>22</u>
<u>3.1. Luminous Flux Method for Interior Space</u>	<u>22</u>
<u>3.2. Luminous Intensity Method – for Rotation–Symmetrical Lighting Fittings</u>	<u>26</u>
<u>4. Measurements at Lighting Installations</u>	<u>29</u>
<u>4.1. General Remarks</u>	<u>29</u>
<u>4.2. Illuminance Measuring</u>	<u>30</u>
<u>4.3. Luminous Density Measuring</u>	<u>30</u>
<u>5. Light Sources for Illuminating Purposes</u>	<u>30</u>
<u>5.1. General Remarks</u>	<u>30</u>
<u>5.2. Thermal Radiation Lamps</u>	<u>31</u>
<u>5.3. Pischarge Lamps</u>	<u>36</u>
<u>6. Operating Components for Discharge Lamps</u>	<u>53</u>
<u>6.1. Ballast</u>	<u>53</u>
<u>6.2. Starter Switches</u>	<u>54</u>
<u>6.3. Ignition Sets</u>	<u>55</u>
<u>6.4. Compensating Capacitors</u>	<u>55</u>
<u>6.5. Intensity Control of Lamps</u>	<u>56</u>
<u>7. Comparative Tabulations of the Properties and Energy Consumption of Lamps</u>	<u>57</u>
<u>8. Lighting Fittings</u>	<u>59</u>
<u>8.1. Protection Classes</u>	<u>60</u>
<u>8.2. Degrees of Protection</u>	<u>61</u>
<u>8.3. Efficiency of a Fitting</u>	<u>62</u>
<u>8.4. Kinds of Lighting Fittings</u>	<u>63</u>
<u>9. Commercial Lighting Fittings</u>	<u>80</u>
<u>9.1. Self–Luminous Lighting Installations</u>	<u>80</u>
<u>9.2. Transilluminated Lighting Installations</u>	<u>84</u>
<u>9.3. Illuminated Installations</u>	<u>84</u>
<u>10. Mounting of Lighting Installations</u>	<u>91</u>
<u>10.1. Mounting of Indoor–Lighting Installations</u>	<u>91</u>
<u>10.2. Factory Lighting – an Example of Indoor–Lighting Installations</u>	<u>94</u>
<u>10.3. Outdoor Lighting Installations Demonstrated by the Example of Industrial Building</u>	<u>97</u>
<u>11. Inspection and Repair of Lighting Installations</u>	<u>100</u>
<u>11.1. General Remarks</u>	<u>100</u>
<u>11.2. Depreciation Factors</u>	<u>101</u>
<u>11.3. Time of Maintenance</u>	<u>101</u>
<u>11.4. Carrying out of Maintenance</u>	<u>101</u>
<u>11.5. Cleaning</u>	<u>103</u>
<u>11.6. Auxiliary means for Maintenance</u>	<u>103</u>
<u>11.7. Hints for Practice</u>	<u>103</u>
<u>12. Answers to the Questions for Repetition and Knowledge Tests</u>	<u>104</u>

Basic Vocational Knowledge – Lighting Installations

Lehr- und Lernmittel,
Informationen, Beratung

Educational Aids
Literature, Consulting

Moyens didactiques,
Informations, Service–conseil

Material didáctico,
Informaciones, Asesoría

Feedback IBE e.V.
91–34–0106/2



Deutsche Gesellschaft für
Technische Zusammenarbeit (GTZ) GmbH

Preface

The present textbook was elaborated on the basis of the extensive experience in the field of vocational training of its authors and is meant for apprentices in electrical engineering.

It deals with elementary knowledge in lighting engineering.

The required knowledge in this field of electrical engineering is presented in didactic form.

Starting from a certain scientific knowledge – which is an absolutely necessary precondition – the learning and understanding of the treated problems is facilitated by many illustrations and diagrams as well as comprehensible texts.

Thanks to the consistent observance of the unity of theory and practice, the apprentices can use the textbook as a working aid in theoretical and practical training as well.

The last part of the textbook consists in tasks and questions for repetition and knowledge tests. They point to the most important contents of training and serve the apprentices for checking their knowledge. To enable an assessment of the answers given, a key is to be found in chapter 12.

Textbook for Vocational Training

Institut für berufliche Entwicklung e.V.
Berlin

Original title:
"Berufliche Grundlagen – Beleuchtungsanlagen"

Author Frank Ponemunski

First Edition © IBE

Institut für berufliche Entwicklung e.V.
Parkstraße 23

1. General Remarks on Lighting Installations

According to various technical, spatial, chromatic and physiological criteria, outdoor and indoor lighting installations are designed and mounted.

Consequently, a lighting installation consists of lamps and accessories belonging to them, light sources with or without accessories, the installation as well as the indirectly or directly used environmental factors such as reflecting surfaces. In any case, the starting point is the physiological and psychological aim of the installation, i.e. the desired degree of lighting of the working and living sphere of man for the special purpose of seeing taking into consideration economical aspects of material and energy consumption.

The times of the day, weather conditions, the various sizes of the objects to be perceived and different degrees of sensitiveness to brightness as well as perception of colours make it very complicated to decide about the type and size of a lighting installation.

For this reason, one makes use of medical findings and technical experience combined in standards regulating the parameters of lighting installations for various purposes. These parameters are definite basic values which are explained in the following. In addition to the physiological purpose to facilitate the visual work of the eye, the artificial light has also a psychological effect which is used as emotional stimulation. Thus, for example, light can have a comfortable or aggressive effect according to colour temperature and spectral colour contents. The mood and emotional disposition of man – and also of animals – can be influenced by light. In this context, the medical effects of light must not be failed to be noticed, e.g. combatting hepatitis with babies, degermination of the air. Ecological functions of the light are reflected by the use of Lumoflor lamps in horticulture – they stimulate the growth of the plants.

Lighting fittings are required for the manifold purposes in all living and working spheres of man.

The differentiated construction of lighting fittings enables the dispersion or focussing of the light emitted by the light sources and thus the intensification or subduing the effect of a light source.

Since lighting fittings play a role also in the emotions of man, there are – in addition to universal and functional lighting fittings – also those for purposes of representation. The use of lighting fittings depends on the respective purpose and light source.

Questions for Repetition and Knowledge Testing

1. What is understood by a lighting installation?
2. By what does a lighting installation mainly stimulate man?

2. Elements

2.1. Basic Terms in Lighting Engineering

Radiation – general

Emission or transmission of energy in the form of electromagnetic waves or corpuscles.
These electromagnetic waves or corpuscles themselves.
The wavelength of this radiation is unlimited.

Radiation – visible

Radiation causing visual sensation immediately and directly.
 The visible radiation comprises the energy in the wave bands between 380 and 780 nm.

Light

Characteristic of all perceptions and sensation the visual organ is capable of mediating.
 Radiation suitable for exciting the visual organ.

Relative luminosity factor

The ratio of the radiant flux with the wavelength λ (m) and the radiant flux with the wavelength λ both radiations causing the same brightness impression in certain photometrical conditions.

λ (m) has to be selected in such a way that the maximum of this ratio is equal to 1.

The graphic representation of this ratio shows the spectral photopic eye response curve for daylight and night vision (Fig. 1). For the purpose of phototechnical evaluation of all physical values these must be related to the mentioned curve. Therefore, the phototechnical formula symbols get the index 'v', whereas the physical values bear the index 'e' for 'energy'.

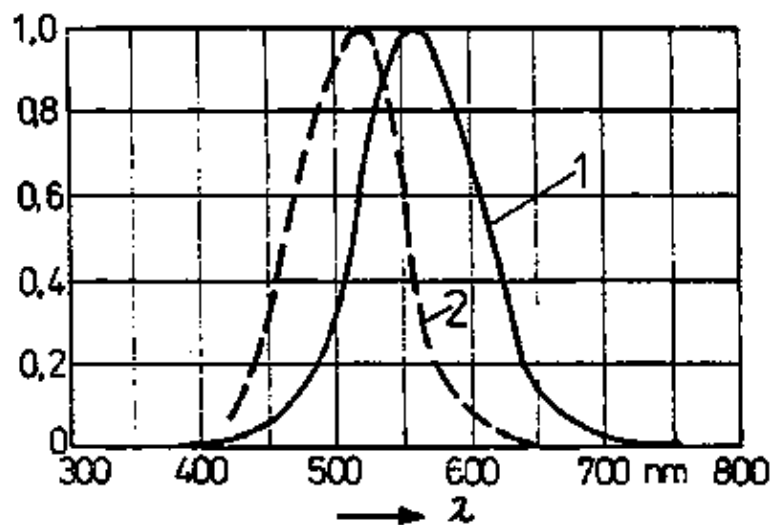

Figure 1. Spectral-response function of the eye depending on the wavelength

- 1 for cone vision (day vision)
- 2 for rod vision (night vision)

Luminous flux

Value derived from the luminous flux in such way that the radiation is assessed according to its effect on a selective receiver the spectral sensitiveness of which is given by the standardized degree of brightness.

Unit lumen (lm)

Lumen is the internationally agreed unit of the luminous flux. The luminous flux characterizes the light power.

Light efficiency

Quotient out of the luminous flux and the wattage applied. Unit lumen per watt ($\frac{\text{lm}}{\text{W}}$)

Light intensity

Quotient out of a luminous flux emitted by a light source into a solid angle element around the considered direction and this solid angle element.



Figure 2. Representation of light intensity

1 light source, 2 direction of view, 3 solid angle, 4 portion of the luminous flux which is registered from the direction of view

For calculating the illumination it is important to know in what direction the lighting fitting distributes the luminous flux. That is to say one must know the spatial distribution of the luminous intensity of the illuminator. For this, the luminous intensity is represented as a radius vector in a polar diagram. All the vectors start from the same point – pole –; their respective length is proportional to the values of the luminous intensity in the various directions. By meridian sections one gets the light distribution curve (LVK) in these planes.

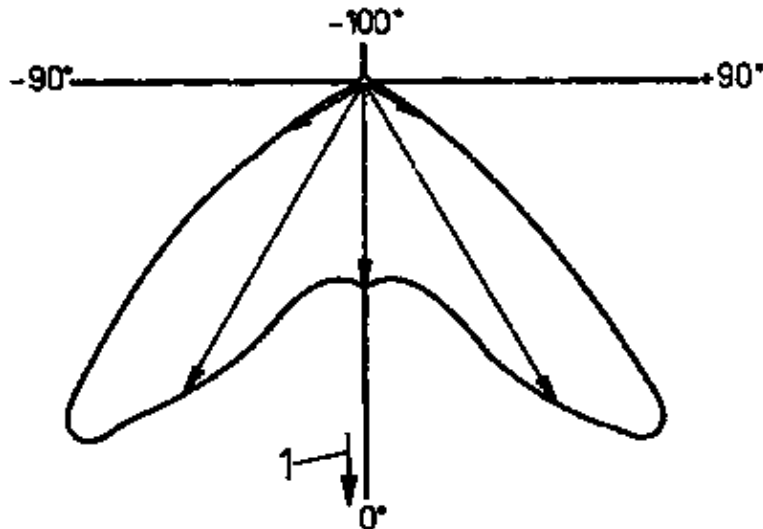

Figure 3. Basic representation of the light distribution curve

1 light intensity in candela

With the representation of the solid of light distribution by light distribution curves with many lighting fittings one cannot manage with one sectional axis; it is necessary to determine plane systems. Three plane systems are preferred.

– Planes the lines of intersection of which stand on one supposed illuminator axis and lie in a horizontal plane through this axis.

The planes are called A–planes, the angle of swing of the planes is represented by beta.

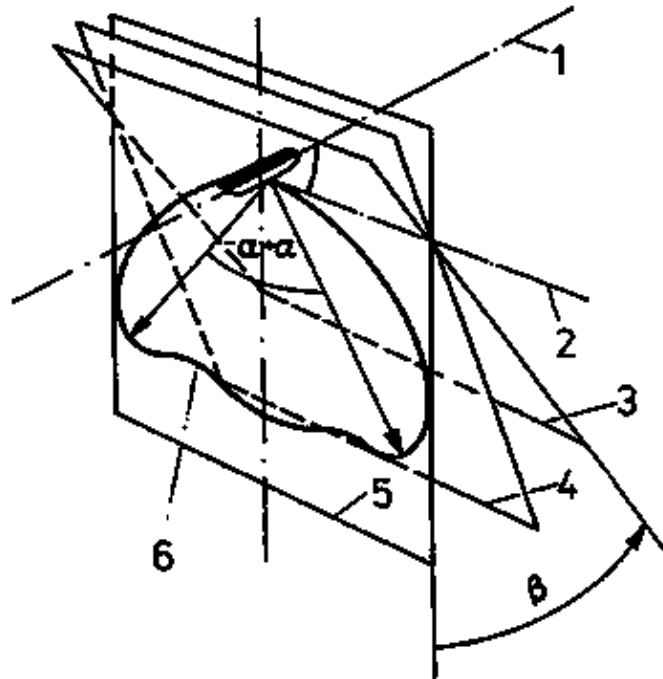

Figure 4. Light distribution curve (A plane)

- 1 illuminator axis
- 2 rotation axis
- 3 beta = 40 degrees
- 4 beta = 20 degrees
- 5 beta = 0 degrees
- 6 light distribution curve in the A plane

– Planes the lines of intersection of which coincide with the supposed illuminator axis. These planes are called B–planes, the angle of swing is marked by alpha.

The alpha– and beta–angles are counted from 0 to ± 180 degrees. The direction of a luminous intensity I in the A–planes system is clearly defined by the value A (beta, alpha), which is equivalent to beta = 40 degree and alpha = 30 degrees. The direction of a luminous intensity I in the B–planes system is clearly defined by the indication of B (alpha, beta), which is – in this example – alpha = 30 degrees and beta = 40 degrees.

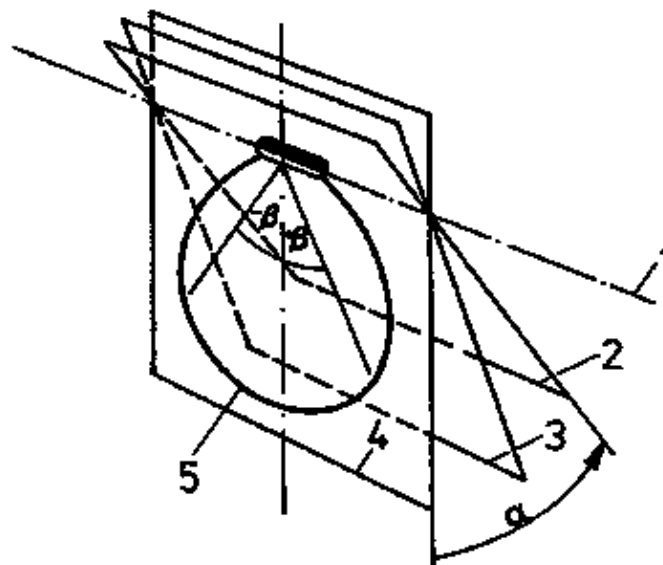

Figure 5. Light distribution curve (B plane)

- 1 illuminator and rotation axis, 2 alpha = 40 degrees, 3 alpha = 20 degrees, 4 alpha = 0 degrees, 5 light distribution curve in the B plane.

– Planes the lines of intersection of which stand vertically on the illuminated surface and which pass through the centre of the illuminator.

These planes are called C–planes; the angle of swing is called gamma and counts from 0 to 360 degrees – semiplanes.

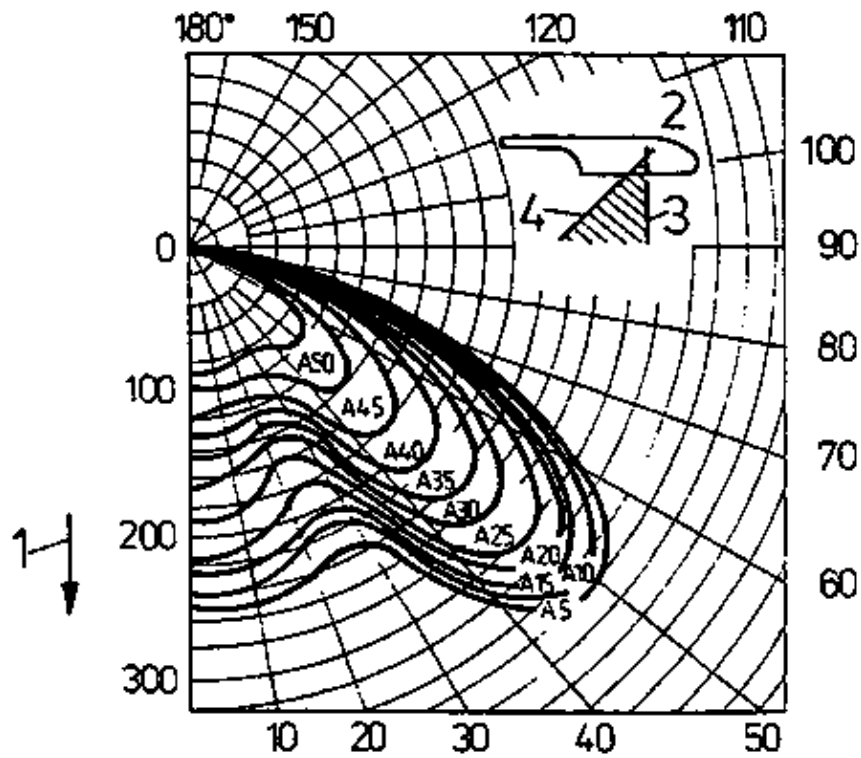
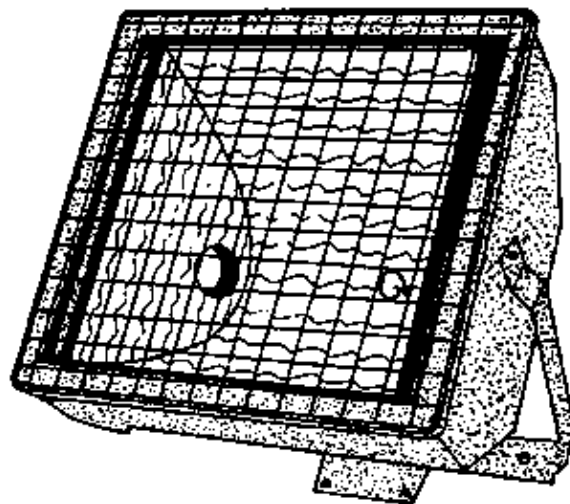
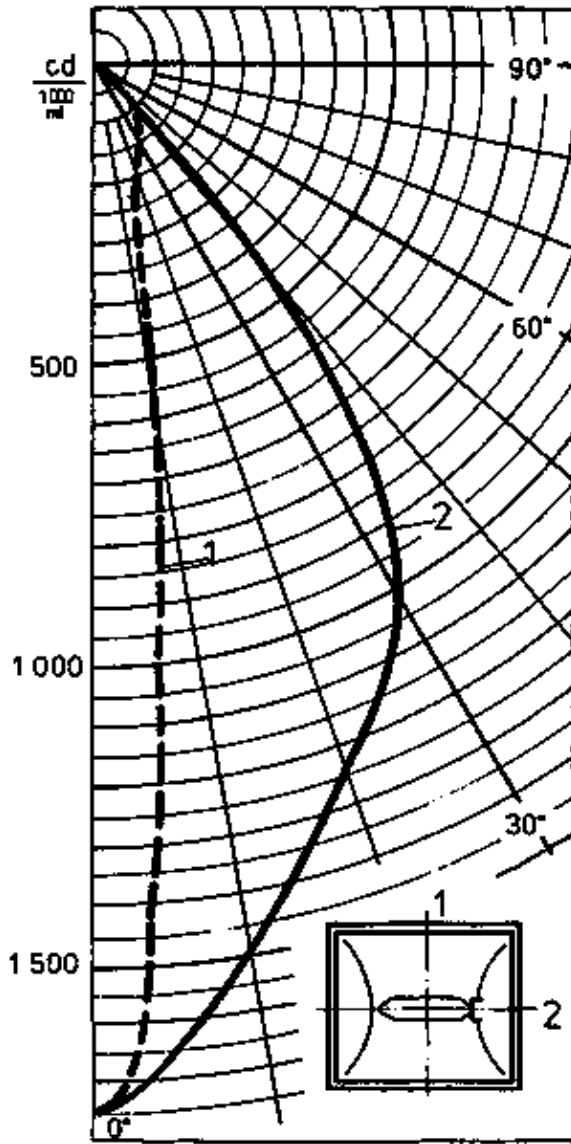

Figure 6. Book-leaf representation of a low-frequency illuminator in the A plane

1 (candela divided by 1000 lumen),
2 measuring plane, 3 beta = 0 degrees, 4 beta = 50 degrees.

Figure 7. Channel flood lantern with light distribution curve





close-radiant with an illuminator efficiency of 0.74 1, 2 radiation planes

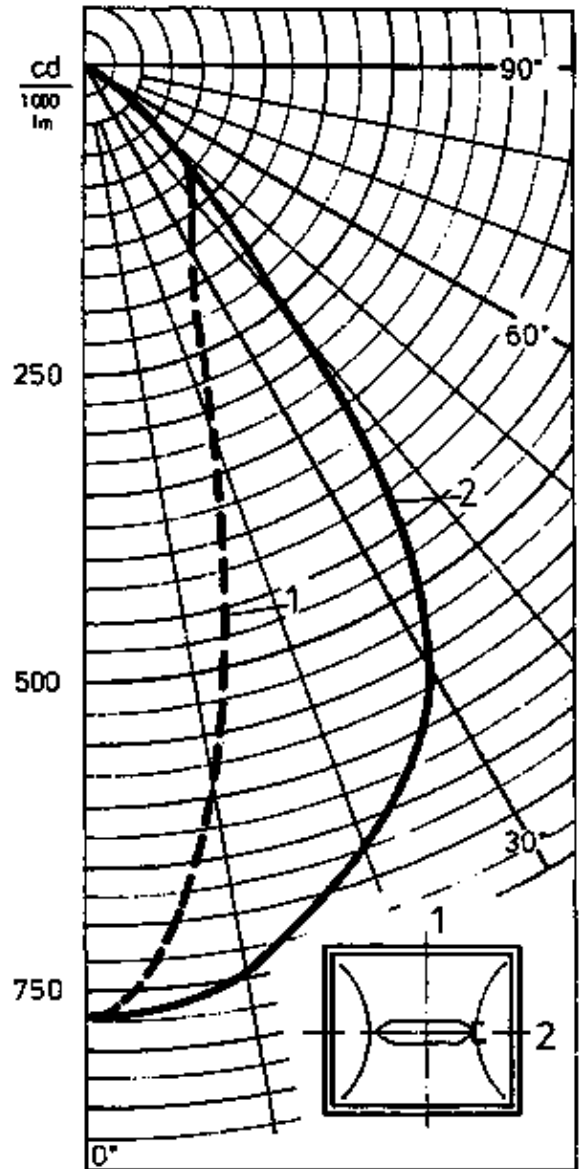

wide beam with an illuminator efficiency of 0.72

Luminance

Luminance – in one direction, at one point of a radiating or irradiated surface, or at a point of an optical path.

Quotient of the luminous flux leaving a surface element enclosing the respective point, hitting the surface element or penetrating it and spreading within a solid angle element in a given direction and of the product of the transilluminated solid angle element and the surface element on one plane vertically to the direction of the radiation.

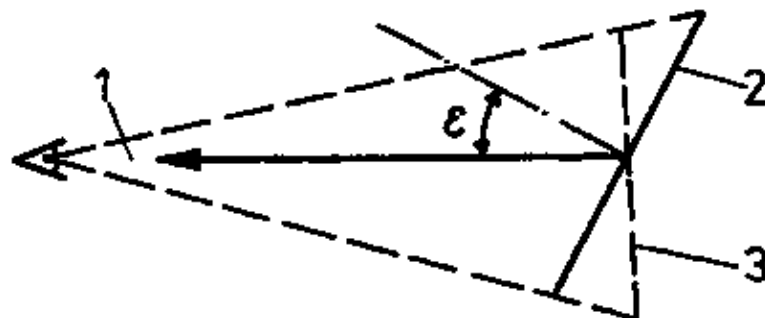

Figure 8. Representation of luminance

- 1 light intensity for epsilon,
- 2 transilluminated solid angle element (surface element),
- 3 vertical orthogonal projection of the surface element

Unit of candela per square metre

Illumination

Quotient of the luminous flux received by a surface element which contains the point considered and of the surface of this element.

Unit of lux (lx)

Illumination is that value in lighting engineering which is mainly used as the basis of projecting indoor and outdoor lighting installations, except street lighting installations.

In this context it is mostly necessary to picture to oneself the distribution of illumination. In many cases, the indication of the average illumination is sufficient. In this case, the surface the average illumination is related to must be accurately marked off.

For characterizing the local evenness it is required to know the maximum and minimum illumination on the calculated surface with outdoor installations. Often it is also important to know the evenness on a number of vertical planes and to find out the minimum and average values of certain vertical planes. After having measured or calculated the illumination in a number of points of one plane, the values in these points can be projected vertically as vectors on the surface (measuring plane); the values are given by the length of the vectors. The enveloping surface of these vectors is the illumination shape that gives a picture of the distribution of illumination on the measuring plane.

By connecting the points of the same illumination within this shape the representation becomes more illustrative – isolux surfaces.

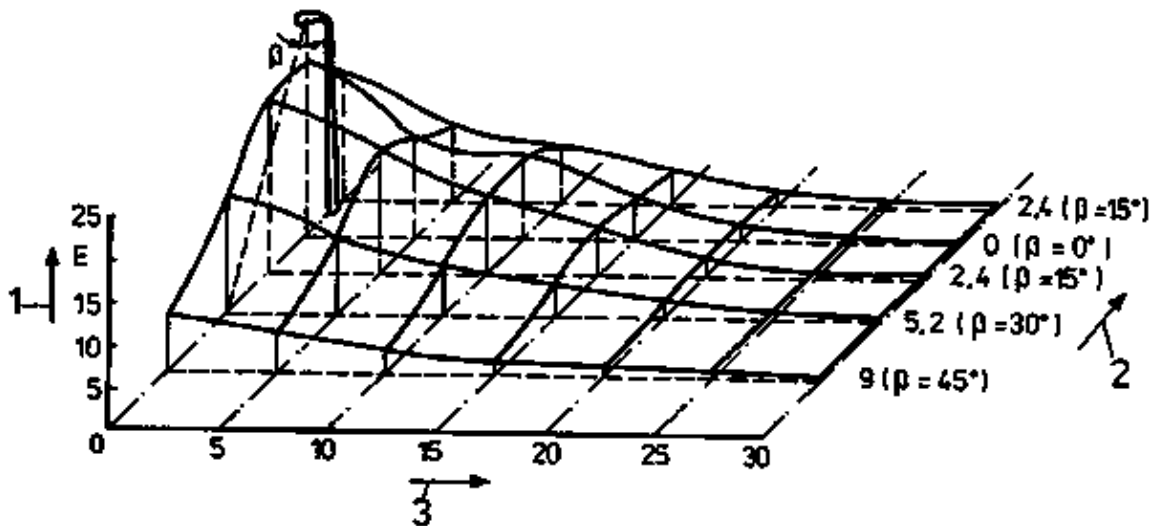

Figure 9. Illumination figure of a lighting fitting fixed to a lamp pole by a holding fixture, useful height = 9 m

1 illumination in lx, 2 width of the measuring plane in m, 3 length of the measuring plane in m

In practice, sections in different planes of the shape are sufficient. The vertical section produces the rectangular illumination diagram.

Table 1 Survey of the basic values, their symbols, units and relations in lighting engineering

Basic value	Symbol	Unit	Abbreviation	Relations
Luminous flux	?	lumen	lm	
Light quantity	?	lumen-second	lm s	?t
Light intensity	I	candela	cd	$\frac{d\Phi}{d\Omega}$

Illuminance or illumination	E	lux	lx	$\frac{d\Phi}{dA_2}$
Luminance or luminous density	L	candela/square metre	$\frac{cd}{m^2}$	$\frac{I_\varepsilon}{\cos\varepsilon dA_1}$
Light efficiency	?	lumen/watt	$\frac{lm}{W}$	$\frac{\Phi}{P}$

Table 2 Luminance in various systems of units

	$\frac{cd}{m}$	sb	asb	L	fl
$1 \frac{cd}{m^2}$	1	10^{-4}	?	$? \times 10^{-4}$	0.2919
1 stilb (sb)	10^4	1	$? 10^4$?	2.919×10^3
1 apostilb (asb)	$\frac{1}{\pi}$	$\frac{1}{\pi} \times 10^{-4}$	1	10^{-4}	9.291×10^{-2}
1 lambert (L)	$\frac{1}{\pi} \times 10^4$	$\frac{1}{\pi}$	10^4	1	9.291×10^2
1 footlambert (fL)	3.426	3.426×10^{-4}	10.764	1.0764×10^{-2}	1

Table 3 Illumination or illuminance in various systems of units

	lx	ph	fc
1 lux (lx)	1	10^{-4}	9.291×10^{-2}
1 phot (ph)	10^4	1	$9,291 \times 10^2$
1 footcandle (fc)	10.764	1.0764×10^{-3}	1

In addition to the mentioned basic units distinguishing marks – materials indices – are required, which mainly characterize the building materials in lighting engineering. These include materials for lamps and lighting fittings and all materials influencing the illumination and entire impression of a room and which exert an influence especially on the mood of the people staying in this room, e.g. machines, surfaces of the room, work clothes, etc.

The qualities of a material relevant for illumination engineering are expressed and represented by:

Reflection, transmission and absorption

This is the throwing back or passing through of a radiation by or through a surface or medium without any change of frequency within the monochromatic portion of the radiation and transformation of radiant energy into another form of energy by interaction of light with matter. There are different types of reflection and transmission:

Specular reflection

Reflection without scattering according to the rules of optical reflection such that all reflected rays have the same direction.

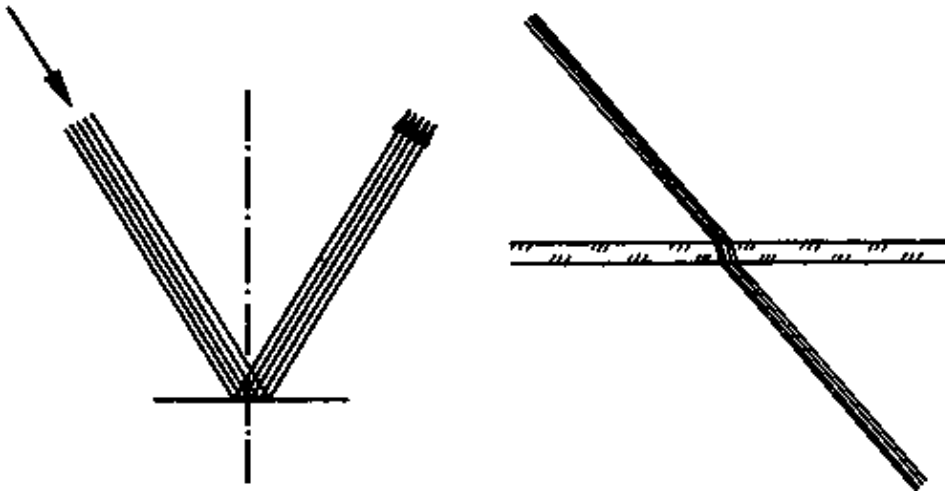

Figure 10. Directed reflection, transmission

Diffuse reflection

The reflection of rays from a surface such that the reflected rays have various directions, as far as the rules of optical reflection do not become noticeable macroscopically.

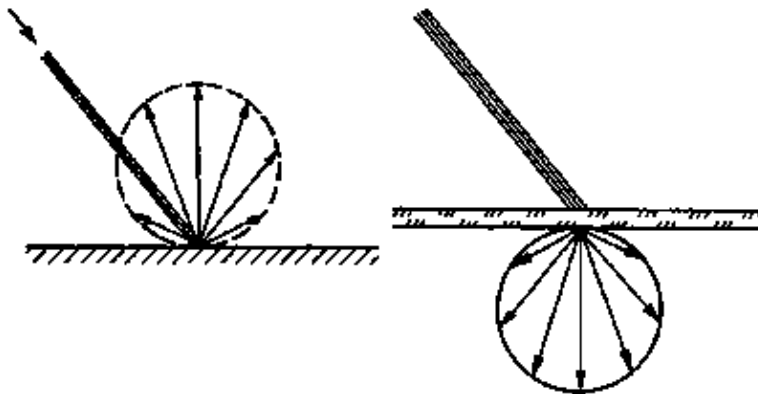

Figure 11. Diffuse reflection, transmission

Mixed reflection

Simultaneous specular and diffuse reflection.

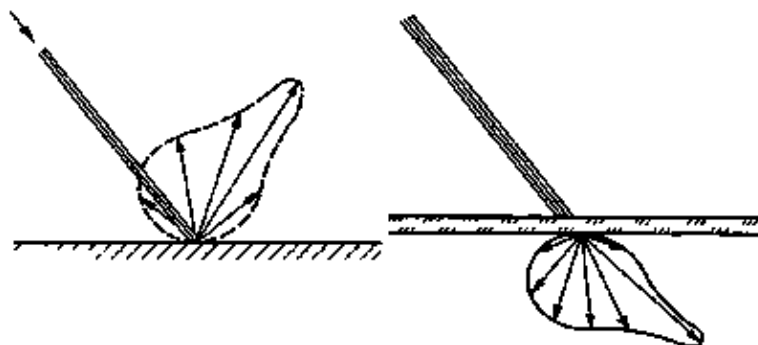

Figure 12. Mixed reflection, transmission

Perfectly diffuse reflection

Diffuse reflection such that the reflected radiation is evenly distributed in all its directions as to radiant intensity and luminance per unit area – Lambertian light source.

To the types of transmission the respective definitions apply.

Among the mixed reflections also counts the term of Gloss (of a surface)

Quality of a surface such that – by specular reflection or an acute reflection indicatrix – it shows bright reflected lights or the reflected pictures of bright things.

Gloss can essentially support the recognition of a form, but it may as well impede the recognition of details.

Therefore, this phenomenon must be paid special attention to when a lighting installation shall be constructed.

Table 4 Characteristics of illuminating engineering materials – glass –

Material	Thickness mm	Transmission factor	Reflection factor	Absorptance	Remarks
Crystal	2 –4	0.9–0.92	0.06–0.08	0.02–0.04	
Plate glass	1 –4	0.90–0.92	0.06–0.08	0.01–0.03	
Raw glass, greenish	4.1–9.1	0.85–0.90	0.06–0.07	0.02–0.08	
Wired glass	5 –7	0.53–0.70	0.1–0.3	0.17–0.20	
Figured glass	3 –6	0.55–0.85	0.07–0.25	0.03–0.20	
Frosted glass, sand–frosted	1.8–4.4	0.77–0.82	0.09–0.14	0.08–0.10	frosted towards the
		0.70–0.75	0.11–0.16	0.12–0.15	light source smooth towards the light source
Frosted glass, acid–frosted	2.0–6.7	0.83–0.91	0.07–0.10	0.02–0.08	frosted towards the
		0.78–0.89	0.06–0.11	0.02–0.06	light source smooth towards the light source
Frosted glass, on both sides, acid–frosted	1.3–2.2	0.75–0.90	0.06–0.11	0.04–0.19	
Opaline glass	1.1–4.5	0.10–0.38	0.4–0.7	0.12–0.30	compact–opaque, without directed transmission
		0.37–0.47	0.46–0.57	0.07–0. –11	opaque with directed transmission under 1%
		0.13–0.31	0.55–0.78	0.04–0.10	opaque with directed transmission over 1%
Opaline glass, on one side	1.3–2.8	0.20–0.44 0.19–0.42	0.45–0.68 0.46–0.69	0.10–0.23 0.10–0.23	opaque towards the light sol –~e smooth towards the light source
Opaline flashed glass	1.8–6.2	0.22–0.66	0.30–0.63	0.03–0.28	double–layer glass
Opaline flashed glass, posted on both sides	2.2–3.2	0.24–0.68	0.36–0.53	0.16–0.27	opaque towards the light source

		0.24–0.51	0.30–0.46	0.15–0.36	clear towards the light source
Opaline flashed glass, in three layers	1 –1	0.49–0.58	0.4 –0.5	0.04–0.06	2 clear–glass layers with very thin, well–scattering opal–glass layer in the middle

Table 5 Characteristics of illuminating engineering materials

– metals –

Material	Reflection factor	Absorptance
Aluminium, polished	0.60...0.72	0.28... 0.40
Aluminium, polished and anodized	0.75...0.90	0.10...0.25
Aluminium, dulled	0.55...0.60	0.40... 0.45
Aluminium, foil	0.80...0.87	0.13...0.20
Silver, polished	0.85...,0.94	0.06...0.15
Glass silver mirror	0.70...0.90	0.10...0.30
Olas aluminium mirror	0.90...0.94	0.08...0.10
Platinum, polished approx.	0.62 approx.	0.38
Gold, polished approx.	0.70 approx.	0.30
Nickel, polished	0.53...0.63	0.37...0.47
Nickel, dull	0.45...0.55	0.45...0.55
Chromium, polished	0.60...0.70	0.30... 0.40
Chromium, dull	0.40... 0.45	0.55... 0.60
Rhodium, polished	0.70...0.78	0.22...0.30
Copper, polished	0.48...0.60	0.40... 0.52
Brass, chromium–plated	0.61...0.62	0.38...0.39
Brass, chromium–plated, dull	0.52...0.55	0.45... 0.48
Steel, polished	0.55...0.60	0.40... 0.45
Tin plate	0.67...0.69	0.31...0.33
Enamel, white	0.65...0.80	0.20...0.35
Enamel, white, from synthetic resine	0.85...0.90	0.10...0.15

Table 6 Characteristics of illuminating engineering materials

– paper and paint coats –

Material	Transmision factor	Reflection factor	Absorptance
<u>Paper</u>			
Drawing paper		0.75...0.85	0.15...0.30
Cardboard, white		0.70...0.80	0.20...0.30

Board, white, slightly coloured		0.61...0.65	0.35...0.39
Paper, white (print)	0.05...0.20	0.60...0.70	0.12... 0.21
Vellum paper, noncoloured	0.35...0.55	0.45... 0.48	0.05...0.15
Vellum paper, slightly toned	0.14... 0.41	0.36...0.38	0.22...0.50
<u>Paint coats</u>			
Oil, white		0.76...0.85	0.15... 0.24
Lime, white		0.70... 0.85	0.15...0.30
Lime, ivory–coloured		0.60...0.70	0.30,..0.40
Lime, cream–coloured		0.56...0.72	0.28...0.44
Lime, straw–coloured		0.55...0.67	0.33... 0.45
Lime, chromium –yellow, pure		0.48...0.52	0.48... 0.52
Lime, gold		0.44...0.59	0.41...0.56
Lime, medium–brown		0.27... 0.41	0.59...0.73
Lime, light green		0.40...0.67	0.33...0.60
Lime, dark green		0.10...0.22	0.78...0.90
Lime, grass green		0.12...0.20	0.80... 0.88
Lime, light blue		0.31...0.55	0.45...0.69
Lime, turquoise		0.10...0.15	0.85...0.90
Lime, ultramarine		0.07...0.10	0.90...0.93
Lime, bright red		0.32...0.55	0.45...0.68
Lime, dark– red		0.10...0.27	0.73...0.90
Lime, vermilion		0.20	0.80
Lime, carmine		0.10	0.90

Table 7 Characteristics of illuminating engineering materials – various building materials –

Material	Thickness mm	Transmission factor	Reflection factor	Absorptance
<u>Fabrics</u>				
Cambric, white, linen	0.50...	0.50...0.60	0.30...0.40	0.07...0.10
Cotton, white		0.25...0.40	0.30...0.40	0.23... 0.40
Shirting, white		0.28...0.35	0.57...0.68	0.04...0.08
Silk, white		0.57...0.71	0.25...0.38	0.01...0.06
Silk, coloured		0.27...0.80	0.05...0.25	0.13...0.54
Velvet, black			0.02...0.10	0.90...0.98
<u>Wood</u>				
Plywood			0.38...0.45	0.55...0.62
Oak, light			0.25...0.33	0.67...0.75
Oak, dark			0.15...0.25	0.75...0.85

Pear tree			0.20 approx.	0.80 approx.
Walnut			0.15...0.20	0.80...0.85
Maple-tree			0.27 approx.	0.73 approx.
Mahogany			0.07 approx.	0.93 approx.
Ash-tree			0.30 approx.	0.70 approx.
Birch-tree, waved			0.40 approx.	0.60 approx.
Natural and artificial stones				
Marble, pure white	more than 5		0.75...0.83	0.17...0.25
soaked	3... 5	0.20...0.40	0.30...0.45	0.10...0.35
mottled	3... 7	0.04...0.20	0.48... 0.70	0.18...0.48
Alabaster	8...13	0.17...0.30	0.45...0.67	0.14...0.33
China, white			0.60...0.80	0.20...0.40
Gypsum plaster (stucco)			0.75...0.89	0.11...0.25
Cement lime plaster			0.40... 0.60	0.40...0.60
Mortar			0.40... 0.45	0.55...0.60
Bricks, new, red			0.10...0.20	0.80...0.90
Bricks, old, red			0.02...0.05	0.95...0.98
Bricks, new, yellow	V		0.20...0.30	0.70...0.80

2.2. The Eye and its Visual Capacity

The image of the environment is perceived and its physiological and psychological processing and assessment for experience of life is effected by the

Visual organ

It is the entirety of eye, optic nerve and cerebral cells that transforms the light stimulus into those nerve excitations which are the subjective correlate of the visual perceptions.

At first, the external light stimulus hits the eye.

Eye

This is the part of the visual organ which perceives the image of the external world and which transforms this image into nerve excitation.

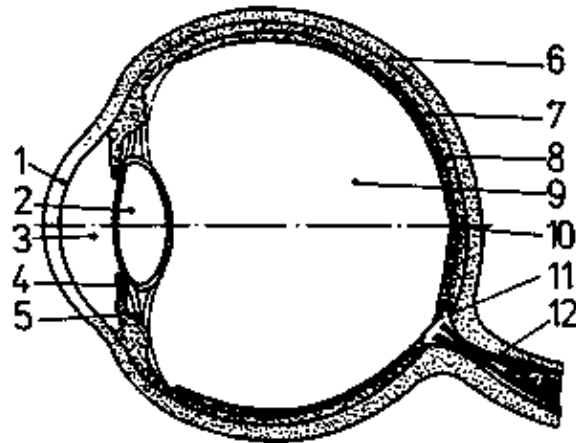

Figure 13. Horizontal section through the human eye

1 cornea (transparent), 2 crystalline lens of the eye, 3 anterior eye chamber, 4 iris, 5 ciliary body, 6 sclerotic coat, 8 retina, 9 vitreous humour, 10 fovea centralis, 11 optic papilla, 12 optic nerve

The most important part of the eye is the retina.

Retina

The light-sensitive membrane of the eye consisting of the light receptors – cones and rods – and nerve cells. The latter lead the excitation to the optic nerves. Cones and rods are embedded in the retina.

Cones

Especially light-sensitive elements of the retina which presumably enable light and colour vision of the light-adapted eye – day vision.

Rods

Especially light-sensitive elements of the retina which most probably enable vision by the darkness-adapted eye. The rods are not likely to contribute to colour vision. (Night vision). The distribution of cones and rods on the retina is different. In the region of the breakthrough of the visual nerve and the choroid through the cornea there are neither cones nor rods. For this reason, this part of the eye is called the "blind spot". On the level of the optical axis of the eye there is a concentration of rods. Here is the region of sharp vision. This part of the retina is called fovea centralis.

Fovea centralis

Thinned and therefore concave central part of the yellow spot showing almost only cones. Region of accurate vision. It is corresponding to a visual angle from 0.017 to 0.035 rad (1 to 2 degrees) in diameter.

From this part of the retina towards its periphery the portion of rods in the retina grows continuously. Finally, there are only isolated cones in the periphery of the retina. With the help of these cones and rods, which have a very differentiated sensitiveness to light, man is able to orient himself in bright sunshine and in moonlight as well. However, experience has shown that the adaptation, especially to a dark environment, takes a certain time. The ability of the human visual organ to adapt itself to light is called

Adaptation

The process of the visual organ adapting itself to luminances and chromatic stimuli in the range of vision.

Condition achieved after completion of the process. The term 'light adaptation' is used if the luminance is at least a few candela per square metre; if it is less than some hundredth parts of a candela per square metre one speaks of 'dark adaptation'. With a physical radiation in the range from 380 to 780 nm seeing is enabled by the cones and rods.

Seeing; visual perception – specific excitation of the sensory system of the eye.

Recognition of the surrounding world by sensory impressions caused by incident radiation.

In this process, rods and cones are included separately or in common because they absorb the incident radiation. The electric pulses created during the absorption of the radiation are led to the brain via the optic nerve, which is the junction of the ends of cones and rods, and – in the optic centre – result in conscious perception.

Perception

Complex content of the consciousness resulting from sensorial impression and contents of the memory (shape).

Especially, the visual perceptions drop in the ideas we form of the existence, form and position of external things.

Since, with the process of seeing, it is not as often a question of stationary things as it is a question of objects in motion, the time for which these objects come into vision is of special importance. The movement of the things, that is to say the impression of movement, may also be caused by the movement of the eyes. Thus, the speed of perception must be considered as a decisive value in the process of seeing.

Speed of perception

Reciprocal of the interval of time passing between the moment of objective exposure of a thing to the eye and the subjective perception of the image.

This term is equivalent to that of 'speed of perception of form'. Another parameter in the context of the perception of the environment is colour.

Colour

– Colour sensation: That characteristic of a visual sensation which makes it possible to distinguish between two neighboring parts of the viewing field equal as to their size, shape and structure but different in their spectral condition.

– Colour valence: Characteristic of a visible radiation which makes it possible to distinguish between two neighboring parts of the viewing field equal as to their size, shape and structure but different because of the different spectral condition of the respective radiations.

Colour sensation is only possible if object, physical radiation and action of the eye concur. Colour sensation can be influenced by the colour of the object as well as by the spectral composition of the radiation. In general, the colour of the object is called body colour.

Body colour

Colour of a non-luminous object: colour sensation caused by a non-luminous object.

The CIE definition of the term of 'seeing' speaks of the 'recognition' of differences in the surrounding world. This can be put in more concrete terms: The eye distinguishes on the one hand brightness and luminance contrasts and on the other hand colour contrasts.

Contrast

– Subjectively: Mutual influencing of two immediately neighboring or successive visual impressions – simultaneous contrast, successive contrast.

– Objectively: The size of the luminance contrast defined by formulae.

If the visual function is reduced by an unfavourable distribution of luminance, too high luminance or too great spatial or temporal luminance contrasts causing an unpleasant feeling – discrimination threshold, etc. – we speak of dazzle.

Literature distinguished between two main types of dazzle:

Psychological dazzle

Kind of dazzle causing an unpleasant sensation without a distinct reduction of the visual capacity being necessarily linked with this feeling.

Table 8 Glare terms according to Schober

Term	Meaning	Examples
Adaptation glare	Sudden change of the luminance level in the field of vision	Flickering of the lighting installation, temporal sunlight incidence with partially clouded sky
Relative glare	Too great simultaneous local luminance differences in the field of view	Light working places in a dark room
Absolute glare	Luminance exceeding the adaptation ability of the eye	Luminance of the sun, the arcs of highest-pressure xenon or mercury lamps, of the full headlight beam of a car at night
Direct glare	Glare caused by light sources	Bare filament lamps, fluorescent lamps and high-pressure mercury lamps near the field of view
Indirect or reflection glare	Glare caused by the ghost image of a light source or by too bright light-scattering surfaces in the field of view	Reflection of the luminance of lamps on the material worked, e.g. a turning part, keys of a typewriter and others, sky luminance of the windows with writing-tables standing in front of them (see also example of indirect glare)
Surround field glare	Glare source is situated at the circumference of the field of view	

Physiological dazzle

Kind of dazzle leading to a reduction of the visual capacity without necessarily causing an unpleasant sensation simultaneously.

With moving objects, flicker may cause a special effect:

Stroboscopic effect

Illusion of motion consisting in the fact that objects in motion appear as resting or in a condition other than their real one because they are illuminated by periodically variable light of a suitable frequency.

2.3. Colour, Light and Space

The aims of illumination include the following components: Light (light source, lighting fitting), colour (colours of the ceiling, walls and furniture etc.) as well as the spatial conditions (dimensions of the room, measuring planes). These have to be considered in order to achieve an economical illumination. The efficiency of the lighting installation is determined by the possibility of directing the light of the respective light source, to diffuse it – according to purpose – or to reflect it. A distinction is made between illuminator efficiency and degree of the effect of depth. Both together result in the efficiency of illumination.

Efficiency of the illuminator

The illuminators shall fulfill their task of directing the luminous flux with the lowest possible light flux loss. Light flux losses are caused by losses in transmission and reflection at lighting fitting components. The efficiency of an illuminator (optical efficiency) is the ratio of the light flux emitted by the illuminator $\Phi(2)$ and the sum of the light flux generated by the individual lamps within the respective illuminator $\Phi(1)$.

$$\text{Eta(LO)} = \frac{\text{Phi}(2)}{\text{Phi}(1)}$$

Degree of the effect of depth

For projecting indoor lighting installations according to the light flux method, the degree of the effect of depth Eta (R) has to be determined. It considers the effects of the room on the direction of the light flux on the plane of calculation Phi (3). It depends on the proportions of the room, the values of the degree of reflection of the limiting surfaces of the room and the mode of construction and is defined by

$$\text{Eta(N)} = \frac{\text{Phi(N)}}{\text{Phi}(1)}$$

Degree of illumination efficiency

The degree of the illumination efficiency Eta (B) is calculated from the degree of efficiency of the illuminator Eta (L) and the degree of the effect of depth Eta (R):

$$\text{Eta(B)} = \text{Eta(L)} \times \text{Eta(R)}.$$

Thus, the degree of illumination efficiency is the ratio of the light flux Phi(3) reaching the area of use and the lamp-emitted light flux Phi(1):

$$\text{Eta(B)} = \frac{\text{Phi}(3)}{\text{Phi}(1)}$$

The degree of illumination efficiency has very wide limits; in practice values between 0.05 and 0.9 are to be found.

Light and colour

The use of colours in a working room deserves more and more attention because due to the ever more sophisticated processes of work the required illumination values at work places amount to 1000 lx and more. A consequence of the putting into practice of so great an illuminance is that the luminance in the range of vision can no more be an optimal one, if no coloured surfaces are used in the working room.

The spectral composition of the light energy emitted by the lamps is different depending on the kind of light generation – temperature radiators or gas-discharge light source – and on the type of lamp which is used.

In warm light colours also warm body colours make themselves felt in a pleasant way, whereas the low proportion of short-wave radiation of these light sources more or less "kills" cold colours such as bluish green, blue and purple. With neutral-white light sources, all colour shades are assessed as equal. Lamps of this group are called 'safe light colours'.

As background colours – wall and ceiling colours – white or light colours of little intensity such as pastel colours are preferred. Here, one can speak of "safe wall colours". On the other hand, very dark background colours are accepted, too. Colours of a medium intensity and brightness are estimated least.

The question whether or not the colour of an object is felt as pleasant or unpleasant mainly depends on the colour of the background before which the object is presented. Therefore, a well chosen background colour may counteract even a 'bad light source' as well as, the other way round, a disadvantageous background colour may spoil the effect of a 'good light source'. Independent of the light colour and the colour of the background, the cold colours blue, bluish green, green and purple are preferred as object colours. Therefore, they can be understood as 'safe object colours'. On the scale of assessment they are followed by red, yellow ranks last.

Whereas for the background colours very little intensity is preferred, very intensive colours are suited best for the objects. In general, women are inclined to choose warmer colours such as red, yellowish red, and yellow in contrast to men who give preference to the green and bluish green shades.

The colours of food, as a rule, look better in warm light than in colder light.

Two neighboring colours, generally, are felt as harmonious only if they are similar in their shades. The more the colour shades are distant from each other on the hue circle the less harmonious is the impression of the combination.

In spite of the above statements it must be said that the colours in a room create a satisfactory atmosphere only if they are lively and diversified.

Simple repetition of a design and of colours which have proved good, decorative and useful often leads to boredom, monotony and thus to the opposite of the desired effect.

2.4. Quality Characteristics of Lighting

2.4.1. Indoor Lighting

Decisive of the impression an illuminated room leaves is the distribution of brightness and colours in it, i.e. the 'colour climate', which by the CIE dictionary is defined as follows:

The colour climate is the physiologically existing and psychologically active atmosphere of a room resulting from light (illumination and its distribution, kind of illumination and light colour) and from colour (shade, degree of intensity, colour rendition and area distribution in a room) in connection with form.

The following criteria of assessment are applied to indoor lighting:

- physiological–optical assessment taking into consideration the visual work and thus physiological problems relating to work;
- psychological assessment concerning the agreeableness of lighting;
- hygienic assessment as to whether or not the light in its quality and quantity is healthy.

The quality characteristics of lighting are subdivided in four groups.

Table 9 Quality characteristics of illumination

Quality characteristics	Quality factors
Illuminating level	Illumination Illumination distribution Luminance distribution
Glare avoidance	Glare limitation with direct glare Avoidance of reflection glare
Shadowyness and light direction	Shadow depth, gloss
Light and colour	Light colour Colour rendition

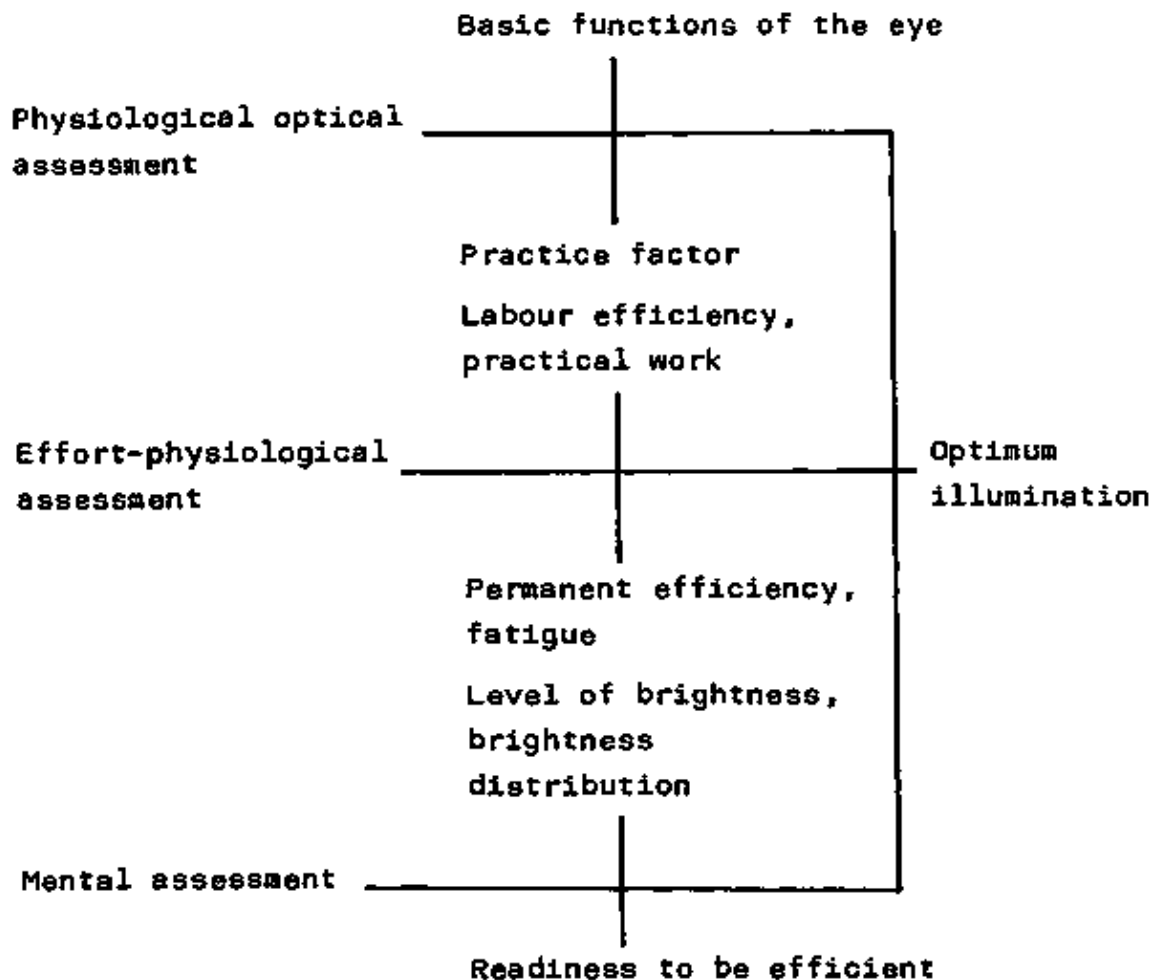

Table 10 Assessing methods and criteria for determining the optimum illumination

Physiological investigations in the relations between illumination and working efficiency

Investigations have shown a direct connection between illumination and efficiency. It is to be seen that the efficiency increases depending on the illumination and the size of the detail of a visual task.

With an increasing fineness of the details, an intensified illumination leads to an increase in efficiency. In this context, of course the level of initial illumination must not be overlooked. Since the physiological investigations in connection with efficiency are carried out over longer periods of time, conclusions can also be drawn with respect to fatigue and lighting as far as fatigue decreases with increasing illumination.

The investigations and findings in connection with the illumination intensity refer to an average visual capacity. The special conditions of seeing at an advanced age and the differences in individual visual capacity were very little considered. An immediate connection between visual capacity – especially visual acuity – and age has been proved. From the fact that younger people often have better eyes it cannot be concluded that older people are less efficient, because there are essential other factors to be considered such as vocational experience and the general attitude towards working. The losses in visual acuity that occur along with the advance in years of life can be balanced to a far extent by an increased illumination in the course of which the specific characteristics of the respective work must not be forgotten.

Glare and glare limitation

Visual capacity is reduced if there are too great differences in luminance within the field of view. In such case one speaks of glare or dazzle.

With indoor lighting fittings it is mostly a question of psychological glare. It causes a feeling of uncomfortableness in man. The assessment of psychological glare and the limitation of it to a permissible degree is an important criterion of the quality of indoor lighting installations. It is distinguished between the glare caused directly by the illuminators in the room – direct glare – and the glare resulting from too great luminances in the field of view, from reflection and/or areas of great luminance within the range of working.

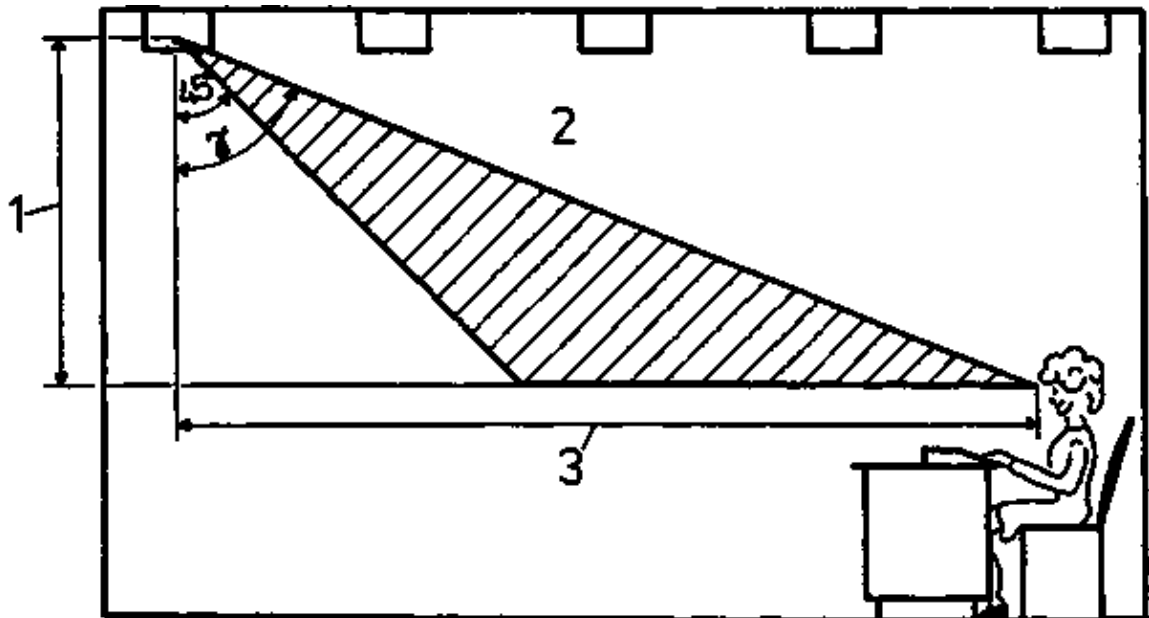

Figure 14. Radiation angle for glare evaluation

1 height difference between eye and illuminator, 2 critical range of the radiation angle, 3 distance of the last visible illuminator

2.4.2. Outdoor Lighting

Similar to indoor lighting, also here the quality depends essentially on the luminance and its distribution in the field of view. Some statements made on indoor lighting also hold good for outdoor lighting.

Not all factors influencing the quality of illumination can be expressed in terms of quantity yet. Therefore, it is important to understand the correlations of the influencing factors in their effect on the quality of lighting. The most important quality characteristics are:

- luminance
- evenness of luminance
- illumination and evenness of illumination
- glare limitation
- optical guidance and additional information
- light design
- operation.

Luminance

Luminance determines the impression of brightness and the visual perception of the range of work or the traffic area. Seeing is the "recognition of differences in the surrounding world...". This is a question of recognizing differences in luminance – brightness differences – and differences in colour. Differences in colour – colour contrasts – generally play a subordinated role in outdoor lighting, because in outdoor areas they are less often represented and – with a low level of illumination – they may be beyond the threshold of visibility at that.

With an increasing luminance, visibility increases, too. This is to say, the eye becomes more sensitive to differences. A further increase in the adaptation luminance of outdoor lighting causes an essential increase in the sensitiveness to differences. For the time being, the luminance of street lighting is approximately 1 candela per square metre. The visual angle can mostly not be influenced. The luminance of the surrounding field can be increased only by much expenditure. Therefore, the creation of favourable contrast conditions is an important task.

Questions for repetition and knowledge test

1. What is the meaning of the term of 'light flux'?
2. What is understood by 'illumination efficiency'?
3. By what factors is the quality of a lighting installation determined?

3. Calculation of Illuminance

The illuminance required in a room or at a working place must be realized – according to the respective visual task – by a suitable number and type of lamps and lighting fittings and their arrangement. For this purpose it is to be calculated how many lighting fittings and lamps are necessary. This can be done by finding the required luminous flux first.

Through the luminous flux of the individual lighting fitting the required number of lighting fittings can be found out. This is called luminous flux method. It is also possible to proceed this way: Calculation from a given arrangement of illuminators and the given luminous flux per illuminator taking into consideration the light distribution of the illuminators the illuminance, for instance at a certain point of the working area. Here, one speaks of the luminous intensity method. Then, the lamp supply of each illuminator or the arrangement of the illuminators must be altered by the difference between the required and the calculated illuminance. It was refrained from an accuracy not required in practice in favour of a more facile application of many calculating methods. The accuracy of the calculated luminous flux or of the calculated illuminance is influenced by the tolerances of the individual calculation factors such as the luminous flux of the illuminator, illuminator efficiency, light distribution curve. Unfortunately, the tolerances of the most important value – the luminous flux of the illuminator – are within wide limits; with gas-discharge light sources the tolerance amounts to 10 or even 15% of the nominal value. Another source of inaccuracy consists in the tolerances of the illuminator efficiency, mainly with the gas-discharge lamps, which in their efficiency depend on temperature. Here, the respective efficiency for a certain surrounding temperature must be indicated in connection with correction factors considering the different thermal behaviour of the illuminators and the illuminator equipment.

3.1. Luminous Flux Method for Interior Space

To calculate the required number of illuminators that shall be symmetrically distributed in a room the following details must be given:

1. The required medium illuminance depending on the visual task

Table 11 Minimum illumination

Place to be lighted	Illumination in lx
Traffic roads	50
Stairs	100
Office rooms	500
Assembly work at consumer goods	1000
Goldsmith's work	1500
Sales rooms	300
Locksmith's work (fine)	300
Locksmith's work (rough)	100
Building sites	20
Filling stations	100
Canteens	200

Schoolrooms	250
Rough work	100

2. Colour of the ceiling and walls

Table 12 Reflection factors (selection)

Reflecting object	Reflection factor
Paper (white)	0.84
Wood (spruce)	0.50
Wood(plywood)	0.38
Bricks (yellow)	0.32
Bricks(red)	0.18
Lime plaster (grey)	0.42
Dry concrete (grey)	0.32
Asphalt (wet)	0.05
Paints (chalk–white)	0.80
Paints (lemon yellow, ivory, creme)	0.70
Paints (medium ochre)	0.52
Paints (lime green, pastel)	0.50
Paints (silver–grey)	0.35
Paints (beige)	0.25
Paints (vermilion, grass–green)	0.20
Paints (carmine)	0.10







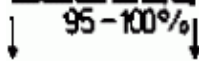

3. Surface of the room (dimensions)
4. Suspension height of the illuminators
5. Measuring plane (height of floor)
6. Cleaning cycle, degree of getting dusty

Table 13 Depreciation factor with indoor lighting installations

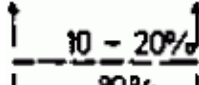
Type of illumination	Getting dusty		
	slightly	normal	much
Direct	0.9	0.8	0.6
Mainly direct	0.9	0.8	0.6
Uniform	0.8	0.8	--
Mainly indirect	0.8	0.7	--
Indirect	0.8	0.7	--

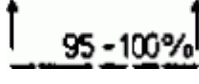
7. Type of illumination

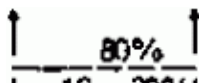
Table 14 Types of illumination

Type of illumination		Luminous flux emittance	Material of the lighting fitting
Direct			light-tight, reflecting
Mainly direct			transparent, partially reflecting
Indirect			light-tight, reflecting
Mainly indirect			transparent, partially reflecting
Uniform			transparent

8. Type of light source

Table 15 Survey of light sources

General-service lamps				Fluorescent lamps					
Wattage rating	Clear glass bulb	Internally coated	Durolife lamp	Wattage rating	Twin-tube	Rod shape diameter (mm) 16	U-shape 26	Ring shape	
(W)	(lm)	(lm)	(lm)	(W)	(lm)	(lm)	(lm)	(lm)	(lm)
25	220	218	190	4		150	-	-	-
				5	250		-	-	-
40	430	395	360	6	-	300	-	-	-
				7	400	-	-	-	-
60	730	680	620	8		450	-	-	-
				9	600	-	-	-	-
75	960	900	825	10	600	-	-	-	-
				11	900	-	-	-	-
100	1380	1280	1170	13	900	950	-	-	-
				15	-	-	900	900	-
150	2200	-	-	16	-	-	900	900	-
				18	1200	-	1450	950	-
200	3100	-	-	20	-	-	-	-	1100
				22	1800	-	-	-	-
300	5000	-	-	24					
				26	1800	-	-	-	-

500	8400	-	-	30	-	-	1700	-	1700
				32					
1000	19000	-	-	36	2900		3450	-	-
				38	-	-	2700	2700	-
1500	29000	-	-	40	-	-	-	-	2800
				50	-	-	5400	-	-
2000	40000	-	-	65	-	-	-	4500	-

The calculation of an interior space illumination shall be demonstrated by an example of the luminous flux method. The result is of sufficient accuracy.

A classroom shall be illuminated by fluorescent lamps. The double-lamp illuminators are evenly distributed in the room. The room is 7.00 m wide and 12.00 m long. The illuminators shall be suspended at a height of 2.60 m. The measuring plane is supposed to be 0.75 m (level of the desks). The degree of contamination is normal. The ceiling is chalk-white, the walls have an ochre painting. Illumination is direct, the illuminators are not screened on their lower ends but have reflectors on top. The degree of efficiency is supposed to be 1.

Solution: Parameters

Ceiling reflection		according to Table 12:	80%
Wall reflection		according to Table 12:	52%
Required illuminance		according to Table 11:	250 lx
Type of illumination			direct
Depreciation factor (V)		according to Table 13:	0.8
Length of the room (L)		:	12.00 m
Width of the room (B)		:	7.00 m
Measuring plane (ME)		:	0.75 m
Suspension height (hA)		:	2.60 m

Solution: Calculating steps

1. Surface of the room

$$A = L \times B = 12\text{m} \times 7\text{m} = 84.00 \text{ square metres}$$

2. Useful height

$$hN = hA - ME = 2.60 \text{ m} - 0.75 \text{ m} = 1.85 \text{ m}$$

3. Room factor

$$K = \frac{\text{width} \times 0.8 + \text{length} \times 0.2}{\text{useful height}} = \frac{7\text{m} \times 0.8 + 12\text{m} \times 0.2}{1.85\text{m}} = 4.3$$

4. Determination of the illumination efficiency with the help of Table 16: Basis is the rubric 'direct'. Under the term of ceiling reflection 70% (the nearest to 80%), that column is chosen which comes next to the wall reflection, i.e. 50%. This column is gone down until the value of K = 4 is reached.

Here, the value 0.45 (45%) is to be found. This is the degree of room efficiency. Since the efficiency degree of the illuminator was supposed to be 1, it appears that the illumination efficiency is equal to the degree of room efficiency (0.45).

5. Determination of the total luminous flux

$$PHI_{ges} = \frac{E_m \times A}{\eta_B \times V} = \frac{250 \text{ lx} \times 84 \text{ squaremetre}}{0.45 \times 0.8} = \frac{21,000}{0.36} =$$

PHI_{ges} approximately 58,340lm

6. Calculation of the number of lamps

$$n = \frac{\text{total lum. flux}}{\text{lamp luminous flux}} = \frac{58.340 \text{ lm}}{2700 \text{ lm}} \text{ approx } 22 \text{ lamps}$$

7. Illuminator arrangement

The result is that double-lamp illuminators have to be evenly distributed in the room.

Hints concerning the selection of the lamps:

According to the principle of assigning lamps of a certain light colour to the individual activities, it has to be decided about the colour of light after having calculated the number of lamps required.

There are the following colour shades: white, warm-tone, warm-tone extra or white, warm-white, warm-white de luxe as well as universal-white, white de luxe and daylight.

In any case it is advisable – due to the variety of international manufacturers – to use the respective colour temperature for selection, (e.g. warm-white 2900 K; white 4300 K). Furthermore, the starting behaviour of the lamps should be considered. In a cool ambient temperature, fluorescent lamps of the standard type start very bad. In such case, cold-proof lamps should be used. As has been stated, the calculation according to the luminous flux method includes the reflection capacity of ceiling and walls in the design of the lighting installation. No daylight support is added! It is also supposed that the colour of the ceiling and the walls remains unchanged, because otherwise the initial parameters of the illumination would change.

3.2. Luminous Intensity Method – for Rotation-Symmetrical Lighting Fittings

By this method, the illuminance on a surface to be illuminated is calculated, with direct irradiation by the light source and without consideration of reflecting surrounding surfaces (spotlight effect). With the illuminance given the light source can be found.

The following details are required for the calculation:

1. Average illuminance required for the visual task.
2. Type of illuminator with the appertaining light distribution curve indicated by the manufacturer.

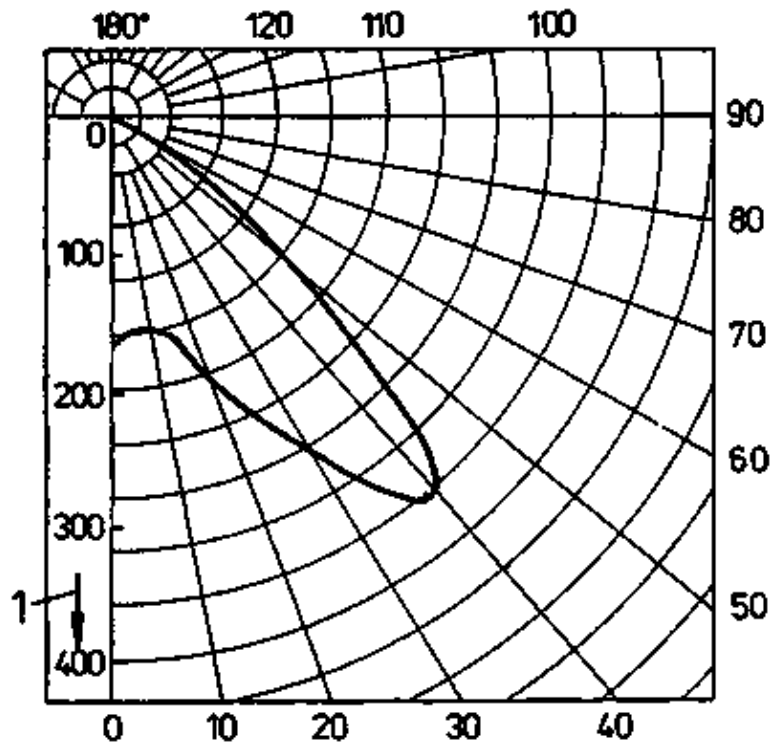

Figure 15. Light distribution curve (rotational symmetrical representation)

- 1 light intensity in cd
3. Suspension height
4. Measuring plane
5. Degree of getting dusty
6. Type of light source
7. Angle of irradiation (indirect by lengths of reference)

Example of a calculation task concerning a lighting installation for an assembly surface (open-air surface). The result is of sufficient accuracy.

An assembly surface shall be illuminated by downlighters equipped with high-pressure mercury vapour lamps. Rough work – locksmith's work – shall be carried out. The dimensions of the surface are 10×10 m. The downlighters shall be installed at a height of 4 m. The required lamp performance has to be found out, if 4 illuminators shall be used.

Solution: Parameters

According to Table 11 for rough work: 100 lx

According to 111. 15: illuminator, general

Light source: suspension height: 4.0 m

measuring plane: 0 m

Degree of getting dusty, depreciation factor: 0.6

Type of light sources high-pressure mercury vapour lamp

Angle of irradiation: This has to be calculated with the help of Pythagoras and function of angles according to the space dimensions. (acc. to Fig. 16).

It amounts to approximately 41.2 degrees.

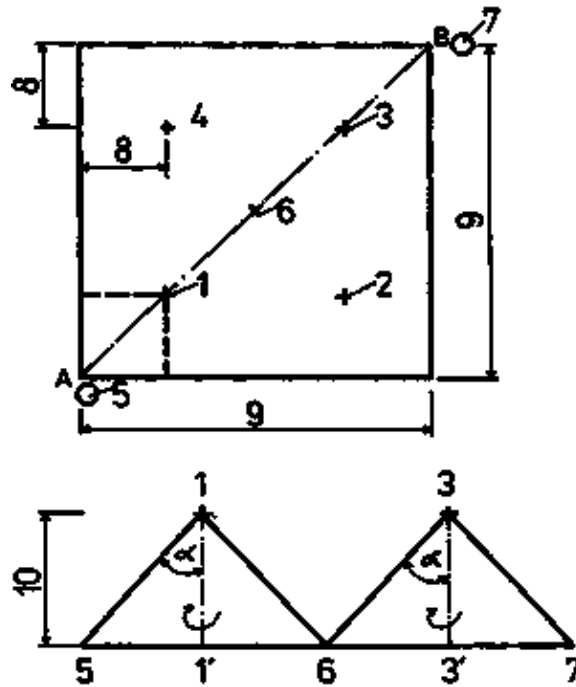

Figure 16. Dimensional sketch

1,2,3,4,6 suspension and/or mounting frames of the lighting fittings, 5,6,7 lighting points resulting from the angle of arrival α , 8 (2.5 m), 9 (10.0 m), 10 (4.0 m), primed 1 and 3 vertical rotation point below the lighting fitting.

Solution: Steps of calculation

1. To 41.2 degrees the corresponding cosine has to be determined. It is approximately 0.425.
2. From the light distribution curve. Fig. 16, approximately 350 cd (candelas) appear.

Application: At 41.2 degree, the curve is intersected. From the point of intersection, the value is read radially on the vertical axis.

3. In order to be able to calculate the required luminous flux, the two formulae for E_p and I_a must be linked, if the respective values are put in as follows

Luminous flux of lamps in lumen (lm)

Illuminance in point 'P' in lux (lx)

Useful height in square metres

Light intensity from the light distribution curve in candela (cd)

Solid angle ratio for rotation-symmetrical light distribution

Depreciation factor (degree of getting dusty in %) the result is a luminous flux of the lamps of 17930 lm

4. Determination of lamps Selection:

High-pressure mercury vapour lamp 400 W = 23.000 lm

High-pressure sodium vapour lamp 250 W = 25.000 lm

5. Counter calculation:

Since the rated luminous flux is greater than the calculated one, it derives for the illuminance in point 'P':

for high-pressure mercury vapour illumination 128 lx

and for high-pressure sodium vapour illumination 139 lx

6. The illuminance adds in the middle of the working surface to $4 \times E_p = 512$ and 556 lx, respectively.

7. Directly under the illuminator the following illuminance is calculated: E_p approx. 302 lx

With high–pressure sodium vapour lamps it would be E_p approx. 328 lx

The illumination distribution, for instance with high–pressure sodium vapour lamps, would be as follows:

+ 139 lx					139 lx +
	+ 328 lx			328 lx +	
		+ 556 lx			
	+328 lx			328 lx +	
+ 139 lx					139 lx +

Questions for repetition and knowledge test

1. By what methods a lighting installation can be calculated?
2. What importance does the type of illumination have for the determination of the number of lamps?
3. What is the importance of the light distribution curve?
4. What is understood by the term of 'illuminance shape'?

4. Measurements at Lighting Installations

4.1. General Remarks

According to the measuring principle, similar instruments are applied to the measurement of illuminance and luminous density. These are always physical measurements.

The photoelectric receivers are photoelements, photoresistors, photodiodes, photomultipliers and others. Their spectral sensitiveness is various and not congruent with the photopic eye response curve. For the correct measuring of illuminance and luminous density values, however, it is necessary that the photoelectric receivers evaluate the light in the same way as the human eye. Therefore, the sensitiveness of the physical receivers must be adapted.

Mostly, this is achieved by filters, but it can also be realized by diaphragm mechanisms. Of course, with supplementary filters and diaphragms, a reduction of the irradiated light energy is connected; the better the adaptation is, the greater becomes the mentioned reduction. Generally, it is compensated by electronic intensifiers.

Since the required measuring accuracy for lighting installations is not very great – it is between 1 and 5% – only approximate adaptations are practised. For this reason, correction factors are indicated on some measuring instruments.

When working with physical receivers, attention must also be paid to the ambient temperature. Sensitiveness alters with higher or lower ambient temperature. Therefore, the receiver must either be thermo–stabilized or this dependence on temperature must be counteracted by correction curves. An especially great importance for the correct assessment of the incident luminous flux is the direction from which the light hits the physical receiver. An exact measurement is possible only with vertically incident light.

4.2. Illuminance Measuring

From the general requirements on physical measuring procedures it derives that the following requirements must be met by illuminance measurements:

- Adaptation of the physical receiver to the photopic eye response curve.
- An adaptor for the receiver for the cosine-true measurement of the incident light.
- As far as possible, linear correlations between illuminance values and indication value of the measuring instrument or correction curves for the individual measuring ranges.
- No influence of the measured value by fatigue of the receiver or by its ambient temperature.

When carrying out measurements, make sure that the measuring instrument and/or its photoelectric receiver is not shaded partially or completely by people or things.

The selection of the measuring points is determined by the measuring task. If the value of illuminance shall be measured in certain check points, make sure that the measuring conditions are the same as with previous measurements. If, for example with a project to be handed over, the average illuminance values shall be measured for comparison with the values demanded by the plan, a great number of measuring points has to be fixed the measuring height of which shall generally be 850 mm above the floor and with which the receiver element must be placed horizontally. The size of the measuring errors has to be chosen in such way that it can be supposed that the illuminance value is constant in each measuring field. This leads to the number of measuring points for the space or part of space to be measured. However, there shall be at least 9 points.

With the measurements the mains voltage has to be checked during the measuring process and indicated in the measuring record.

4.3. Luminous Density Measuring

For measuring the luminous density (surface brightness) also measuring instruments for illuminance may be used if simple additional instruments are applied. It goes without saying that the general requirements in connection with illuminance measuring instruments also apply to luminous density measuring. In this context, attention has to be paid that the receiving area is illuminated as evenly as possible. For the image formation of the surfaces to be measured a luminous density attachment with or without optical system is used.

These kinds of luminance meters are especially suited for measuring floodlighted or transilluminated areas and not for measuring the luminous density at lamps and lighting fittings. For measurements in interior spaces devices of a wide angular aperture are preferred, because – as is known – the medium luminous density in the field of view determines the adaptation of the human eye. Decisive for the adaptation conditions are the surrounding surfaces which are covered by an angle of view of 30 to 50 degrees. If from a number of areas of different luminous density the average value of the luminous density of all the areas shall be calculated, the areas have to be measured individually.

Questions for repetition and knowledge test

1. On what basis do the luminance meters work?
2. What are the measuring methods for measuring illumination installations?

5. Light Sources for Illuminating Purposes

5.1. General Remarks

According to the kind of light generation, the light sources are divided into two groups:

- Temperature radiators and
- Discharge lamps.

The group of temperature radiators includes all universal lamps, projection lamps and halogen lamps. These light sources have a great infrared portion and only a small visible range (approximately 90% of the power rating is heat and 5 – 10% is visible light). Consequently, the light efficiency is very low.

The discharge lamps comprise the group of low-pressure discharge lamps which the fluorescent lamps and sodium vapour discharge lamps (low-pressure lamps) belong to as well as the group of high-pressure discharge lamps which include the high-pressure mercury vapour lamps, halogen metal vapour lamps and high-pressure sodium vapour lamps. This categorization of lamps is of an increasing importance.

5.2. Thermal Radiation Lamps

5.2.1. General-Service Lamps

Construction forms for illuminating purposes

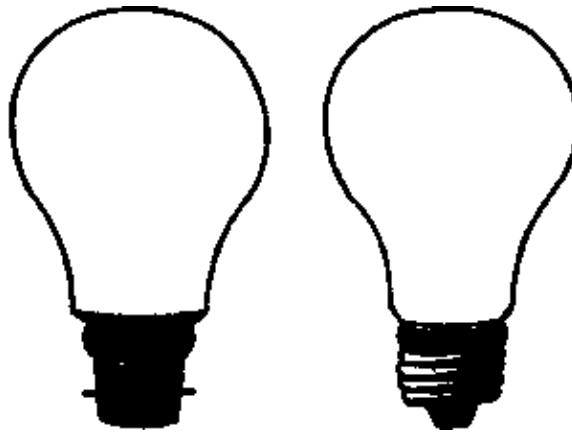

Figure 17. General-service lamps

Base: Screw-thread or bayonet base

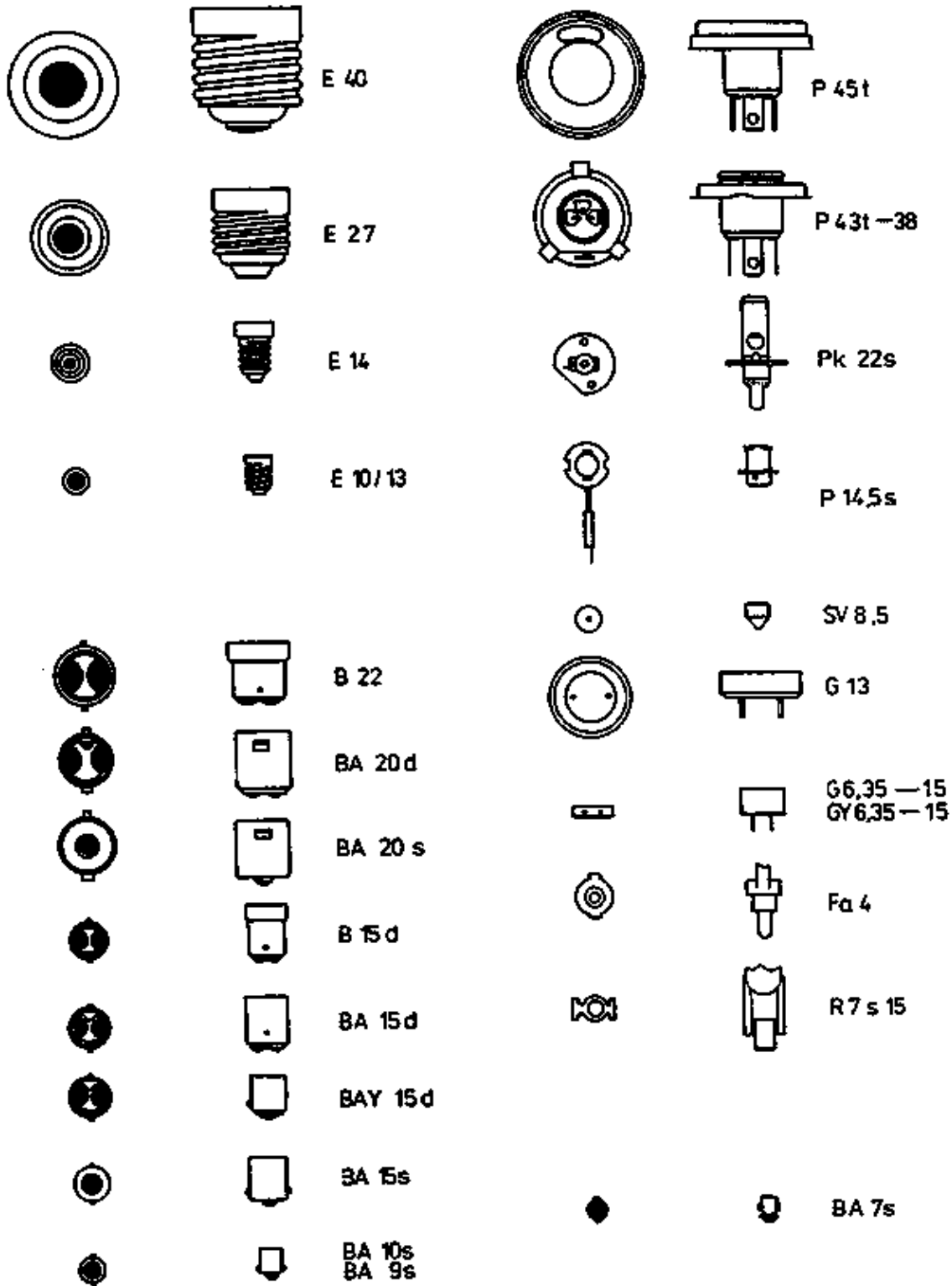

Figure 18. Socket forms for filament lamps

– Bulb: Clear or inside-coated, silvered or with reflector-coating

– Coiled-coil filament: Single or double filament with normal mount or – which is more frequently used – suspension in order to increase the vibration stability and shock absorption

– Gas filling: Argon-nitrogen or krypton-nitrogen mixture

Construction forms for illuminating and decoration purposes

– Bulb: Colour-coated red, orange, yellow, green, blue or pressed patterns or ornaments on the external surface of the bulb

Way of acting

The bulb, after application of its operating voltage, takes a higher current from the mains (starting current) than it will consume after having reached the operating point. The great current density in the coiled-coil filament with much heat development results in bright incandescence, that is to say in the generation of visible light.

Increased voltages lead to increases in the luminous flux but reduce the service life of the bulb considerably. For example: If the mains voltage rises by 5%, the service life of the bulb falls to about 55%, the luminous flux being increased by 20%. Bulbs are produced of an efficiency up to 2000 W.

Use

– For illuminating purposes

In local lamps, decoration lamps, domestic lighting fittings, lighting fittings for purposes of representation and in technical lamps. Use for industrial purposes was much limited for energetic reasons in favour of the discharge lamps.

– For advertisement and illumination

Here, it is the luminous effect that counts, the light power is of secondary importance. The professional use of such lamps requires knowledge in the field of light effects such as colour stimulation, blending of colours, colour suppression.

Hints to practice

Do not put bulbs into lighting fittings with fatty or sweaty hands. Vibrations in general and shock especially have to be avoided when bulbs are in operation.

With frequent defects of bulbs the mains voltage has to be checked – overvoltages. See also way of acting. The wear of the tungsten filament requires a replacement of the bulb after the rated lamp life has expired even if it has not become defect by that time. (The energy consumption increases the older the bulb grows).

For a correct order the following bulb details are required: Rated voltage, power rating in watt and/or luminous flux in lumen, type of base and bulb and/or special wishes such as silvering, colour or ornament glass.

In recent time, the development in the field of bulbs has been intensified. Tungsten-halogen lamps – also in the range of low voltages – have been used more and more. Compact and tubular lamps, too, are used frequently. The trend goes towards a lamp of high light power and little energy consumption.

Spot lights are often designed on the basis of a low-voltage halogen lamp operated through a small transformer in an E 27 lamp base. The service life is remarkably longer than with traditional lamps.

5.2.2. Shaped Lamps for Technical and Decorative Purposes, Tube Lamps

This group of lamps includes bulb lamps 15 and 25 W, drop lamps 25 to 40 W and large candle lamps 15 to 60 W. These lamps are used for decorative lighting purposes, for smallest lighting fittings as well as for the illumination of refrigerators and switching plants.

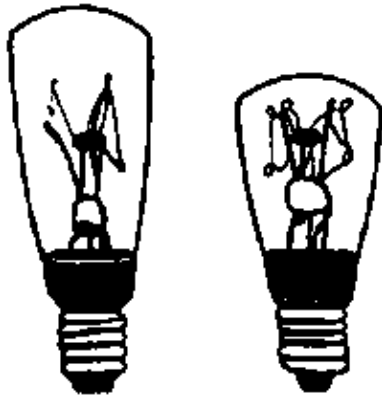

Figure 19. Pear–shape lamps

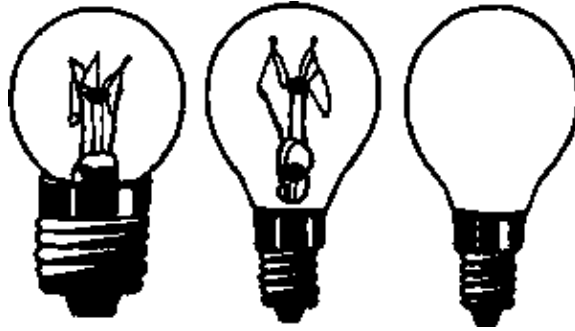

Figure 20. Drop–shape lamps

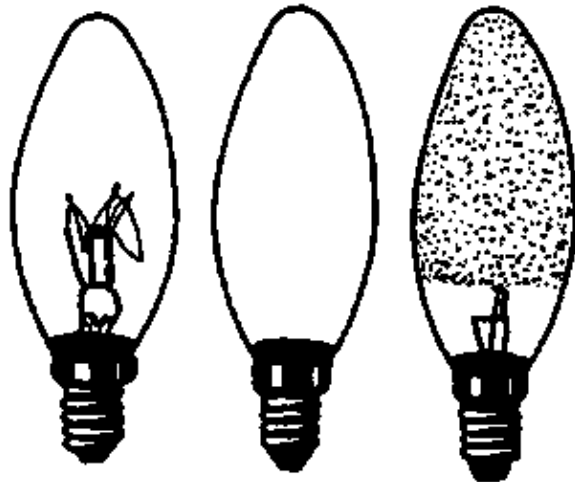

Figure 21. Large candle lamps

Similar in construction are tube lamps from 15 to 25 IV, which are used in various versions as control lamps, sewing machine lamps as well as in small local and decoration lamps.



Figure 22 Tube lamps

5.2.3. Projection Lamps

With projection lamps, the correlation of light efficiency and service life with thermal radiators is applied in favour of the luminous flux. For illumination engineering only a few types are important, among others the A projection lamps the average service life of which amounts to 300 h. The burning position of these lamps has also to be taken into consideration.

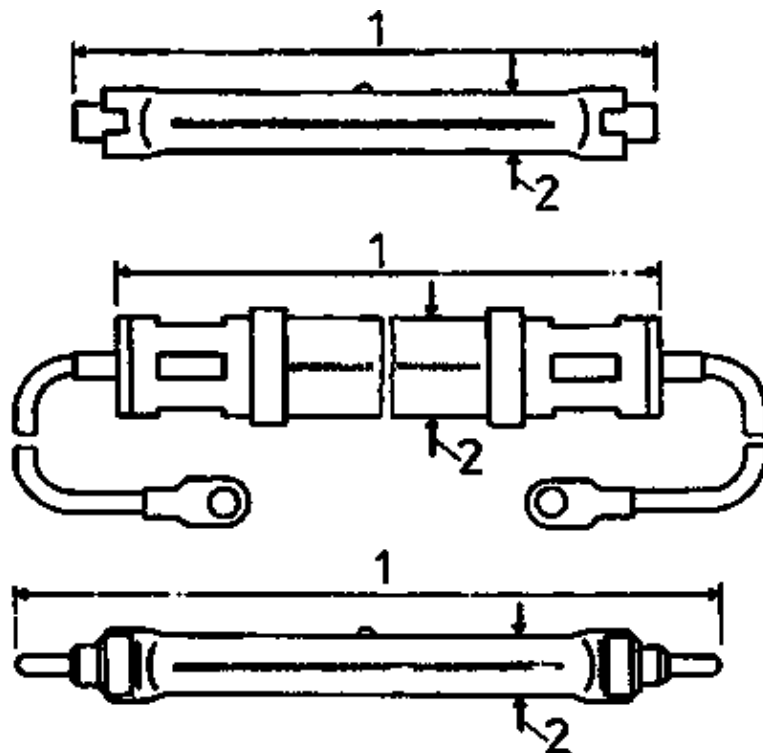

Figure 23. Projection lamps

1 length of lamp
2 diameter of lamp

5.2.4. Halogen-Filled Incandescent Lamps

Halogen-filled incandescent lamps due to their way of functioning must be made of quartz glass or hard glass. When using these lamps make sure that certain admissible temperature limits at some parts of the lamps as well as the given burning position are observed.

The main characteristics of the halogen-filled incandescent lamps are:

- Small dimensions
- No bulb blackening
- Constant luminous flux
- Constant colour temperature
- Colour temperature up to 3400 K
- Longer service life
- Higher luminous flux.

Halogen-filled incandescent lamps are prevailing in the fields of film and photo shooting, lighting fittings for motor vehicles, floodlighting and with slide and narrow-gauge film projectors.

Hints to practice

Projection lamps and halogen-filled incandescent lamps are manufactured in the range of 1000 to 5000 W and, according to type, achieve luminous fluxes up to 125.000 lm in the high-voltage range of 225 V.

With the operation of these lamps, the prescribed burning position must be observed by all means.

In any case, the instructions of the manufacturer have to be considered.

5.3. Discharge Lamps

5.3.1. Low-Pressure Lamps

By this term a low power density in the entire discharge space is understood, i.e. the discharge is distributed over the full cross section.

The most important representatives of this group of light sources are the fluorescent lamps and the low-pressure sodium vapour lamps.

5.3.1.1. Tubular Fluorescent Lamps Forms

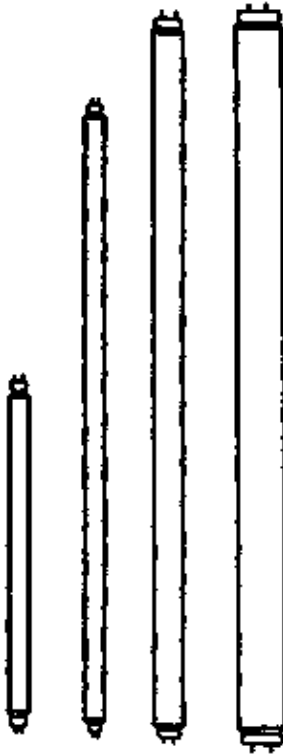

Figure 24. Fluorescent lamps (rod-shape)

- Rod-shaped lamp with bipin caps of 16, 26, 32 and 33 mm in diameter
- Rod-shaped lamp with single-pin caps of 38 mm in diameter (rapid-start lamp)
- U-shape with bipin caps, 26 and 38 mm in diameter

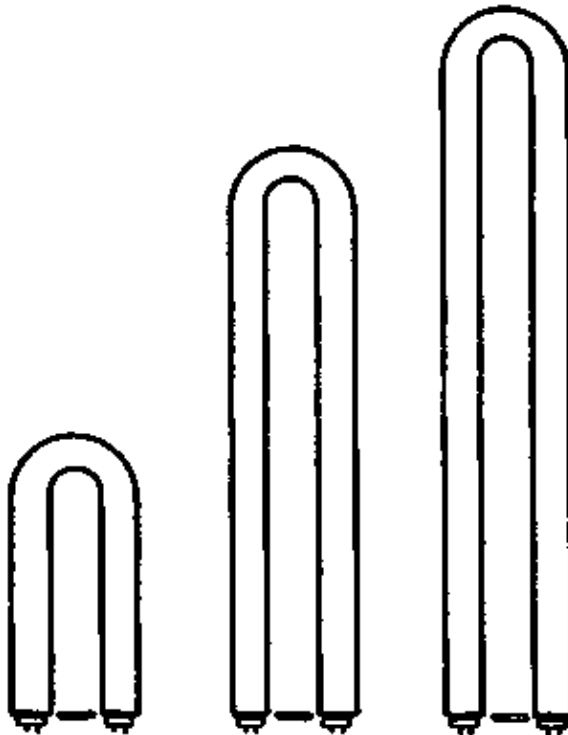

Figure 25. Fluorescent lamps (U-shape)

- Ring-shaped lamp with external ring diameters of 216, 311 and 413 mm and tube diameters of 29 and 32 mm
- Twin tube lamps with the caps G 23, G 24d-1, G 24d-2, G 24d-3, and 2 Gil, a tube diameter of 13 mm and a power range of 5 to 35 W.

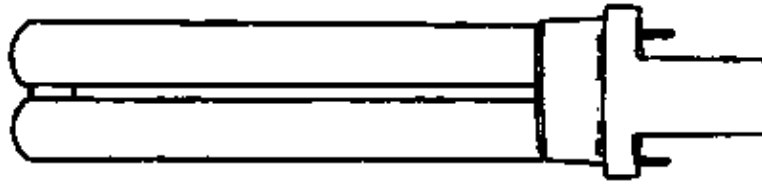

Figure 26. Twin-tube lamp

Table 16 Utilization factors

Type of ill.	Luminous emittance	K	(Rho in %) for ceiling								
			70	50	30						
			(Rho in %) for wall								
			50	30	10	50	30	10	50	30	10
			Utilization factor of the room (Eta)								
Direct	0	1	0.20	0.17	0.15	0.20	0.17	0.15	0.20	0.17	0.14
		1.2	0.24	0.20	0.17	0.23	0.20	0.17	0.23	0.20	0.17
		1.5	0.28	0.24	0.21	0.27	0.24	0.21	0.27	0.24	0.21
		2	0.33	0.30	0.27	0.33	0.30	0.27	0.32	0.29	0.27
		2.5	0.37	0.34	0.31	0.37	0.33	0.31	0.36	0.33	0.31
	75	3	0.40	0.37	0.35	0.40	0.37	0.35	0.39	0.37	0.35
		4	0.45	0.42	0.40	0.44	0.42	0.40	0.44	0.42	0.40
		5	0.48	0.46	0.44	0.47	0.45	0.44	0.47	0.45	0.44
		5	0.50	0.48	0.46	0.49	0.48	0.46	0.49	0.48	0.46
		8	0.53	0.51	0.50	0.52	0.51	0.50	0.52	0.51	0.50
75	10	0.55	0.54	0.53	0.55	0.54	0.53	0.54	0.54	0.53	
Mainly direct	18	1	0.19	0.15	0.13	0.18	0.15	0.13	0.17	0.14	0.12
		1.2	0.22	0.18	0.16	0.21	0.18	0.15	0.20	0.17	0.15
		1.5	0.26	0.22	0.20	0.24	0.21	0.19	0.23	0.20	0.18
		2	0.31	0.28	0.25	0.29	0.26	0.24	0.28	0.25	0.23
		2.5	0.35	0.32	0.29	0.33	0.30	0.28	0.31	0.29	0.27
	83	3	0.38	0.35	0.32	0.36	0.33	0.31	0.33	0.31	0.30
		4	0.42	0.39	0.37	0.40	0.38	0.36	0.38	0.36	0.34
		5	0.45	0.43	0.41	0.42	0.41	0.39	0.40	0.39	0.37
		6	0.47	0.45	0.43	0.44	0.43	0.42	0.42	0.42	0.40
		8	0.50	0.48	0.47	0.48	0.46	0.45	0.45	0.44	0.43
65	10	0.52	0.51	0.50	0.49	0.48	0.48	0.47	0.46	0.45	
Uniform	40	1	0.13	0.10	0.08	0.12	0.09	0.07	0.06	0.06	0.05
		1.2	0.16	0.13	0.10	0.14	0.11	0.09	0.08	0.07	0.07
		1.5	0.19	0.16	0.13	0.17	0.14	0.12	0.10	0.09	0.09

		2	0.23	0.20	0.17	0.20	0.17	0.15	0.13	0.12	0.12
		2.5	0.26	0.23	0.20	0.22	0.19	0.17	0.15	0.14	0.14
	83	3	0.28	0.25	0.22	0.24	0.21	0.19	0.16	0.16	0.16
		4	0.32	0.29	0.26	0.27	0.25	0.23	0.19	0.19	0.19
		5	0.34	0.31	0.29	0.30	0.27	0.25	0.22	0.21	0.21
		6	0.35	0.33	0.31	0.31	0.29	0.27	0.23	0.23	0.23
		8	0.38	0.36	0.34	0.34	0.32	0.30	0.26	0.26	0.26
	43	10	0.40	0.38	0.36	0.35	0.34	0.32	0.28	0.28	0.28
Mainly indirect	60	1	0.12	0.09	0.08	0.09	0.07	0.06	0.04	0.04	0.04
		1.2	0.14	0.12	0.09	0.11	0.09	0.08	0.05	0.05	0.05
		1.5	0.17	0.15	0.12	0.14	0.12	0.10	0.07	0.07	0.07
		2	0.21	0.18	0.16	0.16	0.14	0.13	0.09	0.09	0.09
		2.5	0.23	0.21	0.19	0.19	0.17	0.15	0.11	0.11	0.11
	82	3	0.25	0.23	0.21	0.20	0.18	0.17	0.12	0.12	0.12
		4	0.28	0.26	0.24	0.23	0.21	0.19	0.14	0.14	0.14
		5	0.30	0.28	0.27	0.24	0.23	0.21	0.16	0.16	0.16
		6	0.32	0.30	0.28	0.25	0.24	0.23	0.17	0.17	0.17
		8	0.34	0.33	0.31	0.27	0.26	0.25	0.19	0.19	0.19
	22	10	0.35	0.34	0.33	0.28	0.27	0.26	0.20	0.20	0.20
In-direct	80	1	0.11	0.09	0.07	0.08	0.06	0.05	0.05	0.04	0.03
		1.2	0.13	0.11	0.10	0.09	0.08	0.07	0.05	0.05	0.04
		1.5	0.16	0.14	0.12	0.11	0.10	0.08	0.06	0.06	0.05
		2	0.19	0.17	0.16	0.14	0.12	0.11	0.08	0.07	0.06
		2.5	0.22	0.20	0.18	0.15	0.14	0.13	0.09	0.08	0.07
	80	2	0.24	0.22	0.20	0.17	0.15	0.14	0.10	0.09	0.08
		4	0.26	0.25	0.23	0.19	0.18	0.17	0.11	0.10	0.10
		5	0.28	0.27	0.26	0.20	0.19	0.18	0.12	0.11	0.11
		6	0.29	0.28	0.27	0.21	0.20	0.19	0.12	0.12	0.11
		8	0.31	0.30	0.29	0.22	0.21	0.21	0.13	0.13	0.12
	0	10	0.32	0.31	0.30	0.23	0.22	0.22	0.13	0.13	0.13

Efficiency

(See Table 15)

Colours

The manufacturers of light sources have their own colour designations and appertaining code numbers. At present, there is no international standard in this field. The below selected examples shall demonstrate three national colour designations.

Table 17 Survey of three national determinations of colour (arranged according to colour temperature)

Colour	Colour temperature (K)	Producer country	Characteristic
Warm tone Extra	2700	FRG	82
Warm tone Extra de Luxe	2700	FRG	92
Intima de Luxe	2700	Hungary	F271
Warm white	2900	GDR	30
Warm white de Luxe	2900	GDR	31
Warm white	2900	Hungary	F29
Warm white de Luxe	2900	Hungary	F32
Warm tone	3000	FRG	83
Warm tone de Luxe	3000	FRG	93
Special de Luxe	3000	Hungary	F301
White de Luxe	3800	FRG	94
White	4000	FRG	84
White-Universal	4000	FRG	25
Natural white de Luxe	4000	Hungary	F62
Neutral white de Luxe	4100	GDR	21
Neutral white	4300	GDR	20
Universal white	4300	Hungary	F25
White	4300	Hungary	F33
White de Luxe	4300	Hungary	F34
Daylight de Luxe	5000	FRG	95
Daylight	6000	Hungary	F7
Daylight white	6500	GDR	10
Cold daylight	6500	Hungary	F72
Red		FRG	15
Red		GDR	94
Red		Hungary	
Pink		Hungary	
Orange		Hungary	
Yellow		FRG	16
Yellow		Hungary	
Green		FRG	17
Green		GDR	92
Green		Hungary	
Blue		FRG	18

Blue		GDR	91
Blue		Hungary	
Lumoflor		GDR	81

The above comparison of various manufacturers of tubular fluorescent lamps shows how difficult it is to realize certain definite aims of illumination only starting from the colour designation. For this purpose, the documentations of the manufacturers are absolutely necessary.

Starting aids, starting mechanisms

Tubular fluorescent lamps need starting aids. Without that the fluorescent lamp cannot be operated.

- Starter for separate switching
- starter for tandem switching
- Electronical starter

Starterless operation is enabled by rapid lamps. Here, the starting aid is a special series–reactor switching device as well as a conductive ignitionstrip alongside of the lamp.

Series reactors

They are required to supply a sufficient ignition voltage and to reduce the mains voltage to the lamp voltage.

There are:

- Inductive series reactors (separately for each lamp power)
- Transistor series reactors (for tubular fluorescent lamps for operation with 12 or 24 V direct current voltage)
- Electronic series reactors (for flicker–free start without starter, GS–operation, light control etc.)

Way of acting

After connection of the lamp, a glow discharge takes place in the starter heating up the bimetal which is situated in the starter. This bimetal bends due to the heat and closes the lamp circuit. Then, the tungsten electrodes are heated up and stimulated to emit electrons. Thus the internal space of the lamp is ionized. Simultaneously, a magnetic field is induced by the current that flows through the ballast. Meanwhile, no glow discharge took place in the starter, the bimetal cools down and opens the circuit. By this, the field of force collapses in the ballast, the lines of force intersect the bobbin inducing a high voltage (up to 1300 V). This voltage is able to overcome the ionized internal space of the lamp from electrode to electrode. It comes to a gas discharge. The fluorescent layer is stimulated to emit light. After ignition, the ballast fulfills the function of a variational resistor. A portion of the mains voltage drops over the ballast, it remains the portion which is fed into the lamp as operating voltage. The ballast also limits the operating current to the permissible value of the lamp current.

For this reason, only one ballast is allowed to be used for the lamp, which corresponds to the lamp current. Fluorescent lamps can also be operated by direct current voltage, if the lacking a.c. resistance is replaced by an ohmic resistance and the lamp is pole–changed from time to time with the help of an intermediate switch.

Use

Today, fluorescent lamps are used for many purposes. As far as suitable lighting fittings are available, the existing lamp colours and performance parameters allow the use of fluorescent lamps for almost all and every lighting purpose. By the creation of electronic ballasts, the disturbing flickering and dangerous stroboscopic effect of the fluorescent light is eliminated.

However, with the use of fluorescent lamps psychological aspects must be considered, because certain branches of the food, textile and paint industries as well as artistic fields such as painting and graphic arts can make only limited use of fluorescent light due to colour falsification, shadelessness and so on. Man is

emotionally stimulated by colours and coloured light, that is to say, emotions can be influenced. These problems were only very little touched by the bulb.

New in the range of fluorescent lamps are black–light lamps for special effects or detection of colour falsification in paintings, the baby–blue lamp for combatting jaundice with babies as well as the germicid lamp which is used for degerming the air. The lumoflor lamp is used for the acceleration of plant growth.

Hints to practice

The best ambient temperature for fluorescent lamps is 25° centigrade. With increasing ambient temperature, the service life of the fluorescent lamp decreases.

Since the fluorescent lamp is operated by means of inductive ballast, it is an inductively loaded collector that imposes the required blind power on the network, i.e. on all supply lines. The network can be relieved to a great extent by compensation capacitors which store the required blind power. The following reference values are applicable to fluorescent lamps:

- Power group 13 to 20 W = 3 microfarad
- Power group 36 W = 4 microfarad
- Power group 65 W = 7 microfarad

For interference suppressing (elimination of radio interference), suppressor capacitors of 0.022 microfarad/250 C are connected in parallel per lamp at the lamp feeding point (illuminator entrance).

Fluorescent lamps are connected as follows:

- Single connection (classical version)

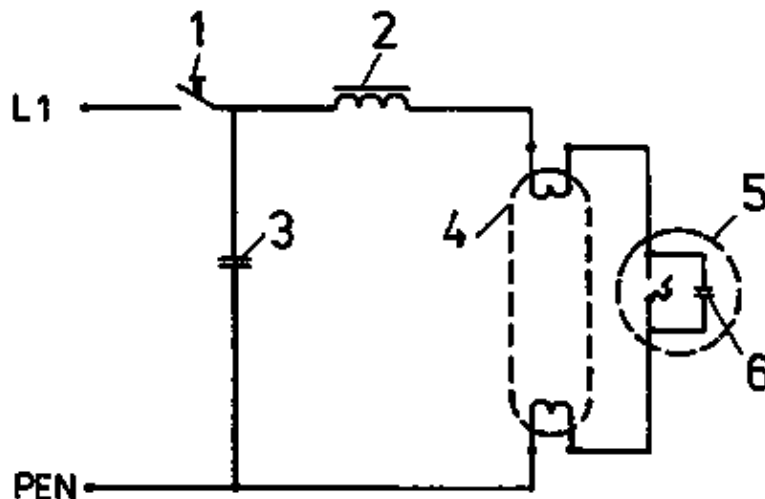

Figure 27. Separate switching of fluorescent lamps

- 1 switch, 2 series reactor,
- 3 compensation capacitor,
- 4 fluorescent lamp, 5 starter, 6 anti–interference capacitor

- Tandem connection

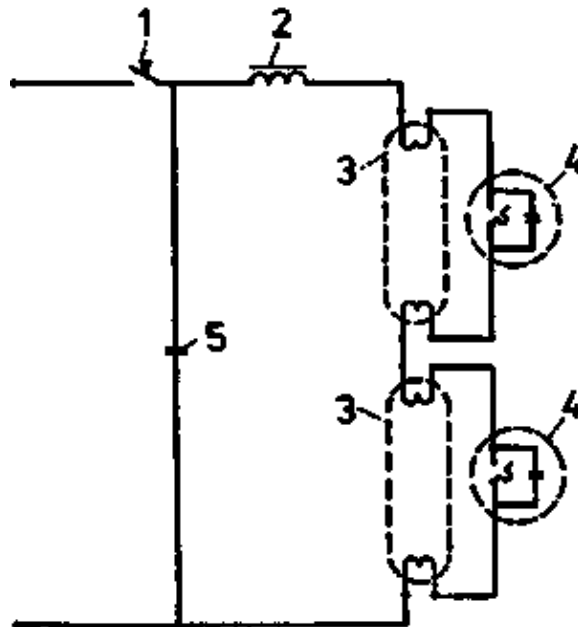

Figure 28. Tandem switching of fluorescent lamps

1 switch, 2 series reactor,
3 fluorescent lamps, 4 starter,
5 compensation capacitor

– Rapid connection

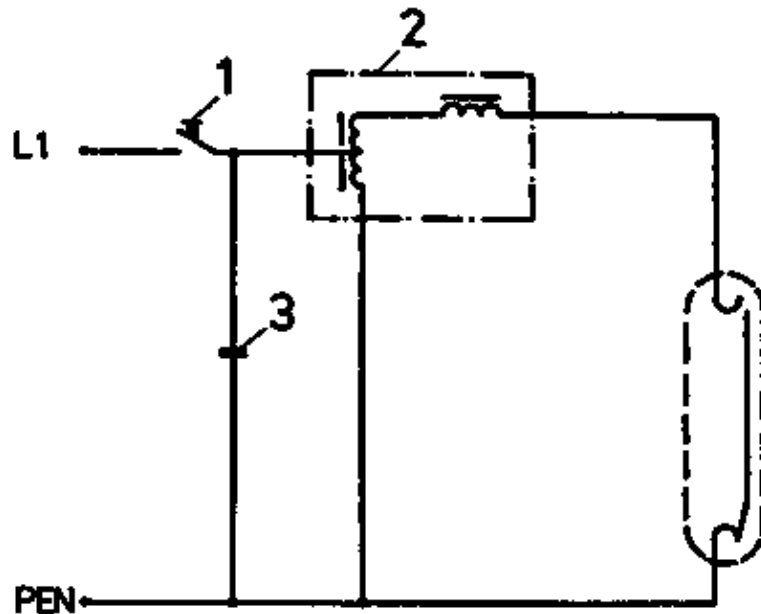

Figure 29. Rapid switching of fluorescent lamps

1 switch, 2 series reactor, 3 compensation capacitor

In addition to these commonly used connections, the below mentioned connection is used:

– Twin-lamp circuit

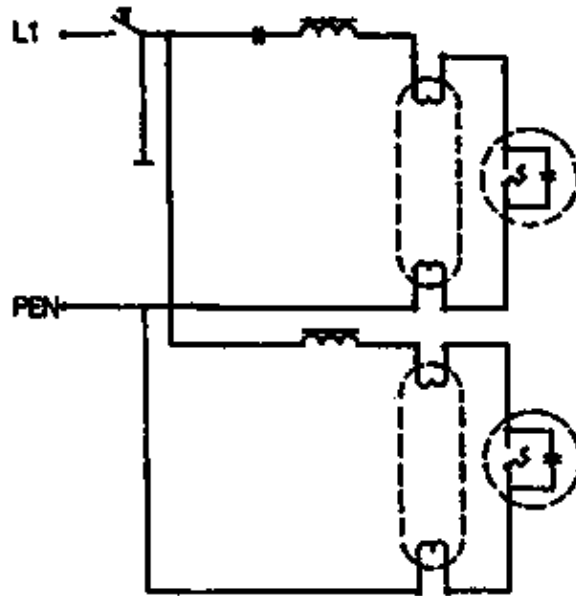

Figure 30. Dual lamp circuit of fluorescent lamps

5.3.1.2. Sodium Vapour Lamps

Low-pressure sodium vapour lamps, at the time being, have the greatest light efficiency: 183 lm/W. The light efficiency of these lamps is bound to a certain discharge temperature (therefore, a heat reflecting protective glass is used which keeps the discharge tube at a favourable temperature).

The light is monochromatic yellow, so that no colour seeing is possible. The body colours appear only as shades of grey. Low-pressure sodium vapour lamps are used in special fields of outdoor lighting such as:

- express motor roads, trunkroads, crossings, tunnels, waterways, docks and wharves,
- protection of buildings and/or sites.

Special advantages:

- Best possible penetration of fog and smoke
- Long useful burning life

Shape:

- Tube Base:
- BY 22

Power and efficiency:

- Electrical 35, 55, 90, 135 and 180 w
- Light 4800, 8000, 13500, 22500 and 33000 lm

Table 18 Supra-national comparison of sodium vapour lamps (arranged according to their rated lamp power and luminous flux)

Power (W)	Voltage (V)	Luminous flux (lm)	Lamp base	Producer country		
				Hungary	FRG	GDR
35	120	2250	E26	x		
50	220	3300	E27		x	
50	220	3700	E27			x

50	120	4000	E26	x		
54	220	4000	E27		x	
70	220	5800	E27		x	
70	220	6000	E27			x
70	120	6300	E26	x		
72	220	6500	E27		x	
100	120	9500	E26	x		
100	220	10000	E40		x	
112	220	10500	E27		x	
150	220	15000	E40			x
150	120/220	16000	E26/E40	x		
150	220	16000	E40		x	
210	220	18000	E40		x	
250	220	21000	E40	x		
250	220	25000	E40		x	
250	220	27000	E40			x
350	220	43500	E40		x	
392	220	47000	E40		x	
400	220	38000	E40	x		
400	220	47000	E40		x	
400	220	48000	E40			x
960	220	125000	E40		x	
1000	220	120000	E40		x	

5.3.2. High-Pressure Lamps

This group includes high-pressure mercury vapour lamps, halogen metal-vapour lamps, and high-pressure sodium vapour lamps.

5.3.2.1. Mercury-Vapour Lamps

High-pressure mercury vapour lamps thanks to their specific advantages have become the preferred kind of lamps for outdoor lighting. The permanent improvement in the quality of colour rendition and the advantages of a great luminous flux per lamp unit contributed to the introduction of these lamps also into many fields of indoor lighting.

The light efficiency of high-pressure mercury vapour lamps is between 40 and 60 lm/W.

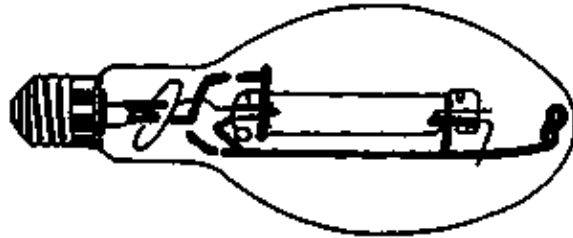

Figure 31. High-pressure mercury lamp

Construction

- Exterior glass bulb ellipsoid or fungiform transparent or inside-coated with or without reflecting layer
- Internal quartz bulb (also called burner) with sealed-in electrodes and auxiliary electrodes

- Base

E 27/30; E 40/45

- Burner

The burner together with the ignition resistors is suspended in a holding element in the exterior bulb.

The space between the burner and the exterior bulb is air-thinned.

Way of acting

If and when an operating voltage is applied, a glow discharge takes place between the auxiliary and main electrodes which results in the development of heat. The heat leads to the evaporation of the quantity of mercury which is situated in the burner as well as to an increase in pressure in the burner in general. The ignition resistors – see circuits – limit the ignition current. The evaporated mercury renders the entire internal space of the burner conductive. A discharge between the main electrodes takes place. Heat and pressure continue to grow up to the point when the mercury vapour settles as a metallic deposit on the internal side of the burner. The discharge arc between the two main electrodes stands now and is stable. The light produced by it leaves the burner with a great proportion of UV. The external glass bulb filters the detrimental ultraviolet radiation and – by means of its internally deposited fluorescent coating transfers the radiation of the burner into visible light. The air-thinned internal space of the lamp keeps the operating temperature nearly constant.

In case of an interruption of current the lamp goes out until the internal pressure of the burner on the basis of the mercury deposited on the internal wall of the burner allows a new evaporation. The ignition process starts again. The initially great starting current is limited on the one hand by the ballast and on the other hand by the increasing burner resistance. After approximately 4 to 5 minutes the lamp has achieved its nominal values and an operating pressure of approximately 8 to 10 at in the burner.

Circuit

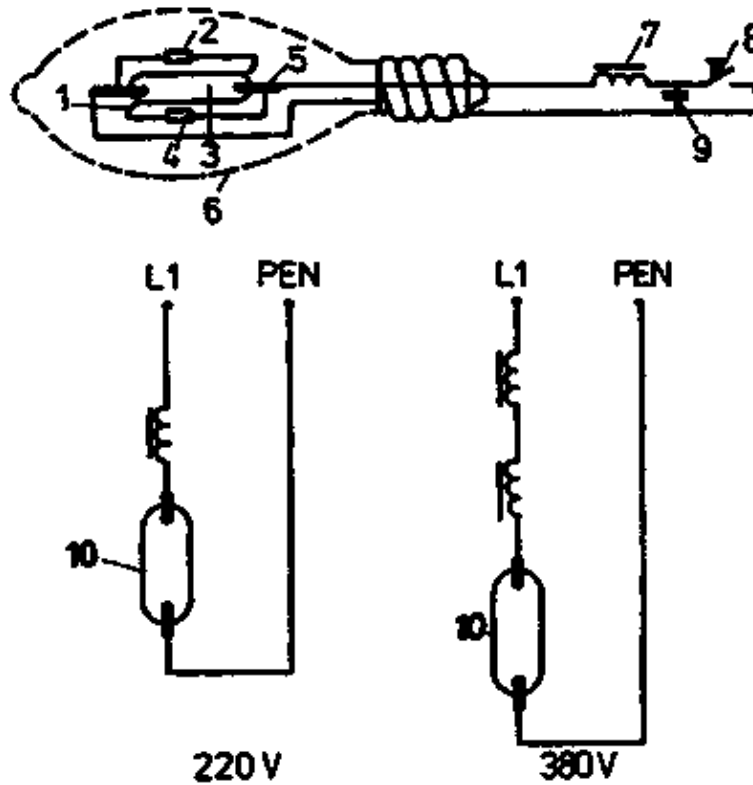

Figure 32. Circuit of the high-pressure mercury lamp

- 1 secondary electrode,
- 2,4 ignition resistor,
- 3 burner, 5 main electrode,
- 6 external bulb, 7 series reactor, 8 switch,
- 9 compensation capacitor,
- 10 lamp

Hints to practice

The burner position is any you like. The lamp parameters, however, apply to the burner position 'vertical' (base on top). With horizontal position only 97% of the luminous flux are achieved. The lamp is nearly independent of ambient temperatures and therefore is ideal for open-air installation. The lamp life is between 5000 and 10.000 hours.

Table 19 Supra-national comparison of high-pressure mercury vapour lamps (arranged according to their rated lamp power and luminous flux)

Power (W)	Luminous flux (lm)	Lamp base	Producer country		
			GDR	FRG	Poland
50	1800	E 27	x		
50	2000	E 27		x	
80	3400	E 27	x		
80	4000	E 27		x	
125	5300	E 27			x
125	6000	E 27	x		
125	6500	E 27		x	
250	11500	E 40			x

250	13000	E 40	x		
250	14000	E 40		x	
400	20000	E 40			x
400	23000	E 40	x		
400	24000	E 40		x	
700	36000	E 40			x
700	40000	E 40		x	
700	42000	E 40	x		
1000	52000	E 40			x
1000	57000	E 40	x		
1000	58000	E 40		x	
2000	125000	E 40		x	

Clear-glass bulb lamps are used for copying machines (helio-graphic printing).

For outdoor lighting, high-pressure reflecting lamps are used. In indoor lighting, lamps with elliptic bulbs with oxidic internal reflector are used. The coating of the external bulb can have different colour variants.

Special attention has to be paid that high-pressure mercury lamps in no case are operated without external bulb, that is to say the burner alone. The UV-light which leaves the burner destroys the retina of the human eye.

In fields where a light failure of several minutes may cause an accident equal filament lamps have to be installed in addition to the high-pressure mercury vapour lamps (mixed light). The lamp should be suspended at such height that dazzling by direct light incidence is avoided.

The high-pressure mercury vapour lamps must be compensated because of their inductive power.

When several lamps are used attention has to be paid to a symmetrical network distribution.

Compensation capacitors are assigned as follows:

50 W	:	7 microfarad/220 V
80 W	:	3 microfarad/220 V
125 W	:	10 microfarad/220 V
250 W	:	18 microfarad/220 V
400 W	:	25 microfarad/220 V
700 W	:	40 microfarad/220 V
1000 W	:	50 microfarad/220 V
2000 W	:	50 microfarad/220 V

5.3.2.2. Halogen Metal Vapour Lamps

Halogen metal vapour lamps, by their great light efficiency of 75 to 90 lm/i/V, the great luminous flux concentration and good colour rendition, are of increasing importance in lighting engineering in the fields of colour television and colour film.

Table 20 Supra-national comparison of halogen metal vapour lamps (arranged according to their rated lamp power)

Power	Luminous flux (lm)	Lamp base	Producer country		
			FRG	GDR	Hungary
75	5200	G 12	x		
100	6300	E 27		x	
150	12000	G 12	x		
175	12600	E 40		x	
245	17000	E 40	x		
250	19000	E 40		x	
250	20000	Fc 2	x		
380	32000	E 40			x
390	31500	E 40	x		
400	32000	E 40		x	
965	81000	E 40	x		
1000	90000	E 40		x	
1900	180000				x
1900	183000	E 40	x		
1960	189000	E 40	x		
2000	210000				x

Construction

The structure of halogen metal vapour lamps, in its essence, is similar to that of the high-pressure mercury vapour lamps. The lamps have a tube-shaped or elliptic clear-glass external bulb.



Figure 33. Halogen metal vapour lamp

Some kinds of these lamps have a layer of luminescent material which, among others, serves to adapt the luminance and light distribution to that of the high-pressure mercury vapour lamps. By admixing certain additional luminescent materials to the high-pressure mercury discharge in the form of metallic halides the gaps in the mercury spectrum are filled, which explains the great light efficiency and good colour rendition of these lamps. Admixtures are – according to the respective type of lamp – iodides of sodium (Ma), thallium (Tl), indium (In) and lithium (Li).

Halogen metal vapour lamps are characterized by a very adaptable spectrum. Among others, for example, lamps can be manufactured emitting radiation only in the green or blue colour ranges.

Way of acting

Halogen metal vapour lamps need approximately 2 to 3 minutes till they achieve their electrical and technical characteristic values. The restarting time is about 10 to 15 minutes. In view of the restarting time of 10 to 15 minutes, it is recommendable to operate the lamps through time–delayed relays. These relays disconnect the operating voltage in the case of short voltage failure which extinguishes the lamp and reconnect it only after the time mentioned. This preserves the ignition mechanism.

Circuit

Halogen metal vapour lamps are operated by alternating current voltage of 220 V for lamps up to 400 W and by 380 V for lamps from 1000 to 2000 W at a voltage tolerance of 5%. With colour film or colour television shooting the tolerance of ± 10 V should not be exceeded in order to keep up the quality of colours. In addition to the ballast, an ignition is required to start the discharge. For this purpose, starter ignition sets as well as a thyristor ignition set are used.

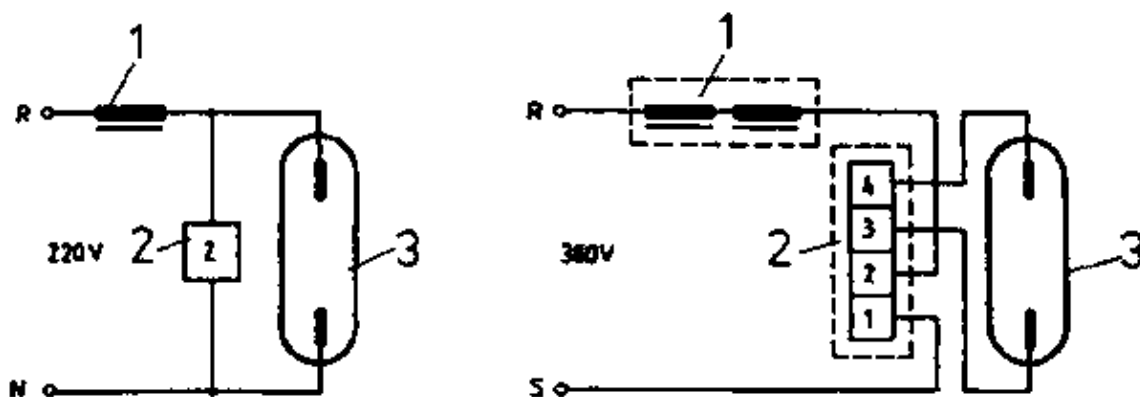

Figure 34. Circuit of halogen metal vapour lamps

1 series reactor, 2 ignition set, 3 lamp

Hints to practice

The burner position of the lamp is any you like. An exception is only the horizontal position with a deviation from position of maximally $\pm 2\%$.

The luminous flux is independent from the ambient temperature. Lamps for vertical position of use have approximately 5% greater luminous fluxes. Changes in network voltage cause colour changes of the lamp, for instance, undervoltages tend to the blue–green range of colour, overvoltages to the yellow–orange one.

That means that the colour temperature changes!

The service life is between 1000 and 6000 hours, according to the type of lamp.

Compensation capacitors are assigned as follows:

175 W	:	18	microfarad/220 V
250 W	:	18	microfarad/220 V
400 W	:	25	microfarad/220 V
1000 W	:	30	microfarad/380 V
2000 W	:	50	microfarad/380 V

5.3.2.3. Sodium Vapour Lamps

High-pressure sodium vapour lamps have gained international importance within a relatively short time. Mainly, this is the result of the great light efficiency values compared with other high-pressure discharge lamps – with some types it is more than 100 lm/W. Taking the respective conditions of use into consideration, very economical lighting solutions can be found with the help of these lamps. For example, the luminous flux of a high-pressure sodium vapour lamp of 250 W is equal to that of a high-pressure mercury vapour lamp of 400 W.

Another advantage in addition to the great light efficiency consists in the little decrease of the luminous flux in the course of the lamp life.

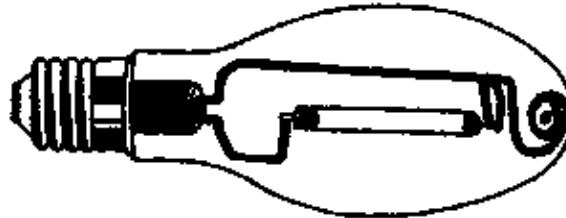

Figure 35. High-pressure sodium vapour lamp

Construction

– External glass bulb	Ellipsoid-shaped clear or coated
– Polycrystalline alumina discharge enclosure	It contains sodium, mercury and a noble gas filling.
– Interspace between external bulb and discharge enclosure	Is air-rarsfied.
– Base	E 40

Way of acting

The starting time is 4 to 5 minutes. Reignition is possible after 1 minute already.

This lamps needs a series reactor and a starting set for being started.

After application of the network voltage, the starting set gives ignition pulses to the discharge enclosure (approximately 1500 V). After ignition, a bimetal switches a the starting set off. In the discharge enclosure, the temperature rises to 1200 degrees centigrade and a pressure develops of approximately 13000 Pa. The most similar colour temperature is 2100 K.

Circuits

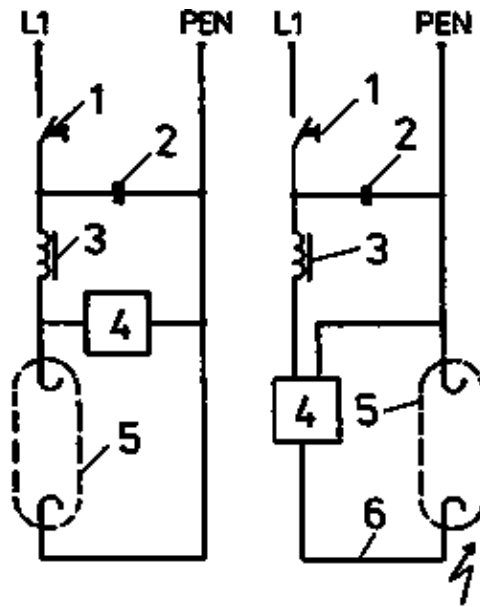

Figure 36. Circuit of high-pressure sodium vapour lamps

1 switch, 2 compensation capacitor, 3 series reactor, 4 ignition set, 5 lamp, 6 ignition lead

Hints to practice

This lamp should be used as follows:

- Street lighting
- Building floodlighting
- Lighting of pedestrian crossings and car parks
- Port installations
- Container stations
- Railway trackages
- Large building sites
- Open-air industrial areas
- Sports fields.

In the field of indoor lighting, this lamp can be used for foundries, cement works, storing and assembly halls. The lamp must be compensated. The following values are recommended:

175 W	:	25 microfarad/220 V
250 W	:	33 microfarad/220 V
400 W	:	50 microfarad/220 V

The service life amounts to approximately 8000 hours.

The burning position is any you like. The luminous flux depends on the ambient temperature.

Questions for repetition and knowledge tests

1. How are the light sources categorized?
2. What forms, diameters and performances do low-pressure fluorescent lamps have?
3. How can fluorescent lamps be started?
4. What are the most commonly used lamp circuits?

5. What are the tasks of the series reactor?
6. What are the advantages of the low–pressure sodium vapour lamp?
7. What is the structure of the high–pressure mercury vapour lamp? (The structure has to be described from inside outwards.)
8. What are the advantages and disadvantages of a high–pressure mercury vapour lamp?
9. If the light emitted by a metal–vapour halogen lamp tends much to the blue–green range, this is traceable to a technical mistake. Name the mistake!
10. Describe the structure of a high–pressure sodium vapour lamp from inside outwards.

6. Operating Components for Discharge Lamps

6.1. Ballast

With discharge lamps, the appropriately dimensioned ballast is an important precondition for the achievement of the lamp life. If a ballast is used which does not correspond to the respective lamp, the lamp parameters may not be achieved and the service life of the lamp may be reduced.

The ballast must have sufficient temperature conditions for the case of use they are meant for. These are printed on the ballast. For example: 105/55/140.

The meaning of these numbers is in succession: Winding limiting temperature in degree centigrade, winding overtemperature in degree Kelvin in normal and anomalous operation. In normal operating conditions, ballasts in permanent operation with the winding limiting temperature have a service life of 10 years. If the ballasts are operated in anomalous conditions, at the limit of the then occurring winding overtemperature, their service life expires after 20 days. Towards the end of the service life, the ballasts fail due to break, interturn short–circuits or body contact. With this, very high temperatures may occur on the contact surfaces.

In the case of anomalous operation – for instance with preheating of the lamp electrodes – and with 110% of the rated voltage for ballasts for lamps up to 400 W, the maximally occurring current is limited to the 2.1–fold value of the rated lamp current with lamps of greater power to the 2.2–fold value of the rated lamp current.

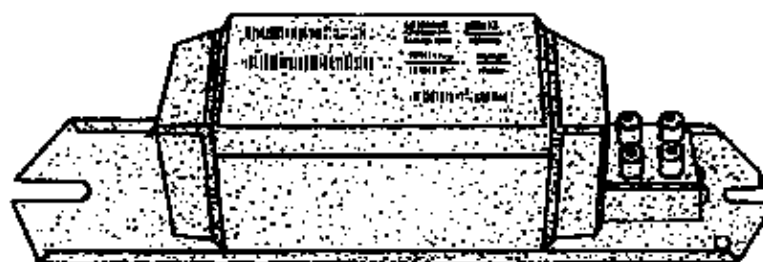

Figure 37. Series reactor for fluorescent lamps

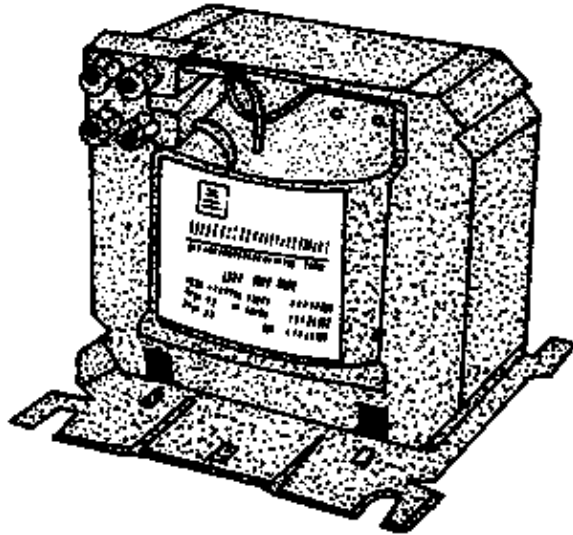

Figure 38. Series reactor for high–pressure mercury vapour lamps and halogen metal vapour lamps

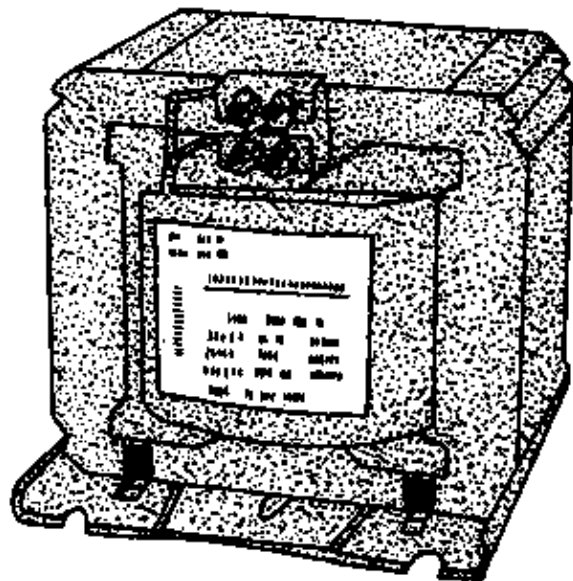

Figure 39. Series reactor for high–pressure sodium vapour lamps

6.2. Starter Switches

Starters consisting of the major components of glow starter and capacitor are in important operating means of fluorescent lamps and recently in special designs have also been used as starters for ignition sets.

The prolonged first make time for instance of the St 1 glow starter for fluorescent lamps is within the range of 0.45 to 2 s; with most starters it is 1 s on an average. The maximum voltage produced is more than 400 V, the test service life 6000 (number of switchings).

For tandem operation of fluorescent lamps of 20 W special starter switches are required.

For starter ignition sets of high–pressure discharge lamps a special glow starter without capacitor is used.

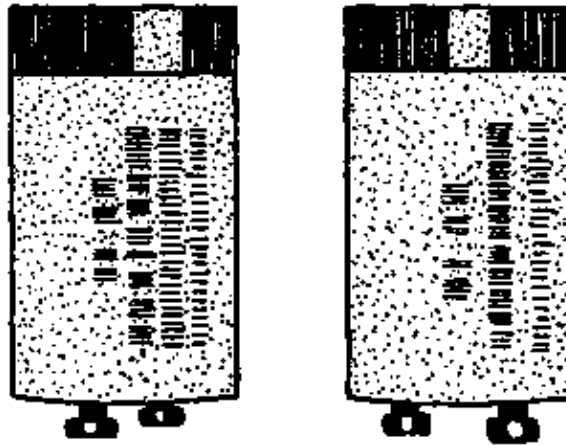

Figure 40. Starter for fluorescent lamps

6.3. Ignition Sets

Halogen metal vapour lamps and high-pressure sodium vapour lamps need ignition sets for starting the discharge. Two different types of sets are available for the user – the starter ignition sets and the thyristor ignition sets.

Starter ignition sets, in their essence, consist of a special glow starter with a current-limiting capacitor and, perhaps, a protective resistor connected in series, by which – including the inductivity of the ballast – the required glitches from 1.5 to 2.5 kV are generated in the form of irregular pulses. Starter ignition sets are very economical as to the price; they meet the requirements of the IP54 protective system and can be placed at a distance from the lamp.

After ignition of the lamp there is no internal consumption. As a wearing part the starter is considered as disadvantageous its replacement requiring much maintenance work.

The thyristor ignition set is an electronic heterodyne ignition set and consists of various semiconductor elements as well as of a pulse transformer. The primary voltage of the pulse transformer is switched by a thyristor controlled by a diac.

The high-voltage pulses of approximately 4.5 kV and a natural frequency of 100 kHz which develop at the secondary winding of this transformer are superimposed on the network voltage near the maximum of the positive half-wave. Ballast and secondary winding of the pulse transformer are connected in series with the lamp, i.e. the lamp current flows over the secondary winding which is designed for a continuous current load of 4.4 A. From this results the power loss of the ignition set of maximally 4 W with the lamp burning. The high tension is led out by an ignition wire which has to be connected with the contact plate of the socket. The short ignition wire conditional on the set requires the ignition set to be arranged near the socket of the lamp. After having ignited the lamp the ignition set gives no further high-voltage pulses; however, it continues to work if and when the lamp is defective or the lighting outlet is unoccupied (continuous ignition).

6.4. Compensating Capacitors

The current limitation by inductive ballasts with discharge lamps causes a power factor of 0.4 to 0.7 according to the type of lamp; the average is 0.5 approximately. The use of suitable capacitors enables an improvement in the power factor – about 0.85. MP-compensating capacitors (parallel capacitors) of 2 to 40 microfarad as well as motor and power capacitors are used. Furthermore, it is distinguished between single power-factor compensation, group power-factor compensation in alternating current installations and three-phase current installations and central power-factor compensation. The last mentioned kind of compensation considers all inductive consumers of the entire generating plant by a battery of capacitors based on an automatic control by connecting and disconnecting individual capacitors depending on the power factor measured. The capacity values of single compensation are to be found in the respective tables.

Compensation capacitors are connected in parallel to the network and must be disconnectable together with the entire installation. If a number of single capacitors are used in order to achieve the total capacity, these must be connected in parallel.

6.5. Intensity Control of Lamps

With all-purpose lamps intensity control can easily be realized. By a voltage dip of only 30%, a luminous flux value of 1% can be achieved. This is done by using series resistors or – more economically – by adjustable transformers. Modern electrical small devices on thyristor basis are known as dimmers. With fluorescent lamps, due to the falling characteristic of the current–voltage–dependence and the required high reignition voltage, an intensity control by reducing the voltage (amplitude control) is not possible.

Here, the principle of phase–shifting control is applied, i.e. the lamp current and thus the luminous flux are changed in a wide range both half–waves being used. The best control behaviour is shown by rod–shaped fluorescent lamps of 40 w, which must be equipped with an ignition aid in the form of an earthed starting strip or a closely spaced ignition grid. In addition to the ballast, each lamp needs a heating transformer with two separate secondary windings for preheating the lamp electrodes. The heating transformer, for instance 220 V/2 × 6.3 V, 10 VA and the device for the phase–shifting control must always be connected to the same external conductor. Because of the low preheating voltage of about 6 V, attention has to be paid that the lamp sockets give faultless contacts. In order to improve the quality of control, an ohmic base load has to be connected to the load exit of the device according to the instructions of the manufacturer (e.g. filament lamps 25 W).

To one light–controlling device, several lamps can be connected according to the design of the device.

The regulating proportion that can be achieved is in the range of 1:20 to 1:30; in favourable conditions a ratio of 1:100 is possible. Before using fluorescent lamps for intensity control the entire lot of lamps of one charge should be burnt in for approximately 20 hours.

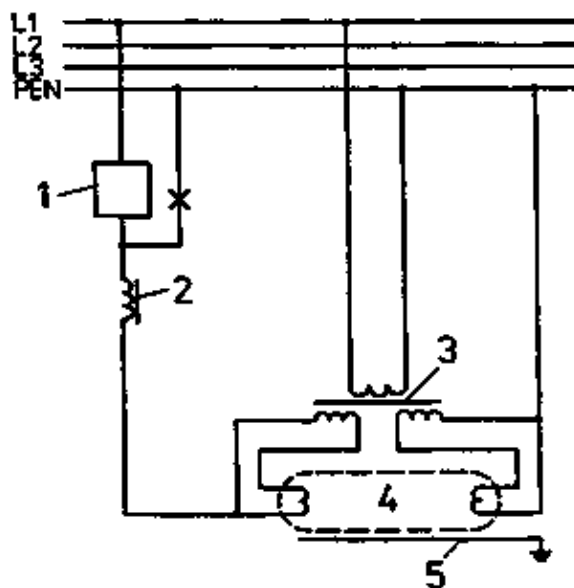

Figure 41. Intensity control of fluorescent lamps

- 1 control unit
- 2 series reactor
- 3 filament transformer
- 4 lamp
- 5 ignition strip

To high–pressure mercury vapour lamps the above mentioned methods cannot be applied, because a voltage dip of more than 15% already leads to the extinction of the lamp or to unstable operation.

Questions for repetition and knowledge tests

1. What are the distinguishing characteristics of ballasts of fluorescent lamps compared with ballasts of high-pressure mercury vapour lamps?
2. Why are compensation capacitors required for discharge lamps?

7. Comparative Tabulations of the Properties and Energy Consumption of Lamps

Lamps are not only radiation sources but also heat sources. The increasing importance of integrated illuminating installations – included in the air-conditioning and noise control measures – requires also knowledge of the energy balance of lamps. The energy balance represents the division of performance into heat of conduction and convection heat as well as the entire radiant flux (radiation power). In this context, it is of special importance how the total radiant flux splits up into the individual wavelength ranges.

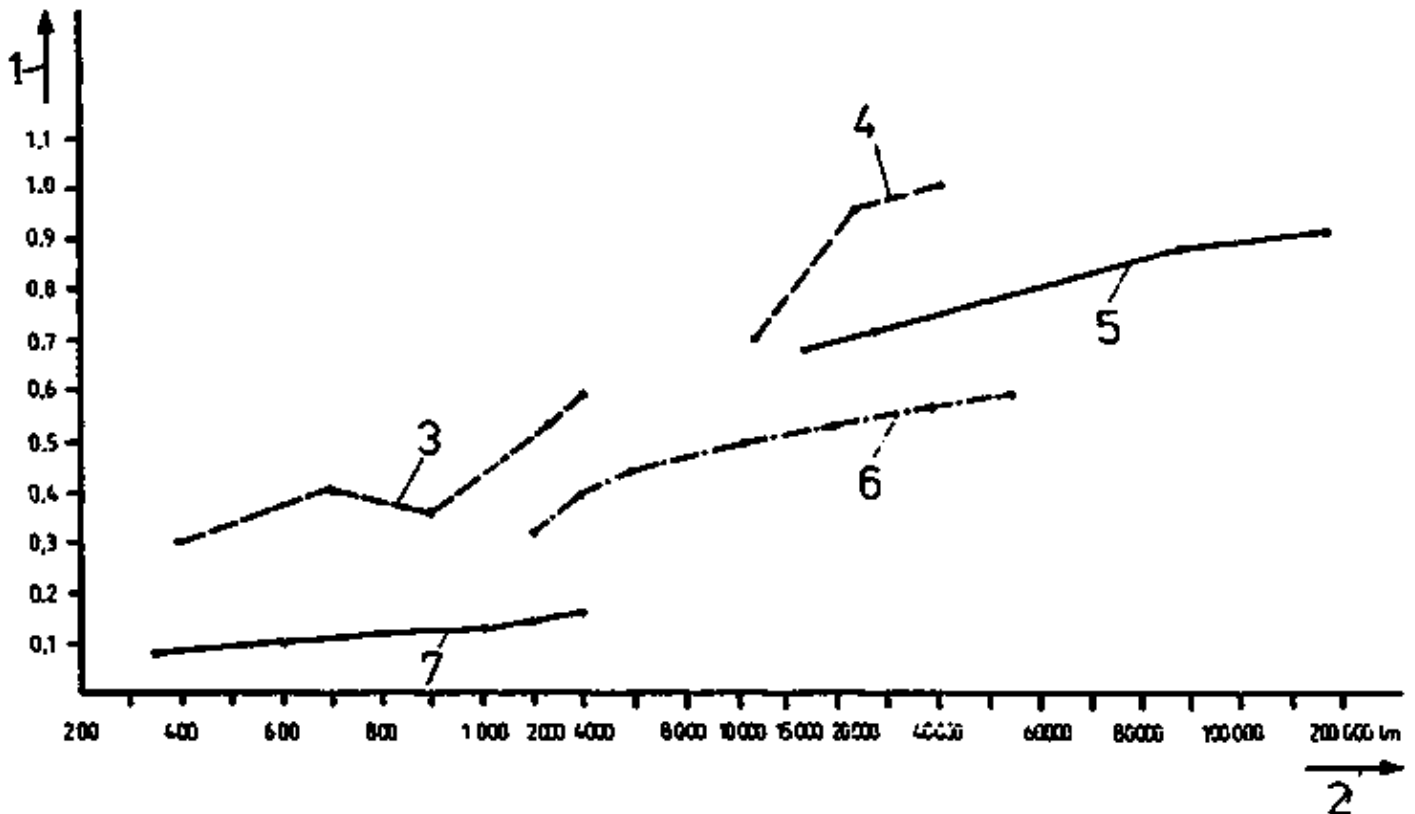

Figure 42. Comparison of light yields of discharge lamps

1 light yield ($\Phi(L)$) divided by ($\Phi(\text{total})$), 2 lamp lumens in 1m, 3 fluorescent lamps, 4 sodium vapour lamps, 5 metal vapour lamps and halogen lamps, 6 high-pressure mercury vapour lamps, 7 filament lamps of standard rating

Table 21 Comparison of light source parameters

Qualities	General service lamp	Halogen filament lamp	Fluorescent lamp	High Press, mercury vapour lamp	Halogen metal vapour lamp	High-pressure, sodium vapour lamp
Rated W power	25... 1000	1000... 2000	8... 65	50... 2000	140... 2000	175... 400
Luminous 1m flux	220... 11900	22000 44000	350... 4300	1900... 120000	12000... 180000	17500... 43000
Light 1m/W yield with	8.8... 19	20... 22	27... 56	31.5... 58	62... 86.5	72.5... 98.8

ballast						
Light colour	ww	ww	ww, nw, dw	nw	ww, nw, dw	ww
Colour rendering steps	1	1	1;2;3	2;4	2;3	3
Service h life	1000	1200	4000... 1000	5000... 12000	1000... 6000	8000
Rated V voltage	225; 240	225	220	220; 380	220	220
Tolerance % of rated voltage	-	-	+--10	+--10	+--5	+--5
Ballast	-	-	choke	choke	choke	choke
Ignition set	-	-	starter	-	ignition set	ignition set
Start-min ing time	app. 0	app. 0	>0.035	4...5	2...3	4...5
Re- min starting time	app. 0	app. 0	app. 0.016	4...5	10...15	app.

(ww warm white; nw neutral white; dw daylight white)

Table 22 Energy balance in % of a number of lamps

Lamp	Circuit convection heat	Total radiant flux	Radiant flux in various wavelength ranges (mean values)					
			UV-B-	UV-A-	visible		IR-	
			range					
			300	350	580	1090	2050	2700
General services lamp								
100 W	7	93	-	0.03	9.0	36.0	32.0	16.0
1000 W	5	95	0.005	0.06	11.9	38.2	29.2	15.6
Halogen filament lamp for floodlight								
2000 W	6	94	0.01	0.1	13.3	38.9	31.1	10.6
Fluorescent lamp								
LS40, nw20	40, approx.	60, app.	0.05	0.5	18.8	0.5	0.15	40, app.
LS65, nw20	40, approx.	60, app.	0.06	0.5	18.0	0.6	0.12	41, app.
High-pressure mercury vapour lamp with luminescent material								
400 W	25	75'	0.12	2.0	14.8	5.5	6.1	47 app.
Halogen metal vapour lamp								
400 W	20	80	0.02	2.3	20.5	8.5	6.8	42 app.
High-pressure sodium vapour lamp								
400 W	22.5	77.5	0.003	0.3	30.0	16.2	8.0	23 app.

8. Lighting Fittings

Lighting fittings are devices serving the distribution, filtering and transformation of light emitted by lamps. They included all parts necessary for fitting, protecting and operating the lamps.







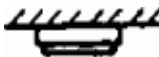
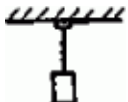

According to the effect of light it is distinguished between two main groups:

- Lighting fittings for illumination purposes
- Lighting fittings for light emission.

Within these groups, the actual subdivision is made according to the respective purposes of use. If one tried to designate all lighting fittings by these very few names, this would soon lead to difficulties of distinction.

Therefore, further subdividing of lighting fittings is made, for instance by the mode of their installation or placing.

Table 23 Classification of the lighting fittings according to the ways of fixing

Stationary fittings		
Built-in fittings 	Ceiling fittings 	Pendant lamps 
Cord-adjusted suspended fittings 	Wall fittings 	Mounting fittings 
Standing fittings 	Fittings put on top of a holding structure 	Fittings fixed by brace at a holding structure 
Mobile fittings		
Floor standard lamps 	Standard lamps 	

All lighting fittings used for illumination purposes have to meet definite requirements as to lighting engineering, design, electrotechnical and mechanical qualities. These requirements have more or less importance according to the purpose the respective lamp shall fulfill. With domestic rooms and rooms for representation, for example, demands will be made mainly on the design of a lighting fitting. Shall the lighting fittings contribute to the interior decoration of a room, this is to say they shall be included in the architecture, demands of illumination engineering should rank first. With working lighting fittings, technical requirements are decisive and the design is subordinated to them. The term of working lighting fittings is not standardized, neither nationally nor internationally. However, it is used in this textbook for better distinction from domestic lighting fittings and those for representation purposes.

8.1. Protection Classes

The protective class of a lighting fitting indicates the protective measures or the integration into the protective measures against hazardous contact voltage during the installation of the lighting fitting.

All lighting fittings must be constructed in accordance with the protective classes I, II or III. For external marking on the lighting fitting, the symbol \square is used for protective class II, while symbol \diamond applies to protective class III.

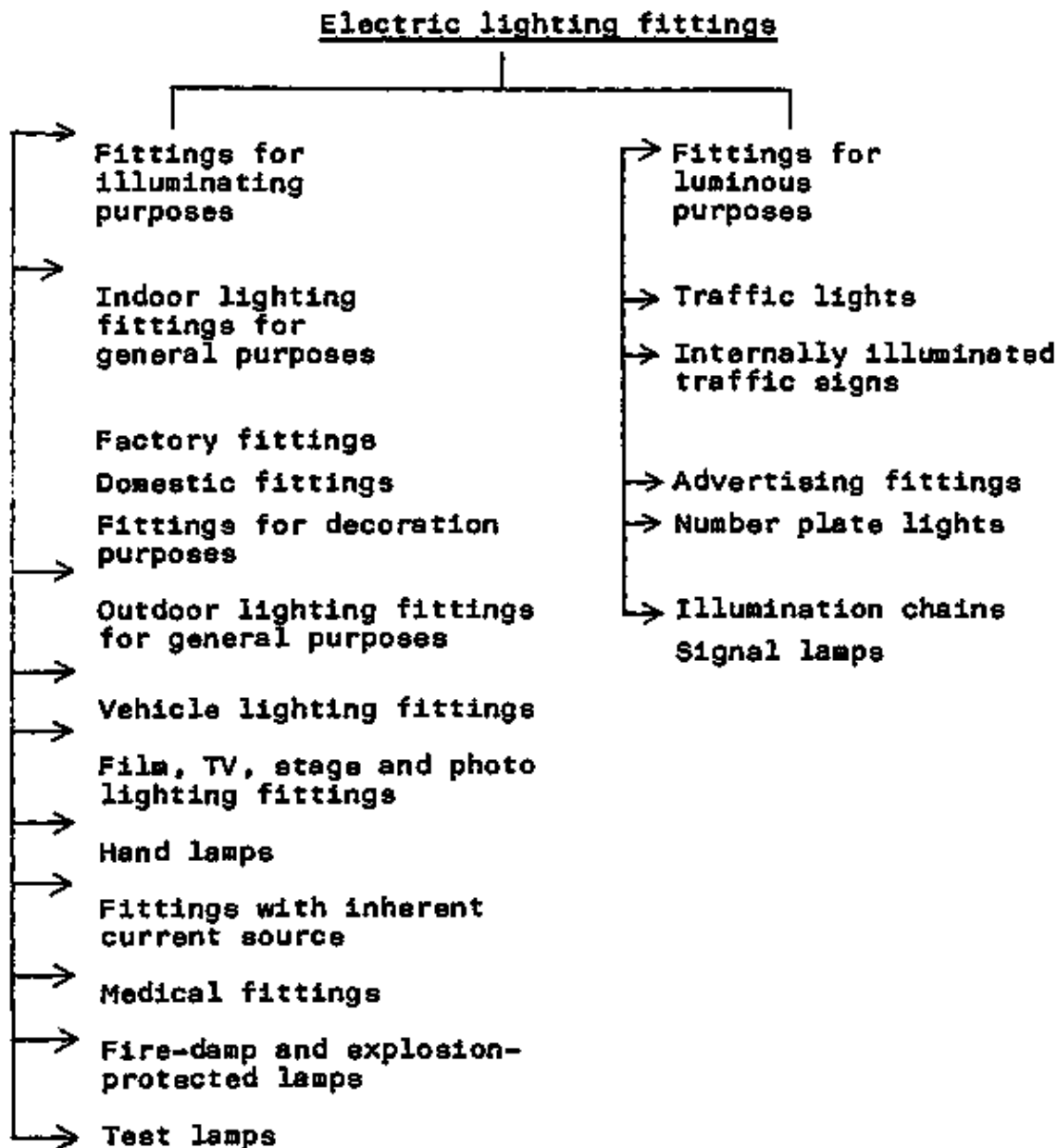

Table 24 Electric lighting fittings

There is no special marking for lighting fittings belonging to protective class I.

The international trend goes to the application of protective class II to lighting fittings that can be installed and maintained by amateurs. This concerns especially the domestic lighting fittings. But also with working lighting fittings the use of the protective insulation leads to greater safety and, with some installations, even to material savings.

The protection classes mean:

Table 25 Degrees of protection of lighting fittings

Degree of protection	Application
I	Marks a lighting fitting equipped with a protective earth-terminal in addition to the operating insulation for protection against hazardous contact voltage.
II	Marks a lighting fitting equipped with an extra insulation in addition to the operating insulation for protection against hazardous contact voltage.
III	(There is no protective-earth terminal) It marks a lighting fitting designed for connection to protection low voltage.

8.2. Degrees of Protection

The degree of protection of a lighting fitting indicates the degree of protection in one or more protective systems. The following markings are used:

- Characteristic letters IP – for the degree of protection
- 1. characteristic numbers 0 to 6 – for the protective system of 'protection against accidental contact and foreign matter'
- 2. characteristic numbers 0 to 8 – for the protective system of 'water protection'
- Additional letter P – for partial accomplishing of a protective system.

Table 26 Protective systems of lighting fittings

Prot. system	First characteristic figure		Second characteristic figure
	Protection against accidental contact	Protection against foreign matters	Protection against water
IP 20	against finger contact	against penetration of solid foreign bodies of a diameter ≥ 12.5 mm	no protection against water
IP 21			protection against harmful effects of vertically falling water drops in horizontal position of use of the test piece
IP 22			protection against harmful effects of vertically falling water drops also with an inclined position of the test piece by ± 15 degrees from the horizontal position of use in two planes vertical to each other
IP 23			protection against the harmful effect of water in the form of rain falling in from all sides at an angle of 60 degrees compared with the vertical
IP 40	against contact with tools	against penetration of foreign bodies of a diameter $\geq 1,0$ mm	see IP 20
IP 43			see IP 23
IP 44			protection against the harmful effects of splash from any direction
IP 50	complete protection against	against detrimental deposition of dust	see IP 20

	accidental contact	inside	
IP 54			see IP 44
IP 55			Protection against the harmful effects of water jets (hose-proof) from any direction
IP5p4		partial protection against deposition of dust	see IP 44
IP 65		against penetration of dust	see IP 55
IP 67			protection against harmful effects of water in case of overflowing in constant pressure and time conditions
IP 68			protection against penetration of water with temporally unlimited overflowing and definite pressure

Not all possible combinations are used in connection with lighting fittings. A selection can be made including the degrees of protection of the most commonly used lighting fittings.

The degree of protection of a lighting fitting is determined by the various operation conditions and the local conditions resulting from the use of the lighting fittings in differently endangered rooms. All lighting fittings are marked as to their respective degree of protection in documentations, device descriptions and on their rating plates.

8.3. Efficiency of a Fitting

The efficiency of a lighting fitting (operating efficiency of a lighting fitting) is the coefficient which indicates to what extent the luminous flux of the lighting fitting operated in the respective ambient temperature results from the luminous flux of the lamps placed in the lighting fitting.

Table 27 Minimum light output ratios of a number of commonly used lighting fittings

Type of reflector	Type of covering	Minimum efficiency
Fittings for filament lamps, high-pressure mercury vapour lamps, halogen metal vapour lamps and high-pressure sodium vapour lamps with a glare protection angle of 15...30°		
mirror	without covering	0.65
reflector	with clear glass covering	0.60
diffuse	without covering	0.65
reflector	with clear glass covering	0.60
	with opaque covering or spill shield	0.55
without reflector	with opaque covering	0.70
Fittings for fluorescent lamps with a glare protection angle of 15... 30° across the longitudinal axis of the fitting		
Diffuse reflector	without covering	0.60
	with clear glass covering	0.55
	with opaque covering or spill shield	0.50

Without reflector	without covering (no glare protection angle)	0.90
	with clear glass covering (no glare protection angle)	0.80
	with opaque covering or spill shield	0.65

8.4. Kinds of Lighting Fittings

In lighting engineering, application of lighting fittings for indoor and outdoor lighting as well as domestic lighting fittings and those for purposes of representation are of the greatest importance. By similar parameters such as equipment, fixing, degree of protection and field of application it is possible to categorize these lighting fittings under certain groups and to describe them. In order to make the text more instructive, pictures of the lighting fittings are inserted which represent only a small part of the extensive range of lighting fittings manufactured by industry and which can be considered as good solutions of construction.

Lighting fittings for special purposes such as vehicle lighting fittings, lighting fittings with own current source, lighting fittings for medical purposes, and those for photo and film shooting as well as for television are not treated.

8.4.1. Functional Lighting Fittings for Indoor Lighting

8.4.1.1. General Lighting Fittings

Lighting fittings the construction of which is such that they – after suitable arrangement – fully illuminate a room are called general lighting fittings. In industrial and social buildings many rooms are illuminated by these lighting fittings. Consequently, there is a very wide range of such fittings. It includes fittings for fluorescent lamps, high–pressure mercury vapour lamps, halogen metal vapour lamps and filament lamps with the protective systems of IP 20 to IP 67 and the degrees of protection I and II. Also the light–technical characteristic values are very diversified and specific according to the respective lighting tasks resulting from the technological process. All the lighting fittings stand out for high characteristic values as to lighting engineering, which are the basis of economical lighting installations.

The following lighting fittings are used to solve the tasks of general lighting:

Lighting fittings with fluorescent lamps for dry rooms

A universally applicable illuminator system for any kind of dry rooms is the combinational illuminator system structured according to the unit principle. Basic body is a trapeziform case that accommodates all electrical construction elements. It is manufactured internationally according to almost similar construction principles and is suited for the equipment with fluorescent lamps of 20, 40 and 65 watt.

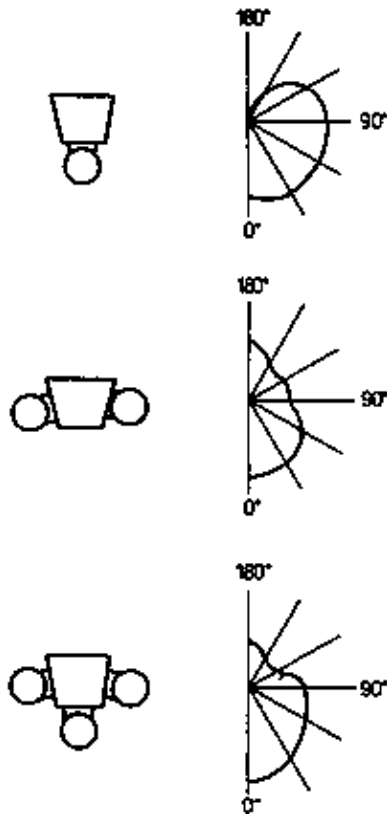

Figure 43. Combination fitting, open

With the help of a similar basic element lighting fittings are realized with 1, 2 and 3 lamps.

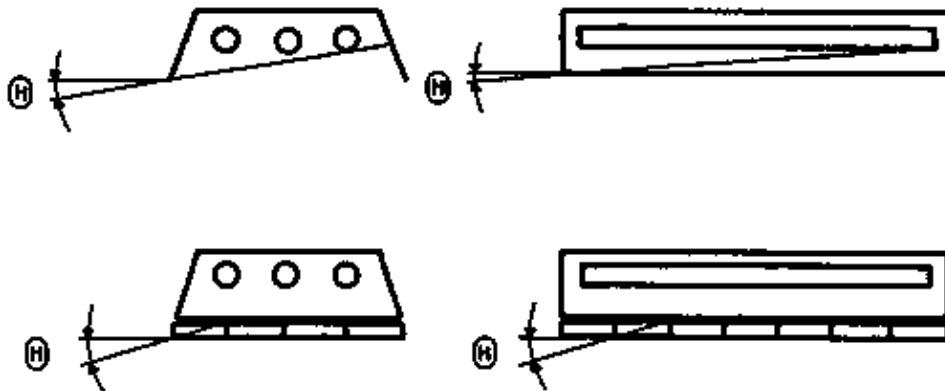

Figure 44. Glare protection angle

By various glare protection shields which are fixed on the basic body a wide range of illuminators can be produced.

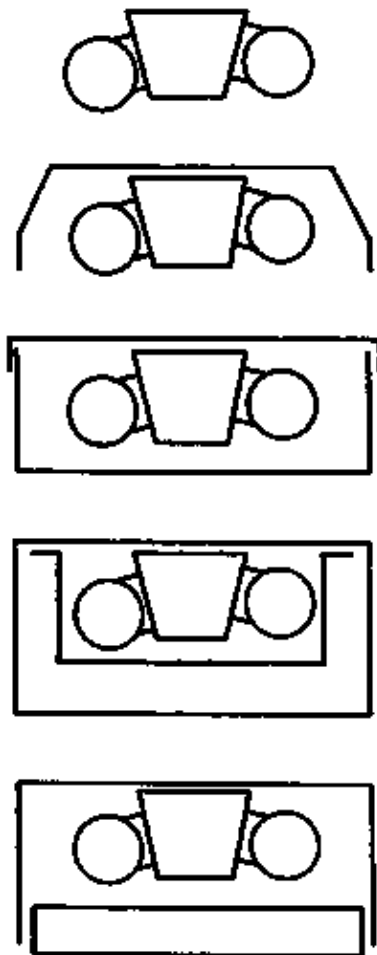

Figure 45. Combination fitting with various glare protection shields

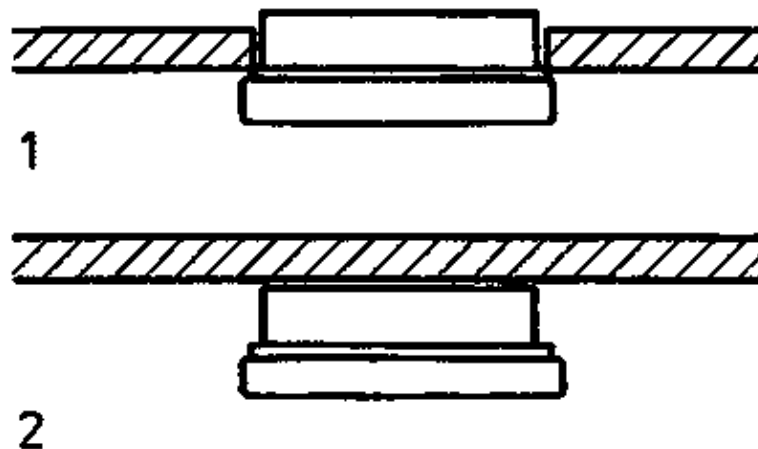

Figure 46. Surface fittings

- 1 for panel mounting in the ceiling
- 2 for surface mounting on the ceiling

The diversified use of the lighting fittings is still enlarged by the different modes of suspension such as ceiling fittings and pendant fittings as well as individual and Christmas-tree pattern arrangements.

Another system of lighting fittings for dry rooms are the so called surface illuminators. These are lighting fittings, which due to their good design and the type of fixing as ceiling-mounted or built-in ceiling illuminators and due to their light-technical characteristic values are used mainly in social buildings and in rooms for representation purposes. As to the design, there are rectangular and square illuminators equipped with spill shields or plastic covering. (See again Fig. 43).

They are equipped with fluorescent lamps. As a result of the cosine-shaped light distribution, a nearly even distribution of illumination can be achieved by a corresponding arrangement of the lighting fittings.

Environmental lighting fittings

The adverse effects of artificial lighting, especially the development of heat with high illumination intensity, shall be reduced or avoided by temperature-controlled lighting fittings. The environmental lighting fittings offered by the manufacturers for fluorescent lamps and filament lamps are mainly integrated in the outgoing-air circle of the air-conditioning system. By this, the following major advantages are achieved:

- Better ambient temperatures are created within the illuminator; thus, optimal values of the luminous flux of the fluorescent lamps are achieved.
- The heat generated by the lamps is partially led out immediately. This leads to less heat in the room.
- The technical elements are less contaminated.
- The combination of lighting and air-conditioning enables a better utilization of the ceiling surface.

Environmental lighting fittings are manufactured mainly as built-in illuminators. These lighting fittings are built in according to three construction principles:

- Lighting fittings with forced air cooling of the lamp
- Lighting fittings cooled by circulating air
- Ventilated lighting fittings.

In order to avoid glare, the environmental lighting fittings are covered by spill shields or plastic screens, in general. The distribution of light intensity is concentrated or at a narrow angle.

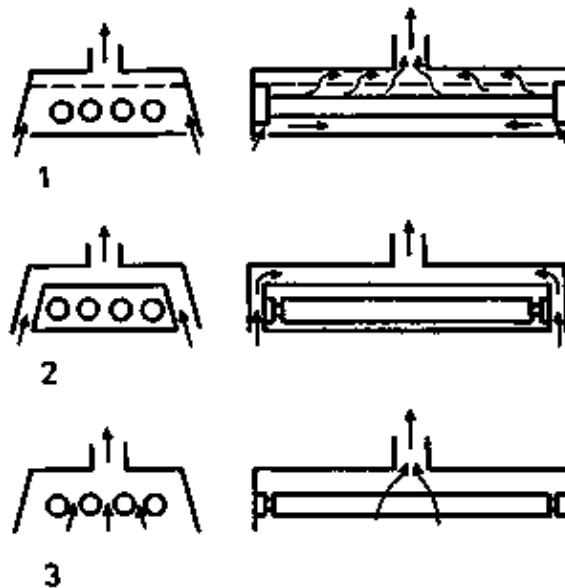

Figure 47. Air-handling fittings

- 1 fittings with forced air-cooling of the lamps,
2 air-circulated fittings, 3 ventilated fittings

Lighting fittings with fluorescent lamps for moist and dusty rooms

In low dusty and moist rooms lighting fittings are used which meet the more complicated requirements by special construction or use of special materials.

Lighting fittings for dusty rooms mostly have a triangular basic body on the inclined external surfaces of which larger quantities of dust cannot deposit. The internal space of the lighting fitting is protected against dust mainly by rubber packings, the fluorescent lamps by dust-proof lamp sockets and perhaps additionally by protective tubings.

With other versions of construction, the entire internal space of a lighting fitting including the lamps is sealed by a glass window or boat.

The protective system of IP 5x, protection against detrimental deposition of dust inside a lighting fitting, will be sufficient in nearly every case. Lighting fittings for moist rooms have no definite form of construction. Purely and simply it is important that the external materials are sufficiently resistant to the effects of moisture or aggressive vapour and that the inside materials – especially the electric parts of an illuminator – are protected against moisture by sealings.

The constructive elements mainly consist of plastic material or steel sheet with a special surface treatment. The internal parts are protected by rubber sealings and the fluorescent lamps by moisture–proof sockets and, if needed, by protective tubings additionally. In most of the cases, the protective system IP x4 – protection against detrimental effects of splash from any direction – is sufficient.

Like the combination illuminators, the moisture–proof lighting fittings, too, have a wide range of application due to their various types of fixing in the forms of ceiling mounting or pendant fittings and the possibilities of single or Christmas–tree pattern arrangement as well as by various accessories, for instance reflectors.

In order to facilitate the installation, assembly and maintenance of the lighting fittings, carrier rails are used for the installation of moisture–proof illuminators. The constructive solution of one certain protective system – protection against dust or moisture – nearly always involves the realization of both protective systems. In so far it is understandable that, for example, the most commonly used moisture–proof lighting fittings meet the requirements of dust protection, too.

For very wet rooms, waterproof illuminators are used the fluorescent lamps and electrical components of which are protected against the detrimental effects of water in the case of flooding in constant pressure and temporal conditions. These lamps are used especially in laundries, dairies, etc.

Narrow angle lighting fittings

For high rooms lighting fittings are required which have a great concentration of luminous flux and light intensity in the lower half of the room. Several narrow angle lighting fittings with various reflection materials meet these requirements, if economical discharge lamps are used.

Narrow angle lighting fittings with mirror reflector are used in rooms of more than 7 m in height.

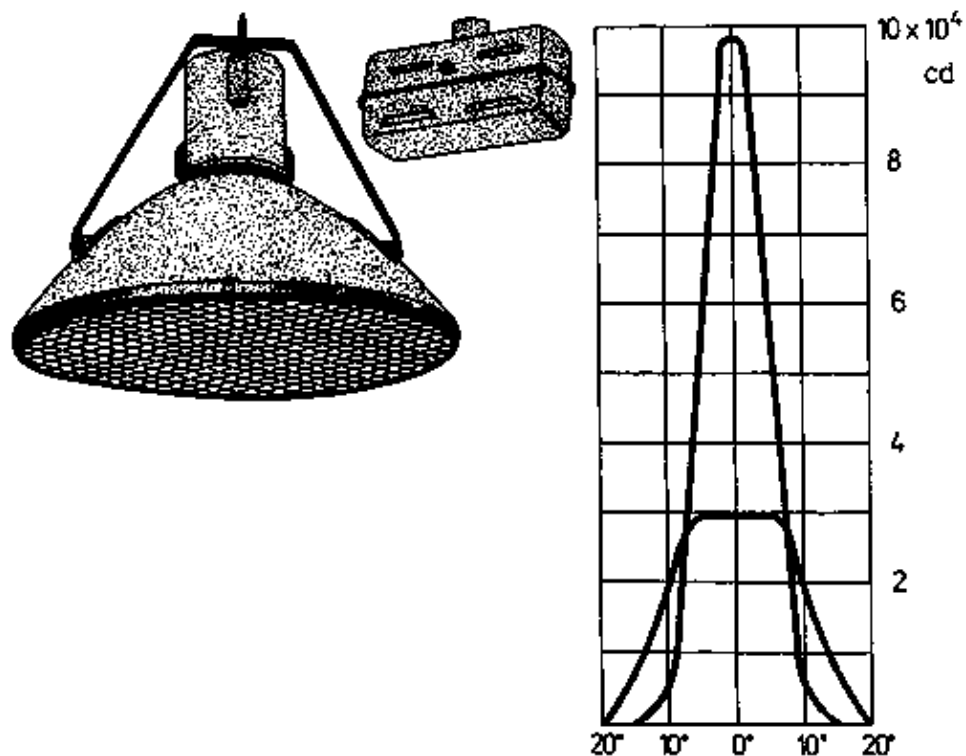

Figure 48. Narrow–angle lighting fitting for illuminating halls with light distribution curve with a light output ratio of 0.66 (halogen metal vapour lamp NC 2000–60)

The different types of equipment – high–pressure mercury vapour lamps, halogen metal vapour lamps and high–pressure sodium vapour lamps – allow a wide–range application in all branches of industry. With the help of focussing mechanisms or different reflectors various forms of light distribution can be achieved. Thus, quite a number of requirements as to lighting engineering can be met by the mentioned illuminators.

A still greater concentration per spot of light and two–phase switching can be realized by so called narrow angle twin lighting fittings. The open version of the two above mentioned narrow angle lighting fittings can be used in dry rooms, the glass–covered reflectors may also be used in rooms exposed to dust and moisture.

In addition to the above mentioned narrow angle lighting fittings there are those with a larger diameter for high–pressure mercury vapour lamps of 2000 watt or halogen metal vapour lamps of 2000 watt. As a result of suitable reflector forms and surface treatment, these illuminators have a great concentration of luminous intensity and therefore are suited to illuminate high rooms.

Narrow angle lighting fittings with enamel reflectors, due to the technical qualities – of the reflector surface – have an almost cosinusoidally radiating distribution of luminous intensity. They are mainly equipped with high–pressure mercury vapour lamps and are very well suited to evenly illuminate rooms of a medium height.

An adjustment of the lamp sockets for altering the shape of the light distribution is not practised with these illuminators, because this would not be efficient due to the size of the light–emitting surfaces of the high–pressure mercury vapour lamps and their size relation to the reflector as well as its surface reflection.

Fluorescent lamp narrow angle lighting fittings which are equipped with a number of fluorescent lamps in order to achieve a great concentration of the luminous flux show a cosinusoidal light distribution curve. Their utility consists in the illumination of high rooms with a relatively good vertical illumination and a good light colour. In addition, the great number of lamps per spot of light enables three–phase switching which avoids flickering.

Wall and ceiling fittings

In some service–rooms of industrial and social buildings porcelain fittings with glass balls are equipped with filament lamps. Although such illuminators do not work very economically, they still have their right to exist, if the utilization of the mentioned rooms is considered. They are offered mainly as ceiling and wall fittings for the illumination of dry rooms or rooms exposed to moisture. They give scattered light, that is to say the light is almost equally distributed over all boundary surfaces of the room.

8.4.1.2. Local Lamps

Working places can be lighted in different ways and by lighting fittings for various purposes.

In practice, it is distinguished between three types of lighting systems each of which includes special lighting fittings:

- Working place orientated general lighting by lighting fittings for purposes of general lighting
- Working place lighting by lighting fittings for general lighting
- Working place lighting by fittings for local lamps.

All the three lighting systems have to illuminate working places of a limited extent, which requires of the lighting fittings a great concentration of the luminous flux in the lower half of the room.

This is to say that lighting fittings are used the light distribution of which is a direct or mainly direct one and which have a narrow–angle and cosinusoidally radiating concentrated light distribution. Lighting fittings for the lighting systems 1 and 2 have already been described.

The lighting–technical values achieved are only a question of the arrangement.

For the lighting system 3 special lighting fittings are required which are fixed directly on the working place near the object to be focussed. Thus, a great illumination on a comparatively small area and good shadow conditions are achieved.

For these lighting tasks the manufacturers of lighting fittings offer adjustable local lamps equipped with filament lamps or with fluorescent lamps. Starting from the same basic components, various and very different light distributions can be realized by attaching different reflectors. In addition, there are many ways of fixing the illuminators in the form of a variety of foot constructions for all double- and single-bracket joint fittings. This enables universal application. The lighting fittings can be categorized as follows:

- Double-bracket joint fittings for filament lamps or fluorescent lamps with a long working range resulting from the two tube brackets. With the help of them any area of a relatively large working surface can be lighted. In addition to the application on or at horizontal placing or mounting surfaces and on vertical mounting surfaces, special application to drawing machines is provided for.
- Single-bracket joint fittings for filament lamps or fluorescent lamps – only in the form of ceiling fittings – with short working ranges; these are mainly used as lighting fittings for machines due to their small dimensions.
- Another group of adjustable local fittings are the extending fittings for filament lamps and fluorescent lamps. They are used mainly on vertical walls and, in general, serve for lighting horizontal working surfaces in industry such as work benches and in social buildings, e.g. in offices. In stretched condition, these fittings have a long working range which is of decisive importance for the universal application of the fittings.

In addition to the above mentioned lighting fittings with lamps of 220 V, single-bracket fittings with low-voltage lamps are used. Due to their lamps and a corresponding form of reflectors, these lighting fittings have a great light intensity concentration and a narrow radiant angle.

Therefore, they are especially suitable for lighting small areas with great illumination values. The transformers required for operating these lighting fittings are placed in the foot of local table fittings or separately (with machine lighting fittings).

Besides the adjustable local lamps, there are stationary lighting fittings for a number of special working places, for example machine lighting fittings at boring mills, sewing machines and others, for other working places, portable lamps with handle, connection line and plug are available for mobile use.

8.4.1.3. Flameproof and Explosion-proof Lighting Fittings

The above described technical fittings for indoor installations cannot be used in mines or production and store rooms where there is the risk of fire-damp or explosion without additional and special measures. For these purposes, special lighting fittings are required which are named flameproof fittings and explosion-proof fittings. If both requirements are met, the term is flameproof and explosion-proof fittings. In the course of technical development, lighting fittings protected in the described way are required in some branches of industry, e.g. chemical industry, for certain technological processes. With these lighting fittings it must be guaranteed that no explosive mixtures are ignited in case of operation-dependant contact sparking or heating up of the lighting fittings.

These fittings are constructed in such way that contact making is totally enclosed, electric connections are protected against coming loose and possible heating up remains in the permissible limits. In addition, special sealings are used and the fittings are marked as to their protective systems, ignition groups and explosion classes. This is made by letters and figures which are attached to the designation of the respective lighting fittings. Their meaning is:

Protective system

To the construction of flameproof and explosion proof lighting fittings, according to their respective purpose and serviceability, the protective systems mentioned in Table 28 can be applied.

Table 28 Protective systems of lighting fittings protected against fire-damp and explosion

Protective system	Characteristic
-------------------	----------------

Pressure-resistant encapsulation	d
Increased safety	e
Oil encapsulation	o
Separate ventilation	f
Foreign air overpressure	f _ü
Inherent safety	i
Special protection	s
Sand encapsulation	q
Particle ignition breakdown protection	dz

Ignition group

Inflammable gas and vapours are categorized by ignition groups according to their ignition temperature (with fluids also with view to their flash point).

Table 29 Ignition groups of lighting fittings protected against fire-damp and explosion

Designation of the ignition group	Ignition temperature in centigrade
T 1	> 450
T 2	> 300...450
T 3	> 200...300
T 4	> 135...200
T 5	> 100...135
T 6	> 85...100

Explosion class

The categorization of inflammable gas and vapours in explosion classes is determined by the explosion pressure generated by the explosion and the ignition penetration. There are the explosion classes I IIA, IIB, IIC. The class IIC is subdivided into IICa and IICb, according to the existing gas and air mixture.

In the construction of flameproof and explosion-proof lighting fittings different construction principles are followed according to the desired field of application. Explosion-proof fittings for fluorescent lamps are known which by a uniform light distribution create good lighting values in a room and which are especially suitable for general lighting. For direct working place lighting and for rooms which are much exposed to dust explosion-proof fittings with reflectors and equipment with fluorescent lamps are more recommendable.

For safety reasons, the lighting fittings are operated by single-pin fluorescent lamps (with ignition strip) without starter. Special series reactors are required. They are integrated in the lighting fittings.

Table 30 Categorization of gases and vapours in explosion classes and ignition groups

Expl. class	Categorization of the gases in ignition groups				
	T 1	T 2	T 3	T 4	T 5
I	methane fire				
II A	damp ethane propane ammonia toluene acetone benzol (pure)	ethyl acetate n-butene n-butyl	gasoline n-hexane		

	carbon monoxide	alcohol		
II B	ethylene town gas	ethyl alcohol	acet-alde-hyde diethyl ether	
II Ca	water gas hydrogen			carbon disulphide
II Cb	acetylene			
II C all gases of the explosion classes II Ca and II Cb				

Another way to illuminate rooms exposed to the risk of explosion consists in the use of lighting fittings for filament lamps or high-pressure mercury vapour lamps. However, with the latter equipment a series reactor must be used which – being accommodated in a separate enclosure – can be combined with the lighting fitting.

All lighting fittings of this kind must be tested by an authorized testing department.

8.4.2. Outdoor-Lighting Fittings

8.4.2.1. Street Lighting Lanterns

The increasing density of traffic in the streets and the greater risks of accidents resulting therefrom in the dark but also the higher cultural level in the cities and communities call for a street lighting of a high technical standard. The same demands are made on the lighting fittings because they are the most important parts in directing and transmitting the lamp-generated light. In addition to their technical function, the street lighting lanterns have to fulfill an aesthetical task; street lighting cort correspond to the modern character of cities and communities not only in the technical respect but also in design. For lighting streets, squares and ways street lights fixed to a post or wall by a bracket, suspended street lights and street lights fixed on top of a lamp-post are used according to the technical, constructional and aesthetical requirements. In nearly all cases, high-pressure mercury vapour lamps, halogen metal vapour lamps and high-pressure sodium vapour lamps are used.

Bracket-fixed lights may be open or enclosed. Depending on the place and degree of air contamination one of the mentioned types may be more economical than the other. Both versions are, in general, equipped with an optical system, mostly in the form of a bidirectional mirror. This reflecting system serves to transform the luminous flux generated by the lamps into certain directions, i.e. to shape a certain light distribution. In favour of a good luminance distribution on the road surface, the light distribution solid is shaped in such way that the largest-possible portion of the emitted luminous flux reaches the road – longish form of the solid of light distribution – and the maximum light intensities are within an angle range of 60 to 65 degrees (LVK, spread beam).

Bracket-fixed lights are attached to buildings directly or to poles by side arms.

It has proved good if the lights are fixed at an angle of 15 degrees upwards from the horizontal line.

Figure 49 Brace-fixed lamp hole fitting with light distribution curve with a light output ratio of 0.76 (high-pressure mercury vapour lamp NF 400-01)

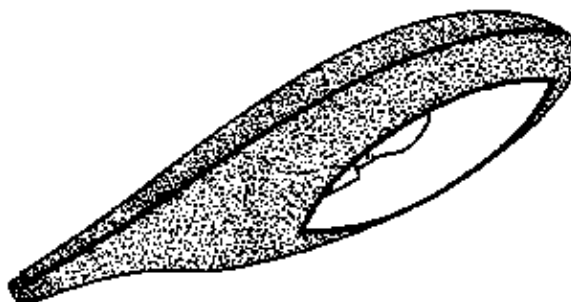

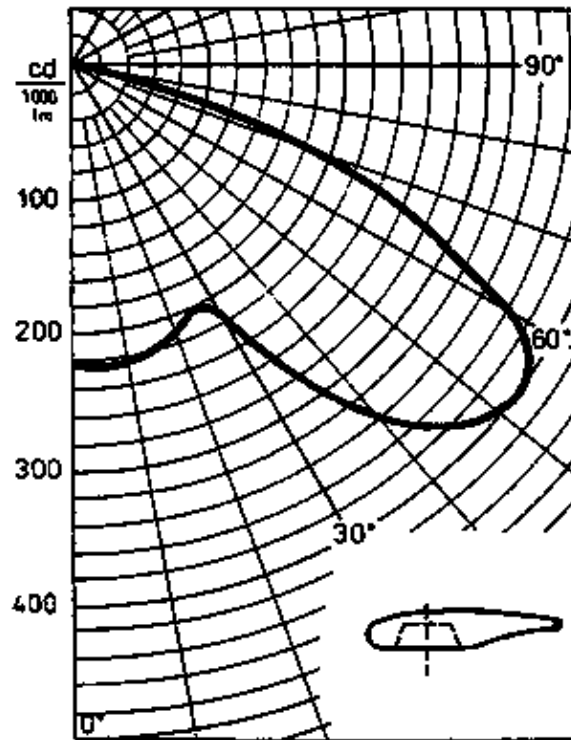

In addition to these high-grade lights with reflector systems there are more simple versions, especially for lighting ways. These are lamp-post lights, fixed by brackets and equipped with simple reflectors such as enamel reflectors, aluminium reflectors and others as well as with mainly high-pressure mercury vapour lamps up to 125 W. They have rotational-symmetrical light distributions. With some types, also high-pressure mercury vapour lamps with internal reflector 80 and 125 W are used.

All bracket-fixed lights have built-in ballasts, compensation condensers and other electric components.

Suspended lights with bidimensional reflectors are – as to their optical system – similar to the bracket-fixed lights and meet the same requirements of lighting engineering. They are fixed by a suspension device on overvoltage wires or ropes over carriageways and pavements. Today, they are used only in places where the traffic ways are very narrow and no posts or other facilities for installing bracket-fixed lights can be erected. Besides the suspended lights mentioned there are those of less technical quality. Mostly they have a reflector of very dense opal glass or enamelled steel sheet. They are used mainly in industry or for lighting paths in smaller communities.

Lights fixed on top of a lamp-post in various designs and for equipment with high-pressure mercury vapour lamps are used mostly in living areas for lighting streets and ways. In addition to their technical function of lighting the surface of the street they have an aesthetical task to fulfill. A portion of the light generated by the lamps is emitted horizontally or in the upper half-space. This brights up buildings, trees, monuments and other things of larger size, so that living areas look more lively in the dark. In addition, a rather good luminance distribution is achieved on the street surface. However, a disadvantage consists in the angle range of 80 to 90 degrees (not shielded). For this reason, lights on lamp-posts are not installed in roads and streets of a great density of traffic.

Figure 50. Brace-fixed lamp pole fitting with light distribution curve with a light output ratio of 0.73 (MA 400-O1 sodium vapour lamp)

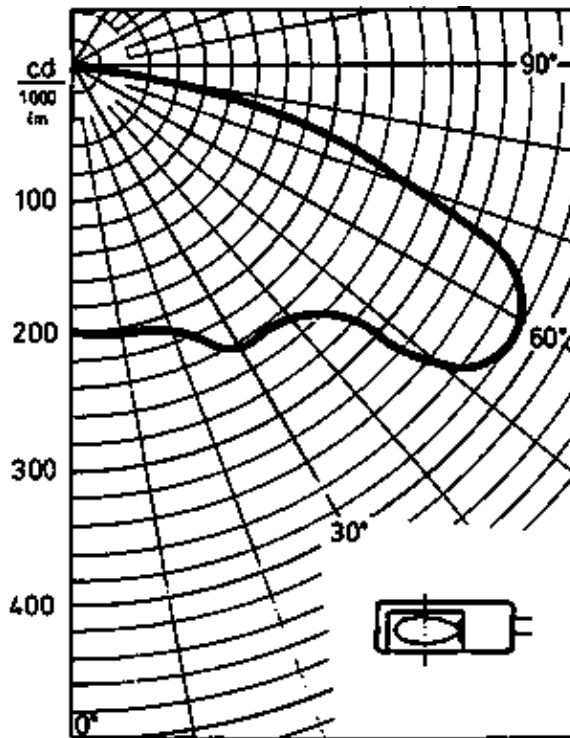
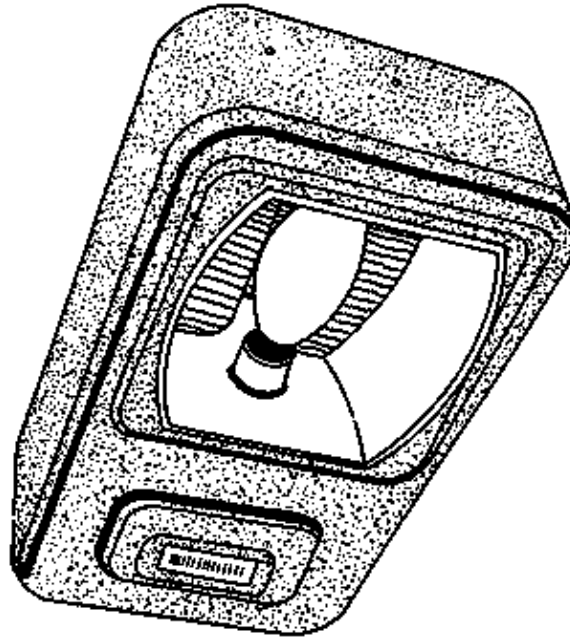

8.4.2.2. Decorative Outdoor-Lighting Fittings

For a number of outdoor-lighting installations, for instance in parks, on lawns, pleasure-grounds, sports fields, gardens and at building entrances lighting fittings are necessary which have to meet great decorative requirements in addition to mere illumination. In the dark and by day as well they shall contribute to the architectural aspect.

We distinguish with this type of fittings those for lamp-posts of 2 to 3 m in height, (fitting on top of the lamp-post), pillar lights, e.g. for gateways, outdoor-lighting fittings to be fixed on walls, ceiling fittings, e.g. for doorways, edged glass fittings to be fixed on walls and flower-bed lights. All the above mentioned lighting fittings are available in various forms according to the conditions of use, the design, the way of fixing and the material used.

All versions are suited mainly for filament lamp equipment. Very often, technical parameters, especially the glare protection angle, are subordinated to decorative considerations.

8.4.2.3. Floodlights and Spotlights

For lighting large outdoor surfaces, especially in industry and with sports fields, where it is not possible to erect many individual lamp-posts for top lights or bracket-fixed lights, lighting columns must be erected. In order to meet the requirements of illumination, which in such places are usually very great, the columns are equipped with lighting fittings of a high concentration of luminous intensity and a narrow half-scattering angle or of lower luminous intensity but wide spreading. These values can be put into practice by floodlights. Basically, it is distinguished between two constructional versions:

- Lights with rotational-symmetrical luminous intensity
- Lights with symmetrical luminous intensity.

Both types can be manufactured in various sizes and, depending on their construction, are suited for equipment with high-pressure mercury vapour lamps, halogen metal vapour lamps, high-pressure sodium vapour lamps, halogen filament lamps and general purpose filament lamps.

Figure 51. Small floodlight with light distribution curve (halogen metal vapour lamp HFL 1000) 1 concentration, 2 scattering

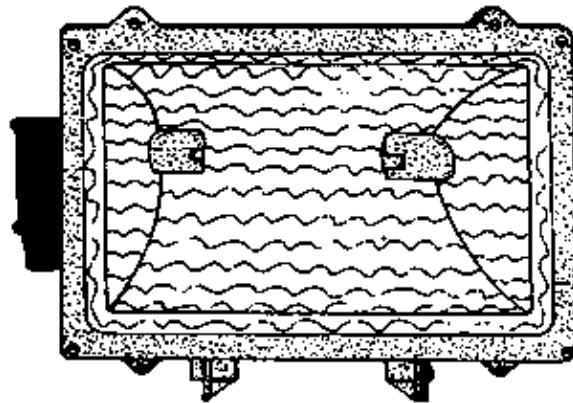

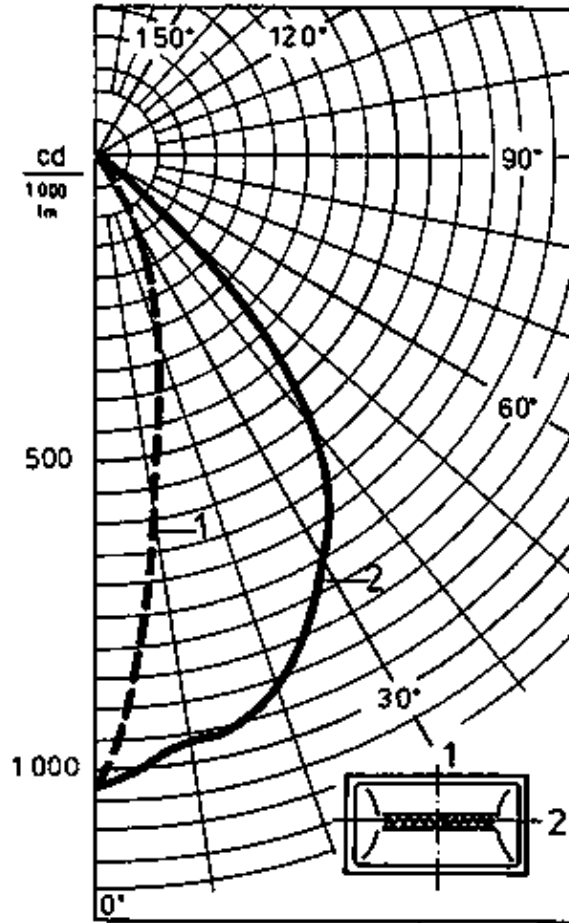
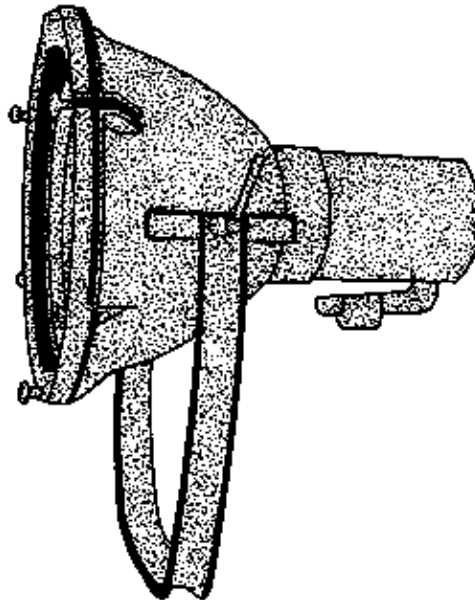

Figure 52. Industrial spot-light with light distribution curve (high-pressure mercury vapour lamp NF 400-01)



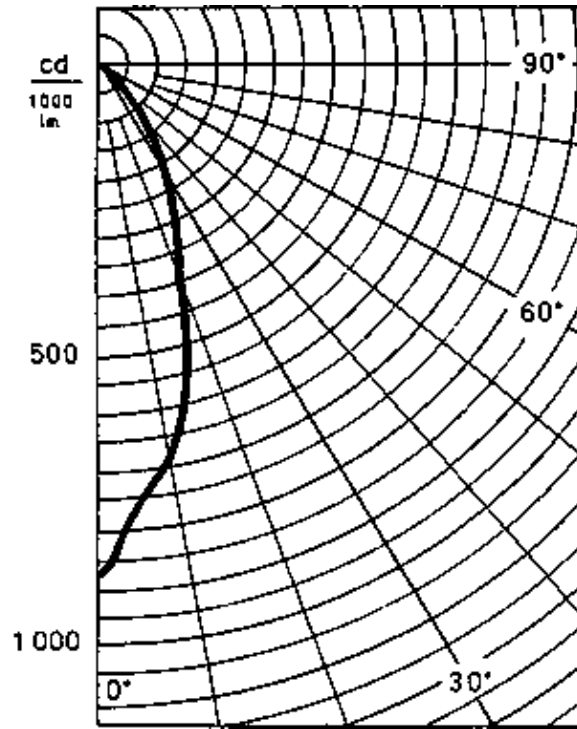
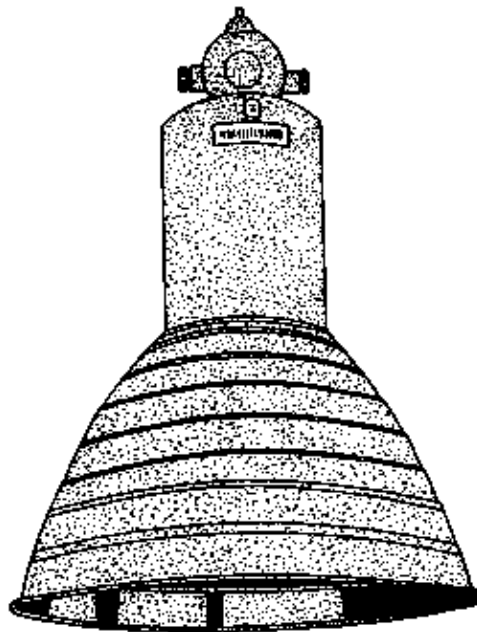
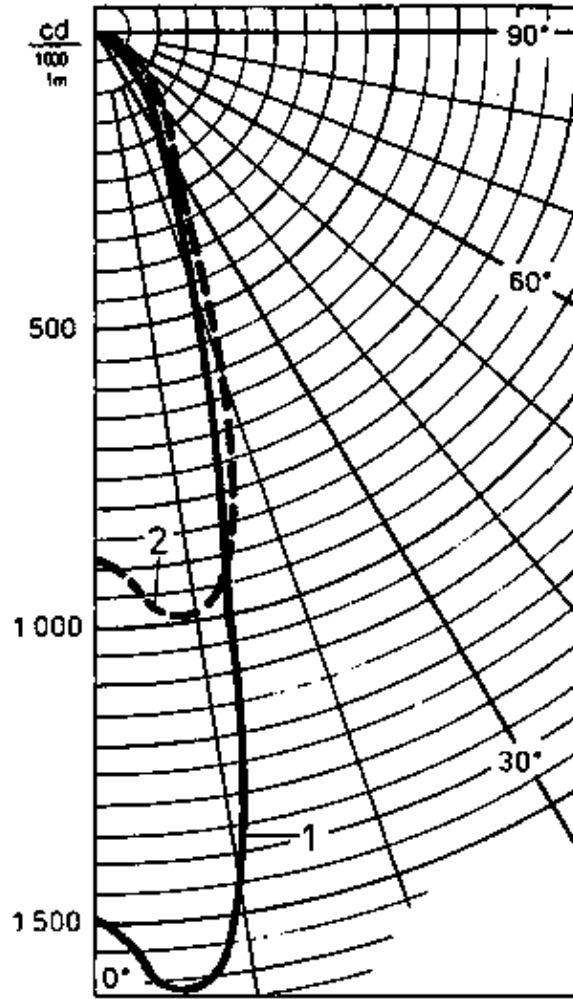
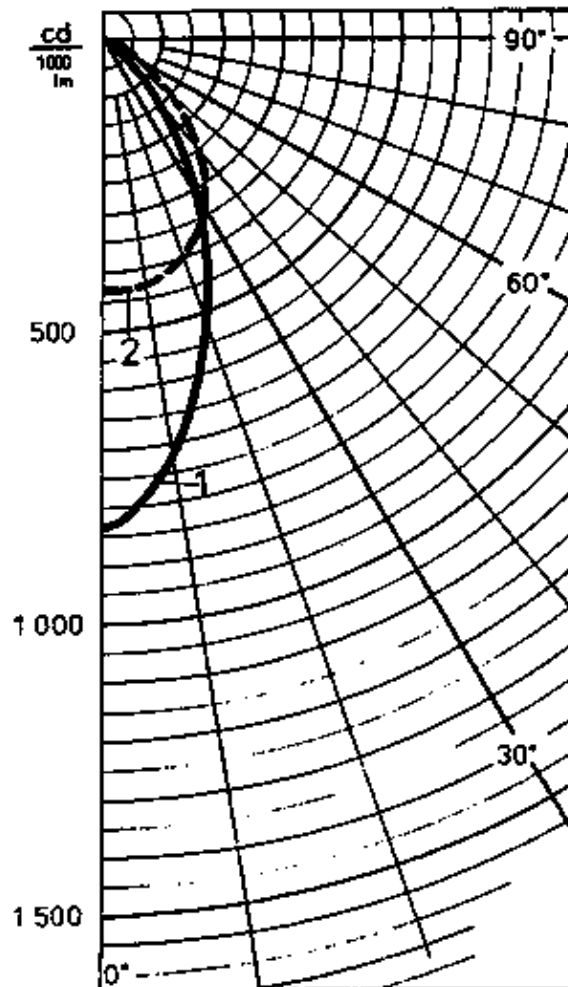

Figure 53. Mirror downlighter with light distribution curves (general service lamp 300/500 W curve around 0 degree)







Efficiency factor of the fitting:

- 1 concentration = 0.62
- 2 scattering = 0.66

(high-pressure mercury vapour lamp NF 400-01; curve around 60 degree)

Efficiency factor of the fitting;

- 1 concentration = 0.62
- 2 scattering = 0.73

It presents itself to achieve various forms of light distribution curves by one lighting fitting by using reflectors of different sizes and shapes, by surface treatment of the reflectors and by using focussing devices – especially with rotational-symmetrical lighting fittings. The series of such lighting fittings prove that this can be done. By a relatively small range of types of floodlights in moisture-proof construction, all tasks of floodlight illumination can be solved.

In addition to floodlight, beam projectors for outdoor-lighting are also used for lighting up buildings, monuments and other things. Such devices are called spotlights – they are very similar to floodlights. Besides the creation of a certain illumination, with these lighting installations it is a question of maintaining the right light colour, shading and evenness on the object to be spotlighted. All these parameters, however, do not immediately influence the construction of the lighting fittings. What is important, is to use the right lamp in the right place. A principle assignment of individual lighting fittings to certain definite lighting tasks cannot be given. All floodlights and spotlights are mostly equipped with a surface-refined aluminium reflector and with a closing glass pane.

For adjusting the horizontal and vertical swinging angle – especially with flood lights – some floodlights or spotlights are equipped with horizontal rotation devices and saal(...)r vertical adjustment.

Floodlights mostly supply rather exactly directed light. Manufacturers often indicate the light distributions in Cartesian coordinates or in tables. For technical calculations, the degree of efficiency of a fitting and the bundle angle (half-scattering angle and tenth – scattering angle) are important.

8.4.3. Lighting Fittings for Representation Purposes and Housing Space

In opposite to utility lighting fittings the light of which, above all, has to fulfill certain technical functions such as illumination, luminance, glare protection, evenness, shading and others, with the lighting of rooms for representation purposes such as restaurants, theatres, cinemas, cultural establishments, hotels etc. aesthetical tasks predominate. In these establishments meant for diversion and recovery light and thus the lighting fittings nearly always are included in the interior design of the entire room. This explains that the form of the fittings and the light colour are of decisive importance, the technical parameters such as light distribution of course being taken into consideration, too. In contrast to this, questions of luminance distribution, glare and evenness are not always of so great an importance. They may even be used to create special effects.

Lighting fittings for representation purposes comprise a wide range of fittings manufactured either as single pieces or in series. This range consists of built-in ceiling fittings or ceiling fittings, suspended or pendant fittings, wall fittings as well as standard lamps. From single-lamp fittings to large chandelier or similar suspended fittings, the lighting fittings are equipped with various reflection and transmission materials. The range of lamps is equally diverse – from filament lamps to various types of discharge lamps. It seems to be rather difficult to select one or another fitting of this range and describe it as a representative. In their technical structure the fittings for representation purposes as well as the utility fittings must meet the relevant standards.

In housing space too, light has –unlike mere utility lighting– an aesthetical task to fulfill by contributing to a comfortable atmosphere in the room. In this context, a flat must be divided up in two parts:

- Working area (kitchen and bathroom)
- Recreation area (sitting-room, nursery, bedroom).

In the working area definite technical characteristic values of lighting are required. The fittings offered for this purpose are increasingly equipped with fluorescent lamps. Open as well as closed types are used. With the help of such fittings relatively great illuminations with good evenness and little glare can be achieved.

In the recreation area mainly fittings for filament lamps are used. Various ceiling, suspended, wall and standard fittings are covered by glass, plastic or textile lamp-screens, so that their light helps to create a comfortable atmosphere in the room. This means that individual zones of the room require different lighting, i.e. greater contrast is desired. Domestic lighting fittings, especially for the recreation area, are very much subject to the trend of fashion; they are constantly harmonized with the design of the rest of furniture and interior architecture.

In order to guarantee the technical quality of lighting and to prevent the waste of energy domestic lighting fittings are tested as to certain minimum requirements in the field of their technical parameters some values being internationally recommended.

These are

- An efficiency of the lighting fitting equal to or exceeding 50%
- Observance of recommended glare protection angles
- Observance of recommended luminance values
- Compliance with illumination values with local lamps.

8.4.4. Lighting Fittings for Special Purposes

This term unites all lighting fittings that serve the above mentioned purposes. They include decorative lighting fittings for advertisement, illumination, theatre, film and television. Medical purposes, research and teaching require special fittings, too.

By the term "special" a special mechanical version, special light source or special optical equipment of a lighting fitting is understood.

However, it is beyond the scope of the present textbook to deal with this group of lighting fittings.

Questions for repetition and knowledge tests

1. What are the tasks of lighting fittings in a lighting installation?
2. What kinds of lighting fittings are known?
3. What requirements must a local lamp (working place, lighting fitting) meet?

9. Commercial Lighting Fittings

Today's technical standard allows manifold possibilities of visual advertisement with the help of artificial light, which, however, are not always fully utilized. Already at the stage of planning it should be determined which external surface for instance of business premises or of a facade comes into the question for light advertisement. In doing so, the following general conditions are to be considered:

Good recognizability

Picture and writing must appear clearly. Good recognizability is determined by the size and shape of the letters, sufficient contrast of the advertisement surface to its environment and the surrounding colours.

Selection of the right luminous colours

With the selection of luminous colours, yellow, white and green are preferred. Yellow is the most quickly sensed colour in the peripheral viewing field. Blue is the least eye-catching one. As to contrast, it is rather difficult to give generally valid recommendations for advertising installations. With wall-mounted installations, there are degrees of legibility of writings with respect to the colour of the background and the colour of the letters. Freely erected letters which have the sky as background have to be especially carefully examined as to their effect by day. For such installations, a contrast painting of two colours would be a suitable solution.

The entire advertising installation should have harmonized luminance ratios.

Luminous advertising must be effective also by day due to form and colour. Above all, it must meet aesthetical and architectural requirements.

Getting dirty must be prevented to the farthest possible extent; Therefore, plane surfaces and coverings of a smooth surface finish should be used for luminous advertising. Defective parts must be easily replaceable.

It is distinguished between three types of advertising installations:

- Self-luminous installations
- Transilluminated installations
- Illuminated installations.

9.1. Self-Luminous Lighting Installations

These include high-voltage luminescent installations and high-voltage fluorescent tube installations. They are the most common types of light advertisement and enable almost all and every form. Practically, any light colour desired can be generated by them. Light intensity is brilliant and makes the installation very striking. The chief components of a fluorescent tube installation are the fluorescent tubes, the metal support in the form of relief bodies, strip or electrode boxes, the series reactors – mostly transformers – and the circuits.

The fluorescent tubes are different in thickness according to the respective purpose and size of the installation.

The total effect of an installation is determined by the relief. The effect by night is reduced in so far as the writing can be recognized absolutely clearly only from an almost vertical direction of sight. Looked at from the side, the letters are not so well legible because they appear indistinct.

With big light advertising installations multiple illumination of the relief is necessary. The legibility of the letters can be improved by concentrating the fluorescent tubes on the cores of the letters leaving edges of 5 to 6 cm in height. The relief body and the equipment are decisive for the effect of the advertising installation by night.

All fluorescent tube writings are special constructions. At first, a commercial artist designs the planned installation as to its effect by day and night. Starting from these drafts, drawings scaled 1:10 are made for an offer. These drawings show all technical details.

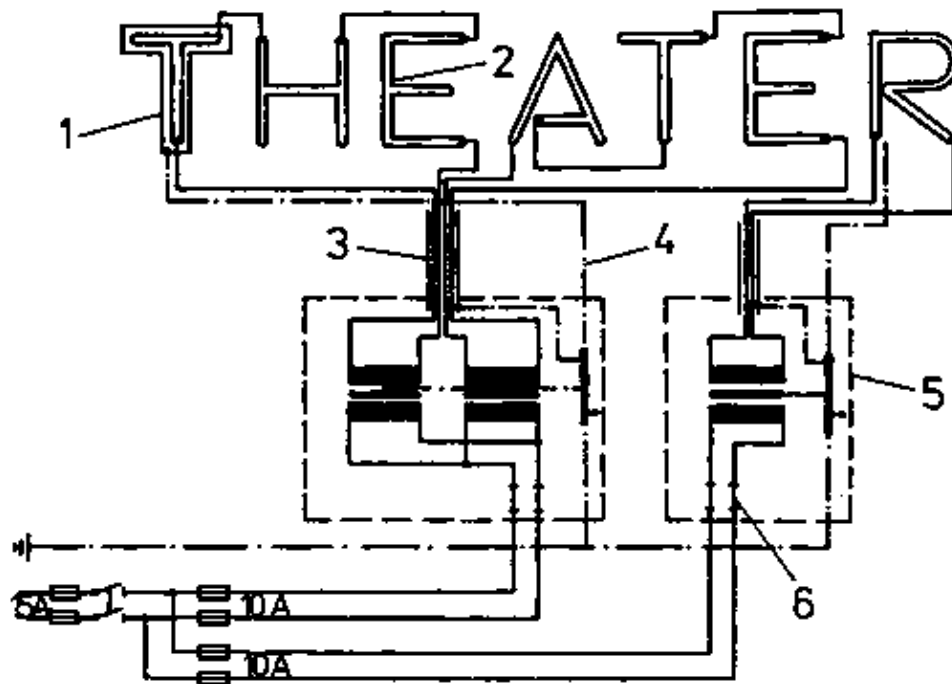

Figure 54. System structure of a fluorescent lamp installation

1 relief body, 2 fluorescent tube, 3 steel tube, 4 earth lead, 5 protective casing, 6 isolating switch

9.1.1. Cold-Cathode Tubes (High-Voltage Fluorescent Lamps)

- Lamps with cold electrodes.
- Little light efficiency due to cathode drop up to 450 V.
- Only long lamps are economical.
- Operating voltage is between 800 and 6000 V, approximately.
- Lamps without luminescent material supply a light yield between 2.5 and 5.5 lm per watt.
- High voltage is generated by leak transformer. With the help of an adjustable shunt, the high voltage is adapted to the operating parameters of the respective lamp or a number of lamps connected in series.
- Service life about 10000 hours.

The colour effects (coloured tubes) are produced with the help of

Luminescent materials

- calcium wolframate – colour light–blue
- magnesium wolframate – colour bluish–white
- zinc silicate – colour light–green
- zinc beryllium silicate – colour yellowish white
- cadmium silicate – colour yellowish white
- cadmium boate – colour carmine

as well as by radiation of inert gas

- helium – colour whitish pink
- neon – colour orange red
- argon – colour bluish grey
- hydrogen – colour violet
- nitrogen – colour yellow
- oxygen – – –
- carbon monoxide – colour white
- mercury – colour bluish grey
- sodium – colour yellow

Table 31 Characteristic values of high–voltage fluorescent lamps

Power	Luminous flux	Light colour	Tube length
(W)	(lm)		(mm)
30	600	daylight white	1000
35	750	daylight white	1250
40	900	white	1500
44	1050	warm tone	1750
47	1200	special colours	2000
50	1350	special colours	2250

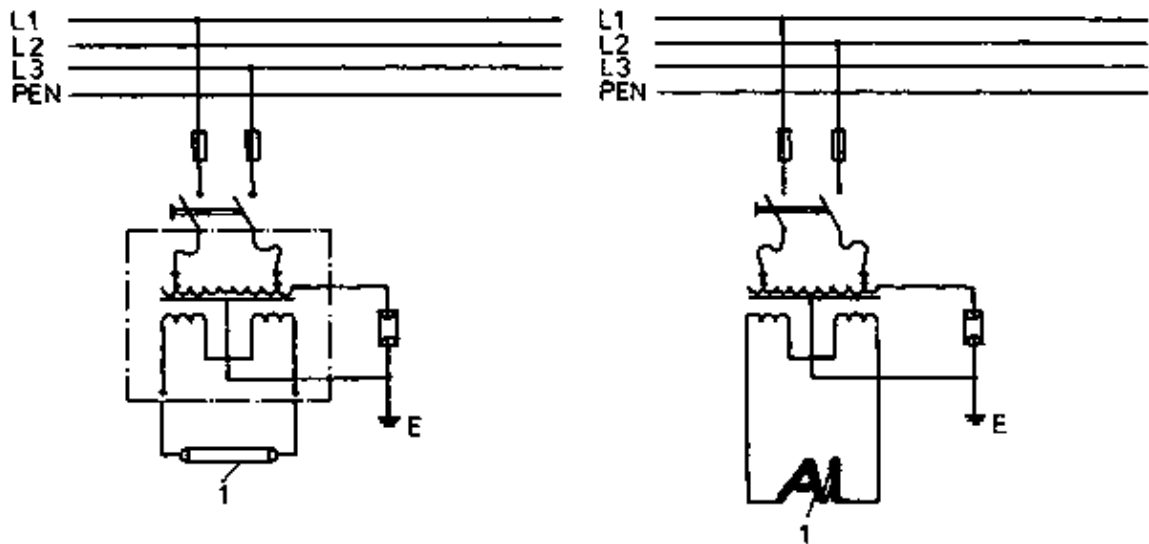

Figure 55. High-voltage fluorescent lamp circuits

1 fluorescent lamp up to 3 kV and/or fluorescent letters up to 6 kV

9.1.2. Operating components

In addition to the high-voltage fluorescent lamps – rod or letter-shaped – pertinent sockets, leak transformers are required. There are installation transformers and letter transformers. A writing can be fed by one transformer or several letter transformers. In case of failure of an installation transformer the entire writing goes out, whereas it comes to gaps between the letters if individual transformers fail to function. It is up to the user to decide about the type of transformer used.

For increasing the advertising efficiency of light installations, these can be equipped with special switching devices. The following versions are used:

- Flashing circuits with bimetallic contacts or controller drums.
- Multitext circuits with which, by a motor-operated switch mechanism, the main text (by-day effect) is switched alternately with an additional text on a secondary level.
- Program circuits with controller drums, with which individual letters or words can be added to a picture.
- Shadow line switchings with which a movement is pictured on a surface by direction-oriented switching steps. This effect is achieved by dividing the entire length of a tube in as many small uniform or equally long portions as possible, which are switched over the primary side by means of a switching mechanism.
- Polypole switching producing the impression of writing or flowing light.

It works by controller drums on the high-voltage side. As fluorescent tubes multielectrode valves are used. The distance between the electrodes is 10 to 15 cm.

- Rotating installations are a form of free-standing advertising installations.

By rotation, the eye of the looker-on is caught by day and in the dark as well. The rotation cycles with installations of a diameter of 4 m or diagonal arrangement shall be 2 to 2.5 rotations per minute, with installations of more than 4 m 1.2 to 1.5 rotations per minute.

- Swelling-light installations with which gradual growing and decreasing of the luminous flux is enabled by actuators. The best interval of regulation between minimum and maximum values of the luminous flux has proved to be 1 s.

- Colour spreading is based on mixing the three primary colours red, green and blue in an additive way. By doing so, any other colour can be created. The period of one colour cycle should last between 5 and 10 s.

Hints to practice

Advertising installations require specially careful installation. High-voltage advertising installations – due to the high voltages applied – are very hazardous. The use of spotlights involve the danger of fire because inflammable materials may be ignited by the focal points of the reflectors and lenses which are situated far from the spotlights themselves.

9.2. Transilluminated Lighting Installations

The most commonly known installations of this group are the transparent. Their effectivity depends on the condition, that the entire luminescent surface appears uniformly bright. The coverings used must produce a good light scattering. Flashed turbid glass or plastic material of equal scattering are the best suited coverings, whereas spotted glass has a good scattering effect but causes more loss of light.

With direct transillumination, frosted glass should not be used. The distance of the lamps to the turbid-glass surface must not fall short of a definite measure.

If filament lamps are used, the minimum distance of the lamp from the transparent surface must amount to one third of the diagonal of the surface portion to be illuminated by the lamp. The distance between the lamps is maximally the 1.5-fold of the distance of the lamps from the luminous area. If such distance cannot be realized, the transparent surface may be irradiated indirectly, which, however, requires much more energy. In any case, transparent boxes must get a diffuse white painting.

9.3. Illuminated Installations

The important point with this type of installation is to achieve the best possible uniformity of the surface to be illuminated by direct lighting of the advertising surface. Test have shown that illumination differences of 3:1 are still perceived as uniform by the eye. Uniformity depends on the distance of the lighting fitting from the surface and from the incident angle of the light. The conditions become the better, the higher the angle of incidence is. The limit of the reflector distance from the advertising surface as to the sensation of uniformity is two thirds of the height of the surface. If this distance cannot be observed, this is to say if the distance of the reflector cannot be made smaller than half the height of the board, uniformity can be achieved by fixing a reflection strip on the lower edge. However, this can be made only with smaller surfaces.

9.3.1. Lighting Installations in Sales Rooms

In sales rooms, the attention of the customer is invited and wishes are awaked mainly by optical impressions. Here is a large sphere of action for lighting engineering. Generally, the following rules apply to the design of lighting installations in sales rooms:

- Illumination must be sufficiently intensive; it is determined by the degree of reflection of the goods.
- If possible, the lighting installation should be mobile in order to be able to follow shifts of the focal points of sale within the sales room.
- The lighting installation must be harmonized with the interior architecture of the room.
- The lighting installation must produce no disturbing glare.
- The lighting installation should be easy of access for maintenance reasons.

There are recommendations concerning the selection of lighting in sales rooms. In this context, the indications on the illumination should be considered as the minimum requirements. It is determined by two factors: the colour of the goods and the situation of the sales rooms as regards traffic. Dark coloured goods require more illumination than bright goods. If in a sales room dark ware is frequently followed by light-coloured articles or vice versa, the lighting installation should be constructed in such way that illumination is adjustable. With the selection of the light colour two things have to be considered: Firstly, the colour rendition qualities of the products sold are important and secondly, customer and shop-assistant must find themselves in a pleasant light. Therefore, fluorescent lamps of 'neutral white' light colour are used in most sales rooms. In many sales rooms, lighting fittings are included in the design of the inserted ceiling, especially if the rooms must be ventilated or partially air-conditioned. Many possibilities of variation are offered by modern assembly ceilings, which can easily be adapted to the changing design of the sales room and the changing lighting situation resulting therefrom. In addition to the general lighting, the equipment of a sales room must provide for additional local lighting for marking main points of sale. By illuminating an article with the help of point-shaped light sources, its plasticity and gloss can be accentuated. Make sure that glare is avoided. Direct glare is prevented by screens, reflection glare by selecting the right place of installation. Lighting fittings that shall illuminate the counter should be placed above the front edge of the counter, so that the customer does not stand in his own light or is disturbed by reflection or a shiny table-top.

Very often, show-cases or shelves are used for display. They, too, require appropriate illumination.

For the illumination of exhibition rooms for motor vehicles luminous ceilings or indirect illumination of the room is applied. This kind of illumination is especially suitable in cases where show-windows and sales rooms are combined. This way, a calm and uniform illumination of the entire room is achieved, and the vehicles can be viewed well from all sides.

A disadvantage consists in the low efficiency factor of the installation and the uniformity that creates no special eye appeal in the room. Luminous rows on the ceiling of the exhibition room look more gay due to the reflection of the lights by the car-bodies. However, the fittings always must be covered by opaline glass, plastic cups or spill shields. Furnishing houses, too have to be treated as a unity of show-windows and sales rooms as regards illumination. Very often, completely furnished rooms are shown including wall-paper, carpets, curtains, vases and lighting fittings. The lighting fittings should always be switched on. Because they do not supply sufficient sales room illumination, additional general lighting is required in the form of fluorescent lamps placed above the show-window pane behind the window head. These fittings have to be covered by wooden or sheet metal flashings or by spill shields, so that they are not to be seen from the sales room, in large rooms, general lighting is effected by fluorescent lamps arranged directly on the ceiling and covered by large-space spill shields or by covered lighting fittings integrated in ceiling systems. The right lighting of glass, crystal and jewellery shops is a special challenge due to the manifold refraction of light, reflection and mirror effects which attract the attention of the looker-on.

In the sales rooms of textile shops the goods must be presented to the customer not only in artificial light but also in daylight. For this purpose, try-on cabins have to be equipped with xenon lamps the spectral energy distribution of which is similar to daylight with overcast sky.

In all sales rooms where clothings are sold, mirror illumination deserves special attention. In a good mirror lighting, the entire person should appear in a uniform light without dark shadows.

The best possible illumination is achieved by one light source on either side of the mirror. The lighting fitting must be such that the looker-on is not dazzled. Point-shaped light sources, as a general principle, must be placed behind light-scattering materials. Line-shaped light sources should be screened in the same way.

A special type of sales rooms are those where clothes are presented by fashion models, for instance outer garments for ladies and gentlemen. Usually, such rooms are rather comfortably furnished. Illumination must enable the customer to see all details of the clothes presented. Illumination must be free of glare, and especially vertical illumination must be sufficient.

9.3.2. Shop-window Lighting

The old advertising slogan 'light attracts people' applies especially to the decoration of shop-windows. With shop-window illumination, luminescent lamps are prevailing.

For achieving special effects, reflector fittings or silvered filament lamps with or without colour filter are used.

By this, individual parts of the shop-window can be accentuated. Most articles require illumination from below, so that the construction of the shop-window should provide for the connection of additional lighting fittings near the floor.

The selection of the illumination is – similar to the sales room illumination – determined by the kind of goods exhibited in the respective show-window and by the traffic situation. In table 32, recommended values for the illumination of shop-windows are to be found.

Recommendations for the electric power that should be available per square metre base surface of the shop-window are indicated in table 33.

Table 33 Recommended values of electric power per square metre

Size of settlement	Main roads	Boulevards	Business streets
	(power per square metre)		
50000 inhabitants	300	200	100
50000	200	100	50

The following demands are made on shop-window lighting:

- The shop-window must have a sufficient illumination level according to the kind of articles displayed.
- The goods exhibited must form a good contrast to the rear wall of the shop-window.
- If the shop-window decoration has light or dark colours alternately, the lighting installation must enable the switching-on of more or less light.
- No lamps or lighting fittings must be visible from the standpoint of the passer-by in front of the shop-window. Reflections on the rear panel of the shop-window should be avoided by using dull material in this place.
- Lamps and lighting fittings from the sales room have to be covered by shields on the rear wall of the shop-window.
- No unnatural shadows must be created; this holds especially true for things situated near the shop-window pane.
- There must be sufficient possibilities of connecting additional fittings for special light effects.

Table 32 Intensity of illumination in shop-windows

Size of settlement	Type of street	Service illuminance in lx					
		Kind of goods					
		light, e.g. china, linen		medium, e.g. food books		dark, e.g. cloth, fur	
		Window space					
		narrow	deep	narrow	deep	narrow	deep
More than 50000 inhabitants	Business streets, parking places, side-streets	300	500	300	500	500	750
	Boulevards	500	750	750	1000	750	1000

	Central squares, important junctions, main roads, places in front of stations	750	1000	2000	3000	3000	5000
10000 to 50000 inhabitants	Business streets, parking places, side-streets	200	300	400	500	300	500
	Boulevards	300	500	300	500	500	750
	Central squares, important junctions, main roads, places in front of stations	300	500	500	750	750	1000
Less than 10000 inhabitants	Business streets, parking places, side-streets	100	150	150	200	200	300
	Boulevards	150	300	200	300	300	500

The main conditions of the electrical installations are

- that the entire electrical equipment is invisible for the looker-on;
- that the freely selectable connection can be easily used by the window-dresser free of accident and at any time.

Besides the adaptation of the shop-window illumination to the space conditions, attention has to be paid to the kind of goods displayed. The articles shown determine the light colour and the type of illumination. Table 34 gives recommendations related to the displayed goods.

Figure 56 shows basic possibilities of designing modern shop-window illuminations.

Table 34 Demands on light colour and type of lighting

Goods displayed	Light colour Light source	Type of lighting	Additional light
Glass and ceramics	fluorescent lamp neutral white de luxe 21	direct	spotlight
Gold, silver, jewels, watches	fluorescent lamp neutral white de luxe 21	direct	low-voltage spotlight
Books, stationery, pieces of graphic grap, optical articles	fluorescent lamp neutral white de luxe 21	mainly direct	
Furniture and accessories	fluorescent lamp neutral white de luxe 21	uniform (large)	
Cloth, garments, leather goods, shoes	fluorescent lamp neutral white de luxe 21	uniform	spotlight
Cosmetics, hairdresser' s shops, beauty parlours	fluorescent lamp neutral white de luxe 21	uniform	
Flowers	fluorescent lamp neutral white; filament lamp	mainly direct	spotlight
Meat and meat products, baker's ware	fluorescent lamp warm white de luxe 31	uniform	
Household goods, technical art.	fluorescent lamp neutral white 20	uniform (large)	
Cars	fluorescent lamp neutral white 20	mainly indirect or uniform (large)	

Questions for repetition and knowledge tests

1. What is understood by the term of 'self-luminous installation'?
2. How are the high-voltage cold-cathode tubes and high-voltage fluorescent tubes fed as regards high voltage?
3. What commonly used switching equipment for advertising installations is known?

Figure 56. Ways of arrangement of fittings

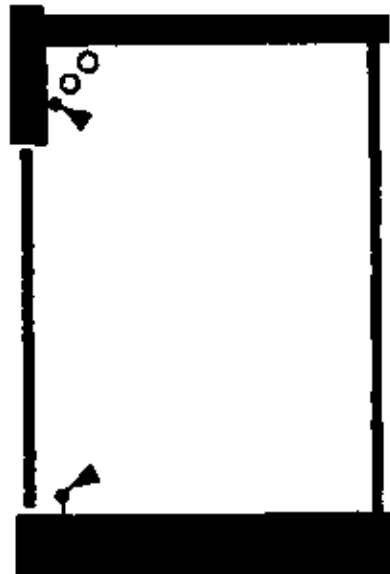

1 front shop-window with little depth

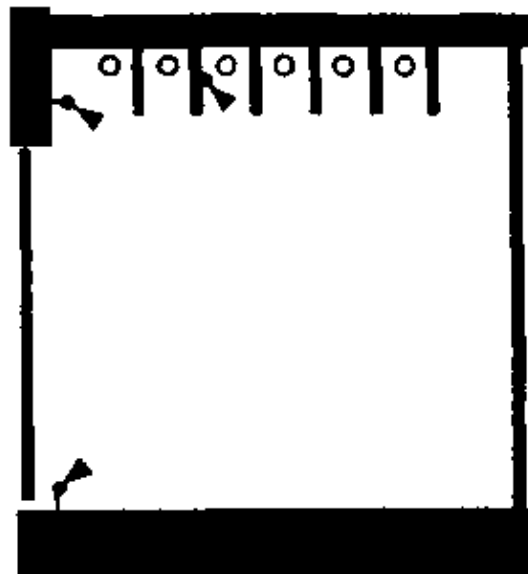

2 front shop-window with great depth

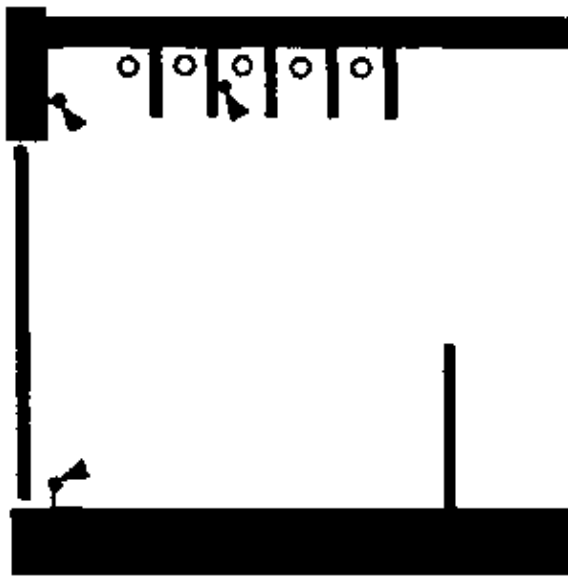

3 front shop-window not separated from the sales room

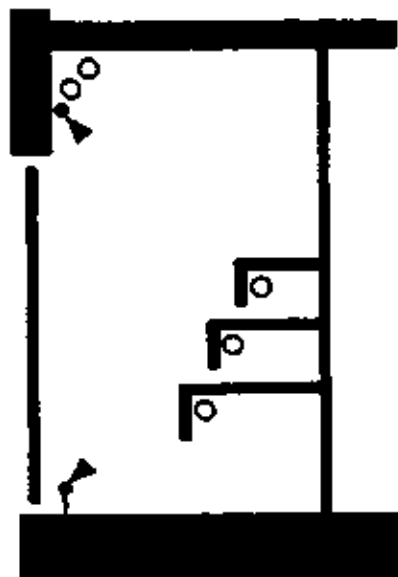

4 front shop-window with decks

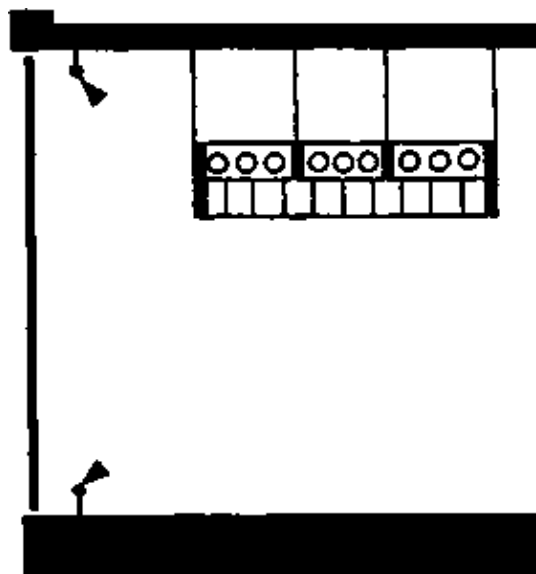

5 corner shop-window or front shop-window without window head

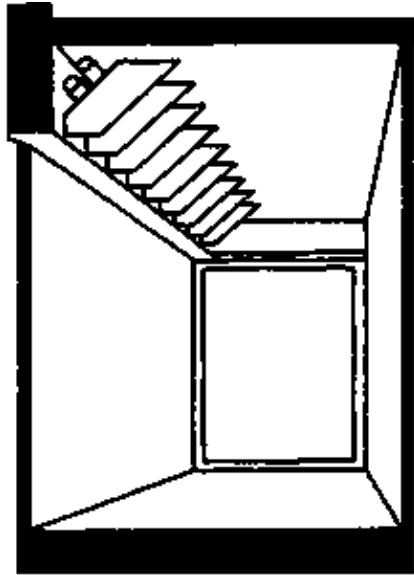

6 corner shop-window with little depth

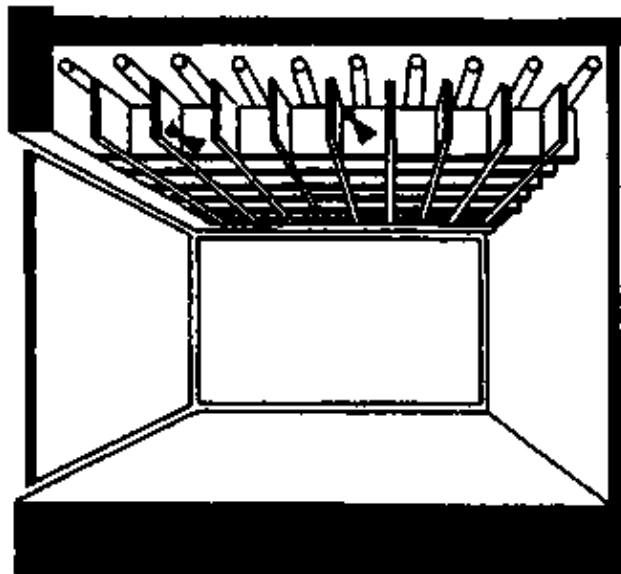

7 corner shop-window with great depth,

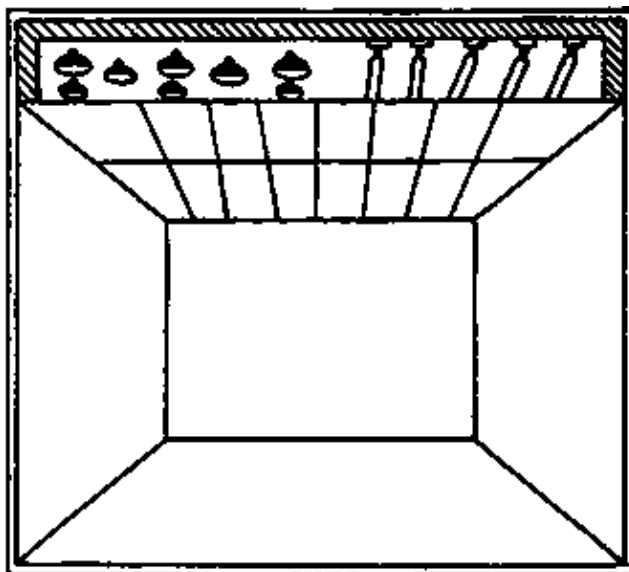

8 shop-window that can be looked over from all sides - passage shop-window

10. Mounting of Lighting Installations

Lighting installations are to be found in a variety of buildings constructed by classic or modern methods.

Consequently, the arrangement, fixing and electrical feeding of the lighting fittings must be carried out accordingly. The techniques and technology applied depends on the material and know-how available such as working means and manufacturing means. In addition, the purpose of the lighting installation imposes further decisions and/or limitation. The normal procedure includes the wishes of the future user, the examination of the network conditions, environmental and local conditions and then the projecting of the lighting installation with simultaneous ordering of the required materials.

Only then the practitioner starts to act. He is responsible for the skillful mounting of the lighting installation true to plan. The variety of regulations and standards to be observed go down to clearly outlined sections. Lighting installations are categorized by the following order:

Indoor Lighting

- Local lighting (working places)
- General lighting
- Emergency lighting
- Factory lighting
- Domestic lighting
- Lighting of social buildings
- Lighting in agricultural buildings
- Lighting of rooms for special purposes

Outdoor lighting

- Industrial buildings
- Filling stations
- Advertising installations
- Athletic grounds
- Streets, ways, squares
- Building sites
- Camping sites
- Port and quay installations

In the framework of this chapter only a limited selection of the relevant problems is dealt with.

10.1. Mounting of Indoor-Lighting Installations

In this context, a number of installation variant come into question. In the phase of projecting of an installation it must be decided how a useful, economical and effective solution can be achieved. The conditions of use of an installation are determined by the physical, chemical, climatic, technological and aesthetical demands on the lighting installations caused by the building itself and its environment. The following points have to be decided upon:

- Only series-manufactured installation elements and systems are used.
- The elements or components of the installation systems shall be arranged and fixed directly on the structure or on parts of it without greater auxiliary constructions.
- The mounting elements shall be universally usable to the largest possible extent,
- As regards the fastening points, the permissible static loading of the truss or ceiling construction has to be considered.
- With metallic mounting elements, corrosion protection must be provided for; a connection of Al and Fe has to be avoided.

- In buildings with cranes or conveying equipment, horizontal or vertical installations are permissible only in definite places.
- Installations of any kind must not reduce the aesthetically quality of the general view of the respective building.
- The entire installation has to be considered as a complex system; it shall form a unity, starting from the arrangement of the distribution system over the horizontal or vertical circuits to the lighting installation as well as in connection with the balancing system and the controlling mechanisms.

For fastening the lighting fittings and for the run of the installation in the truss areas, installation systems have been developed enabling quick and flexible electrotechnical equipment of a building. Table 35 informs about the preferred installation systems for the construction of lighting installations.

Table 35 Preferred indoor lighting installation system

Installation system	Application
High-current distributor	Rising main, main circuits
Rail channel systems	Rising main, main circuits feed line to luminous rows
Underground systems	Feed line to distributions, line from distributions to supports and walls
Baseboard and wallboard channel systems	Feed lines from distribution, to lighting fittings or switches, used in housing and social construction
Lamp brackets combined with installation carrier rail	Used mainly in social construction
Universal carrier rail system	Especially suitable for carrying and mounting the lighting installation and wiring in factory buildings due to great carrying capacity and fixing distance (truss level)

Universal carrier rail systems and the installations rails which are connected with the lamp bracket are of special importance. The technical advantages of the universal carrier rail systems are that the parts of the system can be easily combined, that wires can be laid independently, that the general view and protection quality are better, that re-installation or additional installations can be made in a cost-saving way, that the assembly and the change of connection points are easy. The components of the universal carrier rail system enable the construction of any kind of net in the ceiling or truss area for fixing installation wires, devices and lighting fittings.

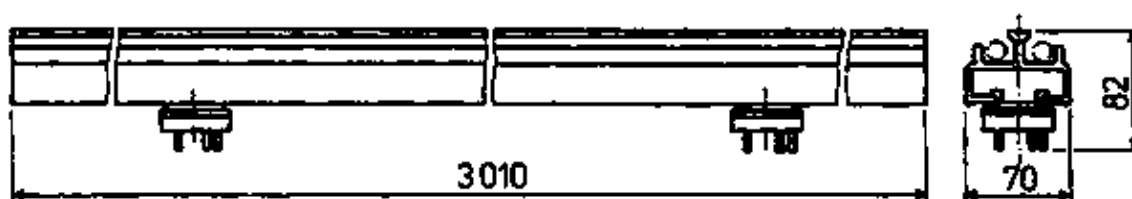

Figure 57. Carrier rails for fittings in row installation

Another possibility of rational assembly consists in the use of installation carrier rails in connection with combinatory lighting fittings.

As far as the fixing of the lighting fittings, luminous rows or luminaire rows is concerned.

- fixing on carrier systems and
- individual fixing are distinguished.

Individual fixing mechanisms are hooks, straps and ropes. When fixing a lighting fitting make sure that the suspension attachment can carry the 5-fold weight of the fittings, but at least 10 kg without being deformed.

In addition, the ceiling hook must resist a torque of 2.5 Mm for 1 minute. Ceiling dowel pins must be from hardwood, because those consisting of soft wood or plastic have too much shrinkage. For extremely heavy

lighting fittings, concrete fixing or fixing with the help of through bolts is to be preferred.

With span–wire installations, maximum values apply as to the structure loading resulting therefrom.

Lighting fittings have to be fixed and arranged in such way that the accumulation of heat is avoided. Make sure that there is no contact with easily inflammable materials such as curtains, strawplaiting etc.

Lighting fittings must be fixed and arranged in such way that neither the operating temperatures nor temperatures occurring in the case of overload endanger the installation itself or the environment.

The fixing of lighting fittings immediately on the ceiling is allowed only if the ceiling consists of non–inflammable material. By such material are meant: sand, gypsum plaster, stone, mortar, concrete, glass, asbestos cement, mineral wool and metal. On inflammable materials lighting fittings are allowed to be fixed immediately on the ceiling only if these fittings consist of materials which hardly catch fire. All the rest of lighting fittings must have a structure distance of 35 mm and must be closed on their upper side. If a lighting fitting has no top cover, it can be closed by a sheet metal of 3 mm in thickness. If inserted ceilings are constructed of easily inflammable material, even hardly inflammable lighting fittings must have a distance from the ceiling of at least 35 mm. The electric connection of lighting fittings must be realized only through fixed built–in terminals or luminaire terminals. As far as the terminals are suited to receive two or more cable cores, through–wiring or a branch is possible. If a through–wiring of lighting fittings in band arrangement is made, the internal temperature is decisive. The required reduction of the current–carrying capacity of the installation material is to be seen from the relevant standards.

Lighting fittings have to be included into the protective measures against shock even if they are not within hand reach. The following protective measures against hazardous contact voltage are applied to indoor lighting installations:

- Connection to neutral
- Protective lead system
- Protective insulation
- Protection low voltage
- Protective isolation.

With the protective measure of connection to neutral, which is used with the most installations, and with the protective lead system all conductive parts of the casing of the lighting fitting that can get alive in case of failure must be well connected with one another and with the protective conductor. Construction components of the lighting fitting must not be used as protective conductors. An exception are installation carrier rail systems, which may be used as protective conductor supposed that their structure allows it.

Especially strict conditions apply to protective measures in rooms used for medical purposes such as the maintenance, monitoring and restauration of vital functions of patients. These purposes include functional unities such as operation, functional diagnostics, endoscopy, childbirth, premature infants, emergency cases, diagnostic radiology. In such rooms even those lighting fittings which do not serve for general illumination must be provided with the protective measure of the protective lead system with constant control of the insulation resistance of the active conductors to earth.

With lighting fittings with protective insulation, no connecting of a protective conductor – neither directly nor indirectly –must be possible!

The protective measures of protective low voltage and protective isolation are applied to hand lighting fittings for use in boilers, silos, bakery ovens, etc. Permitted wiring materials for lighting fittings are:

- holder wires type H05V–V and
- flexible cords type NYPLYw.

Fixed connecting leads must have a minimum cross section of 0.75 mm².

The following cable material has to be used:

- NYFAw for 55 to 105 centigrade
- N4GA up to 120 centigrade and
- H05SJ–K up to 180 centigrade.

There must be no risk of the cables being damaged by lighting fitting motion.

Mobile lighting fittings may be supplied with current by plug and socket connections or in a fixed way, but tension-relieved, over an appliance coupler.

Lighting fittings permitted to be operated in temperature ranges other than 30 degrees centigrade must be specially marked, for instance 'T45gradC' or 'for outdoor lighting only'.

The hammer symbol stands for rough work such as heavy industry, building firms, agriculture and so on.



If the following symbols are to be found on a lighting fitting, this means: 60 W T 30 °C

Lighting fitting for rough work; water and dustproof; protective insulation; maximum wattage 60 watt; usable in temperature up to 30 degrees centigrade.

Fittings to be built in furniture must be marked for this purpose. Furniture fittings for filament lamps are marked



as follows:

The same applies to furniture fittings with discharge lamps, if the inflammability of the respective piece of



furniture is not known. Lighting fittings bearing a furniture mark be fitted on materials of normal or little inflammability. In rooms with bath-tub or shower lighting fittings are allowed to be fixed in zone 2, if they have a protective insulation and at least the protective system of IPX4. They must be connected by plastic cables – no metal sheathing! In rooms with swimming-pool, lighting fittings should be placed at a distance of 2 m from the rim of the basin and in any case out of hand reach. Underwater lighting fittings must resist hydrostatic pressure, this is to say they must be enclosed in a IP68 watertight capsule and operated with protective low voltage (25 V). There are three types of swimming-pool lighting fittings:

- Connection to the net and replacement of lamps is made from the side opposite to the water.
- Replacement of lamps from the front side after draining.
- The complete lighting fitting is taken out for replacement of the lamp.

Lighting of saunas must be switched separately. In the terminal boxes, breaking terminals must be built in that with the outgoing circuits the insulation test can be carried out without disconnecting 'N'.

10.2. Factory Lighting – an Example of Indoor-Lighting Installations

This partial field comprises the following focal points:

- Metal-processing factories
- Chemical works
- Textile works
- Enterprises of electrical engineering and electronics
- Pulp, paper and printing works
- Energy supply plants
- Agricultural units
- Mining works.

On the basis of a number of the above mentioned focal points problems in connection with special lighting installations shall be discussed.

10.2.1. Metal Working Factories

The technological working process in metal-processing factories is determined by the final product. This means that there are no individual separate workshops for every single step of manufacturing but the workpieces are processed or worked by various machines arranged in succession in the same large room. This transition to flow-line production requires – as to lighting engineering – that the illumination in such room is determined by the work to be done most frequently. In general, illumination for these conditions is 500 lx.

Visual tasks requiring greater illumination should be supplied with light by workshop place-orientated general lighting or by local lamps.

In heavy industry halls fluorescent lamps or high-pressure discharge lamps are used according to the height of the hall and the demands made on colour rendition. Halls of more than 6 m in height are illuminated by downlighters or broad-beam spotlights equipped with high-pressure mercury vapour lamps.

A special branch of industry within the metal-working sector are the foundries. The lighting problems to be solved here are mostly due to the dark working material such as moulding sand, cast members, black iron, etc. In addition, the room limiting surfaces are exposed to much dust and soil, so that the reflection conditions on walls and ceiling are poor. The visual task in this field of production consists in the recognition of the negative model contours in the moulds.

A useful illumination of these industrial rooms can be supplied by a general lighting in connection with downlighters the illuminations being between 150 and 200 lx.

The illumination of such rooms shall provide a good local evenness in order to reduce the risk of accidents.

Additional local lamps are required where certain operations at work benches or the manufacture of complicated cores need a better lighting level.

In foundries and similar works high-pressure mercury vapour lamps with clear glass bulbs and high-pressure sodium vapour lamps have proved good. The advantages of this kind of lighting consist, above all, in an increase in visual acuity by intensified contrasts.

Similar conditions are to be found in smelting plants, rolling mills and others. Especially in rolling mills monochromatic light is used for examining the rolling material as to its surface quality and for crack detection.

In factory halls of the metal-working industry, where large machines such as presses and shearing machines are installed, the illumination is so much reduced by the shadows thrown by the machines, that in addition to the general lighting local lamps are required for each workshop place. The best solution of this problem is a local lamp built in the machine by the manufacturer of the machine.

Particularly complicated is the planning of lighting installations in motorcar industry. The extensive technological equipment in the form of overhead transportation means, spot-welding units and other technological facilities require close cooperation of lighting engineer and technologist for the planning of the lighting installations.

Often, in this branch of industry, a satisfactory illumination of the workshop place can be achieved only, if workshop place orientated lighting fittings or local lamps are installed.

In many metal-working factories, spray-painting units are necessary. With the lighting of spraying cabins and fully automatic spraying plants in varnishing units each workshop place must be sufficiently and very evenly illuminated according to the respective material to be spray-painted.

10.2.2. Textile Mills

Textile industry is divided into two major branches: mills that produce the thread and those processing the thread. In the thread-producing mills, i.e. in spinning mills and finishing mills such as twisted-yarn mills and dye-works, most of the lighting tasks are solved by a general lighting or by workshop-orientated lighting.

Many modern factories are accommodated in windowless buildings, because the processing of synthetic fibres makes high demands on constant climatic conditions. Therefore, often combined solutions are to be found in these factories, which unite air-conditioning and illumination by using climatic lighting fittings. If the lighting fittings cannot be integrated in the inserted ceilings, it must be considered that in cotton processing mills much dust deposits on the fittings due to fibre flight and that static electrification may easily lead to explosion and fire. For this reason, special lighting fittings for textile mills or dustproof fittings with a reflector opening angle of 60 degrees are used.

The illumination level in the thread-producing and thread-finishing mills is determined by the size of the visual object and the colour of the material to be processed (light or dark). For thread control a workshop place-orientated lighting is the best suitable one.

For colour pattern making in dye-houses special cabins for this purpose are required. Self-contained cabins must be constructed in order to avoid falsification by other light sources.

The illumination level of general lighting in textile mills ranges between 500 and 2000 lx according to the respective colour of material and contrast conditions. Special fabric control which need good contrast effect with a high level of illumination – e.g. for the detection of torn threads or knots that may occur in a piece of material – requires special local lighting. For fabric examination long tables are used on which even very long webs of cloth can be laid out.

The illuminations required for the inspection tables vary between 500 and 2000 lx according to the degree of reflection of the material. The fittings are suspended approximately 1 m above the upper edge of the inclined tables. The incident light provides enough shadows and highlights on the fabric to enable safe detection of possible faults.

10.2.3. Agriculture

Also in agriculture, there is an increasing demand for good illumination. For lighting stables, cowsheds and others mainly directly radiating lighting fittings are used. For rooms painted in white colour or whitewashed medium illuminations of 100 lx are sufficient. In cowsheds of a width up to 6 m the lighting fittings can be placed over the manure way. In cowsheds of several rows about one third of the required lighting fittings are installed above the fodder way. The fittings in the fodder way must be protected against mechanical damaging so that no glass splinters can fall into the fodder.

Milk-processing rooms must be absolutely clean. Since all work in this field is to be done early in the morning or in the evening, there is a permanent need for artificial lighting. Here too, the average lighting level is around 100 lx. In the milking parlours an underground lighting is recommendable.

In piggeries the right lighting of the troughs is of special importance in addition to the general illumination of the pigpen. The recommended illumination for this purpose is approximately 50 lx. In pig sties for brood-pigs the average illumination should be 100 lx. The best place for the lighting fittings is above the middle of the brood stall so that there is sufficient light for assistance and care with littering.

In hen-houses illumination has to fulfill two tasks. On one hand the hen-houses shall be lighted, on the other hand the hens shall be stimulated to lay more eggs. Nearly all houses in intensive poultry farming are nowadays designed as dark space, no matter if the poultry is kept on the floor, in large numbers or in cages. For these hen-houses detailed lighting schedules have been developed which normally provide for an illumination period of 14 hours. Only in exceptional cases it is allowed to prolong this lighting time, for instance if the time of moulting shall be shortened or if young hens shall be stimulated to lay eggs as early as possible. For intensive poultry farming illuminations of 50 lx are sufficient. The light colour should be within the range of 3000 K.

Very good successes were made with the help of the light colour 'warm white' with fluorescent lamps.

In storage rooms, potatoe sheds and other agricultural space an illumination of 50 lx is sufficient. Special attention has to be paid to the lighting of stairs, ladders and hatchways for throwing down goods or materials, because bad sight conditions are especially dangerous in these places.

10.2.4. Summary Hints for Practice

To the above mentioned focal points made in the field of 'industrial lighting' the respective standards and regulations apply to the installation. That means that – irrespective of the mere task of illuminating – the installation of the lighting fittings, cables, leads and accessories now as before is subject to the valid standards concerning the protection and functioning of the entire installation.

10.3. Outdoor Lighting Installations Demonstrated by the Example of Industrial Building

Lighting installations in industrial building comprise the following focal points:

- Production areas
- Storage places
- Inspection lighting as to order and safety
- Outdoor switching stations
- Illumination of railway trackages
- Illumination of building sites

In this paragraph too, it shall be pointed to the problems in connection with special lighting installations on the bases of some of the above mentioned focal points.

It is the task of outdoor lighting installations to create the appropriate visual conditions for working processes such as occur in production, merchandise traffic and traffic in the dark. Also the lighting shall increase the safety of workers and users of the traffic facilities. The best visual conditions for working in the open air are provided by natural light. There are limits to artificial lighting for economical and energy reasons, so that outdoor lighting installations provide visual conditions equal to those of lower daylight level by which the visual qualities of the eye are affected. Favourable lighting conditions in the open can only be achieved if and when combined lighting in the form of a system of general lighting and local lighting is applied.

It is not always possible to take all important aspects into consideration when planning an outdoor lighting installation. Outdoor lighting installations are projected on the basis of nominal illuminations and requirements of evenness. However, the quality characteristics of glare limitation, contrast conditions, light direction and shading have to be observed. The most frequently used lamps in outdoor lighting installations are high–pressure mercury vapour lamps, metal vapour lamps and high–pressure sodium vapour lamps.

With outdoor lighting installations two lighting systems are distinguished:

- Decentral arrangement of the fittings, for example single lighting fittings on lamp poles, and
- central arrangement of the fittings, for example floodlighting towers.

Decentrally arranged lighting fittings are used for illuminating works streets and industrial open–air surfaces. For the latter on condition that technology and geometrical structure allow this solution.

Works road or streets are different from normal roads in so far as they are situated within an enclosed area. They are not open to the public. Sometimes, works roads are directly connected with working places, e.g. unloading stations. The illumination level for works roads is determined by the traffic density to be expected and the paving.

With the illumination of industrial open–air areas by decentrally arranged lighting fittings, place and height of light point of the fittings should be chosen in such way that with view to the visual task the most important quality criteria are observed. According to the respective geometrical conditions and the possibilities of arranging the lighting fittings, following types of lighting fittings are used:

- Fittings mounted on top of lamp poles
- Lighting fittings with rotational symmetrical light distribution
- Lighting fittings with two planes of symmetrical light distribution
- Lighting fittings with one plane of symmetrical light distribution.

The illumination of decentrally arranged lighting fittings can be calculated with sufficient accuracy by the efficiency method. The central lighting system in the form of floodlighting towers has the following advantages:

- Little number of poles
- Possibilities of rapid adaptation of lighting to changed technology by changing the direction of the floodlighting
- Easy maintenance.

The disadvantages of such installations are:

- Little vertical illumination
- Risk of cast shadows due to one-sided light direction
- Higher costs in comparison with decentral lighting systems.

The tower position with floodlighting installations is determined mainly by the territorial conditions and the purpose of use of the area to be illuminated. The number of towers depends on the size of the surface to be illuminated, on the type of floodlight and on the lamp power. With the arrangement of the lighting fittings on the tower and the decision on the height of the tower, special attention has to be paid to the following factors:

- Adherence to the glare protection angle
- Avoidance of irritating cast shadows
- Guarantee of even illumination
- Observance of the maximum floodlight equipment per tower.

For economical reasons, the towers should be placed, if possible, within the area to be illuminated – equipment of the fitting platform on four sides. If, for technological reasons, the tower cannot be put in a central place – for instance with the illumination of a container store frequented by a gantry crane, the towers should be placed as closely as possible to the surface to be illuminated.

When deciding about the place for the floodlighting tower, the conditions of assembly and erecting must also be considered in addition to lighting task. The tower is preferably assembled on the floor or ground and erected with the help of the appropriate erecting and pulling equipment. Consequently, there must be a driving way for the pulling machine. Lamp towers can also be erected by mounting the individual parts of the pole on with the help of a crane.

During the planning phase of the floodlighting installation it should be found out if buildings or other structures are perhaps suitable for bearing the floodlights.

10.3.1. Criteria for Quality Assessment of Outdoor Lighting Installations

- Nominal illumination – these are fixed by standards.
- Shadowyness – formation of cast shadows has to be avoided.
- Local evenness – avoidance of greater differences in luminance within the field of view.
- Glare limitation – avoidance of direct exposure of the eye to the light source.

10.3.2. Production Areas

There is a trend in heavy and chemical industry to shift technological processes from indoor to outdoor space. This leads to new requirements on lighting. The general illumination in production areas shall be at least between 30 and 50 lx. The nominal illumination at the workshop or working place is determined by the visual task and is assessed by the described method. Hazardous points of the technological plant should be pointed to by increased illumination, spotlighting or use of different light colours.

For general lighting, central as well as decentral lighting systems are used central lighting being preferred with large plants.

Local lighting fittings can be stationary or – if they are used only for repair work – mobile. The mobile ones are movable lighting towers, lighting platforms or lighting poles with heights of light point between 6 and 20 m. Stationary working place lighting fittings are fixed on available structures or auxiliary structures. If a combined lighting system is used, the transfer from the illumination of the environment to that of the working place should be made as soft as possible.

This means that the working place lighting fittings must be installed at a greater distance from the place of working than the local lamps at machines and workshop places in indoor rooms. Between the working area and its environment the evenness of lighting should not exceed the ratio of 5:1.

With growing distance from the working place, the illumination may subside to the given values of general lighting. The lighting fittings are chosen according to the purpose of use, mechanical stress, required protective system and aspects of maintenance. As to protection against moisture, outdoor installations must be provided at least with the protective system IPX3. The lighting fittings shall comply with degree of protection I – with protective conductor connection – or with degree of protection II – with protective insulation.

10.3.3. Storage Areas

Storage areas are divided into three types:

- Those with permanent handling during the night
- Those with temporary handling of material at night-time
- Those with occasional handling at night.

Other storage areas where no activities take place during the night are equipped with a control or survey lighting.

With increased requirements on the visual tasks on storage areas or with increased risk of accident, the illumination is intensified by one step, respectively.

The given values of illumination do not only refer to the places where loading and transportation work is done but to the entire storage area. Endeavours should be made to install an additional local lighting immediately on the working zones. For instance, an additional local lighting can be realized by fixing floodlights to the supports of gantry or bridge cranes thus creating a light direction transverse to the direction of motion. Further additional lighting fittings can be fixed also on the crane bridges in order to supply the crane driver with sufficient local lighting. However, these lamp sockets should be provided with a spring-loaded suspension device to absorb the permanent shocks caused by the crane.

With railway goods wagon and container unloading by crane, further additional lighting fittings are required for lighting up shadow zones due to laterally incident light. The problem could be solved by erecting one lighting pole at each crane track, so that the light of the floodlights installed here can fall between the wagon rows. (Pay attention to glare limitation.).

General lighting of storage areas can be realized as central or decentral installation, the trend going to a central arrangement of the lighting fittings for large areas, though.

10.3.4. Building Site Lighting

Also in building industry shift-work is more and more prevailing. As the most significant differences between the working conditions by day and at night the different conditions of lighting must be considered.

The equal requirements on the quality of work by day and night result in certain minimum requirements of the lighting. The designer of lighting installations for building sites has to consider the expenditures that would be necessary to erect the installation and the requirements of the work to be done on the building site as well as safety aspects, protection of health and technical reliability.

In planning lighting installations for building sites the most important quality characteristics have to be observed as it is done with other kinds of lighting installations: sufficient level of illumination, sufficient glare

limitation, sufficient shadowiness and local and temporal evenness.

Standard values for the illumination of building sites are given in Table 36.

Table 36 Service illuminances and uniformity requirements on general and local lighting at building sites

Visual object, operation	General lighting		Combined lighting	
			Local lighting	Portion of general lighting
	(Illuminances indicated in lx)			
Operations with which the majority of the visual objects is up to 2.5 mm big	100	1:3	≤ 500	15
Operations with which the majority of the visual objects is between 2.5 and 10 mm	50	1:5	200	10
Operations with which the majority of the visual objects is between 10 and 25 mm as well as traffic ways within buildings	25	1:5	100	5
Storage areas and handling installations with temporal handling work, temporal stacking work (1)	10	1:5	50	5
Survey lighting	5	1:8	–	–
Inspection lighting without special requirements, only if necessity arises	2	–	–	–

(1) With increased risk of accident, the previous illuminance is applied.

10.3.5. Summary Hints for Practice

As stated under point 10.2.4., the regulations and standards issued by the legislator apply to each respective installation according to the local conditions. In addition to these, regulations for overhead constructions – floodlight towers – have to be observed.

Questions for repetition and knowledge tests

1. What conditions are known in connection with installing a lighting installation?
2. What must be paid special attention to when arranging lighting fittings?
3. How can – despite all difficulties – a good illumination of the working areas be achieved in metal-working industry?
4. In textile industry, orientation to brightness alone is not enough. For what reason?

11. Inspection and Repair of Lighting Installations

11.1. General Remarks

Due to the constantly increasing values of illumination for the various visual tasks, the number of lamps and lighting fittings and the consumption of electric energy are growing too, so that the maintenance of illumination installations becomes more and more important. The discharge lamps, which are preferably used in lighting engineering, have added to the maintenance problem because of their lamp shape, light yield and service life.

The deterioration of the illumination or luminance of a lighting installation is caused by a number of factors, for example:

- Ageing of the lamps (reduction of light flux)
- Premature failure of lamps
- Getting dusty of lamps and fittings
- Contamination of the limiting surfaces of the room with indoor lighting installations
- Changing of the optically effective parts of the lighting fittings.

Further influence is exercised by deviations of voltage as well as adverse ambient temperatures for fluorescent lamp fittings. Most of all, the dust depositing on lamps and lighting fittings contributes to the decrease in illumination or luminance.

11.2. Depreciation Factors

The reduction of the illumination or luminance occurring in the course of operation is expressed in calculations by the depreciation factor (v).

The depreciation factor (v) is the product of the partial depreciation factors (v_1 , v_2 and v_3):

$$v = v_1 \cdot v_2 \cdot v_3$$

For the majority of indoor lighting installations the 'normal' degree of getting dusty is calculated. The degree of 'much' getting dusty is applied mainly to installations in surroundings with much dust generation such as cement plants or in connection with coal.

11.3. Time of Maintenance

Maintenance work at a lighting installation must be done at the latest if and when the maintenance illumination has reached the minimum admissible value. Here the following values apply: Indoor, sports fields and outdoor lighting

$$E''_m = 0.8 E_n$$
$$E''_a = 0.8 E_n$$

Street lighting

$$E''_m = 0.7 E_n$$
$$L''_m = 0.7 L_n.$$

From this follows, that the maintenance of indoor lighting installations has to be done at the latest, if and when the nominal illumination on the illuminated surface has lowered to the value of 0.8 E_n , with street lighting installations to the value of 0.7 E_n . The right time for maintenance is found out by regular measurements of the illumination at fixed control measuring points, at least every half year.

11.4. Carrying out of Maintenance

The regulations on maintenance on the basis of permissible minimum operating values in the form of the maintenance illumination obliges the user to provide for the measuring of the illumination at regular intervals. In this connection, it is recommendable to work out a maintenance schedule which should include the following details:

- Position of the control measuring points
- Time of the control measurements
- Lamp replacement
- Cleaning of lamps and lighting fittings

- Renovation of the rooms
- Replacement of optically effective parts of lighting fittings.

The main maintenance times at a lighting installation are the replacement of lamps and the cleaning and – according to the respective kind of lighting installation – the replacement of optically effective parts of fittings. The replacement of lamps can be done in the form of replacing single lamps or groups of lamps.

Replacement of single lamps

With single lamp replacement, each lamp is replaced immediately after failure. On the one hand, this method is very troublesome and hardly justifiable with larger installations. On the other hand, there are always lamps of very different age in one installation as a consequence of this method, which may result in disturbing effects with indoor lighting installations due to different light colours and luminance values of the lamps. Single lamps should be replaced only in rooms with a low number of lamps or if the failure of a lamp of a great luminous flux would cause a considerable drop of illumination.

Replacement of groups of lamps

In many countries, the replacement of groups of lamps has proved good. Group replacement means, that after a definite period of time all lamps of one lighting installation are replaced by new ones, irrespective of the number of lamps that would still be serviceable. This method of lamp replacement is followed mainly with fluorescent lamps and high–pressure mercury vapour lamps. The replacement of all lamps of a lighting installation by fresh ones complies with economical findings in the field of lighting engineering. The lamps which are exchanged despite that they are still usable have in any case only a little portion of their original light flux left due to age and dust, so that their further use would be uneconomical during the last part of their total service life. Among others, group replacement has the following advantages as to economy and lighting engineering:

- Better effective power of the lamps – higher lighting level with the same energy costs.
- More accurate planning of the costs for the fresh lamps.
- Better appearance of the lighting installation.
- Better working atmosphere.
- Uniform light colour and luminance of the lamps.
- Simultaneous carrying out of cleaning of the lighting fittings.
- Less maintenance work.

From the economical point of view, the best time for the group replacement of lamps is at approximately 80% of the average service life of the lamps, because later the light flux drop and increasing number of failures would have an unfavourable bearing on the illumination level.

With lamps of little switching frequency or in permanent operation the time of lamp replacement can be postponed to 100% of their service life.

In addition to the group replacement schedule the lighting installation should be checked after approximately 800 to 1000 hours of operation in order to replace the lamps that have prematurely failed individually.

On the occasion of group replacement of lamps the lighting fittings should be cleaned.

Complex replacement

Often, the complex replacement of high–pressure mercury vapour lamps and the lighting fittings reflectors and/or protective glasses as optically effective parts of the fitting represent the main part of regular maintenance in street lighting.

The time of this is determined by the reflector behaviour and the service life of the lamp. So, complex replacement is done preferably at intervals of three years. For example: high–pressure mercury vapour lamps of 80 to 400 W and a service life of 12000 h are replaced after three years of operation.

In addition to this, a reflector replacement after 1.5 years is considered as optimal. This method of lamp and reflector replacement is very effective in improving the level of illumination and must be approved especially from the economical point of view.

11.5. Cleaning

The decisive factor in the decrease of illumination is the dust that deposits on lamps and lighting fittings. According to the local conditions and the kind of lighting fittings used the illumination can decrease up to 60% within one year due to the deposition of dust. Taking the corrosion of fitting components into consideration, the values with outdoor lighting components installations may be still worse.

It is understandable that freely radiating lamps or luminous rows or lighting fittings of the light distribution 'uniform' count among the most contaminated ones. Reflector fittings or enclosed lighting fittings suffer only little from dust deposition. Regular cleaning is of technical and economical importance. Indoor lighting installations of a normal degree of getting dusty should be cleaned twice a year, for installations with very little dust deposition one cleaning per year is sufficient: With outdoor lighting installations in most cases one cleaning per year is carried out in the course of which – in case of much reflector corrosion – the reflectors of the lighting fittings must perhaps be replaced.

11.6. Auxiliary means for Maintenance

Effective maintenance requires the appropriate auxiliary means.

Maintenance equipment and devices

For maintaining indoor lighting installations, a number of devices and equipment, e.g. bridge crane are used. Devices and equipment for maintenance work should meet the following requirements:

- little floor area
- large working platform
- light-weight construction
- adjustable height
- mobility.

Shall the maintenance work be done from a bridge crane, special safety measures have to be observed. The bridge crane is allowed to be used for maintenance work at lighting installations only, if there is a secured gangway along the crane track providing an escape-route in danger.

All this shows that in the projecting phase already the future maintenance is determined. The kind of lighting fittings as well as their arrangement must guarantee the user unhindered maintenance.

For outdoor lighting installations, especially for street lighting, a number of vehicles is available equipped with ladders and/or with a universal mounting tower.

11.7. Hints for Practice

On principle, maintenance work is allowed to be done only at a dead installation.

The work should be done by two people.

It is recommendable to take the lamps out of the fitting for purposes of maintenance. The lamps are cleaned best by two sponges – one for washing, one for rinsing.

The lamp sockets can be cleaned by a brush. With aluminium parts strongly alkaline agents should be avoided. For glass and enamel only non-grinding cleaning agents must be used.

For plastic parts, normal household cleaning agents will do; yet they will not produce an antistatic effect. Washable plastic surfaces dry in the air; in no case they must be rubbed dry, because by this they would charge up statically. After cleaning it is recommended to apply an antistatic coating.

Questions for repetition and knowledge tests

1. What are the reasons for the increasing importance of maintenance of lighting installations?
2. By what criteria is the maintenance work scheduled?
3. What are the most important devices used in maintenance?
4. What is understood by 'complex replacement'?

12. Answers to the Questions for Repetition and Knowledge Tests

Cp. Section 1

1. The lighting installations include: lighting fittings, light sources, accessories for both, if required. The installation wiring consists of plastic cables, electric lines with appertaining connection material, switching devices, junction boxes, etc. Reflecting surfaces are included in the design of the installation.
2. The light colour with its specific colour temperature, the design of the lighting fittings and an aesthetic installation reach the emotions of man. With the help of coloured light, for example, one can give or spoil a person's appetite or stimulate or restrain the desire for communication. Light can exercise a decisive influence on the labour productivity.

Cp. Section 2

1. This designation stands for the real light power of a light source. The indication of electric power in watt used hitherto allows no accurate statement on the actual light power or efficiency.
2. The efficiency factor of illumination consists of the illuminator efficiency and the room utilization factor. The efficiency of a fitting indicates in per cent how much light emitted by the light source is absorbed by the fitting. The room utilization factor comprises the ceiling and wall reflections as well as the room conditions and proportions.
3. Colour temperature, light intensity, absence of glare, richness in contrasts, shadowyness.

Cp. Section 3

1. Indoor lighting: For general lighting with uniform illumination on the measuring level the luminous flux or efficiency method is sufficient. For local lighting the light intensity method can be applied with rotational symmetrical lighting fittings. Outdoor lighting: Illumination method.
2. The shielded or unshielded light source shows different deposition of dust. Getting dusty leads to the reduction of the yield of luminous flux. Direct or indirect lighting is different in irradiation as to the visual object. An extremely unfavourable variant would be an indirect illumination with a dirty–grey ceiling.
3. It informs about the emission capacity of the lighting fitting under various angles. It is related to a luminous flux of 1000 1m and must be expressed in terms of the respective light source power.
4. According to a grid system, the illuminations in a room are measured or calculated and the results entered in the crossings of the grid system. If the various points are connected, a mountain–like figure appears.

Cp. Section 4

1. On the basis of selenium photo–cells.
2. Illumination measuring, luminance measuring.

Cp. Section 5

1. The main groups are: A) Temperature radiators and

B) Discharge lamps.

Subgroups are:

A) General-purpose lamps

Functional lamps, decorative lamps,

tube-shaped lamps,
projection lamps,

tungsten-halogen lamps

B) Low-pressure lamps

High-pressure lamps.

2. Rod shape: 16, 26, 32 and 38 mm diameter, with power rates of 3, 13, 20, 40 and 65 W.

U-shape: 26 and 38 mm in diameter, power rates of 40 and 65 W.

Ring-shape: 29 and 32 mm in diameter, power rates of 40 and 65 W.

Twin-tube form: Individual tube diameter 13 mm, power rates of 5 to 36 W.

3. By starter, timer switch (1 to 4 seconds), electrical starter, electrical start and serve unit.

By ignition strip at the lamp tube and quick-start switching, also with single-pin cap.

4. Separate switching (classic method), tandem switching (two lamps – one series reactor), dual lamp circuit (two lamps –two series reactors but one capacitive branch and one inductive branch).

5. It serves to provide a sufficiently high ignition voltage during the ignition process and to limit the current during operation.

6. Best penetration of fog and mist, long effective burning life, use in outdoor lighting installations possible without problems.

7. Quartz glass bulb (burner) with enclosed auxiliary and main electrodes.

Framework with ignition current-limiting resistors, evacuated internal space.

External bulb clear or coated, mushroom-shaped or ellipsoidal. Base – Edison screw.

8. Almost independent of ambient temperature and therefore ideal for outdoor lighting installations. Long service life; great light output.

A disadvantage is the great sensitivity to mains voltages or network failure for split seconds; long starting time and very long reclosing time after mains disconnection.

9. The lamp does not get enough voltage.

10. Polycrystalline alumina tube (discharge tube) with enclosed electrodes. It contains sodium, mercury and inert gas. The space between discharge tube and external bulb is evacuated Socked E 40.

Cp. Section 6

1. Firstly, by the unmistakable form, the size and the weight resulting therefrom.

Secondly, by its purpose of use.

The series reactor of the fluorescent lamp shall supply a high ignition voltage and, in addition, shall serve for current limitation.

The series reactor of the high–pressure mercury vapour lamp serves for current limitation only.

2. Discharge lamp circuits – due to the series reactors – are inductive consumers. The legislator demands the farthest possible relief of the net from reactive current. Capacitors serve for accumulating inductive reactive current. Now, the wattless power required for the switching can – after having been released by the coil of the series reactor – be stored in the capacitor to a great extent. The net must no longer transport this power.

Cp. Section 8

1. They serve the technical purpose to accommodate the light sources, to bundle their light, to direct it or to disperse it. At the same time, they shall produce an emotional effect. Used in the right way, they help to save valuable electric energy.

2. Fittings for general lighting (indoor)

Local lamps

Fittings protected against fire–damp and explosion

Outdoor lighting fittings

Street lighting fixtures

Outdoor lighting fittings for decoration purposes

Floodlights and spot–lights

Domestic lighting fittings and those for decoration

Special lighting fittings.

3. Little energy consumption with a maximum light output.

Little space requirement, adjustable.

Decorative design, easy maintenance.

Mobile, easy to operate.

Cp. Section 9

1. Light advertisement using high–voltage luminescent tubes and high–voltage fluorescent tubes.

2. Leak transformers are used.

There are two circuit variants:

1. Supply of a writing by a transformer.
2. Supply of a writing by letter transformers.

3. Flashing switchings over controller drums.

Program switchings over controller drums.

Running writing Swelling–light installations over actuating mechanisms.

Cp. Section 10

1. Physical, chemical, climatic, technical and aesthetic conditions.

2. Heat accumulation has to be avoided! Mounting at or on easily inflammable materials is not allowed.

With use of spot–lights or floodlights, the focal point which is situated away from the fittings must not be brought near inflammable materials.

When suspending the fittings, their weight must be carefully considered.

3. By combining general lighting installations with local lamps. The chief stress is put on the local (working place) lamps.

4. In places where colours are part of the visual task, for instance with colour patterns, light sources must be used which do not falsify the colours. Mixed light has proved good.

Cp. Section 11

1. Lighting installations need regular cleaning of the lighting fittings and light sources as well as timely replacement of used up lamps and defective accessories in order to maintain their efficiency. The expenditure of time and material increases, if the lamp are not replaced in due course.

2. There are schedules for this purpose. Mainly, planned stoppage times are used for maintenance of the lighting installation.

3. Lifting platforms, step-ladders, derrick wagons.

4. Light sources are replaced at definite intervals.

A three-years rhythm has proved good. Independent of the condition of the lamps, all lamps are replaced by new ones. By this, the illumination level is raised and the energy consumption reduced, simultaneously.

