






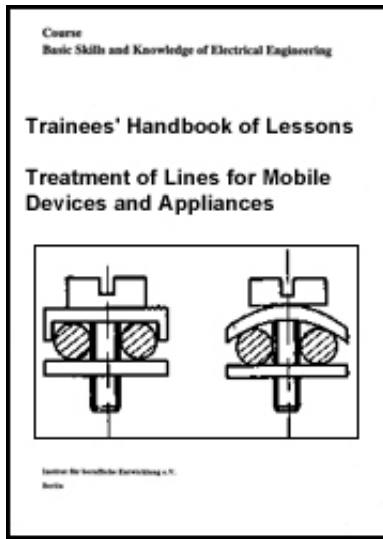
 **Treatment of Lines for Mobile Devices and Appliances - Course: Basic skills and knowledge of electrical engineering. Trainees' handbook of lessons (Institut für Berufliche Entwicklung, 21 p.)**

 **(introduction...)**






 **Introduction**

-  **1. Elementary Knowledge of the Connection of Lines for Mobile Devices and Appliances and their Use**
- 2. Treatment of Lines for Mobile Devices and Appliances**
  -  **2.1. Removing of Insulations**
  -  **2.2. Preparation of the Conductors for Further Processing**
- 3. Connection of Lines to Mobile Devices and Appliances**
  -  **3.1. Making of Screw Fastenings**
  -  **3.2. Tension Relieving**
  -  **3.3. Principle Regulations for Plug-in Devices**
  -  **3.4. Combining of Mobile Lines to Bank Cables in Plants and Devices**





**Course: Basic skills and knowledge of electrical engineering. Trainees' handbook of lessons (Institut für Berufliche Entwicklung, 21 p.)**

- ➔  **(introduction...)**
-  **Introduction**
-  **1. Elementary Knowledge of the Connection of Lines for Mobile Devices and Appliances and their Use**
-  **2. Treatment of Lines for Mobile Devices and Appliances**
-  **3. Connection of Lines to Mobile Devices and Appliances**

**Institut für berufliche Entwicklung e.V.  
Berlin**

**Original title:  
Arbeitsmaterial für den Lernenden  
"Bearbeiten von Leitungen für ortsveränderliche Betriebsmittel"**

**Author: Gerhard Klix**

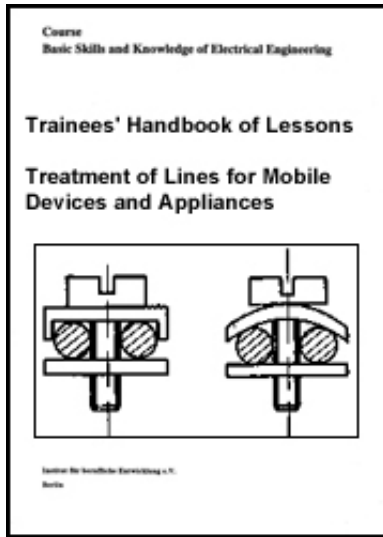
**First Edition © IBE**


**Institut für berufliche Entwicklung e.V.  
Parkstraße 23  
13187 Berlin**

**Order No.: 91-35-3106/2**






[Home](#) > [ar](#).[cn](#).[de](#).[en](#).[es](#).[fr](#).[id](#).[it](#).[ph](#).[po](#).[ru](#).[sw](#)



 **Treatment of Lines for Mobile Devices and Appliances - Course: Basic skills and knowledge of electrical engineering. Trainees' handbook of lessons (Institut für Berufliche Entwicklung, 21 p.)**

 **(introduction...)**

  **Introduction**

-  **1. Elementary Knowledge of the Connection of Lines for Mobile Devices and Appliances and their Use**
-  **2. Treatment of Lines for Mobile Devices and Appliances**
-  **3. Connection of Lines to Mobile Devices and Appliances**

## Introduction

**The present handbook is a studying aid for trainees in the field of electrical engineering.**

**It describes the operations and auxiliary means required for the treatment of lines for mobile devices and appliances.**

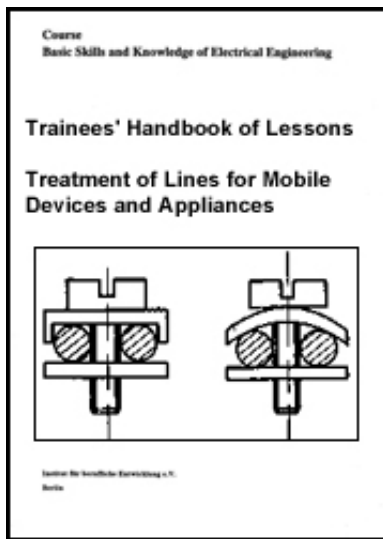
**The required methods are explained in individual sections. The required knowledge and skills are described in the order of the necessary operations in each paragraph. The included illustrations promote the understanding of the text**


**and add to the contents of the individual sections.**

**In support of the process of learning, questions are included for the trainers to test their knowledge.**



[Home](#) > [ar](#).[cn](#).[de](#).[en](#).[es](#).[fr](#).[id](#).[it](#).[ph](#).[po](#).[ru](#).[sw](#)



 **Treatment of Lines for Mobile Devices and Appliances - Course: Basic skills and knowledge of electrical engineering. Trainees' handbook of lessons (Institut für Berufliche Entwicklung, 21 p.)**

 **(introduction...)**

 **Introduction**

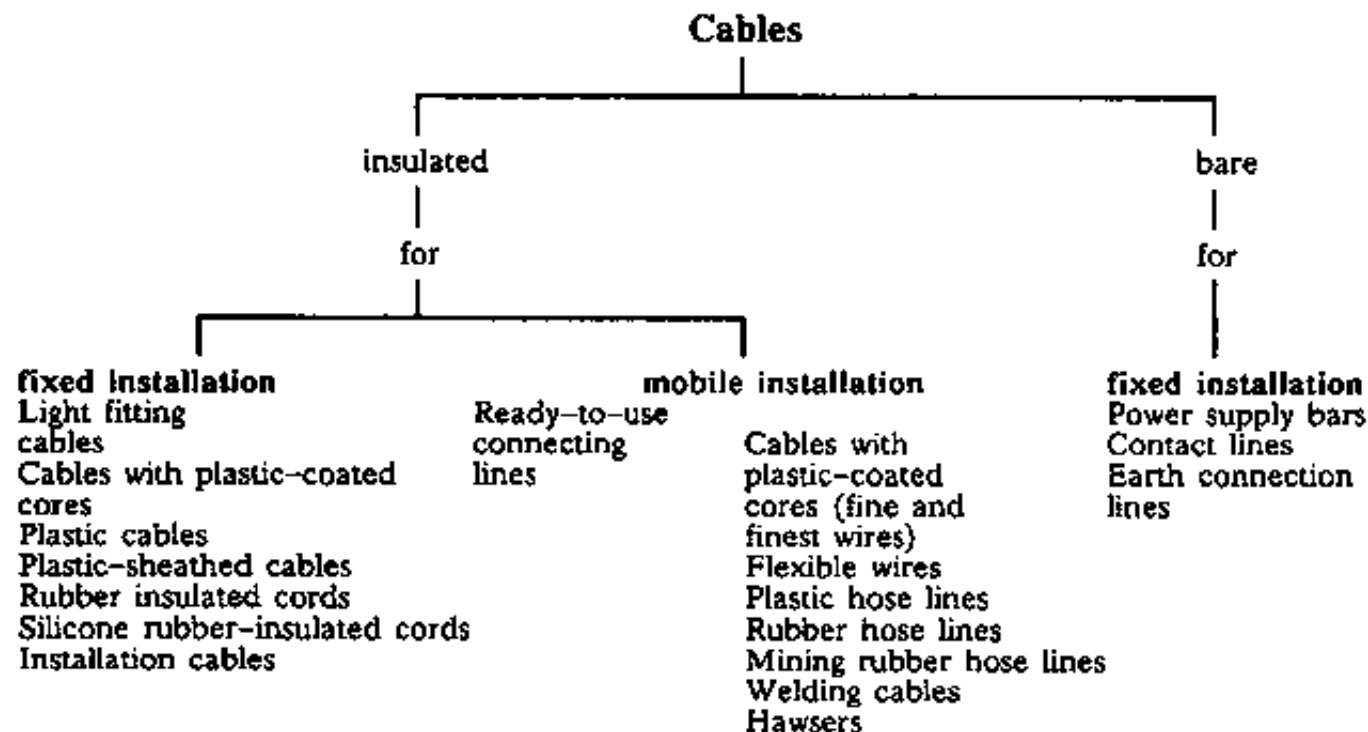
-  **1. Elementary Knowledge of the Connection of Lines for Mobile Devices and Appliances and their Use**
- 2. Treatment of Lines for Mobile Devices and Appliances**
- 3. Connection of Lines to Mobile Devices and Appliances**

## **1. Elementary Knowledge of the Connection of Lines for Mobile Devices and Appliances and their Use**

**Mobile service equipment such as devices and appliances are used in all fields of economy, production and everyday life.**

**They are connected to the electric mains by reusable cables, which are not fixed**

**such as extension cords, mobile multi-way connectors, flexible cables and so on.**



### *Survey of cables*

#### **Insulated cables**

- **Conductors are fitted with a plastic or rubber insulation (core insulation).**
- **Several conductors are twisted and covered by a common sheath (sheath insulation).**

#### **Bare cables**

- **Uninsulated conductors**

## Cables for mobile installation

- Flexible (mobile) insulated cables.

## Lines for permanent installation

- Lines are fixed - permanent installation.

## Characteristics of lines for mobile installation

- Material of conductor Cu
- Conductor
  - . fine wire
  - . finest wire
- Core and sheath insulations flexible.
- Line is designed for repeated use,

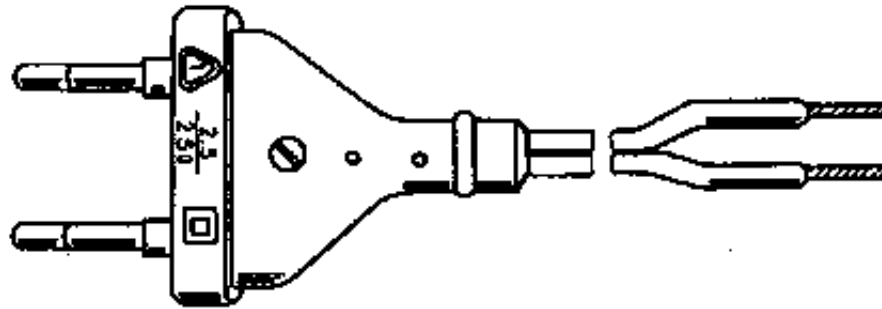
**What is the difference between cables to be connected to mobile equipment and those for permanent installation?**

---

## Examples of use of the lines for mobile devices and appliances

Kind of line		Room		In the open	Use
	dry	moist	wet		

	dry	moist	wet		
Light plastic hose cables	+	+	+		Lighting fittings, extension cables, refrigerators
Light rubber hose cables	+				Light heat appliances, irons, electric heat pads, extension cables
Medium plastic hose cables	+	+	+		Hand drills, industrial refrigerators, light X-ray units, office machines
Strong rubber hose cables	+	+	+	+	Construction equipment, machine tools



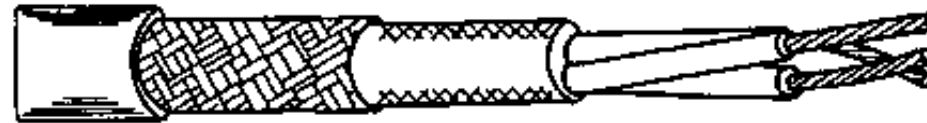
**Figure 1 Light plastic hose cable (ready-made cable)**



**Figure 2 Light rubber hose cable (ready-made cable)**



**Figure 3 Light rubber hose cable with yarn wrapping (ready-made cable)**



**Figure 4 Medium-size rubber hose cable (covered)**



**Figure 5 Strong rubber hose cable**

**On what criteria does the selection and use depend of cables to be connected to mobile equipment?**

---

**Plastic hose cables are allowed to be used for electric heat appliances only if it is absolutely impossible that the cable gets in touch with parts of the device that may be heated up to more than 85° Celsius.**

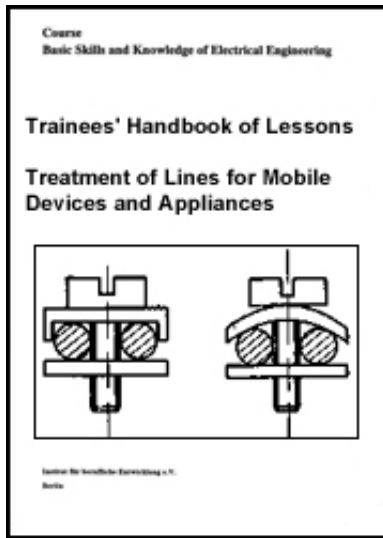
**For electric devices or appliances with plastic case no rubber hose cables must be used! Rubber contains an age-protecting agent, which passes over**





**into the plastic material when it gets in contact with it and discolours it under the effect of light.**



[Home](#) > [ar](#).[cn](#).[de](#).[en](#).[es](#).[fr](#).[id](#).[it](#).[ph](#).[po](#).[ru](#).[sw](#)



 **Treatment of Lines for Mobile Devices and Appliances - Course: Basic skills and knowledge of electrical engineering. Trainees' handbook of lessons (Institut für Berufliche Entwicklung, 21 p.)**

- ➔  **2. Treatment of Lines for Mobile Devices and Appliances**
  -  **2.1. Removing of Insulations**
  -  **2.2. Preparation of the Conductors for Further Processing**

**Treatment of Lines for Mobile Devices and Appliances - Course: Basic skills and knowledge of electrical engineering. Trainees' handbook of lessons (Institut für Berufliche Entwicklung, 21 p.)**

## **2. Treatment of Lines for Mobile Devices and Appliances**

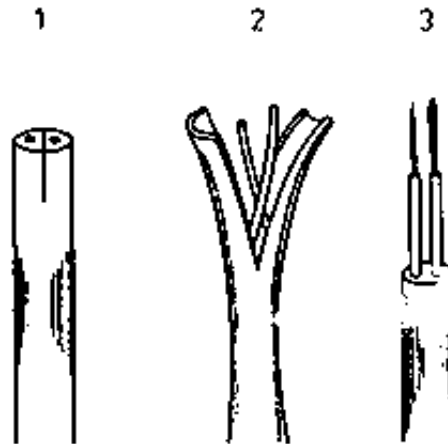
### **2.1. Removing of Insulations**

**For removing the insulation, the following tools may be used as auxiliary means:**

- **Cable strippers**
- **Automatic deinsulating tongs**
- **Thermal deinsulating device**
- **Deinsulating fixtures**

## Removing the sheath insulation

- **Cutting the rubber sheath in between the cores until it can be taken hold of by hand.**
- **Ripping the rubber sheath apart up to the given measure.**
- **Cutting the sheath insulation carefully all around.**



**Figure 6 Stripping of a light rubber hose cable**

- 1 notching the rubber coating between the cores,***
- 2 thearing the rubber sheath apart,***
- 3 cutting off the sheath insulation carefully***

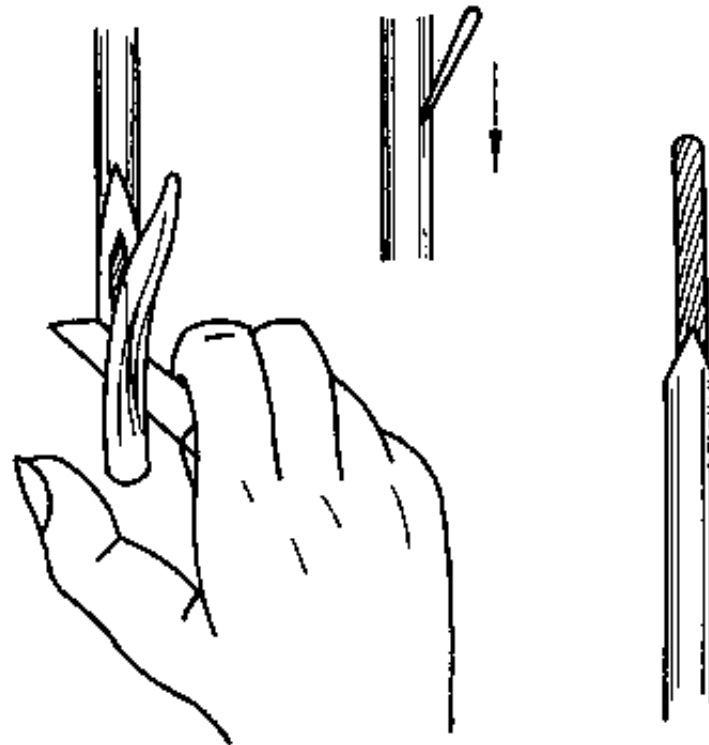
**Make sure that the core insulation is not cut when removing the sheath**

## insulation!

### Removing the core insulation

#### - By the cable stripper

- . Cutting off one half of the insulation by a longitudinal cut by the knife (stripping off).
- . Cutting off the second half by a longitudinal cut, too.



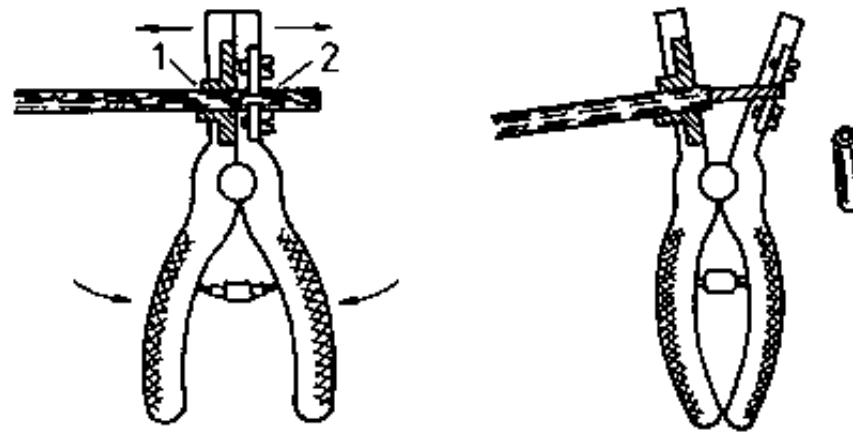
**Figure 7 Stripping the core insulation by the electrician's knife**

**Pay attention to the correct handling of the knife, because the fine-wire conductor**

**might be damaged by a wrong touch of the knife and break in the course of further working.**

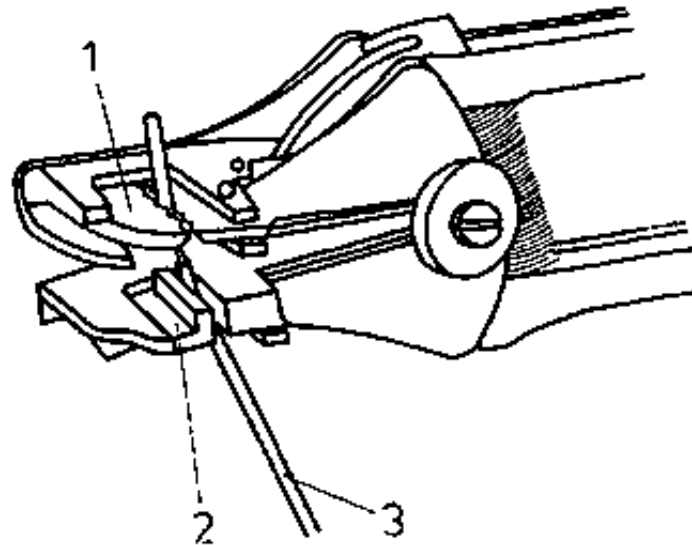
**- By the deinsulating tongs**

- . With movable deinsulating edges, these are adapted to the cross-section of the conductor.**
- . The conductor is put into the pair of jaws of the deinsulating tongs and the tongs are actuated.**



**Figure 8 Stripping the core insulation off with the help of the wire strippers**

***1 clamping jaw,  
2 stripping jaw***



**Figure 9 Wire strippers**

***1 cutting edge for various diameters,  
2 clamping jaw,  
3 conductor***

**Do only use the cutting edge assigned to the cross-section of the conductor and marked accordingly. Conductor cross-sections exceeding 6 mm<sup>2</sup> are deinsulated by the cable stripper.**

**By the thermal deinsulating device**

- Switching the device on.**
- Cleaning the resistance wire curl.**
- Selection of temperature. (Core insulation must only melt, not burn.)**
- Removing the core insulation by the deinsulating handle of the device.**

## **- Switching the device off and pulling the plug after use.**

**The core insulation of heat-proof silicone and rubber-covered cables is not removed by thermal deinsulating devices due to their heat resistance and the strong smell that would develop.**

**Make sure that the ends of the conductors are always cleanly deinsulated. The conductor must neither show rests of the insulation nor indentations.**

### **Removal of yarn wrappings from cables**

- Cutting the yarn wrapping open.**
- Prevent the yarn wrapping from undoing by ligaturing.**
- Cutting the yarn wrapping open and removing it.**
- Proceed as described above.**

## **2.2. Preparation of the Conductors for Further Processing**

**Why must mobile cables get a special treatment before being connected?**

---

**What operations have to be done before the cable is connected?**

---

**For**

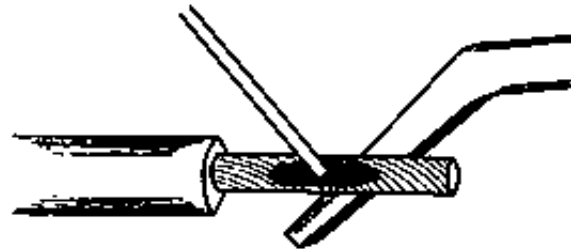
- **cleaning the conductor**
- **tinning the conductor**
- **soldering on of cable eyes**
- **pressing on of cable eyes**

**the handbook of "Making Permanent Joints" should be used.**

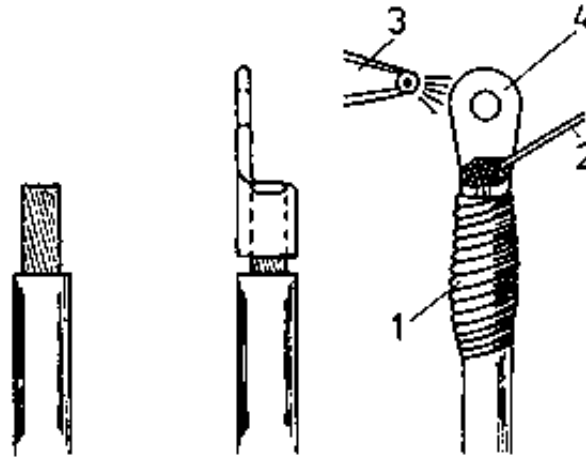
**After cleaning - also of the internal layers - the end of the conductor must be accurately retwisted clockwise.**

**Tinning of cables and the use of sweating thimbles has to be avoided to the farrest possible extent.**

**These methods should be applied only in special cases, for instance if and when eyes must be bent or pressing cable thimbles cannot be used.**

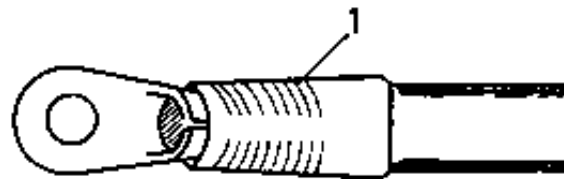


**Figure 10 Tinning of a conductor**



**Figure 11 Soldering of a cable eye**

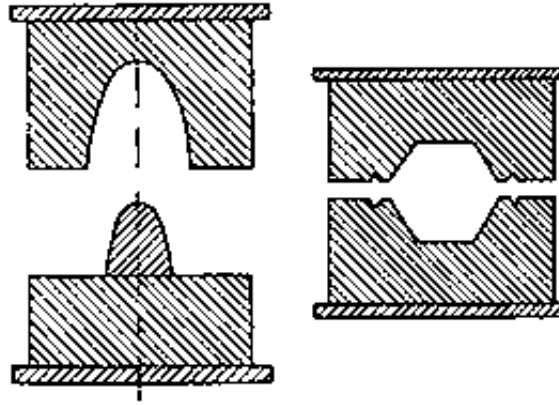
**1 fire-resistant wrapping,  
2 tin-base solder,  
3 nozzle of the sounder,  
4 cable eye**



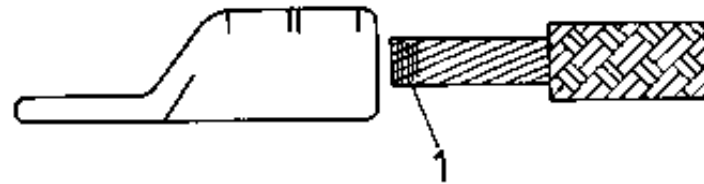
**Figure 12 Cable eye soldered on**

**1 plastic hose or tape**



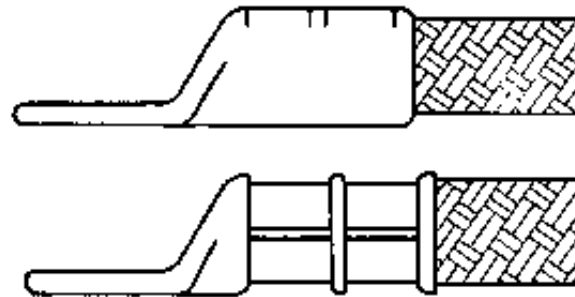


**Figure 13 Pressing inserts for V-shaped grooving or hexagonal pressing**

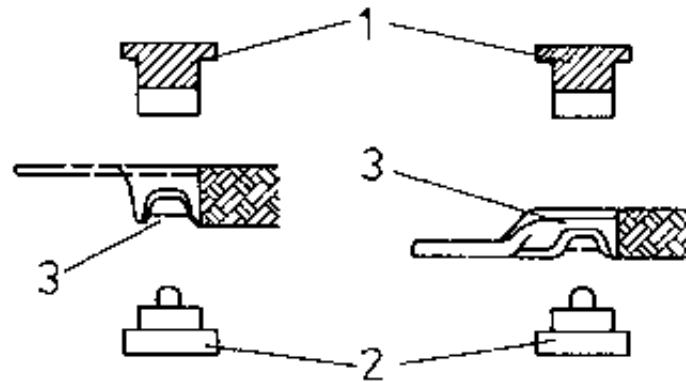


**Figure 14 Putting a shaped conductor into the cable eye**

***1 binding for aerial line***



**Figure 15 Cable eye before and after the pressing operation**



**Figure 16 Making the V-shaped grooving at the top and bottom side of the cable eye**

***1 top pressing insert,***

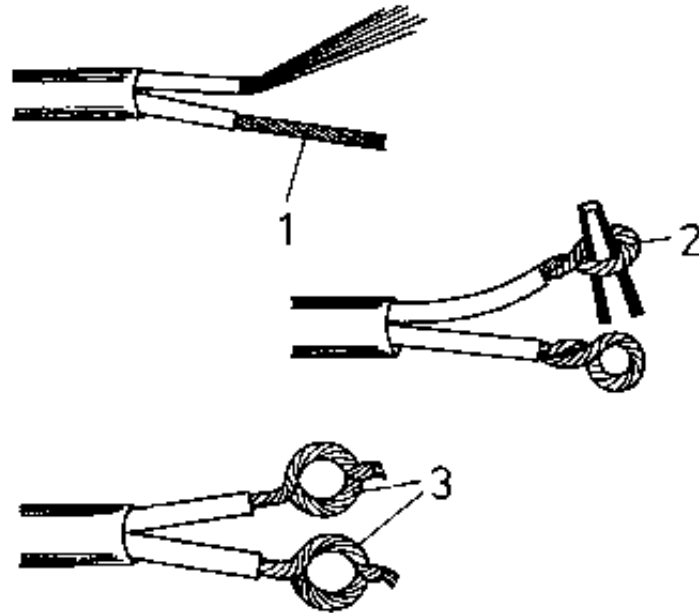
***2 bottom side pressing insert,***

***3 V-shaped grooving (left: D-shape, right: C-shape of the cable eye)***

### **Bending of eyes**

- **Twisting of the cleaned appropriately prepared core.**
- **Bending the eye with the help of an arbor or round-nose pliers. or**
- **Dividing the conductor and twisting it separately.**
- **Putting it around an arbor from both sides and joining the two ends by twisting them together.**

**When bending eyes, make sure that the internal diameter of the eye is 0.1 to 0.2 mm greater than the diameter of the locking screw or bolt.**



**Figure 17 Bending of eyes**

***1 twisting of the cleaned conductor,  
2 eye bent over an arbor,  
3 completed eyes after the conductor having been divided up and twisted separately***

**After this, the end of the conductor and the eye are tinned by soldering iron tin bath.**

**- If the twisted conductors are tinned first, they have to be shaped to an eye by round-nose pliers afterwards.**

**When tinned in a tin bath, the prepared and flux-coated end of the conductor is dipped into the fluid tin to approximately 3/4 of its lengths.**

**The process of tin-coating is completed, if and when the end of the conductor and the eye have a uniform, tin-covered surface.**

### **Putting on of conductor end sleeves and contact eyes**

- **If not other forms are required, this technique should be preferred.**
- **It can be used with cross-sections up to 16 mm<sup>2</sup>.**

**What are the advantages of this technique compared with tin-coating?**

---

### **Sequence of operations for working conductor end sleeves**

- **The wires are stripped.**
- **The wide end of the sleeve is shoved on the blank end of the conductor.**
- **The end of the conductor together with the conductor end sleeve is put into the clamping fixture.**
- **Clamping by fastening the clamping screw by the required contact pressure.**

### **Special fields of use of conductor end sleeves**

- **At terminal points with two cables, one conductor end sleeve of the appropriate size can be drawn over the two wires.**

- **Circuit bridges which must not be broken when being disconnected can be twisted and provided with a conductor end sleeve.**
- **Conductor of less than 0.75 mm<sup>2</sup> in cross-section are stripped over such length that they can be folded up two or three times and then put into a conductor end sleeve of a corresponding size.**
- **Size conductor end sleeves and contact eyes are not marked, attention must be payed that the conductor cross-sections and the end sleeves are fitting together.**

### **Assignment of conductor end sleeves to the conductor cross-sections**

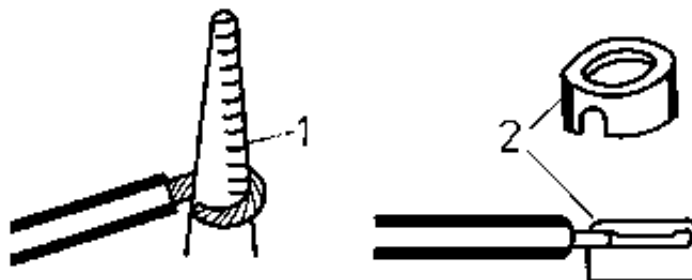
**(Cross-sections indicated in mm<sup>2</sup>, main dimensions and length in mm)**

<b>Conductor cross-section</b>	<b>Conductor end sleeve</b>	<b>Main dimension</b>		<b>Length</b>
		<b>Internal diameter</b>	<b>External diameter</b>	
0.5	1.3	1.3	1.8	12
0.75	1.3	1.3	1.8	12
1.0	1.5	1.5	2.2	12
1.5	1.8	1.8	2.6	12
2.5	2.2	2.2	3.4	12
4.0	2.9	2.9	4.1	12

6.0	3.5	3.5	4.8	16
10.0	4.4	4.4	5.7	16
16.0	5.5	5.5	6.8	16

## Sequence of operations with the use of contact eyes

- **Stripping the wire.**
- **Prebending the stripped conductor over an arbor.**
- **Pressing the contact eye on the prepared conductor.**



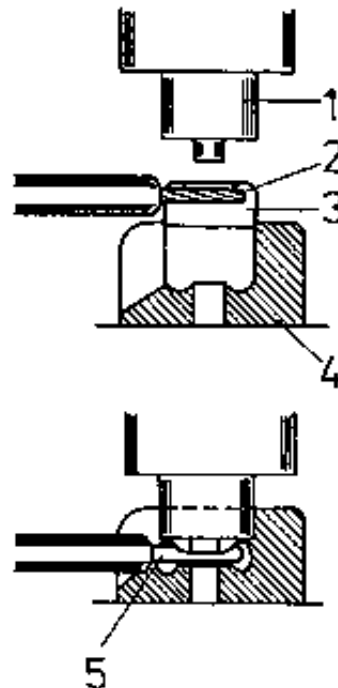
**Figure 18 Prebending of the conductor over an arbor**

### ***1 arbor, 2 contact eye***

- **Putting the conductor with the contact eye in the mould of the pressing device or in the pressing pliers.**

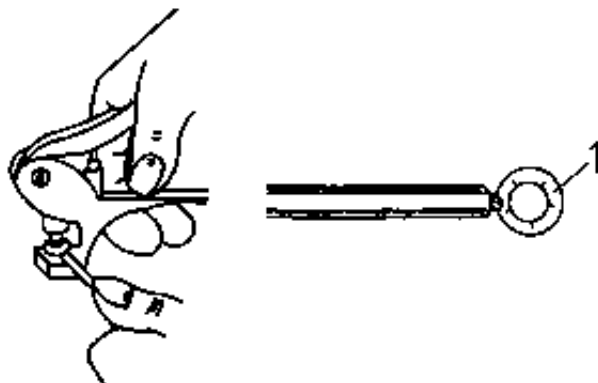
**The conductor must be placed into the slot of the contact eye and in the slot of the matrix of the pressing device.**

- **Pressing on by pressing device or pressing pliers.**



**Figure 19 Principle of the pressing-on of contact eyes**

***1 punch, 2 conductor, 3 contact eye, 4 matrix, 5 contact eye with conductor after having been pressed in the matrix***



**Figure 20 Pressing-on of contact eyes by the pressing tongs**

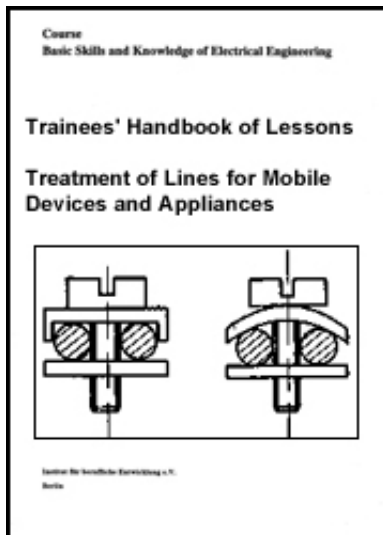
## 1 completed contact eye


All individual wires of the flexible conductor must be held by the sleeve or by the eye.






Why should to cables, which shall be connected to mobile equipment, preferably conductor end sleeves and contact eyes be attached or cable eyes be pressed on?



[Home](#) > [ar.cn.de.en.es.fr.id.it.ph.po.ru.sw](#)



 **Treatment of Lines for Mobile Devices and Appliances - Course: Basic skills and knowledge of electrical engineering. Trainees' handbook of lessons (Institut für Berufliche Entwicklung, 21 p.)**

- ➔  **3. Connection of Lines to Mobile Devices and Appliances**
  -  **3.1. Making of Screw Fastenings**
  -  **3.2. Tension Relieving**
  -  **3.3. Principle Regulations for Plug-in Devices**
  -  **3.4. Combining of Mobile Lines to Bank Cables in Plants and Devices**

**Treatment of Lines for Mobile Devices and Appliances - Course: Basic skills and knowledge of electrical engineering. Trainees' handbook of lessons (Institut für**



## **Berufliche Entwicklung, 21 p.)**

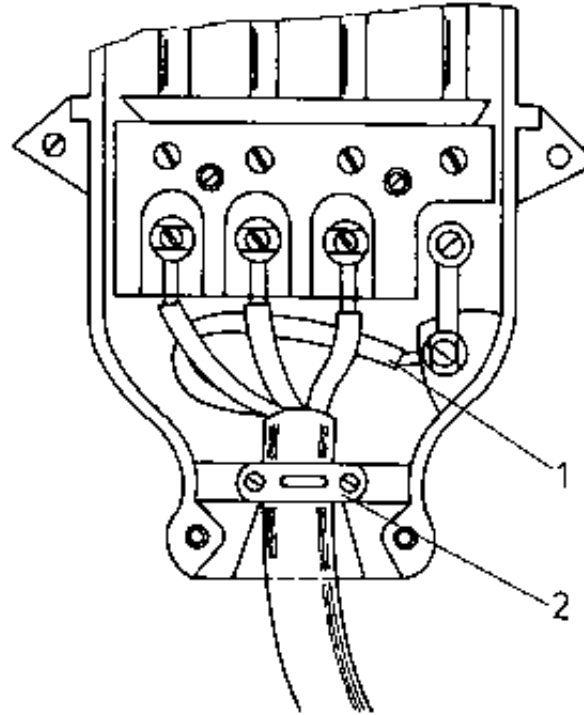
### **3. Connection of Lines to Mobile Devices and Appliances**

#### **3.1. Making of Screw Fastenings**

**- Before a cable is put in and connected to a mobile device or appliance, this cable has to be stripped according to the requirements and prepared for connection.**

**- With the stripping length, the arrangement of the connections in the device or appliance has to be taken into consideration.**

**After putting the cable into the place of connection, a protective measure with protective conductor has to be taken and the external conductors have to be cut in such way that the protective conductor is the longest connecting core.**



**Figure 21 Collar coupler plug**

***1 protective conductor,  
2 tension relieving***

**Why shall the protective conductor be the longest connecting core in the place of connection of the device or appliance?**

---

**- The covering of the cable must project into the device or appliance for approximately 3 mm.**

**By putting in the covered cables, the conductor insulation cannot be**

**damaged by perhaps sharp edges of the device or appliance and sources of faults are avoided.**

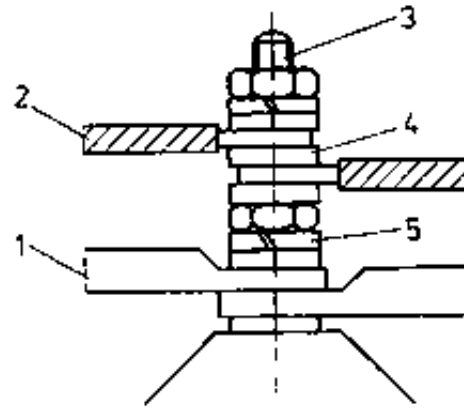
- **The core insulation must end 1 mm in front of the connecting point.**



**Figure 22 Connection points with correctly removed core insulation**

**Securing under terminals of the core insulation would put the functioning of the connection at risk. Too long stripping could lead to short circuits.**

- **Conductors equipped with eyes must only be connected in the direction of rotation of the terminal screw. (In doing so, make sure that the eye rests evenly on the junction block, because otherwise it may come to a deficiency of contact.)**
- **If several conductors are connected to one connecting bolt, pay attention that each conductor is followed by one washer and that - at least after every third conductor - one spring ring is inserted.**
- **If and when cable thimble and eye are connected to one connection bolt, the eye has to be connected separately.**

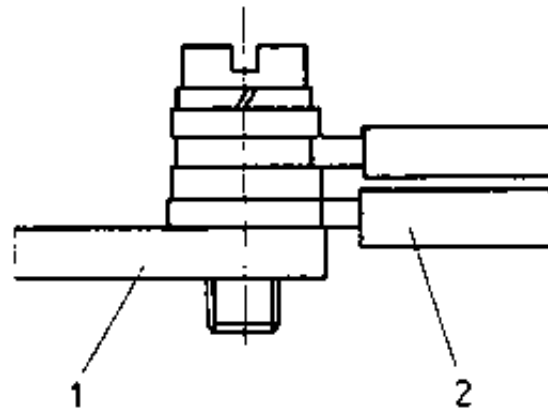


**Figure 23 Connection to a connection bolt**

***1 cable eyes, 2 conductor with eyes, 3 connection bolt, 4 washers, 5 spring ring***

**- With the connection of protective conductor and middle wire, only one conductor per connecting point is permissible.**

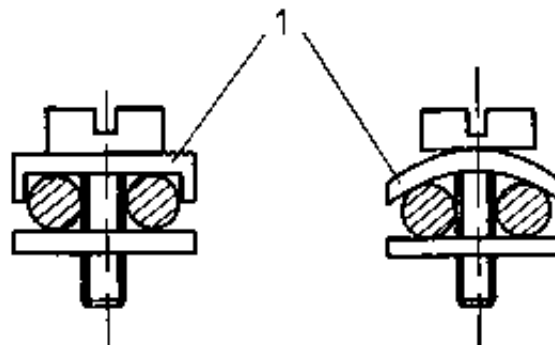
**- To cap-screws without clamping bow or conductor holding fixture, three conductors which may differ by two cross-section steps at the most are allowed to be connected only if one washer is placed between the conductors, each.**



**Figure 24 Connection by a cap-screw without clamping bow and holding fixture to a connection strap**

**1 connection strap,  
2 conductor**

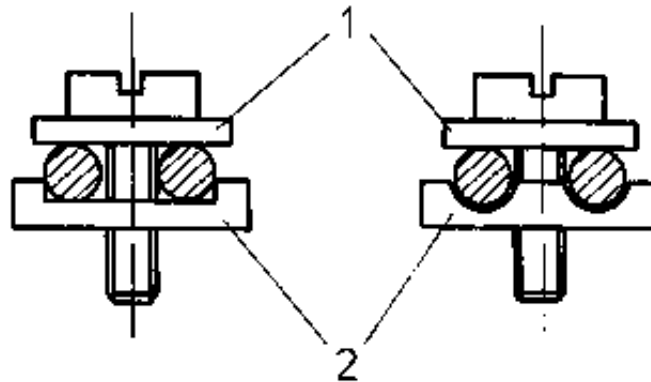
**- To cap-screws with clamping bow only one conductor is allowed to be connected on either side of the bow. The conductors to be connected may differ by one step in cross-section.**



**Figure 25 Connection to a cap-screw with clamping bow**

## ***1 clamping bow***

**- To cap-screws with conductor holding fixtures only one conductor is allowed to be connected to each holding fixture. The conductors to be connected must have the same cross-sections.**



**Figure 26 Connection to cap-screw with holding fixture**

## ***1 free disk, 2 conductor holding fixture***

**The washers used for the connection of conductors to screws or bolts must cover at least 2/3 of the conductor.**

**Screw slots must not be damaged by using wrong or defective screw drivers.**

**- To terminal blocks for sequencing two conductors are allowed to be connected to each terminal point, if they are soldered together at the connecting points and equipped with conductor end sleeves.**

- When connecting conductors with end sleeves or eyes, make sure that**
  - . the clip of each respective contact is sufficiently fastened, so that the conductor cannot the sleeve or eye,**
  - . if the conductor end sleeve might be shifted on the conductor when it is put in the clip - for instance with cables that are put in from above - the sleeve should be slightly pressed on with the help of a suitable tool such as round-nose pliers or side cutting pliers.**

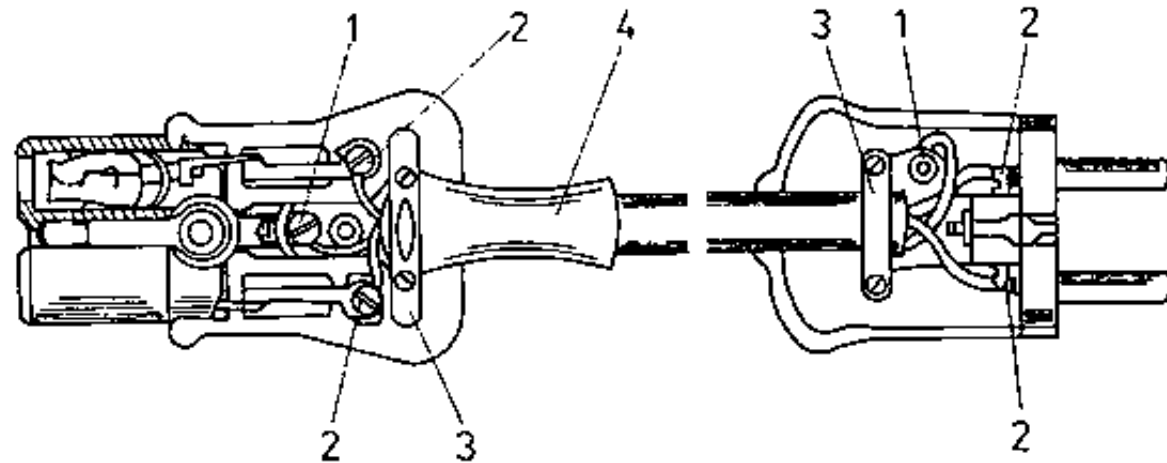
### **3.2. Tension Relieving**

**Why is tension relieving required with mobile devices and appliances?**

---

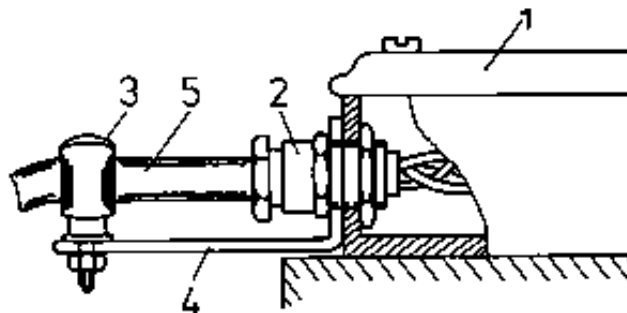
- Tension relieve is possible inside and outside the connection space of mobile equipment.**
- Tension relieve must act immediately on one cable and not on intermediate layers.**
- Mostly, tension relieve consists of one pressure clip with two fastening points. (See Figure 21).**
- If tension relieve cannot be given within the connection space, it must be done outside at the casing or construction part of the device or appliance. However, the protective system of the device or appliance must thereby**

**not be reduced.**



**Figure 27 Tension relieving within the connection space of a protective contact flexible cable**

***1 protective contact connection, 2 external conductor, 3 tension relieving, 4 protection against buckling***

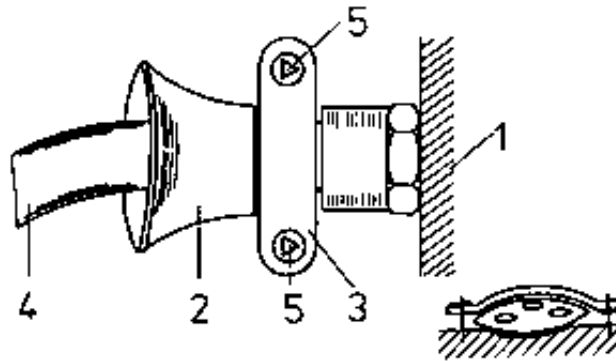


**Figure 28 Tension relieving at an engine cable**

***1 clamping box, 2 cable entry,  
3 tension relieving clip,***



**4 bow for tension relieving,  
5 engine cable**



**Figure 29 Trumpet-shaped entry at an explosion-proof lamp which is mobile to a certain extent**

**1 lamp casing, 2 trumpet-shaped entry, 3 tension relieving clip. 4 supply line, 5 screw with triangular heads**

**What is the importance of protection against buckling at device and/or appliance entries and exits?**

---

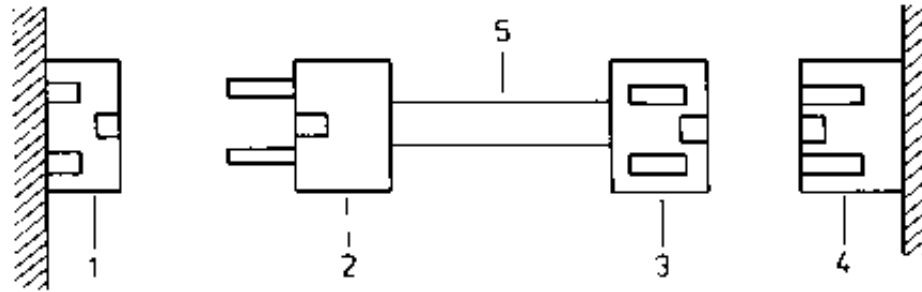
**Boltings which only serve the observance of the protective system or degree of protection of the device or appliance must not be used for tension relieving.**

### **3.3. Principle Regulations for Plug-in Devices**

**- The order of plug and socket and/or coupler socket in the circuit is determined**

**by the direction of the power flow.**

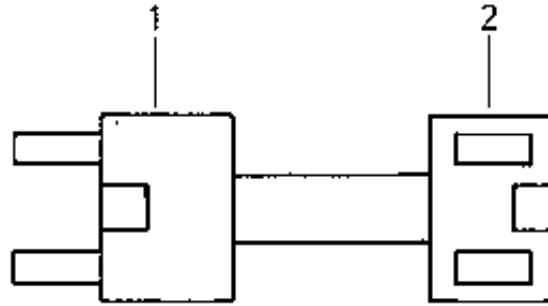
**- Plug and socket and/or coupler socket must be arranged in such a way that, under no circumstances, the plug pins are alive as long as they are not plugged in.**



**Figure 30 Direction of a power flow**

***1 socket, 2 plug, 3 appliance plug-socket, 4 appliance coupler, 5 cable***

- For the supply of a number of devices or appliances fixed multiple sockets with earthing contact or mobile multiple sockets with earthing contact are preferred.**
- It is not permissible to use plug-in devices in connection with lampholders and of free distributing plugs, even with shock protection.**
- To a plug, a coupler socket or an appliance coupler only one mobile cable is allowed to be connected.**



**Figure 31 Correct installation of a mobile appliance connecting cable**

***1 plug, 2 coupling***

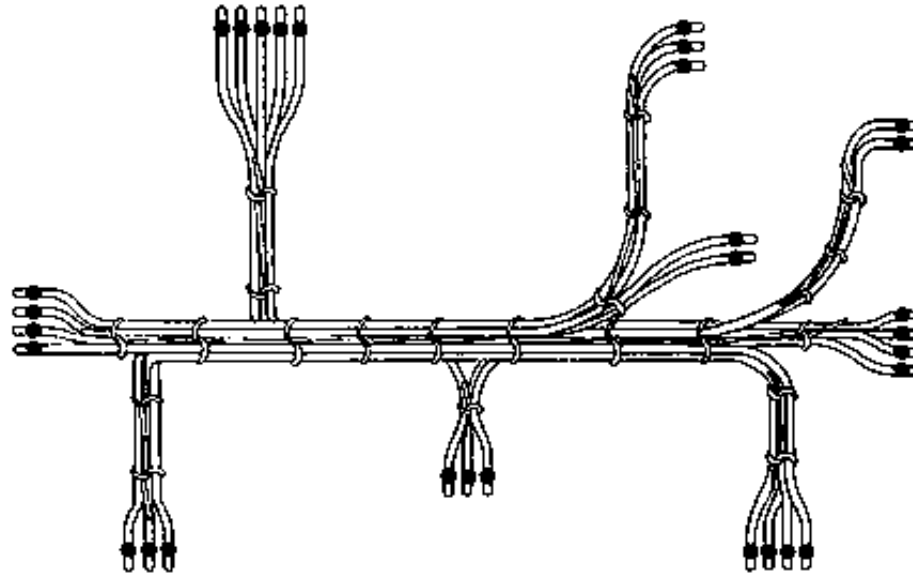
### **3.4. Combining of Mobile Lines to Bank Cables in Plants and Devices**

**In addition to the cables for connecting mobile devices and appliances, there are pilot-wire circuits consisting of multiwire or thin-wire conductors.**

**Especially this is the case in plants which, during operation, are exposed to great mechanical strain and vibration.**

**If in such plants conductors are combined to bank cables, this is called bundled wiring and the manufacture of preformed cables presents itself.**

**In connection with the manufacture of preformed cables also use the handbook of "Manufacture of Preformed Cable".**

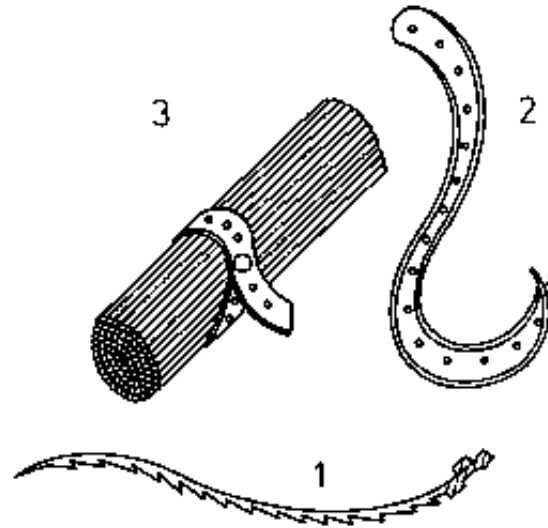


**Figure 32 Manufacture of shaped cables on a matrix**

### **Manufacture of a preformed cable**

- **Manufacturing of a model according to the individual conductor connections.**
- **Testing the cables as to continuity, unwinding them and cutting them to length.**
- **Combining them to bank cables.**

**If possible, use punched tape to tie them up with plastic string or cord.**



**Figure 33 Binding material**

***1 grit tape, 2 punched tape,  
3 binding by punched tape***

**- Fastening of the bank cables in the place where it shall be connected.**

**Access to the connections and free connecting and disconnecting must be guaranteed.**

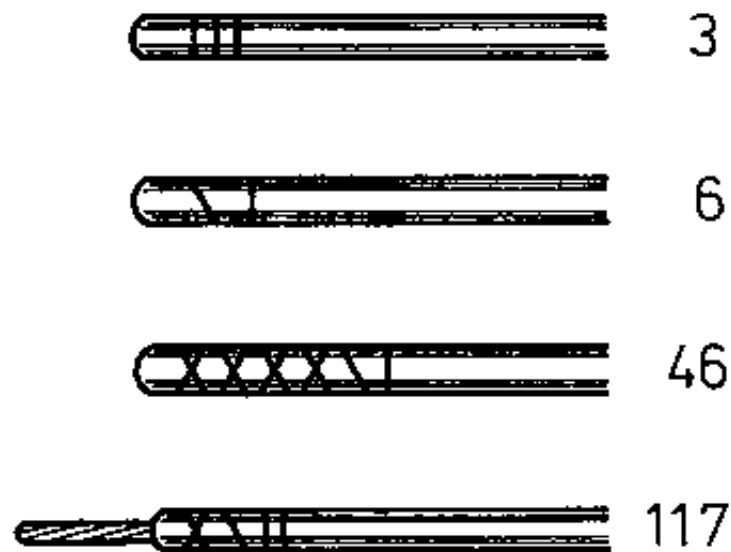
**- Testing and marking of the cables according to their respective purpose.**

**Marking the conductors by notches**

**This is the simplest and safest method of marking conductors.**

**- Suitable tools for notching are electrician's knives and side cutting pliers.**

- **The notches have to be started on the cable cross section at the end of the conductor and are continued away from there.**
- **Roman figures should be used for marking. (A correspondingly stripped piece of conductor is to be seen in Figure 34; it is equivalent to number 100.)**



**Figure 34 Notch marking by Roman figures**

**When notching, make sure that the marking remains legible even after a longer period of time and that also other people are able to read it.**

**What could be the consequences of mixed up connections in a plant?**

---

