

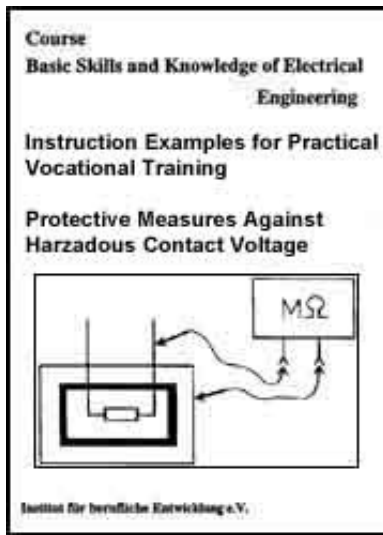





[Home](#) > [ar](#).[cn](#).[de](#).[en](#).[es](#).[fr](#).[id](#).[it](#).[ph](#).[po](#).[ru](#).[sw](#)





 **Protective Measures against Hazardous Contact Voltage - Course: Basic skills and knowledge of electrical engineering. Instruction examples for practical vocational training (Institut für Berufliche Entwicklung, 15 p.)**

-  **(introduction...)**
-  **Introduction**
-  **Instruction Example 4.1. Preparation of a Potential Equalitation**
-  **Instruction Example 4.2. Testing of the Protective Measure of "Protective Insulation"**
-  **Instruction Example 4.3. Testing of the Protective Measure of "Protective Conductor System"**





[Home](#) > [ar](#).[cn](#).[de](#).[en](#).[es](#).[fr](#).[id](#).[it](#).[ph](#).[po](#).[ru](#).[sw](#)

 **Protective Measures against Hazardous Contact Voltage - Course: Basic skills and knowledge of electrical engineering. Instruction examples for practical vocational training (Institut für Berufliche Entwicklung, 15 p.)**

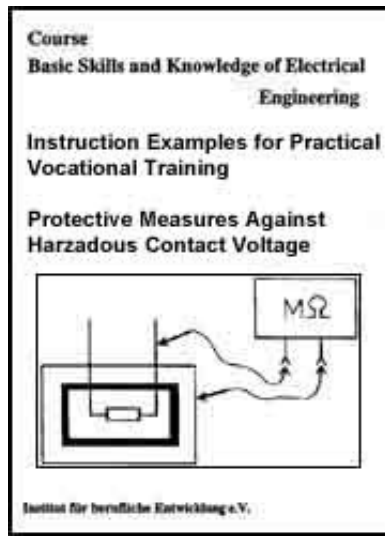
-  **(introduction...)**
-  **Introduction**
-  **Instruction Example 4.1. Preparation of a Potential Equalitation**



-  **Instruction Example 4.2. Testing of the Protective Measure of "Protective Insulation"**
-  **Instruction Example 4.3. Testing of the Protective Measure of "Protective Conductor System"**

Institut für berufliche Entwicklung e.V.

Original title:

**Lehrbeispiele für die berufspraktische Ausbildung
"Schutzmaßnahmen gegen zu hohe Berührungsspannung"**

Author: Gerhard Klix

First edition © IBE

**Institut für berufliche Entwicklung e.V.
Parkstraße 23**

13187 Berlin

Order No.: 91-33-3104/2



[Home](#) > [ar](#).[cn](#).[de](#).[en](#).[es](#).[fr](#).[id](#).[it](#).[ph](#).[po](#).[ru](#).[sw](#)

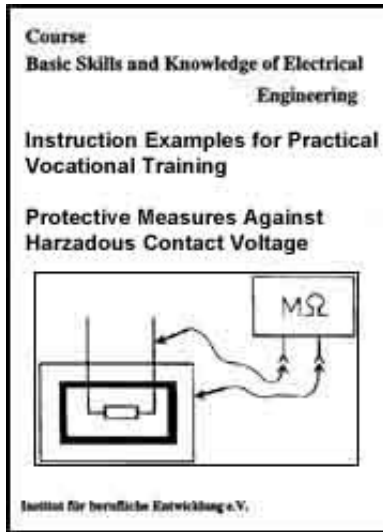

Protective Measures against Hazardous Contact Voltage - Course: Basic skills and knowledge of electrical engineering. Instruction examples for practical vocational training (Institut für Berufliche Entwicklung, 15 p.)

 **(introduction...)**

 **Introduction**

 **Instruction Example 4.1. Preparation of a Potential Equalitation**

 **Instruction Example 4.2. Testing of the Protective Measure of "Protective Insulation"**

 **Instruction Example 4.3. Testing of the Protective Measure of "Protective Conductor System"**

Introduction

The present material contains 3 selected instruction examples on the basis of which essential skills shall be exercised in the field of protective measures against hazardous contact voltage.

Since these protective measures against hazardous contact voltage are mastered only by much practice, the instruction examples have to be repeated continuously.

In order to facilitate the preparation and accomplishing of the exercises, for each instruction example - if required - the necessary materials, measuring and testing tools, auxiliary means and basic knowledge are mentioned, which must be available to carry out the tasks.

In addition to the sequence of operations, sketches are enclosed illustrating the carrying out of the exercises.



[Home](#) > [ar.cn.de.en.es.fr.id.it.ph.po.ru.sw](#)

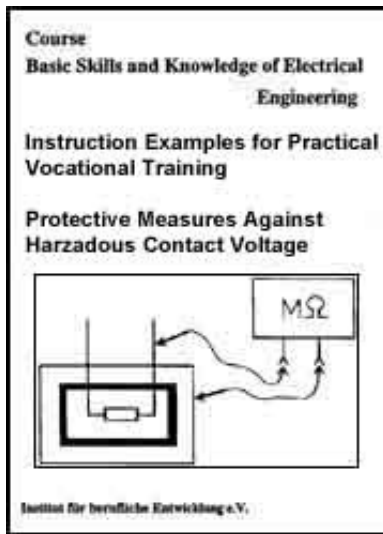

 **Protective Measures against Hazardous Contact Voltage - Course: Basic skills and knowledge of electrical engineering. Instruction examples for practical vocational training (Institut für Berufliche Entwicklung, 15 p.)**

 **(introduction...)**

 **Introduction**

 **Instruction Example 4.1. Preparation of a Potential Equalitation**

 **Instruction Example 4.2. Testing of the Protective Measure of "Protective Insulation"**

 **Instruction Example 4.3. Testing of the Protective Measure of "Protective Conductor System"**

Instruction Example 4.1. Preparation of a Potential Equalitation

Material

**Potential equalization bar,
Pipe clips of the required size,
Potential equalization lines of the required lengths and cross section**

Working tools

Screw driver, wrench, round-nose-pliers, wire brush, cable stripper, soldering iron or blow lamp for soldering

Measuring and testing tools

.Folding rule

Auxiliary means

Cable fixing clips, cable eyes, flux, tin-base solder, flameproofing tape, insulating tubing or winding tape, anti-corrosive grease

Required basic knowledge

Knowledge of the necessity of potential equalization, measuring, application of pipe clips, working at, fixing and connecting of lines

Sequence of operations

Comments

1. Finding out which parts, building

All conductive parts, such as pipe systems,

constructions and plants have to be included in the potential equalization

2. Application of the potential equalization bar

3. Determining the path of the potential equalization lines

4. Application of the pipe connecting clips

5. Application of the cable fixing clips

6. Laying the potential equalization lines

7. Connecting the potential equalization lines

8. Testing the potential equalization

heating systems, metal jackets, other metal constructions etc.

Gas and water meters in pipe systems have to be bridged!

Visual inspection, measuring

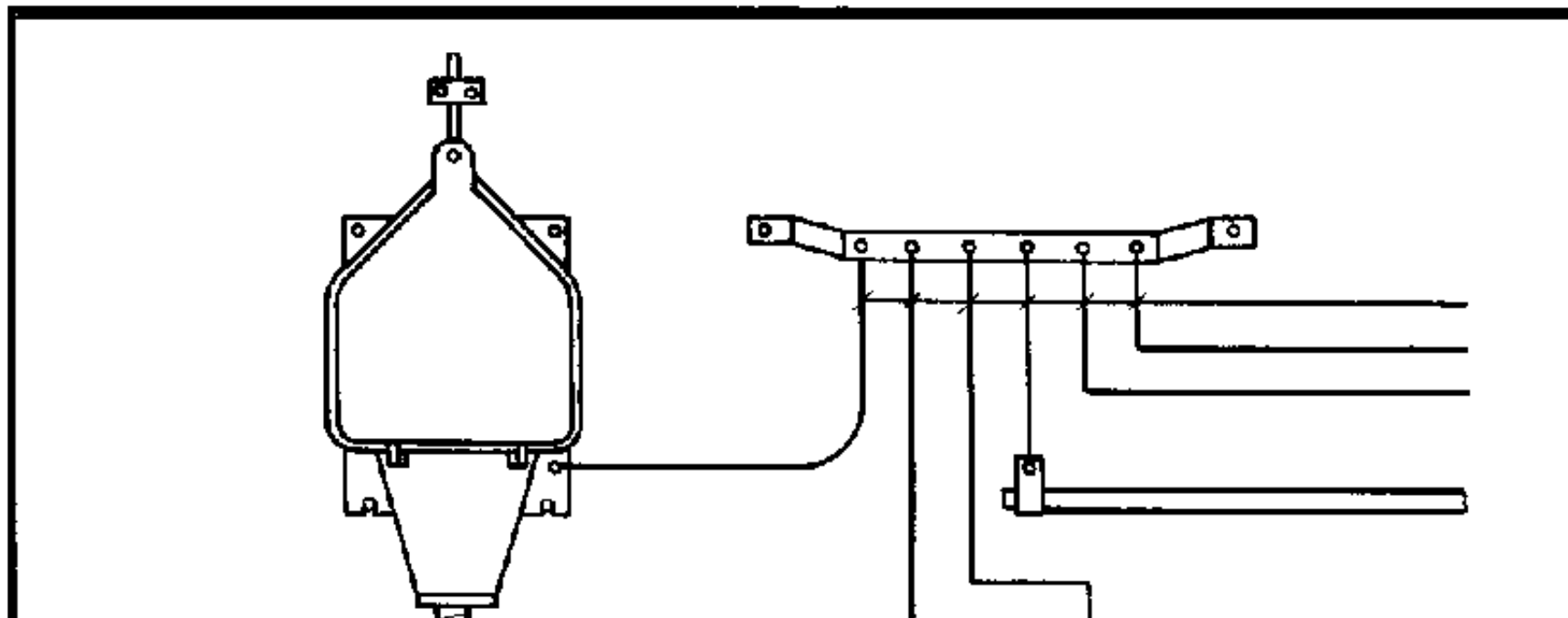

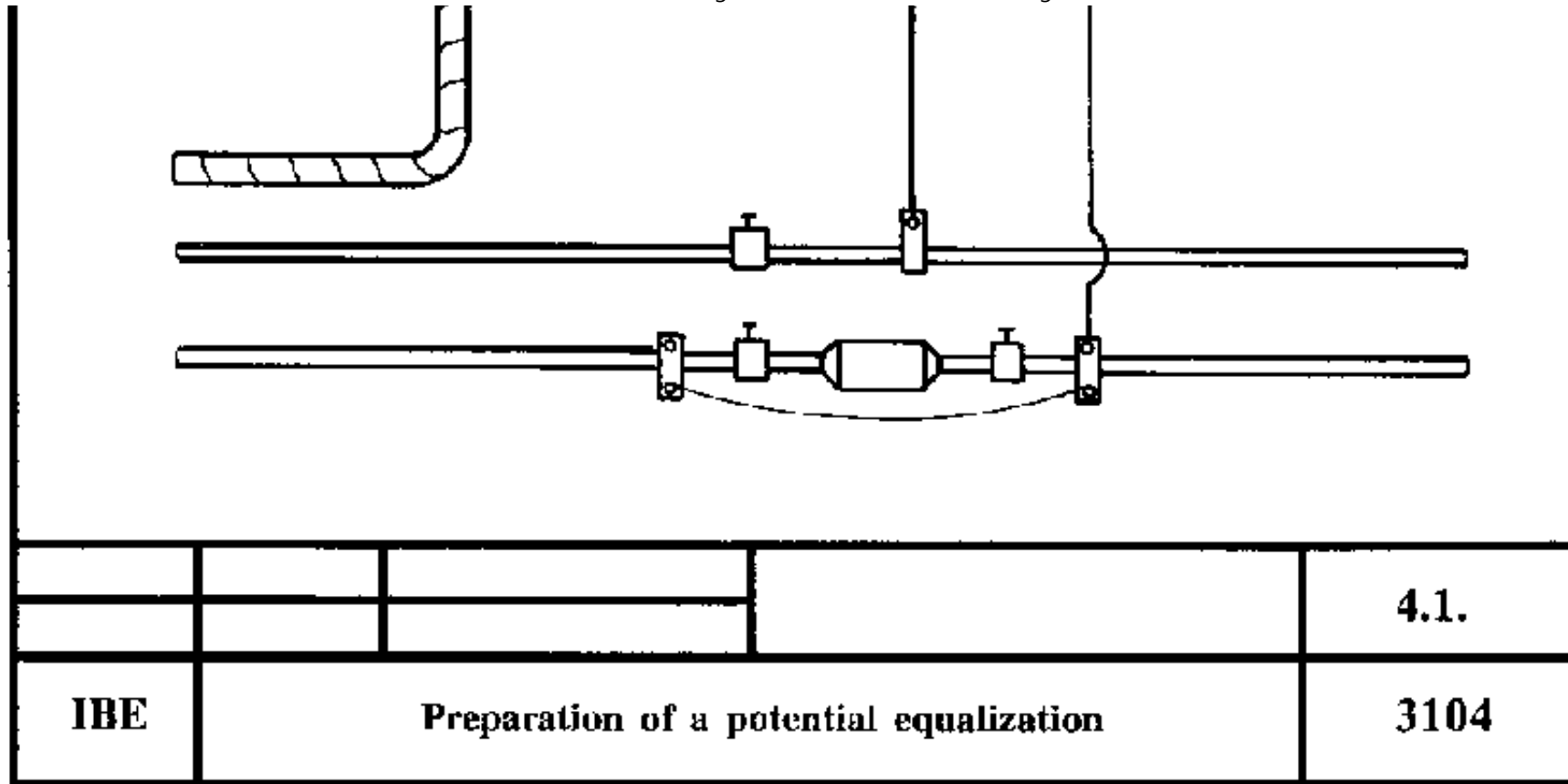

Preparation of a potential equalization



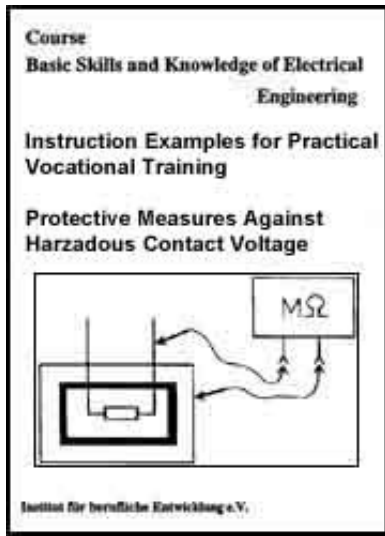

[Home](#) > [ar](#).[cn](#).[de](#).[en](#).[es](#).[fr](#).[id](#).[it](#).[ph](#).[po](#).[ru](#).[sw](#)

 **Protective Measures against Hazardous Contact Voltage - Course: Basic skills and knowledge of electrical engineering. Instruction examples for practical vocational training (Institut fr Berufliche Entwicklung, 15 p.)**



 **(introduction...)
Introduction**

 **Instruction Example 4.1. Preparation of a Potential Equalitation**

 **Instruction Example 4.2. Testing of the Protective Measure of "Protective Insulation"**

 **Instruction Example 4.3. Testing of the Protective Measure of "Protective Conductor System"**

Instruction Example 4.2. Testing of the Protective Measure of "Protective Insulation"

Measuring and testing tools

Protective insulation testing instrument, insulation resistance measuring instrument

Auxiliary means

Measuring lines, test prods

Required basic knowledge

Criteria of the protective insulation, handling of measuring and testing tools, knowledge of measuring and testing processes, how to act after accidents caused by electric current

Sequence of operations

Comments

1. Visual inspection

-

Determination of the form of the protective insulation

- No visible damage of the insulation

- No protective conductor connections

2. Measuring

- Testing of the protective insulation

Attention "high voltage" - observe safety instructions!

The protective insulation must stand an alternating current test voltage of 4 kV for at least one minute. (After testing, no damage must be visible at the insulation, such as rupture, arcing or deformation.) With high voltage testing at electronically controlled machines, electronics have to be disconnected or bridged.

Testing the The insulation resistance must be at least 1.5 megohm with a measuring

- testing the
insulation
resistance

the insulation resistance must be at least 1.5 megohm with a measuring
voltage of 100 V!

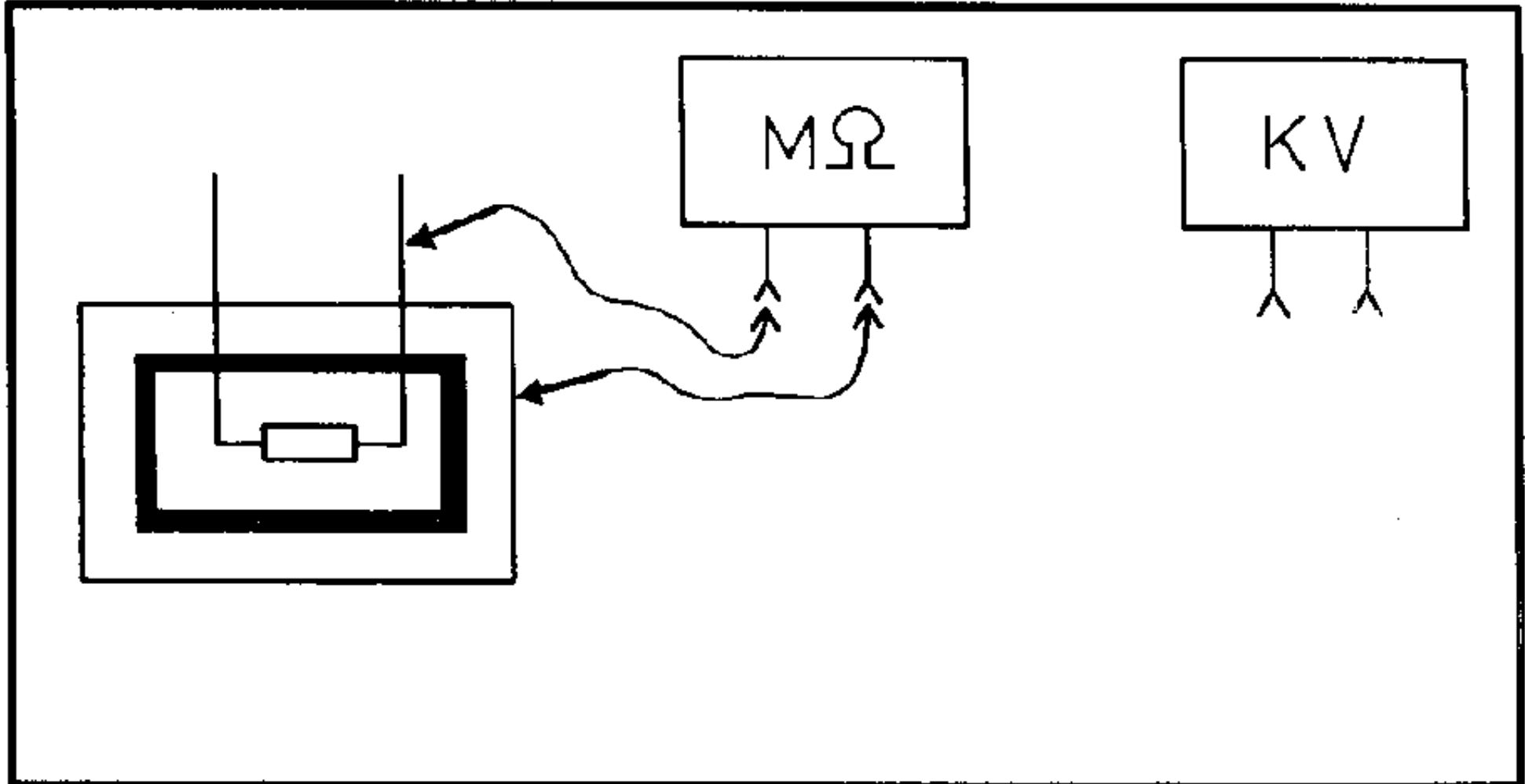



				4.2.
IBE	Testing of the protective measure of "protective insulation"			3104

Testing of the protective measure of "protective insulation"

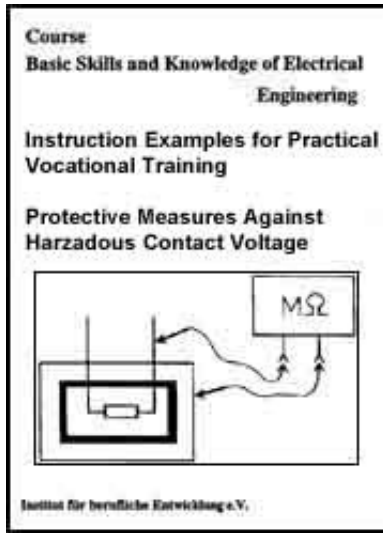

[Home](#) > [ar](#).[cn](#).[de](#).[en](#).[es](#).[fr](#).[id](#).[it](#).[ph](#).[po](#).[ru](#).[sw](#)



 **Protective Measures against Hazardous Contact Voltage - Course: Basic skills and knowledge of electrical engineering. Instruction examples for practical vocational training (Institut für Berufliche Entwicklung, 15 p.)**

 **(introduction...)**

 **Introduction**

 **Instruction Example 4.1. Preparation of a Potential Equalitation**

 **Instruction Example 4.2. Testing of the Protective Measure of "Protective Insulation"**

 **Instruction Example 4.3. Testing of the Protective Measure of "Protective Conductor System"**

Instruction Example 4.3. Testing of the Protective Measure of "Protective Conductor System"

Testing and measuring tools

Insulating resistance measuring instrument

Auxiliary means

Measuring lines, test prods

Required basic knowledge

Criteria of the protective conductor system, handling of measuring and testing tools, knowledge of measuring and testing processes, how to act after accidents caused by electric current

Sequence of operations	Comments
<p>1. Visual inspection</p> <ul style="list-style-type: none"> - Plant has an own transformer - Neutral point of transformer is earthed by a fusible cut-out - All metallic pans that do not belong to the service circuit are connected with each other by a protective conductor 	<p>The protective conductor must not be connected with the neutral conductor!</p>
<p>2. Measuring</p> <ul style="list-style-type: none"> - The insulation resistance is greater than 25 ohms/volt 	
<p>3. Functional testing</p> <ul style="list-style-type: none"> - The insulation resistance is to be reduced to a value less than 25 ohms per volt 	<p>Supervisory facility must switch off!</p>



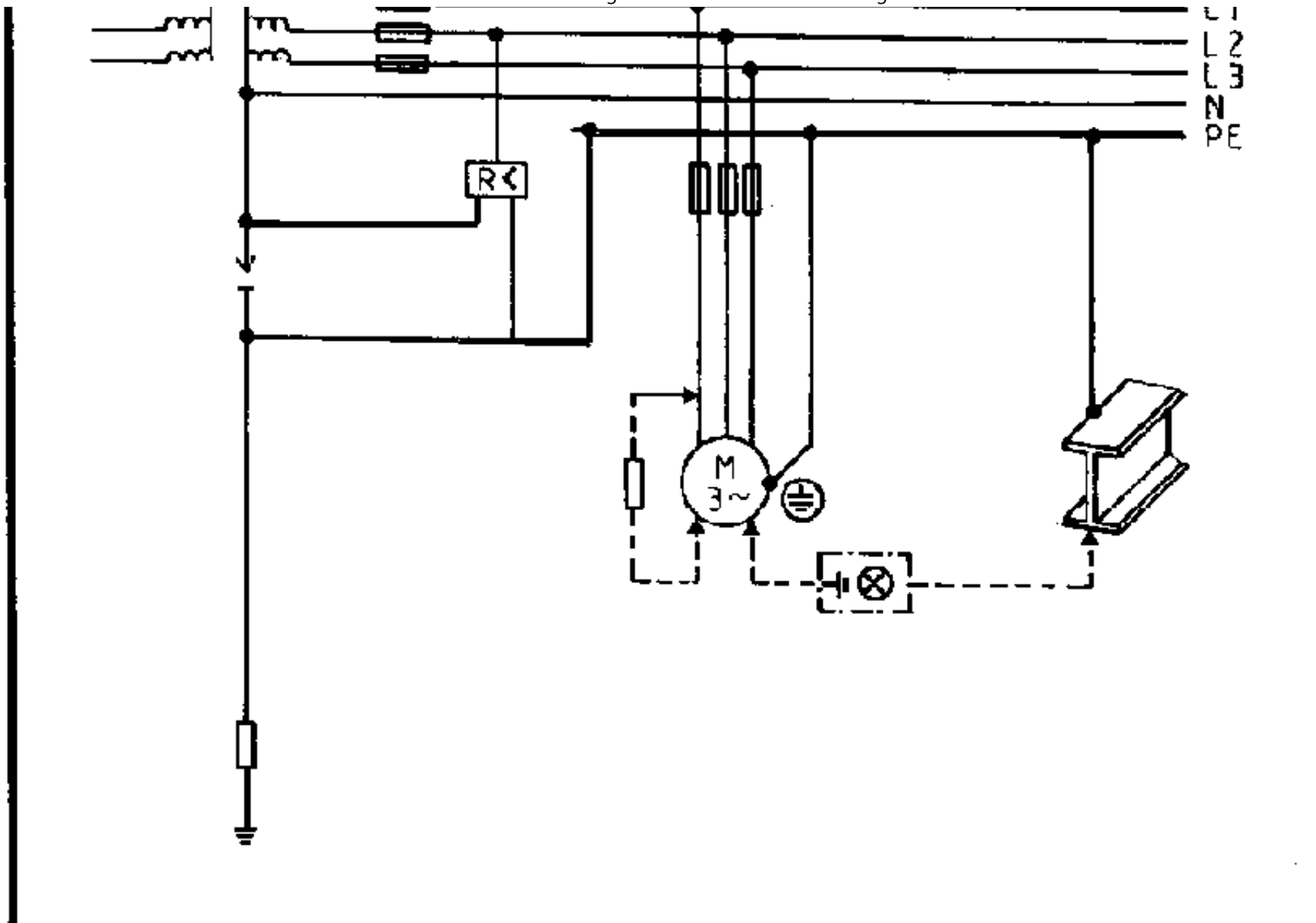

			4.3.
IBE	Testing of the protective measure of		3104

"protective conductor system"

Testing of the protective measure of "protective conductor system"

