



➔ **Small-Scale Manufacture of Footwear (ILO - WEP, 1982, 228 p.)**

(introduction...)

Acknowledgements

Preface

CHAPTER I. INTRODUCTION

I. Objectives of the memorandum

II. The footwear industry

III. Types of footwear

IV. Operation reference numbering system and tables of technical data

V. Scales of production

VI. Use of the technological information

CHAPTER II. MANUFACTURING TECHNOLOGY FOR TYPE 1 FOOTWEAR

(introduction...)

I. Operation sequence

II. Detailed description of processing stages

II.1 Cutting uppers (Operation reference No. 1)

II.2 Upper preparation

II.3 Upper stitching (Operation reference No. 9)

II.4 Stitched upper finishing

II.5 Bottom component preparation

II.6 Making

II.7 Shoe finishing and packing (Operation reference No. 31)

III. Table of technical data

III.1 Material handling resources, work force and production floor area

III.2 Workforce allocation: Table II.4

III.3 Equipment specification: Table II.5

IV. Floor plans for production areas

CHAPTER III. MANUFACTURING TECHNOLOGIES FOR FOOTWEAR TYPES 2 TO 6

























(introduction...)

I. Type 2 footwear: Leather-upper, cement-lasted shoes with directly moulded-on soles

















(introduction...)

I.1 Scrim attaching (Operation reference No. 32)

I.2 Heel Core attaching (Operation reference No. 33)





-  **I.3 Bottom solutioning (Operation reference No. 34)**
-  **I.4 Direct sole moulding-on (Operation reference No. 35)**
-  **I.5 Subsequent operations**
-  **I.6 Tables of technical data for type 2 footwear**
- **II. Type 3 footwear: Leather-upper, tack-lasted shoes with machine-sewn leather soles**
 -  **(introduction...)**
 -  **II.1 Insole preparation (Operation reference No. 36)**
 -  **II.2 Sole preparation (Operation reference No. 37)**
 -  **II.3 Insole tacking (Operation reference No. 38)**
 -  **II.4 Tack lasting (Operation reference No. 39)**
 -  **II.5 Bottom pounding (Operation reference No. 40)**
 -  **II.6 Bottom cementing (Operation reference No. 41)**
 -  **II.7 Sole laying (Operation reference No. 42)**
 -  **II.8 Last removal (Operation reference No. 43)**
 -  **II.9 Sole stitching (Operation reference No. 44)**
 -  **II.10 Sole levelling (Operation reference No. 45)**
 -  **II.11 Seat nailing (Operation reference No. 46)**
 -  **II.12 Heel attaching (Operation reference No. 47)**
 -  **II.13 Re-lasting (Operation reference No. 48)**
 -  **II.14 Heel trimming (Operation reference No. 49)**
 -  **II.15 Edge trimming (Operation reference No. 50)**
 -  **II.16 Bottom finishing (Operation reference No. 51)**
 -  **II.17 Tables of technical data**
- **III. Type 4 footwear: Welded synthetic upper, string lasted shoes with moulded-on soles**
 -  **(introduction...)**
 -  **III.1 Cutting and welding upper components (Operation reference No. 52)**
 - III.2 Welding upper components together (Operation reference No. 53)**
 - III.3 Lasting string attaching (Operation reference No. 54)**
 - III.4 String lasting and moulding-on of soles (Operation reference No. 55)**
 - III.5 Sock insertion (Operation reference No. 56)**
 - III.6 Tables of technical data**
- IV. Type 5 footwear: Stitched synthetic upper cement-lasted sandals and casual shoes with built or unit soles**
 - (introduction...)**

- IV.1 Sole and insole preparation (Operation reference No. 57)**
 - IV.2 Heel preparation (Operation reference No. 58)**
 - IV.3 Lasting uppers (Operation reference No. 59)**
 - IV.4 Heel attaching (Operation reference No. 60)**
 - IV.5 Sole, finishing (Operation reference No. 61)**
 - IV.6 Tables of technical data**
- V. Type 6 footwear: Single injection, moulded plastic sandals**
 - (introduction...)**
 - V.1 Single injection moulding technique and equipment (Operation reference No. 62)**
 - V.2 Tables of technical data**
- CHAPTER IV. FRAMEWORK FOR PROJECT EVALUATION**
 - (introduction...)**
 - I. Factors influencing the choice of technology**
 - II. Evaluation methodology**
 - (introduction...)**
 - II.1 Estimation of cost items**
 - II.2 Estimation of total annual costs and of gross profits**
 - II.3 Sources of technical and economic data**
 - II.4 Hypothetical examples of the application of the evaluation methodology**
 - III. Evaluation of technologies adopted by established footwear factories in developing countries**
 - (introduction...)**
 - III.1 Alternative technologies for type 1 footwear: A Ghanaian case study**
 - III.2 Comparison of alternative types of footwear at fixed levels of scale: Ethiopian case study**
 - III.3 Effects of scale on manufacturing technology for type 1 footwear: Ghanaian and Ethiopian case studies**
 - IV. Concluding remarks on the choice of technology and specialisation**
 - IV.1 Need for preliminary marketing investigations**
 - IV.2 Specialisation and organisation of production**
- CHAPTER V. FRAMEWORK FOR NATIONAL DECISIONS**
 - (introduction...)**
 - I. Comparison of alternative footwear products**
 - I.1 Capital and labour requirements for different technologies and types of footwear**
 - I.2 Product choice, resource allocation and the satisfaction of basic needs**
 - II. Economic and social appraisal of alternative technologies and products**

-  **II.1 Social versus private benefit-cost analysis**
 -  **II.2 Appraisal of alternative technologies for type 1 footwear**
 -  **II.3 Data requirements and sensitivity analysis**
- **III. Towards a national footwear manufacturing strategy**
 -  **III.1 Factors influencing a national footwear strategy**
 -  **III.2 Comparative advantage, social considerations and product choice**
 -  **III.3 Backward linkages and availability of raw materials**
 -  **III.4 Employment, technological choice and skill requirements**
 -  **III.5 Other factors**
- **APPENDICES**
 -  **Appendix I - Glossary of technical terms**
 -  **Appendix II - List of equipment suppliers**
 -  **Appendix III - Selected bibliography**
 -  **Appendix IV - Selected list of technical institutions**
 -  **Appendix V - Present worth of an annuity factor**
 -  **Questionnaire**
-  **Other ILO publications**
-  **Back cover**

[Home](#) > [ar.cn.de.en.es.fr.id.it.ph.po.ru.sw](#)



-  **Small-Scale Manufacture of Footwear (ILO - WEP, 1982, 228 p.)**
 - ➔  **(introduction...)**
 -  **Acknowledgements**
 -  **Preface**
 - **CHAPTER I. INTRODUCTION**
 - **CHAPTER II. MANUFACTURING TECHNOLOGY FOR TYPE 1 FOOTWEAR**
 - CHAPTER III. MANUFACTURING TECHNOLOGIES FOR FOOTWEAR TYPES 2 TO 6**
 - CHAPTER IV. FRAMEWORK FOR PROJECT EVALUATION**
 - CHAPTER V. FRAMEWORK FOR NATIONAL DECISIONS**
 - APPENDICES**
 - Other ILO publications**
 - Back cover**

Technical Memorandum No. 2

Prepared under the joint auspices of the International Labour Office and the United Nations Industrial Development Organisation



International Labour Office Geneva



World Employment Programme

The ILO's World Employment Programme (WEP) aims to assist and encourage member States to adopt and implement active policies and projects designed to promote full, productive and freely chosen employment and to reduce poverty. Through its action-oriented research, technical advisory services, national projects and the work of its four regional employment teams in Africa, Asia and Latin America, the WEP pays special attention to the longer-term development problems of rural areas where the vast majority of poor and underemployed people still live, and to the rapidly growing urban informal sector.

At the same time, in response to the economic crises and the growth in open unemployment of the 1980s, the WEP has entered into an ongoing dialogue with the social partners and other international agencies on the social dimensions of adjustment, and is devoting a major part of its policy analysis and advice to achieving greater equity in structural adjustment programmes. Employment and poverty monitoring, direct employment creation and income generation for vulnerable groups, linkages between macro-economic and micro-economic interventions, technological change and labour market problems and policies are among the areas covered.

Through these overall activities, the ILO has been able to help national decision-makers to reshape their policies and plans with the aim of eradicating mass poverty and promoting productive employment.

This publication is the outcome of a WEP project.

Copyright © International Labour Organisation 1982

Publications of the International Labour Office enjoy copyright under Protocol 2 of the Universal Copyright Convention. Nevertheless, short excerpts from them may be reproduced without authorisation, on condition that the source is indicated. For rights of reproduction or translation, application should be made to the Publications Branch (Rights and Permissions), International Labour Office, CH-1211 Geneva 22, Switzerland. The International Labour Office welcomes such applications.

ISBN 92-2-103079-2

ISSN 0252-2004

First published 1982
Third impression 1989

The designations employed in ILO publications, which are in conformity with United Nations practice, and the presentation of material therein do not imply the expression of any opinion whatsoever on the part of the International Labour Office concerning the legal status of any country, area or territory or of its authorities, or concerning the delimitation of its frontiers. The responsibility for opinions expressed in signed articles, studies and other contributions rests solely with their authors, and publication does not constitute an endorsement by the International Labour Office of the opinions expressed in them. Reference to names of firms and commercial products and processes does not imply their endorsement by the International Labour Office, and any failure to mention a particular firm, commercial product or process is not a sign of disapproval.

ILO publications can be obtained through major booksellers or ILO local offices in many countries, or direct from ILO Publications, International Labour Office, CH-1211 Geneva 22, Switzerland. A catalogue or list of new publications will be sent free of charge from the above address.

Printed by the International Labour Office, Geneva, Switzerland



[Home](#) > [ar.cn.de.en.es.fr.id.it.ph.po.ru.sw](#)



 **Small-Scale Manufacture of Footwear (ILO - WEP, 1982, 228 p.)**

 **(introduction...)**

 **Acknowledgements**

 **Preface**

CHAPTER I. INTRODUCTION

CHAPTER II. MANUFACTURING TECHNOLOGY FOR TYPE 1 FOOTWEAR

CHAPTER III. MANUFACTURING TECHNOLOGIES FOR FOOTWEAR TYPES 2 TO 6

CHAPTER IV. FRAMEWORK FOR PROJECT EVALUATION

CHAPTER V. FRAMEWORK FOR NATIONAL DECISIONS

APPENDICES

Other ILO publications

Back cover

Other ILO publications

Technology Series ISSN 0252-2004

The object of the technical memoranda in this series is to help to disseminate, among small-scale producers, extension officers and project evaluators, information on small-scale processing technologies that are appropriate to the socio-

economic conditions of developing countries.

Tanning of hides and skins (Technology Series - Technical Memorandum No. 1)

Provides technical and economic information concerning the tanning of hides and skins at scales ranging from two hides per day (a typical rural tannery) to 200 hides per day. Six alternative tanning technologies are described, from a fully mechanised 200 hides per day project to a highly labour-intensive two hides per day project. Subprocesses are described in great detail, with diagrams of pieces of equipment which may be manufactured locally. A list of equipment suppliers is also provided for those pieces of equipment which may need to be imported.

The memorandum on the tanning of hides and skins is, to some extent, complementary to that on the small-scale manufacture of footwear.

ISBN 92-2-102904-2 27.50 Swiss francs

Small-scale manufacture of footwear, (Technology Series - Technical Memorandum No. 2)

Covers the small-scale production of footwear (shoes and sandals) of differing types and quality, providing detailed technical and economic information covering four scales of production ranging from eight pairs per day to 1,000 pairs per day. A number of alternative technologies are described, including both equipment-intensive and labour-intensive production methods. Subprocesses are described in great detail, with diagrams of pieces of equipment which may be manufactured locally. A list of equipment suppliers is also provided for those pieces of equipment which may need to be imported.

ISBN 92-2-103079-2 25 Swiss francs

Small-scale processing of fish (Technology Series - Technical Memorandum No. 3)

This technical memorandum covers, in detail, technologies that are suitable for the small-scale processing of fish: that is, drying, salting, smoking, boiling and fermenting. Thermal processing is described only briefly, as it is used mainly in large-scale production. Enough information is given about the technologies to meet most of the needs of small-scale processors. Two chapters of interest to public planners compare, from a socio-economic viewpoint, the various technologies described in the memorandum and analyse their impact on the environment.

ISBN 92-2-103205-1 17.50 Swiss francs

Small-scale weaving (Technology Series - Technical Memorandum No. 4)

Describes alternative weaving technologies for eight types of cloth (four plains and four twills) of particular interest for low-income groups in terms of both price and durability. The monograph provides information on available equipment (e.g. looms, pirning equipment, warping equipment), including equipment productivity, quality of output, required quality of materials inputs, and so on. A methodological framework for the evaluation of alternative weaving technologies at three scales of production is provided for the benefit of the textile producer who wishes to identify the technology/scale of

production best suited to his own circumstances. ISBN 92-2-103419-4 20 Swiss francs

Small-scale oil extraction from groundnuts and copra (Technology Series - Technical Memorandum No. 5) Covers, in detail, various technologies for the extraction of oil from groundnuts and copra: baby expeller mills, small package expellers and power ghanis. Three main stages of processing are considered, namely the pre-processing stages (drying, crushing, scorching), the oil extraction stage and the post-treatment stages (filtering, cake breaking, packaging, bagging). The economic and technical details provided on the stages of processing should help would-be or practising small-scale producers to identify and apply the oil extraction technology best suited to local conditions. A chapter of interest to public planners compares small-scale plants and large-scale plants from a socio-economic viewpoint and suggests various policy measures for the promotion of the right mix of oil extraction techniques.

ISBN 92-2-103503-4 17.50 Swiss francs

Small-scale brickmaking (Technology Series - Technical Memorandum No. 6)

Provides detailed technical information on different brickmaking techniques and covers all processing stages, including quarrying, clay preparation, moulding, drying, firing and the testing of produced bricks. The techniques described are mostly of interest to small-scale producers in both rural and urban areas. The processes and equipment are described in great detail, including drawings of equipment and tools which may be produced locally, floor plans, labour and skill requirements, materials and fuel inputs per unit of output. A list of equipment suppliers from both developing and developed countries is also supplied with a view to assisting the would-be brickmaker to import the required equipment. A chapter of interest to public planners compares, from a socio-economic point of view, the various brickmaking techniques described in this memorandum.

ISBN 92-2-103567-0 27.50 Swiss francs

Small-scale maize milling (Technology Series - Technical Memorandum No. 7)

Provides detailed information on alternative techniques for the production of whole meal, bolted meal and super-sifted meal. It covers all processing stages, including grain preparation, shelling, milling, sifting and packaging. The techniques described are mostly of interest to custom mills and small-scale merchant mills located in rural and urban areas. The first chapter of the memorandum gives in-depth information on the effects of different maize-milling techniques, including the nutritional value of various kinds of maize meal, employment generation, foreign exchange savings and so on.

ISBN 92-2-103640-5 17.50 Swiss francs

Other ILO publications

Small-scale paper-making (Technology Series - Technical Memorandum No. 8)

Provides technical and economic information on alternative paper-making technologies, describes the characteristics of various types and grades of paper products and gives guidance in the choice of paper machines. The information relates

mostly to small-scale paper mills with a capacity of 30 tonnes of paper per day or less. The raw materials suggested for such mills include straw, bagasse, waste paper, rags and cotton waste, as well as other agricultural residues and imported wood pulp. Unlike other memoranda in the series, this memorandum is not a technical introduction to paper-making in general, nor is it a basic textbook on the subject. Instead, it provides people already in possession of the necessary background knowledge with criteria for choosing amongst different methods of paper-making.

ISBN 92-2-103971-4 22.50 Swiss francs

Small-scale processing of pork (Technology Series - Technical Memorandum No. 9)

Provides detailed technical information on small-scale technologies for the production of a variety of pig-meat products, including fresh sausage, *Mortadella*, ham, bacon, *Metwurst* and so on. Information is provided on the raw materials required, processing equipment, plant layout and hygiene, and the processing stages for each pig-meat product. A methodological framework for the evaluation of alternative meat processing technologies and scales of production is included for the benefit of potential meat processors. The focus is placed on the establishment of pork processing units which operate as a separate business. However, with some adaptation, the information supplied should also allow planners to assess the feasibility of attaching a processing unit to an existing slaughterhouse or butchery business.

ISBN 92-2-100542-9 20 Swiss francs

Small-scale processing of beef (Technology Series - Technical Memorandum No. 10)

Provides detailed technical information on small-scale technologies for the production of a variety of beef products, including beefburgers, *chill con came*, biltong, *charqui*, frankfurters, beef cervelat and so on. Information is provided on the raw materials required, processing equipment, plant layout and hygiene, and the processing stages for each beef product. A methodological framework for the evaluation of alternative meat processing technologies and scales of production is included for the benefit of potential meat processors. The focus is placed on the establishment of pork processing units which operate as a separate business. However, with some adaptation, the information supplied should also allow planners to assess the feasibility of attaching a processing unit to an existing slaughterhouse or butchery business.

ISBN 92-2-105050-5 20 Swiss francs

Solar drying: Practical methods of food preservation

This training manual is the outcome of an ILO regional project on the development and application of appropriate food-processing technologies. The manual provides clear and detailed information on the basic theory and practice of sun and solar drying of various food products (fish, fruit, vegetables and grains). It discusses the type of information needed to determine whether solar drying is feasible and appropriate in particular cases, and, with an explanation of how the sun's energy can be harnessed, outlines basic drying theory. Several different types of dryers-cabinet, tent, paddy, hybrid -are described and some guidance is given on their construction. Information is also provided on the preparation of the raw materials before they are dried and on packaging techniques for the dried product.







All prices subject to change without notice.



[Home](#) > [ar](#) [cn](#) [de](#) [en](#) [es](#) [fr](#) [id](#) [it](#) [ph](#) [po](#) [ru](#) [sw](#)



 **Small-Scale Manufacture of Footwear (ILO - WEP, 1982, 228 p.)**

-  **(introduction...)**
-  **Acknowledgements**
-  **Preface**
- CHAPTER I. INTRODUCTION**
- CHAPTER II. MANUFACTURING TECHNOLOGY FOR TYPE 1 FOOTWEAR**
- CHAPTER III. MANUFACTURING TECHNOLOGIES FOR FOOTWEAR TYPES 2 TO 6**
- CHAPTER IV. FRAMEWORK FOR PROJECT EVALUATION**
- CHAPTER V. FRAMEWORK FOR NATIONAL DECISIONS**
- APPENDICES**
-  **Other ILO publications**
-   **Back cover**

Back cover

Small-scale processing of footwear

A number of developing countries have developed and successfully applied technologies that are suited to the socio-economic conditions prevailing in those countries: that is, technologies which make better use of abundant labour and scarce capital than do technologies developed in industrialised countries. Unfortunately, these technologies are rarely disseminated outside the countries where they have been developed. Consequently, the ILO and UNIDO have joined forces in order to make available to small-scale entrepreneurs in developing countries detailed technical and economic information on these technologies. This information will be published in the form of technical memoranda, and will cover products and processes of particular interest to developing countries.

This technical memorandum covers the small-scale production of footwear (shoes and sandals) of differing types and quality. It provides detailed technical and economic information covering four scales of production ranging from eight pairs per day to 1,000 pairs per day. A number of alternative technologies are described, including both equipment-intensive and labour-intensive production methods. Subprocesses are described in great detail, with diagrams of pieces of equipment which may be manufactured locally. A list of equipment suppliers is also provided for those pieces of equipment which may need to be imported.

It is hoped that the information contained in this memorandum will help would-be and practising footwear producers to choose and apply manufacturing techniques which will minimise production costs while improving the quality of footwear.

ISSN 0252-2004 Price: 25 Swiss francs



[Home](#) > [ar.cn.de.en.es.fr.id.it.ph.po.ru.sw](#)



Small-Scale Manufacture of Footwear (ILO - WEP, 1982, 228 p.)

(introduction...)

Acknowledgements

Preface

CHAPTER I. INTRODUCTION

CHAPTER II. MANUFACTURING TECHNOLOGY FOR TYPE 1 FOOTWEAR

CHAPTER III. MANUFACTURING TECHNOLOGIES FOR FOOTWEAR TYPES 2 TO 6

CHAPTER IV. FRAMEWORK FOR PROJECT EVALUATION

CHAPTER V. FRAMEWORK FOR NATIONAL DECISIONS

APPENDICES

Other ILO publications

Back cover

Acknowledgements

The publication of this memoranda has been made possible by a grant from the Swedish International Development Authority (SIDA). The International Labour Office and the United Industrial Development Organisation acknowledge this generous support.



[Home](#) > [ar.cn.de.en.es.fr.id.it.ph.po.ru.sw](#)

Small-Scale Manufacture of Footwear (ILO - WEP, 1982, 228 p.)

(introduction...)

Acknowledgements

Preface

CHAPTER I. INTRODUCTION

CHAPTER II. MANUFACTURING TECHNOLOGY FOR TYPE 1 FOOTWEAR



- CHAPTER IV. FRAMEWORK FOR PROJECT EVALUATION**
- CHAPTER V. FRAMEWORK FOR NATIONAL DECISIONS**
- APPENDICES**
-  **Other ILO publications**
-  **Back cover**

Preface

In their efforts to industrialise, developing countries have often relied on technologies developed in industrialised countries. These technologies are generally imported in the form of 'turn-key' factories, and few adjustments - if any - are made in order to adapt them to local socio-economic conditions. An alternative approach consists in importing equipment specified in plant designs prepared by local or foreign engineering firms. Whatever the approach, the choice of technology is generally restricted to those technologies developed and marketed in industrialised countries. Only a few countries have established local engineering firms capable of developing plant designs suitable to local socio-economic conditions and of producing appropriate capital goods.

Reliance on technologies imported from industrialised countries would not necessarily be harmful if these technologies were suitable for prevailing local socio-economic conditions. This is, unfortunately, not always the case. A large number of studies show that these technologies are seldom appropriate for countries suffering from high unemployment and underemployment, lack of foreign exchange, capital, and a strong industrial structure (e.g. capital goods industries, adequate physical infrastructure), and an insufficiently large pool of highly skilled labour. In general, they tend to make a heavy use of scarce resources while abundant ones, such as labour, are little utilised.

What may explain such reliance on imported technologies? Although a large number of reasons can be advanced to explain this phenomenon, the following three reasons are probably the most important ones:

Firstly, local technologies used by small-scale enterprises, artisans, and cottage industries have often proved to be less competitive than imported technologies, both in terms of production costs and the quality of output. These production units have not also been able to adapt their production to changing tastes, or to increase the supply of consumer goods and capital goods at a rate commensurate with that of demand for these goods. Secondly, foreign investors (e.g. as in the case of joint ventures) tend to adopt technologies used in their home countries and their local partners (private entrepreneurs or public enterprises) are generally not in a position to propose and/or impose alternative technologies. Thirdly, in the case of export industries, the type and quality of goods in demand in industrialised countries often require the use of technologies developed in these countries.

While the above reasons may explain the current reliance on imported technologies, one should not conclude that developing

countries have no other choice than to adopt these technologies. A number of these countries have developed and successfully applied technologies which are both more cost-effective than technologies developed in industrialised countries and more suitable to socio-economic conditions prevailing in developing countries. These locally developed technologies make a larger use of available labour than do imported technologies, require few imports, generate important multiplier effects on the economy (e.g. through the local production of equipment used by these technologies) and do not rely extensively on foreign skills and know-how. They have been developed for a large number of products and processes, especially those of particular interest for developing countries.

Unfortunately, information on these technologies is not generally available in a useful form, if available at all. They are mostly known in the countries where they have been developed and applied, and are rarely transferred to other developing countries. This may be explained by various reasons. Firstly, those who develop these technologies were either not interested in disseminating them, or did not have the necessary means for the publication and dissemination of the technological information. Secondly, most of these technologies are neither patented nor marketed internationally by engineering firms or equipment suppliers. Finally, they are not generally advertised in trade journals published in industrialised countries. Developing countries are therefore not aware of their existence, or cannot obtain detailed technical information which would enable them to apply these technologies.

Consequently, the International Labour Office and the United Nations Industrial Development Organisation have joined efforts in order to improve the dissemination of information on appropriate technologies among developing countries. One outcome of this joint collaboration was the decision to publish a series of technical memoranda on specific industrial products and processes, and to disseminate these as widely as possible among potential and established private and public enterprises.

The technical memoranda are mostly intended for potential producers who have some difficulties in choosing and applying technologies best suited to their own circumstances. However, they should also be of interest to public planners, project evaluators from industrial development agencies, training institutions and national and international financial institutions. In short, the memoranda should be useful to all those who are in a position to influence the choice of public or private investment and therefore the choice of technologies associated with these investments.

The technological information contained in the memoranda is fairly detailed as it would be difficult for the reader to obtain missing information. Thus, clear and detailed descriptions of processes as well as drawings of equipment which may be manufactured locally are provided, and lists of equipment suppliers -from both developing and developed countries - are included whenever the local manufacture of equipment may not be easily undertaken. A methodological framework for the evaluation of alternative technologies is provided in order to enable the reader to identify the least-cost or most profitable technology. Some information on the socio-economic impact of alternative technologies is also included for the benefit of public planners and project evaluators.

While an attempt has been made to provide fairly detailed technical information, there would undoubtedly be cases where some information will still be missing.

The reader may contact technology institutions or research centres listed in a separate appendix or other additional books or journals included in the bibliography. The ILO and UNIDO may also be contacted and every effort will be made to provide the

missing information.

Technical memoranda are not intended as training manuals. It is assumed that the potential users of the technologies described in the memoranda are trained practitioners and that the memoranda are only supposed to provide them with information on alternative technological choices. Memoranda may, however, be used as complementary training material by training institutions.

This technical memorandum on small-scale footwear manufacturing is the second of a series being currently prepared by the ILO and UNIDO. It follows the publication of a technical memorandum on a closely related subject: the tanning of hides and skins.¹ Some of the information contained in this latter memorandum is complementary to that contained in this one, and may be found useful by footwear manufacturers and public planners.

¹ International Labour Office and United Nations Development Organisation, Tanning of Hides and Skins, (Geneva, ILO, 1981)

This technical memorandum provides technical and economic details on alternative footwear manufacture technologies used in scales of production ranging from 8 pairs per day to 1,000 pairs per day (i.e. the range of scales of production varies from the artisanal type production to medium-scale production). Substantially larger scales of production are not covered by this memorandum for the following reasons. Firstly, potential footwear manufacturers who may wish to invest in large-scale, capital-intensive plants costing many million dollars would most probably use the services of a specialised engineering firm in view of the large investment involved. Secondly, information on technologies used in these plants is readily available from engineering firms or equipment suppliers from industrialised countries. Finally, experience shows that in machine-intensive footwear plants producing conventionally constructed shoes, spare machine capacity is likely to be at a minimum at outputs approximately equal to 1,000 pairs per 8-hour shift. In fact, equipment is often designed to reach output capacity at this scale, and plants producing substantially more than 1,000 pairs per 8-hour shift tend to group their equipment in such a way as to form separate units producing at the above output level. Thus, footwear manufacturers interested in producing a few thousands of pairs per day may still benefit from the information contained in this memorandum.

The effective dissemination of technical memoranda would require the active participation of various government agencies, trade associations, workers' and employers' organisations, training institutions, etc. Seminars may be organised for the benefit of established or potential footwear manufacturers in order to review the proposed technologies, identify those which are particularly suited to prevailing local conditions and identify the type of assistance needed by manufacturers who wish to adopt one of the technologies described in the memorandum.

This memorandum may be directly used by functionally literate footwear manufacturers who are familiar with accounting methods, and are capable therefore of evaluating the proposed technologies on the basis of local factor prices. However, some shoemakers may not be functionally literate, especially artisans who may be interested in the very small scale of production (8 pairs per day). In this case, information on alternative techniques may be disseminated among these artisans by extension officers or training institutions.

Names of equipment suppliers are provided in Appendix II of the memorandum. This does not, however, imply a special

endorsement of these suppliers by the ILO. These names are only provided for illustrative purposes, and footwear manufacturers should try to obtain information from as many suppliers as feasible.

A questionnaire is attached at the end of the memorandum for those readers who may wish to send to the ILO or UNIDO their comments and observations on the content and usefulness of this publication. These will be taken into consideration in the future preparation of additional technical memoranda.

This memorandum was prepared by N.S. McBain and A. Kuyvenhoven (consultants) in collaboration with M. Allal, staff member of the Technology and Employment Branch of the ILO.

**A. S. Bhalla,
Chief,
Technology and Employment Branch.**









[Home](#) > [ar.cn.de.en.es.fr.id.it.ph.po.ru.sw](#)



 **Small-Scale Manufacture of Footwear (ILO - WEP, 1982, 228 p.)**

➔ **CHAPTER I. INTRODUCTION**

-  **I. Objectives of the memorandum**
-  **II. The footwear industry**
-  **III. Types of footwear**
-  **IV. Operation reference numbering system and tables of technical data**
-  **V. Scales of production**
-  **VI. Use of the technological information**

Small-Scale Manufacture of Footwear (ILO - WEP, 1982, 228 p.)

CHAPTER I. INTRODUCTION

I. Objectives of the memorandum

The footwear industry constitutes an important sector of the economy of developing countries for the following reasons. Firstly, footwear may be considered as a basic needs item, following closely, in importance, other items such as food, shelter and clothing. Secondly, the manufacture of footwear uses relatively labour-intensive processes, and thus contributes substantially to employment generation. Thirdly, this sector can, in some cases, generate important backward linkages whenever leather is locally produced. Forward linkages are also generated in the marketing of footwear. Finally, developing countries enjoy a comparative advantage in the manufacture and export of footwear to industrialised countries: thus, this sector could be the source of much needed foreign exchange.

Given the importance of the footwear industry for developing countries, it is essential that socio-economic benefits derived from its expansion be maximised. In other words, the choice of footwear type and quality and that of technology and scale of production should be such as to contribute to the overall development strategy of a country. However, recent developments in the footwear industry of developing countries tend to indicate that many of the choices which are made - in terms of technology, scale of production and footwear type and quality - are not always in line with the adopted development objectives. Many developing countries have allowed the establishment of large-scale, capital-intensive footwear plants, often owned and operated by foreign investors. These plants have, in some cases, been responsible for the closing down of local small-scale factories although the latter produced good quality footwear at moderate prices.¹ Furthermore, few countries offer effective assistance to small-scale footwear producers with a view to improving their competitiveness and profitability. Thus, developing countries have often allowed the establishment of what may be called a "technological dualism" in the footwear industry whereby large-scale, capital-intensive footwear plants compete against ill-equipped artisans and small-scale producers.

¹ This may be explained by the prestige associated with footwear produced under internationally known brands.

The above considerations should not lead one to conclude that large-scale modern footwear plants should not be established under any circumstances. These plants may, in many cases, be justified (e.g. for the production of inexpensive plastic sandals or the production of footwear for the export market). It is only suggested that public planners and project evaluators should carefully consider future large investments in this sector with a view to determining whether they are justified or whether small-scale production should be promoted instead.

In order to be able to better plan the expansion of the footwear industry, public planners and project evaluators need detailed technical and economic information on alternative footwear projects (e.g. scales of production, alternative manufacturing technologies, foreign exchange savings, employment effects). This information is also of great importance to potential shoe manufacturers who wish to invest limited funds in profitable projects. Unfortunately, the existing information is more relevant to industrialised countries' conditions than to those prevailing in developing countries. Thus, the technologies, footwear types and quality, and scales of production analysed or advertised in trade journals tend to reflect the market conditions of industrialised countries as well as their economic structures (e.g. relatively low unemployment rates when compared to those prevailing in developing countries (e.g. relatively abundant capital and foreign exchange, highly skilled labour). Consequently, the purpose of this technical memorandum is to partially bridge the information gap by providing information on technologies suitable for developing countries's conditions and circumstances, and by evaluating these technologies in the light of these countries' economic structure.

It is hoped that this memorandum will be of assistance to decision makers - entrepreneurs, public planners, project evaluators - concerned with footwear manufacture. It has been prepared in an awareness that it is often difficult in developing countries to obtain information on alternative footwear production methods. The primary concerns of the memorandum are to describe ranges of alternative ways of making footwear and to show how the most suitable combination of alternatives for a particular set of circumstances can be identified.

II. The footwear industry

In recent years, there has been a tendency for the footwear sector in the developing world to become increasingly successful in exporting to industrially developed countries. Domestic markets in developing countries for locally produced footwear have also grown, partly at the expense of developed country exports. These new trends have resulted in the establishment of relatively large-scale, capital-intensive plants. Local enterprises with less access to technical information have thus tended to adopt manufacturing methods similar to those in 'turn-key' factories, at the expense of technologies more suitable to local conditions, especially at low scales of production.

Scale of output is only one of the factors affecting technical choice in the industry- As shown in Chapters Hand III, choice of footwear type, quality and durability is also a crucial factor. Low income consumers concerned with satisfying basic health needs or obtaining the foot protection necessary for many activities may, for example, be less concerned with the variety of styles available than with retail price. Generally, the narrower the product variety required from a manufacturing enterprise at a given level of output, the greater the level of mechanisation that can be economically justified.

Technical choice of manufacturing methods can also be affected by the level of specialisation in shoe parts. In addition to this scope for enterprises to supply a number of customers with components, a group of producers may share the use of common facilities for some manufacturing stages. Other considerations that can affect technical choices are the availability and cost of imported and locally produced manufacturing equipment and the cost of borrowing capital. Finally, the relationships between the levels of wages, manual skills and the working paces of operatives, and the degree of utilisation of capital equipment are extremely important considerations.

These factors are analysed in detail in chapters IV and V.

III. Types of footwear

Chapters II and III contain descriptions of alternative manufacturing methods and equipment that can be used for the production of the following types of footwear:

Type 1: Leather-Upper, Cement-Lasted Shoes with Cemented-on Soles,

Type 2: Leather-Upper, Cement-Lasted Shoes with Moulded-on Soles,

Type 3: Leather Upper, Tack-Lasted Shoes with Stitched-on Leather Soles,

Type 4: Welded-Synthetic Upper, String-Lasted Shoes with Moulded-on Soles,

Type 5: Stitched Synthetic-Upper, Cement-Lasted Sandals and Casuals with Cemented-on Built Unit Soles,

Type 6: One-Shot Injection Moulded Plastic Sandals.

Type 1, which is the subject of Chapter II, is, for our purposes, considered to be the standard method of construction. More space is devoted to Type 1 footwear than to the other five types because some of them can be made by processes used for Type 1. The chart of production stages in Figure I.1 illustrates how constructional features of the six types of shoe and sandal can be combined in a variety of ways.

The six constructional methods considered in this memorandum are only a small proportion of the possible combinations of methods shown on the chart. For example, shoes having stitched leather uppers and cemented-on prefinished soles could be lasted using tacks, cement or string, but only the combination involving cement lasting is dealt with. However, all the techniques required to construct the tack and string-lasted alternatives are dealt with in the context of other types. In all, forty-six different construction methods are possible using the alternatives shown in Figure I.1. Although these forty-six methods cover far from all the possible forms of footwear construction, it is likely that they account for about ninety per cent of the total output volume of non-rubber footwear. Rubber footwear are outside the scope of this memorandum.

Simplified cross-sections of shoes made on the basis of the adopted six types of construction are shown in Figure I.2. Readers who are unfamiliar with footwear manufacture may find it useful to consult the glossary of terms at the end of this memorandum.

IV. Operation reference numbering system and tables of technical data

The manufacturing sequence is listed at the start of the sections dealing with each of the footwear types covered in Chapters II and III. Each of the sub-process stages is given a unique operation reference number. Consequently, if a process is common to two or more footwear types, cross-references are made to avoid repeating the description of manufacturing techniques.

The operation reference numbering system is also used in the tabulations of technical data which follow the discussions of manufacturing methods that may be used at each stage. The tabulations cover a range of scales of output but do not include the details of each alternative technique mentioned in the text.

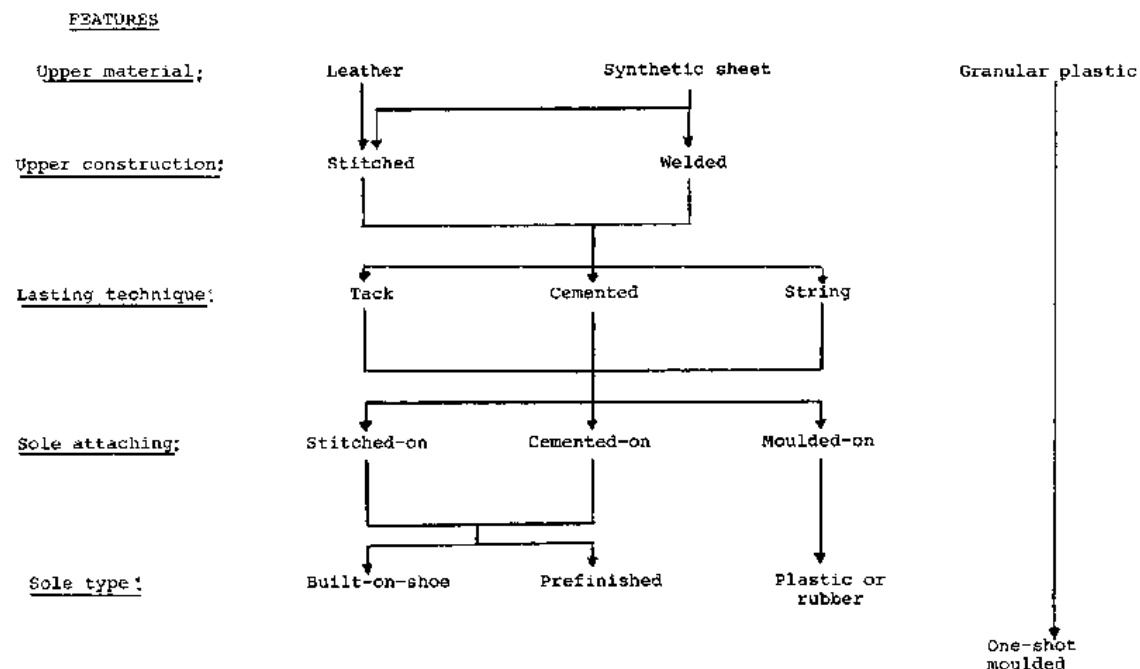
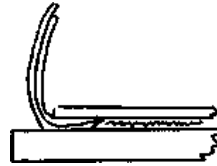
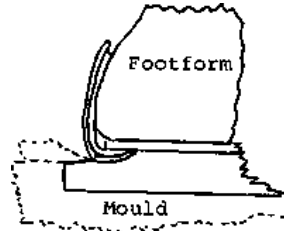
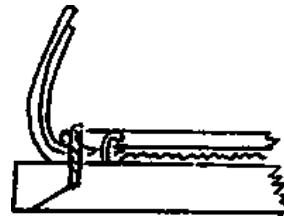
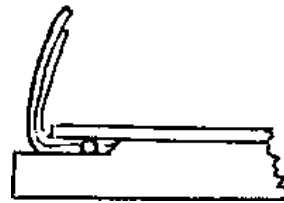
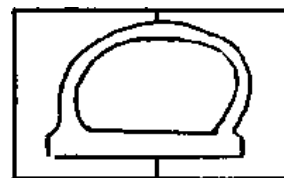

Figure I.1 Combinations of construction methods**Figure I.2 Simplified cross-sections of footwear types 1 to 6****Types 1 and 5. Cement-lasted cemented-on sole****Type 2. Cement-lasted, moulded on sole****Type 3. Tack-lasted, machine-sewn sole****Type 4. String-lasted, moulded-on sole****Type 6. One-shot moulded sandal (in mould)**

The combinations of techniques described in Chapters II and III have not been chosen on the basis of specific sets of productivity levels, wage rates or the cost of various inputs. They have been selected on the basis of extensive analyses of footwear projects located in both developing¹ and developed countries. Alternative production techniques were evaluated for each manufacturing sub-process, taking into account the range of wage levels, interest rates, labour productivities, equipment capacity utilisations etc. most prevalent in the majority of developing countries. Thus, techniques which could never be justified under the above range of values are not considered in chapters II and III. The alternative to this approach would have been to describe all alternative combinations of techniques used in the production of the six types of footwear, and to let the reader evaluate each alternative on the basis of local factor prices. This latter approach is not however feasible since it would have been necessary to describe thousands of alternative projects.² Thus, the adopted approach consists in describing only those combinations of techniques which are relevant to developing countries' conditions. There may, however, be cases whereby particular circumstances could justify the adoption of combinations of techniques not covered in chapters II and III. The reader should therefore analyse additional combinations whenever he may feel that these could be more cost-effective than the alternative combinations described in the above chapters. The information needed to analyse other combinations of techniques is provided in the text of these chapters.

¹ Some of the investigated footwear projects were located in Ghana, Ethiopia, Jamaica and El Salvador. Chapter IV provides detailed economic data for the Ethiopian and Ghanaian projects.

² The manufacture of a typical footwear requires as much as 31 operations. If two or three techniques may be used for each operation, the total number of combinations of techniques used in the production of footwear may be calculated at tens of thousands.

Equipment costs are quoted in U.S. Dollars at mid-1979 exchange rates. A list of equipment suppliers for each operation reference number is provided in Appendix II. The tabulations in Chapters II and III include descriptions of the production operation and of the selected equipment and method, the required quantity of each item and the source of the equipment (for example, locally made) and its approximate cost. It is assumed that an electricity supply is available for all scales of production. Equipment requiring compressed air systems is excluded at the small scales.

For Type 1 footwear, some additional data is provided at the end of Chapter II. The materials handling methods, associated workforce and estimated equipment costs that could be found appropriate in an enterprise manufacturing Type 1 footwear are detailed. The total production floor areas, including space for work in progress and aisles, together with block plans of factories suitable for producing 8 to 1,000 pairs of Type 1 footwear per day are provided. This information should also be relevant for the other types of footwear.

Summaries of the materials required for each type of construction are given in Table I.1. Since the amount of materials per unit of output is generally unaffected by the level of mechanisation of the manufacturing process or scale of production, this factor does not need to be taken into consideration when evaluating alternative production techniques used in the production of a given type of footwear.

V. Scales of production

The levels of output that are considered were selected to span a range from a very small scale to the largest manufacturing scale likely to be set up without considerable external assistance. Technical data is provided for four scales of production and for each of the six types of footwear. These scales of production expressed in terms of pairs produced per single shift day, are 8, 40, 200 and 1,000. They are referred to as Scales 1, 2, 3 and 4 respectively. These scales were selected because they are part of a geometric progression weighted towards the smaller volume end of the range.

An additional table shows for each footwear type the number of workers directly required for production at each manufacturing stage and for each scale of output.

VI. Use of the technological information

While it is not intended for Chapters II and III to act as an instruction manual in footwear manufacture, it is hoped that the discussion of alternatives will serve several purposes.

First, readers from enterprises at present specialising in a limited range of techniques and types of footwear construction may identify possibilities for innovations in their products on the basis of information contained in this memorandum. Second, the attention of the reader is drawn to situations in which machinery is likely to reduce manufacturing times but not substitute for manual skills, or contribute to product quality conformance. Reducing operation times may not be a major objective in very small enterprises with spare manufacturing capacity. Equipment that only speeds up output may therefore be unnecessary.

Table I.1 Specifications of materials used in the construction of footwear Types 1 to 6

Footwear	Upper components			
	Uppers	Linings	Stiffeners	Puffs
1	Leather	Leather/synth. sheet	Leather/board	Solvent act.
2.	Leather	Leather/synth. sheet	Leather/board	Solvent act.
3	Leather	Leather/synth. sheet	Leather/board	Leather/ solvent act.
4	Synthetic	Synthetic sheet	Board/ thermoplastic	Solvent act./ thermoplastic
5	Synthetic	Synthetic sheet	None	None
6		One shot moulded		
	Bottom components			
	Insoles	Bottom filler	Shanks	Soles/Heels
1	Board	Felt	Steel/wood	Prefinished units
2	Board	Felt/heel core	Steel/wood	PVC moulded-on
3	Leather or board	Felt/scrap leather	Steel/wood	Leather, built on shoe
4	Board/synth. sheet	None	Steel	PVC moulded-on
5	Board	Felt	Steel/wood	Resin sheets, units, built

The third aim is to alert potential users to the wide range of manufacturing equipment and tools that are available. The choice of equipment that is described includes: machines specially designed to perform particular operations in footwear manufacture, general purpose tools and equipment which are not designed specifically for the industry but are suitable for some of the operations, and equipment that is not generally available commercially but that small enterprises could find useful and which could be produced in industrially developing countries.

Fourth, for each sub-process stage the description of the manufacturing methods and the tabulated technical data are presented as separate elements. As explained earlier, many of the technical elements dealt with in connection with each type of footwear can be combined to construct a range of other footwear types. The elements described can also be used whenever an enterprise only engages in a single stage or a few manufacturing stages. Thus, for example, the techniques suitable for insole preparation in a large enterprise undertaking all the manufacturing stages could be identical to the techniques appropriate in a very small enterprise which only prepares insoles in large numbers. This matter is further elaborated in Chapter V.



[Home](#) > [ar](#) [cn](#) [de](#) [en](#) [es](#) [fr](#) [id](#) [it](#) [ph](#) [po](#) [ru](#) [sw](#)



Small-Scale Manufacture of Footwear (ILO - WEP, 1982, 228 p.)

➔ CHAPTER II. MANUFACTURING TECHNOLOGY FOR TYPE 1 FOOTWEAR

(introduction...)

I. Operation sequence

II. Detailed description of processing stages

II.1 Cutting uppers (Operation reference No. 1)

II.2 Upper preparation

II.3 Upper stitching (Operation reference No. 9)

II.4 Stitched upper finishing

II.5 Bottom component preparation

II.6 Making

II.7 Shoe finishing and packing (Operation reference No. 31)

III. Table of technical data

III.1 Material handling resources, work force and production floor area

III.2 Workforce allocation: Table II.4

III.3 Equipment specification: Table II.5

IV. Floor plans for production areas

Small-Scale Manufacture of Footwear (ILO - WEP, 1982, 228 p.)**CHAPTER II. MANUFACTURING TECHNOLOGY FOR TYPE 1 FOOTWEAR**

The objectives of this chapter are to describe methods of constructing walking shoes of conventional design and to examine the range of manufacturing techniques available at each processing stage. Such shoes have cement-lasted leather uppers and cemented on sole units that do not require finishing once assembled. This manufacturing technique is now widely used by shoe manufacturers.

These shoes are referred to throughout the text as Type 1. A reason for their popularity is that lasting tacks and the accompanying heavy insoles are unnecessary, which results in light and flexible footwear. Also, unit soles avoid the need for skilled and lengthy finishing operations often required when soles and heels are 'built' on the lasted shoe.

I. Operation sequence

Stages in the manufacture of a Type 1 man's shoe are shown in Figure II.1. In summary, manufacture first involves cutting out the upper components from skins and the linings and insoles from leather or fabric and man-made sheets. Next, the edges of the upper components are tapered, or skived, to reduce the bulk of seams. The eyelets are then inserted in lacing styles and the various upper components are stitched and cemented together, stitched upper counter puff insole lasted shoe V shank sole unit completed shoe

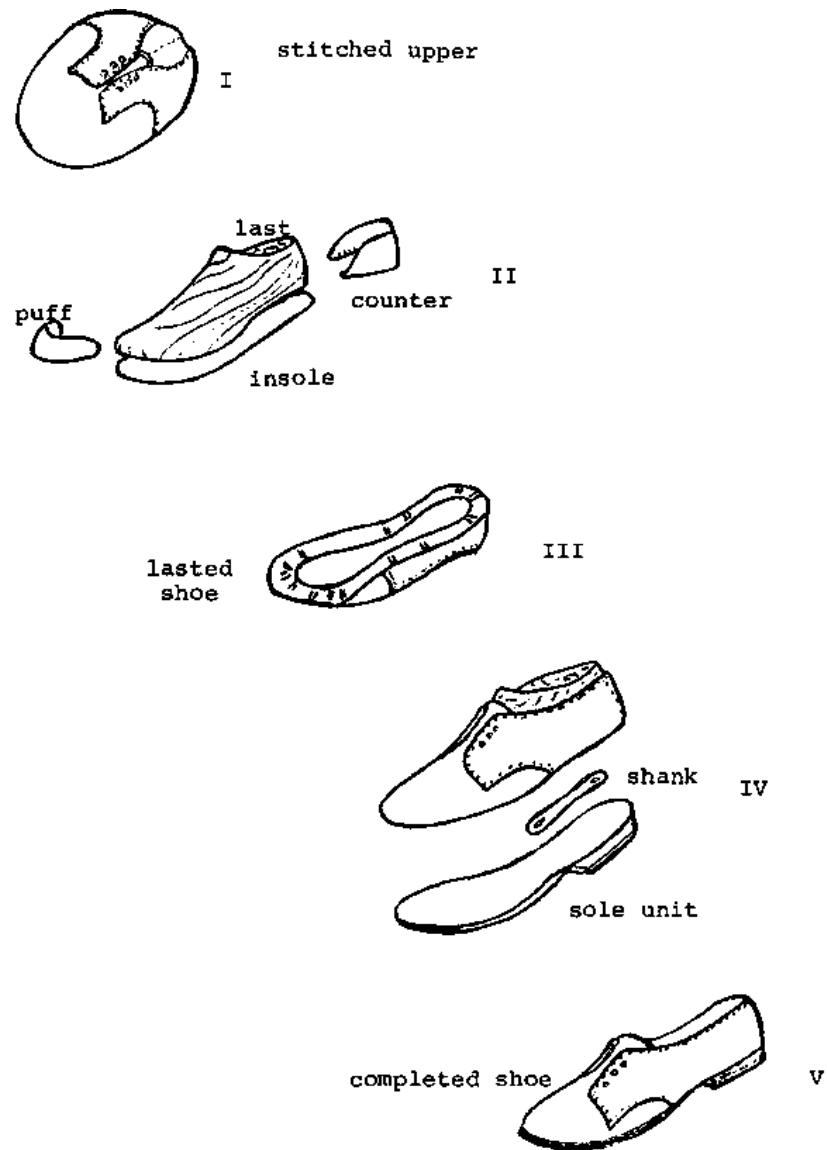

Figure II.1 Stages in the manufacture of Type 1 footwear

The stitched upper of a plain lacing style is shown at 1. The insoles are then attached temporarily to the bottom of the last by tacks, and the heel stiffeners and the toe puffs (which respectively help shape the backs and toes) are located. At II, a toe puff, a heel stiffener, and an insole ready for assembly with the upper on a wooden last, are illustrated. Cement lasting involves stretching the edge of the upper round the last bottom and attaching it to the insole bottom with cement. After removing the tacks holding the insole to the last, the shoes are conditioned, the shanks which stiffen up the waist of the shoe are attached to the insoles, and the sole units are stuck on to the bottom. IV shows a shank and sole unit, and V a finished

shoe after the removal of the last. The final manufacturing stages involve cleaning, inspecting and packaging.

A full list of the manufacturing stages is given in Table II.1. The departmental divisions indicated in the table are often ignored in small enterprises. The points at which major inputs occur are listed, but for the sake of clarity minor consumables such as tacks, cements and finishing solutions (mentioned in the text) are not shown. In terms of human resources, cutting, stitching and lasting require more inputs than the other operations and, consequently, they receive the greatest attention.

II. Detailed description of processing stages

II.1 Cutting uppers (Operation reference No. 1)

The way in which upper components are cut, or 'clicked', out of skins can have a considerable influence on the cost, appearance, comfort and wear resistance of finished shoes and on how well they retain their shape in use. Because leather is expensive, it is important that it is cut in the most economical manner, thus providing cut components of the required quality while minimising the amount of waste leather.

II.1.1 Hand cutting

Hand cutting is exclusively used in scales 1 and 2 (8 and 40 pairs per day) and used in some of the operations in scales 3 and 4 (200 and 1000 pairs per day). Choosing the best cutting pattern on a particular skin is the most important and difficult part of a leather cutter's task. Cutting by hand rather than machine should not affect the quality of the components. In hand cutting, a knife held in one hand cuts round the contour of the required shape with the material laid on a board, and the second hand preventing the pattern from slipping. Long continuous clean cuts are desirable since short cutting strokes will leave the profile with irregular edges and cause problems during the subsequent edge tapering, or skiving, operation.

Table II.1 Stages in the production of leather-upper cement shoes with cemented-on unit soles

Production stages	Op. Ref	Operations	Major materials
Upper-cutting	1.	Cutting upper components	Skins and lining materials
Upper preparation	2.	Leather splitting	
	3.	Lining marking	
	4.	Stitch marking	
	5.	Hole punching	
	6.	Sock embossing	
	7.	Skiving	
	8.	Edge folding and cementing	
Upper stitching	9.	Stiching of uppers	Threads, tapes
Stitched Upper finishing	10.	Seam reducing	
	11.	Tapina	Tapes

	12.	Eyelet reinforcing	
	13.	Punching and eyelet insertion	Eyelets
	14.	Temporary lacing	String
	15.	General fitting and puff attaching	Trim, puffs
	16.	Upper trimming	
Bottom component preparation	17.	Insole preparation	Insole sheeting
	18.	Sole cementing and drying	Sole units
Making	19.	Insole tacking	
	20.	Stiffener insertion	Heel stiffeners
	21.	Upper conditioning	
	22.	Cement lasting	
	23.	Tack removal and inspection	
	24.	Heat setting	
	25.	Bottom roughing	
	26.	Shank attaching	Shanks
	27.	Bottom cementing	
	28.	Bottom filler insertion	Felt
	29.	Sole laying	
	30.	Last removal	
Upper finishing	31	Upper finishing operations and packing	Packing materials

The edges of hand-cut components should be cut square to their surfaces to faithfully reproduce the required shape. Cutting at acute angle to the leather surface with a straight blade produces vertical as well as horizontal forces which help hold thin leather and fabric against the board, thus preventing buckling and tearing.

When upper components are cut from skins, only one thickness can be cut at a time so that blemishes may be seen and avoided by operatives. This puts hand cutting at less of a disadvantage compared to machine cutting than if it were technically feasible to cut skins in a stack.

The equipment used in hand cutting includes the following:

(i) Clicking knives

Ranges of interchangeable, differently shaped, blades are available to fit specially designed hand clicking knives. Blades used for heavy leathers have longitudinal concave cutting edges about 30 mm. long so that the cutting edge is

nearly at right angles to the surface of the leather. This type of blades avoids over-running at corners.

To keep hand cutting knives very sharp, a strip of waxed calf skin can be fixed along the edge of the cutting bench. Stopping the blade on this strip between cuts reduces the frequency with which it is necessary to sharpen the blade on emery. Apart from accelerating the blade wear, rubbing the blade on emery heats it up and tends to remove the temper.

Clicking knives may be made out of a broken hacksaw by grinding one edge of the hacksaw to shape, and by wrapping insulating tape around part of the blade. These knives may be used in place of the special purpose knives marketed by various tools manufacturers.

Figure II.2 shows three differently shaped clicking knives.

(ii) Patterns and cutting boards

Patterns are sometimes made of galvanised sheet steel, but more often they are of rigid fibre-board with their edges bound all round with a brass channel strip to prevent knives from cutting into the card.

Cutting boards are normally 70-100 mm. thick with a roughly square surface of about one half square metre (e.g. 70 cm x 70 cm). Boards can be of artificial fibre or of wood with blocks of pine or lime bonded together so that their end grains form the cutting surface. This reduces the rate at which the surface is cut away. The benches are usually high enough to permit cutting in the standing position.

(iii) Awls

Awls about the size of old fashioned gramophone needles can be fitted to the end of a knife handle, and are used to prick stitching and lapping guide holes on upper components.

II.1.2 Mechanised Cutting

Mechanised cutting should be used in some of the operations in scales 3 and 4. It commonly uses cutting presses and strip steel knives cold bent to the shape of the pattern. Some high speed automatic processes using lasers or water jets are available for cutting stacked man-made materials but such equipment is only economical if output volumes are very large.

Figure II. 2 Simply made cutting tools

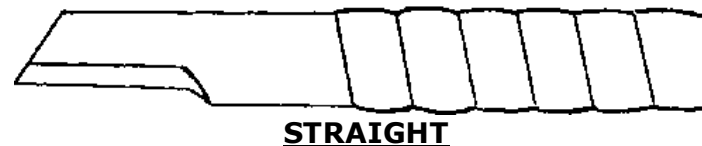

The knife may be made from hacksaw blades wrapped with insulating tape.

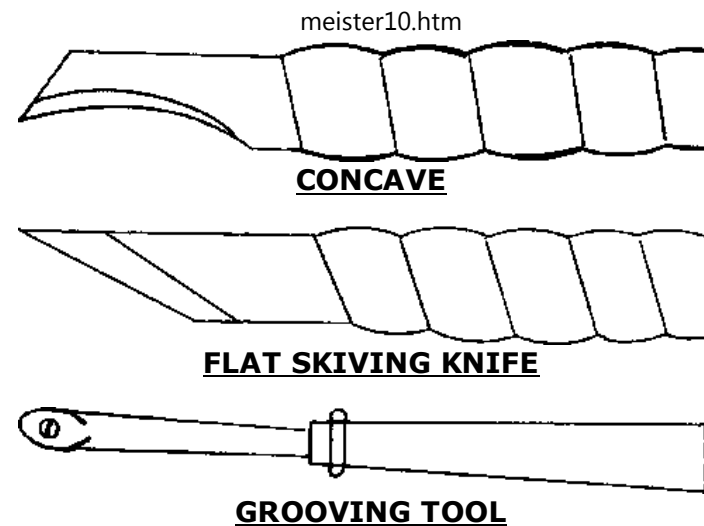

The grooving tool can be made from an old screwdriver softened before drilling, with its cutting edge formed with a very small round file, then sharpened with a narrow strip of fine emery cloth.

Note: The steel may be softened by heating and slow cooling then hardened by heating and quenching in oil.

The equipment used in mechanised cutting include the following:

(i) Press knives

Press knives for cutting single thickness of material are usually reversible with cutting blades on both their top and bottom edges so that only one knife needs to be used for pairs of right and left foot components. In cases where it is unnecessary to see the top surface of the material before cutting, cuts can be made from both sides of the material with a single edged cutter to produce left and right foot components. These knives are made from thin strips of steel. Frequent checks are required in order to ensure that they have not been distorted. To produce clean cuts, the knives must be sharp. Special purpose edge dressing machines are available to help regrind knives. Rotating grinding wheels can also be used for knife sharpening but care is necessary to avoid "burning" the edge by exerting too much pressure.

Notches to indicate the component size can be incorporated into the knives. Alternatively, cut edges on components can be hand dabbed with paint of different colours and in different positions so that machinists may bring together the correct components. Machines carrying several rotating wheels which each dip into a different coloured paint, can be used for this purpose. Alternatively, the cutter may merely write the necessary details on the back of the cut components with a piece of chalk. Sometimes, colour marking is undertaken in the preparation and stitching department.

(ii) Cutting presses

Some cutting presses have a "beam" supported between two columns and a cutting head that can be traversed along the beam. Other presses have a cantilevered beam that can swing over the table. The surface of the tables of swing arm presses are usually 1 m long by 0.5 m wide, while travelling head press tables are usually 1.5 or 2m long by 0.5 m wide. The maximum press cutting forces vary from below 10 tonnes on small beam presses to 30 tonnes on large travelling head machines. The simpler presses have hardwood, synthetic rubber or fibreboard cutting blocks, and are mechanically or hydraulically activated. Electronically controlled hydraulic machines are also available, with the attached beam reversing as soon as the knife completes an electric circuit by touching the lower cutting block. This cutting block is made of a soft aluminium alloy to avoid damaging the hardened steel cutting edge. Most manually controlled presses have two hand operated tripping buttons located on top of the beam. These buttons must be pressed simultaneously to activate the cutting cycle, thus reducing the chance of accidents. Some travelling head presses can be controlled by a joystick located on one of the columns, while other presses have a completely automatic pre-programmed cycle to traverse the head and initiate the cutting cycle. Both swing arm and travelling head presses can be equipped with devices for unrolling and feeding fabrics and synthetic material in single or multiple layers. Swinging beam presses can be used to cut wide fabric fed from rolls by arranging one cutting table under two swinging beams facing each other at right angles to the direction in which the material is fed.

The economic break-even scale of production between hand and press cutting is about two thousand pairs of cuts. The point at which the costs switch in favour of one of the two cutting techniques is not a function of the wage level since the cost of knives is the determining factor. Thus, differences in wage levels between developed and developing countries should not determine the use of hand or press cutting. It is the scale of production which determines the choice of cutting technique. For example, even the most highly mechanised factories in developed countries use hand cutting for small scales of production.

II.2 Upper preparation

Manufacturing leather uppers involves preparation, stitching and finishing operations. They consist of a relatively large number of short operations ranging from visual inspection at a bench to assembling the various components on a stitching machine. In terms of work content, stitching is usually the most important of the three types of operations involved, in upper manufacture. Usually, a greater proportion of the workforce is engaged in stitching than in any other activity. Even in its most capital-intensive form, stitching is still a labour-intensive process.

Figure II.3 shows an example of the sequence of operations necessary to produce uppers for an elaborate style of men's leather upper. The sequence of operations required to prepare components prior to stitching and finishing may vary widely from style to style. In large factories, each type of work may be carried out in a separate department and, sometimes, stitching of different types of upper is divided between a number of departments. If the lot, or batch, sizes of components were very large, each operation shown in Figure II.3 may need to be performed on a separate machine. On the other hand, small enterprises may carry out many of the stitching operations on a single machine. Since this memorandum is principally concerned with small-scale production, descriptions of the equipment available for the different types of work are grouped together.

II.2.1 Leather splitting (Operation reference No. 2)

The leather splitting may be economically performed by shoe manufacturing plants producing at least 2000 pairs per day (i.e.

scale 4).

Cut leather components that are thicker than required or have uneven thickness due to loose flesh adhering to their underside can be split on a band knife machine. The thickness of the split may vary from about 5 mm. down to zero. The machine has a continuous strip knife blade running horizontally between two large rotating wheels using the principle employed in a band saw. The components to be reduced are fed between a pair of feed rolls which move the work past the knife blade. The whole area of the component is reduced to the pre-set thickness and the waste is collected in a box.

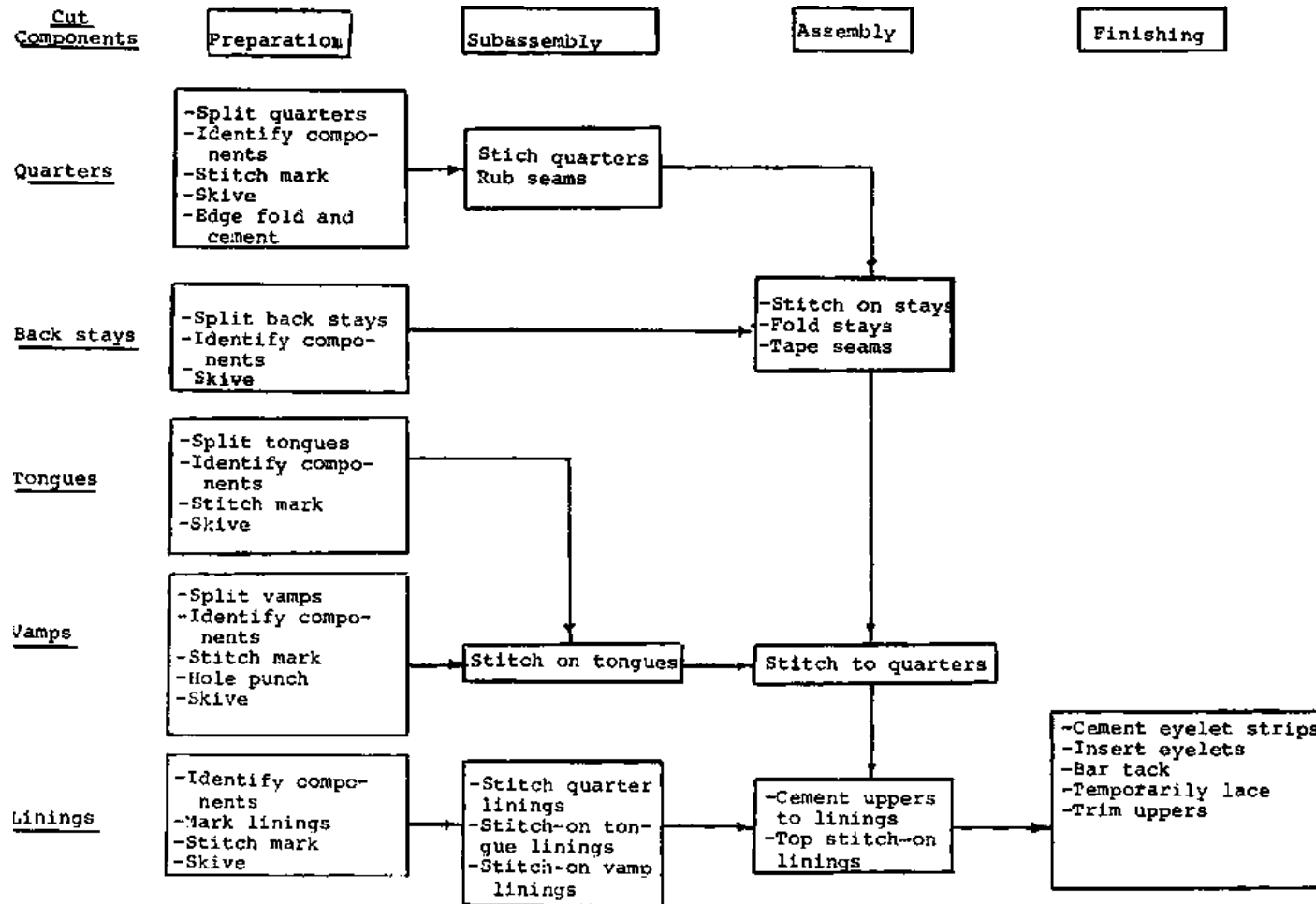

Figure II.3 Typical work flow during preparation and stitching

Footwear manufacturing enterprises in developing countries that do not find it necessary to invest in band knife splitters (i.e. enterprises operating at scales 1 to 3) may depend on local tanners to supply leather of the required thicknesses. Otherwise, they may remove uneven flesh areas by hand, with a sharp steel scraper blade held at right angles to the surface of the

leather.

II.2.2 Lining marking (Operation reference No. 3)

It is common for details of each pair of shoes to be marked on the uppers. Marking helps identify pairs of shoes at subsequent stages of manufacture, and facilitates the ordering of repeats by trade customers. Details usually include style number, size, width fitting and last number. On unlined shoes, the information is sometimes printed on top of the tongue, but in the majority of cases it is marked on the quarter linings.

Three techniques may be used for lining marking:

- (i) Details may be written by hand with ball point pens if one wishes to convey an expensive individual appearance,**
- (ii) Use of an inkpad and rubber stamp,**
- (iii) Specially designed stamping machines, that can be mounted on a bench, are available for large-scale production. These machines have stamping heads, and use automatically dispensed foil embossing strips. The type is mounted on the circumference of adjustable wheels.**

II.2.3 Stitch marking (Operation reference No. 4)

Guide marks help stitching machinists to accurately overlap upper sections, and to correctly position fancy stitches, buckles, eyelets and trims. Two techniques may be used for stitch marking, depending on the adopted scale of production:

(i) Use of press cutting knives

This method may be adopted for scales 1 to 3 (i.e. 8 pairs to 200 pairs per day).

Press cutting knives may incorporate notches to indicate the positions at which seams are to start and stop, as well as pricker pins which produce stitch guidance holes. Guide lines can be drawn on upper components with a ball point pen through slots in a flat pattern or template made of fireboard. The template will, in this case, have the same shape as the component on which it is laid.

(ii) Treadle and hand-operated marking machines

For scales of production of 1000 pairs per day and higher, enterprises may use treadle and hand-operated marking machines. These machines use a printing die consisting of a sheet of pattern board to which raised metal or plastic ribs of the desired seam configuration are attached. Ink from a wide ribbon is transferred on the die to a component which is located by pegs on a guide board. Each end of the die block is located by two radial arms to provide a parallel motion. The die block is thus held in a horizontal plane as it swivels over between the inking ribbon and the component laid on the guide board. Springs centre the swivelling die block clear of both the guide board and the ribbon when the machine is not in use.

A similar manual inking method uses fibreboard patterns cut to the component shape. The patterns have plastic ribs attached to both sides in the desired stitch pattern. The pattern with the ribs on its underface loaded with ink is placed on top of a component to be marked. By inking the ribs on the top face of the pattern while pressing the pattern down onto a component, left and right components can be marked alternatively. The replenishment of ink to the ribs on the top face is by means of an inking ribbon running across the bottom face of a hinged plate. The latter is spring loaded upwards so that the operator can load and unload work, and turn the pattern over between strokes of the machine. Each pattern board may be used to cover a range of one and a half British sizes of adult shoes.

These machines can be of wood but are most often of cast iron.

II.2.4 Hole punching (Operation reference No. 5)

Some leather upper design styles require decorative perforations round the edge of toe caps. Hole patterns are also often cut on the foreparts of children's sandals. The following devices may be used for hole punching:

(i) Manual punching tools

Manual punching tools may be used for scales 1 to 3. These tools have blades of the required shape which cut one hole at a time with each hammer blow.

(ii) Hole punching machines

For larger scales of production (scales 4 and higher) hole punching machines become cost-efficient. These machines may consist of top male punches and lower female recesses which are capable of producing a whole pattern (e.g. on a sandal vamp) in one cycle of a hand fly press or light powered bench press. Edge perforations may also be produced by powered punches in which the punch action is synchronised to the edge feed.

II. 2. 5 Sock embossing (Operation reference No. 6)

Brand names and trade marks are usually embossed onto the plastic coated fabric or thin leather socks that are cemented over the seat or the whole of the insole once the sole has been lasted. Normally, gold coloured plastic foil is used for this transfer process although, in the past ,the discolouring action of a heated die was sometimes used to produce a contrast on leather socks.

(i) Local production of embossing equipment

At production scales 1 and 2, a very inexpensive machine can be constructed by mounting an electric iron (which has a variable temperature control) on a hinged arm with the brass embossing die attached to the bottom of the iron. The pressure and duration of contact is controlled by the operator. Consequently, the work quality relies on the operator rather than on predetermined machine settings. Such machines are used by small-scale footwear manufacturing enterprises in developing countries. When used on a continuous basis, these machines may process fifty pairs of socks per hour (see Figure II.4).

(ii) Semi-automatic embossing machines

For higher scales of production (3 and above) high throughput semi-automatic embossing machines are available. Control of die temperature, embossing pressure and dwell time are preset and the operator merely feeds the socks in one after the other. The production rates of these sophisticated machines can reach seven hundred pairs per hour on long runs. Slower, manually operated machines are less expensive but less convenient to operate.

II.2.6 Skiving (Operation reference No. 7)

Skiving is the term used to describe the tapering required on the flesh side of some edges of upper components. On fabric backed materials, it may be necessary to skive the top rather than the flesh surface. The objectives of this important operation are to permit easy assembly, good appearance and wearer comfort.

(i) Manual skiving

Manual skiving may be efficiently adopted for scales of production 1 and 2. The traditional way of carrying out this operation is by hand, using a very sharp flexible steel knife blade and a flat surface such as a solid steel plate, a slab of marble or a sheet of plate glass. The component is laid flesh side up on the surface and held down with the free hand while the excess thickness is sliced off. The knife is held across the flat of the hand and drawn back towards the operator. This method is relatively slow, with a typical output rate of ten pairs of components per operator hour. A good deal of practice is required to produce uniform tapers.

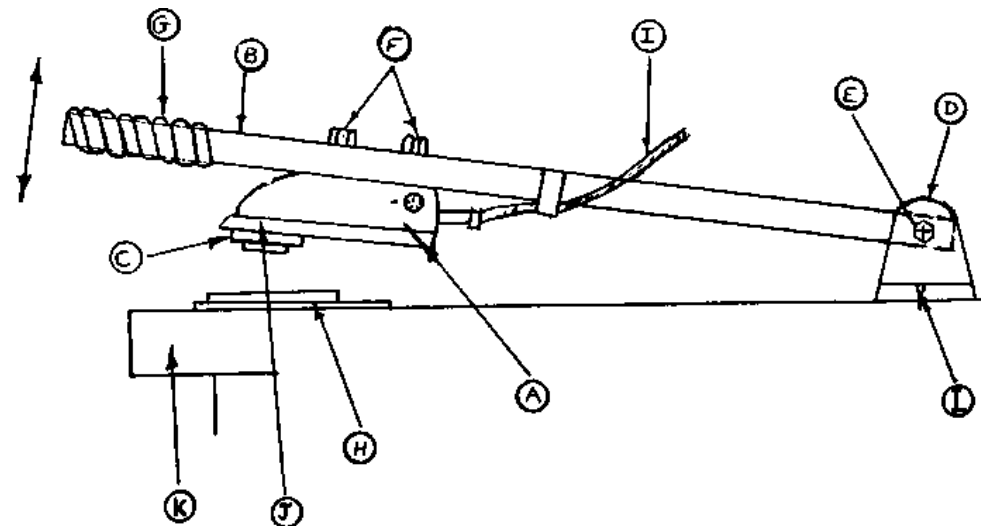

Figure II.4 A simply made insole embosser for small volume production

PARTS LIST

A. Domestic electric iron with adjustable thermostat with handle removed.

- B. Steel tube, 30 mm. diameter by 650 mm. long drilled for hinge bolt and screws to hold iron.**
- C. Proprietary brass embossing die.**
- D. Hinge blocks of steel angle section or wood drilled to hinge and screwing to work bench.**
- E. 10 mm. diameter bolt, nut and washers to act as hinge pin.**
- F. Screws to attach the body of the iron to tube and the die to the sole of the iron.**
- G. Insulating tape.**
- H. Workpiece to be embossed with precut strip of embossing foil laid on it.**
- I. Flex for mains.**
- J. Sole of iron drilled and tapped for attachment of embossing die.**
- K. Work bench.**
- L. Two hinge bracket screwed to work bench.**

Note: The best combination of pressure, temperature and application time should be found by means of trials.

(ii) Skiving machines

For higher scales of production (3 and above) the use of skiving machines may become more efficient. The most widely used type of skiving machine employs a rapidly rotating steel disc with the cutting edge on its circumference, past which the component is carried. The edge support plate, which guides the component, is adjustable for scarf width and angle.

Machines are available that can be preset to produce two or three different knife angles at the flick of a pedal so that a component requiring different treatments along different edges may be completed in one pick up. The skill required to set these rotating cutter machines varies considerably from model to model. In operation, these machines require substantially less skill to produce good results than skiving by hand and their output can be about fifty pairs per operator hour on a typical men's style with five leather upper components per shoe.

(iii) Matrix skiving

A more recently introduced method, called matrix skiving, requires fixtures or matrices made from sheets of hard rubber or composite material which have recesses sculptured into one side. These recesses are shaped to the size and contour of the finished component. This method is, in general, economically viable when more than two edges of a component require skiving, and when there is a sufficient volume of work to justify the cost of producing the recessed work holding fixtures for each size of each component. In matrix skiving, components are laid flat in the recesses,

with only the material to be removed protruding. The loaded fixtures are then guided through a band knife splitting machine similar to that described earlier in connection with leather splitting. The knife removes the surplus thickness from the areas of the component protruding above the top surface of the fixture.

II.2.7 Edge folding and cementing (Operation reference No. 8)

This operation may be carried out on unassembled components or on partly stitched uppers. Several methods of folding over and cementing down the top lines of uppers are available.

(i) Manual folding and cementing

Manual folding and cementing may be efficiently used for scales of production 1 and 2. The output rate of manual methods is estimated at approximately 12 to 15 pairs per operator hour. The usual sequence used in manual folding and cementing includes the following: adhesive application, notching of curves, folding over the straights, pleating the bends, and flattening the folds. The last operation involves tapping down the folds with a short, flat-ended metal bar or similar tool. A metal template can be useful in maintaining an even fold line.

Figure II.5 shows a hand tool for cementing down folded skived edges.

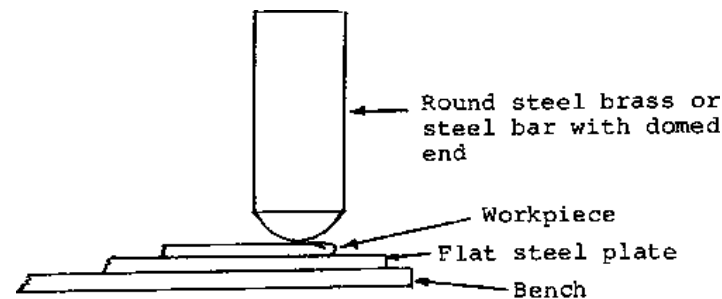

Figure II.5 Hand tool for cementing down folded skived edges

(ii) Folding and cementing machines

For higher outputs (e.g. production scales 3 and above) various expensive electronically controlled machines are available. These machines require relatively little operator skill, but need a good deal of maintenance back-up.

Electronically controlled machines incorporate photo-electric cells that automatically sense bends requiring snipping and pleating, and also dispense thermoplastic adhesive to bond the material in position. The operator feeds the components and controls the speed with a foot pedal. A narrow tape can be incorporated into the fold to limit stretch.

The output of these machines is estimated at approximately 80 pairs per operator hour. Simpler machines, similar in overall design concept to the above machines, are also available at lower prices. These simpler machines do not include electronic components, and their output rate is estimated at approximately 40 pairs per operator hour.

Equipment for producing other types of edge finishes is discussed in the section dealing with stitching.

II.3 Upper stitching (Operation reference No. 9)

II.3.1 Stitching methods

Stitching may be carried out by hand or by stitching machines. However, manual stitching is rarely used in the construction of uppers except in the stitching of mocassins for the production of decorative effects. Even in countries where capital is very scarce and wages very low, stitching machines are usually employed in very small production units. The reason for this is that stitching machines are extremely productive. An operator using such machines can construct as much as two metres of double rowed lapped seam per minute. He can also form regularly spaced and tensioned lock stitches at a rate of forty per second. Even the most skillful hand stitcher would find it difficult to achieve one per cent of this output. Consequently, the use of stitching machines may be shown to be much more cost-effective than manual stitching for all but the lowest scales of production.

II.3.2 Stitching machines

Most stitching machines produce lock stitches which have a top thread fed by the needle and a bottom thread fed from a bobbin. The lock between the top and the bottom threads should be concealed within the material. Chain stitches only require a top thread, but it unravels if the thread breaks.

Stitched seams can be produced on components with edges cut to matching or different contours when flat. When the contours do not match, stitching them together produces assemblies with seams curved in three dimensions at once. This reduces the amount of curvature that it is necessary to impart during lasting.

On some machines, the stitch length is adjustable. On variable stitch length machines, the work is stationary while the point of the needle is below the needle plate and the work is advanced between stitches. This type of machine is more often used on light work where variability of the feed rate is unimportant. It is necessary to change the gearing ratios to alter the stitch length on fixed feed rate machines. Their needles and needle plates oscillate at the same rates so that the work is advanced while the needle is below the needle plate. On all types of stitcher, the thread tension can be varied to suit particular types of work.

Machines having flat beds are used for a wide range of work, such as stitching in eyelet reinforcing strips and other work that can easily be stitched on a flat surface.

In post bed machines, the bobbin is located at the top of a vertical post below the needle. The small working platform at the top of the post enables sprung seams to be constructed more easily than on flat bed machines, since the material can hang down clear of the area being stitched. Machines are available with a choice of the post located to the left or right of the needle.

Figure II.6 Types of stitching machines

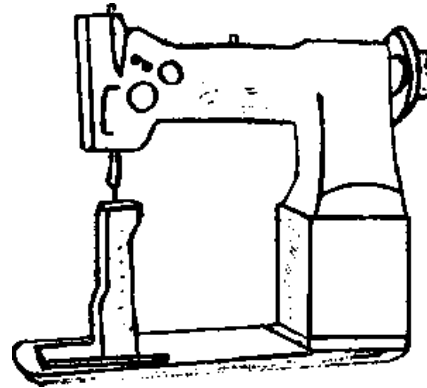

POST BED MACHINE

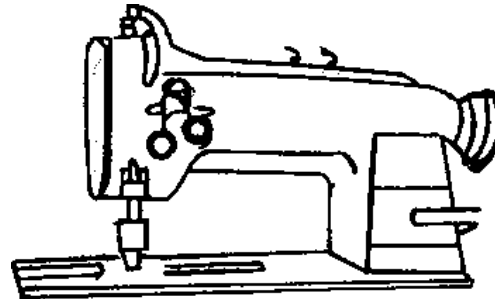

TWIN NEEDLE FLAT BED MACHINE

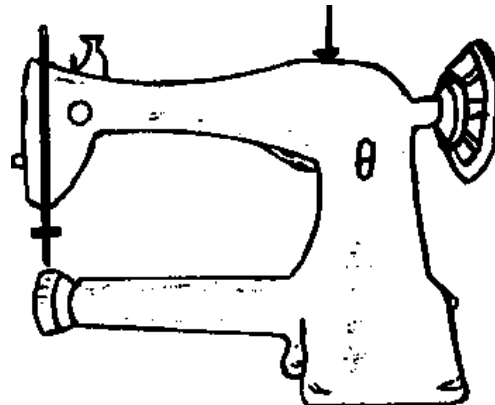

CYLINDER ARM MACHINE

Once uppers have been closed down the back seams, they can be stitched on cylinder arm machines in which the bobbin is located at the end of a horizontal arm cantilevered out from the main vertical column. Long boots are also closed on cylinder arm machines.

Special purpose treadle driven machines which are designed so that the work can be fed in any direction during stitching are still popular for repair work in developed countries.

(i) Semi-automatic machines

Semi-automatic machines can include under-bed thread trimming devices to cut off surplus yarn at the end of a seam as well as edge trimming devices. On some of these machines, the operator can pre-select to finish a seam with a needle up or down, which reduces the time required to remove work at the end of a run, or to turn sharp corners by rotating the work round the table.

(ii) Automatic machines

This type of machines, which costs approximately US\$ 2,000, does not require the operator to guide the work past the needle. Manufacturers normally sell automatic machine set up with cams and guides to produce a pre-determined shape of stitch pattern. These machines may be easily adjusted for stitching patterns of different sizes. However, most footwear manufacturers would find it extremely difficult, if not impossible, to adjust these machines for stitching basically different patterns.

Most enterprises in developed countries which handle a sufficiently large volume of repetitive work such as bar tacking, buckle attaching and tongue attaching use a few automatic machines. It is sometimes possible for an operator to manage two of these machines by loading and unloading one machine while the other is stitching. Some machine manufacturers offer pairs of automatic machines ganged together to carry out a back seaming and frenching sequence.

Microprocessor controlled automatic machines, each requiring an initial investment of approximately US\$ 20,000, are now available. These machines, which are programmed by means of tape cassettes, were first used for fancy stitch designs on the sides of boot uppers but are now also used for flat multi-part seaming.

(iii) Choice of stitching machines

Brief specifications of some types of stitching machines suitable for the footwear industry are given in Table II.2 The type of work for which each machine is likely to be appropriate is indicated in the table and further discussed below.

Stitchers are normally described according to their physical characteristics or the type of work that they are intended to carry out. Some of the more commonly specified options are listed below:

Number of needles: single, twin or three Type of stitch: chain or lock

Type of top presser: foot, idler roller or driven top roller

Stitch length: variable or fixed

Stitch pattern: straight or zig zag

One of the most popular combinations of these options found on machines used by small-scale enterprises in developing

countries is: straight lock stitching, single needle, roller presser and flat bed. Without motor, stand clutch or lighting, such machines can cost less than US\$400. It is feasible to make good quality footwear on such general purpose machines. However, some operations will take longer on these machines than on more specialised types costing approximately US\$2,000.

Table II. 2 Brief description of some machines suitable for stitching uppers

Operations	Description
Under edge trimming of top lines	Single (needle) , post (bed), roller (presser)
Zig zag	Single, flat, roller
Barring machine	Single, cyl. (arm), barring tack set up
Flat binding	Single, cyl., tape feed with binder
Back strapping	Single, post, for non-parallel back straps
Cording (raised seam)	Twin, flat, roller with air cording attachments
Repairs machine (treadle Powered)	Often purchased second hand
French binding	Single, post, roller with guide, top tape drum and pad needle plate
Close row (1.5mm.) stitching	Twin, flat, roller
Silking or rowing back seams of leather linings	Twin, flat, with silking row modification
Intermediate operations,	Single, post, roller
For heavy (up to 8 cord) decorative stitching	Single, cyl., roller
Intermediate operations (lighter)	Single, flat, roller, auto-underbed trimming and needle control
Intermediate operations (lighter)	Single, flat, roller (simple machine)

(iv) Stitching aids

Stitching machine attachments and work guides can be inexpensive substitutes for operator training and experience in the achievement of high standards of accuracy and levels of output. Unfortunately, greater use of aids tends to be made in areas of the world with long experience in footwear manufacture than in areas where the industry has been recently established. Some types of aids are listed below for those readers who may not be familiar with their use:

Work guides

- Adjustable guide and presser foot for running on French bindings.
- Adjustable roller edge guide consisting of a short round vertical steel peg attached to the table for control of the overlap width on lapped seams. These guide stout leather better than soft leather.
- Presser foot and guide to aid the insertion of zips using twin needle machines.

- Thread cutters - Treadle operated thread-end cutting and thread pulling through devices. These are often offered as original equipment.
- Needle threaders - Can be fitted to a wide variety of stitching machines
- Special control mechanisms - Electronic controls to position the needle up or down which enables work to be swivelled on the needle at corners.
- Holding aids - Clamps to hold work during such operations as decorative stitching and tongue attaching.
- General aids - Under edge trimming knives for cutting off excess lining material during top line stitching.
- General aids - Thread break detector which stops the stitcher after a break and when the bobbin runs out.
- Device for lowering clamp, starting machine and lifting clamp during semi-automatic tongue attaching work.

II.3.3 Mocassin seams

Mocassin seams are variants of open seams and are most often used to attach mocassin aprons to their vamp wings. They may be formed on an arm-type coarse stitching machine or by hand. Covered mocassin seams, in which the edge of the apron is doubled over the vamp, are more weather-proof than open seams, but hand stitching of the latter takes less than half as much time as on the former. Often, outworkers carry out hand stitching. Where it is carried out in-house, the operation can be simply mechanised without losing the hand-finished appearance. A needle, with an open barb to carry the thread, is fastened to the piston rod of a small air cylinder. To form each stitch, the upper components are first pushed manually onto the unthreaded needle, the thread is then laid into the bar, and finally, the cylinder is activated so that the needle pulls the thread back through the hole.

II.4 Stitched upper finishing

Between stitching operations, and after stitching is completed, it is usually necessary to perform several additional operations in order to prepare uppers for the lasting stage. These operations are briefly described below:

II.4.1 Seam reducing (Operation reference No, 10)

The first operation is seam reducing. It involves cutting down the bulk of stitched back seams by removing the excess material on the seam and then flattening what is left under pressure. These two operations are separated when performed manually. They are on the other hand combined when performed by special purpose seam reducing machines.

Figure II.7 shows the drawing of a simply made tool for reducing closed back seams. This tool can be easily manufactured

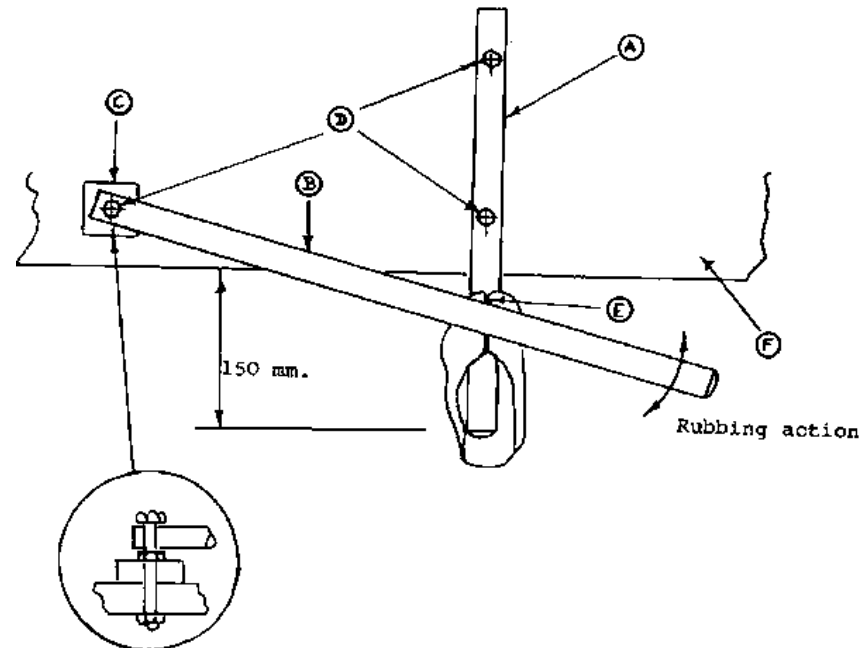
locally.SIDEVIEW OF SWIVEL**Figure II.7 A simply made tool for reducing closed back seams****PART LIST**

- A. Bright steel support bar, 30mm diameter x 400 mm long drilled for fixing bolts.**
- B. Bright steel rubbing bar 30mm diameter x 600 mm long drilled with a clearance hole at one end for the swivel bolt.**
- C. 25 mm thick spacer block of hard wood drilled for swivel bolt.**
- D. 12 mm diameter bolts, nuts and washers for swivel and support bar clamping.**
- E. Back seam of upper F. Work bench.**

Operation: The upper is gripped in the left hand so that the seam is stretched over the support bar. The right hand applies pressure to the rubbing bar while moving it back and forward across the seam.

11.4.2 Taping (operation reference No. 11)

As an alternative to a stitched silked seam, woven tape or paper tape can be cemented to the inside of the closed back seam either with the aid of a special purpose machine or by hand.

11.4.3 Eyelet Reinforcing (Operation reference No. 12)

Eyelet reinforcements can be stitched into uppers. Alternatively various labour saving machines are available which cement strips of fabric under the wings of uppers. In small enterprises, this simple operation is usually carried out manually.

11.4.4 Punching and Eyelet Insertion (Operation reference No. 13)

There are wide varieties of techniques available for the punching of eyelet holes and the insertion and clinching of metal eyelets. Some of these are briefly described below.

(i) Manual punching and eyelet insertion

A simple technique, suitable for scales 1 and 2, involves hole punching and eyelet clinching with hand held pliers. Although the cost of the needed equipment is very low, this technique yields an output of up to 30 pairs of shoes per hour. The technique may be further improved through the use of simple tools which may be manufactured locally. These tools are described on Figure II.8. They include an eyelet hole punching tube, and a punch and die for eyelets clinching.

(ii) Mechanised punching and eyelet insertion

For large outputs (e.g. scales 3 and above) various machines may be used for punching and eyelet insertion. The most elaborate machines punch a hole, insert and clinch an eyelet, then advance the work to the position of the next eyelet where the cycle is repeated. Depending on the type of shoe and the number of eyelets, these machines can process up to about 1,500 pairs per shift.

Figure II.8 Eyelet hole punch and eyelet clinching tools

The most sophisticated manually powered machines have automatic eyelet feeds but do not advance the work automatically. In a less expensive version of this machine, the operator has to locate the position of the eyelets manually.



The punch may be produced from a short length of solid steel tube, filed and buffed to shape in a revolving chuck. The hole is cleared with a steel rod after use.

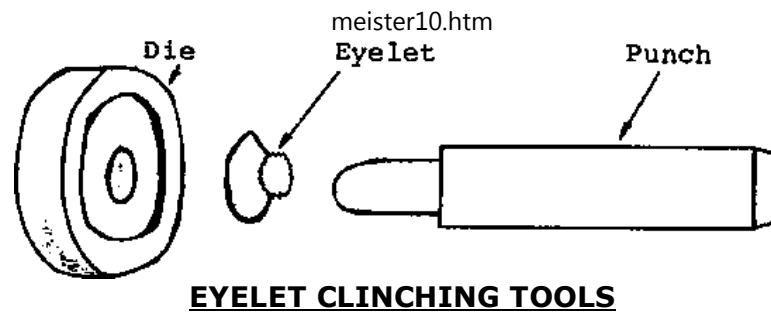

The punch and die should be turned from a steel bar to fit eyelets.

II.4.5 Temporary lacing

This operation can be carried out by machine or by hand. Temporary laces are tied through the eyelets on lacing shoes so that the uppers maintain their shape during lasting. When casual styles of shoe have elastic gussets rather than laces, fabric tabs are sewn in at the same time as the gussets. The tabs are cut out after lasting.

II.4.6 General fitting and puff attaching (Operation reference No. 15)

When toe puffs are assembled to the upper at this stage rather than during lasting, they may be attached with the help of a mechanical cement applicator or by hand. Decorative trims may be stapled or stuck on after lasting to reduce the risk of their being damaged. In large enterprises in developed countries there is a trend towards the use of puffs consisting of cotton impregnated with thermoplastic resins which are heat printed onto the upper and reheated before lasting to soften them. Thermoplastics are being increasingly used in the same way on stiffeners of leather-board and fabric.

II.4.7 Upper trimming (Operation reference No. 16)

The final trimming of loose threads from the uppers is carried out by hand with scissors. Although a flame is sometimes used to burn off threads, no powered machine is available for this operation. Where the lasting allowance on uppers requires cementing prior to lasting, the cement can be applied by brush or with the aid of an automatic supply unit. If hot melt adhesives are used for cement lasting this operation is unnecessary.

Linings and toe puff edges usually require trimming back to expose the lasting margin or allowance of the upper. Machines are available which can carry out this simple operation and to also roughen up the margin of the upper in preparation for cementing. However, these two operations may also be carried out efficiently by hand.

II.5 Bottom component preparation

II.5.1 Insole Preparation (Operation reference No. 17) The operation includes the following sub-processes:

(i) Cutting

Insoles are cut to shape from sheets of leatherboard, cellulose board, blended strip or, exceptionally, leather. Cutting

can be done manually with knives and templates of the required shape. Large enterprises often use heavy cast steel knives to cut several thicknesses of board with one stroke of a mechanical beam press. A heavy duty press/ used to cut stacks of up to four boards at once, can produce 2,400 pairs of insole blanks per shift. Swing arm mechanical presses, identical to those used for cutting upper leather, can usually cut two thicknesses of insole material.

(ii) Size stamping

To enable the various sizes and widths of insoles to be identified, numbers and letters are normally stamped onto them. This operation may be carried out with a stamping machine or manually with stamps and a hammer.

(iii) Seat bevelling

The edges of the back part of the insoles are bevelled to help the fit of the upper round the edge of the insole. This operation may be carried out either manually or with the help of a machine.

(iv) Slotting

Insoles for high heeled shoes may need a series of shallow slots cut across the undersides of their foreparts to assist flexing. These slots may be cut by hand or with the help of a rotary cutter.

(v) Insole moulding

The omission of an insole moulding operation at this stage can adversely affect the quality of the finished footwear. The operation involves shaping the insole into an exaggerated copy of the last bottom contour. During lasting, the moulded insole springs back to the last contour. The objectives are to achieve a close fit between the last and the insole (and thus prevent the insole from curving up round its edge during lasting) and to obtain a good shape retention and appearance. Many small-scale enterprises do not have presses equipped with male and female moulds capable of permanently forming the insole. They, therefore, rely on the insole being bent roughly to the required shape by hand. Another solution for small enterprises is to fit metal insole forming moulds or lasts that have been rounded off at the feather line with the help of the press used for cement sole attaching. Sole presses are discussed in a later section.

(vi) Shank grooving

In the past, the shank - which is the narrow reinforcing strip used to strengthen the waist of the shoe - was invariably attached to the bottom of the insole after lasting. Wooden shanks are still often tacked or cemented on at that stage but the use of metal shanks contoured to the shape of the moulded insole is increasing. Metal shanks can be laid in a groove specially cut into the insole and then riveted into position. The groove is cut out before moulding by hand or with a rotary cutter.

(vii) Cementing

Insoles that will be attached to the lasting margin of uppers by means of contact adhesive require to be cemented

round their edges. Neoprene cement or pressure sensitive latex adhesive is usually used. Cement dispensing machines are available or the operation can be performed manually with a brush. Drying may be in air on a rack or in a heated cabinet.

II.5.2 Sole cementing and drying (operation reference No. 18)

To prepare their surfaces for sole attaching adhesives, sole units made of PVC or polyurethane are washed with solvents. Those made of resin rubber are scoured with wire brushes, while units of leather to be cemented on can be roughened with needle sharp saw toothed rotary cutters. Application of a synthetic rubber or polyurethane adhesive to the upper surface of the sole unit can be done by brush or under pressure from a nozzle. The cemented units are normally stored on wire racks while drying.

II.6 Making

II.6.1 Insole tacking (operation reference No. 19)

Insole tacking is one of several operations carried out before lasting, whereby insoles are temporarily fastened onto the bottom of the last. This operation may be carried out manually or with the help of special purpose tacking machines.

(i) Manual insole tacking

At small levels of output, insole tacking may be carried out with the help of a worn magnetised file for tapping the tacks through the insole into the last bottom. In this operation, the socket on top of the last is located on a vertical steel column -called a jack - fixed to a work bench. Figure II.9 shows drawings of the file and of the lasting jack. These tools can be manufactured locally.

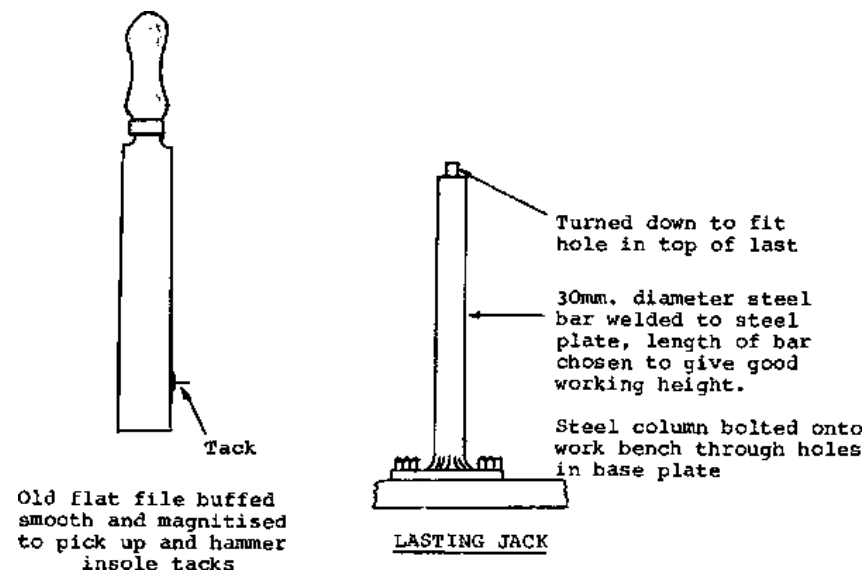

Figure II.9 Insole taking tools

(ii) Insole tacking machines

At high levels of output, the use of special purpose tacking machines may be justified. In some systems, steel studs are permanently fixed in the bottom of the last, and insoles are pushed onto them by a machine. Although expensive, this approach has the advantage that tacks cannot be inadvertently left in the shoe.

Normally, three tacks are inserted for each insole. However, small enterprises which do not possess an insole moulding machine, often insert five or six tacks on the forepart, and two or three tacks over the waist and seat. These tacks hold the insole tight to the last during lasting.

II.6.2 Stiffener Insertion (Operation reference No. 20)

Where stiffeners do not have to be inserted immediately before lasting, and there is a sufficient volume to justify the operation being separated from lasting, heel stiffeners may be manually placed into the pocket between the quarter lining and the quarter. At this point, French chalk may be applied to the seat of the upper, and last slip paste may also be applied to the toe of the last. Both substances assist in the removal of the last from the lasted shoe.

II.6.3 Upper Conditioning (Operation reference No. 21)

The absorption of moisture by leather uppers before lasting, and their subsequent drying after lasting greatly enhance the shape retention properties of leather uppers. Although synthetic upper materials do not absorb water, their fabric backers may do so. They may therefore be heated either with or without moisture prior to lasting and then dried in the normal manner after lasting.

A variety of moisture conditioning techniques are available. For scales 1, 2 and 3, water mixed with a soapy wetting solution may be sponged on the uppers. For the same scales, a more satisfactory result may be obtained if the upper are suspended over a tray of boiling water so that steam permeates the leather. The introduction of this relatively simple and inexpensive system can markedly improve appearance and shape retention.

A method which is unlikely to be appropriate at the lower levels of production, but which could be suitable for scale 4, involves suspending the uppers (until required for lasting) in a closed room where atomised water droplets are sprayed at ambient temperature. This approach is unsuitable when thermoplastic heel stiffeners and toe puffs requiring activation by heat before lasting are used. In a more sophisticated version of this approach, the uppers may be placed in a cabinet in which the temperature and moisture content of the air are controlled at predetermined levels. In this case, uppers require to spend a short period in the conditioning cabinet.

II.6.4 Cement-lasting (Operation reference No. 22)

Although many systems of lasting are available, they all involve pulling the upper over the last and fastening it over the bottom edge of the insole. Cement is now used in the majority of lasted shoes but the whole shoe is not always cement-lasted since tacks may be used to last the sides. A major benefit of cement-lasting a whole shoe is the elimination of the risk

of having a loose tack injuring the wearer. Since other methods of lasting are described in later sections, only cement-lasting is considered here. Figure II.10 shows several alternative lasting systems.

(i) Manual cement-lasting

Manual cement-lasting techniques are usually appropriate at low production levels (e.g. scales 1 and 2). In general, one operator carries out cement lasting for a whole shoe. Some operators prefer to mount the last on a jack and to stand at a bench, while others find it most convenient to sit on a low stool beside a low bench on which are laid the materials and tools. A pair of special purpose lasting pincers, with curved and deeply serrated jaws and incorporating a light hammer head, is used to stretch the upper over the last and to fix the lasting allowance to the insole.

If preassembled stiffeners are not used, the operator may have to dip a stiffener (usually pre-moulded leather-board) into a pot of latex and then position it. Similarly a puff (usually woven cotton) may have to be dipped into an acetone solvent before inserting it.

Hand lasting usually requires greater skill than any other footwear manufacturing task. The aspects of the job that are most difficult to master are the attainment of the correct directions and degrees of strain, and the achievement of uniformity between a pair of shoes in terms of squareness, back height and the fit and shape of the top line.

In manual cement lasting, tacks may be used to temporarily hold uppers in position on the last. Usually the toe is drafted over and fixed first. The back and sides are usually fixed after the toe area has been attached. The order in which each stage is completed depends on the preference of the operator. The final stage includes careful pleating of the lasting allowance and the removal of any puckers from the upper round the heel and toe.

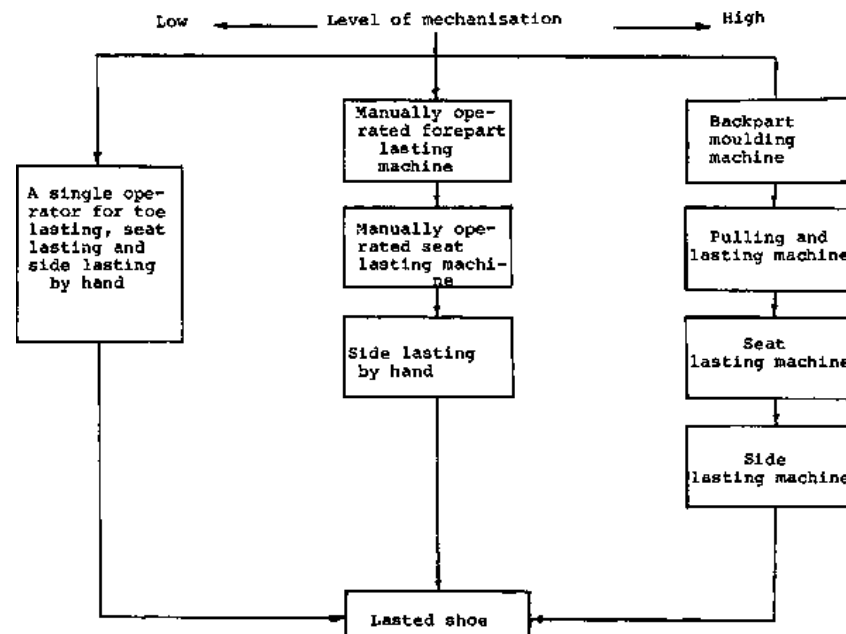

Figure II.10 Alternative cement-lasting sequences

Note: Similar alternatives are available for tack lasting type 3 footwear

ii) Mechanised cement lasting

Manual cement lasting is generally inappropriate at high levels of production. This operation is therefore carried out with the help of special purpose machines at scales 3 and above. Simple lasting machines may be used at scale 3 while scale 4 usually requires rather more elaborate machinery.

A wide range of machines are available for cement lasting foreparts, sides and seats. Machines are also available that combine pairs of these operations. Consequently, there is a wide spectrum of complete systems that can either toe or seat-last first. As a result of recent technological developments, the quality of work now attainable with expensive modern machinery is often as good as if not better than, that produced by highly skilled operators.

(a) Simple lasting machine

Lasting systems consisting of a pair of manually powered machines are available. One operator using the two machines can generally cement last a shoe in under two minutes. In one such system, the upper is drafted onto the last and the forepart is secured by impact adhesive to the insole on the first machine. In the second machine, wiper plates sweep the lasting margin in over the insole. The wiper plates can be changed over so that toes and seats can be lasted on the same machine. A typical two machine system of this type costs approximately US\$ 7,500.

(b) High output lasting machine

One type of high output lasting machine uses thermo-activated stiffeners. Before lasting proper, the backparts containing the stiffeners are pre-heated and then moulded to shape in special purpose machines off the last. During this operation the seat can be hot melt cemented to the insole between the internal mould (which is chilled to accelerate setting) and inflatable external seat supports. The last is then inserted into the upper and a tack placed at the toe to hold it in position.

A simpler and less expensive version of this technique involves as a first step back moulding and seat lasting on the last. The next step is to last the forepart. In sophisticated machines, adjustable pincers grip the lasted margin of the upper and wipe it over the bottom of the insole following the automatic application of hot melt adhesive.

In one widely used type of side lasting machine, the operator holds the shoe so that the lasting margins on the side and in the waist are in turn fed through a pair of rollers. As with other cement lasting techniques, the upper and insole can be pre-cemented or immediately cemented manually (prior to lasting) with the help of a hand gun. Alternatively, the adhesive can be applied automatically during lasting.

A lasting unit consisting of a backpart moulding and seat lasting machine, a forepart laster and a side laster with an operator on each machine, might be able to produce a lasted shoe in approximately ten seconds. A high quality system of this type, consisting of three machines, costs approximately US\$100.000. Few footwear manufacturing enterprises

in developing countries have sufficiently large markets for high quality footwear to justify such expensive systems.

II.6.5 Tack Removal and Inspection (Operation reference No. 23)

Tacks inserted to temporarily hold the insole to the last are removed after lasting. Usually hand held saw toothed tack lifters are used. For large scales of production, high speed tack extracting machines are also available. The operator removing tacks may also check on the quality of the lasting.

II.6.6 Heat Setting (Operation reference No. 24)

Allowing uppers that were conditioned with moisture before lasting to dry naturally has an important disadvantage: it increases the investment in work-in progress and the number of lasts in circulation. It may also lead to the development of mildew and rust stains may be caused by steel plates fitted to last bottoms. Artificial drying may therefore be used in order to avoid the above problems. Infra-red and other forms of radiant heat constitute one artificial drying source. However, they may result in uneven drying. Blown air should, on the other hand, produce more satisfactory results. One expensive method now available involves passing the shoes through a heating chamber on a conveyor belt. In the first half of the chamber moist air is circulated at high speed to stress-relieve the surface. The air circulating in the second half is hot and dry to remove all moisture and set the upper firmly. Hot air blown from a hair dryer can carry out the same operation.

II.6.7 Bottom Roughing (Operation reference No. 25)

The object of this operation is to provide a good keying surface for the adhesive used to attach the lasted margin of the upper to the sole unit. The operation removes the finished outward facing surface of the upper material and flattens the pleats round the forepart and seat.

(i) Manual bottom roughing

For production scale 1, this operation can be performed manually with a knife for levelling the folds and a wire brush for roughening the grain.

(ii) Bottom roughing machines

For scales 2 and 3, small electric portable drilling machines, costing less than US\$250 may be used for this operation. They are fitted with a wire brush or emery covered wheel and may be clamped to a bench top. Some skill is necessary to ensure that a clean "feather" edge is produced where the sole and upper meet.

A variety of similar machines working on the same principle as the electric drill arrangement are available. Some of these are fitted with wide scouring bands and powerful dust extractors. Figure II.11 shows a simply made scourer for small volume production.

For production scales 4 and above, fully automatic roughing machines are also available. They require the operator to simply fix the lasts carrying the shoes on fixtures, and remove them once the bottoms have been scoured. The cost of these machines is however high (US\$25,000 each) and they should not be adopted unless it may be shown that they

are more profitable than simpler machines.

II.6.8 Shank Attaching (Operation reference No. 26)

Shanks not riveted to the bottom of the insole before lasting are attached at this stage. They can be stapled in position with a manually powered or pneumatic powered staple gun, or can be attached with adhesive applied by brush.

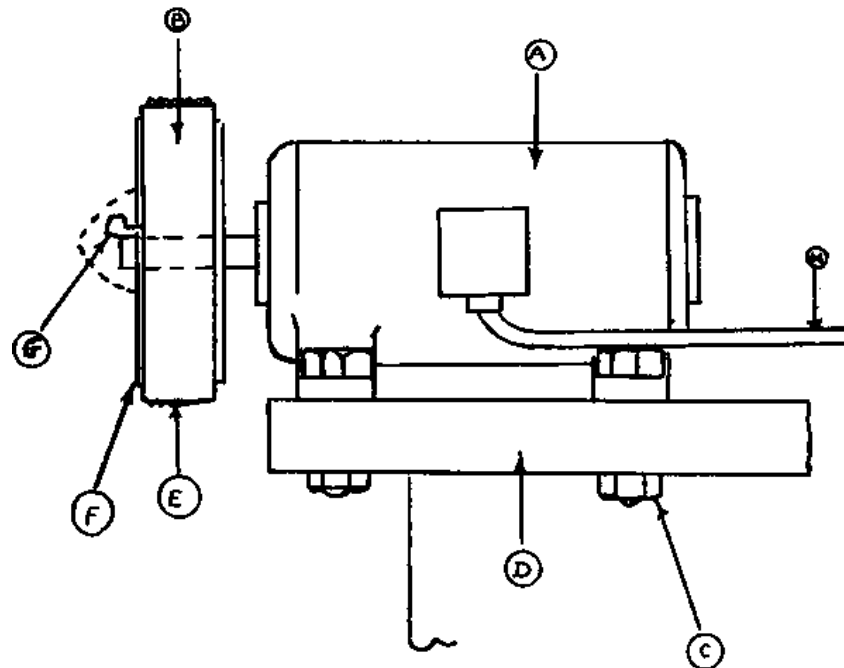

Figure II.11 A simply made scrouer for small volume production.

PARTS LIST

- A. Small electric motor.**
- B. Wooden disc turned true to bore.**
- C. Bolts, nuts and washers to hold motor.**
- D. Work bench.**
- E. Replacable emery cloth cemented to outer diameter of disc.**
- F. Steel clamping plates bored for shaft and drilled for clamping screws. Clamps are screwed to disc with countersunk head screws,**

G. Gib headed tapered machine key for securing and driving clamp plates. Guard cap shown dotted on figure.

H. Electric wire from mains.

Notes: - Check before use that wheel is sufficiently strong so that it does not break up or loosen at high speed.

- The operator should wear goggles and a face mask since no wheel guards or dust extractors are fitted to cement a cap over the head of the key to avoid injury.

- As an alternative to the system shown, a power drill could be used with the disc clamped in its chuck.

- A pulley belt drive from the motor to a separate shaft to carry one or more wheels would be more satisfactory than the design shown, but would be considerably more complicated.

- Polishing discs, grind stones and rotary cutters can be power driven in a method similar to the one shown here.

II.6.9 Bottom Cementing (Operation reference No. 27)

A brush or cement applying machine can be used to spread adhesive onto the roughened lasted margin on the bottom of the shoe. Cement applying nozzles fed from drums pressurised by a hand pump via a flexible tube are available. The adhesive may be dried naturally or by heat.

II.6.10 Bottom Filler Insertion (Operation reference No. 28)

Pieces of felt or scraps of thick leather are attached to the elliptical area in the middle of the forepart of the insole, and to the exposed part of the seat inside the lasting margin. Usually, the operation is performed manually. The cement can be applied to one side of the component with a manually fed, electrically powered machine.

II.6.11 Sole Laying (Operation reference No. 29)

Before placing the sole unit on the shoe bottom, the adhesive on both surfaces must be activated. This is often done by infra-red or quartz-halogen radiant heating.

The next step is to attach the sole unit to the shoe bottom. A number of techniques are available for this operation.

(i) Manual sole laying

Manual sole laying is often used by certain small enterprises. It consists of hammering the units to effect adhesion after careful positioning of the components. Unless care is taken, hammering may cut the upper at the feather edge.

Another technique consists in applying a steady pressure for an extended period of time, so that the cement is allowed to permeate into the lasting margin. This technique is likely to be superior to hammering. It may be adopted for scales 1 to 3, using manually operated machines that may exert pressures of over a tonne. In this type of machines, the load is applied through a large hand wheel which, by means of a reduction gear, raises and lowers a pair of hold-down posts under which the lasted shoe sits. The sole unit is pressed into a hard rubber pad set in a metal box.

(ii) Hydraulically powered machines

For scales 4 and above, elaborate hydraulically powered machines, which can apply loads of about three tonnes, are widely used. Less expensive machines using compressed air to apply the load through a flexible rubber diaphragm are also available.

II.6.12 Last Removal (Operation reference No. 30)

Once the sole is attached, the last is removed or slipped from the shoe. This can be done manually using a lasting jack to support the last, or with the help of a pneumatically powered last-slipping machine. Whether lasts are slipped by hand or machine, top lines and seams can be damaged if care is not taken.

At this stage, the shoes are ready for finishing operations.

II.7 Shoe finishing and packing (Operation reference No. 31)**II.7.1 Crease Removal**

Crease removal is the first operation of the finishing stage. It involves the removal of any creases on fine grained upper leathers. Various types of machines may be used for this purpose.

(i) Hot air treeing machine

These machines produce a blast of steam as well as one of hot air. They are appropriate only at higher levels of output such as 3 and 4. These machines are available at various levels of sophistication. Figure II.12 shows a simply made hot treeing machine for small volume production.

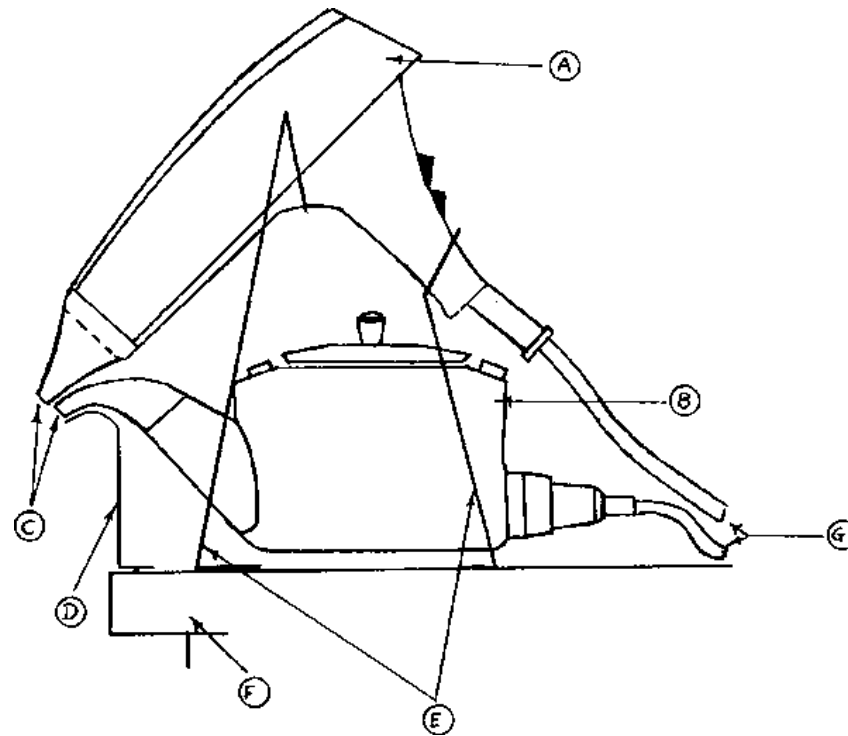

Figure II.12 A simply made hot treeing unit for small volume production

PARTS LIST

- A. Domestic electric hair dryer stapled to bench on both sides.**
- B. Domestic electric kettle with handle removed**
- C. Lengths of copper or steel tube flattened into slits at one end to form fish tails for dryer outlet and kettle spout,**
- D. Short metal strip bent to remove drips.**
- E. Two lengths of bent wires for supporting dryer.**
- F. Work bench.**
- G. Leads from mains.**

Notes: The best size for the fish tail slots should be found by means of trials.

It is very dangerous to let hair dryers get wet.

(ii) Hair dryers

For lower levels of output, such as scales 1 and 2, a powerful domestic or professional hair dryer is capable of producing the same required finish as do treeing machines. However, the output rate is in this case much lower. The cost of a hair dryer is approximately US\$30.

II.7.2 Upper Repair

The next step is to repair damages to the surface of the upper material. This may be done with the help of wax crayon to cover blemishes and with cement to fix down cuts.

II.7.3 Sock Insertion

A sock (which may have a backing pad of foam cemented to it) can be cemented either manually, with a brush, or by passing it through an electrically powered cement applying machine. The sock is then inserted into the shoe.

II.7.4 Upper Dressing

The sequence of this operation includes the following:

- Cleaning of upper with a detergent, e.g. a proprietary cleaning fluid or a spirit based solvent,**
- Application of a cream dressing by hand,**
- Application of a liquid dressing with a sponge or a sprayer. Some manufacturers in developing countries use a dressing mixture made of car enamel of the required pigmentation and solvent,**
- An alternative to liquid dressing is the brushing of uppers. This may be done with hand held brushes, bench mounted power drills fitted with mops, and specially designed brushing machines.**

II.7.5 Lacing

In lacing styles, laces are inserted into the uppers by hand.

II.7.6 Packaging

Information on shoe styles and sizes are written or printed on labels which are attached to packaging.

Shoe boxes can be assembled either on machines or cemented or stapled by hand.

II.7.7 Inspection

Shoes rejected at the final inspection are returned to the repair section.

III. Table of technical data

III.1 Material handling resources, work force and production floor area

Table II.3 refers to type 1 footwear and to the four scales of production covered by this memorandum. However, it also constitutes a useful guide for other types of footwear. The provided floor area should, for example, be approximately the same for footwear types 1 to 4 at each particular scale (e.g. for scale 3, the area should be approximately 250 m² for plants producing footwear types 1 to 4).

III.2 Workforce allocation: Table II.4

The table on workforce allocation gives a detailed account of the allocation of production workers with respect to each operation and scale of production. It also provides information on the level of skills required for each operation.

III.3 Equipment specification: Table II.5

Table II.5 provides information on the type and number of equipment required for each operation and scale of production. The four scales of production are shown on the same table in order to facilitate comparisons of equipment requirements between different volumes of output.

IV. Floor plans for production areas

A floor plan for each of the four scales considered in the memorandum are provided in this section. These floor plans are for type 1 footwear, but they may also partially apply to other types of footwear. The floor plan for scale 4 relates to the whole plant area (i.e. production areas as well as non-production areas - e.g. storage areas and offices).

Table II.3 Materials handling resources, work force and production floor area for type 1 footwear

Group of Operations	Scale 1 8prs/8hrs	Scale 2 40prs/8hrs	Scale 3 200prs/8hrs	Scale 4 1000prs/8hrs.
Raw materials storage	Racks	Racks	Separate store with storekeeper	Stores with storekeeper
Handling in cutting dept.	Boxes of work, carried	Boxes of work, carried	Boxes of work, carried	Boxes on gravity conveyor
Handling in preparation, stitching and upper finishing	Boxes	Mobile racks	Boxes on gravity conveyor	Boxes on gravity conveyor
Handling and storage before lasting	Rack	Mobile rack, last bins, bottom racks	As for scale 2	Buffer store to sort batches
Handling through making dept.	Carried by hand	Mobile trolleys	Mobile trolleys	Unpowered monorail tracks
Handling through finishing dept.	Carried by hand	Carried by hand	Mobile trolleys	Unpowered monorail

				tracks
Finished goods storage	Rack	Racks	Sharing raw material store	Separate store with storekeeper
Estimated cost of equipment	\$100	\$250	\$750	\$2,000
Number of indirect employees required 2	1	3	5	15
Production floor area(m ²)	30	70	250	700

Table II.4 Workforce allocation at each output scale level for type 1 footwear

Up. Ref. No.	OPERATIONS	Scale 1 8prs/8hrs	Scale 2 40prs/8hrs	Scale 3 200prs/8hrs	Scale 4 1000prs/8hrs.
1	Cutting uppers	0.8 s	1.5 s	6 s	16 s
2	Leather split				1 ss
3	Lining marking		1.0 ss	1 us	1 us
4	Stitch marking				3 us
5	Hole punching			2 ss	1 ss
6	Sock embossing				2 ss
7	Skiving			2 ss	4 ss
8	Edge folding and cementing				3 us
9	Stitching uppers	1.0 s	2.0 s	9 s	40 s
10	Seam reducing		1.0 s	1 us	1 us
11	Taping				1 us
12	Eyelet reinforcing			1 us	1 us
13	Punch and eyelet insertion				1 us
14	Temporary lacing			3 s	2 us
15	General felting and puff attaching				2 ss
16	Upper trimming				8 s
17	Insole preparation	0.2	0.5 ss	1 ss	4 ss
18	Sole cementing, and drying				1 ss
19	Insole tacking	1.0 s	1.5 s	1 us	1 us
20	Stiffener insertion				1 us
21	Upper conditioning				
22	Cement lasting			3 s	9 s
23	Tack removing and inspection		1.5 ss	1 ss	2 ss

24	Heat setting				1 us
25	Bottom roughening			1 ss	2 ss
26	Shank attaching				1 us
27	Bottom cementing			1 us	2 us
28	Bottom filling				1 us
29	Sole laying			1 ss	2 ss
30	Last removal		1.0 s	4 s	2 us
31	Upper finishing				14 s
TOTAL DIRECT WORKERS		3	10	38	130

Where an operative is only required part-time on an operation, the work is split.

***s = skilled (4 months training)**

ss= semi-skilled (3 weeks training)

us= unskilled (1 week training)

Table II.5 Methods and Equipment Specifications for Type 1 footwear

Output per 8 hours: 8, 40, 200 and 1,000 pairs.

Type: leather-upper cement lasted shoes with cemented-on unit soles

Op. Ref No.	Operations and Major Equipment Items	Equipment source	No. required by scale				Estimated unit cost (\$)
			1	2	3	4	
1	<u>CUTTING UPPERS</u>						
	- clicking bench	local	1	2	6	11	30
	- clicking board	local	1	2	6	11	15
	- cutting knives	sup. list 1	3	10	20	35	6
	- mech. swing arm	sup. list 1	-	-	1	5	2,200
	clicking press						
2	<u>LEATHER SPLITTING</u>						
	- Band knife splitting machine	sup. list 2	-	-	-	1	10,000
3	<u>LINING MARKING</u>						
	- clicking bench		OP1	OP1	-	-	
	- marking bench	local	-	-	1	-	25
	- lining stamping machine	sup. list 3	-	-	-	1	1,700

4	<u>STITCH MARKING</u>		OP1	-	-	-	
	- clicking bench						
	- preparation bench	local	-	1	-	-	25
	- marking bench	local	-	-	OP3	2	25
	- manually operated stitch marking machine	sup. list 4				1	600
5	<u>HOLE PUNCHING</u>						
	- bench	local	OP1	OP4	1	-	25
	- handheld punches	Loc/foreign	1	1	1	-	-
	- perforating mach.	sup. list 5	-	-	-	1	3,500
6	<u>SOCK EMBOSSING</u>						
	- press using electric iron element	local	1	1	-	-	35
	- hand controlled press	sup. list 5	-	-	1	-	550
	-semi-auto sock embosser	sup. list 6	-	-	-	1	3,000
7	<u>SKIVING</u>						
	- plate glass sheet	local	1	1	2	2	
	- paring knives	sup. list 1	3	6	12	12	6
	- manually controlled skiving machines	sup. list 7	-	-	-	2	2,000
	- skiving benches	local	OP1	OP4	2	-	50
	- hand work benches	local	-	-	-	2	50
8	<u>EDGE FOLDING AND CEMENTING</u>						
	- bench		OP1	OP4	OP7	-	
	- mechanical edge	sup. list 8	-	-	-	1	3,500
9	<u>STITCHING UPPERS</u>						
	All machines listed in-						
	clude motors, clutches						
	and stands. The mix of						
	types is as follows:						
	Needle Presser Bed Features						
	Single roller flat basic	sup. list 9	1	1	4	16	740
	Single roller post basic	sup. list 9	-	2	3	10	950
	Single roller flat light speed light duty	sup. list 9	-	-	1	4	650
	Single roller cy.arm basic	sup. list 9	-	-	1	3	1,700
	Single roller post under edge trimmina	sup. list 9	-	-	-	3	2,000

	Single roller flat zig zag	sup. list 9	-	-	-	2	740
	Single clamp flat barring auto	sup. list 9	-	-	-	1	2,200
	Twin roller flat cording	sup. list 9	-	-	-	1	2,400
	Single foot cyl, arm manual repair	sup. list 9	-	-	-	1	1,000
	Twin roller flat silking machine	sup. list 9	-	-	-	1	2,100
10	<u>SEAM REDUCING</u>						
	- fitting bench, two steel tubes with 1 fixed to bench	local	1	1	1	-	30
	- seam reducing machine	Sup. list 10	-	-	-	1	2,200
11	<u>TAPING</u>		OP10	OP10	OP10	-	
	- bench						
	- tape dispensing mach.	Sup. list 11	-	-	-	1	400
12	<u>EYELET REINFORCING</u>						
	- eyeletting bench	local	OP10	OP10	1		25
	- tape dispensing mach.	Sup. list 11	-	-	-	1	400
13	<u>PUNCHING AND EYELET INSERTION</u>						
	- hand operated punch and clincher	Sup. list 13	2	2	-	-	10
	- treadle operated punching and clinching machine	Sup. list 13	-	-	1	-	180
	- hole punching mach.	Sup. list 13	-	-	-	1	500
	- auto feed eyeletter	Sup. list 13	-	-	-	1	400
	- bench		OP10	OP10	OP12	-	
14	<u>TEMPORARY LACING</u>	local	OP10	OP10	1	2	25
	- lacing bench						
15	<u>GENERAL FITTING AND PUFF ATTACHING</u>						
	- fitting bench	local	OP10	OP10	2	1	25
	- loose upper roughing machine	Sup. list 15	-	-	-	1	1,600
16	<u>UPPER TRIMMING</u>						
	- powered trimming mach.	Sup. list 16	-	-	-	2	850
	- bench		OP10	OP10	OP15	-	
17	<u>INSOLE PREPARATION</u>						
	- bench		OP1	OP1	OP1	-	
	- press knives		-	-	30	50	40
	- sole bench		-	-	1	1	25

	- insole moulding mach.	Sup. list 17	-	-	-	1	8,000
	- insole bevelling mach.	Sup. list 17	-	-	-	1	2,500
18	<u>SOLE CEMENTING AND DRYING</u>						
	- wooden rack	local	1	1	6	10	10
	- bench	local	OP10	OP1	OP17	1	25
19.	<u>INSOLE TACKING</u>						
	- lasting bench	local	1	1	1	1	30
	- tubular steel jacks	local	1	2	1	1	5
20	<u>STIFFENER INSERTION</u>						
	- conditioning bench	local	OP19	OP19	OP19	1	25
21	<u>UPPER CONDITIONING</u>						
	- steamer using electric kettle element and feed tank	local	1	1	2	-	60
	- lasting heater	Sup. list 21	-	-	-	1	250
22	<u>CEMENT LASTING</u>						
	- lasting pincers and knives	Sup. list 22	3	6	20	50	4
	- lasting benches	local	OP19	OP19	3	4	25
	- jacks		-	-	3	7	5
	- manually operated drafting machine	Sup. list 22	-	-	1	-	3,000
	- pull toe lasting mach.	Sup. list 22	-	-	-	1	18,000
	- back part moulding machine	Sup. list 22	-	-	-	1	10,500
23	<u>TACK REMOVAL AND INSPECTION</u>						
	- tack lifters	Sup. list 23	2	2	3	6	4
	- bench	local	OP19	1	1	2	25
24	<u>HEAT SETTING</u>						
	- hand held hot air dryer	local	1	1	1	-	30
	- wrinkle chasing mach.	Sup. list 24	-	-	-	1	1,200
	- bench		OP19	OP23	OP23	-	
25	<u>BOTTOM ROUGHING</u>						
	- hand held wire brush	local	1	-	-		20
	- scouring buff without dust extractor	Sup. list 25	-	1	1	-	400
	- bottom roughing mach.	Sup. list 25	-	-	-	2	2,400
26	<u>BENCH ATTACHING</u>		OP19	-	-	-	

20	<u>SPANK ATTACHING</u>							
	- bench	local	1	OP23	1	1	25	
27	<u>BOTTOM CEMENTING</u>							
	- cementing bench	local	OP26	OP23	1	2	25	
28	<u>BOTTOM FILLER INSERTION</u>							
	- bench	local	OP26	OP23	OP27	1	25	
29	<u>SOLE LAYING</u>							
	- manually powered sole press	Sup. list 29	1	1	1	-	1,900	
	- twin station hydraulic sole presses	Sup. list 29	-	-	-	2	8,000	
	- electric fire for heat activation local		1	1	2	-	40	
	- heat activator.	Sup. list 29	-	-	-	2	450	
30	<u>LAST REMOVAL</u>							
	- lasting jack	local	OP19	1	1	2	5	
	- benches	local	-	-	-	2	25	
31	<u>UPPER FINISHING</u>							
	- finishing bench	local	OP26	1	3	12	25	
	- hot blast treeing mach.	Sup. list 31	-	-	-	1	1,200	
	- spray booth and guns	Sup. list 31	-	-	-	1	500	
	- mopping and polishing machine	Sup. list 31	-	-	-	1	400	
	- manually operated cementing machine	Sup. list 31	-	-	-	1	200	

1 See equipment suppliers list in Appendix II.

2 The same pieces of equipment may be used in a number of operations. This is indicated by reference to the number of operation where the equipment is used for the first time (e.g. OP1, OP3).

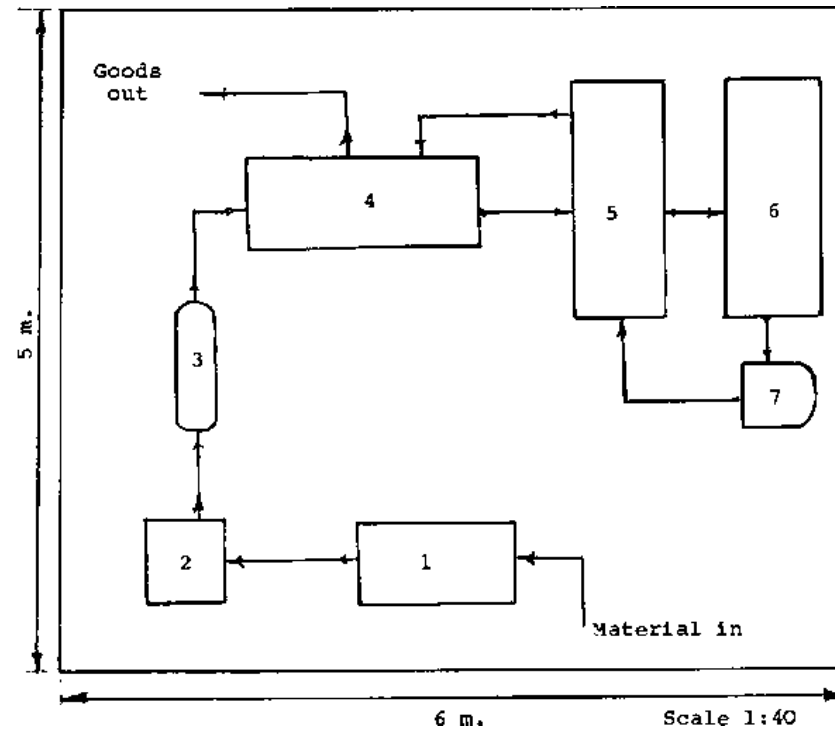
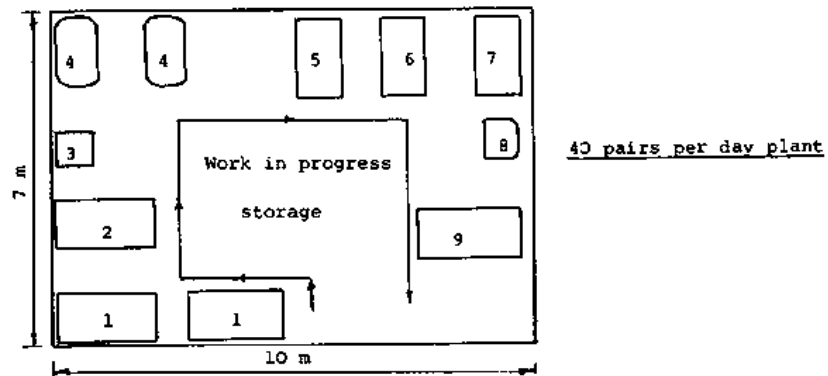

Figure II.13 Layout of production area for type 1 footwear - 8 pairs/day

Designation of work stations

- 1. Clicking**
- 2. Embossing**
- 3. Stitching**
- 4. Upper finishing and packing**
- 5. Lasting**
- 6. Bottom preparation**
- 7. Sole laying**



40 pairs per day plant

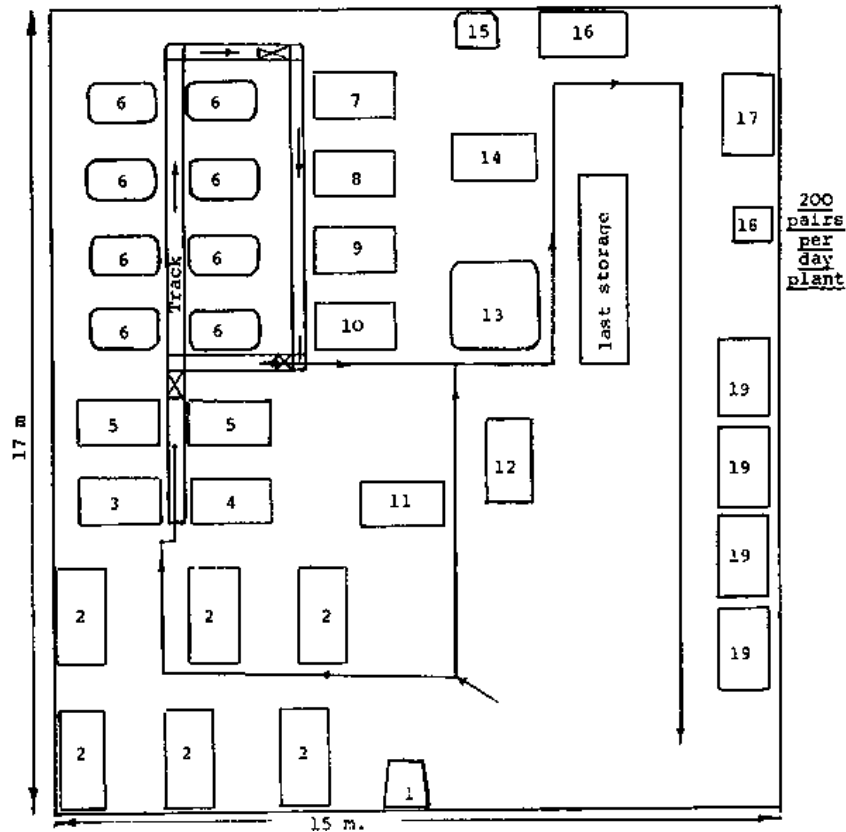

200 pairs per day plant

Figure II.14 Layout of production areas for type 1 footwear - 40 and 200 pairs per day

Keys to layouts*

* The identification numbers in the diagrams are not Operation Reference Numbers.

40 pairs / 8 hours 200 pairs / 8 hours

<u>70 pairs / 6 hours</u>	<u>200 pairs / 6 hours</u>
1. Clicking	1. Clicking machine
2. Upper preparation	2. Hand clicking
3. Embossing	3. Marking
4. Stitching	4. Embossing
5. Upper finishing	5. Skiving
6. Lasting	6. Stitching
7. Bottom preparation	7. Seam reducing and taping
8. Sole laying	8. Eyeletting
9. Finishing and packing	9. Lacing
	10. Upper fitting
	11. Sole bench
	12. Insole tacking
	13. Lasting
	14. Tack removal
	15. Bottom roughing
	16. Shank attaching
	17. Bottom cementing
	18. Sole laying
	19. Finishing and packing

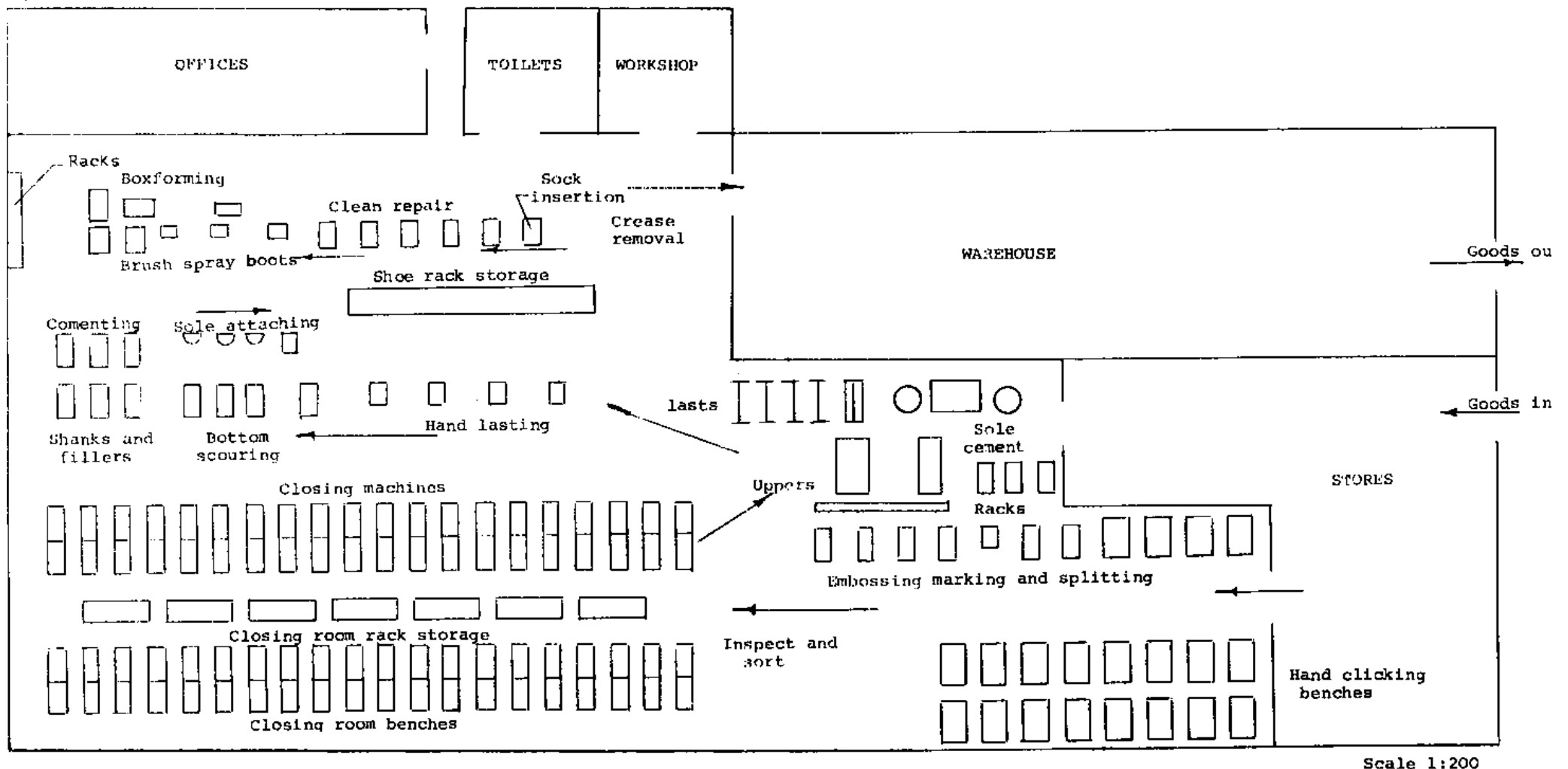

Figure II.15 Plant layout for type 1 foot-year - 1000 pairs per day

[Home](#) > [ar](#) [cn](#) [de](#) [en](#) [es](#) [fr](#) [id](#) [it](#) [ph](#) [po](#) [ru](#) [sw](#)

Small-Scale Manufacture of Footwear (ILO - WEP, 1982, 228 p.)

























CHAPTER III. MANUFACTURING TECHNOLOGIES FOR FOOTWEAR TYPES 2 TO 6











(introduction...)

I. Type 2 footwear: Leather-upper, cement-lasted shoes with directly moulded-on soles

(introduction...)



-  **I.1 Scrim attaching (Operation reference No. 32)**
 -  **I.2 Heel Core attaching (Operation reference No. 33)**
 -  **I.3 Bottom solutioning (Operation reference No. 34)**
 -  **I.4 Direct sole moulding-on (Operation reference No. 35)**
 -  **I.5 Subsequent operations**
 -  **I.6 Tables of technical data for type 2 footwear**
- **II. Type 3 footwear: Leather-upper, tack-lasted shoes with machine-sewn leather soles**
 -  **(introduction...)**
 -  **II.1 Insole preparation (Operation reference No. 36)**
 -  **II.2 Sole preparation (Operation reference No. 37)**
 -  **II.3 Insole tacking (Operation reference No. 38)**
 -  **II.4 Tack lasting (Operation reference No. 39)**
 -  **II.5 Bottom pounding (Operation reference No. 40)**
 -  **II.6 Bottom cementing (Operation reference No. 41)**
 -  **II.7 Sole laying (Operation reference No. 42)**
 -  **II.8 Last removal (Operation reference No. 43)**
 -  **II.9 Sole stitching (Operation reference No. 44)**
 -  **II.10 Sole levelling (Operation reference No. 45)**
 -  **II.11 Seat nailing (Operation reference No. 46)**
 -  **II.12 Heel attaching (Operation reference No. 47)**
 -  **II.13 Re-lasting (Operation reference No. 48)**
 -  **II.14 Heel trimming (Operation reference No. 49)**
 -  **II.15 Edge trimming (Operation reference No. 50)**
 -  **II.16 Bottom finishing (Operation reference No. 51)**
 -  **II.17 Tables of technical data**
- **III. Type 4 footwear: Welded synthetic upper, string lasted shoes with moulded-on soles**
 -  **(introduction...)**
 - III.1 Cutting and welding upper components (Operation reference No. 52)**
 - III.2 Welding upper components together (Operation reference No. 53)**
 - III.3 Lasting string attaching (Operation reference No. 54)**
 - III.4 String lasting and moulding-on of soles (Operation reference No. 55)**
 - III.5 Sock insertion (Operation reference No. 56)**
 - III.6 Tables of technical data**
- IV. Type 5 footwear: Stitched synthetic upper cement-lasted sandals and casual shoes with built or unit soles**

-  **(introduction...)**
-  **IV.1 Sole and insole preparation (Operation reference No. 57)**
-  **IV.2 Heel preparation (Operation reference No. 58)**
-  **IV.3 Lasting uppers (Operation reference No. 59)**
-  **IV.4 Heel attaching (Operation reference No. 60)**
-  **IV.5 Sole, finishing (Operation reference No. 61)**
-  **IV.6 Tables of technical data**
- V. Type 6 footwear: Single injection, moulded plastic sandals**
 -  **(introduction...)**
 -  **V.1 Single injection moulding technique and equipment (Operation reference No. 62)**
 -  **V.2 Tables of technical data**

Small-Scale Manufacture of Footwear (ILO - WEP, 1982, 228 p.)

CHAPTER III. MANUFACTURING TECHNOLOGIES FOR FOOTWEAR TYPES 2 TO 6

This chapter considers techniques of manufacturing footwear types 2 to 6. Methods and equipment discussed in Chapter II are referred to in this chapter but not dealt with again. Production stages are first described for each footwear type and are then followed by technical tables covering the four selected scales of production.

I. Type 2 footwear: Leather-upper, cement-lasted shoes with directly moulded-on soles

The moulding-on process occurs in a single operation. It is a development of the vulcanising method of forming a rubber blank by heat and pressure while bonding its top surface to the shoe bottom.

The principal materials used for this type are Ethylene-Vinyl-Acetate (EVA), Thermoplastic Rubber, Polyvinyl Chloride (PVC) and Polyurethane (PU). This section refers to (PVC) and (PU), The popularity of these methods rose rapidly between the mid 60s and the energy crisis of the mid-70s, and has since continued to grow but at a reduced rate.

Table III.1 lists the manufacturing stages for this type of footwear. Operations unique to this type are listed without asterisks and are discussed below.

I.1 Scrim attaching (Operation reference No. 32)

To prevent soling material from stocking to the insole and filler, it is necessary sometimes to cement a paper scrim to the forepart of the lasted shoe so that its edge overlaps the lasted margin. This paper scrim, which is pre-cut to be a little smaller than the sole bottom, also prevents the plastic from forcing its way between the upper and insole.

Equipment - the equipment required for this operation is a cement pot, brushes and a lasting jack to hold the shoe while attaching the scrim.

I.2 Heel Core attaching (Operation reference No. 33)

Heel core attaching is an unskilled cementing operation. Heel cores, also called filler blocks, are often cardboard blanks. These cores are attached to the underside of the seat before moulding and are buried in PVC during moulding.

Advantages - these cores speed up cooling, make the soles cheaper, lighter and reduce their elasticity. Heel cores replace the seat fillers used on cemented-on sole shoes.

I.3 Bottom solutioning (Operation reference No. 34)

A polyurethane (PU) solution is applied to the lasting margin to ensure that the PVC adheres to it.

The following operation is last removal. It has already been dealt with in Chapter II.

I.4 Direct sole moulding-on (Operation reference No. 35)

Direct sole moulding-on constitutes one of a number of alternative bottoming processes. Figure III.1 shows the sequence of operations used in bottoming processes for footwear types 1 to 5. Soles may be moulded-on (footwear types 2 and 4), cemented-on (footwear types 1 and 5) or sewn-on (footwear type 3) . The figure highlights the relative complexity levels of the five alternative bottoming processes.

Table III.1 Stages in the production of leather-upper, cement-lasted shoes with directly moulded-on soles

Production Stages	Op. Ref	Operations	Major materials
Upper cutting	1*	Cutting upper components	Skins and lining materials
Upper preparation	2*	Leather splitting	
	3*	Lining marking	
	4*	Stitch marking	
	5*	Hole punching	
	6*	Sock embossing	
	7*	Skiving	
	8*	Edge folding and cementing	
Upper stitching	9*	Stitching of uppers	Threads and tapes
Stitched upper finishing	10*	Seam reducing	
	11*	Taping	Tapes
	12*	Eyelet reinforcing	
	13*	Punching and eye-let insertion	Eyelets
	14*	Temporary lacing	String

	15*	General fitting and puff attaching	Trim, puffs
	16*	Upper trimming	
Bottom component preparation	17*	Insole preparation	Insole board
Making	19*	Insole tacking	
	20*	Stiffener insertion	Heel stiffeners
	21*	Upper conditioning	
	22*	Cement lasting	
	23*	Tack removal and inspection	
	24*	Heat setting	
	25*	Bottom roughing	
	26*	Shank attaching	Shanks
	32	Scrim attaching	Scrim paper
	33	Heel core attaching	Heel cores
	34	Bottom solutioning	
	30*	Last removal	
	35	Direct sole moulding on	Sole raw materials
Finishing	31*	Upper finishing operations and packing	Packing materials

Note: The operations marked (*) are discussed in the section dealing with leather-upper, cement-lasted shoes with cemented-on soles.

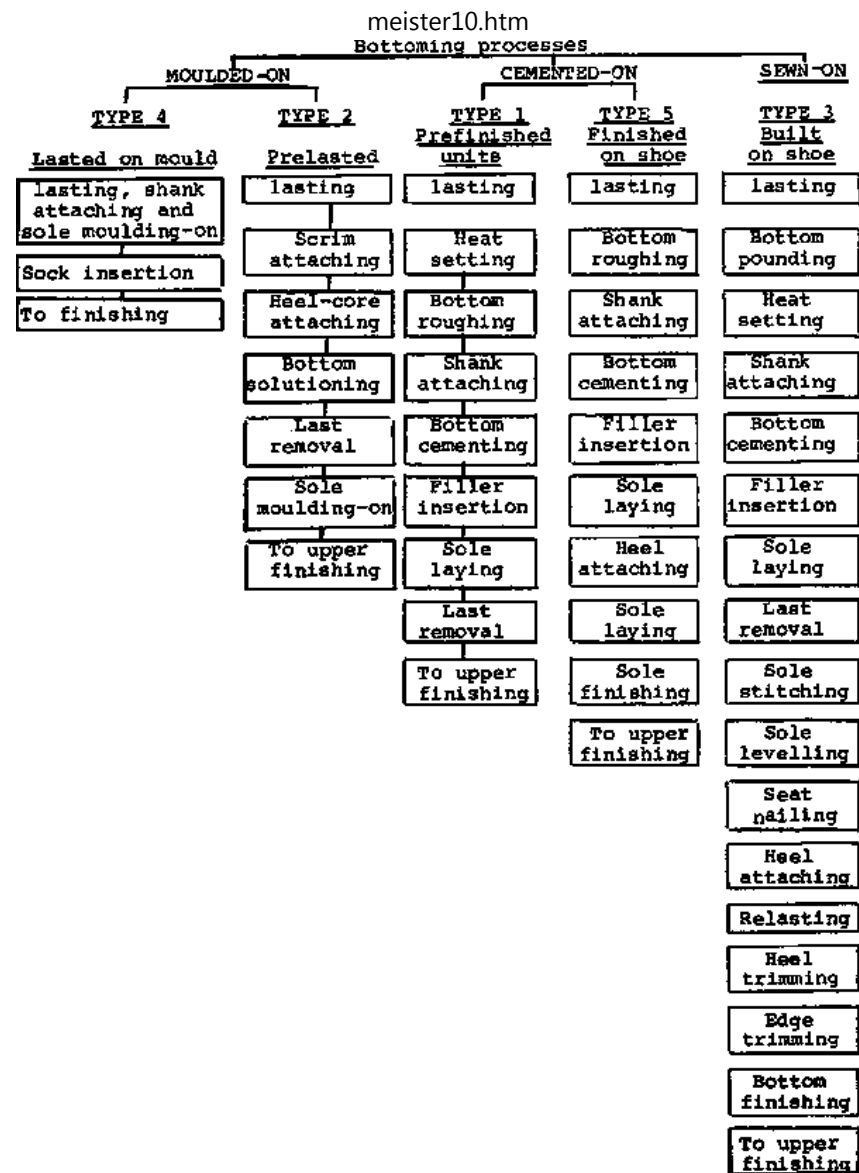

Figure III.1 Comparison of alternative bottoming processes

I.4.1 Work-in-progress storage

A buffer stock of work-in-progress waiting for sole moulding is required for the following reasons:

- (i) extended runs of one size and style are desirable as mould changing is time consuming,
- (ii) moulding machines are expensive and, therefore, small enterprises run the machines for more than one shift a

day.

Mobile storage racks are suitable for this operation.

I.4.2 Moulding machines

The use of a moulding machine is required regardless of the scale of production.

(i) Description of the moulding process

The soling material, usually PVC, is supplied in bags of granules. The bags are loaded into a hopper feeding a heating chamber. A revolving screw or plunger forces the softened plastic through a nozzle into a cavity. This cavity's upper surface is formed by the shoe bottom. During moulding, the shoes are mounted on last-shaped footforms of steel or aluminium. Average moulding stations can complete a full mould-on cycle in less than 3 minutes.

(ii) Equipment

Moulding machines are available with single, twin or multiple stations. Machines with twelve stations or more are uneconomical whenever frequent mould size and style changes occur since every station must be stopped for each change. A battery of small machines (e.g. with a single or twin stations) may therefore be preferable to a single multiple stations machine even when large outputs are contemplated. In particular small enterprises should employ single or twin stations moulding machines.

A recent innovation is the introduction of multi-mould machines that run three or four different styles simultaneously. This innovation overcomes, to some extent, the problem related to frequent size and style changes.

Prices of moulding machines vary with the precision of injection equipment and the quality of the heating arrangement. Moulds and footforms are made by specialist firms or machinery suppliers and are justifiable only for long sole style lives.

(iii) Machine operating tasks

An operator on a twin station machine can, normally, perform additional tasks within the moulding cycle time. Little skill is required to mount shoes onto the metal footforms, unload them after moulding and to remove any moulding flash by hand. Any waste PVC is ground and re-melted for further use.

(iv) Moulded-on polyurethane(PU)

An increasing number of footwear manufacturers in developed countries produce directly injected moulded-on soles of PU which has better wear resistance than PVC but has only one third of its density.

Process: The PU moulding process is similar to that of PVC except that a hardener and a resin in liquid states are injected into the mould. They react in the mould and expand into a cellular structure which fills the mould cavity and

solidifies. Small enterprises in developing countries will probably find PU moulding unattractive because the process is relatively complex. Furthermore, the technical back-up from chemicals and equipment suppliers may be inadequate and could be responsible for frequent disruptions of production.

I.5 Subsequent operations

Processing stages after sole moulding are the same as those used for type 1 footwear, namely finishing and packing. These operations are described in Chapter II and need not be further elaborated in this chapter.

I.6 Tables of technical data for type 2 footwear

Table III.2 provides estimates of labour requirements for scales of production 1 to 4, while Table III.3 lists the additional equipment needed for Type 2 footwear.

Table III.2 Workforce allocation at each output scale for type 2 footwear

Op. Ref	Operations	Scale 1 8prs/8hrs	Scale 2 40prs/8hrs	Scale 3 200prs/8hrs	Scale 4 1000prs/8hrs
1	*Cutting uppers	0.8 s	1.5 s	6 s	16 s
2	*Leather splitting				1 ss
3	*Lining marking		1.0 ss	1 us	1 us
4	*Stitch marking				3 us
5	*Hole punching			2 ss	1 ss
6	*Sock embossing				2 ss
7	* skiving			2 ss	4 ss
8	*Edge folding/cementing				3 us
9	*Stitching uppers	1.0 s	2.0 s	9 s	40 s
10	*Seam reducing		1.0 s	1 us	1 us
11	*Taping				1 us
12	*Eyelet reinforcing			1 us	1 us
13	*Punch/eyelet insertion				1 us
14	*Temporary lacing			3 s	2 us
15	*General fitting and puff insertion				2 ss
16	*Upper trimming				8 s
17	*Insole preparation	0.2 ss	0.5 ss	1 ss	4 ss
19	*Insole tacking				1 ss
20	*Stiffener insertion	0.5 s	1.5 s	1 us	1 us
21	*Inner conditioning				1 us

21	Upper conditioning				1 us
22	*Cement lasting				
23	*Tack removing/inspection			3 s	9 s
24	*Heat setting		1.0 s	1 ss	2 ss
25	*Bottom roughing				
26	*Shank attaching				1 us
32	Scrim attaching			1 us	1 us
33	Heel core attaching				1 us
34	Bottom solutioning			1 us	2 us
30	*Last removal				2 us
35	Mould-on sole			1 s	2 s
31	*Upper finishing	0.5 s	1.0 s	4 s	14 s
	TOTAL DIRECT WORKERS	3.0	10	38	128

Keys to table: s = skilled (4 months training). ss = semi-skilled (3 weeks training). us = unskilled (1 week training)

Notes: *See type 1 equipment specifications for these operations. Moulding on is unlikely to be undertaken at daily output levels of 8 and 40 pairs. Jobs are shared by operatives in some cases.

Table III.3 Methods and equipment specifications for type 2 footwear

Output per 8 hours: 8, 40, 200 and 1000 pairs.

Type: Leather-upper, cement-lasted shoes with moulded-on soles.

Op. Ref. No.	Operations and Major Equipment required	Equipment source	No required by scale				Estimated unit cost (\$)
			1	2	3	4	
1-26	See Type 1 at same scale						
32	<u>SCRIM ATTACHING</u>						
	See Type 1 for scales 1 and 2		OP 20	OP23	-	-	
	- scrim bench	local	-	-	1	1	25
33	<u>HEEL CORE ATTACHING</u>	local					
	See type 1 for scales 1 to 3 - core bench		OP 20	OP23	OP 32	1	25
34	<u>BOTTOM SOLUTIONING</u>						

	See type 1 for scales		OP 20	OP23	-	-	
	- solutioning bench	local	-	-	1	2	25
30	<u>LAST REMOVAL</u>						
	See type 1 at same scale						
35	<u>MOULD-ON SOLE</u>						
	- single station PVC sole injection moulding-on machine	Sup. list 35	-	-	1	-	23,000
	- twin station PVC sole injection moulding-on machines (1 machine if work on a two-shift basis)	Sup. list 35	-	-	-	1/2	35,000
35	<u>MOULD-ON SOLE</u>						
	- sets of moulds and foot forms	Sup. list 35	-	-	8	16	2,125
	- preheater	Sup. list 35	-	-	1	2	800
	- granulator	Sup. list 35	-	-	-	1	1,400
31	<u>UPPER FINISHING AND PACKING</u>						
	See type 1 at same scale						

II. Type 3 footwear: Leather-upper, tack-lasted shoes with machine-sewn leather soles

The type of shoes considered in this section are leather upper, tack-lasted shoes with stitched on leather soles.

As a result of the development of effective adhesives during the last thirty years, large scale footwear manufacturing enterprises in developed countries have steadily reduced their use of tack-lasting in favour of cement-lasting. Similarly, cemented-on unit soles have replaced stitched-on soles and heels finished on the shoe. However, the traditional techniques employed in constructing tack-lasted, stitched-on sole shoes may still constitute an appropriate alternative. They are often used by small-scale enterprises in developing countries, where the available insole materials are liable to delaminate and where locally tanned sole leather is more readily available than unit soles for each size and shape of last.

Some of the operations and equipment described in this section are used in two other methods of construction whereby the sole is attached by stitching. The first is known as the veldtschoen construction while the second is known as the welted construction. Neither of these methods of construction involves tack lasting of the complete shoe. The veldtschoen method rarely uses leather soles. The welted method is now almost exclusively used on expensive walking shoes for men which are unlikely to be made by small enterprises in developing countries. For these reasons, it was decided to describe the methods available for manufacturing tack-lasted stitched-on sole shoes only. Such shoes are often referred to as machine-sewn shoes.

Table III. 4 shows the operation sequence that can be used to construct these shoes. The operations marked by an asterisk have been dealt with in Chapter II and are thus not discussed below.

II.1 Insole preparation (Operation reference No. 36)

Insoles used on tack-lasted shoes require to be stouter than cemented insoles. The best insole material for this type of shoes is leather. Leather insoles are cut in the same way as leather soles, as described below. An often used substitute material is fibreboard. Insoles made with this material are cut according to the same techniques as those described for cemented-on soles. Insoles are further processed in the same way as fibreboard and composition soles used in cemented-on sole shoes.

Table III.4 Stages in the production of leather-upper, tack-lasted shoes with stitched-on leather soles

Production stages	Op. Ref.	Operations	Major materials
Upper cutting	1*	Cutting upper components	Skins and lining
Upper preparation	2*	Leather splitting	
	3*	Lining marking	
	4*	Stitch marking	
	5*	Hole punching	
	6*	Sock embossing	
	7*	Skiving	
	8*	Edge folding and cementing	
Upper stitching	9*	Stitching of uppers	Threads and tapes
Stitched upper finishing	10*	Seam reducing	
	11*	Taping	Tapes
	12*	Eyelet reinforcing	
	13*	Punching and eyelet insertion	Eyelets
	14*	Temporary lacing	String
	15*	General fitting and puff attaching	Trim, puffs
	16*	Upper trimming	
Bottom component preparation	36	Insole preparation	Insole board
	37	Sole preparation	Sole leather
Making	38	Insole tacking	
	20*	Stiffener insertion	Heel stiffeners
	21*	Upper conditioning	
	39	Tack lasting	
	23*	Tack removal, inspection	
	40	Bottom pounding	
	24*	Heat setting	

	26*	Shank attaching	Shanks
	41	Bottom cementing	
	28*	Bottom filler insertion	
	42	Sole laying	
	43	Last removal	
	44	Sole stitching	
	45	Sole levelling	
	46	Seat nailing	
	47	Heel attaching	Heels
	48	Re-lasting	
	49	Heel trimming	
	50	Edge trimming	
	51	Bottom finishing	
	30*	Last removal	
Upper finishing	31*	Upper finishing operations and packing	Packing materials

The operations marked with (*) are discussed in the section dealing with leather-upper, cement-lasted shoes with cemented-on soles.

II.2 Sole preparation (Operation reference No. 37)

Small enterprises which sell their footwear at the lower end of the local market may find it unnecessary to subject soles to the full sequence of operations described below.

II.2.1 Sole cutting

(i) Description of sole cutting techniques

Hides used for soles come from the largest animals. Some manufacturing concerns only use the portion down the back of each side and either use the remainder for other applications or re-sell it. The cutting pattern is usually regular and disregards all but the very largest blemishes since it is considered more economical to discard defective soles than break the pattern to avoid damaged areas. Due to its thickness, sole leather can rarely be cut cleanly the whole way with a mechanical press. Consequently, soles are cut oversize and are then edge-pared before being attached to the shoe. Soles can also be hand clicked, and then hand pared.

(ii) Sole cutting equipment

Equipment for this operation includes beam presses with heavy cutting knives. Often, only one knife is used, the hide being turned over in order to make both left and right soles.

II.2.2 Evening

Highly mechanised factories use automatic evening and grading machines. These machines, in a single cycle sense the thickness of the thinnest part of the sole and reduce the thickness of the remainder part to this thickness. They also stamp on a number corresponding to the final thickness. It is then simple for the operator to sort the soles into boxes or piles. On simple evening machines, it is necessary to adjust the thickness manually. Evening can be also carried out manually.

II.2.3 Tempering

Tempering involves immersing the soles in clean water for an extended period to increase their workability. The operation can be greatly speeded up if a pressure vessel is used. In some systems, as much as a 100 bars pressure is used to force water into the soles. It is important that the temper is maintained until the soles have been attached.

II.2.4 Edge paring

The purpose of this operation has been described in the sole cutting section. Machines called planetary edge rounders can be used. They employ a vertical knife and two wooden templates (i.e. cum-clamps which grip the sole between them). The knife automatically follows the contour of the lower template and produces a clean edge. Performing the operation by a hand held knife requires effort and some skill to maintain a smooth, square edge.

II.2.5 Waist reducing

To give the soles a light appearance in the waist, the outside edges can be tapered in a manner similar to that used in skiving. Usually, about a quarter of the sole thickness is removed at the outside and the 20 mm. down the middle is left at full thickness.

II.2.6 Grading

This is an inspection operation in which the flexibility, grain, size and general quality of each sole is assessed, and suitable lefts and rights are matched up.

II.2.7 Channel cutting

(i) Process

To prevent the stitching on the grain side of the sole from rubbing against the ground, it is recessed in a channel with a lip cemented over it. The channel is cut at an angle to the sole bottom from near the sole edge back in towards the middle. A small groove is cut at the bottom of the slit. The 'flap' is lifted before stitching and cemented back in place afterwards. As an alternative, to a channel, an open groove can be cut so that the stitches can be seen on the finished shoe. Care is required to keep stitches in the groove. More latitude is possible when stitching channelled shoes.

(ii) Channel cutting equipment

The equipment used for channel cutting is a hand cranked machine through which the sole is fed by a pair of rollers past a blade fixed at the required angle. By depressing a pedal, the operator can alter the angle at which the knife cuts at different points round the waist and forepart. Both the machine method and cutting with a hand held knife in a manner reminiscent of hand skiving require considerable skill.

II.2.8 Conforming

This operation moulds the sole to the shape of the last so that it fits snugly on the finished shoe. The alternative methods of doing this job are similar to those available for moulding insoles in the cemented-on construction.

II.2.9 Sole cementing

The upper, flesh side of the soles can be cemented at this stage with a neoprene or a resin based latex solution, and then dried.

II.3 Insole tacking (Operation reference No. 38)

Insole tacking is carried out in a similar fashion as for cemented-on sole shoes, except that the last bottom has a steel plate over it which clenches the tips of the lasting tacks back into the top surface of the insole. Holes are left in the plate at the seat, waist and on the forepart so that insoles can be temporarily attached by tacks driven into the wood. Some experience in placing the tacks is required since the holes in the plate cannot be seen during the operation.

II.4 Tack lasting (Operation reference No. 39)

Although many shoes of this type are now lasted by other methods (e.g. cement-lasting or combinations of cement-seat, tack-side and cement-forepart lasting), this section describes techniques and equipment for tack-lasting the complete upper. Tack-lasting combined with stitched-on soles results in stiff, and rather inflexible foreparts. To compensate for this, additional 'toe spring' is often allowed for in the last used for this construction.

II.4.1 Manual lasting techniques

(i) Back tacking

Footwear is usually hand tack-lasted with a round vertical steel peg, or lasting jack, inserted into the socket on top of the last. In this position, the bottom of the insole provides an upwards facing surface ready for tacking. Pincers, incorporating a hammer head, similar to those used for cement-lasting, are normally used for this operation. After lining up the back-seam, the upper is tacked to the seat of the insole by one or two tacks.

(ii) Pulling over

Any lining material must always be pulled tight before pulling on the upper itself. Normally, the first lasting pull is straight over the toe. The pincers lever the lasting allowance of the upper over the toe of the insole. The thumb of the free hand holds the material while the pincers push a tack into position. The tack is then hammered down. This is

basically the method used to insert all tacks, although in some cases it is necessary for the pincers to pleat and twist the margin to obtain a smooth feather-edge line. When soles are to be stitched-on, tacks are placed well back from the insole edge to leave room for the stitching. Tacks are inserted on either sides of the toe to stretch the upper forward from the heel over the toe. The seat and forepart just ahead of the waist are then tacked.

(iii) Seat lasting

Strains are taken and tacks inserted alternatively at approximately 5 mm. intervals round one half, and then the other half of the seat. Small pleats are produced between each tack.

(iv) Toe lasting

The same procedure as for seat lasting is also used for toe lasting. More skill is generally required to remove puckers over the toe and to pleat the material neatly than is needed for seat lasting.

(v) Side lasting

Tacks are generally spaced at about 10 mm. intervals down the sides. Much less force is required for this operation than for lasting the seat and toe.

II.4.2 Tack lasting machinery

Small footwear manufacturing enterprises will not find it economical to invest in elaborate tack-lasting machines. However, where output levels exceed one hundred pairs per day, there may be a case for investing in relatively simple, manually-powered drafting and lasting machines. With machines of this type, the tacks are individually driven in by the operator. Two such machines cost approximately US\$8,000, and may also be used for cement-lasting if necessary. The essential difference between these two machines is that pincers are used on the drafting machines to take the initial strains over the toe, while wiper plates are used to assist toe- and seat-lasting on the second machines. Side tack-lasting is carried out by hand in either of these machines.

A type of machine which is used for side and waist lasting by large-scale enterprises can also be used to completely tack-last shoes. In these machines, the operator holds the work up to the machine so that the lasting margin is gripped by a pincer. A knee operated lever can twist the pincers to the left or right as required and a wiper holds the margin while a tack is automatically driven. Simplified versions of these machines are available for tack side-lasting.

II.5 Bottom pounding (Operation reference No. 40)

The lasting margins of stitched-on sole shoes do not need to be scoured. However, after cutting off any excess material inside the tack line, the pleats around the seat and the toe must be flattened. Special purpose machines are available but the operation can be carried out with a hammer having a large, slightly-domed face. To avoid damaging the feather-edge, the blows should be directed so that they have a slight inwards component.

II.6 Bottom cementing (Operation reference No. 41)

The purpose of this operation is to hold the sole against the shoe bottom during sole stitching. This is done through the application of a latex solution usually applied by brush. The soles can then be loaded onto racks where the cement dries naturally. (See operation reference Nos 18 and 27 for Type 1 footwear).

II.7 Sole laying (Operation reference No. 42)

The object of this operation is to attach the sole to the shoe bottom by adhesive and to form the sole round the lasted bottom so that they are in close contact during stitching. It is important that leather-soles are mellow during this operation.

Sole presses identical to those described for attaching cemented-on soles can be used. Alternatively, soles can be tacked or stapled in position with the fasteners positioned near the edge of the channel. Thus, they can be avoided during stitching and will not leave visible holes in the finished shoe once they are removed after stitching.

II.8 Last removal (Operation reference No. 43)

The methods available for last-removal were dealt with in connection with cemented-on shoes. However, in this case, there is no sole to provide support to the bottom and the lasts used are normally of the hinged type so that they 'break' at the waist. The use of such lasts reduces the risk of damaging insoles, particularly when they are made of fibreboard.

II.9 Sole stitching (Operation reference No. 44)

II.9.1 Channel opening

The channels round the edge of the soles are opened up at this stage. Machines are available, but opening can be carried out by hand after the top surface of the lip has been moistened with a sponge to increase its plasticity.

II.9.2 Stitching

(i) Stitching techniques

All stitching machines have a swivelling horn placed inside the shoe and through which waxed thread is fed. The wax, which may be pre-heated, helps waterproof the sole. In chain stitching machines, the needle is hook shaped so that it can catch the thread when at the bottom of its stroke. It then pulls the loop through the layers of insole, upper and sole on the upstroke. It then links the loop into the chain with the proceeding loop.¹ Considerable skill is required to keep stitches vertical and the line of stitching in the bottom channel, particularly around the toe curve. After traversing from the waist round to the other side of the sole, keeping about 3mm. from the edge of the insole, the operator cuts off any excess thread.

¹ **Stitching configurations are illustrated in Appendix I(Glossary of terms).**

(ii) Equipment

Although machines have been used in this operation for over a hundred years, they are still expensive. Both

chainstitching and lockstitching machines are available.

New motor driven chainstitching machines can cost up to US\$4,000. Alternatively, small enterprises may buy less expensive used machines.

II.10 Sole levelling (Operation reference No. 45)

In this operation, the channel and lip are cemented, usually with brush applied latex. After drying, the lip is moistened to soften it and is then rubbed down with a metal bar. The shoes may require re-lasting before this operation, using a last smaller than the making last. The metal bar should be rust proof since iron can leave rust stains on the damp leather. Alternatively, this operation may be carried out with machines fitted with a rotating indented wheel. These machines reduce considerably the time needed for this operation.

To restore the curve of the waist, the shoe can then be mounted in a sole press with a female mould to compress the layers of material on the shoe bottom. Special purpose presses are available for this purpose whereby the shoe is mounted on a cast iron footform. It is then forced into a concave mould made from a non-corrosive alloy. Any press with a force of about four tonnes which may be gradually applied may be used for this operation.

II.11 Seat nailing (Operation reference No. 46)

The back of the sole is attached to the shoe by a semi-circle of nails driven from the outside. The nails pass through the sole, the lasted margin of the upper and the insole and are finally clenched on a flat topped iron horn on which the inverted shoe rests. The operation can be carried out by hand or on a special purpose nailing machine.

Surplus material is then trimmed from the edge of the sole around the seat. This rough rounding operation can be done manually with a knife. Alternatively, the excess material may be ground away with an abrasive covered wheel or on a special purpose disc knife. The wheel or the disc knife may be incorporated into a seat nailing machine so that both operations are carried out simultaneously.

II.12 Heel attaching (Operation reference No. 47)

When heels are built from stacked leather or leatherboard, they can be cut and built by hand with nails. However, the best results are obtained if a heavy load is used to compress the stack before nailing.

Since the shoes are unlasted at this point, they can be attached by nails driven from either inside or outside the shoe. Usually, the nail heads are on the inside of women's shoes and on the outside of men's shoes.

The nails attaching the heel can be driven manually or by special purpose machines. Heel attaching nails usually have rows of corrugations round them which helps provide a firm grip. Top pieces can be nailed or stapled onto the heel.

II.13 Re-lasting (Operation reference No. 48)

In this operation, lasts are put back into the shoes. Hinged lasts smaller than the making lasts are usually used to simplify

their subsequent removal.

II.14 Heel trimming (Operation reference No. 49)

The uneven edges of built heels can be smoothed and shaped by rough scouring on a emery covered wheel. Alternatively, a special purpose cutting machine called a heel parer can be used. The latter is preferred when heels with backward sloping concave curves are required on women's shoes.

Heel paring machines are fitted with rotating cutters consisting of a pair of knives shaped to the required contour. These cutters rotate at a very high speed. The top piece and the sole top edge act as guides for the shoe on either side of the cutter blades during paring.

II.15 Edge trimming (Operation reference No. 50)

The edge of the sole around the forepart is trimmed, back in preparation for the finishing operation. The edge is moistened to aid the operation.

Excess sole leather can be removed manually with a knife. Alternatively, special purpose machines costing about US\$300 are available. These machines have a guarded rotating knife. The operator guides the edge of the upper past this knife.

II.16 Bottom finishing (Operation reference No. 51)

Unless soles and heels are prefinished, a substantial amount of work remains to be carried out on them. The operations involved are described in some detail, since the view that a consumer forms of the quality of leather soled shoe is possibly influenced as much by the finish on the sole as by that on the upper.

The traditional bottom finishing sequence is very elaborate and includes several variants. However, it is rarely followed completely. A comprehensive sequence of operations is described below. Whenever appropriate, simple alternatives to the types of machines that are employed in large scale factories in developed countries are described.

II.16.1 Heel scouring

This operation removes marks left after heel paring, and polishes the surface. Usually, rough and fine grades of scouring paper are used. The work can be done by hand, or, preferably with a rotating wheel fitted with a felt backing on which is placed the scouring paper.

A number of machines, equipped with steel wheels that open into two halves to permit the ends of the felt and paper to be gripped are available. Sometimes, felts and paper are contoured to the heel shape and cut to a width that corresponds to the heel height. Square heels require only flat papers and felts. These can be cemented to the circumference of a wooden wheel, belt driven by a small motor (see figure II.11). A bicycle can also be adapted to provide the drive by removing the rear tyre, and clamping the frame in an upright position. A continuous belt drive taken around the back wheel and then around a small pulley on the wheel shaft completes the adaptation.

II.16.2 Heel dyeing

A spirit based dye of the required colour is applied with a fine hair brush. Sometimes, a wide brush is used for the heel and a narrow one for the top edge of the sole. Since the heel fibres open when wetted by dye, a second coat containing a small quantity of filler may be applied.

II.16.3 Fine heel scouring

Very worn fine scouring paper can be used at this stage to restore the surface roughened as a result of swelling during dyeing.

II.16.4 Edge inking

A soft toothbrush may be used to ink the top, flesh and surface of the sole next to the upper. The ink has more filler than that used for dyeing. To avoid the inadvertent application of ink to the upper, this operation is sometimes carried out before sole attaching.

II.16.5 Edge setting

This is an important operation since unset leather sole edges are very porous. Hand edge setting involves applying melted stick wax or wax in an emulsion with water to the sole edge. It is then rubbed with a pre-heated iron back and forth to polish and force the wax into the edge. Often, the process is repeated to obtain the desired degree of smoothness and water resistance. Flat edges can be set using any hard and smooth round object.

The irons used for rubbing the wax have their nose shaped to a slightly exaggerated reverse contour of the trimmed sole edges in one plane, and are slightly convex in the other plane. For flat edges, a wooden or plastic disc that is free to rotate on a length of bar, or even a round glass bottle, will suffice. Machines with heated oscillating irons are available. Irons are also often fitted to finishing machines that are used by repair workshops in developed countries.

II.16.6 Heel burnishing

Heel burnishing involves a number of operations, including: applying a hard wax to the heel with a rough cloth, producing a dull polish with a finer fabric; and finally producing a high polish with a brush or mop. Alternatively, a simple machine with three driven wheels carrying progressively finer cloths may be used for these operations.

II.16.7 Seat wheeling

This is a traditional operation that only performs a decorative function. It is now only applied to expensive men's shoes. The result of the operation is a narrow line of small vertical indentations round the seat at a level that overlaps the sole and heel. It is carried out with a handle carrying a freely rotating wheel with a milled edge. A lip to register against the upper edge of the sole acts as a guide.

II.16.8 Bottom scouring

The purpose of this operation is to produce a smooth clean surface in preparation for finishing the sole bottom. Two grades of scouring paper are used. They can be either mounted on the circumference of a driven wheel or wrapped round flat wooden blocks. When scouring by hand, a circular motion should be applied in order to avoid a grained effect. On some machines, the rotating cylinders reciprocate from side to side to produce a similar effect to hand scouring. If the leather is dry during this operation its surface structure can be damaged.

II.16.9 Naumkeaging

The purpose of naumkeaging is to scour the curved waist of leather soles. The equipment for this operation is often mounted on a vertical shaft at one end of proprietary finishing machines. It consists of a conical wheel round which scouring paper is secured. For hand scouring, the scouring paper can be wrapped around a suitably shaped piece of wood.

II.16.10 Bottom staining

Shoe bottoms can be finished in several ways, but only staining is considered here. In small enterprises, the stain - which can contain some wax - is painted on with two or three strokes of a soft wide brush.

II.16.11 Bottom burnishing

Once the stain has dried, the bottom of the sole is burnished with wax and cloth in a manner similar to that employed to burnish heels.

II.16.12 Bottom inspection

Some rectification of the bottom finishing work may be required. Melted wax and heated irons can be used to hide minor defects. After last removal, the soles may be branded on the waist or forepart. As described in the context of insole marking, the impression can be produced directly with a heated metal die or with embossing foil.

II.17 Tables of technical data

Tables III.5 and III.6 provide estimates of the needed workforce for the selected four scales of production, and the type, number and cost of the pieces of equipment required for each scale.

Table III.5 Workforce allocation at each output level for Type 3 footwear

(Jobs are shared by operatives in some cases)

Op. Ref No.	Operations	Scale 1 8prs/8hrs	1 Scale 2 40prs/8hrs	Scale 3 200prs/8hrs	Scale 4 1000prs/8hrs
1	*Cutting uppers	0.8 s	1.5 s	6 s	16 s
2	*Leather splitting				1 ss
3	*Lining marking		1 0 ss	1 11 s	1 11 s

	Limiting marking		1.0 ss	1 us	1 us
4	*Stitch marking				3 us
5	*Hole punching			2 ss	1 ss
6	*Sock embossing				2 ss
7	*Skiving			2 ss	4 ss
8	*Edge folding/cementing				3 us
9	*Stitch uppers	1.0 s	2.0 s	9 s	40 s
10	*Seam reducing		1.0 s	1 us	1 us
11	*Taping				1 us
12	*Eyelet reinforcing			1 us	1 us
13	*Punch/eyelet insertion				1 us
14	*Temporary lacing			3 s	2 us
15	*General fitting and puff insertion				2 ss
16	*Upper trimming				8 s
36	Insole preparation	1.0 s	1.0 ss	3 ss	4 ss
37	Sole preparation				4 ss
38	Insole tacking		2.0 s	2 us	1 us
20	*Stiffener insertion				1 us
21	*Upper conditioning				
39	Tack lasting			4 s	10 s
23	*Tack removal and inspection		1.0 ss	2 ss	2 ss
40	Bottom pounding				2 ss
24	*Heat setting				1 us
26	*Shank attaching	0.2 us	0.5 us	1 us	1 us
27	*Bottom cementing				2 us
28	*Bottom filling	1.0 s	2.0 s	1 ss	1 us
42	Sole laying				3 ss
43	Last removal				1 us
44	Sole stitching			1 s	2 s
45	Sole levelling				1 ss
46	Seat nailing			3 ss	3 ss
47	Heel attaching				2 ss

48	Relasting				1 us
49	Heel trimming	0.5 s	2.0 s	1 ss	1 ss
50	Edge trimming				1 ss
51	Bottom finishing			2 s	8 s
30	*Last removal				1 us
31	*Upper finishing	0.5s	1.0 s	4 s	14 s
	TOTAL DIRECT WORKERS	5	15	49	151

***See Type 1 equipment specifications for these operations,**
s = skilled (4 months training)
ss= semi-skilled (3 weeks training)
us= unskilled (1 week training)

Table III.6 Methods and equipment specifications for Type 3 footwear

Output per day: 8, 40, 200 and 1000 pairs

Type: Leather-upper, tack lasted shoes with machine-sewn leather soles

Op. Ref No.	Operations and Major Equipment required:	Equipment source ¹	No. required by scale ²				Estimated unit cost (\$)
			1	2	3	4	
1-16	See Type 1 footwear at same scale						
36	INSOLE PREPARATION						
	- clicking bench	local	OP1	1	2	1	30
	- clicking board	local	-	1	-	-	15
	- mechanical swing arm clicking press	Sup. list 1	-	-	1	1	2,200
	- press knives	Sup. list 1	-	-	30	-	40
	- insole moulding and sole conforming mach.	Sup. list 17	-	-	-	1	8,000
	- insole bevelling machine	Sup. list 17	-	-	-	1	2,500
37	SOLE PREPARATION						
	- clicking bench	local	OP1	1	1	-	30
	- clicking board	local	-	1	-	-	15
	- tempering tank	local	1	1	1	1	50

	- paring and channeling knives	local	-	5	5	-	6
	- mechanical swing arm clicking press	Sup. list 1	-	-	OP36	1	2,200
	- bench for waist reducing , bottom cementing and channel cutting	local	-	1	1	1	30
	- sole evening machine	Sup. list 37	-	-	1	1	1,800
	- sole rounding machine	Sup. list 37	-	-	-	1	7,000
	- manually powered channel cutter	Sup. list 37	-	-	-	1	1,000
	- mechanical swing arm clicking press	Sup. list 1	-	-	OP36	-	2,200
38	<u>INSOLE TACKING</u>						
	- tacking bench	local	1	1	1	1	25
	- tubular steel jack	local	1	1	1	2	5
20-21	See Type 1 footwear at same scale						
39	<u>TACK LASTING</u>						
	- lasting bench	local	OP38	1	1	2	25
	- jack (mounted on bench)	local	-	-	1	2	5
	- lasting pincers hammers and knives	Sup. list 22	4	-	20	-	4
	- hand tacking tool	Sup. list 22	-	-	1set	1set	1,000
	- manually operated drafting machine	Sup. list 22	-	-	1	-	3,000
	- manually operated lasting machine	Sup. list 22	-	-	1	-	5,000
	- back part moulding machine	Sup. list 22	-	-	-	1	10,500
	- pulling and lasting machine	Sup. list 22	-	-	-	1	18,000
	- tack side lasting mach.	Sup. list 22	-	-	-	1	6,000
	- tack seat lasting mach.	Sup. list 22	-	-	-	1	15,000
23	See Type 1 footwear at same scale						
40	<u>BOTTOM POUNDING</u>						
	- lasting bench	local	OP38	1	-	-	25
	- lasting jack	local	-	1	-	-	5
	- scouring buff without dust extractor	Sup. list 25	-	-	1	-	400
	- bottom roughing mach.	Sup. list 25	-	-	-	2	2,400
24 , 26,28	See Type 1 footwear at same scale						
42	<u>SOLE LAYING</u>						
	- bench	local	OP26	1	1	1	25

	- manually powered sole press	Sup. list 29	1	1	1	-	1,900
	<u>SOLE LAYING</u>						
42	- twin station hydraulic sole press	Sup. list 29	-	-	-	2	8,000
	<u>LAST REMOVAL</u>						
43	- tubular steel jack	local	1	1	1	1	5
44	- bench	local				1	25
	<u>SOLE STITCHING</u>						
	- lock stitch insole sewing machine (This operation could be performed in a central facility serving several small enterprises)	Sup. list 44	1	1	1	2	6,000
	<u>SOLE LEVELLING</u>						
45	- manually powered sole press using sole levelling plates		OP42	OP42	OP4	2 -	
	- twin station sole press with sole levelling plates	Sup. list 29	-	-	-	1	8,500
	<u>SEAT NAILING</u>						
46	- bench	local	OP26	1	1	-	25
	- tools for nailing and edge paring	Sup. list 1	-	3	5	-	7
	- loose nailing and rounding machine	Sup. list 46	-	-	-	1	3,000
47	<u>EEL ATTACHING</u>						
	- bench	local	OP26	OP46	-	-	
	- manually operated heel attaching machine	Sup. list 47	-	-	1	-	1,600
47	<u>HEEL ATTACHING</u>						
	- heel nailing machines for heel building and heel and top piece attaching	Sup. list 47	-	-	-	1	9,000
48	<u>RELASTING</u>						
	- bench	local	OP26	OP46	OP46	1	25
	- tubular steel jack	local	-	1	1	-	5
49	<u>HEEL TRIMMING</u>						
	- trimming bench	local	1	1	1		25
	- heel paring machine	Sup. list 49	-	-	-	1	4,000
50	<u>EDGE TRIMMING</u>						
	- trimming bench	local	OP49	OP49	OP49		25
	- sole trimming machine	Sup. list 50	-	1	1	-	300
	- edge trimming machine	Sup. list 50	-	-	-	1	1,200
51	<u>BOTTOM FINISHING</u>						

	- bottom finishing mach. with edge irons scouring wheels, mops and brushes (can be shared with small-scale ent.)	Sup. list 51	1	1	1	4	5,500
	- hand work bench for drying, inking and staining	local	-	1	1	1	25
30-31	See Type 1 footwear at same scale						

1 See equipment suppliers list in Appendix II.

2 The same pieces of equipment may be used in a number of operations. This is indicated by reference to the number of the operation where the equipment is used for the first time.

III. Type 4 footwear: Welded synthetic upper, string lasted shoes with moulded-on soles

Type 4 footwear is a welded synthetic upper, string lasted shoe with moulded-on sole. It is a substitute for leather upper shoes with cemented-on soles, to which it bears a superficial resemblance. As an upper material, PVC has a number of disadvantages: it is impermeable and does not therefore absorb sweat or allow it to escape, and lacks the wear resistant qualities of leather.

A process route for this type of footwear is outlined in Table III.7. Operations already dealt with in relation with footwear type 1 are marked with asterisks.

Usually, the PVC sheet that forms the upper material has a woven fabric backing. The seams are produced by means of high potential, high frequency electrical power under pressure. Rapid changes in the polarity of the particles that make up the material causes internal friction. This friction heats the material to above its melting point, and weld layers together.

Table III.7 Stages in the production of welded synthetic upper, string-lasting shoes with moulded-on soles

Production stages	Op. Ref.	Operations	Major materials
Upper cutting and welding	52	Cutting and welding uppers	PVC uppers and lining materials
	53	Upper welding	
	54	Lasting string attaching	Lasting string
	14*	Temporary lacing	String
	17*	Sock cutting	PVC or board socking
	6*	Sock embossing	
Lasting and moulding	20*	Stiffener insertion	Heel stiffeners
	55	String-lasting and moulding-on	Sole raw materials
	56	Sock insertion	Socks
Upper finishing	31*	Upper finishing operations, packing	Packing materials

The operations marked (*) are discussed in the section dealing with leather-upper, cement-lasting shoes with

cemented-on soles.

The output capacities of the equipment described in the remaining part of this section are relatively high. Thus, although capital investments are also high, unit production costs are generally low. This type of shoes may, therefore, be particularly suitable for low to middle income groups in developing countries although the manufacturing processes are relatively capital-intensive.

III.1 Cutting and welding upper components (Operation reference No. 52)

(i) Processing techniques

Upper components may be cut in the conventional manner with knives. Alternatively, heat cutting and welding can both be performed on a single machine. The machine can be fitted with a material roll feed unit enabling two thicknesses of material to be cut to shape as well as welded together during the operation. Thus, the back parts of the upper can be welded to a lining material round their top lines to form pockets for stiffeners. Similar arrangements can be made to locate toe puffs.

(ii) Equipment

Typical machines of the type described above have open fronted twin station welding areas approximately fifty centimeters square. Two work stations can be arranged on the table so that an operator can unload work at one station while a welding cycle takes place at the other. Power requirements on such machines are three kilowatts for the press and ten kilowatts for the generator needed for the high frequency welding operations. This type of machine is often operated for two or three shifts a day in developed countries.

III.2 Welding upper components together (Operation reference No. 53)

The type of machine used for this operation works on the same principle as the cutting and welding machine described above, but is smaller and consumes a total of about four kilowatts. Operations performed by this type of machines replace the conventional closing operations on shoe uppers performed by means of stitching. A variety of welding tools is required for operations such as side and back seam welding and for tongue attaching.

III.3 Lasting string attaching (Operation reference No. 54)

Lasting string is made from strong, loosely twisted cord. It is held in position around the lasting margin of the shoe by a run of overlock chainstitch loops. This allows the string to run freely through them.

Specially adapted conventional stitching machine or stitchers of the type used for glove manufacturing are suitable for this operation.

III.4 String lasting and moulding-on of soles (Operation reference No. 55)

Shoes with directly moulded-on soles can be string lasted immediately before sole moulding on metal foot-forms attached to

the machines. Usually, stiff socks-cum-insoles, which cover the whole bottom, are inserted after moulding.

III.4.1 String lasting

String lasting is becoming increasingly popular for lasting light leather upper materials onto conventional insoles, using wooden or plastic lasts, prior to cementing-on sole units. Lasting involves pulling the two ends of the string tightly so that the lasted margin bunches in over the sole of the last and stretches the upper down onto it. The lasting string may run either once around the lasting margin or twice around the forepart and once around the seat. Operators should wear a leather glove for protection when lasting is performed manually. Pneumatically powered string hauling equipment is available.

III.4.2 Moulding

The lasting margin of synthetic uppers is solvent wiped prior to moulding. The sole moulding process is similar to the one described for conventionally lasted shoes with moulded-en soles.

Equipment

Moulding machines are used for this operation. They are often single or twin station machines, having two or three metal footforms per station. One footform is used for string lasting while the second footform moulds-on the sole. Soles may cool on a third footform if one is included. The footforms are indexed between moulding cycles. The waists of the footforms may have magnetic inserts so that steel stiffening shanks placed on them can be incorporated into the upper surfaces of the soles. Alternatively, arrangements of spikes can be used to locate wooden shanks.

III.5 Sock insertion (Operation reference No. 56)

In situations where the soles are to be moulded-on immediately after string lasting, insoles need not be lasted into the shoes. Instead, socks of a heavy substance can be used to line the whole inside of the shoe's soles. These socks are cemented to the top surface of the soling material and blank off any cavities moulded into the top of the sole for lightening purposes. Inserting these stiffeners can be time consuming due to their size and stiffness.

Following this operation, the shoe is ready for finishing and packing. This latter operation is the same as that used for the previous types of footwear.

III.6 Tables of technical data

Table III.8 provides estimates of labour requirements for the selected scales of production, while Table III.9 lists the type and number of tools and equipment needed for each production scale.

Table III. 8 Workforce allocation at each output scale for Type 4 footwear

Note: Where an operative is only required part-time on an operation the work is split.

This construction is unlikely to be used at output levels of 8 and 40 pairs per day.

Op. Ref No.	Operations	Scale 1 8prs/8hrs	Scale 2 40prs/8hrs	Scale 3 200prs/8hrs	Scale 4 1000prs/8hrs
52	Cutting and welding uppers	-	-	1 ss	2 ss
53	Upper welding	-	-	1 ss	2 ss
54	Last string attaching	-	-		2 ss
14	*Temporary lacing	-	-	1 s	2 us
17	*Sock cutting	-	-		3 ss
6	*Sock embossing	-	-		2 ss
20	*Stiffener insertion	-	-		1 us
55	String last and moulding-on	-	-	1 s	3 s
56	Sock insertion				2 us
31	*Upper finishing and packing	-	-	2 s	7 s
	TOTAL: DIRECT WORKERS	-	-	6	26

***See Type 1 equipment specification for these operations.**

s = skilled (4 months training)

ss = semi-skilled (3 weeks training)

us = unskilled (1 week training)

Table III.9 Methods and equipment specifications for Type 4 footwear

Output per day; 200 and 1000 pairs of shoes

Type: Welded synthetic upper, string-lasted shoes with moulded-on soles

Op. Ref No.	Operations and Major equipment required	Equipment source	No. required by scale		Estimated unit cost (\$)
			3	4	
52	UPPER CUTTING AND WELDING				
	- twin station welding and cutting machine, generator and cutting and welding tools	Sup. list 52	1	2*	34,000
53	UPPER WELDING				
	- seam welding machine with tools	Sup. list 52	1	2	8,000
54	LAST STRING ATTACHING	Sup. list 54	1	2*	1,600
	- overlock chain stitching machine	Sup. list 35	8	12	2,125
14,17 6,20	See Type 1 footwear at same scale				

55	STRING LASTING AND MOULDING-ON				
	- sets of moulds and foot-forms				
	- preheater	Sup. list 35	1	2	800
	- granulator	Sup. list 35	-	1	1,400
	- single station PVC injection moulding-on machine	Sup. list 35	1	-	23,000
	- twin station PVC moulded-on machines	Sup. list 35	-	2*	35,000
	- last string pullers	Sup. list 35	-	2	1,000
56	SOCK INSERTION				
31	- hand fitting and cementing at bench See Type 1 footwear at at same scale	local	1	2	25

***A single machine is needed when used on a two-shift basis.**

IV. Type 5 footwear: Stitched synthetic upper cement-lasted sandals and casual shoes with built or unit soles

The type of footwear considered in this section are stitched synthetic upper, cement-lasted sandals and casual shoes with built or unit soles. While the majority of the footwear of this type is manufactured for the women's market, none of the constructions covered are exclusively used for either women's or men's footwear. Shoes of the flip-flop and buckling types, with stitched synthetic uppers and with either flat or raised heels comes under the type 5 footwear. They typically have a PVC coating and a woven fabric backing. However, few changes to the basic sequence of operations would be required if leather rather than synthetic uppers were used, or if men's or children's sandals were to be produced.

In tropical climates, a large proportion of the demand for women's shoes often consists of plastic casual and sandals produced by injection moulding machines. This latter type of footwear - described in the following section of this chapter - is mostly marketed among low-income groups. On the other hand, the type of footwear described in this section are more likely to be marketed among middle-income groups.

The process sequence is shown in Table III.10. Only the five operations that are unique to this type are discussed below since the other operations have already been dealt with earlier.

IV.1 Sole and insole preparation (Operation reference No. 57)

Outsoles can be cut to shape from sheets of rubber or resin and man-made composite materials. This may be done by hand or with the assistance of a press. Insoles preparation is similar to that for cement-lasted, cemented-on construction, with the exception of the following: (i) the bevelling of the edge of the insole backpart is unnecessary on open backed shoes, (ii) a binding of fabric or of upper material may be cemented around the edge of the insole if it were to show on the finished sandal, and (iii) the bottom of the insole may be reduced in thickness in areas where straps must be lasted to it.

Table III.10 Stages in the production of stitched synthetic upper cement-lasted sandals and casual shoes with built or unit

soles

Production stages	Op. ref.	Operations	Major materials
Upper cutting	1	*Cutting upper components	Sheets of upper materials
Upper preparation	3	*Lining marking	
	4	*Stitch marking	
	5	*Hole punching	
	6	*Sock embossing	
	7	*Skiving	
	8	*Edge folding and cementing	
Upper stitching	9	*Stitching of uppers	Threads and tapes
Stitched upper finishing	10	*Seam reducing	
	11	*Taping	Tapes
	15	*General fitting/attaching	Trim, puffs
	16	*Upper trimming	
	57	Sole and insole preparat.	
Bottom component preparation	58	Heel preparation	Sole units and insole sheet Heels
Making	19	*Insole tacking	
	20	*Stiffener insertion	Heel stiffeners
	21	*Upper conditioning	
	59	Lasting uppers	
	23	*Tack removal/inspection	
	25	*Bottom roughing	
	26	*Shank attaching	Shanks
	27	*Bottom cementing	
	28	*Bottom filler insertion	Felt
	29	*Sole laying	
	30	*Last removal	
	60	Heel attaching	
	61	Sole finishing	
Upper finishing	31	*Upper finishing and packing	Packing materials

***The operations marked with (*) are discussed in the section dealing with leather-upper, cement-lasted shoes with**

cemented-on soles.

IV.2 Heel preparation (Operation reference No. 58)

Prevailing fashions determine if women's casual shoes may have prefinished sole units, wedge or flat soles or separate soles and heels. It is nowadays unusual to carry out the finishing of the heels of women's shoes after they have been attached since most heels are made of wood or plastic covered with material which matches or contrasts with the upper. Even when heels are built from stacked leatherboard, they are prefinished before attaching.

When mould parting lines are not evident (as they may be on some type of plastic heels), heels may be painted by hand or sprayed with cellulose paint. Cementing operations associated with heel covering are, usually, carried out by hand.

IV.3 Lasting uppers (Operation reference No. 59)

Lasting this type of footwear is much simpler than for other types of footwear since open work uppers do not require lasting at the toe and heel. The lasting techniques vary with style, but they only involve the pulling of pre-heated uppers over the lasts followed by side-lasting onto the insoles. For example, they are not needed in cases where the upper consists of two narrow straps fed through slots cut in the insoles and cemented to the insole bottom.

IV.4 Heel attaching (Operation reference No. 60)

When separate heels are used, they are usually attached to the insole by a maximum six nails driven out into the heel through the insole. Heel attaching can be done by hand or by machine. Simple, manually operated machines costing US\$700 are available. They can attach a heel in about one minute. Hand nailing takes longer and requires skills whenever high heels are used.

IV.5 Sole, finishing (Operation reference No. 61)

Where laminated sole or heel units are built up, or when pre-cut outsoles or heels are attached to insoles so that their edges are exposed on the completed footwear, mismatches on the edges usually need trimming and smoothing.

Operators require considerable skill to produce a neat finish regardless of the type of machinery used. Simple, inexpensive machines of a type used by shoe repairers in developed countries may be used for this operation. These machines are usually bench mounted and driven by small electric motors. Elaborate machines are also available. Their use may not, however, be justified for conditions in developing countries.

IV.6 Tables of technical data

Tables III.11 and III.12 provide estimates of labour requirements for the four selected scales of production, and the estimated number of pieces of equipment needed for the additional operations used in the production of Type 5 footwear.

Table III.11 Workforce allocation at each output scale for Type 5 footwear

Op. Ref.	Operation	Scale 1	Scale 2	Scale 3	Scale 4
-----------------	------------------	----------------	----------------	----------------	----------------

Up. ker No.	Operations	Scale 1 8prs/8hrs	Scale 2 40prs/8hrs	Scale 3 200prs/8hrs	Scale 4 1000prs/8hrs
1	*Cutting uppers	0.7 s	1 s	5 s	16 s
3	*Lining marking			1 us	1 us
4	*Stitch marking				3 us
5	*Hole punching		1 ss	2 ss	1 ss
6	*Sock embossing				2 ss
7	*Skiving			1 ss	1 ss
8	*Edge folding/cementing				2 us
9	*Stitching uppers	1.0 s	2 s	8 s	36 s
10	*Seam reducing		1 s	2 s	1 us
11	*Taping				
15	*General fitting and puff attachment				1 ss
16	*Upper trimming				5 s
57	Prep, sole and insole	0.3 ss	1 ss	1 ss	4 ss
58	Heel preparation				1 ss
19	*Insole tacking	1.0 s	1 s	1 us	1 us
20	*Stiffener insertion				1 us
21	Upper conditioning				
59	Cement lasting			1 s	5 s
23	*Tack removal/inspection			1 ss	2 ss
25	*Bottom roughing				2 ss
26	*Shank attaching		1 s	2 ss	1 us
27	*Bottom cementing				2 us
28	*Bottom filling				1 us
29	*Sole laying				2 ss
30	*Last removal				1 us
60	Heel attaching			1 s	2 ss
61	Sole finishing				4 s
31	*Upper finishing		1 s	3 s	10 s
	TOTAL DIRECT WORKERS	3	9	29	108

Note: Where an operative is only required part time on an operation, the work is split.

*See type 1 equipment specifications for these operations.

s = skilled (4 months training)

ss = semi-skilled (3 weeks training)

us = unskilled (1 week training)

Table III.12 Methods and equipment specifications for Type 5 footwear

Output per day: 8, 40, 200 and 1000 pairs

Type: Stitched synthetic upper cement-lasted shoes with cemented-on built and unit soles

Op. Ref. No.	Operations and Major Equipment required	Equipment source ¹	No. required by scale. ²				Estimated unit cost \$
			1	2	3	4	
1-16	See Type 1 footwear at same scale						
57	PREPARATION OF SOLES AND INSOLES						
	- clicking bench	local	OP1	1	1	1	25
	- clicking press	Sup. list 1	-	-	1	2	2,200
	- press knives	Sup. list 1	-	-	20	60	40
	- cutting knives	Sup. list 1	3	3	-	-	6
	- cutting board	local	-	1	-	-	15
	- insole moulding mach.	Sup. list 17	-	-	-	1	8,000
58	PREPARATION OF HEELS						
	- clicking bench	local	OP57	OP57	OP57	OP57	
	- manually operated heel attaching machine for heel building	Sup. list 47			1		2,500
	- heel attaching machine	Sup. list 47	-	-	-	1	10,800
19-21	See Type 1 footwear at same scale						
59	CEMENT LASTING						
	- bench	local	OP19	OP19	1	3	25
	- lasting pincers and knives	Sup. list 22	3	6	10	40	4
	- jacks	local	-	-	1	6	5
23,25 30	See Type 1 footwear at same scale						
60	HEEL ATTACHING						
	- cemented heel attachment for sole press	Sup. list 20	1				500

	- manually operated heel-attachment for sole press	Sup. list 29	1	-	-	-	600
	- manually operated heel attaching machine	Sup. list 47	-	1	1	-	2,200
	- heel attaching machine	Sup. list 47	-	-	-	1	10,800
61	SOLE FINISHING						
	- sole trimming machine on bench	Sup. list 50	1	-	-	-	300
	- edge finishing wheel on powered buff without dust extraction	Sup. list 25	1	-	-	-	400
	- bottom finishing machine with edge irons, scouring wheels, mops and brushes*	Sup. list 51	-	1	1	3	5,500
	- hand work bench for inking and drying of heels	local	-	-	1	1	25
31	See Type 1 footwear at same scale						

1 See equipment suppliers list in Appendix II.

2 The same pieces of equipment may be used in a number of operations. This is indicated by reference to the number of the operation where the equipment is used for the first time.

***May be shared by several small enterprises.**

V. Type 6 footwear: Single injection, moulded plastic sandals

Single injection moulded plastic sandals are typically of the 'flip-flops' type, with broad straps across the forepart and completely open backparts and toes. Closed sandal designs are sometimes produced, but may not look attractive unless the tooling quality is very high. The main merit of sandals of this type is that they are inexpensive. On the other hand, they have a number of disadvantages when compared to leather sandals: they do not absorb sweat, are difficult to repair and require a large capital investment in machining and tooling for their production.

The various operations specific to the production of plastic sandals are briefly described below.

V.1 Single injection moulding technique and equipment (Operation reference No. 62)

In the production of moulding, melted PVC is injected into a split metal mould. The process is very similar to that used for the direct moulding-on of soles to pre-lasted uppers. However, in the case of single injection moulding, the moulds incorporate spaces which allow the melted PVC to form both the uppers and the soles. After solidification of the melted plastic, the mould is opened and the finished moulding ejected. The moulding and cooling cycle time varies with the weight of the material injected, the amount of mould cooling applied and the shape of the moulding. Once the best settings and the automatic cycle have been established, it is only necessary for the machine operator to fill up the raw material hopper and to remove any flash from the mouldings. If the range of moulds on the machine does not cover the full range of sizes and styles that are required, it will be necessary to change moulds occasionally. The colour of the PVC granules may also be changed from time to time.

After moulding, sandals have any trim added and are then inspected and packed.

Since PVC is thermoplastic, mould runners, sprues, and flash can be regranulated and fed back into the process.

The moulding operation is the only important operation in the production of plastic sandals, the other operations consisting of packaging and re-granulating of PVC wastes.

Various types of single injection moulding machines are available on the market. The choice of machine will depend on the selected batch and market sizes. These determine which of the available single-station, twin-station or multi-station machines are the most appropriate ones. In general, whenever the product mix is very wide and the batch sizes and total volumes of output are small, single station or twin station machines are likely to be more economically efficient than multi-station machines. The former machines may also be used by large-scale enterprises for the completion of small orders or the carrying out of tooling trials.

V.2 Tables of technical data

Tables III.13 and III.14 provide estimates of the required labour force and equipment. Given the high capital-intensity of the production process, single injection moulding may not be adopted for scales of production lower than 200 pairs per day. Thus, no data is provided for scales 1 and 2.

Table III.13 Workforce allocation at each output level for Type 6 footwear

Note 1: Where an operative is only required part time on an operation, the work is split.

Note 2: One-shot moulding is unlikely to be undertaken at daily output levels of 8 and 40 pairs.

Op. Ref No.	Operations	Scale 1 8prs/8hrs	Scale 2 40prs/8hrs	Scale 3 200prs/8hrs	Scale 4 1000prs/8hrs
62	One-shot injection moulding of complete sandals	-	-	2 ss	3 ss
63	Packing	-	-	1 us	1 us

ss = semi skilled (3 weeks training)

us = unskilled (one week training)

Table III.14 Methods and equipment specifications for Type 6 footwear

Output: 200 and 1000 pairs per 8 hours

Type: Single injection moulded PVC sandals

Op. Ref No.	Operations and Major Equipment Required	Equipment source	No required by scale		Estimated unit cost
			3	4	
					\$

62	<u>SINGLE INJECTION MOULDING OF SANDALS</u>				
	- twin station, semiautomatic injection moulding machine, moulds and racks	Sup. list 62	1		40,000
	- ten-station, semiautomatic injection moulding machine, moulds and racks	Sup. list 62		1	110,000
63	- granulator	Sup. list 35	1	1	1,400
	<u>PACKING</u>				
	- packing bench	local	1	1	25

