








































➔  **Tools for Mining: Techniques and Processes for Small Scale Mining (GTZ, 1993, 538 p.)**

-  **(introduction...)**
-  **Acknowledgements**
-  **Preface**
-  **Guide to the user**
-  **Introduction**
- A. Analysis**
  -  **A.1. Definition**
  -  **A.2. Initial conditions and problem areas**
- Technical Chapter 1: Analysis**
  -  **1.1 Blow pipe assaying**
  -  **1.2 Pycnometer**
  -  **1.3 Manual magnetic separator by Dr A. Wilke**
  -  **1.4 Quick-test-strips merckoquant**
  -  **1.5 Rifflebox**
- B. Underground mining**
  -  **B.1. Definition**
  -  **B.2. Existing situation and problem areas**
  -  **B.3. Organizational measures**
  -  **B.4 Environmental and health aspects**

- **Technical Chapter 2: Safety Techniques**
  - 📄 **(introduction...)**
  - 📄 **2.1 Safety kit**
- **Technical Chapter 3: Ventilation**
  - 📄 **3.1 Bricked brattice, bricked duct**
  - 📄 **3.2 Small blowers, manual fans**
  - 📄 **3.3 Air-jet ventilator**
  - 📄 **3.4 Hydro-compressor**
  - 📄 **3.5 Ventilation oven**
  - 📄 **3.6 Wind sail**
  - 📄 **3.7 Box blower**
  - 📄 **3.8 Bell blower baaders blower**
- **Technical Chapter 4: Water supply and drainage**
  - 📄 **4.1 Pneumatic positive-displacement pump**
  - 📄 **4.2 Chinese liberation pump**
  - 📄 **4.3 Water bag**
  - 📄 **4.4 Bucket-chain conveyor**
  - 📄 **4.5 Pneumatic high-pressure pump**
- **Technical Chapter 5: Support**
  - 📄 **5.1 Rigid support in drifts and stopes**
  - 📄 **5.2 Single mechanical prop**
  - 📄 **5.3 Hydraulic prop support**
  - 📄 **5.4 Rock bolts, rods, rock stabilizers**

- **Technical Chapter 6: Lighting**
  - 📄 **6.1 Underground lighting equipment**
- **Technical Chapter 7: Stoping**
  - 📄 **7.1 Pneumatic jack hammer, drilling stand, jackleg**
  - 📄 **7.2 Gasoline hammer drill**
  - 📄 **7.3 Wedge ram**
  - 📄 **7.4 Electric hammer drill with stand Y D Z**
  - 📄 **7.5 Manual mining methods**
  - 📄 **7.6 Pneumatic charging machine for explosives**
- **Technical Chapter 8: Loading**
  - 📄 **8.1 Mucking sheet**
  - 📄 **8.2 Hand scraper and tray**
  - 📄 **8.3 Scraper loader**
  - 📄 **8.4 Pneumatic overhead loader**
  - 📄 **8.5 Chute, charging hopper**
- **Technical Chapter 9: Hauling**
  - 📄 **9.1 Manual winch**
  - 📄 **9.2 Motor cars as hauling machines, depth indicators**
  - 📄 **9.3 Block and pulley**
  - 📄 **9.4 Trackless and track bound haulage**
  - 📄 **9.5 Passenger lifting moving ladder**
- **C. Surface mining**
  - 📄 **C.1. Definition**

-  **C.2. Initial conditions and problem areas**
-  **C.3. Factors related to environment and health**
-  **C.4. Pit and quarry industry**
-  **Technical Chapter 10: Surface Mining Equipment**
  -  **(introduction...)**
  -  **10.1 Aerial cable-way by gravity**
  -  **10.2 Cable tool drill**
  -  **10.3 Suction dredge**
  -  **10.4 Hydram, hydraulic ram pump, rife ram**
  -  **10.5 Noria**
  -  **10.6 Tyre pump**
  -  **10.7 Archimedian screw**
  -  **10.8 Boat mill**
  -  **10.9 Hydraulic mining gravel pump mining**
-  **Technical Chapter 11: Other special techniques**
  -  **11.1 Welding additives**
  -  **11.2 Rubber tanks, flexible tanks**
  -  **11.3 BY-Pass oil filters, by-pass micro-filters**
  -  **11.4 Eccentric motor, vibrator, shaker**
-  **D. Beneficiation**
  -  **D.1. Definition**
  -  **D.2. Initial conditions and problem areas**
  - 

### **D.3. Proposals for procedural and organizational solutions**

 **D.4. Environmental and health aspects**

 **D.5. Processing of diamonds**

 **D.6. Gold beneficiation processing**

 **D.7 The processing of phosphate-containing raw-minerals into p-fertilizers**

### **Technical Chapter 12: Crushing**

 **(introduction...)**

 **12.1 Jaw crusher, jaw breaker**

 **12.2 Roll crusher, roll grinder**

 **12.3 Ball mill**

 **12.4 Stamp mill, hammer mill**

 **12.5 Chilean mill edge mill, roller mill**

 **12.6 "See-saw" crusher, "rocker" crusher**

### **Technical Chapter 13: Classification**

 **13.1 Set of rigid screens**

 **13.2 Screen riddle, vibrating screen**

 **13.3 Cantilever grizzly**























 **13.4 Sizing drum, classifying drum**























 **13.5 Cone classifier**























 **13.6 Countercurrent hydraulic classifier**

 **13.7 Hydro-cyclone**














-  **13.8 Bag washer, spiral classifier**
-  **13.10 Sluice, sluice box, washing sluice**
-  **Technical Chapter 14: Sorting**
  -  **14.1 Jig screen, hand-jigging**
  -  **14.2 Simple hand jig, moving bed(percussion) jig**
  -  **14.3 Hand piston jig**
  -  **14.4 Piston jig, 'harzer' jig**
  -  **14.5 Pulsator classifier pan american jig**
  -  **14.6 Sluices with or without linings/insets, long tom**
  -  **14.7 Ground sluice**
  -  **14.8 Pinched sluice, fanned sluice**
  -  **14.9 Air separator, dry blower**
  -  **14.10 Settling basin, buddle**
  -  **14.11 Circular buddle**
  -  **14.12 Dolly tub**
  -  **14.13 Bumping table, concussion table**
  -  **14.14 Racking table, tilting frame**
  -  **14.15 Sweeping table, belt table**
  -  **14.16 Vibrating table**
  -  **14.17 Humphrey's spiral, spiral separator**
  -  **14.18 Spiral concentrator**
-  **Technical Chapter 15: Gold Benefication**

-  **15.1 Amalgamating table**
-  **15.2 Amalgamating table**
-  **15.3 Amalgamating barrel**
-  **15.4 Rocker, cradle**
-  **15.5 Mechanized, compact gold processor**
-  **15.6 Hydraulic gold trap**
-  **15.7 Retort for, amalgam**
-  **15.8 Centrifugal separator**
-  **15.9 Gold pan, batea**
-  **15.10 Jigs with jig bed, russel jig**
-  **15.11 Gold leaching**
-  **15.12 Gold separation by smelting**
-  **15.13 Gold-coal-agglomeration**
-  **Technical Chapter 16: Other Sorting and Separating Techniques**
  -  **16.1 Roasting oven, calcining furnace**
  -  **16.2 Salt gardens, salt works, salterns**
  -  **16.3 Sulfur production in heap smelting or chamber ovens**
  -  **16.4 Autoclaves for extracting sulfur**
  -  **16.5 Copper sulfate plant**
  -  **16.6 Electrostatic sorting**
  -  **16.7 Flotation**
-  **Technical Chapter 17: Drying**

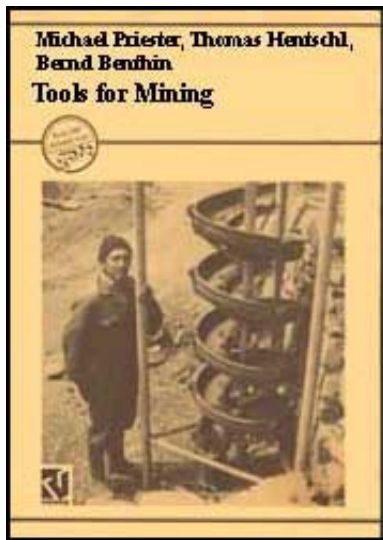
-  **17.1 Drying oven**
-  **17.2 Solar houses**
-  **17.3 Drying areas, drying surfaces**
-  **Technical Chapter 18: Clarification**
  -  **18.1 Thickener**
  -  **18.2 Lamella-thickener**
  -  **18.3 Continuous (rake) thickener**
-  **E. Mechanization and energy supply**
  -  **E.1. Introduction**
  -  **E.2. Energy source**
  -  **E.3. Drive unit**
  -  **E.4. Energy conversion**
  -  **E.5. Distribution of energy**
  -  **E.6. Energy systems**
  -  **E.7. Aspects of mechanization in mining**
  -  **E.8. Environmental and health aspects**
-  **Technical Chapter 19: Energy Techniques**
  -  ***(introduction...)***
  -  **19.1 Bicycle drive pedal drive**
  -  **19.2 Animal-powered whim**
  -  **19.3 Water balance**
  -  **19.4 Wind generator**










-  **19.5 Savonius rotor**
-  **19.6 Water wheel**
-  **19.7 Horizontal water wheel**
-  **19.8 Rope turbine**
-  **19.9 Solar cells**
-  **19.10 Solar collector (solar thermal)**
-  **19.11 Water turbine**
-  **19.12 Internal combustion engine**
-  **Bibliography**
-  **List of manufacturers and suppliers**
-  **List of abbreviations**



[Home](#) > [ar](#).[cn](#).[de](#).[en](#).[es](#).[fr](#).[id](#).[it](#).[ph](#).[po](#).[ru](#).[sw](#)



-  **Tools for Mining: Techniques and Processes for Small Scale Mining (GTZ, 1993, 538 p.)**
-  **(introduction...)**
-  **Acknowledgements**
-  **Preface**
-  **Guide to the user**
-  **Introduction**
- A. Analysis**
- Technical Chapter 1: Analysis**
- B. Underground mining**

- Technical Chapter 2: Safety Techniques**
- Technical Chapter 3: Ventilation**
- Technical Chapter 4: Water supply and drainage**
- Technical Chapter 5: Support**
- Technical Chapter 6: Lighting**
- Technical Chapter 7: Stoping**
- Technical Chapter 8: Loading**
- Technical Chapter 9: Hauling**
- C. Surface mining**
- Technical Chapter 10: Surface Mining Equipment**
- Technical Chapter 11: Other special techniques**
- D. Beneficiation**
- Technical Chapter 12: Crushing**
- Technical Chapter 13: Classification**
- Technical Chapter 14: Sorting**
- Technical Chapter 15: Gold Beneficiation**
- Technical Chapter 16: Other Sorting and Separating Techniques**
- Technical Chapter 17: Drying**
- Technical Chapter 18: Clarification**
- E. Mechanization and energy supply**
- Technical Chapter 19: Energy Techniques**
-  **Bibliography**



**List of manufacturers and suppliers**

**List of abbreviations**

**Techniques and processes for Small Scale Mining  
by Michael Priester, Thomas Hentschel, Bernd Benthin**

**A Publication of the Deutsches Zentrum fr Entwicklungstechnologien - GATE A  
division of the Deutsche Gesellschaft fr Technische Zusammenarbeit (GTZ) GmbH -  
1993**

***The authors:***

**Dr.-Ing. *Michael Priester*, mining engineer, has accumulated very extensive experience in small-scale mining and mining/environment in developing countries in such commodities as zinc, tungsten, lead-silver, antimony, coal, diamonds and gold. He is a specialist in traditional techniques for exploitation and beneficiation, exploration projects, assistance and education.**

**Dipl.-Geogr. *Thomas Hentschel* has gained extensive experience in small-scale mining in Latin America. He is specialized in economic and energy aspects, transport infrastructure and environmental aspects.**

**Dipl.-Econ. *Bernd Benthin* specialized in social-economic and historical-technical aspects os small-scale mining. He as well as the afore mentioned belongs to the team of Projekt-Consult, Beratung in EntwicklungsIndern GmbH.**

***Front cover:***

## **Humphrey's spiral for the concentration of tin ores in Kalauyo Mine near La Paz, Bolivia**

### **Die Deutsche Bibliothek - CIP-Einheitsaufnahme**

**Priester, Michael:**

**Tools for mining: techniques and processes for small scale mining; a publication of Deutsches Zentrum fr Entwicklungstechnologien - GATE, a division of the Deutsche Gesellschaft fr Technische Zusammenarbeit (GTZ) GmbH /**

**Michael Priester; Thomas Hentschel; Bernd Benthin. -**

**Braunschweig; Wiesbaden: Vieweg, 1993**

**ISBN 3-528-02007-6**

**NE: Hentschel, Thomas;; Benthin, Bernd:**

**The author's opinion does not necessarily represent the view of the publisher.**

**All rights reserved**

**© Deutsche Gesellschaft fr Technische Zusammenarbeit (GTZ) GmbH, Eschborn 1993**

**Published by Friedr. Vieweg & Sohn Verlagsgesellschaft mbH, Braunschweig**

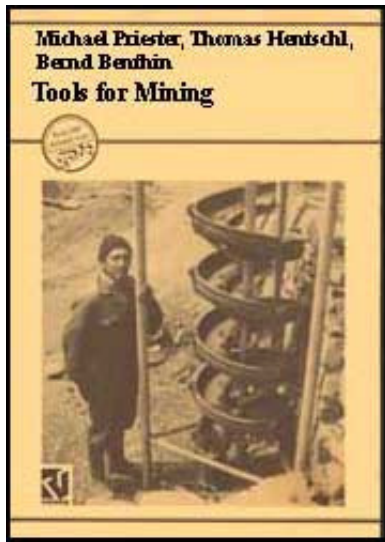
**Vieweg is a subsidiary company of the Bertelsmann Publishing Group International.**

**Printed in /germany by Lengericher Handelsdruckerei, Lengerich**

**ISBN 3-528-02007-6**











**[Home](#)"" """"> [ar.cn.de.en.es.fr.id.it.ph.po.ru.sw](#)**



## **Tools for Mining: Techniques and Processes for Small Scale Mining (GTZ, 1993, 538 p.)**

### **Technical Chapter 3: Ventilation**

-  **3.1 Bricked brattice, bricked duct**
-  **3.2 Small blowers, manual fans**
-  **3.3 Air-jet ventilator**
-  **3.4 Hydro-compressor**
-  **3.5 Ventilation oven**
-  **3.6 Wind sail**
-  **3.7 Box blower**
-  **3.8 Bell blower baaders blower**

## **Tools for Mining: Techniques and Processes for Small Scale Mining (GTZ, 1993, 538 p.)**

### **Technical Chapter 3: Ventilation**

#### **3.1 Bricked brattice, bricked duct**

#### **Deep Mining in Solid Rock Underground Mining Ventilation**

germ.: Streckenscheider, gemauerte Lutte

span.: canal de ventilacion embovedado, huayrachina, huayracanyon

<b><u>TECHNICAL DATA:</u></b>	
Dimensions:	air channel approx. 30 cm in width × 70 cm in height
Extent of Mechanization:	not mechanized
Form of Driving Energy:	differential air pressure and temperature
Alternative methods:	blowing or exhaust ventilation
Mode of Operation:	continuous
Operating Materials:	contruction material
Type:	rough rocks, loam
<b><u>ECONOMIC DATA:</u></b>	
Investment Costs:	labor costs only
Operating Costs:	none
Related Costs:	none for mechanized ventilation fans

### **CONDITIONS OF APPLICATION:**

Operating Expenditure:		low  ----- -----  high
Maintenance Expenditure:		low  ----- -----  high
Personnel Requirements:	none	
Location Requirements:	none	
Ore Requirements:	none	

Host Rock                      Larger host-rock fragments should be generated during blasting

Requirements:	for use in constructing the duct (huayrachina), requiring that the mine's drilling scheme be adjusted accordingly
Regional Distribution:	In earlier times, widely distributed in Latin America
Environmental Impact:	low  — — — —  very high
Suitability for	
Local Production:	very good  — — — —  bad
Under What Conditions:	limited to construction of the duct (huayrachina)
Lifespan:	very long  — — — —  very short

## **Bibliography, Source: Priester, Schauroth, Ponson, Winkelmann**

### **OPERATING PRINCIPLE:**

**Huayrachina is a bricked duct erected on one side of the roadway floor. This method is suitable for ventilating mines with only one opening to the surface. On the surface, the huayrachina ends in a chimney or short ventilation raise in order to achieve the required pressure differential.**

### **AREAS OF APPLICATION:**

**For ventilation of drifting or tunnelling operations. For ventilation of isolated activities in mines with natural ventilation.**

### **REMARKS:**

**The natural mine ventilation is a natural air current which automatically replaces the mine air without human intervention. Natural ventilation is possible when a mine has at least two openings located at different topographic elevations. In special cases, natural ventilation can also temporarily occur in deep mines with two shaft or roadway openings of the same elevation. Natural ventilation results primarily from differences in temperature (and therefore air density), and secondarily from variations in humidity and air pressure, between the inside and outside air. Whereas in summer the air current normally flows in from the opening at the higher elevation through the mine to the lower opening, this flow pattern reverses direction in the winter months (see Fig. 3.2). The air current in deeper mines is stronger in winter than in summer.**

**The Huayrachina is suitable for blowing (forced) as well as exhaust ventilation.**

**Materials for constructing the wall are taken from the gob, which minimizes the transport distances required for the stones used to build the huayrachina and simultaneously reduces the volume of gob.**

**A disadvantage of this bricked brattice ventilation system is the inhomogeneity of cross-sectional areas and rough inner surfaces of the huayrachina, resulting in high friction losses. In order to mechanize the ventilation, larger-capacity blower fans are therefore necessary.**

**A similar method of ventilation was applied already in the old Japanese gold mine of Sado, where two parallel drifts at an interval of approx. 0.5 m served to ventilate the mine.**



## **SUITABILITY FOR SMALL-SCALE MINING:**

**Given the prerequisite of low labor costs, this method is appropriate even today, particularly for small-scale mining operations In Latin America. The ability to ventilate with exhaust fans, together with the almost unlimited lifespan and minimal cost of materials, fulfill the requirements for small-scale mining application.**

### **3.2 Small blowers, manual fans**

#### **Deep Mining General Underground Mining Ventilation**

germ.: Kleine Wetterlifter, Wetterrad, Facher, Facherceblase, Centrifugalgeblase, Windtrumel, Focher

span.: pequeno ventilador manual, rueda pare ventilacion, abanico, fuelle abanico, fuelle centrifungal, ventilador manual

<b><u>TECHNICAL DATA:</u></b>	
Dimensions:	approx. 0.5 × 0.5 × 0.5 m
Weight:	approx. 20 kg
Extent of Mechanization:	not mechanized or mechanized
Power Generated:	80 W or more
Form of Driving Energy:	manual, pedal or with a small electric, pneumatic or internal-combustion engine

Mode of Operation:	continuous
<b>ECONOMIC DATA:</b>	
Investment Costs:	probably around 500 DM (estimated value) when locally manufactured
Operating Costs:	labor costs only
Related Costs:	ducts, huayrachina, etc.

### **CONDITIONS OF APPLICATION:**

Operating Expenditure:		low  ----- -----  high
Maintenance Expenditure:	lubrication	low  ----- -----  high
Location Requirements:	independent of location	
Mining Method Requirements:	due to the relatively small air-flow volume, should not be employed where larger open excavation chambers exist to ensure a complete air exchange.	
Replaces other Equipment:	Other mechanized types of ventilation blower-fans For mining activities.	
Regional Distribution:	Earlier, generally widely distributed, today used only seldom for auxiliary ventilation.	
Operating Experience:		very good  ----- -----  bad
Environmental		low  ----- -----  very high

Impact:  
Sustainability for

Local

very good |----|-----| bad

Production:

Under What Conditions: qualified metal workshops where the fan-rotors, gears, etc. can be manufactured.

Lifespan:

very long |----|-----| very short

**Bibliography, Source: Delius, Schauroth, DBM, v. Hauer, v. Humbolt**

### **OPERATING PRINCIPLE:**

**Different types of centrifugal and axial-flow fans which circulate and displace the air by means of rotating blades. In centrifugal fans, air is drawn in near the blades' center of rotation where it is rotated, compressed and finally expelled outward due to inertia. With axial-flow fans, the air is tangentially accelerated by the rotating fan blades in an axial direction due to the generation of a pressure differential (higher pressure on the inner side of the blades where expelled air is compressed, and lower pressure at the suction side of the blades where the expelled air creates a vacuum).**

### **AREAS OF APPLICATION:**

**Complete ventilation of mines.  
Auxiliary ventilation.**

### **REMARKS:**

**Manual fans are available from Delius (radial air compressor).**

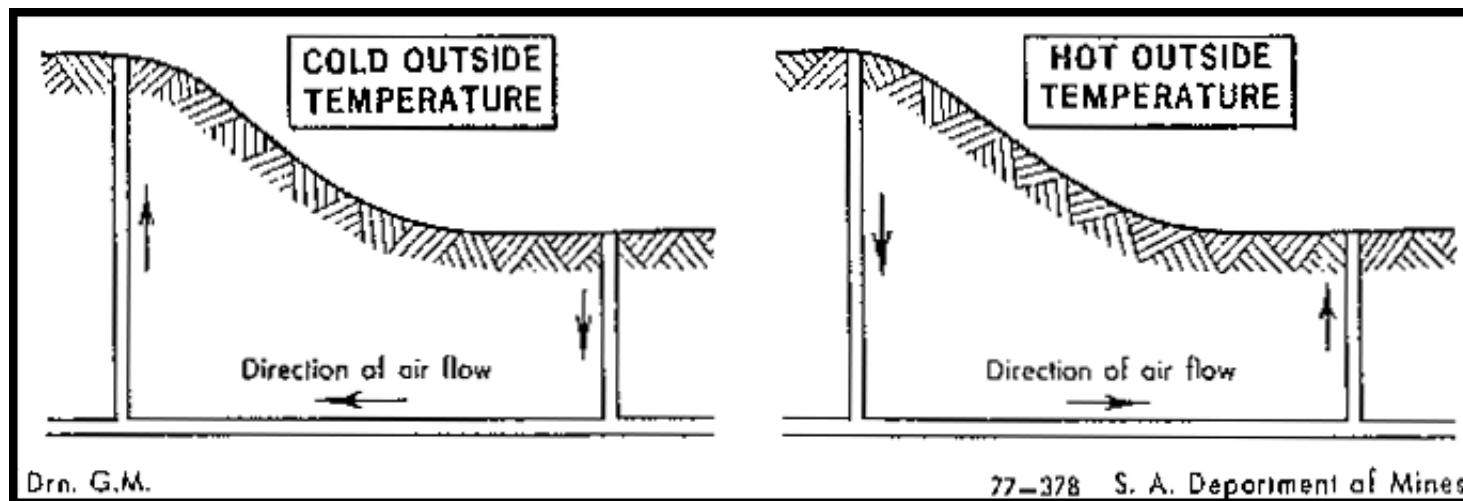
**Manual fans were industrially produced in Germany until the beginning of this century (Pelzer, Wulf, Mortier) and were driven by means of cranks and gears up to velocities of 650 rpm.**

### **SUGGESTIONS FOR DESIGN:**

**To serve as a gear drive, spur gears were placed at the rotor periphery. For pedal-driven fans, a chain-coupling would suffice, such as a bicycle chain.**

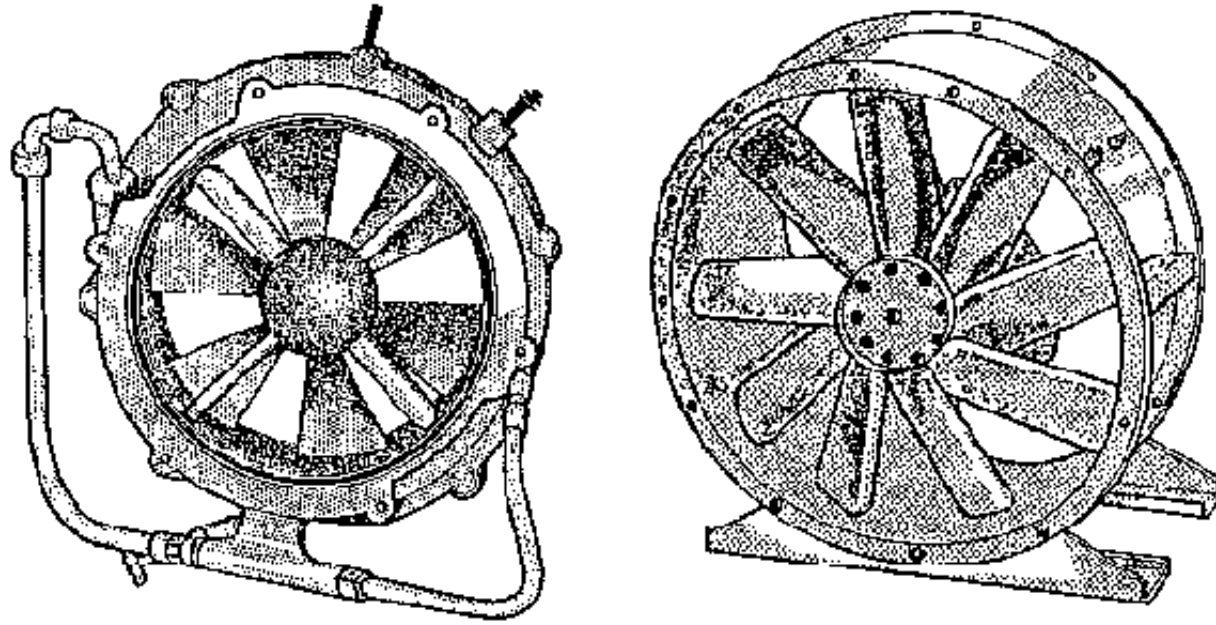
### **SUITABILITY FOR SMALL-SCALE MINING:**

**For small-scale and minimally-mechanized operations, a manual or pedal-driven fan which is manufactured locally offers the possibility to ventilate artificially at low investment cost and without external energy input.**



**Fig.: Principle of natural ventilation (left, flow in winter; right, flow in summer).**

**Source: Armstrong.**



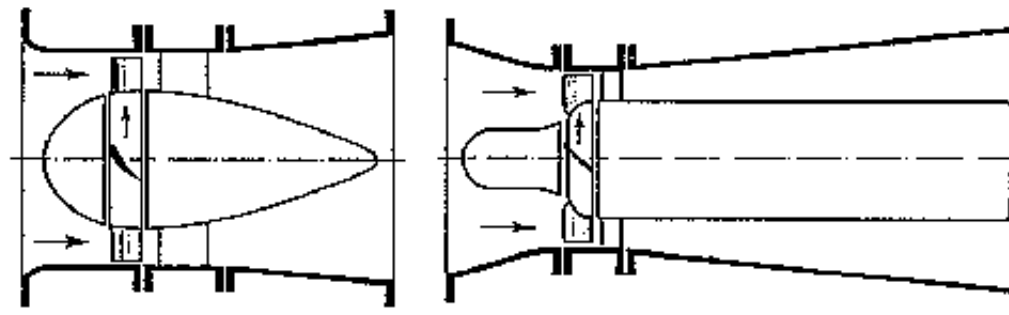
Drn GM

S13075 S.A. Department of Mines

Drn GM

S13050 S.A. Department of Mines

**Fig.: Small fans: left a pneumatic fan, right an electric fan. Source: Armstrong**



**Fig.: A comparison of different fan types (in cross-section); high-pressure fan (above), equal-pressure fan (below)**

### 3.3 Air-jet ventilator

## Deep Mining General Underground Mining Ventilation

engl.: injector fan, venturi fan, air driver, venturi blower

germ.: Luftstrahigeblase, Pneumatisches Strahlgeblase

span.: ventilador neumatico de inyeccion

Producer: Turmag

### **TECHNICAL DATA:**

Dimensions: diameter 200 mm, length 550 mm with 3 nozzles of 2-mm diameter

Extent of fully mechanized

Mechanization:

Form of Driving compressed air, pneumatic

Energy:

Mode of Operation: continuous

Output/Performance: air volume of 55 m<sup>3</sup>/min; fan type Altenkamp (1921) delivered 256.9 m<sup>3</sup>/min, intake fan: 0.667 m<sup>3</sup>/min

Technical Efficiency: somewhat less than that of pneumatic turbofans

Operating Materials:

Type: compressed air to 4 bar

Quantity: 1.6 m<sup>3</sup>/min

### **ECONOMIC DATA:**

Investment Costs: If locally made, estimated to be as low as 400 DM; for Turmag fan, 618 DM + sales tax

Operating Costs: costs to compress air

Operating Costs. costs to compress air

Related Costs: costs of ducts

## CONDITIONS OF APPLICATION:

Operating Expenditure: low |----|-----| high

Maintenance Expenditure: low |----|-----| high

Location independent of location

Requirements:

Mining-

Method Requirements: Due to the relatively small pressure gradient between the intake and exhaust sides of the fan, the length of the ducts is limited (maximum of 100 m for a 200 - 300 mm duct) therefore, the mining procedure must be so designed as to ensure that a fresh-air intake is within close proximity of the area to be ventilated.

Replaces other

Equipment: other ventilators, manual as well as mechanized fans

Regional low

Distribution:

Operating Experience: very good |----|-----| bad

Environmental

Impact: low |----|-----| very high

Suitability for  
Local

very good |----|-----| bad

Production:

Under What requires qualified metal and welding workshops

Conditions:

Lifespan:

very long |----|-----| very short

**Bibliography, Source: DBM, manufacturer's information, Stout, Armstrong**

### **OPERATING PRINCIPLE**

**Compressed air is blown through one or more small nozzles (2 - 3 mm or larger) into an expansion chamber of the air driver. As the compressed air expands it draws additional air into the chamber, which has the form of a laval turbine. The ratio between compressed air and the quantity of air drawn in can reach 1 : 35.**

### **AREAS OF APPLICATION:**

**Ventilation and auxiliary ventilation of mines, working faces or roadways with relatively short duct lengths.**

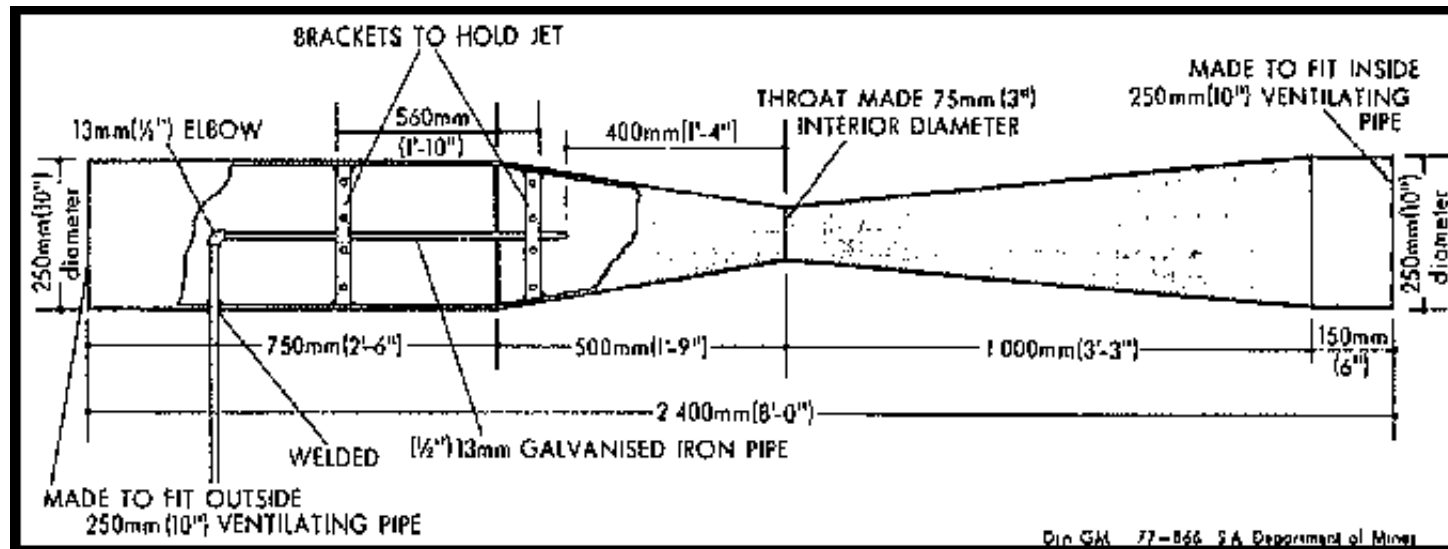
### **REMARKS:**

**Air-drivers or infector fans are stable and have a long lifespan as a result of their simple design, which involves no driven moving parts. Therefore maintenance is minimal and potential repair work is simple.**



## SUITABILITY FOR SMALL-SCALE MINING:

For pneumatically-mechanized mining operations with small workings, locally-made air-drivers are superior to other pneumatic ventilators due to their stable design and maintenance-free operation.



**Fig.: Design of an Air-driver. Source: Armstrong**

### 3.4 Hydro-compressor

#### Deep Mining General Underground Mining Ventilation

germ.: Wassertrommel, Hydrokompressor, Althaus'Geblase

span.: toner de agua compresor, hidrocompresor fuelle de Althaus

#### TECHNICAL DATA:

Dimensions:	approx. 3 m × 1 m × 1 m (HWL)
Weight:	approx. 100 kg
Extent of Mechanization:	not mechanized
Form of Driving Energy:	hydromechanic
Mode of Operation:	continuous
Throughput/Performance:	small capacities
Technical Efficiency:	substantially higher than other compressors, 8 - 15 % for a simple hydro-compressor
Operating Materials:	
Type:	water
Quantity:	relatively high
<b>ECONOMIC DATA:</b>	
Investment Costs:	highly dependent on air pressure (higher pressure requires longer pipelines and better quality)
Operating Costs:	none
Related Costs:	for operation of compressor very high

## **CONDITIONS OF APPLICATION**

Operating Expenditure: low |----|-----| high  
Maintenance Expenditure: low |----|-----| high  
Operator Experience: little  
Location Requirements: requires water and a sufficient elevation difference

Mining Requirements:	A shaft is a prerequisite for the use of hydro-compressors.
Replaces other Equipment:	fan, small compressors
Regional Distribution:	No longer in use today; distributed throughout Central Europe earlier.
Operating Experience:	very good  — — — —  bad
Environmental Impact:	low  — — — —  very high
Suitability for Local Production:	very good  — — — —  bad
Under What Conditions:	carpenter shop for fans, qualified metal workshop for compressors and fans
Lifespan:	very long  — — — —  very short

**Bibliography, Source: Calvor, v. Bernewitz, Slotta in Eckholdt, Delius, Kircher, v. Hauer, Cancrinus, Wagner**

### **OPERATING PRINCIPLE:**

**The water falls into a closed barrel where it strikes a reflecting plate, separating it from the air which has been drawn along with the water; this air is then directed through a duct to the working face.**

**The air-collection system can be designed using a water-jet pump (injector pump) of tubular construction (Bernewitz).**

### **AREAS OF APPLICATION:**

## **Blowing (forced) ventilation of smaller mines.**

**As a small compressor for revolution of slurries, reagents etc. according to the air-lift pump principle.**

### **SPECIAL AREAS OF APPLICATION:**

**As a compressor to produce compressed air for driving pneumatic motors.**

### **REMARKS:**

**Hydro-compressors were in operation until the early 1980s in the Harz Mountains mining region in Germany, whereby the output capacity of around 11 m<sup>3</sup>/min or 16.3 m<sup>3</sup>/min was somewhat low. The air pressure sufficed, however, for pneumatic drive units.**

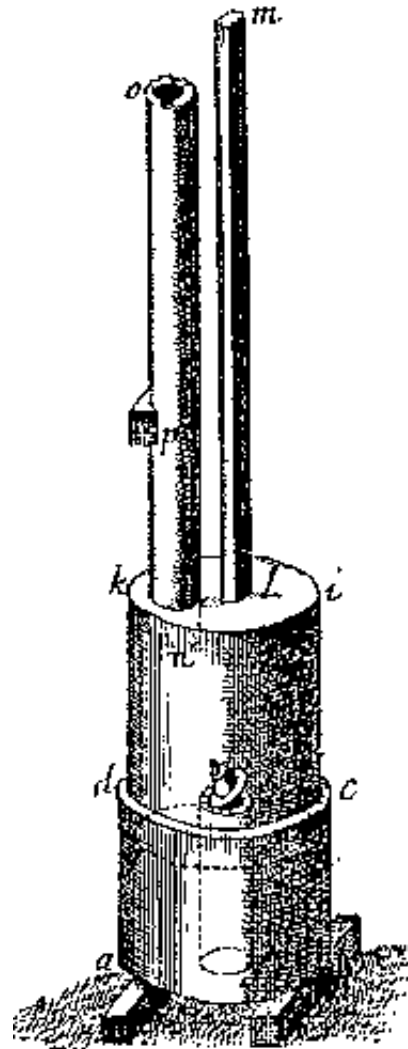
**When used to generate compressed air, the separating of the air must occur under pressure, which is created by means of a standpipe for the expelled water. The height of the standpipe determines the pressurization of the compressed air.**

### **SUITABILITY FOR SMALL-SCALE MINING:**

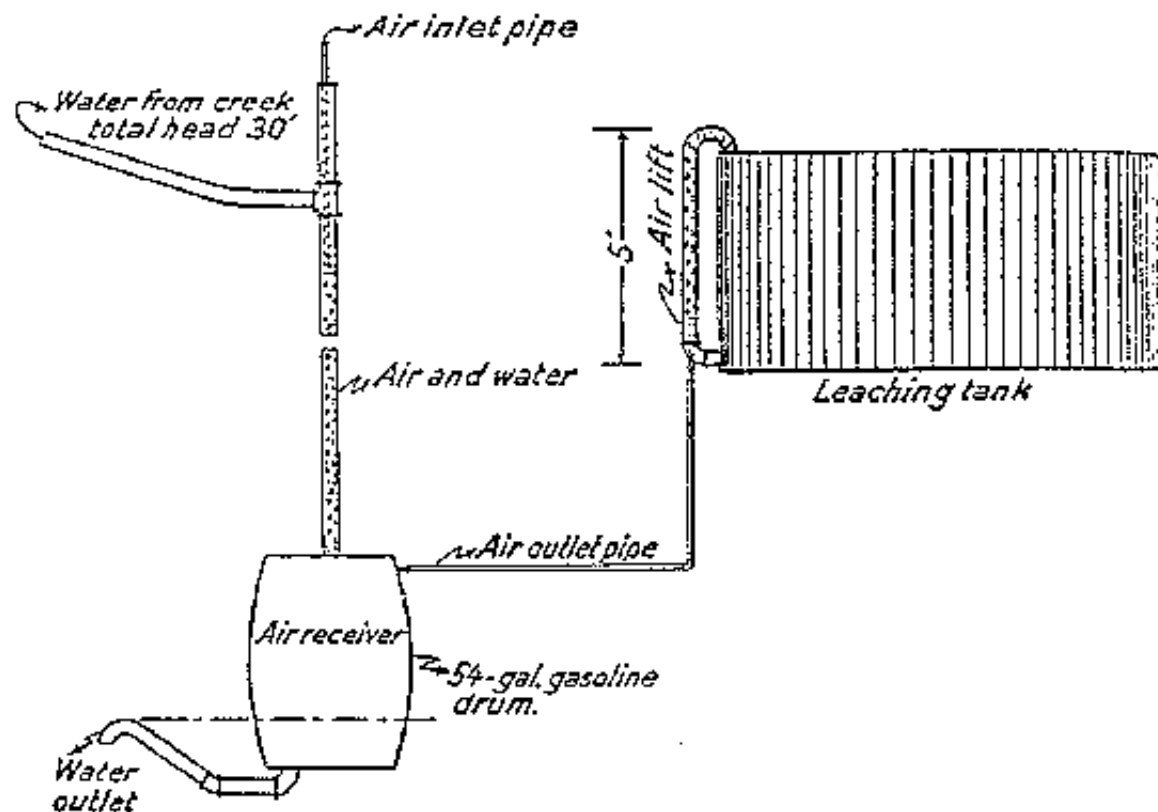
**The hydro-compressor for ventilation is a simple, stable apparatus without moving parts; it is locally available and suitable for small-scale mining. Prerequisites for its use, without exception, are the presence of water and an elevation gradient.**

**Its use as a compressor to produce compressed air appears less suitable due to the high construction costs. In situations where conditions permit the construction of a hydro-compressor (water, sufficient elevation gradient), a**

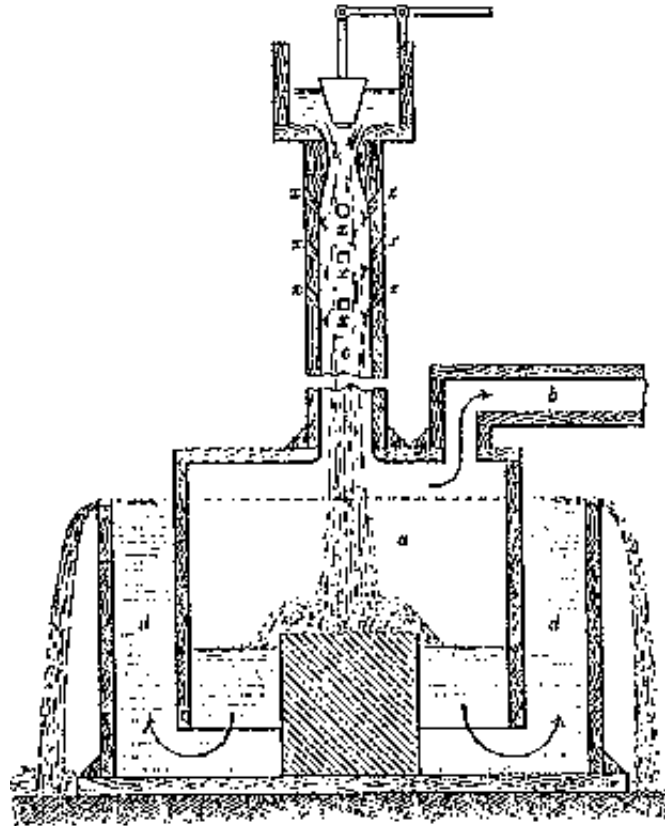
**turbine-driven conventional compressor is probably more economical than a hydro-compressor for generating compressed air.**



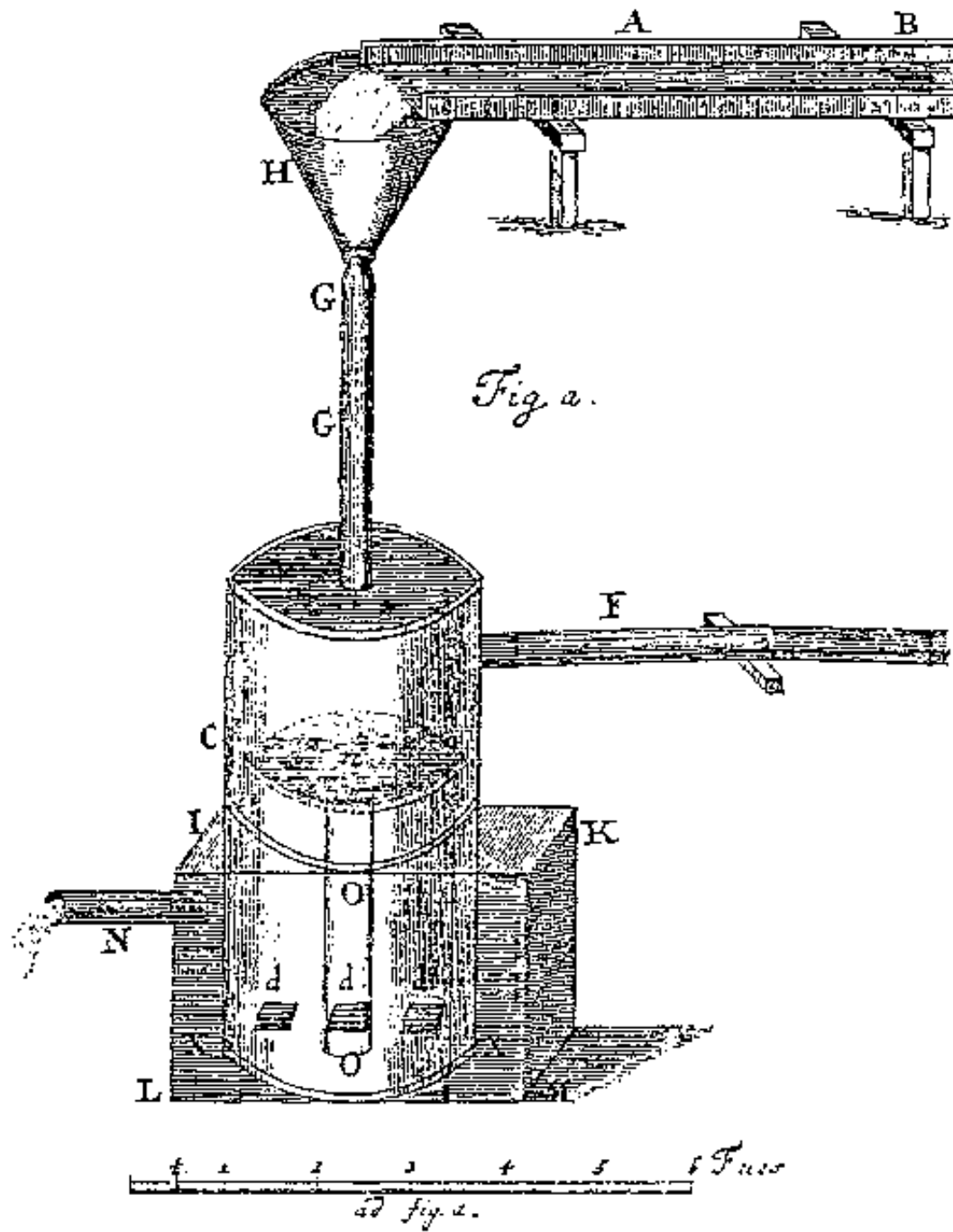
**Fig.: Waterdrum for ventilation purposes, by Cancrinus**



**Fig.: A Small hydro-compressor for operating a circulating pump according to the air-lift-pump principle for circulation of agitation-leaching solution. Source: Bernewitz**



**Fig.: Working principle of a waterdrum for ventilation purposes, by Wabner**





## Fig.: A waterdrum for ventilation purpose. Source: Calvr

### 3.5 Ventilation oven

#### Deep Mining General Underground Mining Ventilation

engl.: furnace ventilation

germ.: Bewetterungsofen, Bartels Feuermaschine, Wetterofen

span.: horno de ventilacion

<b><u>TECHNICAL DATA:</u></b>	
Dimensions:	large oven-house or furnace with a chimney several meters high, or preferably underground oven in a by-pass with approx. 4 m hearth area
Extent of Mechanization:	not mechanized
Form of Driving Energy:	wood or coal-fired
Alternative Forms of Energy:	gas, oil
Mode of Operation:	semi-continual

Technical Efficiency:	20 - 80 % (in English mines)
Operating Materials:	
Type:	wood or coal
Quantity:	large, 30 - 50 k9/PSuseable × h
<b><u>ECONOMIC DATA:</u></b>	
Investment Costs:	high
Operating Costs:	high, due to high fuel costs
Related Costs:	intake ducts, huayrachinas when only one opening exists

### **CONDITIONS OF APPLICATION:**

Operating Expenditure:  
Maintenance Expenditure:

low |-----|-----| high

low |----|-----| high

Location Requirements:

wood or coal fuel must be available in sufficient quantities

Deposit Requirements: only suitable for small excavation areas due to the small intake capacity

**Mining Requirements:** the mining procedure must be so designed that only small excavation chambers are created

Replaces other

**Equipment:** fans

**Regional Distribution:** historically used in Europe

**Operator Experience:** very good |—|—|—|—| bad

**Environmental Impact:** low |—|—|—|—| very high

**Suitability for Local Production:** very good |—|—|—|—| bad

**Under What Conditions:** adobe construction, metal hearth-grates

**Lifespan:** very long |—|—|—|—| very short

**Bibliography, Source: Henning Calvor, Delius, A. v. Humboldt, Schauroth, Wagner**

### **OPERATING PRINCIPLE:**

**The fire in the oven heats the air which then escapes through the chimney, drawing mine-air along with it; ducts direct the mine-air into the oven. Based on convection principle.**

### **AREAS OF APPLICATION:**

**Exhaust ventilation of small mines where sufficient coal or wood is available. Also suitable as supplementary support for natural ventilation.**

**REMARKS:**

**It remains to be investigated if the effects of convective flow could be achieved through the use of solar energy (e.g. air collectors).**

**Ventilation ovens of this type are suitable for non-coal mining only in regions of abundant vegetation; unsuitable for regions of higher elevation with low vegetation density.**

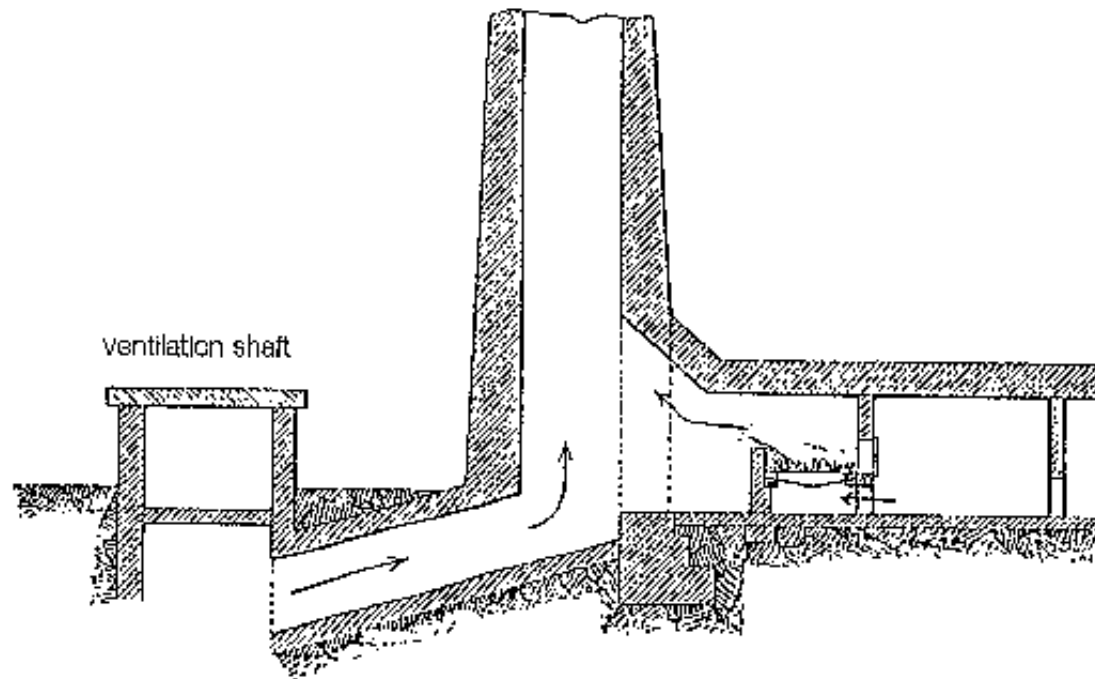
**Use of ventilation ovens is appropriate especially in coal mining, where even products of poor market quality (for example, coal with high ash contents or poor carbonization, etc.) can be employed for firing the ventilation ovens.**

**Ventilation ovens have not only been constructed on the surface, but also underground, where the entire shaft served as a chimney, making this type of ventilation significantly more effective. The ventilation oven was in this case installed in a by-pass in a slightly-ascending roadway, whereby the correct quantity of air needed for combustion was regulated by ventilation doors and gates. The heat loss from the ovens is predominantly dependent on the humidity of mining air, leading to fluctuations in the efficiency between 80% in dry ventilation shafts to 20% in wet shafts.**

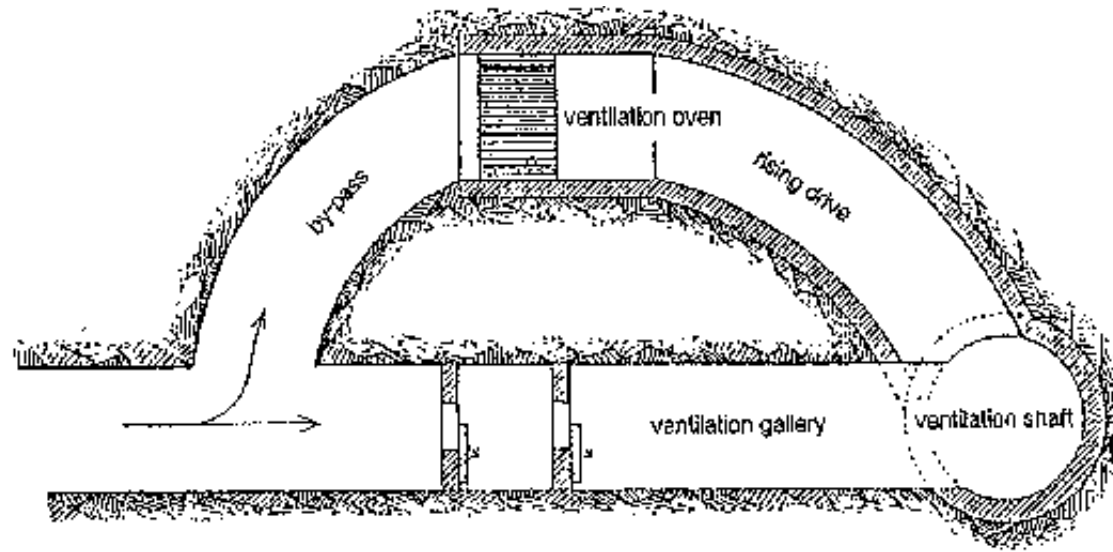
**An alternative method was also investigated in which the heat generated by coal combustion was used to heat water and convert it to steam, which then flowed under high pressure into an injector fan (jet-stream fan by Korting), drawing mine air along with it. The effect of this arrangement was however only minimal (efficiency only 2 % that of the ventilation oven).**

## SUITABILITY FOR SMALL-SCALE MINING:

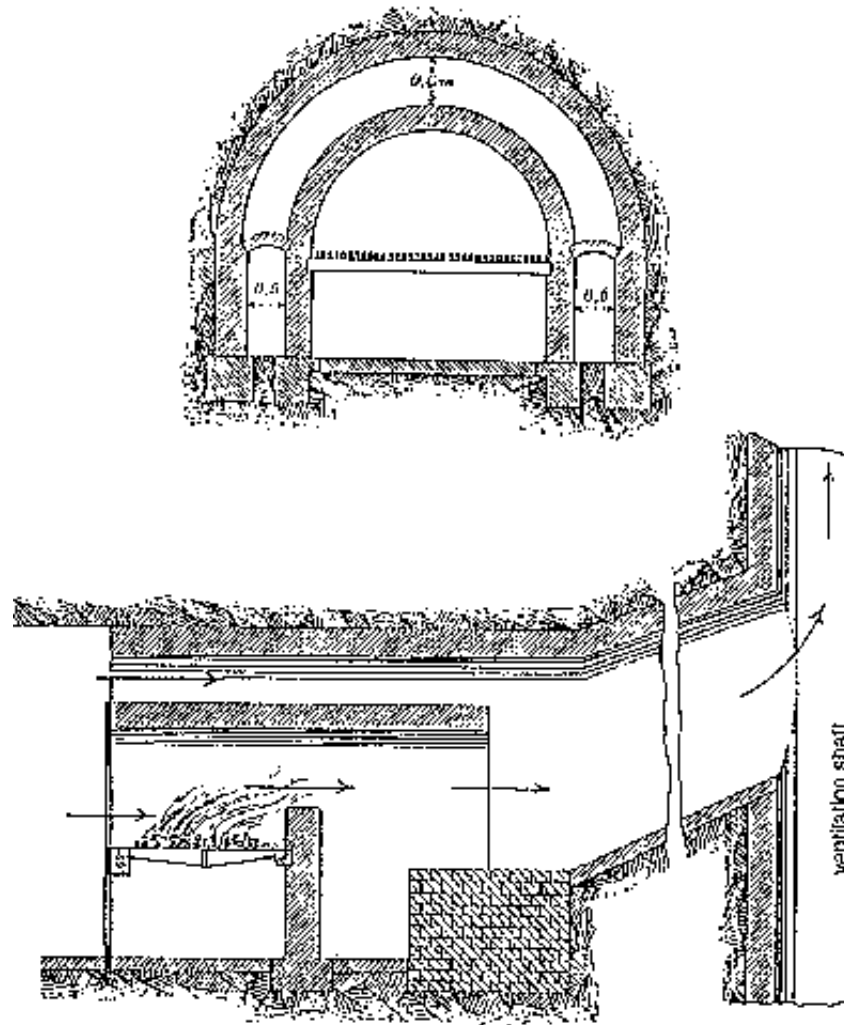
**Ventilation ovens are not recommended for small-scale mining because of their detrimental impact on vegetation. In isolated cases, the use of ventilation ovens in coal mines may be appropriate, however the associated risk of mine fires must be taken into consideration.**



**Fig.: Above-ground ventilation oven, by Wabner**

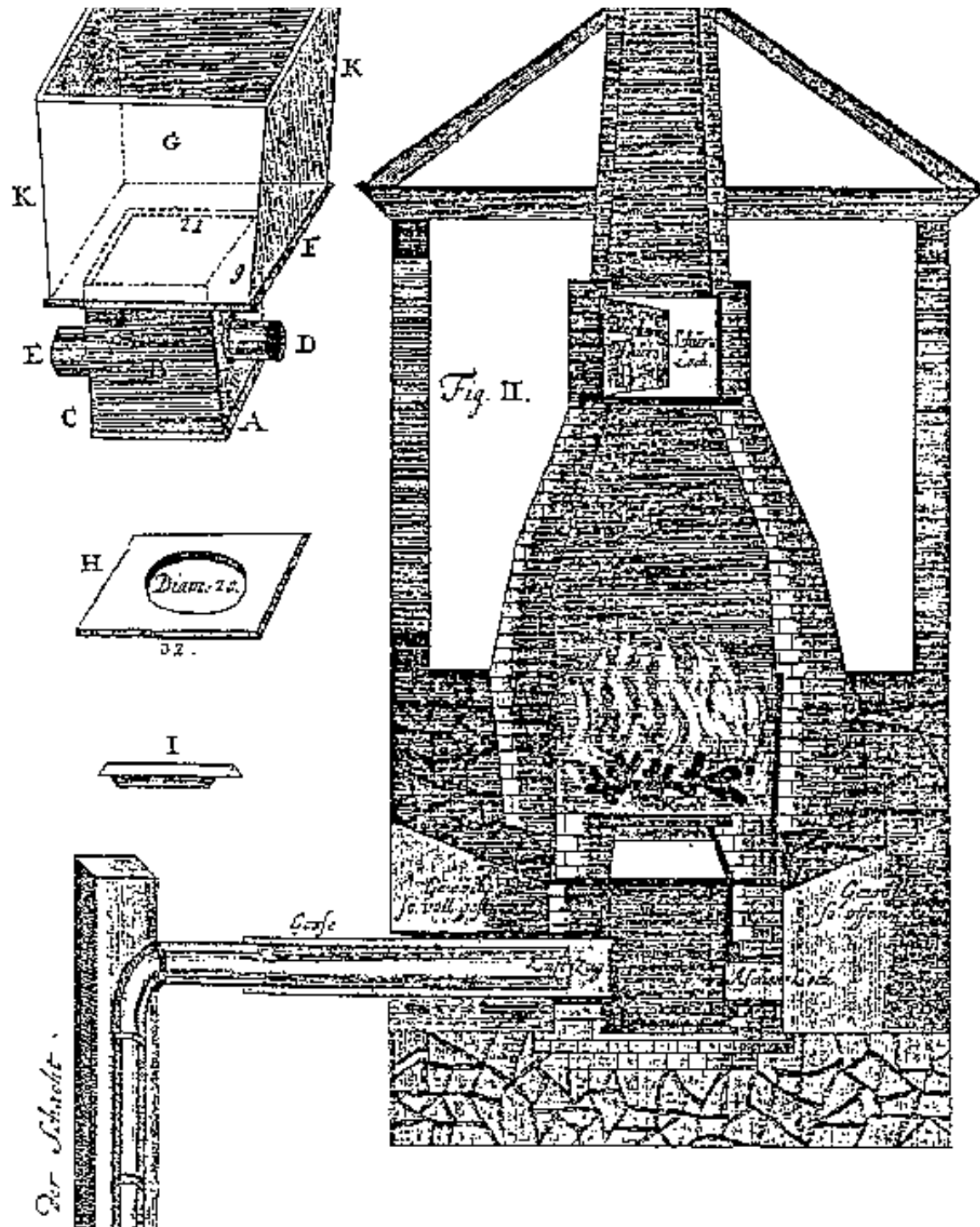


**Fig.: Installation of underground ventilation oven in by-pass roadway, by Wabner**

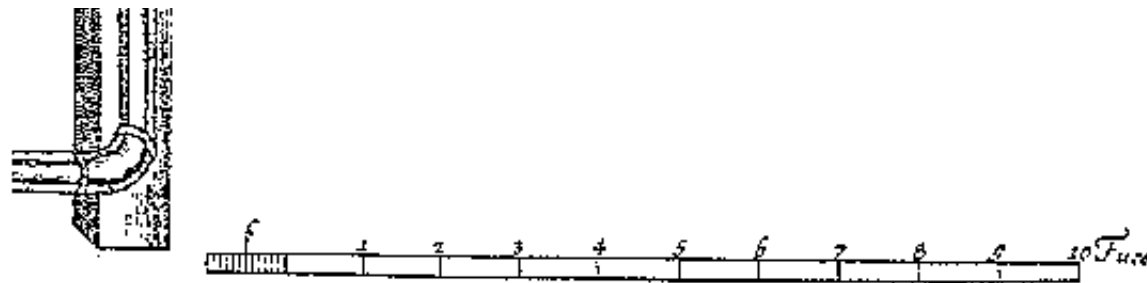


**Fig.: Elevation and section of ventilation oven constructed underground. Source: Wabner**









**Fig.: Ventilation oven or Bartel's Fire Machine. Source: Calvr**

### 3.6 Wind sail

#### Deep Mining General Underground Mining Ventilation

germ.: Bewetterungssegel, Windsegel, Machina Anemica, Windfang, Wetterhut  
span.: vela de ventilacion, vela de viento, machine anemica, cortaviento

#### **TECHNICAL DATA:**

Dimensions: up to several m in diameter  
 Weight: 10 - 50 kg  
 Extent of Mechanization: not mechanized  
 Form of Driving Energy: wind  
 Mode of Operation: intermittent  
 Throughput/Performance: depends on resistance of the duct/huayrachina  
 Technical Efficiency: high

#### **ECONOMIC DATA:**

Investment Costs: very low

**INVESTMENT COSTS:**

very low

Operating Costs:

none

Related Costs:

an alternative ventilation system may be necessary; ducts or huayrachina must be installed

**CONDITIONS OF APPLICATION:**

Operating

low |-----|-----| high

Expenditure:

Maintenance

low |-----|-----| high

Expenditure:

Location

locations of mine or shaft openings must be characterized by sufficiently strong daily and seasonal winds

Requirements:

Mining

mine has to be designed for blowing (forced) ventilation

Requirements:

Replaces other

mechanized types of fans, natural ventilation

Equipment:

Regional

Australia

Distribution:

Operating

very good |-----|-----| bad

Experience:

Environmental

low |-----|-----| very high

Impact:

Suitability for

very good |-----|-----| bad

Local Production:

Under What

carpentry and/or other workshops where the manufacture of textile

Conditions:

sails and wooden or metal frames can be combined

Lifespan:

very long |—|—|—|—| very short

given that the construction is storm-resistant

**Bibliography, Source: Armstrong, Kircher, A. v. Humboldt, Loehneyss, Schauroth, Wagner**

### **OPERATING PRINCIPLE:**

**A funnel-shaped extension of the duct is oriented with its opening toward the wind. The creation of a pressure head causes air to flow into the duct. The windsail is constructed of wind-permeable materials such as sail cloth, coated cotton or linen, or fiber-reinforced synthetic material. The wooden or metallic frame keeps the funnel open.**

### **MODES OF OPERATION:**

**Ventilation of small mines where ducts or huayrachinas are present.**

### **REMARKS:**

**During periods of insufficient winds, non-wind-dependent auxiliary ventilation equipment must be available.**

**Kircher describes a Machina Anemica, which is a wooden wind sail automatically aligned by use of a tail fin.**

**Schauroth indicates that combination blowing and exhaust ventilation sails have**

**already been constructed, the simplest being at the opening of the shaft or drift, whereby the doors and gates were opened on the windward side for exhaust ventilation and on the leeward side for blowing ventilation.**

**Windsails are historically the oldest form of artificial mine ventilation.**

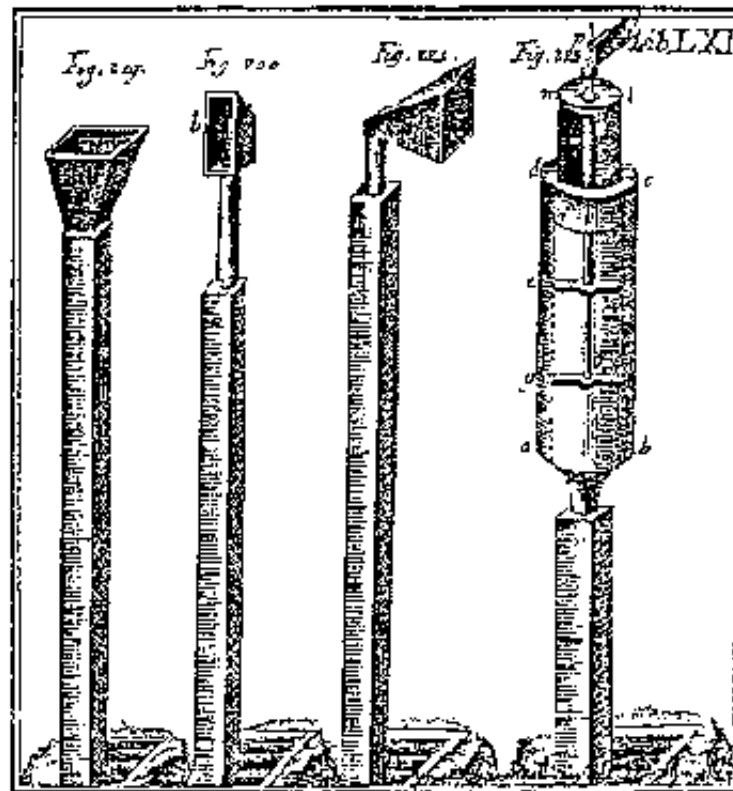
**Windsails of textile-construction, such as those currently used in small-scale mines in Australia, are preferable to those of wooden construction.**

**Aside from the mechanics for turning the opening toward the wind direction, windsails do not have moving parts and are therefore of sturdy construction. They should be designed to accommodate the strongest occurring winds.**

**In downcast ventilating shafts in dry locations, ventilation can be enhanced by cooling the intake air with a fine water mist which is sprayed into the shaft. The evaporation effect cools the air flow; the higher the air temperature and the lower the relative humidity, the stronger the cooling effect.**

### **SUITABILITY FOR SMALL-SCALE MINING:**

**The use of wind sails in Latin American small-scale mines is only practical where sufficient winds occur on a regular daily or seasonal basis near the shaft or mine entrances.**



**Fig.: Types of historical windsails applied primarily for bowing ventilation.**

### 3.7 Box blower

## Deep Mining General Underground Mining Ventilation

germ.: Kastengeblase

span.: soplador de cajon

<b>TECHNICAL DATA:</b>	
Dimensions:	e.g. 3 square pistons, 1 × 1 m surface area; box: 4 × 1.2 × 5 m

	LWH
Weight:	approx. 1,000 kg
Extent of Mechanization:	partly mechanized
Power:	starting at approx. 0.5 kW
Form of Driving Energy:	waterwheel (as for the box Freiberg) blower of above-mentioned dimensions in
Alternative Forms:	other slow-moving driving mechanisms
Mode of Operation:	semicontinual
Technical Efficiency	420 m <sup>3</sup> /h air volume with 450 mm water column pressure
Operating Materials:	
Type:	lubricant
Quantity:	small quantities
<b><u>ECONOMIC DATA:</u></b>	
Investment Costs:	approx. 2,000 DM
Operating Costs:	depends on drive-system, however generally very low
Related Costs:	drive-system, air channel system (ducts, etc.)

### **CONDITIONS OF APPLICATION:**

Operating  
Expenditure:

low |-----|-----| high

Maintenance

low |-----|-----| high

Maintenance

Expenditure:

Replaces other all other blower systems for auxiliary ventilation

Equipment:

Regional to date not distributed in the Latin American small-scale mining industry

Distribution:

Operating

very good |-----|-----| bad

Experience:

Environmental

low |-----|-----| very high

Impact:

Suitability for

very good |-----|-----| bad

Local

Production:

Under What as traditional wooden system, possibly also produceable as plastic,  
 Conditions: fiberglass-reinforced resin, etc; valves of leather and felt for sealing,  
 possibly also of rubber.

Lifespan:

very long |-----|-----| very short

**Bibliography, Source: Wagenbreth, Grube Alte Elisabeth/Freiberg**

### **OPERATING PRINCIPLE:**

**Air contained in the compression chamber of the wooden box is compressed by tightly-fitting wooden pistons which work in two opposite directions. Each wooden box accordingly has an inlet and an outlet valve for each of the two compression chambers, which are separated by the piston in between. As the**

**piston travels in one direction, the air in front of it is compressed and driven out through a simple flap valve. When the piston has reached the end of the stroke and reverses direction, the flap valve closes gravitationally and the suction valve opens due to the pressure drop behind the piston, letting fresh air into the chamber. In the other chamber, now in front of the piston, the air is compressed and then driven out the respective flap-valve in that chamber. With each piston stroke and corresponding direction change, air is alternately compressed and expelled from the one chamber while fresh air is drawn into the other. A cross head Joint assures that the pistons travel parallel to their axis. As an alternative, Watts' parallelogram system can be used in conjunction with a beam.**

**Box blowers are generally constructed in an upright position where the driving-axle is vertical; all other constructions have experienced significantly higher friction losses and sealing problems.**

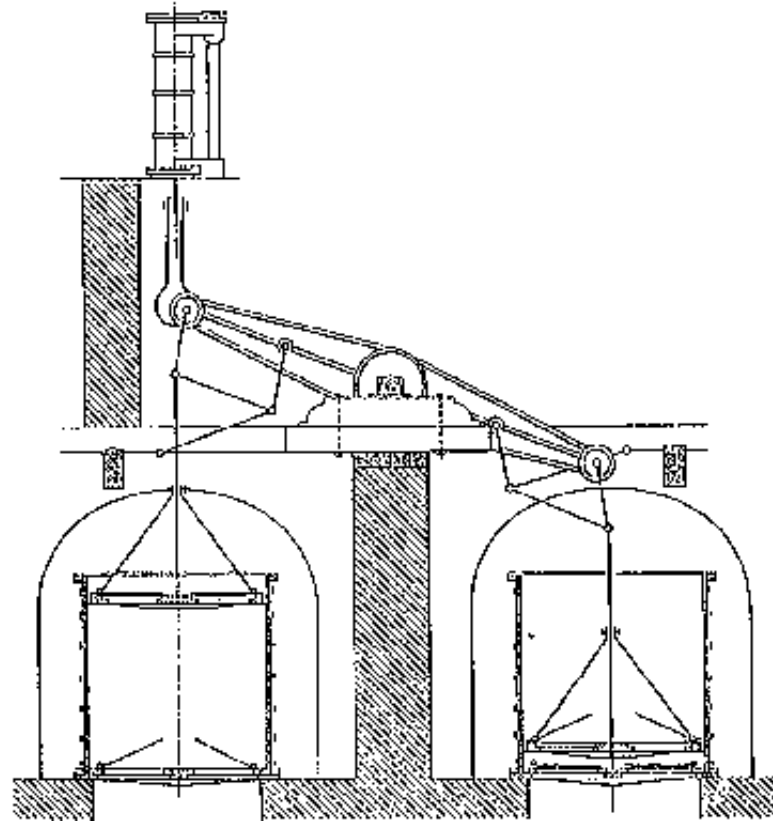
### **AREAS OF APPLICATION**

**Compressing of air for ventilation and forge furnaces**

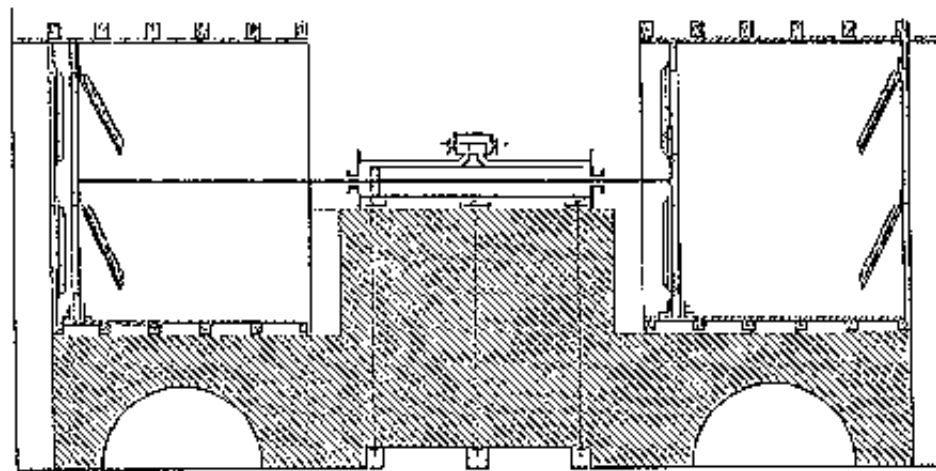
### **SUITABILITY FOR SMALL-SCALE MINING:**

**Box blowers are suitable for ventilation of small mines where waterwheels or slow moving drive-systems exist.**





**Fig.: Box blower for ventilation, driven by a steam engine with balancing beam and Watt's Parallelogram construction, by Wabner**



**Fig.: Horizontal box blower, by Wabner**

### 3.8 Bell blower baaders blower

#### Deep Mining General Underground Mining Ventilation

germ.: Glockengeblase, Harzer Wettersatz, Baader'sches Geblase

span.: soplador de campana, equipo pare ventilacion del Harz, soplador de Baader

<b>TECHNICAL DATA:</b>	
Dimensions of one blower unit:	approx. 1 m in dia., 2 - 3 m in height
Driving Output:	100 W or more
Extent of Mechanization:	not or semi-mechanized
Form of Driving Energy:	manual or hydromechanic
Alternative Forms:	pedal drive, animal-powered gear

Mode of Operation:	intermittent
Throughput/Performance:	per stroke approx. 2 m <sup>3</sup> air, frequency approx. 6 strokes/min
Technical Efficiency:	very high, due to low frictional losses
<b><u>ECONOMIC DATA:</u></b>	
Investment Costs:	very low, < 550 DM
Operating Costs:	dependent upon extent of mechanization
Related Costs:	duct, conduit or huayrachina nessesary

### **CONDITIONS OF APPLICATION:**

Operating Expenditure:	low  -----  high depending upon extent of mechanization
Maintenance Expenditure:	low  ----- -----  high
Personnel Requirements:	low
Location Requirements:	none
Replaces other Equipment:	natural ventilation, blower
Regional Distribution:	historical only (Harz, Germany)
Operating Experience:	very good  ----- -----  bad
Environmental Impact:	low  ----- -----  very high
Suitability for Local Production:	very good  ----- -----  bad

Under What Conditions: simple metal or wood manufacturers, leather or rubber

Lifespan: valves very long |-----|-----| very short

**Bibliography, Source: German Museum, Slotta in Eckhlodt, A. v. Humboldt, v. Hauer, Schauroth, Wagner, Treptow**

### **OPERATING PRINCIPLE:**

**A small, bottomless bell-shaped or cylindrical container is continually moved up and down in a water bath within a larger open-topped container. This causes a constant increase or decrease of air space volume in the upper portion of the inside vessel, like a bellows. A pipe connecting the ventilation duct to the head of the inner container is equipped with valves to direct the air flow.**

### **AREAS OF APPLICATION:**

**Ventilation and auxiliary ventilation in small mines and drifts.**

### **REMARKS:**

**In the 18th century in the Harz mining region in Germany, drifts up to 3 km in length were ventilated with Baaders blowers (invented by Josef Baader, 1789). At that time, wooden ventilation ducts (hollowed out logs) were used which were connected and sealed with metal rings.**

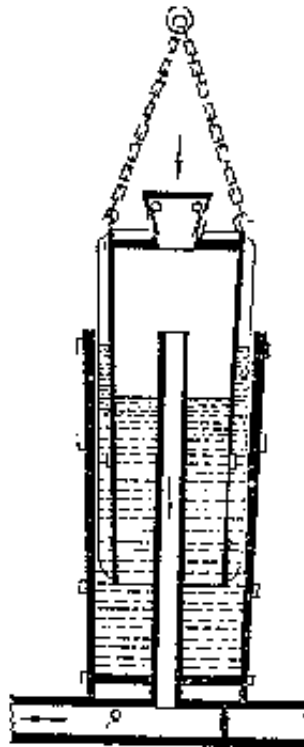
**Depending on the valve type, exhaust or blowing (forced) ventilation is possible. The simultaneous operation of two Baader's blowers counterposed on a tilting beam can produce a continual air flow. Compared to all other designs of bellows,**

**box blowers, etc., Baader's blower is distinguished by its very low friction losses and high performance efficiency.**

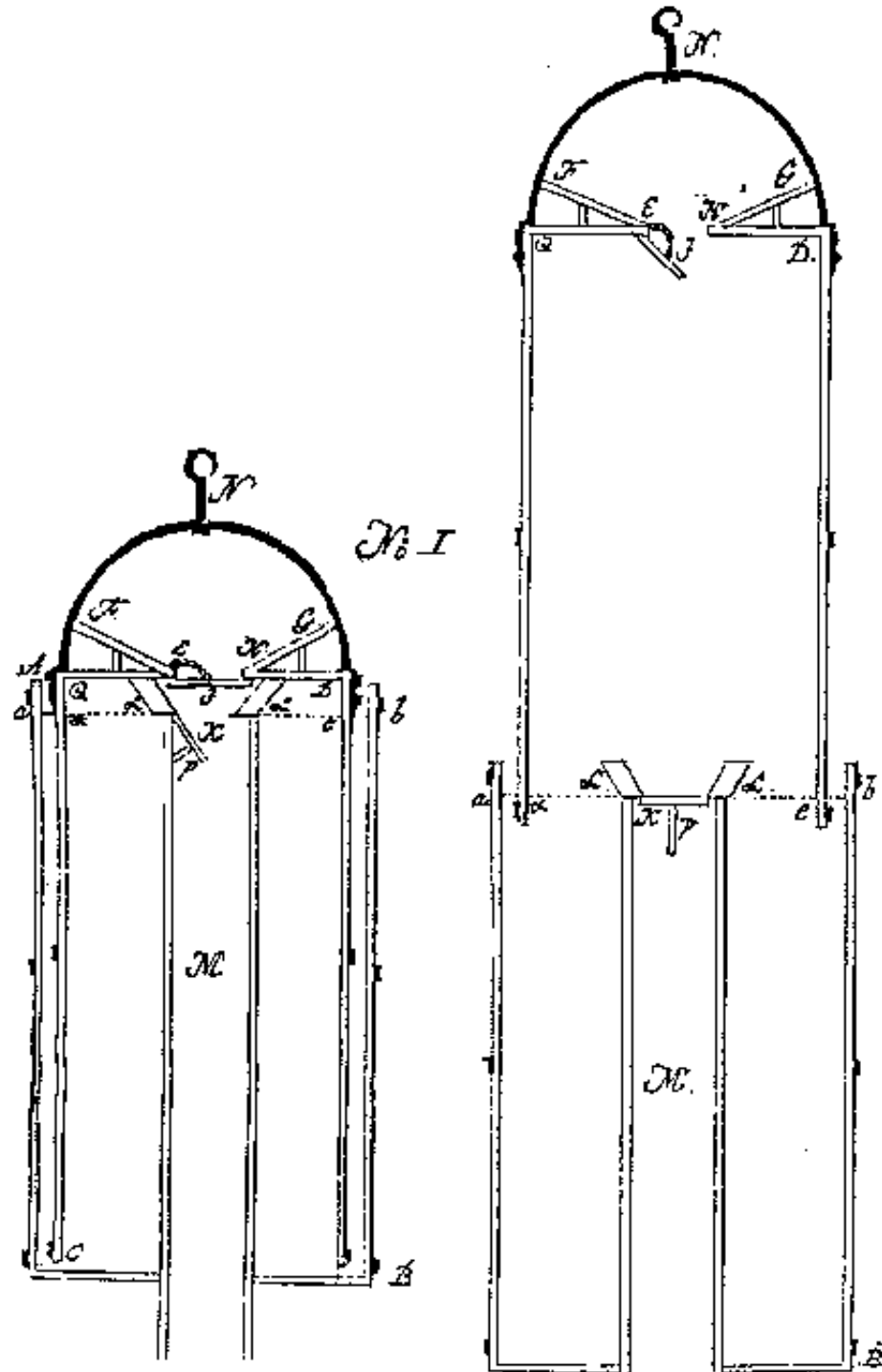
**It would be worth investigating to what extent Baader's blowers could be animal-powered.**

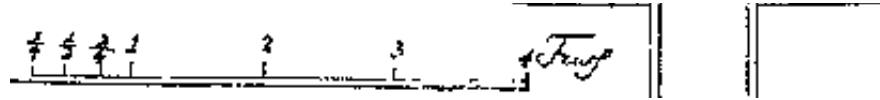
### **SUITABILITY FOR SMALL-SCALE MINING:**

**Low investment costs, a simple operating principle and its suitability for local production make Baaders blower appropriate as one of the simplest method for artificial ventilation. Slowly-moving drive systems are most suitable.**



**Fig.: Design section of a bell-shaped blower. Source: Slotta, in: Eckhold**

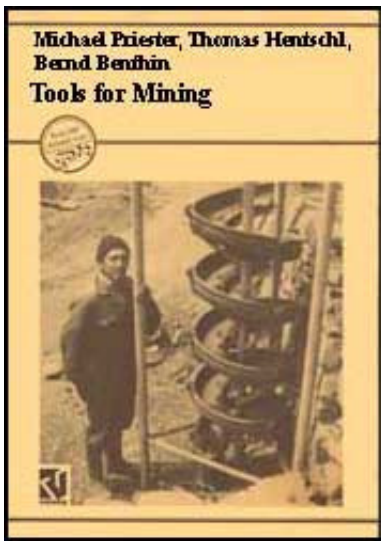










**Fig.: Schematic diagram of a Baader's blower (Harzer Wettersatz). Source: Lempe**



[Home](#) > [ar](#).[cn](#).[de](#).[en](#).[es](#).[fr](#).[id](#).[it](#).[ph](#).[po](#).[ru](#).[sw](#)



## **Tools for Mining: Techniques and Processes for Small Scale Mining (GTZ, 1993, 538 p.)**

- ➔  **Technical Chapter 4: Water supply and drainage**
  -  **4.1 Pneumatic positive-displacement pump**
  -  **4.2 Chinese liberation pump**
  -  **4.3 Water bag**
  -  **4.4 Bucket-chain conveyor**
  -  **4.5 Pneumatic high-pressure pump**

**Tools for Mining: Techniques and Processes for Small Scale Mining (GTZ, 1993, 538 p.)**

**Technical Chapter 4: Water supply and drainage**

**4.1 Pneumatic positive-displacement pump**

**Deep Mining General  
Underground Mining Mine Drainage**

engl.: floating pump

germ.: Druckluftgetriebene Verdrängungspumpe, Schwimmerpumpe

span.: bomba neumática de expulsión, bomba con flotador

<b><u>TECHNICAL DATA:</u></b>	
Dimensions:	volumes ranging from a few liters up to several 100 liters
Weight:	the total weight of the pump's displacement chamber should be greater than that of the volume in liters, so that the pump sinks down when it's empty
Extent of Mechanization:	semi-mechanized
Form of Driving Energy:	pneumatic
Mode of Operation:	intermittent
Technical Efficiency:	relatively low, due to the low efficiency of compressed air; furthermore, the intermittent operation results in a loss in the built-up air pressure relative to standard pressure
Operating Material:	
Type:	compressed air
Quantity:	$P = P_{\text{hydrostat}} + (0.5 - 1.0) \text{ bar}$



<b><u>ECONOMIC DATA:</u></b>	
Investment Costs:	very low, approx. 100 DM + pipe costs = f (height)
Operating Costs:	f (costs for compressed air)
Related Costs:	Compressed air system, compressor

### **CONDITIONS OF APPLICATION:**

Operating Expenditure:  
manually operated

low |-----|-----| high

Maintenance Expenditure:

low |-----|-----| high

Personnel Requirements: low

Location Requirements: theoretically, greater pumping depths are possible; in practice, the compressive strength of the material and the maximum compressed-air pressure limit the depth to 50 m.

Replaces other

Equipment: other types of pumps for mine drainage, and for pumping of processing and mill water in smaller volumes but over greater heights.

Regional new technology, so far not distributed

Distribution:  
Operating  
Experience:

low |-----|-----| very high

non-existent; only test operations performed in Landtechnik  
Weihestephan (Germany)

Environmental  
Impact:

low |-----|-----| very high

oil-contamination of water due to leaking oil from the compressed air  
system

Suitability for  
Local  
Production:

very good |-----|-----| bad

Under What  
Conditions:

metal workshop employing simple components, e.g. pipe sections, simple  
ball valves employing hard rubber balls.

Lifespan:

very long |-----|-----| very short

## **Bibliography, Source: Landtechnik Weihestephan, Fritzsche**

### **OPERATING PRINCIPLE:**

**The pump consists of a displacement chamber with two valves: an intake valve with protective sand filter and an outlet valve with an uptake on the delivery side of the pump. The intake and discharge are located at the bottom of the pump housing, where a standpipe serving as the outlet has proven to be best. The valves are designed as check-valves, e.g. as flap valves or ball valves. The latter for example, should be constructed with rubber balls of a density only slightly higher**

**than water allowing them to open at even the smallest pressure increase on the intake side. A compressed-air line, externally-controlled by means of a three-way cock, is connected to the pump chamber. Water from the mine sump flows through the intake valve into the pump chamber, when the pump chamber is full, the three-way cock is turned to allow compressed air to flow into the chamber. The intake valve closes and the outlet (discharge) valve starts to open, whereby the compressed air drives the water out through the standpipe, outlet valve and uptake pipe. After all the water has been discharged, the three-way cock is switched open, the air pressure drops, the outlet valve closes, the intake valve begins to open and water again flows into the pump chamber. The manual three-way-cock pump control can be automated by means of floats.**

### **ADVANTAGES:**

- + can be self-made or locally-produced using inexpensive material**
- + can be applied in narrow shafts, drill holes or pump sumps since the pump is suspended only by two flexible hoses, and perhaps additionally by a rope or cable**
- + less susceptible to break-downs since, except for the valves, there are no moving parts**
- + can be controlled manually in its simplest construction**

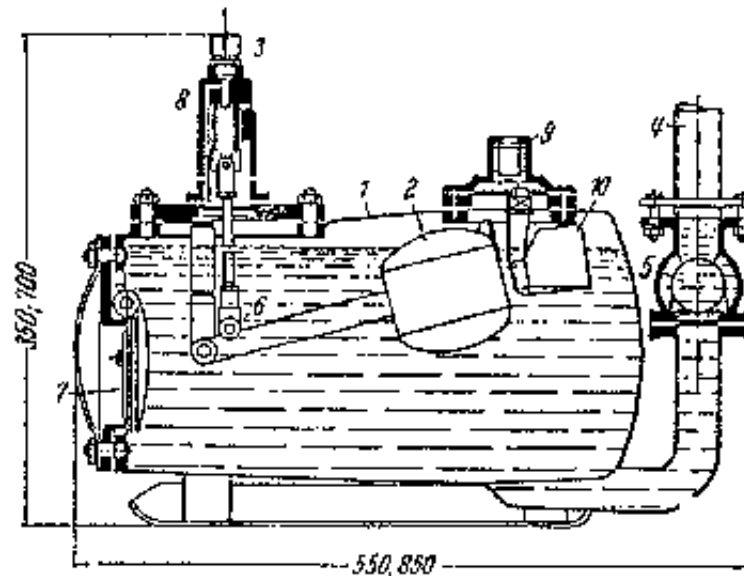
### **DISADVANTAGES:**

- lower efficiency than directly-driven piston or diaphragm pumps**

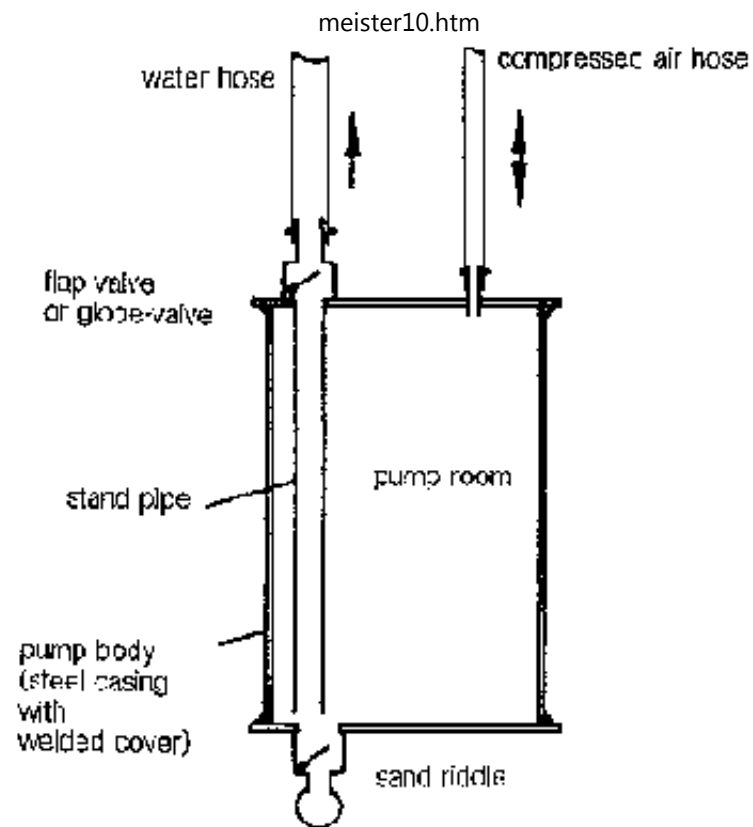
**Proposals for optimization: a three-way cock at the pump housing, controlled for example by a mechanical transmission, decreases the depressurization volume and therefore increases efficiency.**

### **SUITABILITY FOR SMALL-SCALE MINING:**

**Suitable for handling small quantities of water, under the condition that a compressed-air system and compressor are already available; otherwise, robust pneumatic immersible pumps are superior.**



**Fig.: Float pump, Reuter**



**Fig.: Compressed-air pump, Landtechnik Weihenstephan (Germany)**

## 4.2 Chinese liberation pump

### Deep Mining General Underground Mining Mine Drainage

germ.: Seilpumpe, Heinzenkunst

span.: bomba de mecate

Producer: Campo Nuevo, FCAP-UMSS

#### TECHNICAL DATA:

Dimensions:	down to 15 m depth
Weight approx.:	150 kg
Extent of Mechanization:	not mechanized
Form of Driving Energy:	manual
Alternative Forms:	hydromechanic, pedal drive, animal-powered whim
Mode of Operation:	continuous
Throughput/Performance:	low output quantities, e.g. for 5 m 10 m <sup>3</sup> /h
Technical Efficiency:	approx. 75 %
<b>ECONOMIC DATA:</b>	
Investment Costs:	approx. 200 DM
Operating Costs:	labor costs only

### **CONDITIONS OF APPLICATION:**

Operating Expenditure:	one person	low  ----- -----  high
Maintenance Expenditure:		low  ----- -----  high
Personnel Requirements:	low	
Location Requirements:	none	

Minina water must be pre-clarified in a sump. Coarser suspended solids lead to

Requirements:	excess wear of the standpipes.	
Replaces other Equipment:	other pumps	
Regional Distribution:	seldom used in Latin America, distributed worldwide in the agricultural industry	
Operating Experience:		very good  ----- -----  bad
	to date, the only experience is from the agricultural sector (for irrigation) and from conveyance of drinking water from wells	
Environmental Impact:		low  ----- -----  very high
Suitability for Local Production:		very good  ----- -----  bad
Under What Conditions:	village workshops. Materials: PVC pipes, nylon rope, rubber	
Lifespan:		very long  -----  very short

## **Bibliography, Source: PAAC, Fraenkel, Agricola, Cancrinus**

### **OPERATING PRINCIPLE:**

**A rope with rubber disks runs around an upper drive pulley and a lower return pulley through the sump. The upward-travelling portion runs through a PVC pipe, carrying water with it between tightly-fitting rubber flaps.**

**Comparable to 'Heinzenkunst' by Agricola, one of the early forms of mine drainage**

**pumps during the end of the Middle Ages. Rods were made of wood or iron chains and the water-transport vessels of leather.**

### **AREAS OF APPLICATION:**

**Mine drainage at pump depths of 10 - 15 m.**

### **SPECIAL AREAS OF APPLICATION:**

**Recirculation of plant water.**

### **REMARKS:**

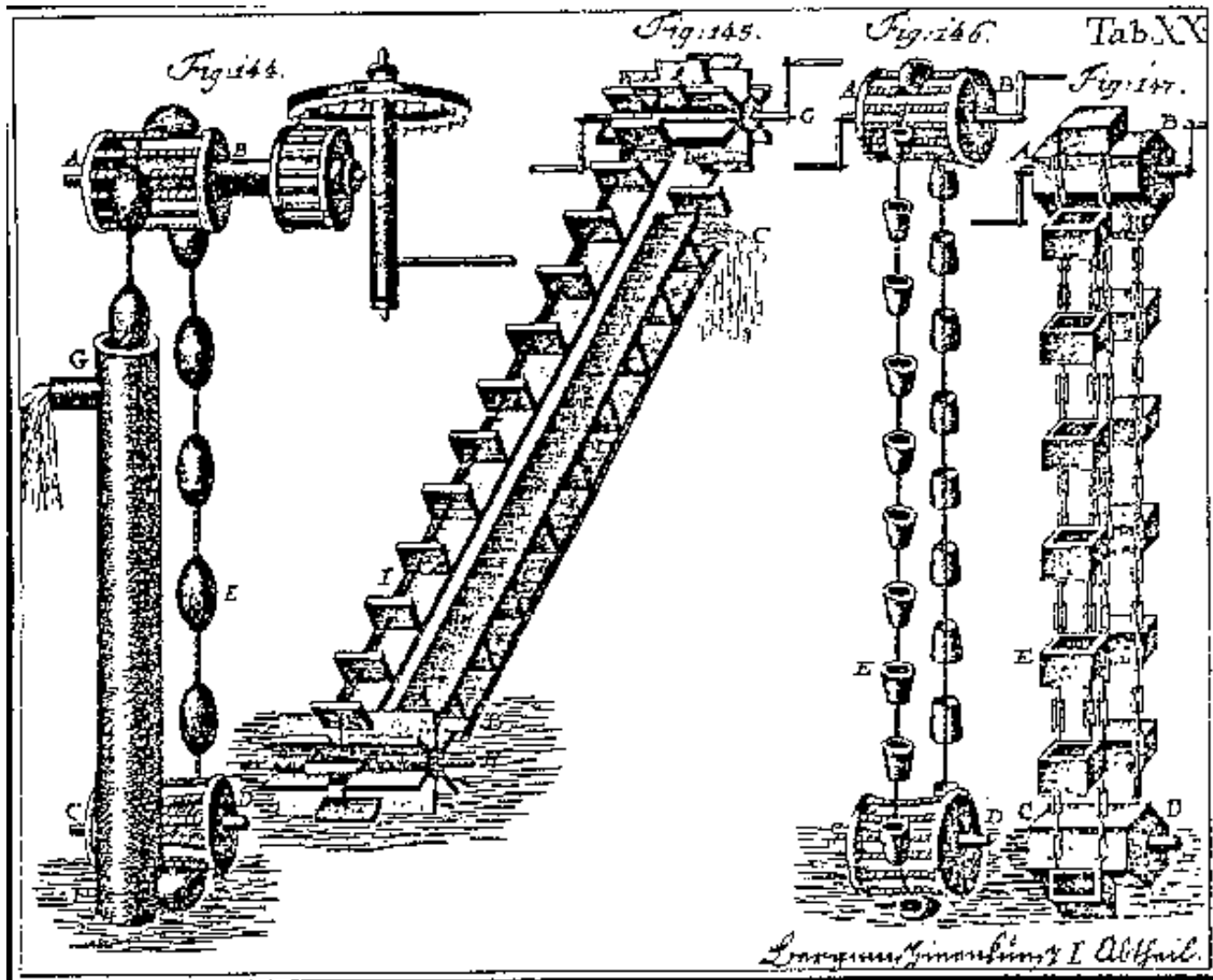
**For technical reasons due to excessive wear, Chinese Liberation Pumps or 'Heinzenkunste' have been displaced. Modern materials, however, such as PVC-pipes, etc., can produce long-lasting designs.**

**The efficiency of the pump decreases with increased transport distances as a result of increasing frictional losses and weakening of the seal in the cells. Therefore the maximal conveying distance is limited to approx. 15 m. The primary range of application is to a depth of around 2 - 5 m.**

### **SUITABILITY FOR SMALL-SCALE MINING:**

**'Heinzenkunst' can be applied most appropriately where energy is not available and wherever it is possible to pump intermittently over small heights. One area of application is the recirculation of plant water for beneficiation.**





**Fig.: 'Heinzenkunst' and other early types of drainage pumps. Source: Cancrinus, Part 6**

**4.3 Water bag**

**Deep Mining General  
Underground Mining Mine Drainage**

germ.: Bulgen zur Wasserhaltung, Botas zur Wasserhaltung  
 span.: botas de aro pare desague, botas de aro, botas de mano

<b>TECHNICAL DATA:</b>	
Dimensions:	30 - 50 liter leather bag for transporting water
Weight:	approx. 20 kg
Extent of Mechanization:	not or semi-mechanized
Form of Driving Energy:	pneumatic or electric engine on a winch
Alternative Forms:	animal-powered whim, animal drive, water wheel
Throughput/Performance:	1 - 5 m <sup>3</sup> /h up to approx. 30 m
Mode of Operation:	intermittent
<b>ECONOMIC DATA:</b>	
Investment Costs:	approx. 100 DM, local production
Operating Costs:	dependent on type of drive
Related Costs:	winch, hoisting rig, hoisting rope or cable

### **CONDITIONS OF APPLICATION:**

Operating Expenditure:

low |-----|-----| high

Maintenance Expenditure:

low |-----|-----| high

Personnel Requirements: low

**Location Requirements:** driving energy source is necessary

Replaces other equipment: drainage pumps

Regional Distribution: rare; Bolivia, Colombia and Chile

Operating Experience: very good |-----|-----| bad

Environmental Impact: energy-intensive low |-----|-----| very high

Suitability for Local Production: very good |-----|-----| bad

Production:

water bag, hoisting rig, and possibly drive-systems (e.g. hydromechanic)

Lifespan: very long |-----|-----| very short

**Bibliography, Source: Hentschel, Villefosse, Agricola, Treptow-Collection/Freiberg**

### **OPERATING PRINCIPLE:**

**Intermittently-operating technology for water drainage and crude-ore transport by means of leather bags. For mine drainage, the filled leather bag is hoisted by a shaft winch to the surface, where it is emptied through a hose following the principle of interconnected containers (known through Villefosse from Mexico).**

### **AREAS OF APPLICATION:**

**Water drainage for small quantities at shallow depths.**

### **SPECIAL AREAS OF APPLICATION:**

**In addition to water drainage, this technique is still currently used in small-scale mining for crude-ore transport.**

## **REMARKS:**

**The discontinuous operation is characterized by high energy demand, low efficiency, and low throughput. This could be improved by implementing a shuttle-service with two transport containers. In any case, the drive unit has to provide a controlled up and down movement, or reversal in direction. For a hydromechanic drive with a water wheel this can only be achieved only with a gear-drive unit or with a very complicated bull-wheel drive. In this case, an animal-powered drive is preferable.**

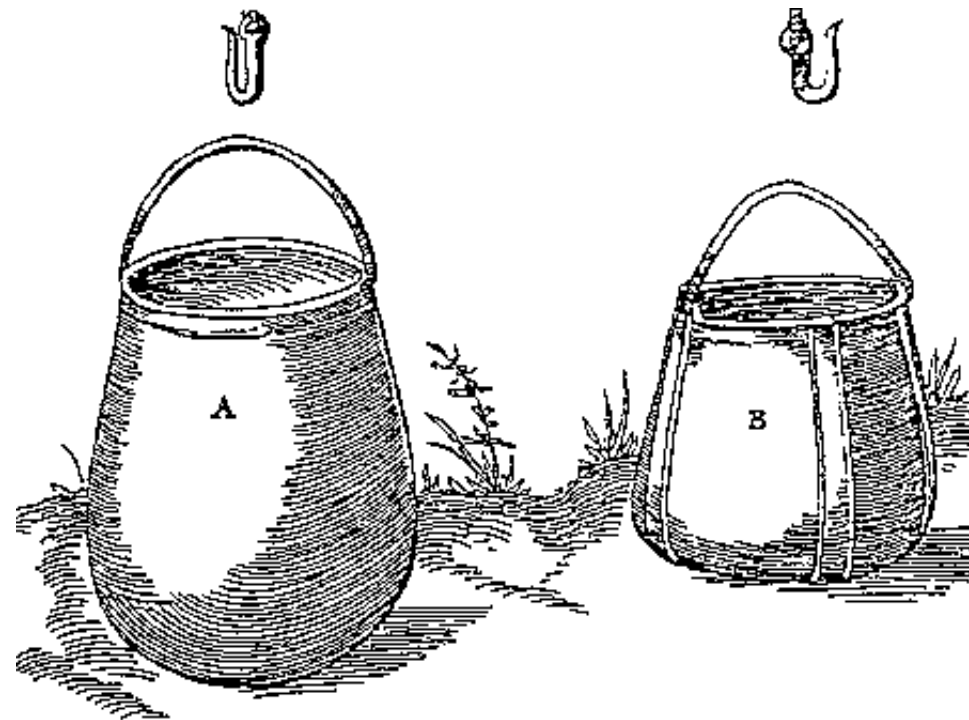
**As a whole, this technique is very labor intensive. At least three men are necessary for a drainage operation.**

**Drainage bags made of grass and coated with pitch are known to have been used in ancient Mazarron/Spain.**

**Water-bag transport is possible only in steep shafts. In ramps, small mines employ simple water wagons for mine drainage which are driven into the mine sump where they are filled with water. In some places, water wagons are equipped with flap valves and ball valves attached to the bottom of the water tank which automatically open and close in the sump, thus avoiding the necessity for personnel for filling at the sump. At the surface, the wagons are emptied by means of tipping devices, siphons, etc.**

## **SUITABILITY FOR SMALL-SCALE MINING:**

**Application is practical only under extreme conditions. This technique is highly labor and energy intensive and has a comparably low transport capacity.**



**Fig.: Types of water bags, by Agricola**

## **4.4 Bucket-chain conveyor**

### **Deep Mining General**

### **Underground Mining Mine Drainage**

engl.: bucket elevator, chain pump

germ.: Eimerkettenpumpe, Becherwerk, Kannenkunst, Paternosterpumpe

span.: bomba de cangilones, bomba rosario

**TECHNICAL**

<b><u>DATA:</u></b>	
Dimensions:	up to 100 m depth
Weight:	depends on depth
Extent of Mechanization:	not mechanized
Form of Driving Energy:	slow moving (water wheel or animal-powered whim) or geared-down high-speed drives (engines, turbines)
Mode of Operation:	semicontinuous/continuous
Operating Materials:	
Type:	lubricants
Quantity:	small amounts
<b><u>ECONOMIC DATA:</u></b>	
Investment Costs:	starting at approx. 100 DM plus drive-system for approx.10m
Operating Costs:	mainly cost of energy
Related Costs:	dependent on type of drive

### **CONDITIONS OF APPLICATION:**

Operating  
Expenditure:

low |-----|-----| high

Maintenance  
Expenditure:

low |-----|-----| high

Mining Bucket-chain pumps are designed only for steep shafts, and not for use in  
Requirements: inclined shafts or ramps. They are widely used for pumping slurries in  
beneficiation operations (bucket elevators or hoisting wheels).

Replaces other other pumping systems

Equipment:

Regional Formerly a widely distributed technique, today used in Africa for purposes  
Distribution: of conveying water.

Operating  
Experience:

very good |-----|-----| bad

Environmental  
Impact:

low |-----|-----| very high

Suitability for  
Local

very good |-----|-----| bad

Production:

Under What Metal workshops handling wire ropes, metal chains, metal bands or rods,  
Conditions: synthetic or natural-fiber ropes, and metal or wooden transport containers.

Lifespan:

very long |-----|-----| very short

## **Bibliography, Source: DBM, Cancrinus, Agricola**

### **OPERATING PRINCIPLE:**

**The bucket-chain conveyor consists of conveyor vessels attached to two circulating ropes or chains. At the deepest point of the pump, these vessels**

**submerge into the sump where they automatically fill with water. When the vessels reach the upper driving axle, they automatically empty into a discharge trough. As a result of the well-balanced weight distribution between the full transporting chain stringer and the empty return stringer, energy is needed only to overcome friction and to lift the weight of the water.**

### **REMARKS:**

**Bucket-chain conveyor pumping systems were successfully used in mines in the the Harz region (Germany) and in the other central european mines up to depths of 150 m, and were typically driven by hydropower (water wheels).**

**Unlike the chinese liberation pump, the bucket conveyor pump does not empty out when the driving power is off.**

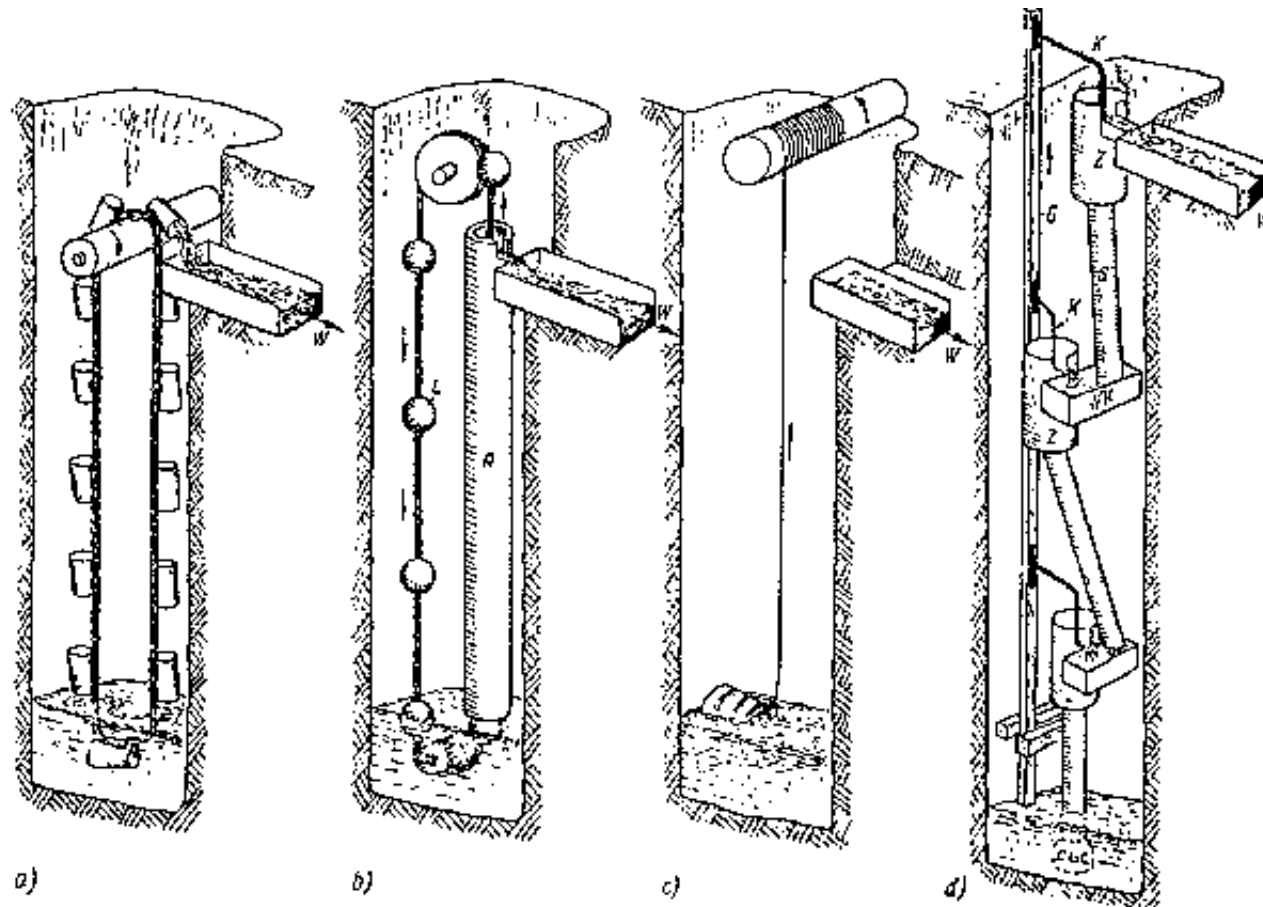
**The driving power required can be regulated by the number of vessels attached to the cable.**

**Bucket-chain conveyors are frequently employed in beneficiation processing where minor elevation differences are encountered because they can transport slurries with high solids contents without difficulties (still in operation today in tin benefication in Altenberg/Saxony, Germany).**

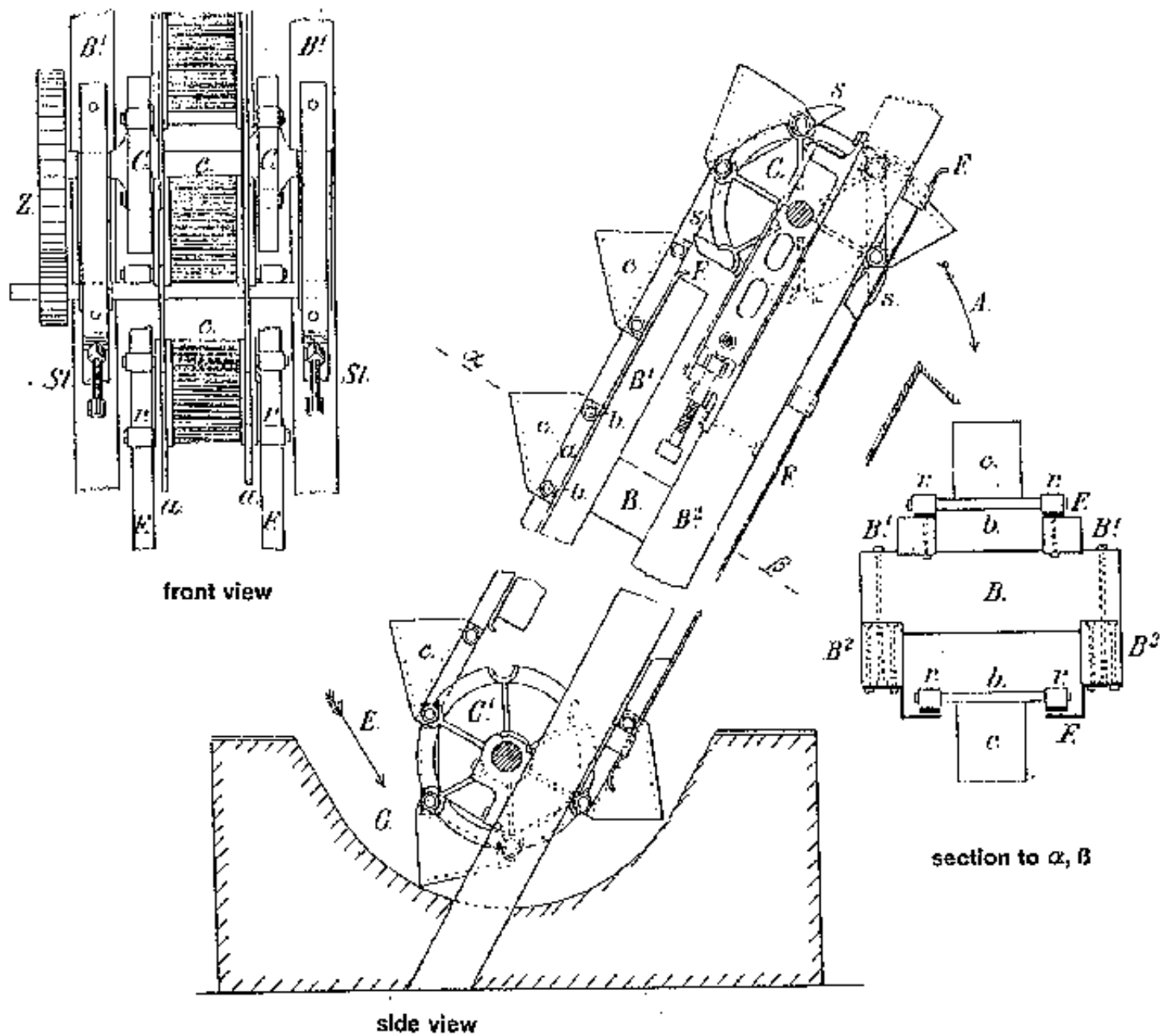
### **SUITABILITY FOR SMALL-SCALE MINING:**

**Appropriate for transporting smaller quantities over greater lifting distances, a simple and practical drainage system which can be locally produced and can be powered by a slow drive-system.**

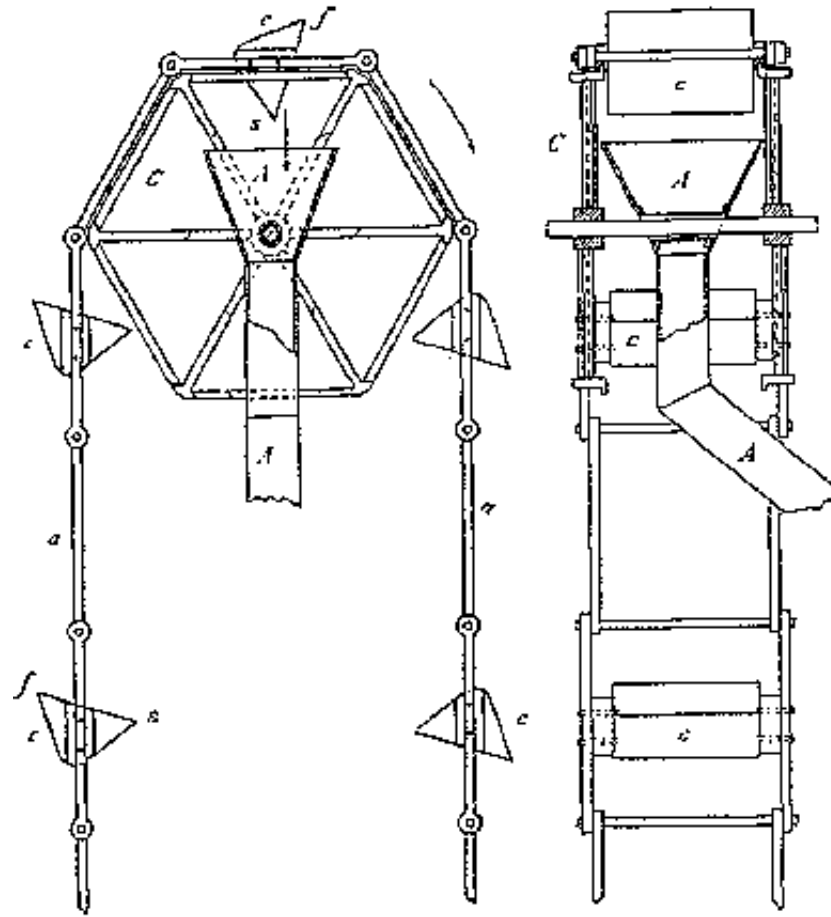




**Fig.: Different types of drainage apparatuses, by Agricola: a) bucket-chain b) chinese liberation pump c) water bag d) piston pump. Source: Wagenbreth**



**Fig.: Bucket elevator in beneficiation processing, from Treptow.**



**Fig.: Vertical bucket elevator in beneficiation processing, from Treptow**

## 4.5 Pneumatic high-pressure pump

### Deep Mining General Underground Mining Mine Drainage

germ.: Pneumatische Forder- und Hochdruckpumpe

span.: bomba neumatica de transporte y de alta presion, bomba neumatica de alta presion

Producer: Atlas Copco, Pleiger

<b>TECHNICAL DATA:</b>	
Dimensions.	40 × 40 × 60 cm LWH
Weight:	25 - 50 kg
Form of Driving Energy:	pneumatic
Alternative Forms:	none
Mode of Operation:	centrifugal pump, diaphragm pump or multistage piston pump
Operating Materials:	
Type:	compressed air (6 bar)
Quantity:	2 - 4 m <sup>3</sup> /min
<b>ECONOMIC DATA:</b>	
Operating Costs:	mainly cost of energy
Related Costs:	compressed air feed line, transport line (fire hose or pipe)

### **CONDITIONS OF APPLICATION:**

Operating Expenditure: low |-----|-----| high

Maintenance Expenditure: low |-----|-----| high

Location no restrictions, however pump selection must consider water quality:

Requirements: centrifugal pump and diaphragm pump for waste water; centrifugal pump

for fresh water

Replaces other other pump and water conveying systems

Equipment:

Regional worldwide

Distribution:

Operating Experience: very good |-----|-----| bad

due to low specific weight and non-susceptibility to malfunctions

Environmental Impact: low |-----|-----| very high

Impact:

minimal oil contamination from the air compressor

Suitability for Local Production: very good |-----|-----| bad

Local

Production:

Lifespan: very long |-----|-----| very short

### **OPERATING PRINCIPLE:**

**For drainage in underground mines, a wide range of different pumps are available as pneumatic pumps which can be operated with the commonly used underground energy source compressed air.**

**Depending on the type of fluid to be conveyed and the transport distances and quantities, axial, radial, piston or diaphragm pumps can be employed. The first two of these pump types are fluid-flow engines, which transmit energy to the water through acceleration. The resulting lifting pressure is sufficient for only**

**small to moderate lifting distances, the rate of flow is however relatively high. The positive-displacement pumps (piston and diaphragm pumps) expel the water from the pump chamber by decreasing the volume. High pressures are attainable especially with piston pumps.**

### **AREAS OF APPLICATION:**

**Pneumatic pumps are employed both in underground and surface mining for drainage purposes, for the supply of hydraulic fluids, for pumping of gelatinous blasting explosives, etc.**

### **REMARKS:**

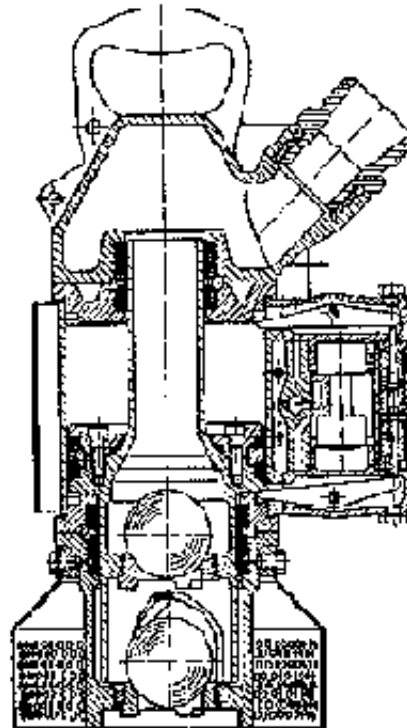
**Fluid-flow engines serving as pumps are generally not equipped with check valves, so that the water in the transport line flows back down when the power is turned off. Piston pumps, on the other hand, are inherently designed with check-valves, so that the return flow of water through the pump is not possible.**

**Piston and diaphragm pumps can also function as suction pumps whereby the maximum suction head should not exceed 5 m.**

**In mines where a compressed air infrastructure does not exist (rendering pneumatic pumps infeasible), electric pumps and even pumps driven by internal-combustion engines are also available. They are, however, inferior to compressed air pumps in terms of operating safety.**

### **SUITABILITY FOR SMALL-SCALE MINING:**

**For pneumatically mechanized mining operations, compressed air pumps are mobile and universally employable as a result of their high safety of operation, low specific weight and sturdy technology.**

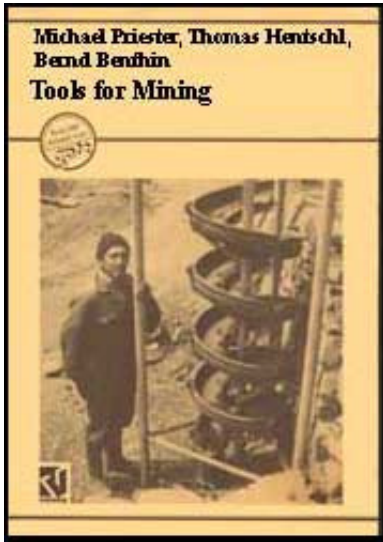


**Fig.: Cross-section of a pneumatic immersion pump for drainage purposes. Source: Manufacture's information, Pleinger**



[Home](#) > [ar](#).[cn](#).[de](#).[en](#).[es](#).[fr](#).[id](#).[it](#).[ph](#).[po](#).[ru](#).[sw](#)

 **Tools for Mining: Techniques and Processes for Small Scale Mining (GTZ, 1993, 538 p.)**



- ➔ □ **Technical Chapter 5: Support**
  - 📄 **5.1 Rigid support in drifts and stopes**
  - 📄 **5.2 Single mechanical prop**
  - 📄 **5.3 Hydraulic prop support**
  - 📄 **5.4 Rock bolts, rods, rock stabilizers**

**Tools for Mining: Techniques and Processes for Small Scale Mining (GTZ, 1993, 538 p.)**

## **Technical Chapter 5: Support**

### **5.1 Rigid support in drifts and stopes**

#### **Deep Mining General Underground Mining Support**

germ.: Starrer Ausbau in Strecke und Abbau

span.: entibacion rigida en galeria y explotacion, enmaderacion

#### **TECHNICAL DATA:**

Dimensions:	dependent upon roadway cross-section
Extent of	not mechanized



Mechanization:	
Alternative Forms:	possibly pneumatic chain saw to adjust roof bars and props, gas welding units for steel supports (for example from old railroad rails), cutting torch.
Operating Materials:	
Type:	wood, possibly impregnation agents, e.g. common salt, iron or copper vitriol, mercury or zinc chloride.
Quantity:	large quantities
<b>ECONOMIC DATA:</b>	
Investment Costs:	vary greatly depending on location of mining operation, cost of wood, cost of transportation, quality of wood, etc.
Related Costs:	possibly pneumatic chain saw (e.g. from Spitznas) for wooden supports, welding torch for steel supports.

### **CONDITIONS OF APPLICATION:**

Operatig Expenditure:	low  ----- -----  high
Maintance Expenditure:	low  ----- -----  high
Replaces other Equipment:	all other types of support
Regional Distribution:	worldwide
Operating Experience:	very good  ----- -----  bad
Environmental Impact:	low  ----- -----  very high
	damage to vegetation due to use of wooden supports
Suitability for Local Production:	very good  ----- -----  bad

Suitability for local production:

Lifespan:

very long |-----|-----| very short

steel frame-sets are reusable

**OPERATING PRINCIPLE:**

**Framing or timbering support consists of two props and one roof bar made of wood or iron. Support capabilities vary depending upon the type of connection between the props and the roof bar.**

**The German framing method is characterized by the interlocking or scarfing of bars and props. The frame-set can then resist both shear forces as well as vertical compressive loading. Depending on the calculated ratio between these two loads, scarfing can be designed more for shearing forces or more for vertical compressive loading. To increase the compressive strength of the props, the props are installed with the thicker end toward the roof.**

**The Polish timbering method is characterized by a loose laying of the roof bar on top of the two grooved props. This method cannot counter shearing forces (lateral compression).**

**The 'Silesian' method includes a "soldier sprag" brace wedged between the props underneath the roof bar to reinforce the props against lateral compressive forces.**

**Frame-set supports are additionally braced by wedging struts between the props of adjacent sets to increase their stability. The spacing between sets ranges from a few centimeters up to 1,5 m depending on the compressive load. In Inclined formations, frame supports are installed with the props perpendicular to the**

## **stratification (dip).**

### **REMARKS:**

**For mine support, a timber with a long fiber structure is always employed, such as spruce, fir, or other conifer wood, or eucalyptus. Timbers of these wood types shatter slowly when their loading capacity is exceeded and thus warn the miners through a definite creaking. Short-fibered timbers break without any prior, slowly-developing visible or audible indications. A dense, resinous, slow-growing wood type is always preferable for mine support purposes. For mining activities of longer duration, the timber should be cultivated by the mine operators themselves near the mine site.**

**Timber employed in moist or wet mines, especially for shaft construction in exhaust ventilation shafts or drifts in water-bearing strata, should be previously treated by a preservative. Timbers are impregnated by dipping them into special solutions, such as Roman-salt, copper sulphate, etc., either with or without pressure.**

**Timber support normally is not reuseable. The only exception is simple prop timbering for stoping which is sometimes recovered and the wood then reused for shorter props, head boards, breast timbers or wooden cribbing. In situations requiring excessive support, such as mining in incompetent rock, the cost off timbering becomes a significant factor in the economic analysis of the operation. Here the higher investment costs for friction prop support can result in a substantial savings In operation costs, since these support elements can be reused.**

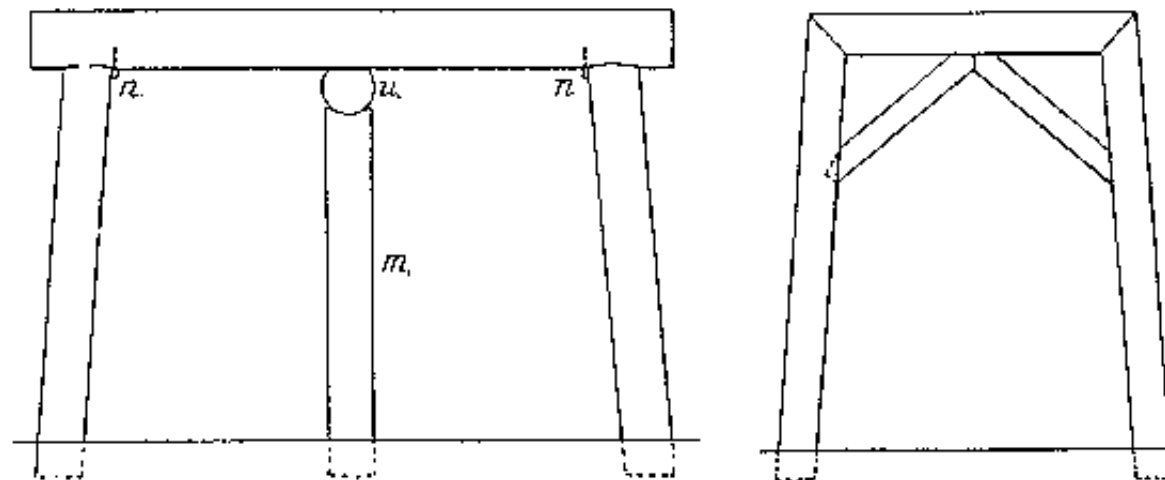
**Timbering is the simplest roof support method in incompetent rock (e.g. in faulted zones) and contributes greatly to increasing mine safety. It is, however, disadvantageous for artificial mine ventilation in that it increases air resistance.**

**In addition to purely wooden supports, there are also systems which employ mixtures of wood and steel, as well as purely steel supports or arches and - also widely distributed - yielding arches made from steel channel sections.**

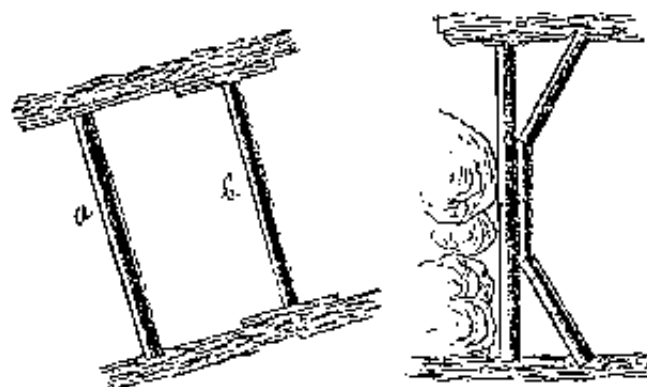
**An alternative method for supporting drifts is the construction of non-cemented or cemented brick arches. These are used to support longitudinal vault-like tunnels, requiring either expensive abutments on both sides (built into deep grooves in the floor or constructed as retaining walls) or as adjacent arches with span-widths of several meters which run along both sides of the vault parallel to its longitudinal axis. Bricked arch support is extremely expensive and is suitable only where galleries must remain open for longer durations. In areas of stoping activities, support is provided by individual props (see 5.2).**

### **SUITABILITY FOR SMALL-SCALE MINING:**

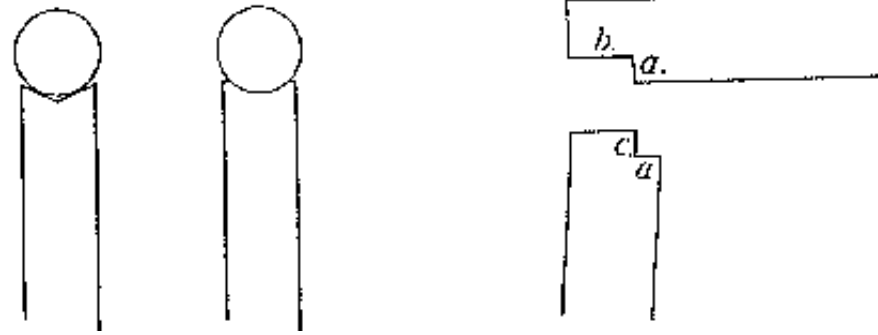
**As an auxiliary support in stopes and drifts, timbering is a very sturdy support method which is quick and simple to install. The local availability of timber for the supports has a major effect on the costs. In areas of poor vegetation, timbering should not be employed In order to avoid destruction of forests.**



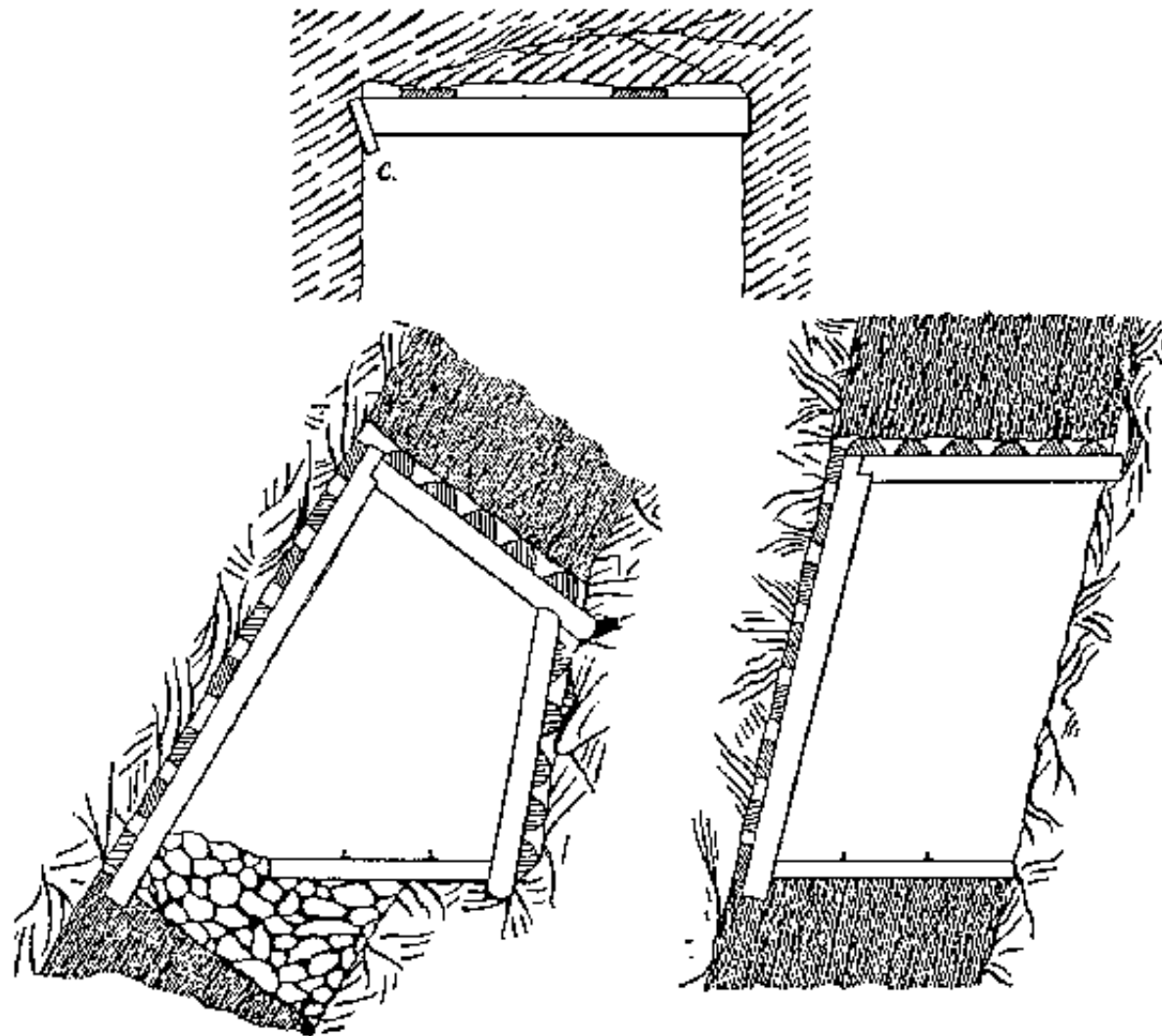
**Fig.: polish and Swedish timber sets. Source: Treptow.**



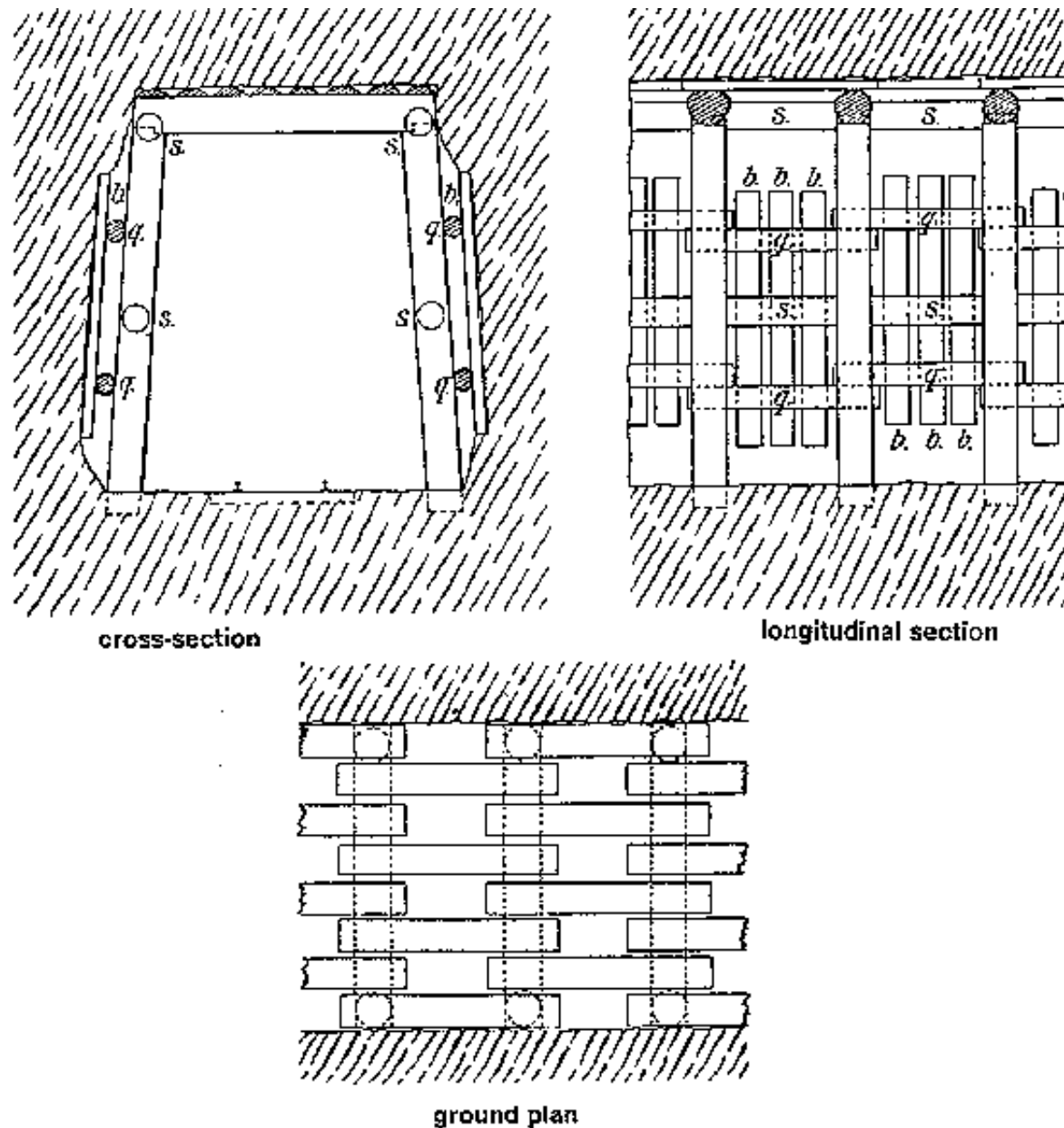
**Fig.: Timbering with individual props; left: a) simple prop, b) prop with head board and foot block; right: prop, wedged to counter lateral compression. Source: Treptow**



**Fig.: Joint between prop and roof bar of a Polish frame-set (left) and scarf joint between the prop and roof bar of a German frame-set (right). Source: Treptow**



**Fig.: Different types of simple timbering for various deposit and strata conditions.  
Source: Treprow**



**German frame-set timbering with breast timbers, typical roof lagging and latticed lagging of the stopes. Fig.: Laggin in German timbering support in a drift. Source: Treptow**



## 5.2 Single mechanical prop

### Deep Mining, General (Coal) Underground Mining Support

germ.: Einzelstempelausbau/mechanisch

span.: estemple individual mecanico

<b>TECHNICAL DATA:</b>	
Dimensions:	from 0,63 - 3,15 m
Weight:	approx. 10 - 50 kg
Extent of Mechanization:	not mechanized
Form of Driving Energy:	manual
Mode of Operation:	intermittent
<b>ECONOMIC DATA:</b>	
Investment Costs:	dependent on material
Operating Costs:	low
Related Costs:	none, requires only hammers for installation; bars of wood or steel rails.

### **CONDITIONS OF APPLICATION:**

Operating Expenditure:

low |-----|-----| high

Maintenance Expenditure:	low  ----- -----  high
Personnel Requirements:	low
Location Requirements:	suitable for areas of low timber availability
Replaces other Equipment:	wooden timbering, etc.
Operating Experience:	very good  ----- -----  bad
Environmental Impact:	low  ----- -----  very high
Suitability for Local Production:	very good  ----- -----  bad
Under What Conditions:	metal workshop
Lifespan:	very long  ----- -----  very short

## **Bibliography, Source: Bansen, Fritzsche, Woodruff**

### **OPERATING PRINCIPLE:**

**A single mechanical prop consists of encased prop sections which are mechanically telescoped outward for wedging the prop between the floor and the roof or roof bar. Rigid props are differentiated from yielding props according to the operating principle: rigid props, for example threaded and nonius-props, can only react to increased compressive loads when a wooden bar permits deformation, otherwise they collapse when the maximum load is exceeded. Yielding props, on the other hand, telescope together when the maximum load is exceeded. This can be achieved either by friction systems (friction prop) or by inserting compressible elements (e.g. peat prop).**

### **REMARKS:**

## **Flexible due to unlimited reapplication possibilities.**

Different types: - nonius-prop / temporary prop  
- friction prop  
- threaded prop / temporary prop

**can possibly be made out of scrap, e.g. railroad rails.**

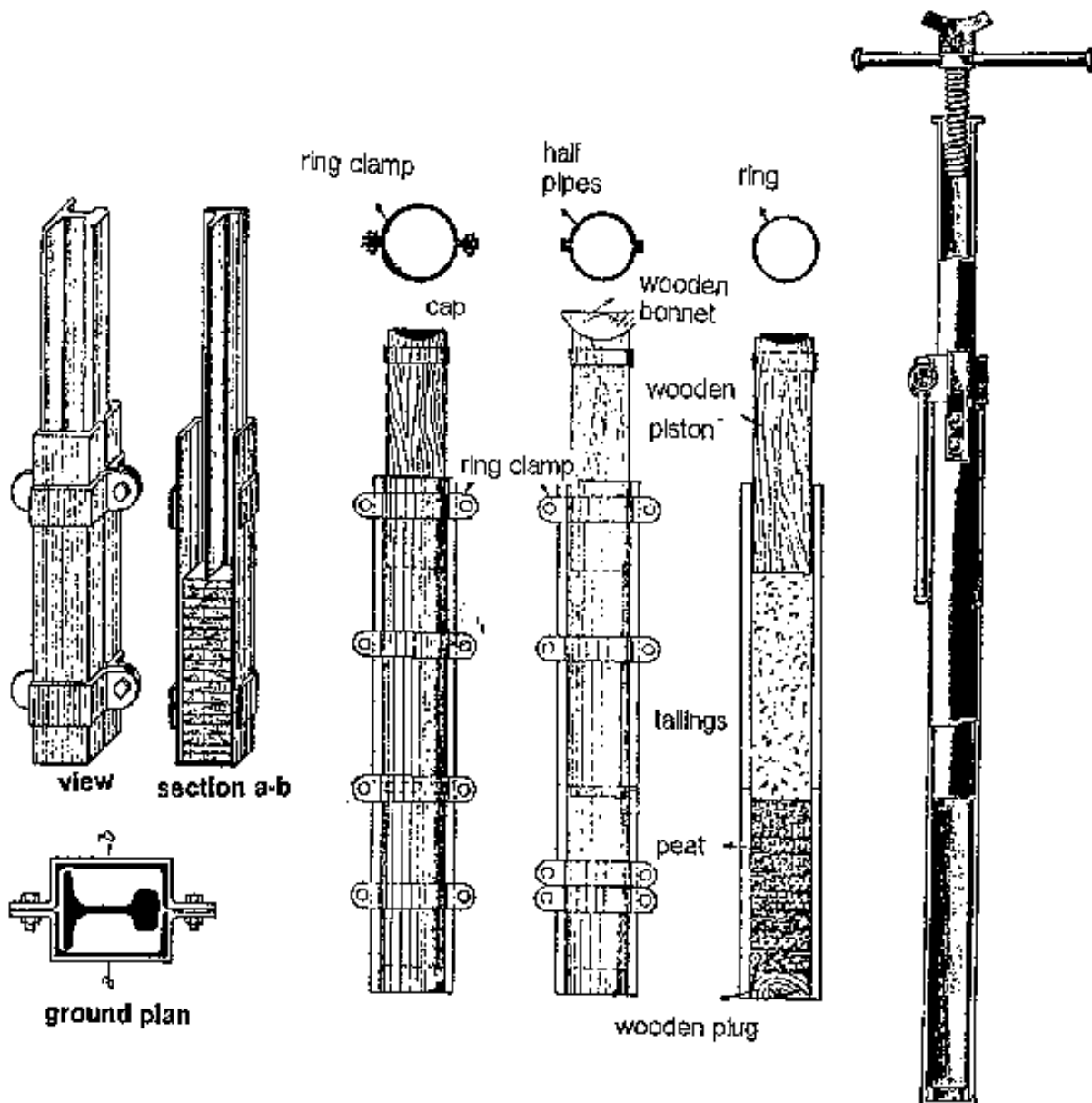
**A common problem is that single mechanical props can only be installed with a low setting load. Various mechanical setting devices make the setting process easier.**

**The less the props are extended, the better they can withstand loading without bending and will therefore last longer.**

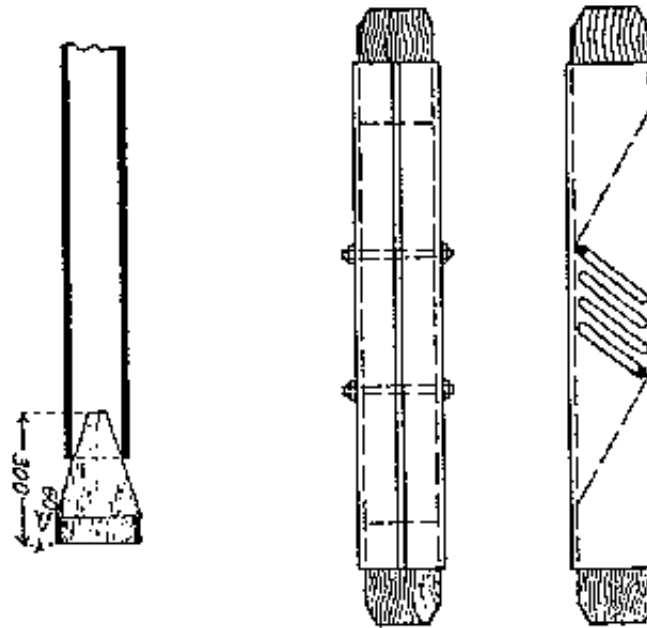
**Problems arise in employing mechanical prop supports in mines which are characterized by highly fluctuating deposit thicknesses, in that a precise assessment is required in advance to determine the appropriate long-term prop length. This greatly limits their suitability for small-scale mining.**

### **SUITABILITY FOR SMALL-SCALE MINING:**

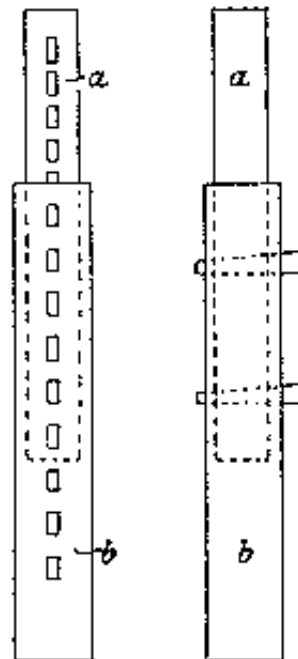
**A mechanical prop support is a suitable reusable support method in mining of deposit zones where relatively low compressive loads are encountered. The low setting load is a major disadvantage of this technique, which -- particularly when a large quantity of props are employed -- is technically inferior to hydraulic prods.**



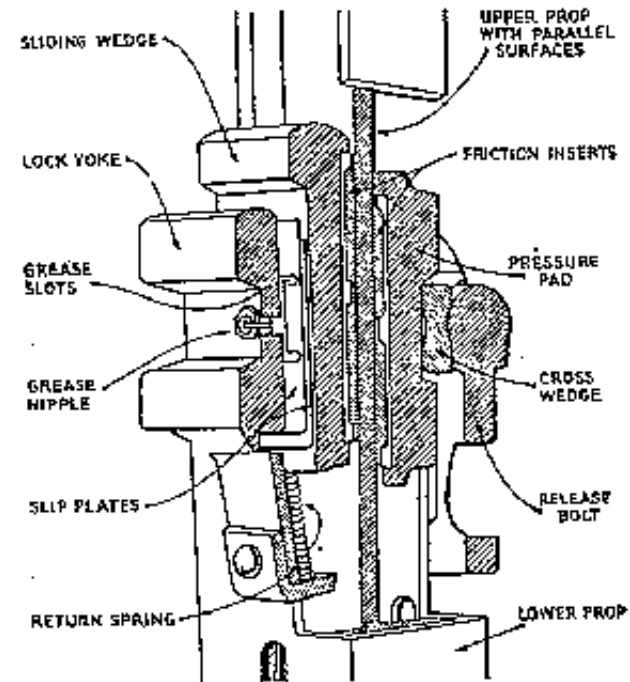
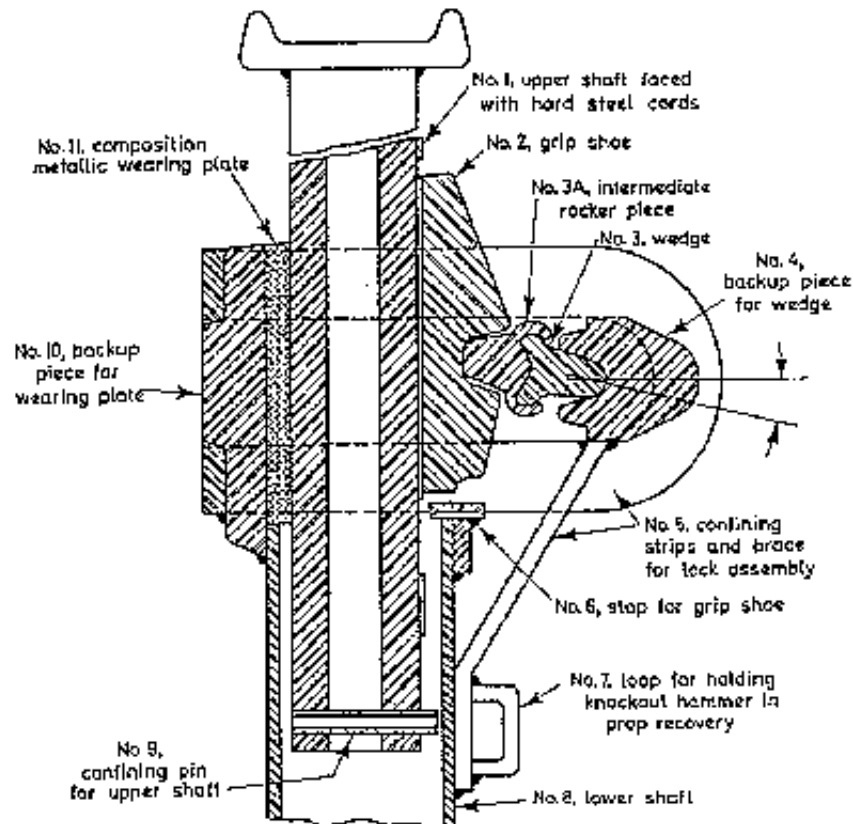
**Fig.: (above): Simple yielding props with compressible insets. (right, of peat; left. of wood). Source: Bansen**



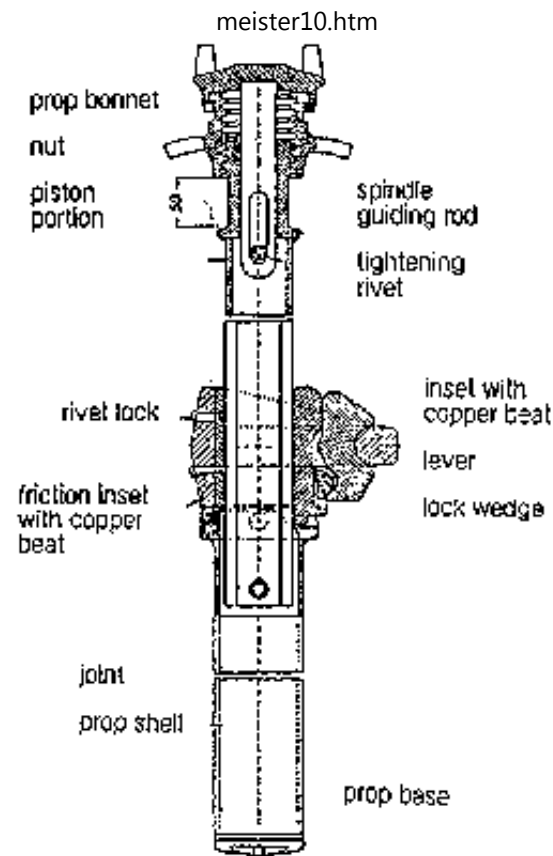
**Fig.: Types of props with compressible elements made of wood. Source: Bansen**



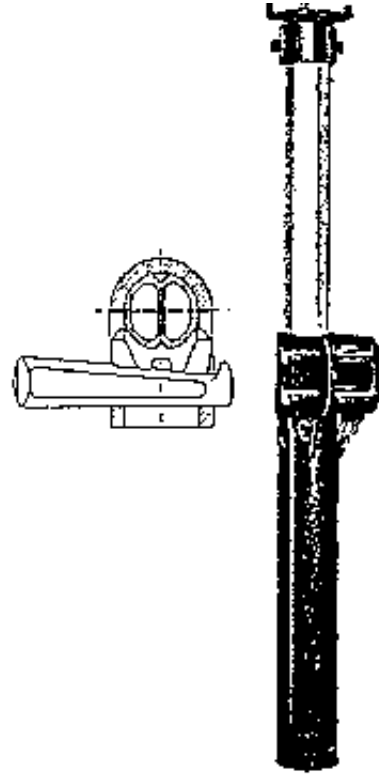
**Fig.: Nonius-prop, in which the nonius serves to increase the setting load of the otherwise rigid prop. Source: Bansen**



**Fig.: Friction elements of modern friction props. Source: Woodruff**

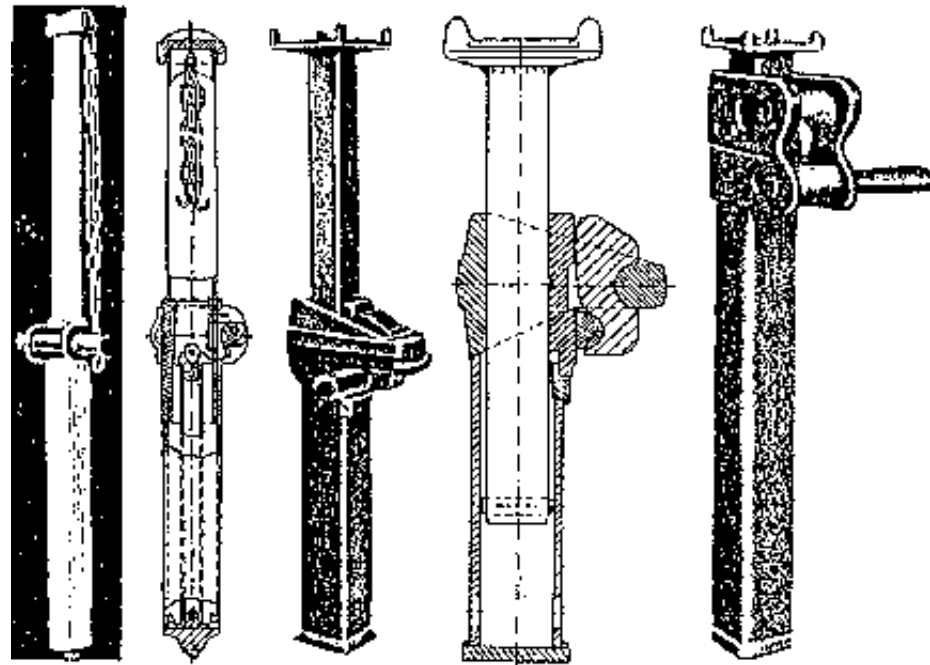


**Fig.: Cross-section of a duplex prop, the top part with threads and the bootom part with friction element.Source: Reuther**



**Fig.: Profile (left) and section view (right) of a wedged prop. Source: Reuther**





**Fig.: Various types of German-made friction props. Source: Woodruff**

## 5.3 Hydraulic prop support

### Deep Mining General Underground Mining Support

germ.: Einzelstempelausbau/hydraulisch

span.: estemple individual hidraulico

Producer: Salzgitter, DeBeSa

#### **TECHNICAL DATA:**

Dimensions: 650 - 3600 mm collapsed, 675 - 5000 mm extended

Weight. steel: 42 - 240 kg/prop + 4 - 18 kg extension pieces, light alloy:

25 - 65 kg

Extent of Mechanization: fully-mechanized when serviced by a central pumping and distribution system for hydraulic fluid; not mechanized when serviced by a manual pumping system (internal or external)

Form of Driving Energy: electric or pneumatic pump for producing hydraulic pressure

Throughput/Performance: 10 - 15 sec. setting time Operating Materials:

Type: oil in water-emulsion pure water (DeBeSa)

Quantity: 2 - 4 % oil in H<sub>2</sub>O, pH 5 - 8, dH up to 15

### **ECONOMIC DATA:**

Investment Costs: approx. 1.2 - 4 times the cost of friction props (see 5.2)

Operating Costs: approx. 50 % of the costs for traditional timbering

Related Costs: hydraulic high-pressure pump (approx. 200 bar) with setting gun, roof bars.

### **CONDITIONS OF APPLICATION:**

Operating Expenditure: low |-----|-----| high

Maintenance

Expenditure: low |-----|-----| high

Mining

Requirements: hydraulic props are primarily employed in slightly or partly mechanized coal mines, but are also found in ore mines, industrial mineral mines, etc. Even in fully-mechanized mines hydraulic props are still in use for special support, for example in areas of geological faults, at the ends of the face, face-roadway intersections, etc. due to their flexibility and versatility.

Replaces other timbering, friction props

Equipment:

Regional worldwide, especially in coal mining

Distribution:

Operating Experience: very |-----|-----| good bad

Environmental

Impact: low |-----|-----| very high

With conventional props, high pollution of mine water and drainage ways due to use of oil-in-water emulsion for hydraulic fluid. Glued - joint steel pipe props from DeBeSa use pure water as hydraulic fluid and thereby contribute to environmental protection.

Suitability for Local Production: very good |-----|-----| bad

Under What

Conditions:

Assembly and repair of the glueable DeBeSa hydraulic props is possible in comparably simple manufacturing workshops.

Lifespan:

very long |-----|-----| very short

The long lifespan and suitability for reuse, in conjunction with the capability to replace defective components, ensure longlasting employment.

**Bibliography, Source: Salzgitter Company information, DeBeSa Company information, Fritzsche, Woodruff**

### **OPERATING PRINCIPLE:**

**Hydraulic props consist of a sealed working cylinder with two valves, one for intake (setting valve) and the other for discharge (release valve, working valve) of hydraulic fluid. For increased stability the hydraulic props are equipped with a claw at the upper head-end and a base at the bottom. The function of the props is to stabilize incompetent roof or hanging wall. The positioned prop is telescopically extended by highly-pressurized hydraulic fluid injected by means of a setting gun and wedged into place with a specific setting load adjusted according to the respective compressive rock load. When the rated load is reached during installation or by subsequent strata movement, the working valve engages and opens the cylinder. This yielding prevents damage to the support from increasing compressive loading. The optimal support is attained when the props are installed in combination with articulated bars which distribute the forces over a wider hanging-wall or roof surface. During prop recovery, the release valve is opened with a key, allowing the hydraulic fluid to escape and the prop, equipped with a spring, to recede. The prop is then available for reuse.**

### **AREAS OF APPLICATION:**

**Use of hydraulic single prop supports is only practical and economic where incompetent roof or hanging wall require a support method which can be adjusted to meet rapidly changing conditions. Hydraulic prop supports are appropriate for short-term installations involving frequent changes of location due to rapid face advance, or where high prop-setting loads are desirable. Such conditions arise in coal mining with roof caving or backfilling, in longwall mining, in room and pillar mining, as well as in ore mining by overhand stoping. In addition, single hydraulic props are suitable for support of all special mining activities such as support of fault-zones or roof-fall areas, machine rooms, and face-roadway intersections.**

**REMARKS:**

**The use of single hydraulic props in the situations listed above can contribute significantly to protecting valuable natural resources by substituting for traditional timbering methods. Replacing the normally non-reuseable support timbers (e.g. in Turkey, totalling more than 1 m<sup>3</sup>/20 t of useable output) with re-usable props can also result in decreased operating costs.**

**The limited working length of the hydraulic prop, like mechanical friction props, is disadvantageous in mines with fluctuating seam or vein thickness. Due to the high setting load achievable with hydraulic props, capable of supporting areas 5 to 10 times larger than mechanical props, the prop density can be reduced.**

**The DeBeSa Company is striving to adapt their products (individual props and articulated bars) to meet the demands of small-scale mining in developing countries:**

- assembly and repair can be performed by local labor. The costs for an assembly and repair shop amount to only around 10 % of the costs of commonly manufactured parts.**
- the approx. 30 % net product arising from local production preserves the country's foreign exchange position.**
- cost savings of more than 50 % can be realized compared to the widely-used wood timbering.**

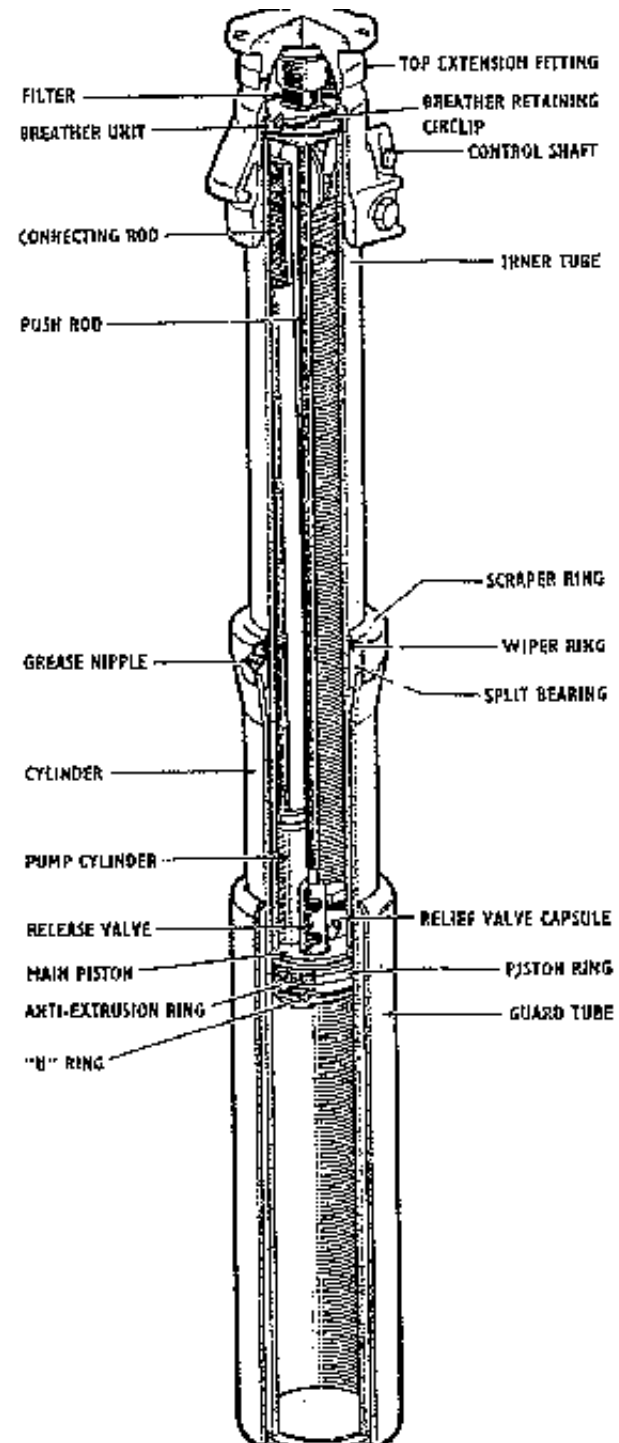
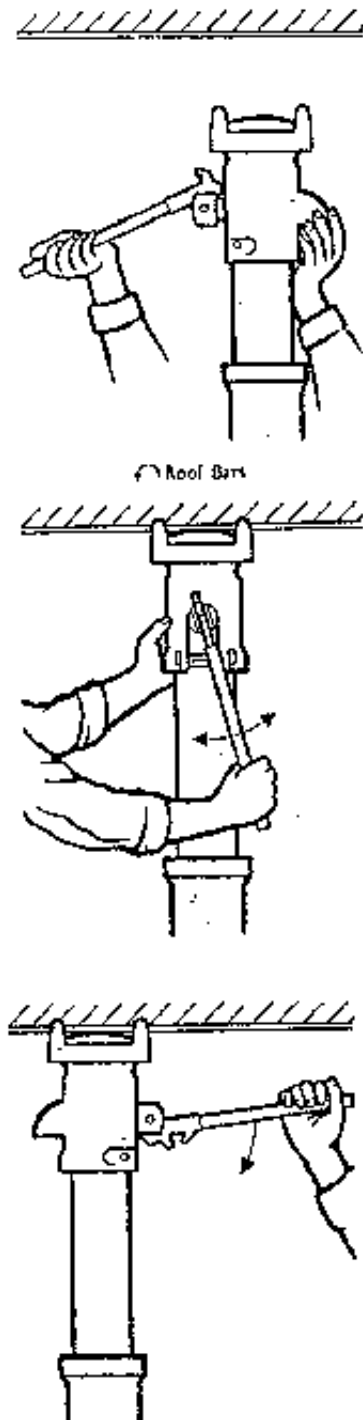
- the capital investment for a highly developed and complex support system is not required.**
- the use of glueable Joints in this modular system permits the replacement of damaged parts, therefore increasing the lifespan of the remaining components.**
- storage costs are reduced by around 70 % as inventory can be limited to only a few standardized parts.**

**Disadvantages of hydraulic props include high consequential or related costs for producing and distributing high-pressure fluids (pneumatic or electric high-pressure pump, liquid storage tank, high-pressure hoses, setting guns, etc.).**

**This disadvantage can be overcome by employing props which are set with manually-operated pumps. Such props were employed earlier in Germany, and are still used today in Anglo-Saxon countries. They function by using a hand pump to force the hydraulic fluid from the upper cylinder (storage cylinder) into the lower cylinder (working cylinder), analogous to a hydraulic automobile jack.**

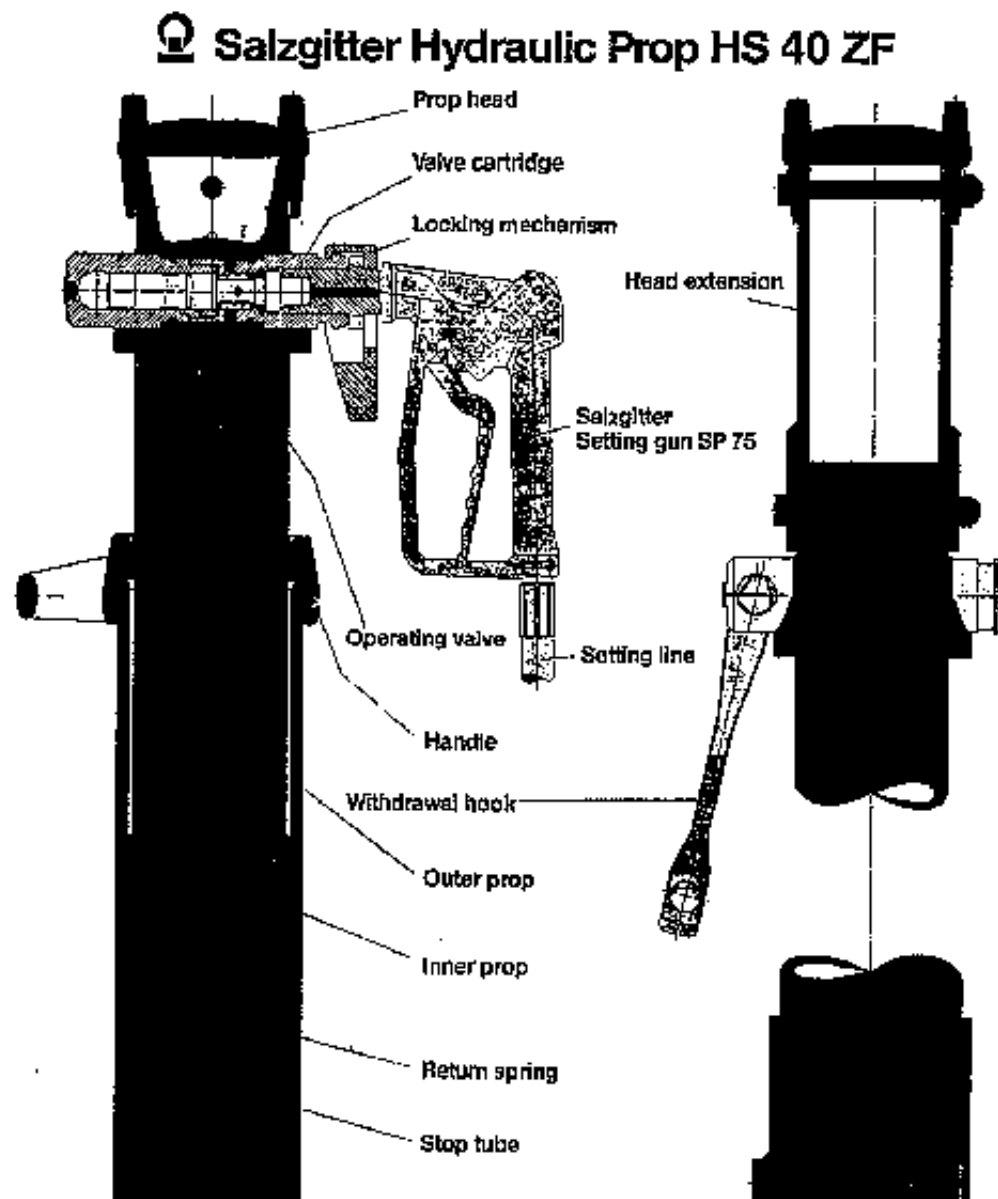
### **SUITABILITY FOR SMALL-SCALE MINING:**

**The type of prop system employed affects the consequential costs. Simple manually-operated props offer an alternative to timbering in small-scale mines. The investment for single hydraulic props with an external pump system can only be recovered when large quantities are employed to offset the higher costs for the necessary auxiliary installation devices.**

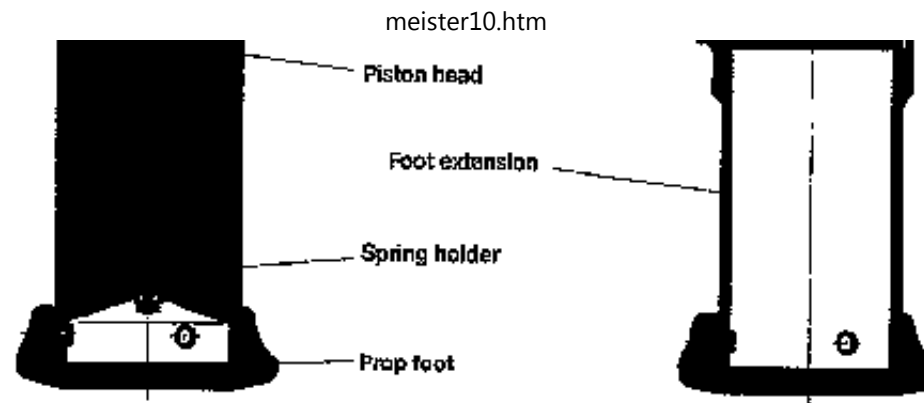




**Fig.: Telescoping, setting and drawing (recovery) of hydraulic individual props with manual pump (left, from top to bottom) and cross-section of a hydraulic prop. Source: Woodruff**







**Fig.: Sketch of a hydraulic prop, supplied externally with hydraulic fluid. Source: Manufacturer's information, Salzgitter**

## 5.4 Rock bolts, rods, rock stabilizers

### Deep Mining in Competent Rock Underground Mining Support

germ.: Felsanker

span.: barras, pernos de anclaje, pernos para hormigon

Producer: Atlas Copco, Grauvogel, Lenoir et merrier, GHH, Becorit, Gebr. Windgassen, Ingersoll-Rand

#### **TECHNICAL DATA:**

Dimensions:	800 mm - 4,000 mm length, 16 - 42 mm for drilling hole 32 - 76 mm
Weight:	1 - 25 kg
Extent of Mechanization:	not/partly mechanized

Mode of Operation:	intermittent
Capacity/Throughput:	5 - 100 t pulling force
Technical Efficiency:	30 - 40 min/bolt inserting time in low mechanized mines, density of bolts up to 1 per m <sup>2</sup>
<b><u>ECONOMICAL DATA:</u></b>	
Investment Cost:	approx. 20 DM/piece
Consequential Cost	
through Coupling Effects:	jack-hammer with drill steel of same length as bolt, spanner or roof bolting drilling and setting machine

### **CONDITIONS DE APPLICATION:**

Operating Expenditures:		low  ----- -----  high
Maintenance Experience:		low  ----- -----  high
Mining Requirements:	bolts have to be preloaded whose intensity is difficult to assess manually. Pneumatic impact wrench or setting winch is therefore preferred.	
Replaceable Equipment:	other support methods in solid rock excavations	
Regional Distribution:	worldwide	
Experience of Operators:		very good  ----- -----  bad

Environmental  
Impacts:

low |-----|-----| very high

decreasing demand for wood in mines

Suitability for  
Local  
Production:

rod anchor

very good |-----|-----| bad

Under what  
Conditions:

metal manufacture

Lifespan:

very long |-----|-----| very short

**Bibliography, Source: Fritzsche, Company Info, Woodruff, Ruther**

### **OPERATING PRINCIPLE:**

**Bolt support is being applied to fix rock strata which are slacking off due to a decreasing pressure of strata in the area of mining excavations at the stable rock mass. This is being done by inserting a bolt into a drilling hole that is then either wedged mechanically or along the whole length or sections cemented or pasted together with the adjoining rock. The anchor bolt transmits the tension to the screwed roof-bolt head.**

### **AREAS OF APPLICATION:**

**To support mining excavations and roadways of underground mines. Bolt support can be an alternative to timbering which is what is commonly used in the developing countries.**

**In hard rock mining, bolts are used where larger excavations in stable rock are supposed to last long, e.g., storage bunkers, crushers, chambers, draw points.**

**Various types of bolts that are used can be classified as follows:**

Mechanical bolts:

- slot-and-wedge bolt\*
- expansion anchor as expansion shell bolt\*
- expansion wedge bolt\* and wedge shell bolt\*
- split set and folding bolt

Mortar bolts:

- cement bolts
- resin-based mortar bolts

Combination bolts:

- end-cemented expansion bolt or split set
- cemented press bolt

**\*such types of anchors need the lowest extension of mechanical equipment**

### **REMARKS:**

**Bolted support shall be applied, where nonrelaxed rock is stable. Bolted support would be the wrong method in faulted zones.**

**Advantages of bolted support are the fast insertion and that no space requirements are needed.**

**Blasting tremors can affect the bracing of mechanical bolts.**

**Different bolts for mechanical bracing in stable and semi-stable rock are available.**

**Semi-stable and loose rock necessitates cemented bolts. Expansion bolts are usually braced with half its yield stress.**

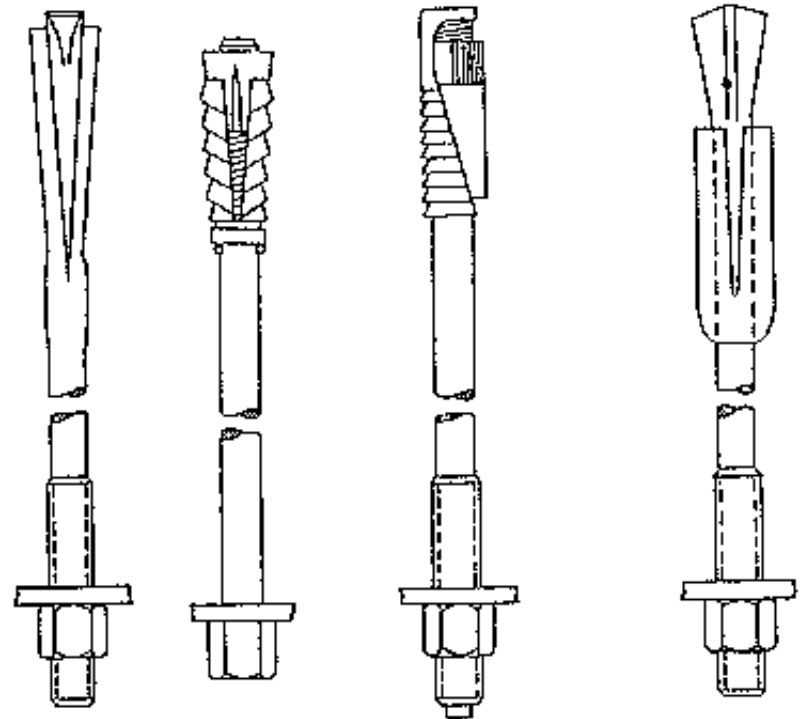
**Besides washers and bolting plates with or without angular compensation, bolted support is being applied by lagging screen wire, steel belts etc. The lagging keeps back the broken rock and directs stress to the bolts.**

**For the optimal functioning of bolted support, it is necessary to insert the bolt in the direction of the expected pulling force. Specific geological knowledge (stratification, foliated structure) is therefore necessary.**

**Besides metallic bolts, wooden slot-and-wedge anchors were applied in the U.S.A. mainly in places with soft hanging such as argillaceous and quartzitic shalestone. Its dimensions were 5 cm, 125 cm length, 6 × 6 cm head, turned on a lathe with fresh, wet pine or spruce wood, two wedges 1 7/8 × 1 × 16" and one 30" in anchor plate. The cost approx. 0.5 US\$/piece. The advantages were, high retaining force in loose adjoining rock, the possible production at the mine site, and high corrosion resistance. Such anchors have been produced locally with output of some 500 pieces/man-shift and setting capacity of some 100 pieces/ms.**

### **SUITABILITY FOR SMALL-SCALE MINING:**

**Bolted support is advisable only for pneumatic mechanized mines with semi-stable adjoining rock as roof support.**



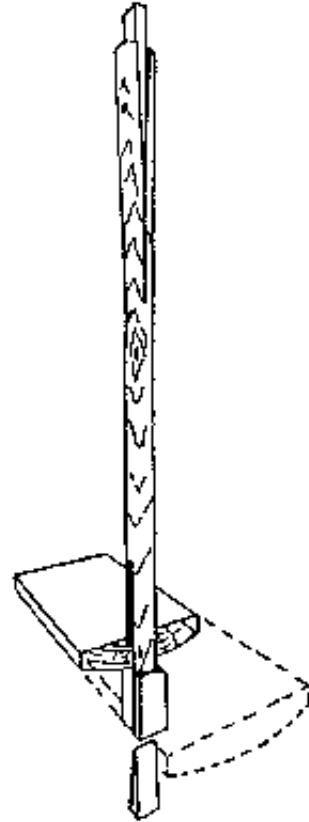
slot-and-wedge bolt

expansion-shell bolt

sliding wedge bolt

wedge-and-sleeve bolt

**Figs.: Different types of expansion bolts, Reuther.**



**Fig.: Wooden bolted support in Dayrock Mine, USE, by Woodruff**

**mechanic bolts**

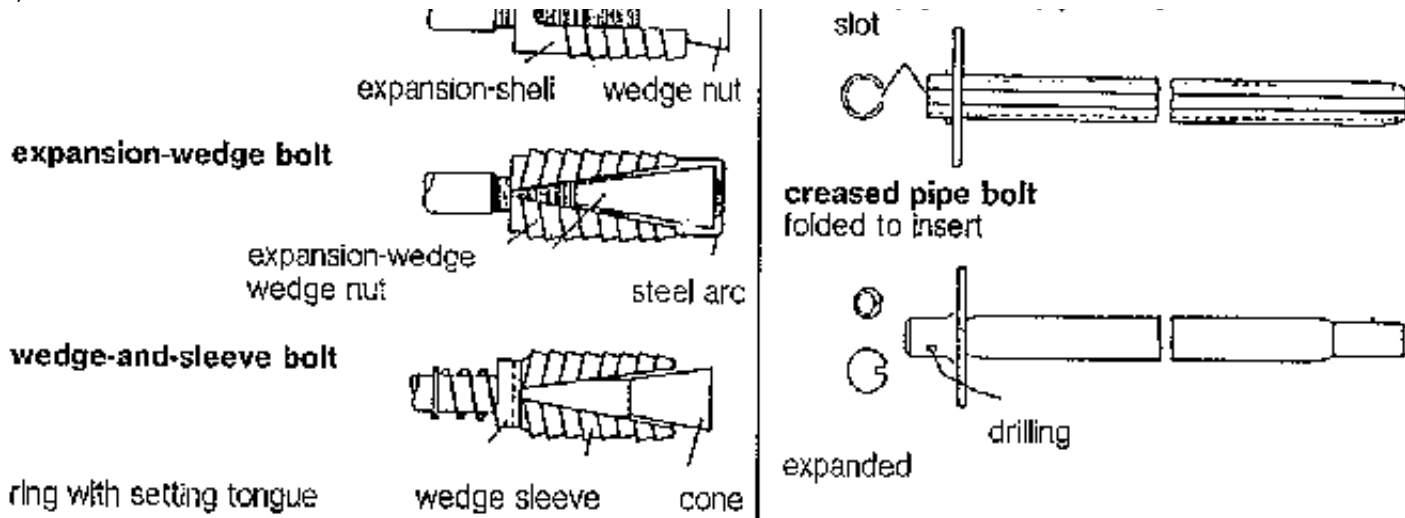
**expanding anchors**

**friction pipe bolts**

**expansion-shell bolt**



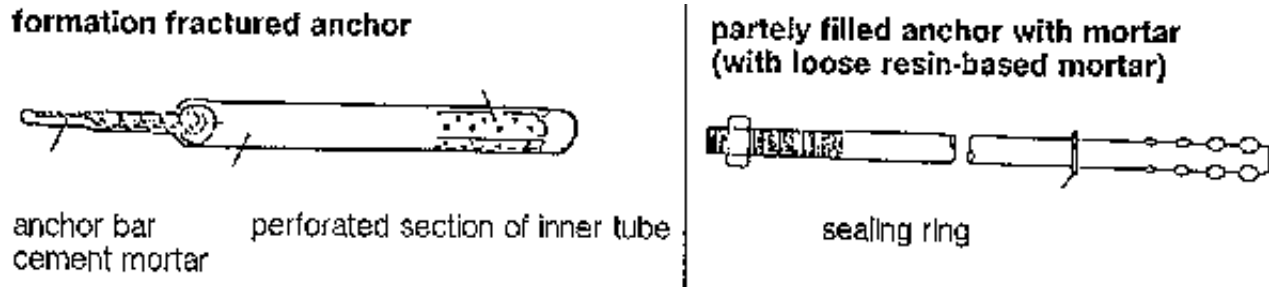
**slotted pipe bolt (split set)**



Figure

### mortar bolt

### cement mortar bolt synthetic resin-based mortar bolt



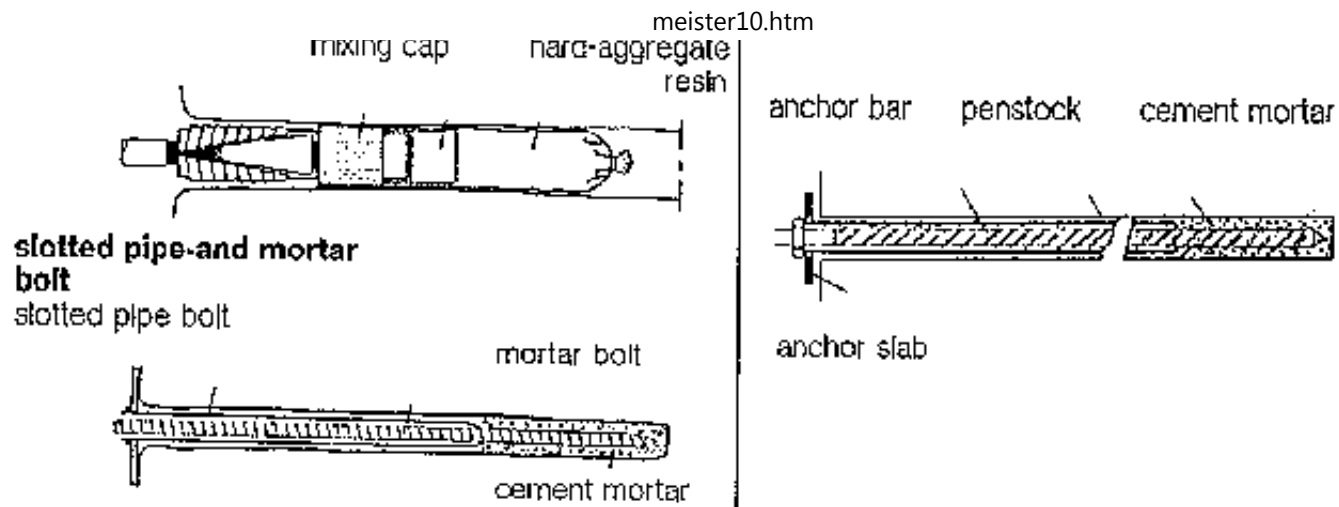
Figure

**combinations of mechanic and mortar bolt partely filled at bottom with mortar**  
**completely filled with mortar**      **expanding anchor with resin-based mortar**

expanding anchor with resin-based mortar

penstock anchor

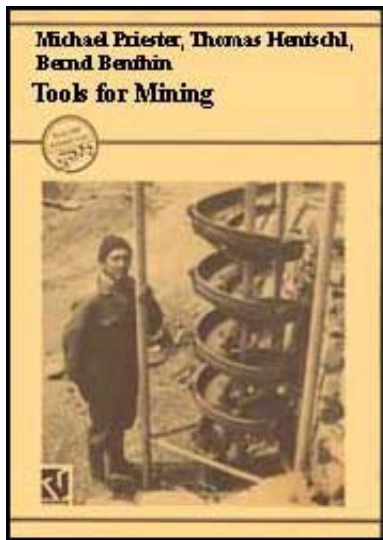




Figure

**Fig.: Different types of bolt systems, Reuther**

[Home](#) > [ar](#).[cn](#).[de](#).[en](#).[es](#).[fr](#).[id](#).[it](#).[ph](#).[po](#).[ru](#).[sw](#)



## Tools for Mining: Techniques and Processes for Small Scale Mining (GTZ, 1993, 538 p.)

### Technical Chapter 6: Lighting

#### 6.1 Underground lighting equipment

**Tools for Mining: Techniques and Processes for Small Scale Mining (GTZ, 1993,**

**538 p.)****Technical Chapter 6: Lighting****6.1 Underground lighting equipment****Deep Mining General  
Underground Mining Lighting Equipment**

germ.: Geleucht für unter Tage

span.: Iluminación para interior mine

Producer: Northern Light, CEAG, Friemann + Wolf

<b>TECHNICAL DATA:</b>	
Mode of Operation:	continuous
Throughput/Capacity:	approx. 260 - 300 l acetylene/kg CaC <sub>2</sub> for calcium carbide lamps
Technical Efficiency:	0.7 - 1.1 l C <sub>2</sub> H <sub>2</sub> /cd. for calcium carbide lamps, 10 - 17.5 W/cd. for electric lamps
Operating Materials:	
Which:	calcium carbide + water gasoline (benzene) possibly battery acid
Quantity:	approx. 250 g + 250 g/MS approx. 100 g/MS
<b>ECONOMICAL DATA:</b>	
Investment Cost:	1. calcium carbide lamp: 50 to 80 DM: 2. gasoline safety

	1. calcium carbide lamp: 20 to 30 DM, 2. gasoline safety lamp: 200 DM, 3. cap lamp: 350 to 400 DM
Operating Cost:	fuel cost for 1. and 2., Energy cost for 3.
Consequential Cost through Coupling Effects:	charging station and energy supply for electric lamps

**CONDITIONS OF APPLICATION:**

Operating Expenditures:		low  ----- ----- high
		calcium carbide lamp
Maintenance Experience:		low  ----- ----- high
		battery lamp
Location Requirements:	All open or naked-light lamps should be used only at explosion proofed locations. The danger of foul air whose oxygen content decreases perilously cannot be determined by the use of carbide lamps.	
Replaceable Equipment:	other types of lighting equipment, e.g. candles, open or naked-light oil or grease lamps	
Regional Distribution:	calcium carbide lamps worldwide, gasoline lamps in Latin America, electric cap lamps worldwide	
Environmental Impacts:		low  ----- ----- very high
Suitability for		very good  ----- ----- bad

Local

Production:

a photovoltaic battery charging station can be assembled from easily available components calcium carbide lamp

Lifespan:

very long |-----|-----|very short  
electric cap lamp

## **Bibliography, Source: Fritzsche, Company Information, Information from Mining Pits**

### **OPERATING PRINCIPLE:**

**As source of lighting for underground mining, different types of lamps are here being distinguished:**

#### **Calcium carbide lamps:**

**A calcium carbide lamp is composed of a double container, the upper vessel of which is filled with water dripping under control of a cock into the lower vessel filled with calcium carbide ( $\text{CaC}_2$ ). Through the water impact, acetylene ( $\text{C}_2\text{H}_2$ ), a burnable gas results, which is then sprayed under pressure through the burner jet. The gas is flamed at the external opening of the Jet. A reflector is installed behind the flame.**

**The bright and continually shining light is a remarkable quality of calcium carbide lamps. The consumption of calcium carbide and Water average approx. 250 g/8 hrs. The total weight of a filled lamp is approx. 1 - 1.2 kg. Calcium carbide lamps are made out of either metal (iron, steel or brass) or plastic. Beside hand lamps,**

**cap lamps are used in which an approx. 1 m long hose combines gas producing unit with jet. The gas producing unit can then be carried at the belt, whereas the Jet with reflector can be carried at the helmet Besides, there are calcium carbide lamps of smaller size that can be fixed directly at the helmet.**

### **Gasoline lamps:**

**Today, gasoline lamps are still widely distributed in Latin American mines. They are composed of a gasoline tank, a wick system, a burning chamber isolated with glass, and an open wire basket. When explosive gas develops, the wire basket avoids an outbreak of flame into the atmospheric weather by cooling flame temperature. At the same time, gas concentration of mine air in a particular weather can be determined by comparing the flame cap (aureole) with known values. Weight is approx. 1 kg.**

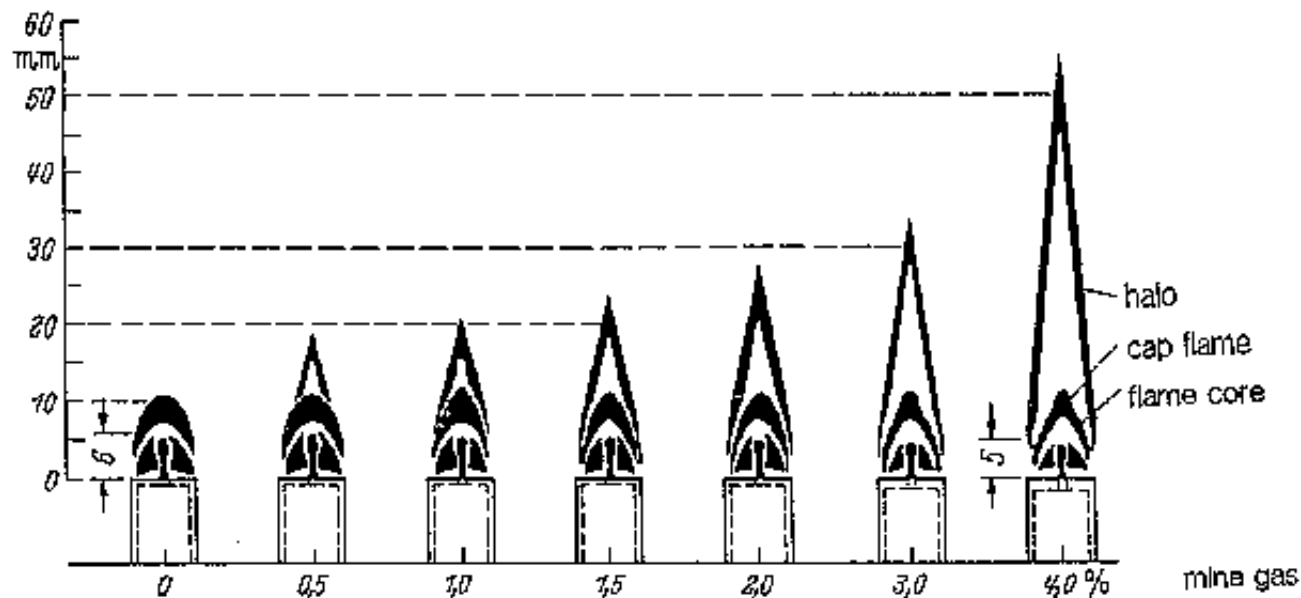
### **Electric lamps:**

**Electric cap lamps with a battery unit carried at the belt and a supply cord connected to the cap lamp weigh between 1.4 and 2 kg and are shining up to approx. 10.5 to 12 hours. The cap lamp is equipped with a double filament bulb which allows different luminescences and operating periods. The use of electric lamps is problematic where supply of electricity does not exist.**

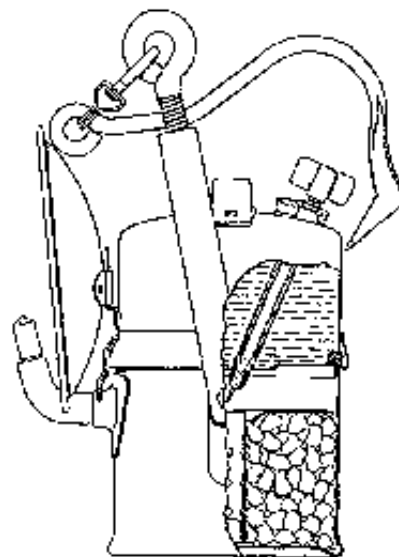
**In areas with high radiation intensity and long periods of sunshine, it is possible to charge battery lamps by photovoltaic method. Two scenarios should be taken in mind. In the first case, direct charging of batteries is done during day time per solar cells, and In the second case, charging of batteries is done by interconnected**

**storage batteries. The volt regulation of charging voltage, however, has turned out to be a problem. If it drops below 5 volts, operation period of the lamp and the amount of possible charging cycles decrease. Normally, an electric lamp can be charged and discharged up to 1000 times. Northern Light Company offers simple charging stations operated by car batteries which, most probably could be applied for charging with solar cells. The cost of a charging unit with direct current of 12 volt ranges between 100 and 120 US\$. Cost of electric cap lamps with a capacity of 7 to 14 h are approx. 350 to 400 DM.**

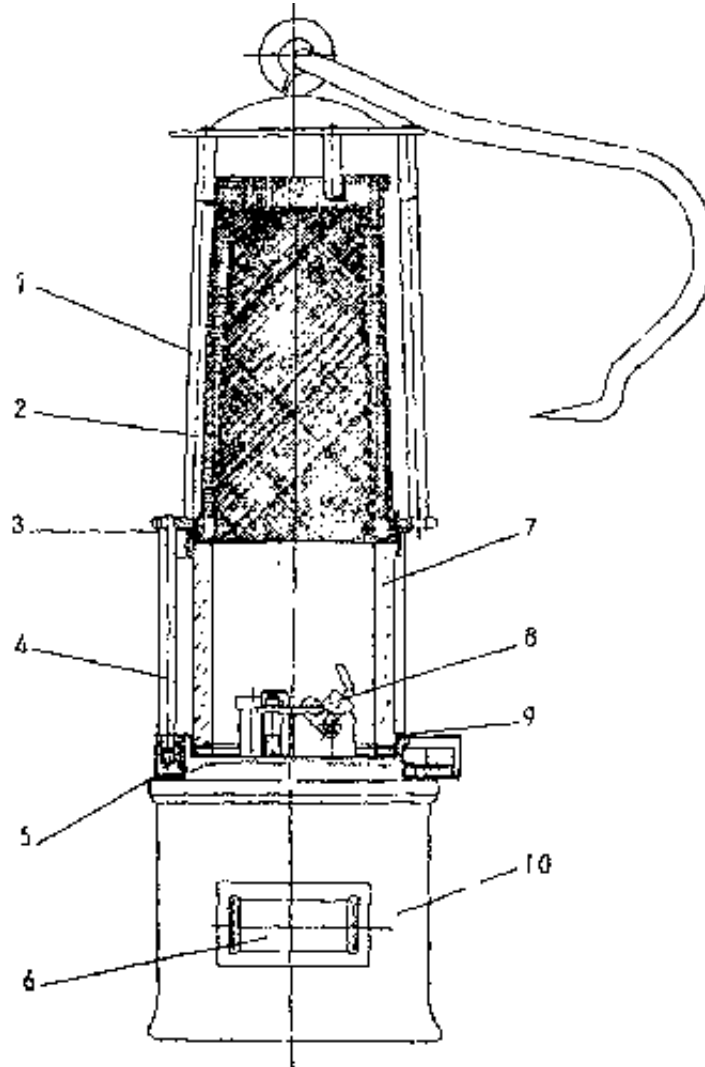
**Finally, compressed air lamps can be used for stationary lighting. Here, an alternating current generator is driven by compressed air with working pressure between 3 and 6 bar, and consumption of compressed air between 5 and 20 m<sup>3</sup>/h. As source of light, either a high-pressure mercury lamp (approx. 80W), a halogen lamp (50 - 70W) or fluorescent lamp (20 - 40 W) is used. The weight of these stationary lamps is between 10 and 15 kg.**



**Fig.: Shape and size of a gasoline lamp flame in correlation to the gas content of mine air. Source: Fritzsche**

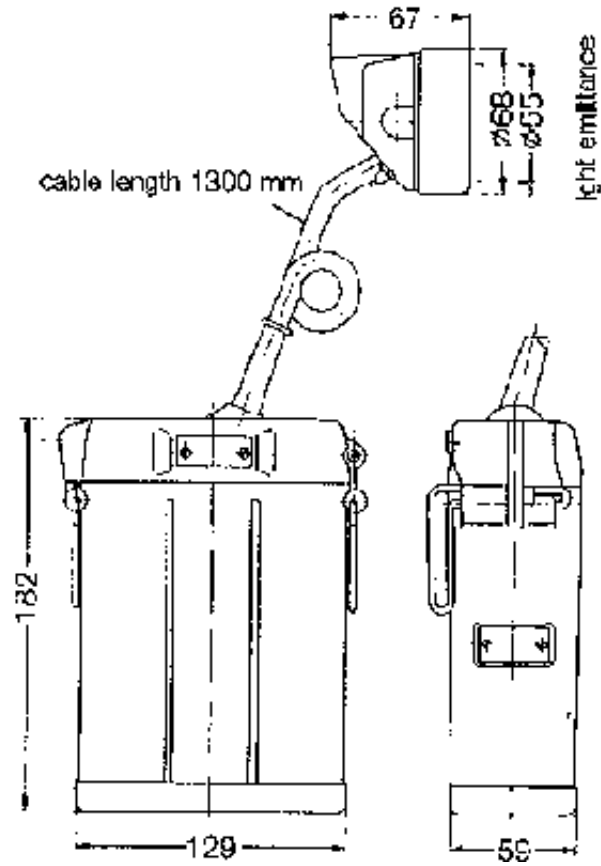


**Fig.: A calcium carbide lamp as hand carrier lamp. Above, water tank; calcium carbide container. Source: Fritzsche**

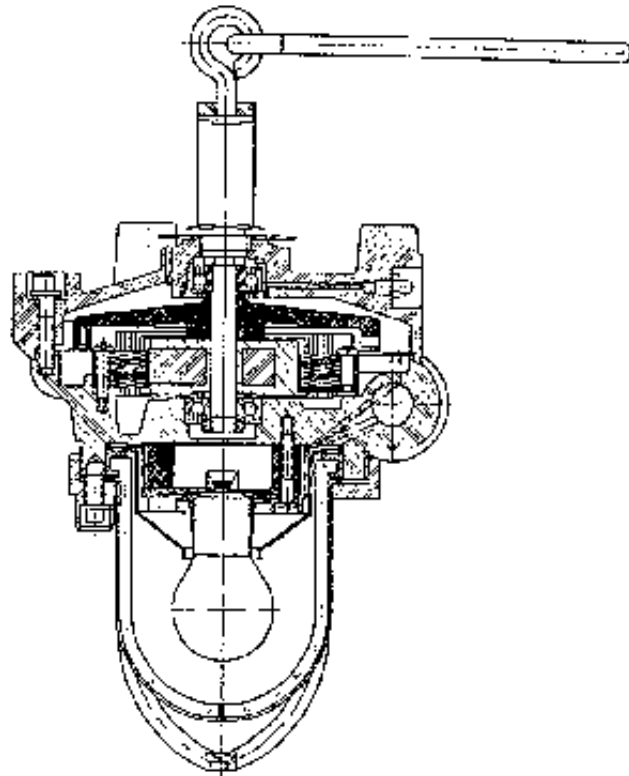


**Fig.: A gasoline lamp. 1) upper frame pannel, 2) wire baskets, 3) ring, 4) lower frame pannel, 5) magnetic lock ring, 6) number plate, 7) hard glass cylinder, 8) heat plug, 9) ring, 10) lamp vesel. Source: Fritzsche**





**Fig.: Electric cap lamp. Source: Frieman & Wolf, Company Information**



**Fig.: Cross-section of an electromagnetic compressed air lamp from CEAG. Source: Fritzsche**



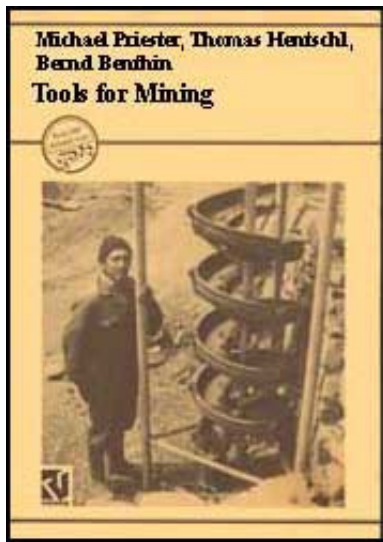
[Home](#) > [ar](#).[cn](#).[de](#).[en](#).[es](#).[fr](#).[id](#).[it](#).[ph](#).[po](#).[ru](#).[sw](#)

 **Tools for Mining: Techniques and Processes for Small Scale Mining (GTZ, 1993, 538 p.)**

➔  **Technical Chapter 7: Stopping**

 **7.1 Pneumatic jack hammer, drilling stand, jackleg**

 **7.2 Gasoline hammer drill**



- 📄 **7.3 Wedge ram**
- 📄 **7.4 Electric hammer drill with stand Y D Z**
- 📄 **7.5 Manual mining methods**
- 📄 **7.6 Pneumatic charging machine for explosives**

**Tools for Mining: Techniques and Processes for Small Scale Mining (GTZ, 1993, 538 p.)**

## **Technical Chapter 7: Stopping**

### **7.1 Pneumatic jack hammer, drilling stand, jackleg**

**Stable Rock Deep Mining, Stable Rock Open-Pit  
Underground Mining, Extraction Mining**

germ.: Pneumatischer Bohrhammer, Bohrstütze, Teleskopstütze

span.: perforadora neumatica, pie de apoyo, apoyo telescopico

Producer: Atlas Copco, Montabert, SIG, Bohler, Tamrock, Mannesmann Demag, Barrenos:  
Barrenos Sandvik SA, ADESUR, Fagersta Secoroc de Peru

## **DATOS TECNICOS:**

	middle weight lack-h	light weight lack-h	drilling stands
Weight:	22 - 29 kg	9.5 kg	13.5 kg
Length:	60 - 70 cm	approx:50 cm	800 - 1.650 mm
Piston :	58 - 90 mm	66 - 75 mm	
Stroke length:	45 - 70 mm	750 - 2.000 mm	
Single strike energy:	48 - 150 Nm		
Number of strokes:	2.200 - 3.400 min <sup>-1</sup>	3.500 min <sup>-1</sup>	
Strike capacity:	1.9 - 5.5 Kw		
R.P.M.:	160 - 240 min <sup>-1</sup>	280 min <sup>-1</sup>	
Rotation angle:	20° - 30°		
Torque:	100 - 150 Nm		
Compressed air consumption:	2.4 - 5.6 m <sup>3</sup> /min		1.4 m <sup>3</sup> /min
Drill hole :	27/41 - 34/5 mm		
Max. length of drill hole:	4 - 6.5 m		
Working pressure:	3 - 7 bar	3 - 7 bar	
Opt. working pressure:	5 - 6 bar	5.5 bar	5 - 6 bar
Rate of drilling progress:	up to 35 - 100 cm/min		

Drilling equipment:	monobloc drilling rods with male end hexagonal 22 mm (7/8 inch) × 108 mm working length of:		
	800 mm with 34 mm diameter and 3.0 kg weight		
	1600 mm with 33 mm diameter and 5.4 kg weight		
	2400 mm with 32 mm diameter and 7.9 kg weight		
	as well as lengths in-between according to the supplier		
Operating Materials:			
Which:	oil	water	$P_{\text{water}} = P_{\text{air}}^{-1}$ (bar)
Quantity:	small amount as lubricant	drilling water 3/4" supply	

### **ECONOMICAL DATE:**

Investment Cost: 2500 DM - 6000 DM jack-hammer; approx. 4000 DM/piece (used) incl. stand; drilling stand approx. 2000 - 3000 DM/piece

Consequential Cost through Coupling Effects: cost of compressed air supply

### **CONDITIONS OF APPLICATION:**

Operating Expenditures:

low |-----|-----|high

Maintenance

low |-----|-----|high

Experience:

Personnel low for handling

Requirements:

Adjoining Rock Almost without exemption, all adjoining rock can be drilled in; in cases of very soft adjoining rock, rotating or rotating-percussion drilling is applied to Requirements: that drill cuttings or debris can be removed easily.

Regional worldwide

Distribution:

Experience of

very good |-----|-----|bad

Operators:

Environmental

low |-----|-----|very high

Impacts:

Especially in cases of insufficient water or air circulation, dangerous dust pollution occurs: Silicosis

Suitability for

very good |-----|-----|bad

Local

Production:

Lifespan:

very long |-----|-----|very short

**Bibliography. Source: AC-Handbook, Stout, Fritzsche, Reuther, Roschlau**

### **WORKING PRINCIPLE:**

**The pneumatic Jack-hammer works with a centrifugal piston driven by compressed air with strokes ranging between 1,800 and 3,500 min-1 in**

**reciprocating motion and is controlled by a flutter valve. After a forward motion, when the admission strike reaches the bigger cylindrical chamber, the centrifugal piston hits the male end of the drilling rod. As the strike reverses, the male end is rotated by spinning grooves at the centrifugal piston. The rotation device with a pawl and ratchet mechanism allows rotation only in one direction. Thus, the cutting edge of drilling steel always hits another sector of the bottom hole. A central water supply leads through the centrifugal piston and male end to the flush. The flushing fluid then cools the drilling steel, removes drill cuttings or debris, and binds possible silicone dusts.**

**Drilling stands guide the percussion bit into the hole and transmit the thrust to the hammer. Such drilling stands composed of pneumatic telescoping cylinders, are fed with compressed air and fixed in an inclined position at the bottom hole. Depending upon the design, air pressure and therefore the thrust can be controlled either directly at the hammer or at the stand. A pneumatic device withdraws the hammer.**

**In drilling rise heading and vertical holes in upward designed mining, such as in steep vein ore deposits, the so called stop-hammers are used which are fixed at the stand.**

**Repeated sharpening of drilling bits or steel is very important for the drilling progress as well as for a long-lasting drilling equipment. This can be done by small compressed air driven grinding machines fixed on a tripod and equipped with a vice to fix the drilling bits. The most important standards for carbide bits, e.g., wedge angle, cutting edge curve, coefficient of wear and lateral angle are controlled by pattern. The standing time of drilling bits until they have to be**

**sharpened are in correlation to the wearing hardness of drilled rock. The following table shows after what rate of penetration sharpening becomes necessary**

<b>Kind of rock</b>	<b>Drilling meterage</b>
Sandstone	8 - 16
Sandy shale	20 - 30
Shalestone	50 - 100
Gneiss, granite	3 - 6
Older rock salt	30 - 36
Carnalitite	40 - 50
Hard salt	22 - 100

### **REMARKS:**

**Percussion and rotating-percussion hammers need high thrust.**

**It should be taken in mind to avail of small jack hammers with stand such as the TII of Montabert weighing 9.5 kg and consuming 1.4 m<sup>3</sup>/min compressed air. The low capacity could be amended by higher explosives. Additional cost for this should be taken In relation to the lower cost of compressed air supply.**

**Instead of supplying water in a costly pipe system, water can be carried by mobile tanks, in which the resuming space is filled with compressed air.**

Cost of percussion drilling: Jack hammer          approx. 50 %

Compressed air                                                  approx. 10 %



Percussion drill bit approx. 40 %

**In pneumatic drilling, the degree of efficiency with the corresponding applied energy is very low considering the losses in the production of compressed air and lies between 1 to 10%, depending upon the parameters used. Aside from losses during the production and distribution of compressed air, losses also occur during transmission of power in percussion, sound insulation, friction at the drilling hole wall as well as during reflexion of percussion energy into the drilling rod.**

**A further source of losses is in the connection of drilling rod, bit, and possibly of extension rods. Power loss of each connection is approx. 5 %. To avoid such losses, using monobloc drilling machines and avoiding extension rods can be done.**

**Since jack-hammers are usually delivered with a left turning rotation, they should be ordered with a right turning rotation for anchor setting, so that the anchor nut can be tightened with the hammer which is equipped with a special device.**

**The thrust which needs a medium-sized hand hammer, ranges between about 60 to 120 kg. Of this, only an average of approx. 5 kg can be done by the hammer manually or without any mechanical aid. Heavier dead weights lower the backward thrust of hand-held percussion drilling machines.**

**In order to be able to distribute the needed high thrust, an optimal angle of attack of the stand has to be selected. It should be always smaller than 40.**

**After a distance of 5 - 10 cm and starting with a low thrust, more power can then be applied.**

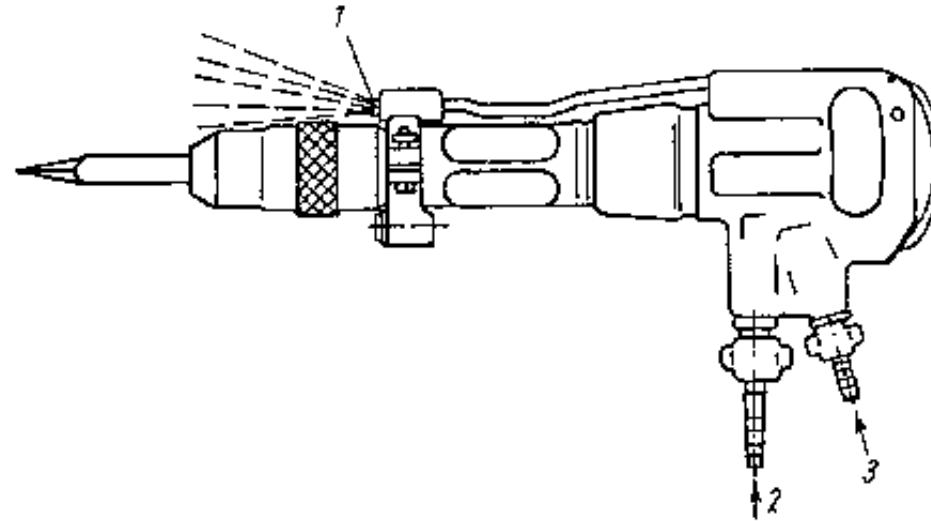
**Instead of a pneumatic drilling stand, the mexican method and a system comprising of two ladders and one slide board can be used for light weight hammers.**

**Before assembly of the drilling system begins, hoses have to be blown out in order to avoid water hammer destroying the drilling machine.**

**Pneumatic mining hammers are used for minerals that don't require drilling and blasting due to their low degree of hardness. Only a forward and backward motion is transmitted by the centrifugal piston to the striking bit. Rotation and flushing of water are excluded.**

### **SUITABILITY FOR SMALL-SCALE MINING:**

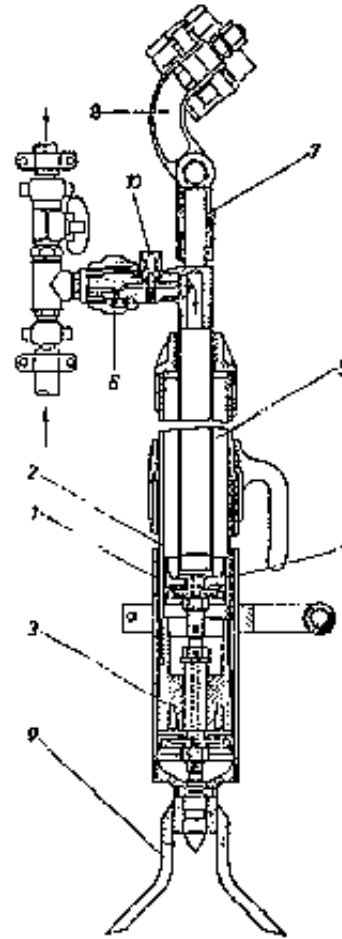
**Pneumatic jack hammers are suitable for all drilling purposes in underground and open-pit mining due to their low weight and high stability, however, they need expensive power supply.**



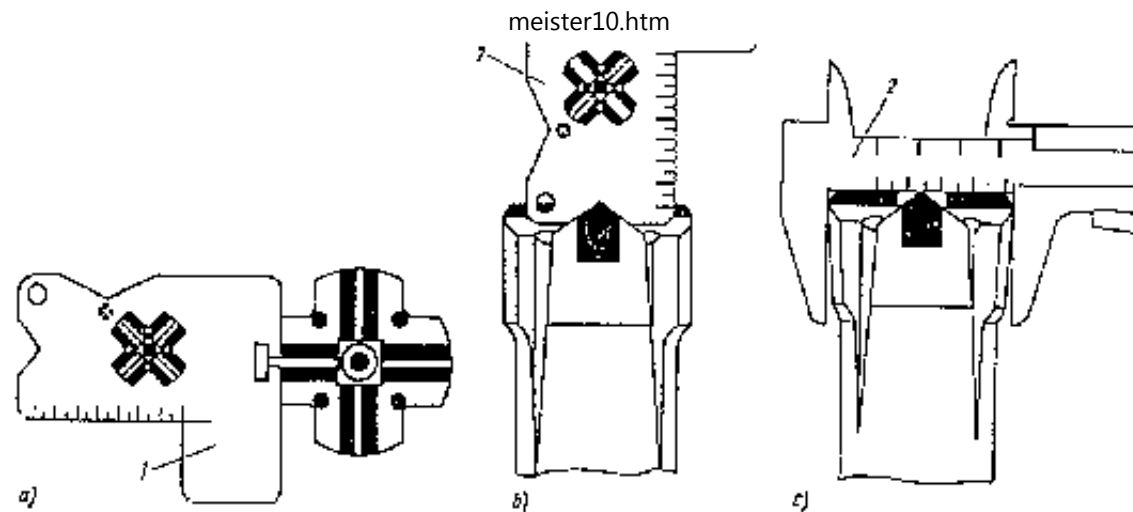
**Fig.: Jack-Hammer with water jet, 1) jet, 2) feed line for compressed air, 3) feed line for water supply. Source: Roschlau.**

### **Multipiers to determine the air consumption of rock and drills at various altitudes**

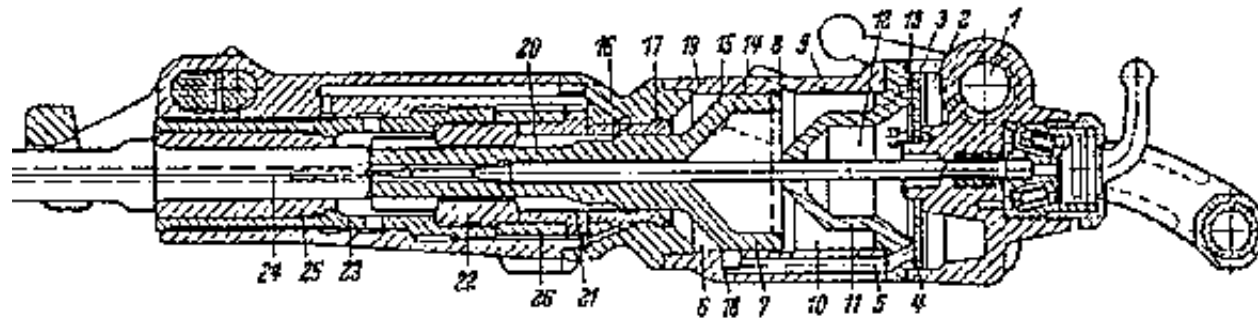
	<b>Number of drills</b>					
<b>Altitude</b>	<b>1</b>	<b>2</b>	<b>3</b>	<b>4</b>	<b>5</b>	<b>6</b>
	<b>Multipliers</b>					
ft.						
0	1.0	0.9	0.9	0.85	0.82	0.8
1.000	1.0	0.95	0.93	0.87	0.84	0.83
2.000	1.1	0.97	0.95	0.92	0.88	0.86
3.000	1.1	1.0	1.0	0.95	0.92	0.9
4.000	1.1	1.05	1.03	0.97	0.94	0.93
5.000	1.2	1.1	1.07	1.02	0.98	0.96



**Fig.: A drilling stand. Source: Fritzsche**



**Fig.: Quality control of drilling bit sharpening, a) wearing control, b) control of wedge angle, c) control of open angle curve. Source: Roschlau.**

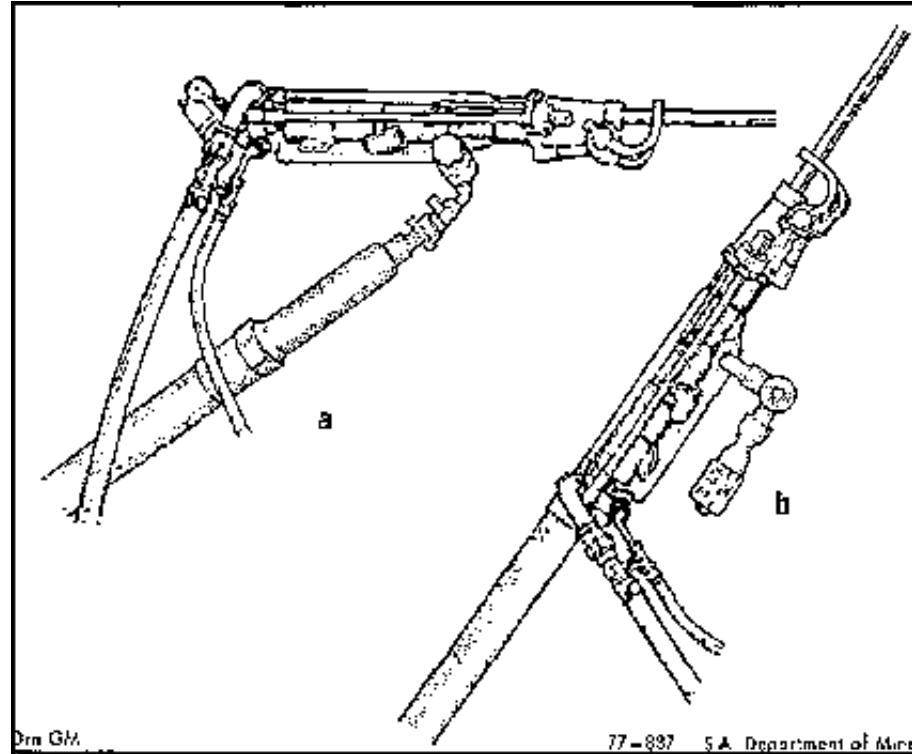


**Fig.: Cross-section of a jack-hammer. Source: Reuther.**

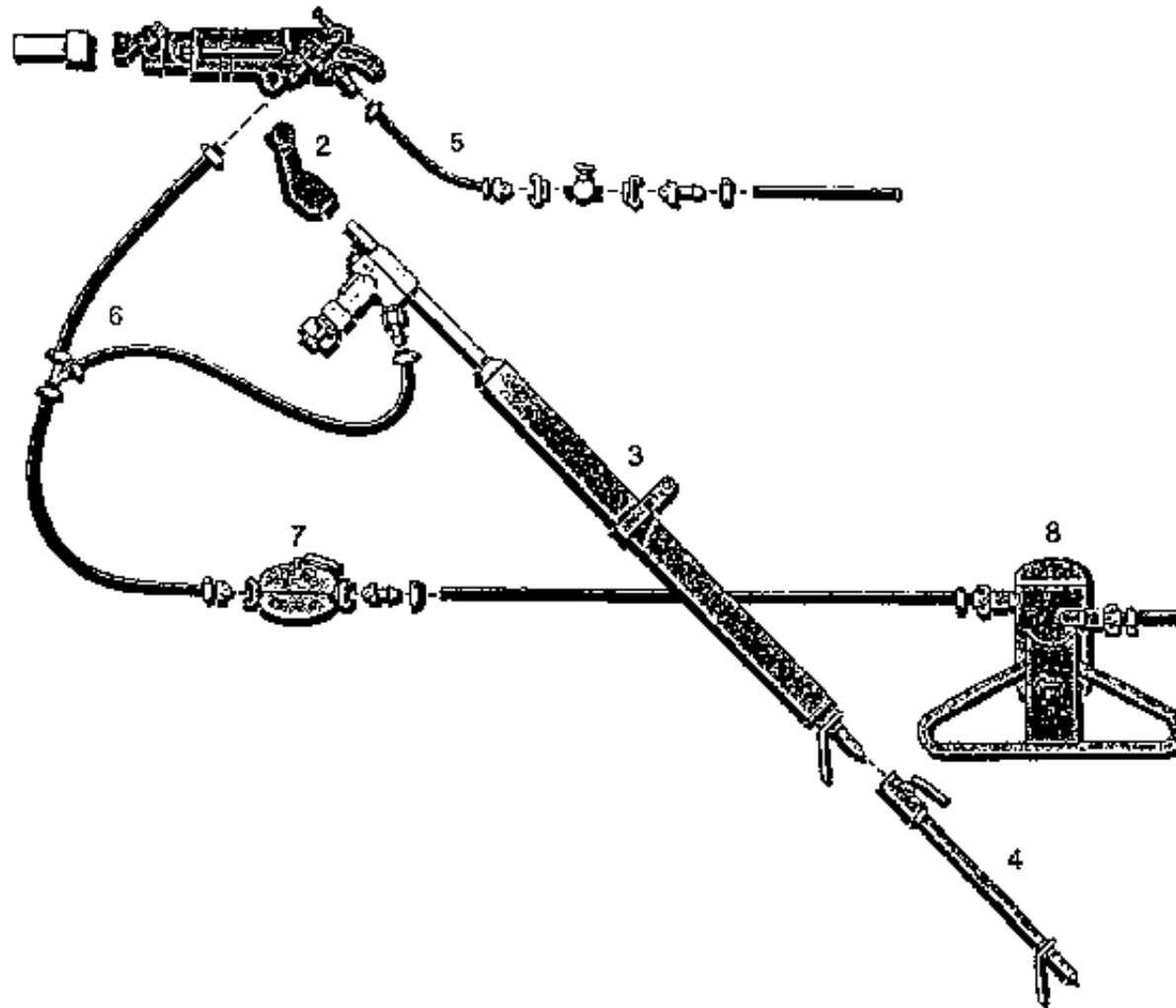
- |                                       |                          |                  |
|---------------------------------------|--------------------------|------------------|
| 1. compressed air adapter             | 10. behind cylinder room | 18. canal        |
| 2. free room inside the cylinder head | 11. cover                | 19. cylinder     |
| 3. valve chatter                      | 12. cover room           | 20. piston shaft |
| 4,5. canal                            | 13. canal                | 21. twist nut    |
| 6. front cylinder room                | 14. exhaust aris         | 22. leader nut   |
| 7. percussion piston                  | 15. front piston aris    | 23. drill sleeve |

- 8. behind piston arris
- 9. exhaust arris

- 16. arris at the piston shaft
- 17. wearing box
- 24. shank
- 25. drill sleeve
- 26. ratchet wheel



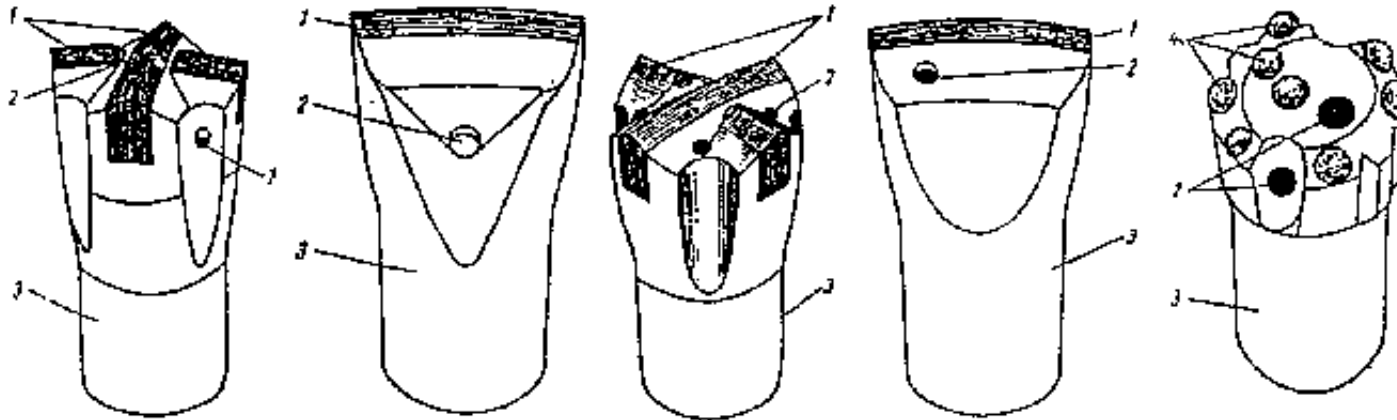
**Fig.: Design of a jack-hammer with stand, a) for thrust, b) stop-hammer. Source: Armstrong.**



**Fig.: Composition of a complete drilling system for pneumatic drilling with stand.  
Source: Atlas Copco Company Information.**

- 1. jack-hammer**
- 2. coupling**
- 3. stand**
- 4. extension for stand**

5. flush water hoses with claw coupling
6. compressed air hoses with claw coupling
7. oil lubricator
8. water separator



**Fig.: Drilling bits for percussion drilling, 1) hard metal tip 2) flush hole 3) bit neck 4) hard metal pins. Source: Roschlau**

## 7.2 Gasoline hammer drill

**Stable Rock Deep Mining Stable Rock Open-Pit  
Underground Mining Drilling Mining**

germ.: Benzingetriebener Bohrhammer, "Cobra", "Pionjar", Brennkrafthammer

span.: motoperforadora, camera de combustion

Producer: Atlas Copco

### **TECHNICAL DATA:**

Dimensions:

75 × 50 × 35 cm



	HWL		
Weight:	25 or 23 kg /26 kg		
Extent of Mechanization:	fully mechanized		
Form of Driving Energy:	eternal combustion engine 185 cm <sup>3</sup> /2500-2700 R.P.M.		
Mode of Operation:	semi-continuous		
Throughput/Capacity:	250 - 300 mm/min thrust in granite		
Operating Materials:		90/100 Pionjar:	
Which:	gasoline	80/100 octane, also lead free	oil/SAE 40
Quantity:	approx. 1.5 I/h	1: 12 (8 %) pionjar	1: 20 (5 %)
<b><u>ECONOMICAL DATA:</u></b>			
Investment Cost:	approx. 5000 DM		
Operating Cost:	high cost of fuel		
Consequential Cost through Coupling Effects:	special sucking ventilation for underground operations is necessary		

### **CONDITIONS OF APPLICATION:**

Operating  
Expenditures:

low |-----|-----| high

Maintenance

low |

| high

Maintenance

Experience:

Mining

Gasoline driven jack-hammer can only drill in horizontal or downward

Requirements:

approach, but in exceptional cases, up to 45° upward. The reasons for that is the direct coupling of engine and carburetor. Advantages are mining methods which lead downward and so allow bench drilling.

Replaceable

compressed air hammer drill

Equipment

Availability of

import is necessary

Technique:

Regional

so far unknown in small-scale mining in Latin America

Distribution:

Experience of

very good |-----|-----| bad

Operators:

Environmental

low |-----|-----| very high

Impacts:

contamination of the environment with exhaust and used oil

Suitability for

very good |-----|-----| bad

Local

Production:

Lifespan:

very long |-----| very short

**Bibliography, Source: AC-Handbook**

**OPERATING PRINCIPLE:**

**Gasoline hammer drills operate with a twin-piston internal combustion engine. One part of the piston is a centrifugal piston which functions as a striking piston, whereas the other part is used for the transmission of drilling rods and compression air in order to blow clean the drilling hole.**

### **AREAS OF APPLICATION:**

**Drilling of downward and possibly horizontally aligned blasting holes of underground and open-pit mining with hard or solid rock.**

### **REMARKS:**

**Grinding machines with bending shaft and centrifugal pump are available as auxiliary equipment to drive gasoline fed hammer drills.**

**Very problematic are the following:**

- somewhat heavy weight is specially when working at or near a hanging wall**
- exhaust with high CO content. Special ventilation is absolutely necessary. Long hose for exhaust lowers efficiency**
- reduced efficiency of up to 50 % in high altitudes of Latin American small-scale mines**
- pulling of drill rods without extra equipment is often difficult or impossible**

**- drilling is dry resulting to enormous dust development.**

**General internal combustion engines are dangerous in underground mines and need special ventilation due to high CO-content in the exhaust. The use of such machines is not advisable especially in small-scale underground mining which often lack sufficient ventilation. The advantage of being independent from an underground power supply system is being neutralized by the expenses for a special sucking ventilation.**

**There is a high danger of silicosis development when working in hard or solid rock where quartz stones are drilled.**

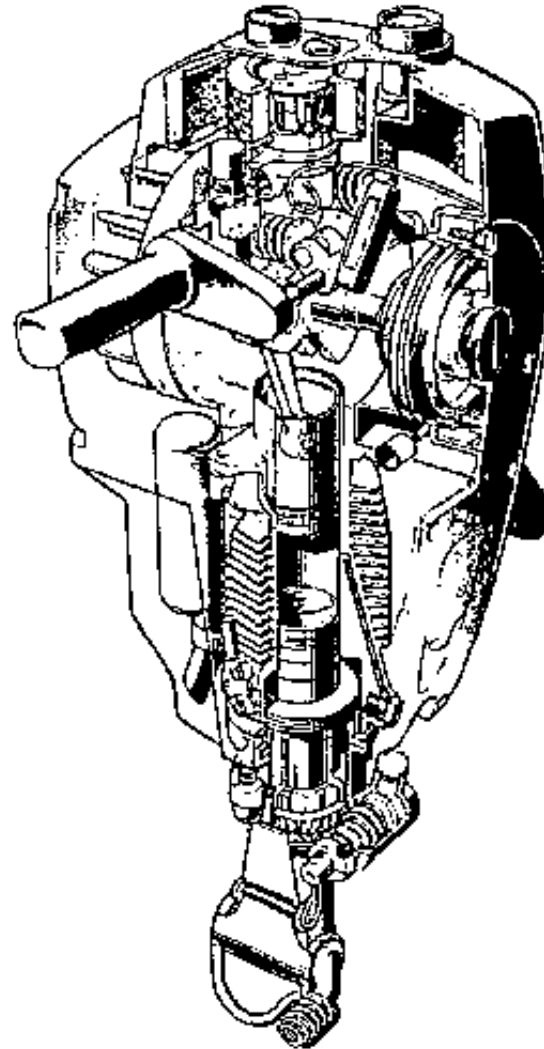
**Pionjar is more suitable for high altitudes in developing countries than the Cobra. On one hand, the needle carburetor can be adjusted to a higher altitude, on the other hand, its design is simpler than the diaphragm carburetor of the Cobra**

**Already used in Afghanistan in blasting short tunnels for storage rooms. There they were used with slides on stands.**

**Analogous to pneumatic mining hammer, gasoline driven mining hammers are available for easily exploitable minerals such as coal.**

### **SUITABILITY FOR SMALL-SCALE MINING:**

**Not suitable for application in running underground operations due to environmental and safety problems. Application or use seems right only for special works without compressed air infrastructure and in open-pit mining for hard sediments.**



**Fig.: Cross-sectional sketch of a Cobra gasoline hammer. Source: Atlas Copco company Information**

### **7.3 Wedge ram**

**Stable Rock Deep Mining Stable Rock Open-Pit  
Underground Mining Extraction Mining**

germ.: Rammkeil, Gesteinsbrecher nach Francois

span.: rompedor de rocas, segun Fran,cois

<b>TECHNICAL DATA:</b>	
Dimensions:	length about 4 m
Weight:	approx. 30 kg + 45 kg driving ram
Extent of Mechanization:	not mechanized
Form of Driving Energy:	manual
Mode of Operation:	intermittent
Operating Materials:	none
<b>ECONOMICAL DATA:</b>	
Investment Cost:	self-made: 250 - 500 DM
Operating Cost:	exclusively labor cost

### **CONDITIONS OF APPLICATION:**

Operating

low |-----|-----| high

Expenditures:

Maintenance

low |-----|-----| high

Experience:

Mining

no breakings can be cut by wedge ramming, which means full work is not

Requirements: possible with wedge ram

Replaceable

blasting explosives

**Equipment:**

Regional Distribution: mostly replaced by blasting explosives, application where ram or blast effects have to be controlled, e.g., in natural stone mining, marble quarries etc.

**Environmental Impacts:**

low |-----|-----| very high

**Suitability for Local Production:**

very good |-----|-----| bad

**Under what Conditions:**

good metal manufacture with good welding technique and can operate with tenacious steel

**Lifespan:**

very long |-----|-----| very short

**Bibliography, Source: Lengemann****OPERATING PRINCIPLE:**

**Four springs are inserted into the drilling hole. The wedge which leads to a quadratic area for the ram is then being rammed into the remaining space. The four rollers being integrated into the ram lower the friction. The ram is pulled with a pulling rope over a pulley against the inset.**

**AREAS OF APPLICATION:**

**Extraction of coarse debris in hand tramming works in the mine heading.  
Application in mining of natural stones.**

**REMARKS:**

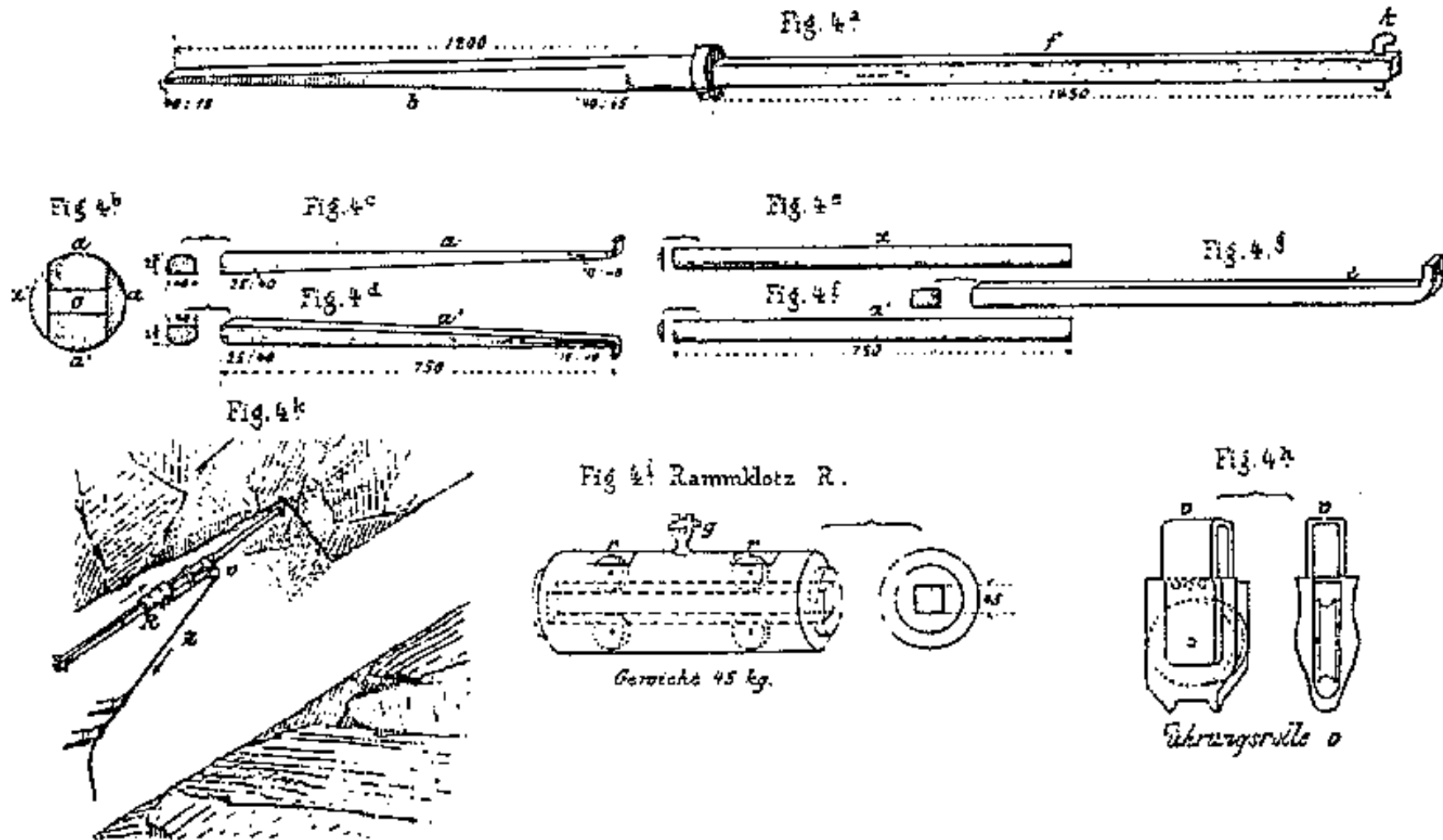
**Due to insufficient crushing, problems in transporting coarse debris occur. The use or application of wedge ram is right in friable bedrock or in open-pit mining where possibly large blocs have to be extracted ( e.g. marble).**

**Cut or sawed marble yield higher prices than blasted marble for sculpting purposes. The latter contains fine micro splits which can lead to a sudden breakage of other parts during treatment.**

**SUITABILITY FOR SMALL-SCALE MINING:**

**For underground ore mining, this technique has only a limited application but it is quite suitable for open-pit mining.**





**Fig.: Design and work principle of a wedge ram. Source: Lengemann Fig. 4: Wedge ram by A and J. Francois. The 4 springs a, a', a, a', are being inserted into the drill hole and if necessary the spring e in-between a and a'. In the remaining space o (compare fig. 4b) the wedge b is rammed In that has backward a quadratic guide f for the quadratic hole of 45 mm width of ram R. The 4 roles r that are let in the latter are minimizing friction. The shackle 9 serves to fix pulling rope Z through**

**pulley v (compare fig. 4b). The ram can also being moved by a tin iron rod with handle, which is fixed at shackle g. K locking pin to limit the ram lifting.**

## **7.4 Electric hammer drill with stand Y D Z**

### **Stable Rock Deep Mining, Stable Rock Open-Pit Underground Mining Extraction Mining**

germ.: Elektrischer Bohrhammer auf Stutze

span.: perforadora electrica sobre apoyo

Producer: China Mining Technology Consultant Centre

#### **TECHNICAL DATA:**

Dimensions: 610 × 335 × 220 mm + stand

Weight: 30 kg + drilling rod, supply cord, water hose

Extent of Mechanization: fully mechanized

Driving Output 2 kw

Form of Driving Energy: electric: 3 phases, 127 V, 15,7 A, 50 Hz

Mode of Operation: semi-continuous

Throughput/Capacity: > 3 kg × m hammer impulse, > 150 kg × cm rotation impulse, 2640 min<sup>-1</sup>, holes up to 4 m 34 - 43 mm, drilling rods 22 or 25 mm, hexagonal with central flush

Technical Efficiency: 65 %

**ECONOMICAL DATA:**

Consequential Cost through Coupling Effects: power supply

**CONDITIONS OF APPLICATION:**

Operating Expenditures: low |-----|-----| high  
 Maintenance Experience: low |-----|-----|high  
 Location Requirements: none, machine is explosion proofed  
 Mining Requirements: power supply needed up to the mine heading  
 Repleaceable Equipment pneumatic hammer drills  
 Regional Distribution: China  
 Environmental Impacts: low |-----|-----| very high  
 low oil consumption in comparison with compressed air  
 Suitability for  
 Local Production: very good |-----|-----| bad  
 Lifespan: very long |-----|-----| very short

**Bibliography, Source: Company information****OPERATING PRINCIPLE:**

**With 3-phases-alternating current driven percussion hammer drill with stand and external water coolant and flush.**

**AREAS OF APPLICATION:**

**Drilling in heading and winning of mechanized small-scale mines with power supply for all rock types.**

**REMARKS:**

**Efficiency of electrical systems is significantly higher than that of pneumatic systems, which means, it requires less input for primary energy.**

**The performance of electrical systems is dependent of external air, which means efficient operation can be done also in greater heights.**

**The environmental impact (oil suspension, noise pollution, etc.) of electric hammer drills is comparably low or not existing at all.**

**In the case of lifespan and maintenance, doubts still remain as there has been no experience on these yet. Particularly for drilling equipment, small-scale mining maintains high standards for stability and lifespan. So far, pneumatic systems rank first under these aspects.**

**Besides electric hammer drills, electric mining hammers ( without rotation and flush) for cutting bits are also being marketed. They are used mainly in coal mining.**

**Electric Systems are only advisable if transmission from a public power supply net is available. Disadvantages of an electric mechanization in underground mining are the results of:**

- sensitive technique especially of the percussion device of hammer drills**

- **safety problems**
- **low marketability.**

## **SUITABILITY FOR SMALL-SCALE MINING:**

**The electric hammer should be considered as an alternative to pneumatic systems in small mines with only few working places. Its low Input of primary energy needed and environmental soundness are marks of the electric hammer, however, high cost of installation of electric power supply should be considered in the case that it is not available.**

### **7.5 Manual mining methods**

#### **Deep Mining in Soft Rock Underground Mining Extraction**

germ.: Manuelle Gewinnungstechniken

span.: tecnicas de explotacion manual

<b>TECHNICAL DATA:</b>	
Extent of Mechanization:	not mechanized
Form of Driving Energy:	manual
Mode of Operation:	intermittent
Throughput/Capacity:	capacity is very low compared with winning capacity of fully mechanized working units
Operating Materials:	none

Operating Materials:	none
<b>ECONOMICAL DATA:</b>	
Investment Cost:	low
Operating Cost:	predominantly labor cost, additionally cost of wearing parts (drill bits, drill steels)
Consequential Cost through Coupling Effects:	none

### **CONDITIONS OF APPLICATION:**

Operating Expenditures: low |-----|-----| high

Maintenance Experience: low |-----|-----| high

Ore Requirements: soft rock

Adjoining Rock Requirements: most favorable deposits are those with stable adjoining rock and comparably soft or loose material to be mined, e.g., that of some oxidation zones, coal seams, etc.

Replaceable Equipment: mechanized mining

Regional Distribution: worldwide

Experience of Operators: very good |-----|-----| bad

extremely high physical stress wherever exploitation of hard raw materials

extremely high physical stress, wherever exploitation of hard raw materials is required

Environmental  
Impacts:

low |-----|-----| very high

Suitability for  
Local

very good |-----|-----| bad

Production:

Under what Conditions: hammers, picks, chisels bits, eventually drill rods can be produced by local small scale industry, and probably simple hand drilling machines, in metal manufactures

## **Bibliography, Source: Fritzeche, Roschlau**

### **OPERATING PRINCIPLE:**

**Manual mining techniques are mostly applied in soft rock in underground and open-pit mining. To be distinguished are the following:**

**1. Manual working with pick and shovel. Predominantly in coal mining but also in extraction of ore from residual zones and consolidated loose material, such as in gold mining wherein extracted ore is cut with a pick.**

**The miner often uses the method of "undermining" by drifting a split into the wall face near the bottom and cutting upward by making use of gravity.**

**First and foremost, this technique is common in an artisan coal mining.**

**2. Manual drilling by rotation and blasting. In small-scale mining more solid**

**materials can be cut with manual rotating drills (such as Lisbeths hand rotary drill) and by blasting. These include such materials as coal, salt, sulfa, shale, gypsum, etc The drilling machines are hand driven, have a manual thrust, are guided by a stand braced at the drilling hole and operate with a percussion drill but without a flush. An auger bit removes the drill cut of the hole. The objective of any drilling is to adjust the thrust so that the chips are cut off with the maximum size in order to guaranty the lowest possible work effort for cutting. The lifespan of hand drill drilling rod is very high and lies within a minimum of 3,000 m. Attached to the drilling rods are exchangeable symmetrical or asymmetrical slot-and-cut bits with hard facing. The time duration between each sharpening is equivalent to 30 - 150 meterage, the total lifespan after about 15 - 25 sharpenings is approx. 2,000 meterage. The stands for hand driven drills are comprised of a telescoping double-tube frame which is braced with an adjusting screw at the fixing point and to the hanging wall.**

**3. Hard rock materials can be broken by manual percussion drilling of blasting holes and by blasting. This is a technique which is widely applied up to now in small-scale mining for high quality ore, such as gold ore, tungsten, tin and precious stones. The advancing distance per round here is shorter than in mechanized mining and is on the average of about 30 cm. A main problem is the discharging of drill cuttings or debris from the drilling holes. Most suitable therefore are small scrapers with flattened bended end. They are placed into the drill hole to scrap out drill cuttings.**

**Here, productivity is seen as the volume of cuttings per shift and is about 3 - 5 times as high as that of the hammer and chisel or manual minining without blasting.**



## AREAS OF APPLICATION:

Manual winning or extraction of raw materials in underground and open-pit mining, mainly for soft and medium soft rock.

## SUITABILITY FOR SMALL-SCALE MINING:

Manual extraction In small-scale mines of the developing countries is important where no mechanization of underground work is being planned.

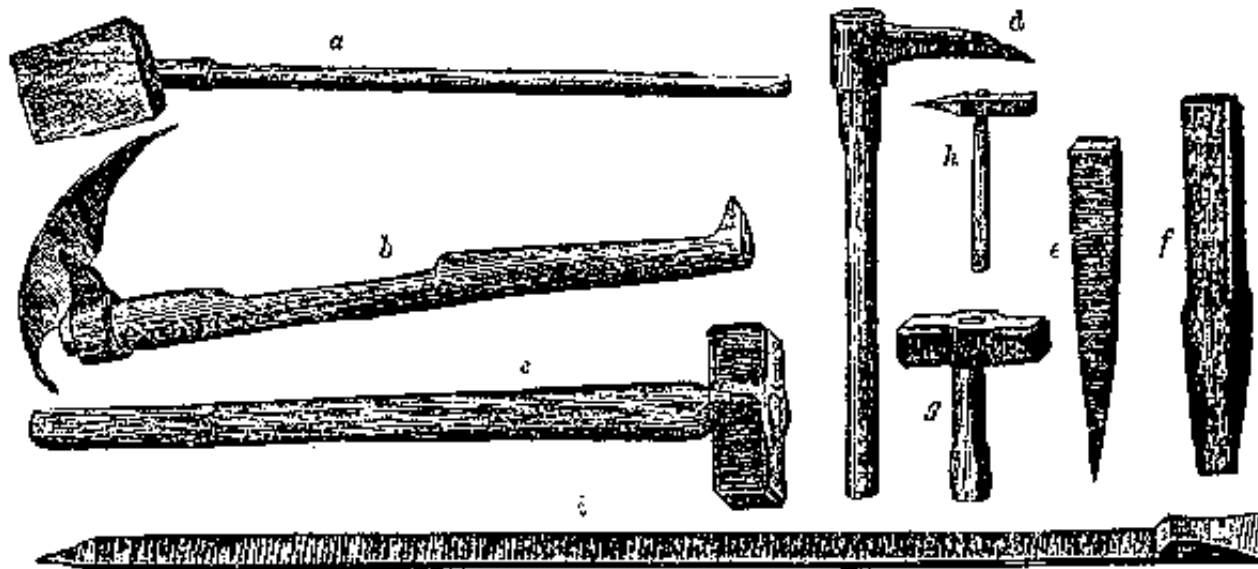
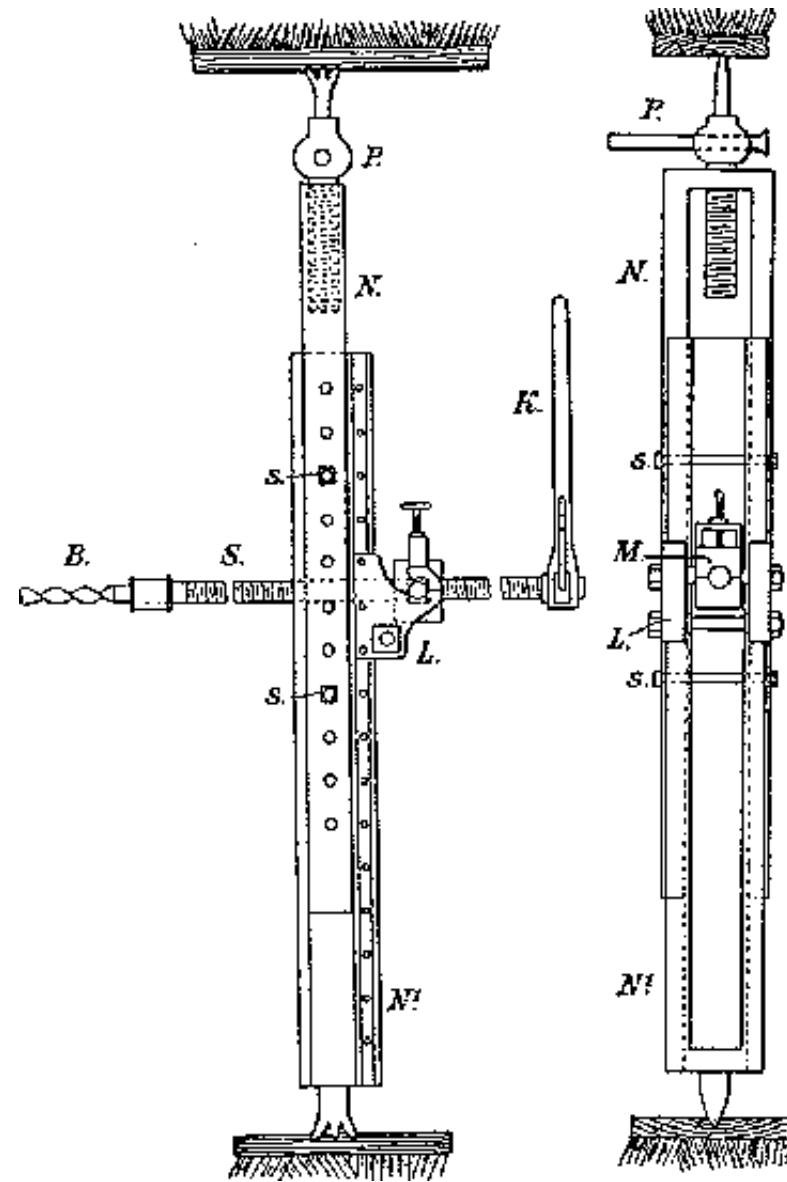
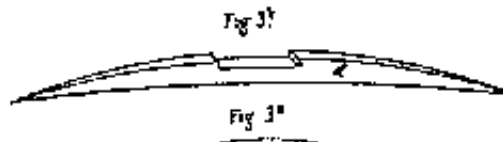
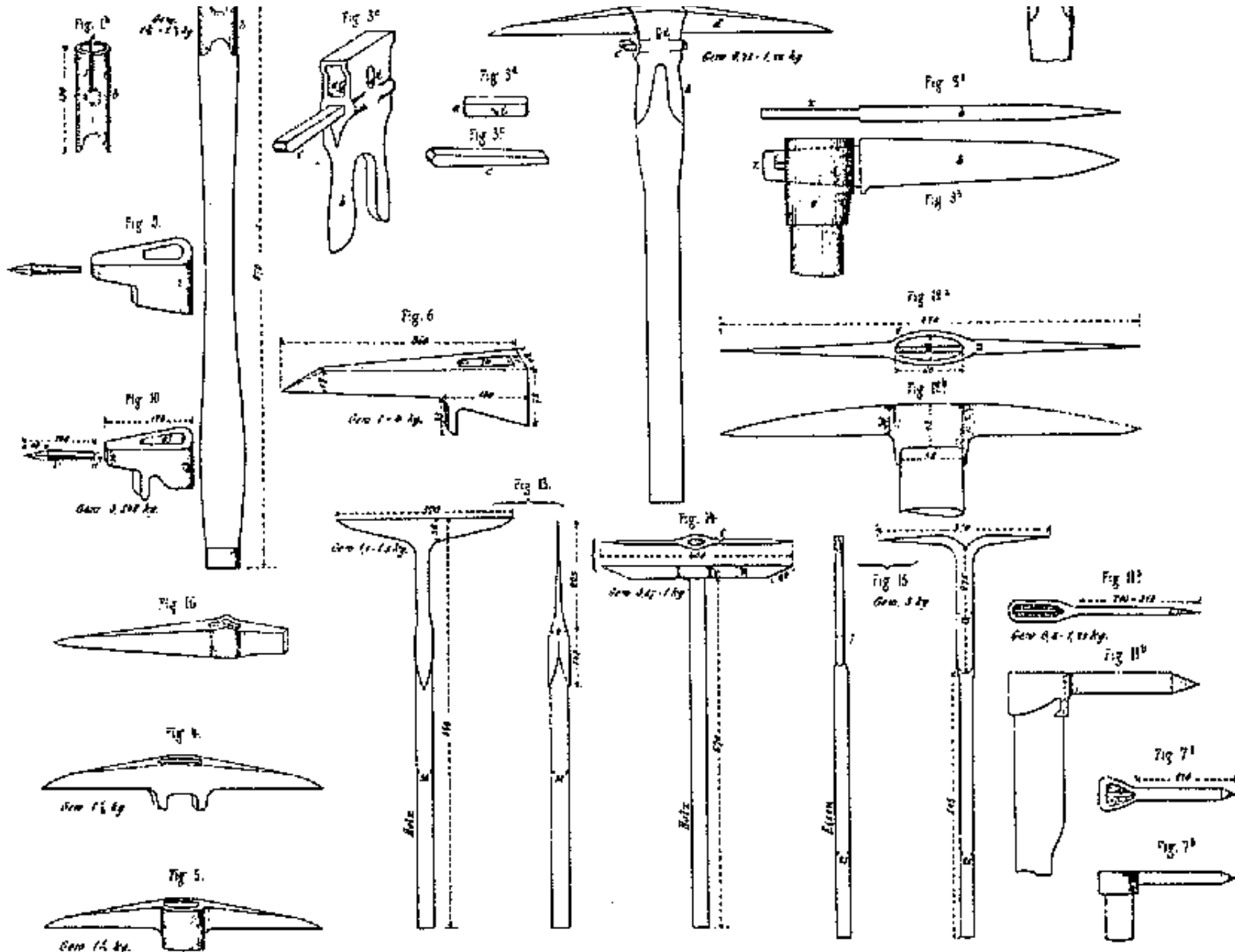


Fig.: Mining tools. Source: Trptow.



**Fig.: A Lisbeth hand drill. Source: Treptow.**





## Fig.: Mining tools. Source: Lengemann

**Fig. 1 - 5 double-pointed picks, fig. 1 - 3 with removable blades and fig. 1 - 2 retaining flanch on helmet by using fig. 3 a wedge following the Acmes method. Fig. 6 and 7 simple pick. Fig. 8 simple pick with removable blade. Fig. 9 and 10 pick with detachable bits. Fig. 11 cutting pick. Fig. 12 double-pointed cutting pick. Fig. 13 - 15 Belgium cutting pick. Fig. 16 acute hammer.**

### 7.6 Pneumatic charging machine for explosives

#### Deep Mining General Open-Pit Mining General Underground Mining Extraction

germ.: Pneumatische Sprengstoffpumpe, Injektorpumpe

span.: bomba neumatica para explosivos, bomba inyectora

<b>TECHNICAL DATA:</b>	
Dimensions:	70 × 70 × 100 cm LWH including tank for blasting explosives
Weight:	approx. 50 kg
Extent of Mechanization:	partly mechanized
Form of Driving Energy.	pneumatic
Mode of Operation:	semi-continuous
Throughput/Capacity:	several 100 kg explosives/hour
<b>ECONOMICAL DATA:</b>	

Investment Cost:	not known
Operating Cost:	cost of compressed air and labor
Consequential Cost through Coupling Effects:	cost of supply of compressed air

### **CONDITIONS OF APPLICATION:**

Operating Expenditures:		low  ----- -----  high
Maintenance Experience:		low  ----- -----  high
Deposit Requirements:	in coal deposits with methane emission and, in all cases where electric detonation is used, non static hoses have to be applied	
Regional Distribution:	wherever prilled explosives are being used	
Experience of Operators:		very good  ----- -----  bad
Environmental Impacts:		low  ----- -----  very high
Suitability for Local Production:	mining air pollution by gas and dust blown out by explosives	very good  ----- -----  bad
Under what Conditions:	good metal manufacture with lathe	
Life span:		very long  ----- -----  very short

## **Bibliography, Source: Roschlau**

### **OPERATING PRINCIPLE:**

**Pneumatic charging machines serve as filling device to insert blasting explosives into the drill hole. Fed by compressed air line or tank, compressed air flows through a venturi Jet. The smaller the cross-section of the Jet is, the higher is the speed of streaming air. In or shortly before the Jet becomes narrowest, granulated explosive is poured into the air stream. The explosive is then transported through a conveying hose into the drill hole.**

**Another way is to fill a storage tank with explosives and compressed air and discharge at the bottom of the tank. This conveying system is more careful, causes less abrasion and little fine dust particles of the explosive.**

**In non-mechanized mines, cartridged blasting explosive can be charged with a tamping stick.**

### **AREAS OF APPLICATION:**

**Charging of prilled explosives in blasting drill holes by using compressed air.**

### **REMARKS:**

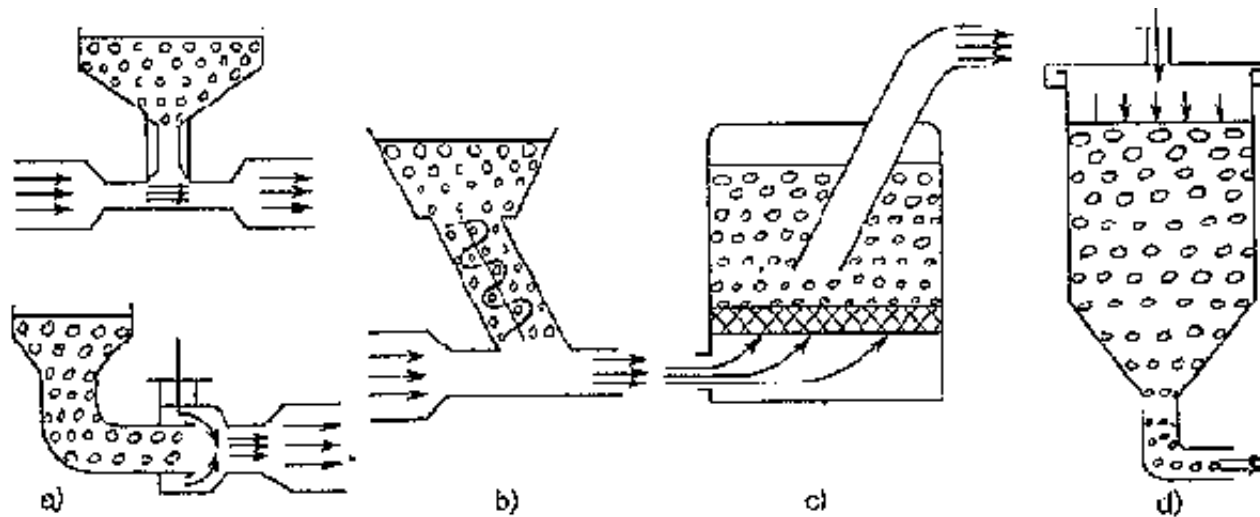
**Charging of drill holes with explosives is being done through the following steps:**

- 1. Blowing the drill hole clean so that the remaining water caused by drilling flush or influx of crack water is removed. Wet explosive can hardly be fired and occasionally leads to a missed hole. Subsequently, this results to either large size debris or breaking away of the round. To clean the hole, a conveyor hose is placed at the drill bottom to blow compressed air into the hole which then carries the water out. The control panel should therefore be so designed so as to allow switching of air mix from explosive compressed air to pure air, alternatively.**
- 2. Charging the drill hole with a high explosive blasting cartridge and detonator with electric ignition or ignitor fuse, by using a tamping stick or charging machine. This charging of cartridge explosive serves as the primer detonation. During insertion of the cartridge with detonator, care should be taken that electrical wires are carefully inserted into the bottom of the hole so as not to damage them.**
- 3. Prepared safety explosive (ANC, ANO, ANFO, ANDEX), a mixture of ammonium nitrate (94 %) and oil (6 %) is inserted with the above-mentioned charging machine through the charging hose.**
- 4. Filling of drill holes with clay, small stones or cotters.**

**Important for a good blasting effect is the correct use of energy which is released during the chemical reaction of explosive. This can be achieved mainly by a complete filling of drill hole with blasting explosive or with explosive components.**

### **SUITABILITY FOR SMALL-SCALE MINING:**

**Pneumatic charging machines are suitable for local production, very simple and cheap remedies, which allow the use of cheaper ANO explosive.**




**Fig.: Schematic sketches of the general methods of compressed air charging.  
Source: Roschlau.**

- a) Jet stream transport,**
- b) Transporter with belt betcher,**
- c) Transporter with porous bottom,**
- d) Pressure tank transporter.**



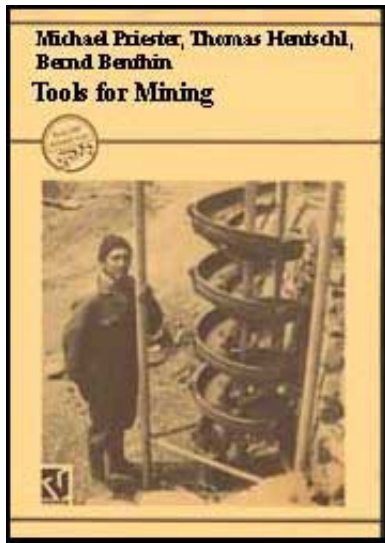
[Home](#) > [ar](#).[cn](#).[de](#).[en](#).[es](#).[fr](#).[id](#).[it](#).[ph](#).[po](#).[ru](#).[sw](#)






 **Tools for Mining: Techniques and Processes for Small Scale Mining (GTZ, 1993, 538 p.)**

 **Technical Chapter 8: Loading**







-  **8.1 Mucking sheet**
-  **8.2 Hand scraper and tray**
-  **8.3 Scraper loader**
-  **8.4 Pneumatic overhead loader**
-  **8.5 Chute, charging hopper**

**Tools for Mining: Techniques and Processes for Small Scale Mining (GTZ, 1993, 538 p.)**

## **Technical Chapter 8: Loading**

### **8.1 Mucking sheet**

#### **Deep Mining General Underground Mining Loading**

germ.: Blechboden als Ladehilfe

span.: Piso de plancha como ayuda para la carga

<b>TECHNICAL DATA:</b>	
Dimensions:	approx. 2 × 1 m ( several pieces), 5 mm thick
Weight:	approx. 50 ka

Extent of Mechanization:	not mechanized
Mode of Operation:	intermittent
Throughput/Capacity:	for increasing efficiency of manual loading
<b>ECONOMICAL DATA:</b>	
Investment Cost:	if scrap, then very low, approx. 100 DM
Operating Cost:	none

### **CONDITIONS OF APPLICATION:**

Operating Expenditures: low |-----|-----| high

Maintenance

low |-----|-----| high

Experience:

Location sufficient space should be available or sheets should be cut into

Requirements:

sizes according to space available.

Mining

Requirements: Mucking sheets should be used if loading has to be made manually without a scraper, overhead shovel loader or other mechanical loading equipment.

Mucking sheets are not bound or dependent upon certain locations since they are also used or applied for cutting and filling, for abandoned workings etc. and avoid muck losses or crushing.

Regional

used or applied in some places in Latin America

Distribution:

Exnerience of

very good |-----|-----| had

EXPERIENCE OF

Operators:

Environmental  
Impacts:

Suitability for  
Local

Production:

Under what application of scrap or simple cuttings of sheet steel  
Conditions:

Lifespan:

very good |-----|-----| bad

low |-----|-----| very high

very good |-----|-----| bad

very long |-----|-----| very short

## **Bibliography, Source: Stout, Treptow**

### **OPERATING PRINCIPLE:**

**The mucking sheets are spread out at the bottom completely before cutting. The cut material is then thrown mostly on the sheets by the blasting or manual cutting. Manual loading becomes easier with mucking sheets, because the shovel can be pushed under the cut materials with less friction. The sheets are then tipped up after loading.**

### **AREAS OF APPLICATION:**

**Loading device for drifting, for cutting, for shaft sinking and at reloading places where materials are loaded by hand.**

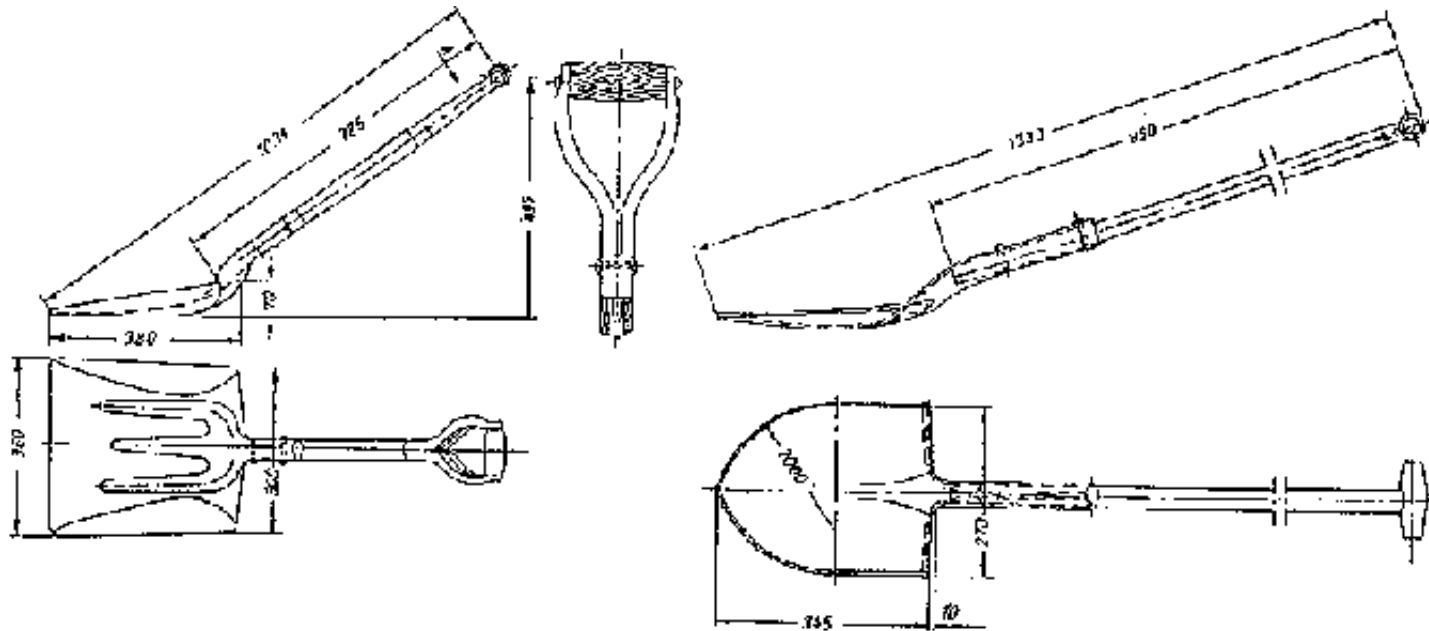
### **REMARKS:**

**Mucking sheets are long lasting, very simple and effective. Before blasting, some materials should be placed on the sheets to serve as weight.**

### **SUITABILITY FOR SMALL-SCALE MINING:**

#### **Summery of suitability**

**Mucking sheets are the right loading remedies for non-mechanized small-scale mining operations. With very low Investment cost, high increases In efficiency can be realized without technical modification and changes of mining method.**



**Fig.: Shovels for loading. a) Coal shovel, b) Muck shovel. Source: Boki.**

## **8.2 Hand scraper and tray**

### **Deep Mining General (vein ore mining)**

## Underground Mining Loading

germ.: Kratze und Trog

span.: Rastrillo y pale pequena

<b>TECHNICAL DATA:</b>	
Dimensions:scraper:	1 m handle, triangular pick, tray approx. 70 × 50 × 20 cm
Weight:	together approx 15 kg
Extent of Mechanization:	not mechanized
Form of Driving Energy:	manual
Throughput/Capacity:	10 :/MS with simultaneous hand-picking
Technical Efficiency:	improves loading efficiency of manual loading
<b>ECONOMICAL DATA:</b>	
Investment Cost:	< 100 DM
Operating Cost:	none

### CONDITIONS OF APPLICATION:

Operating

low |-----|-----| high

Expenditures:

Maintenance

low |-----|-----| high

Experience:

Location

manual loading with scraper and tray is the right technique only

Requirements:

where mine cars or kibbles are loaded.

Regional Distribution:	not known in Latin America	
Experience of Operators:		very good  ----- -----  bad
Environmental Impacts:		low  ----- -----  very high
Suitability for Local Production:		very good  ----- -----  bad
Under what Conditions:	simple metal manufacture	
Lifespan:		very long  ----- -----  very short
	approx. 300 shifts × 8 h	

## **Bibliography, Source: Gerth, Salzmann, Gaetzschmann, Treptow, Freiberg Grube Alte Elisabeth**

### **OPERATING PRINCIPLE:**

**Scraper and tray are supposed to ease loading and increase efficiency. Instead of loading directly everytime into the mining car using the shovel with small loading quantities involving a lot of movement, the material is scraped from the muck or heap into the Iying tray, which, when filled up, is emptied out into the car.**

### **AREAS OF APPLICATION:**

**Manual loading in small-scale mining, increase in efficiency possible with such**

## **simplest remedies.**

### **REMARKS:**

**Before mechanized loading was invented, scraper and tray were widely known in European ore mining during the Middle Ages. Up to this century, they are still used or applied for mining in Harz.**

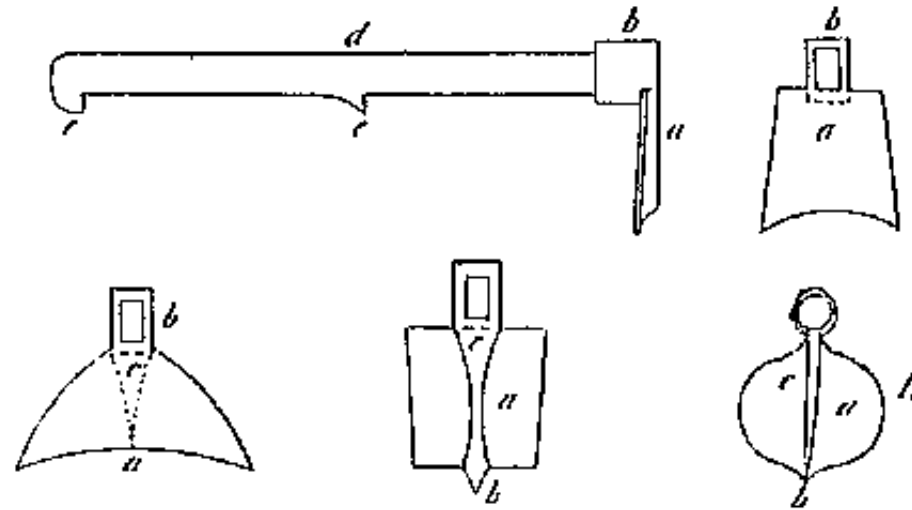
**Gaetzschmann distinguishes a scraper with crescent-shaped concave forged head with a width of 6 - 8", and triangular scraps.**

**To ease or smooth pulling work, about half the length of a nose should stand out at the handle.**

**Scraping is particularly suitable in mines with very limited space where otherwise shovels with short handles would be used.**

### **SUITABILITY FOR SMALL-SCALE MINING:**

**Well-suited remedy to increase loading efficiency with less work effort and less investment in manual small-scale mining In Latin America.**



**Fig.: Different forms of scrapers, Source: Gaetzschmann.**

### 8.3 Scraper loader

#### Deep Mining General Underground Mining Loading

germ.: Schrapper, Schrapplader

span.: trailla cargadora, cuchara de arrastre

Producer: Wolff, MAD (2. hand)

<b>TECHNICAL DATA:</b>	
Dimensions:	engine and loading platform 7 m × 2,2 m; also smaller units available
Weight:	several tones
Extent of	partly mechanized



Mechanization:			
Driving Capacity:	11 kW		
Form of Driving Energy:	electric/only compressed air motor		
Mode of Operation:	intermittent		
Throughput/Capacity	1350 kg pulling force approx. 10 m <sup>3</sup> /h		
Operating Materials:			
Which:	lubricants		
<b><u>ECONOMICAL DATA:</u></b>			
Investment Cost (DM):			
<b><u>New:</u></b>		<b><u>Used:</u></b>	
drum (double)	18.900	without motor	7.000 - 8.000
motor 11 kW	1.410	motor	2.000
rope	680	loading platform	<u>5.000</u>
bucket 0,2 m <sup>3</sup>	3.400	approx.	15.000
pulley	670		
rope anchor	70		
loading platform	<u>15.000</u>		
	40.130		
Operating Cost:	labor cost, power cost and cost of wearing parts, especially ropes		

**CONDITIONS OF APPLICATION:**

Operating Expenditures:		low  ----- -----  high
Maintenance Experience:		low  ----- -----  high
Location Requirements:	Due to immobility of the large and heavy loading platform, the chosen mining method should allow loading of as much material as possible from one location.	
Deposit Requirements:	only applicable, where relative thick veins or gentle inclined deposits are mined	
Replaceable Equipment:	trackbound intermediate conveying, Cavo-loader, overhead loader	
Regional Distribution:	worldwide	
Experience of Operators:		very good  ----- -----  bad
Environmental Impacts:		low  ----- -----  very high
	only through energy supply	
Suitability for Local Production:		very good  ----- -----  bad
Under what Conditions:	loading eventually can be locally produced	
Lifespan:		very long  ----- -----  very short

## **Bibliography, Source: J. Siegert, Stout, Fritsche**

### **WORKING PRINCIPLE:**

**A double hoist at the loading and transfer point moves both the cable with scraper bucket and empty cable through a pulley fixed at the face of heading. The scraper bucket, which is open at the end facing conveying direction is automatically loaded by scrapping through the material like a prow, and is pulled by the haulage cable up to the loading platform to be emptied into a mining car.**

### **AREAS OF APPLICATION:**

**A scraper loader is used for haulage in horizontal gently steep and trackless roadways with stable ground ( not consolidated back fill, abandoned workings, etc.) as, e.g., in drifting, transport to chute, cutting of sills etc..**

### **REMARKS:**

**Scraper loader was widely known and used in all types of small, medium and large-scale mining operations in Europe until the middle of this century. Special advantages have been the reliability as well as stability of such machines. Old scraper loaders are always offered at the second hand market as a mining equipment**

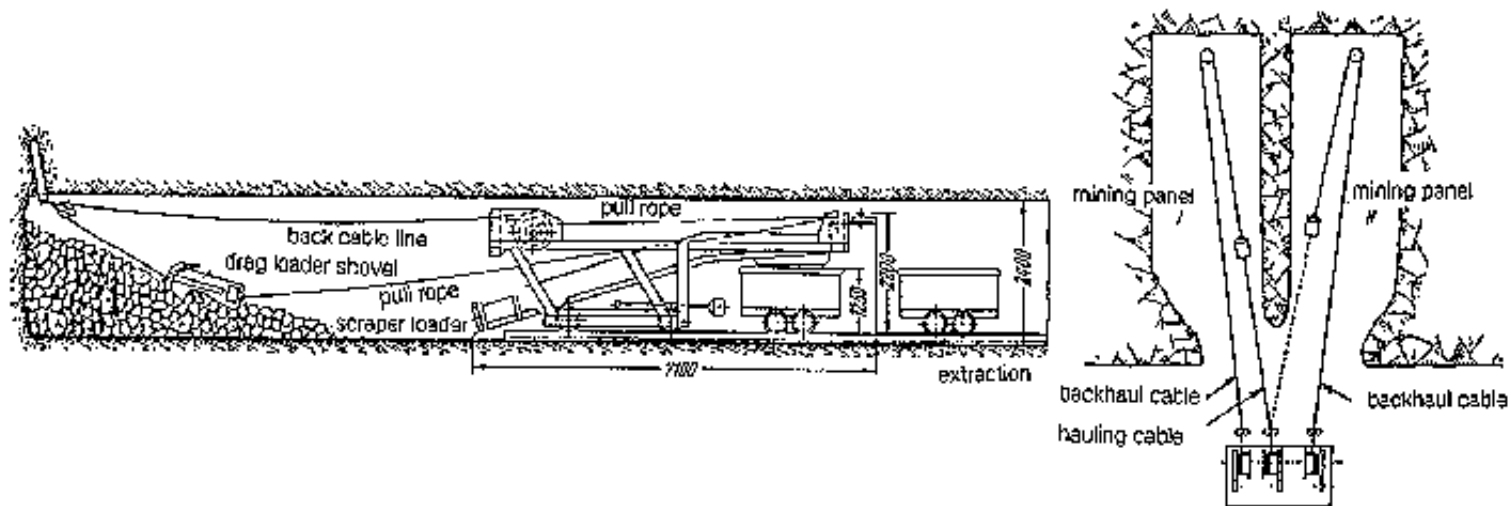
**The simplest construction of a scraper loader is the manual hoist which is economically sound for smaller quantities and shorter transports. The manual hoist works completely without a backward pulling device and pulley. Backward pulling and guiding are done by hand. One man operates the scraper bucket while**

a second one operates the coupling and detaching of hoist and motor. Motor capacity is approx. 1.5 - 5 kW, scrapping capacity is more than 10 t/h for a transport distance of 15 · 20 m.

If scrapers are driven from the surface, other forms of drive can also move the scraper bucket. For example, auto engines were used in small-scale fluorspar mining in Stulln/F.R.Germany.

### SUITABILITY FOR SMALL-SCALE MINING:

For larger small-scale mines that are already mechanized and have adequate geological deposit conditions, the scraper loader is an appropriate remedy for mechanizing the loading despite its somewhat high cost of investment and operation.



**Fig.:** Sketch of a scraper loader; left, With a track-bound loading platform; right, A three-drum scraper loader. Source: Fritzsche.

## 8.4 Pneumatic overhead loader

### Deep Mining General Underground Mining Loading

germ.: Wurfschaufellader

span.: pale cargadora

Producer: Salzgitter MAD (2. hand), Atlas Copco

#### **TECHNICAL DATA:**

SALZGITTER HL 221 T/TSL Type N

Dimension: 1.56 × 1.05 × 2.44 × m HWL, roadway height min. 2.5 m

Weight: 3.600 kg

Extent of Mechanization: partly mechanized

Driving Capacity: 5 - 7 m<sup>3</sup>/min compressed air, 50 mm feed line

Form of Driving Energy: pneumatic

Mode of Operation: intermittent/semi-continuous

Throughput/Capacity: 60 - 100 t/h with 160 l bucket content

Operating Materials:

Which: lubricants

#### **ECONOMICAL DATA:**

Investment Cost: used 5000 to 10.000 DM

Operating Cost: low

**CONDITIONS OF APPLICATION:**

Operating Expenditures:	low  ----- -----  high
Maintenance Experience:	low  ----- -----  high
Personnel Requirements:	low
Location Requirements:	track gauge 450 - 900 mm, compressed air
Ore Requirements:	none
Replaceable Equipment:	loading by hand
Regional Distribution:	worldwide
Experience of Operators:	very good  ----- -----  bad
Environmental Impacts:	low  ----- -----  very high only by energy supply
Suitability for Local Production:	very good  ----- -----  bad
Lifespan:	very long  ----- -----  very short

**Bibliography Source: Siegert, Salzgitter, companies brochure, AC-Handbook**

**OPERATING PRINCIPLE:**

**Pneumatic overhead loader is controlled while running or from a platform. The bucket is being filled during forward driving and emptied into a mining car located at the back by turning the bucket over the whole machine.**

**AREAS OF APPLICATION:**

**loading in drifting loading in ramps loading in haulage way under chutes clean**

## up/loading at special working places under loading in cross-cuts draw points

### REMARKS:

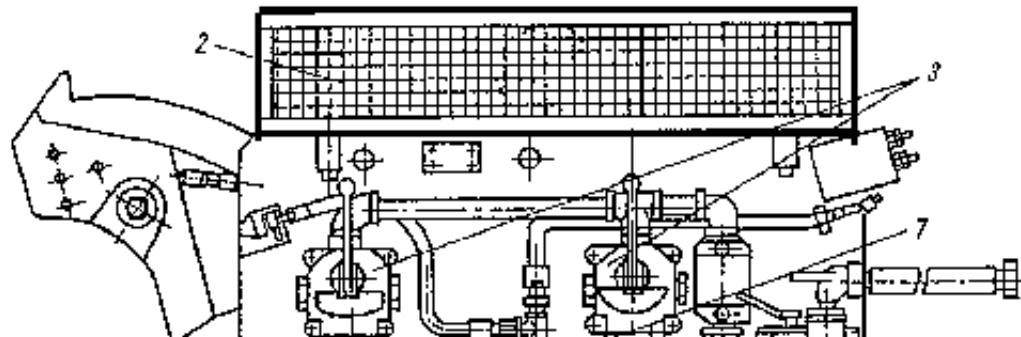
For decades, this type of overhead loader was widely known in small-scale ore mining both in Europe and Latin America and also in other mining countries. It made itself known by its stability, simplicity and long lasting quality.

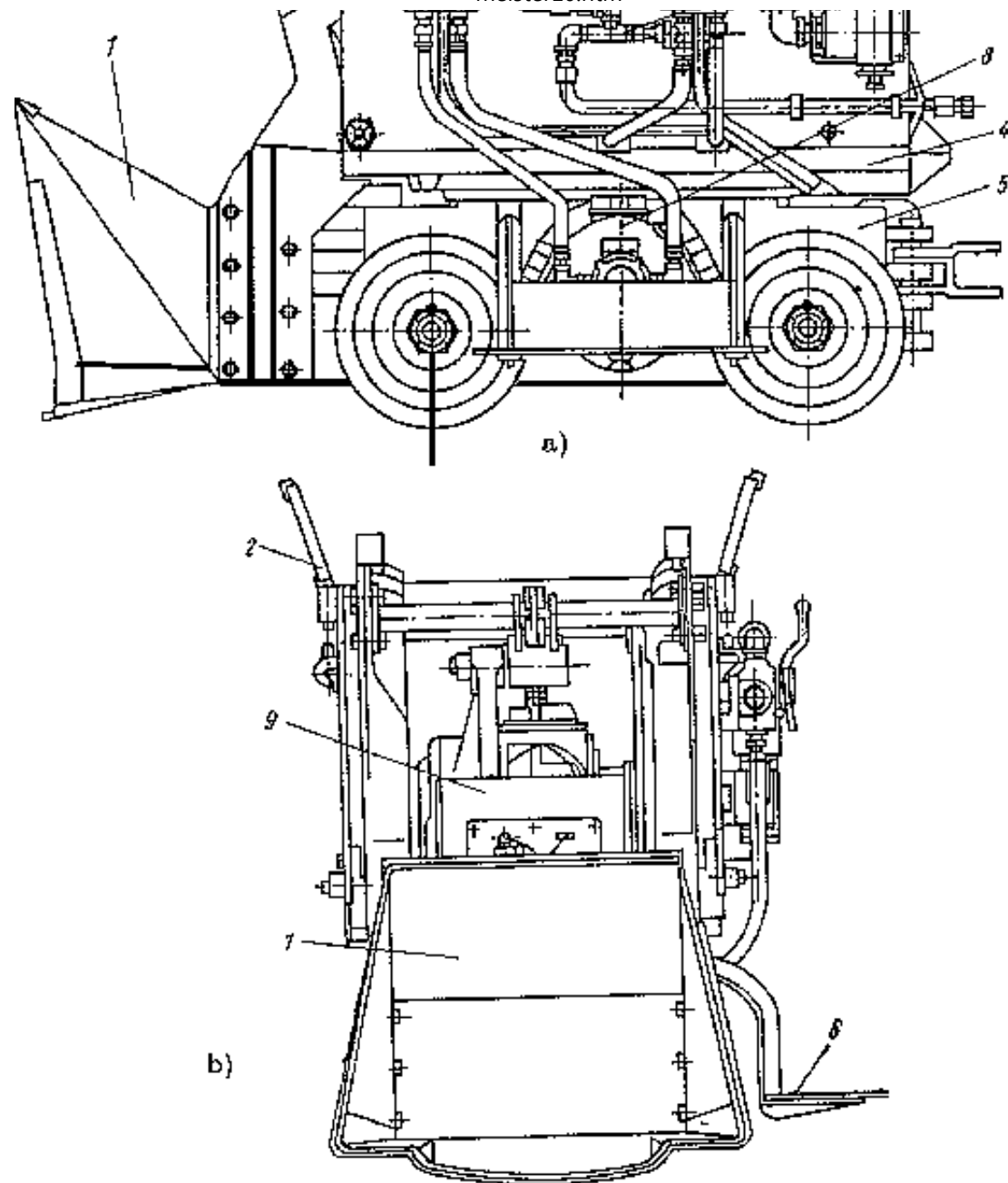
Overhead loaders are also available for operating in ramps with an angle of deviation of 25 gonimeter.

Overhead loader operate as track bound or as trackless machines. For the latter, it would need more inside roadway diameter.

### SUITABILITY FOR SMALL-SCALE MINING:

The right application for overhead loaders is, where an already mechanized efficient drilling system and conveying installations exist. Likewise, the existing compressed air system should be adjusted to the comparably high energy consumption of an overhead loader. Under these conditions, overhead loaders can do the loading work economically and efficiently.

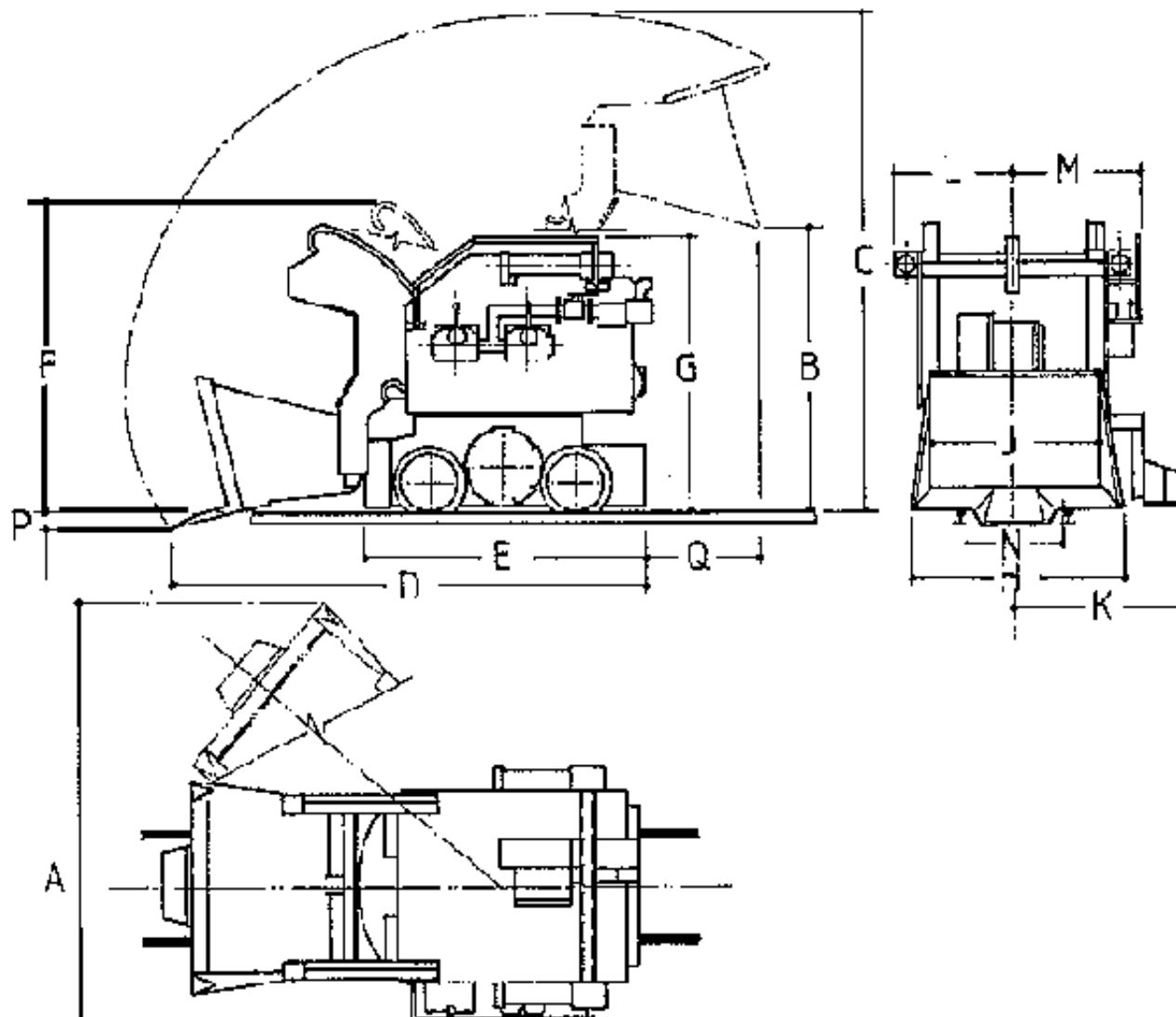




**Fig.: An overhead loader PPN-1s. a) side view; b) front view. Source: Roschlau**



- 1) bucket**
- 2) protective grating**
- 3) control panel**
- 4) machine platform**
- 5) drive system**
- 6) footboard**
- 7) spray device**
- 8) driving motor**
- 9) lifting motor**



**Fig.: An overhead loader. Source: Salzgitter Company Information.**

## **8.5 Chute, charging hopper**

### **Deep Mining General (steep formation) Underground Mining Loading**

germ.: Bunkerschurre, Ladekasten

span.: tolva de buzon, cajon pare cargar

<b>TECHNICAL DATA:</b>	
Dimensions:	approx. 2 × 2 × 2 m
Extent of Mechanization:	not mechanized
Form of Driving Energy:	loading remedy using gravity
Mode of Operation:	intermittent
Other Opportunities:	pneumatic cylinders for opening
Operating Materials:	none
<b>ECONOMICAL DATA:</b>	
Investment Cost:	if constructed with wood, very low cost of material
Operating Cost:	none

### **CONDITIONS OF APPLICATION:**

Operating Expenditures: low |-----|-----| high

Maintenance

low |-----|-----| high

Experience:

Deposit inclined or especially steep ore vein deposits, where the vertical interval

Requirements: can be used for loading. Particularly suitable in mines with roadways in which daydrifting is placed under work facings.

Minina all minina methods that lead upwards and allow partly material storage

**Requirements:**

Replaceable loader as overhead loader under chute

**Equipment:**

Regional widely known in medium-scale mining but unknown in small scale mining

**Distribution:**

Experience of

very good |-----|-----| bad

**Operators:**

Environmental

low |-----|-----| very high

**Impacts:**

Suitability for

very good |-----|-----| bad

Local

**Production:**

Under what simple wooden constructions

**Conditions:**

Lifespan:

very long |-----|-----| very short

**Bibliography, Source: Stout, Fritsche, Armstrong****OPERATING PRINCIPLE:**

**The chutes that are placed under cavities caused by the extraction under drop-holes or bunker, are designed to hold the material above the loading height of mining cars. By opening the chute, the material falls into the mining car which is loaded by gravity.**

**AREAS OF APPLICATION:**

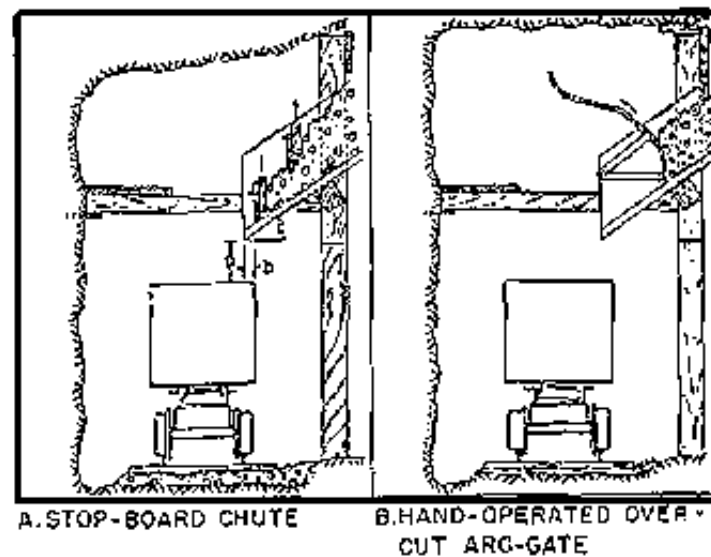
## Material storage and loading of mining cars in haulage road.

### REMARKS:

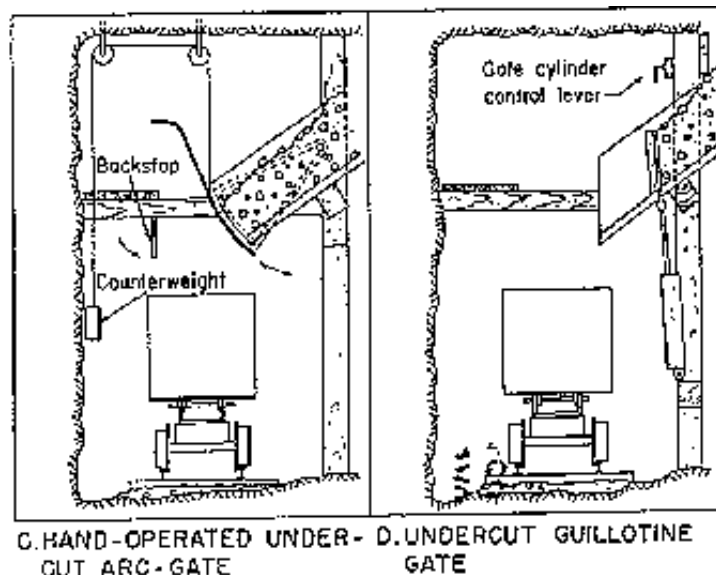
Sticky muck becomes a problem when it muds off and badly affects the transport by gravity. To Increase the lifespan of chutes, the material storage should show a certain minimum filling requirement, to avoid direct impact of material on the feed gate.

### SUITABILITY FOR SMALL-SCALE MINING:

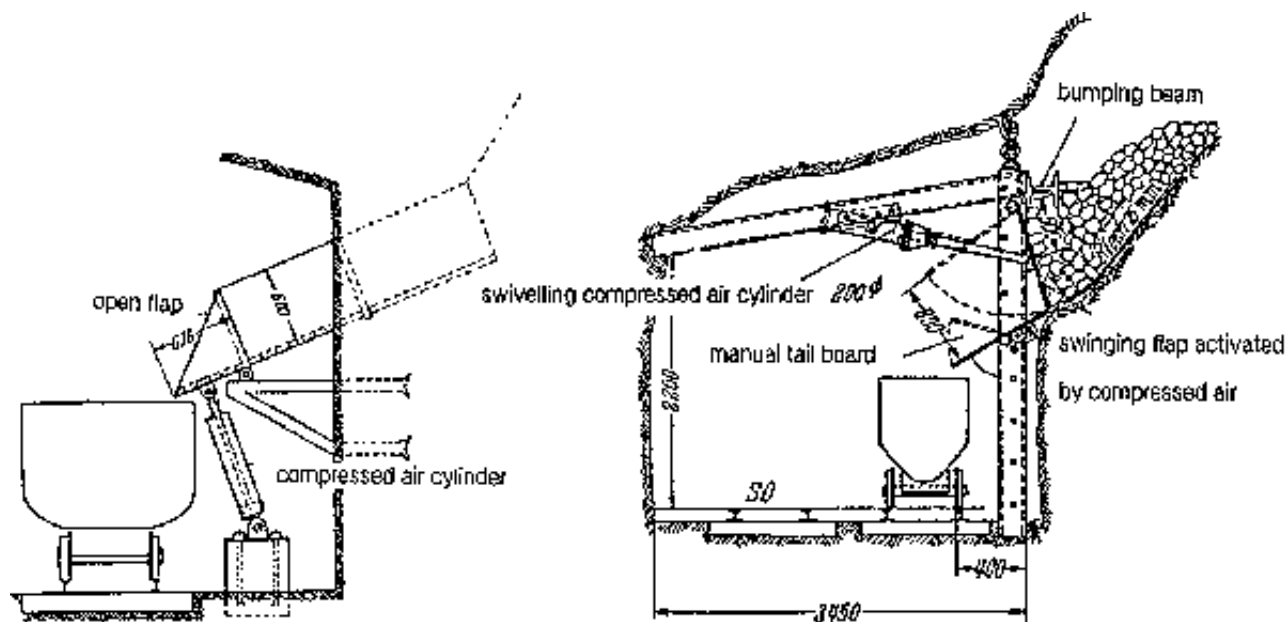
Under suitable conditions (deposit geology, mining method), reloading can then often be avoided and gravity can be used for loading purposes. Thus, chutes are very suitable for application in small-scale mines which are low mechanized.



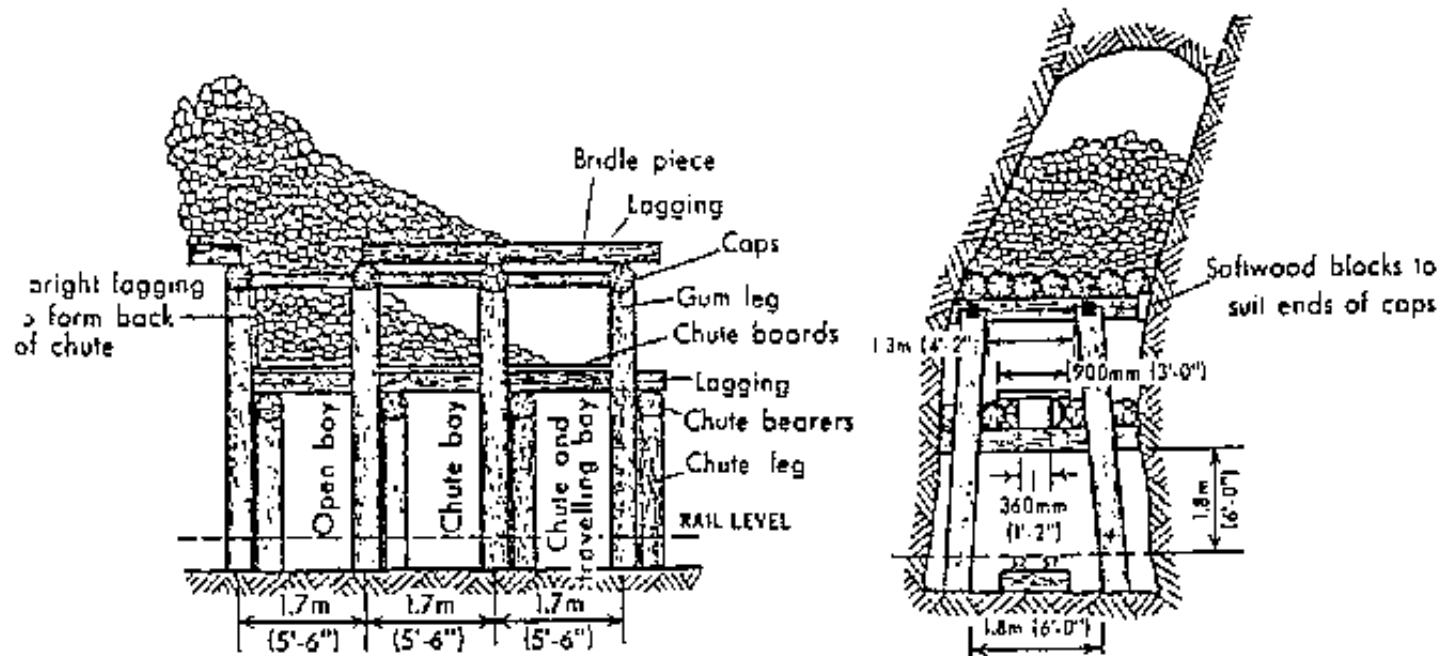
**Fig.: Charging hopper. Source: Stout.**



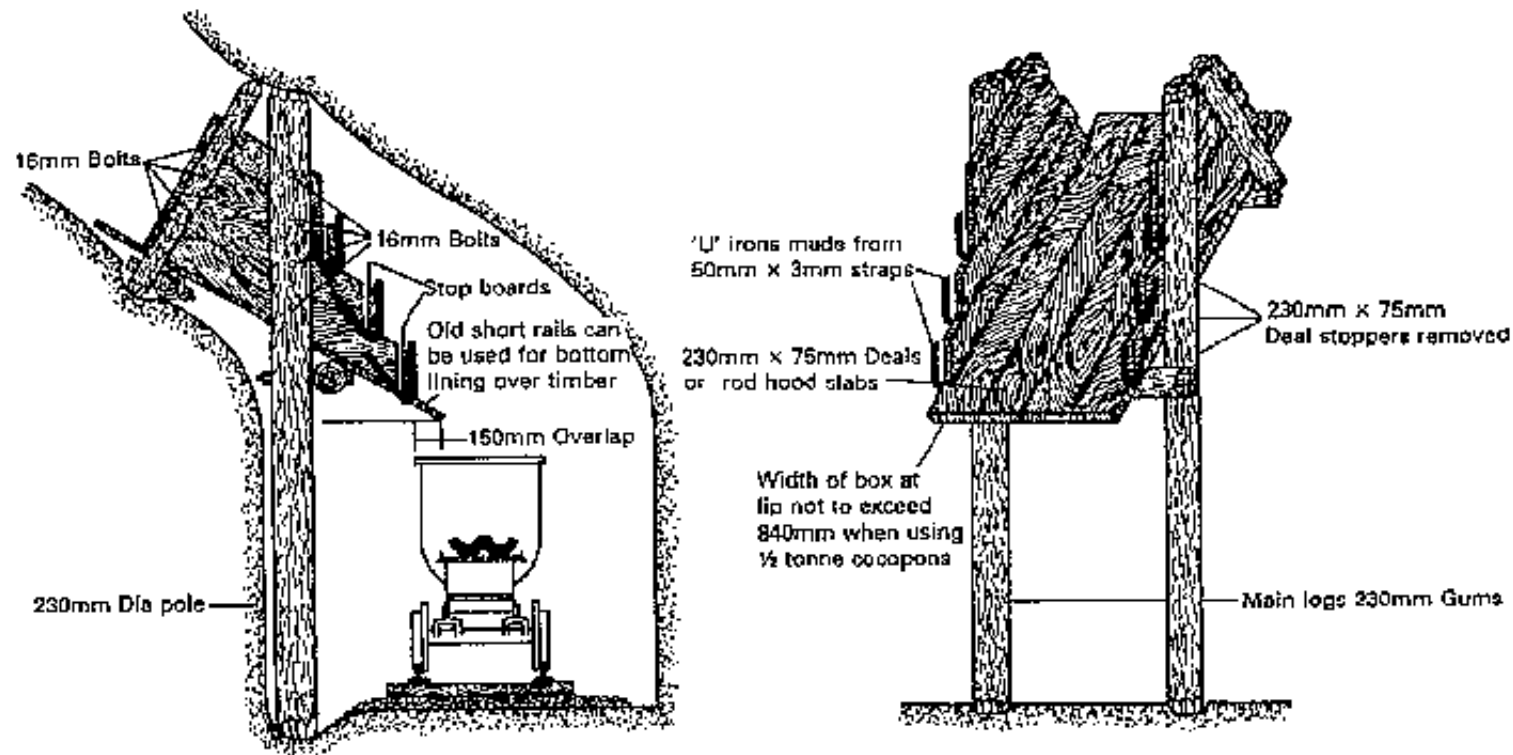
**Fig.: Charging hopper. Source: Stout.**



**Fig.: Chutes with compressed air drive, left from below, Closing gate; right from above, Closing gate. Source: Fritzsche**



**Fig.: Chute; left, longitudinal section; right, general view. Source: Armstrong**



**Fig.: Chute; left, side view; right, perspective view. Source: ITDG.**



[Home](#) > [ar](#).[cn](#).[de](#).[en](#).[es](#).[fr](#).[id](#).[it](#).[ph](#).[po](#).[ru](#).[sw](#)

## **Tools for Mining: Techniques and Processes for Small Scale Mining (GTZ, 1993, 538 p.)**

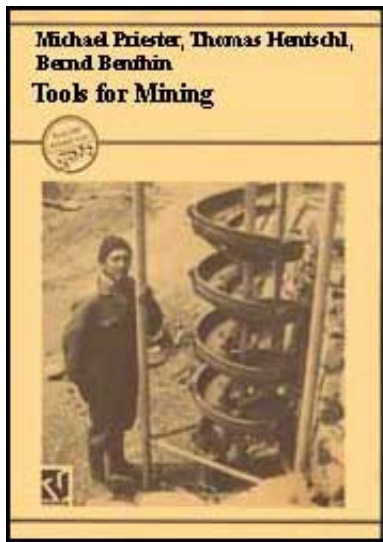
### **Technical Chapter 9: Hauling**

 **9.1 Manual winch**

 **9.2 Motor cars as hauling machines, depth indicators**

 **9.3 Block and pulley**





## 9.4 Trackless and track bound haulage

## 9.5 Passenger lifting moving ladder

**Tools for Mining: Techniques and Processes for Small Scale Mining (GTZ, 1993, 538 p.)**

### Technical Chapter 9: Hauling

#### 9.1 Manual winch

**Deep Mining General Open-Pit Mining General  
Underground Mining Hauling**

germ.: Handhaspel, Winde

span.: guinche manual, malacate, torno

Producer: INCOMAQ, COMESA, DERENA, FIMA, Metal Callao, E.P.S.

#### **TECHNICAL DATA:**

Dimensions:

approx. 2 × 1.5 × 1 m WLH

Weight:	approx. 10 kg
Extent of Mechanization:	not mechanized
Driving Capacity:	0.3 - 0.6 kW in 2 man operation
Form of Driving Energy:	manual
Other Opportunities:	winch (animal power gear), hydromechanic with water wheel
Mode of Operation:	intermittent
Throughput/Capacity:	depth up to approx. 45 m, max. 100 m with 0.1 - 0.2 m/s hauling speed
Technical Efficiency:	very high if friction is low
<b>ECONOMICAL DATA:</b>	
Investment Cost:	approx. 200 DM if locally produced with wood
Operating Cost:	exclusively labor cost
Consequential Cost through Coupling Effects:	cable (rope), bucket 0.05 - 0.2 m <sup>3</sup> content

### **CONDITIONS OF APPLICATION:**

Operating Expenditures: low |-----|-----| high

Maintenance: low |-----|-----| high

Experience:

Location Requirements: shaft or blind shaft with hoist chamber at the upper end of

conveying distance or drift

Replaceable Equipment: leather bag hauling with rope pulled by hand, which is typical for small-scale mining

Regional Distribution: also known in small-scale mining in Latin America

Experience of Operators: very good |-----|-----| bad

Environmental Impacts: low |-----|-----| very high

Suitability for Local Production: very good |-----|-----| bad

Under what Conditions: wood or metal manufacture

Lifespan: very long |-----|-----| very short

**Bibliography, Source: Agricola, Delius, Hartmann, Hentschel, Wagenbreth, Slotta**

### **OPERATING PRINCIPLE:**

**With one or two handles the conveying rope is wound up by hand on a direct coupled drum.**

### **AREAS OF APPLICATION:**

**Ore and material conveyance also water transport and passenger lift in shafts and roadways of small-scale mines.**

### **REMARKS:**

**Winch suspension with counter weight and counter rope to lower the necessary leverage. To equalize the static load moment tapered cable drums were invented. If the bucket hangs deep within the shaft, the load is higher due to the weight of rope. The load moment of hoist is then minimized by the small drum diameter, while the stronger the load is wound up, the weight of the hanging rope is smaller and the drum diameter increases. In case of static load, the following formula is used:**

$$M_{\text{stat.}} = r_{\text{drum}} \times (\text{actual load} + \text{weight of material} + \text{rope weight})$$

**which calculates the conical angle of drum.**

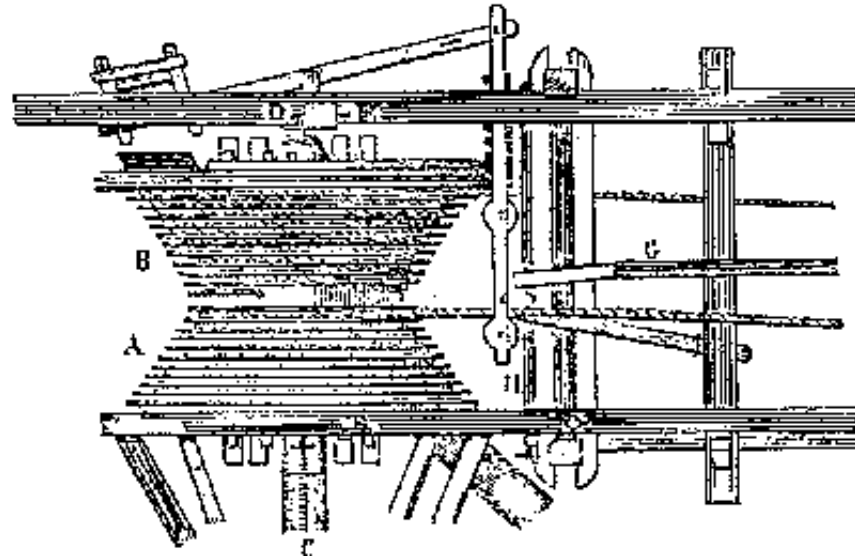
**For the purpose of personnel lifting it is important to use safety dogs and breaks.**

**The integration of anti-friction bearings decreases friction losses.**

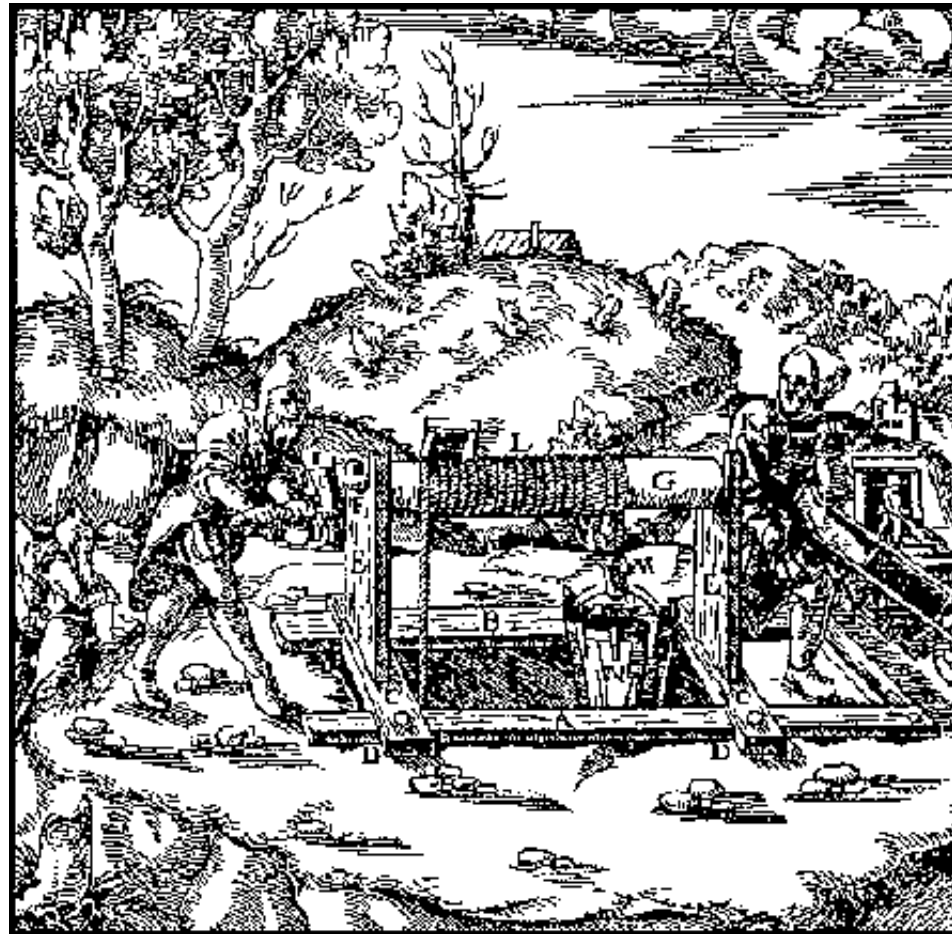
### **SUITABILITY FOR SMALL-SCALE MINING:**

**In comparison to the simple form of conveying by leather bag hooked on a rope, the manual winch which is especially used as double drum system with good ball bearings, makes work considerably easier. On the surface, it is however preferred to use animal power.**





**Fig.: Tapered drum of winch to equalize cable weight as double cable operation.  
Source: Ponson.**



**Fig.: Manual winch. Source: Agricola**

## **9.2 Motor cars as hauling machines, depth indicators**

### **Deep Mining General, Open-Pit Mining General Underground Mining Hauling**

germ.: Fördermaschinen mit PKW-Chassis, Teufenstandsanzeiger für Schachtförderung

span.: máquina de extracción con chasis de auto, indicador de profundidad para el

## transporte en el pozo

<b><u>TECHNICAL DATA:</u></b>		
Weight:	500 - 800 kg	
Extent of Mechanization:	fully mechanized	
Driving Capacity:	30 - 100 kW	
Form of Driving Energy:	internal combustion engine	
Other Opportunities:	none	
Mode of Operation:	intermittent	
Operating Materials:		
Which:	lubricants	fuels   water for
Quantity:	approx. 1 I/10 hours operation 5 - 15 I/hours operation cooling	
<b><u>ECONOMICAL DATA:</u></b>		
Investment Cost:	if a second-hand car chassis is used, approx. 2000 DM	
Operating Cost:	high fuel cost	
Consequential Cost through Coupling Effects:	hauling cable, bucket	

**CONDITIONS OF APPLICATION:**

Operating Expenditures:

low |-----|-----| high

Maintenance Experience:

low |-----|-----| high



Mining Requirements:	mine design should allow shaft hoisting and inclined shaft hoisting from surface
Replaceable Equipment:	animal power gear, winch etc.
Regional Distribution:	known in Colombian mines, but also used to drive a ski lift at Chacaltaya, Bolivia
Experience of Operators:	very good  ----- -----  bad
Environmental Impacts:	low  ----- -----  very high pollution through used oil and exhaust gas
Suitability for Local Production:	very good  ----- -----  bad
Under what Conditions:	old cars redesigned by auto mechanics
Lifespan:	very long  ----- -----  very short

## **Bibliography, Source: Hentschel, Priester**

### **OPERATING PRINCIPLE:**

**The small-scale mining industry uses car chassis as a simple hauling system of which engine, clutch, gear, differential and drive axle are still in operation. One side of the drive is put away and at the other side, the cable is wound up by the remaining rim used as drum. The radiator is replaced by an open barrel to serve as water tank for a closed cooling circuit. The haulage is controlled by forward and backward shifting.**

**A depth indicator which reflects the location of the bucket on a well displayed board, substantially helps in controlling the shaft hoist, especially if rope marking**

**fails due to foul rope. Simple designs of depth indicators are:**

- string indicators, which wind up a string on a screw bolt at the axle of the hauling machine or the rope drum along the thread. The exact position of the bucket is indicated or shown on a weighted or gauged scale by a clean thread and a nonelastic string guided through a pulley and suspended by a weight at the string end.**
- thread indicator comprised of a thread coupled with an axle of the cable drum or hoist and drives a nut holed by a pin avoiding the nuts rotation.**

**For the correct performance of string indicators it is necessary that the cable is equally wound up.**

**Beside depth indicators, signal systems like for example curb bells (see 1st photo, Technique 4.3), are most practical. Even in inclined shafts, mechanized curb bells can be operated over several hundred meters by moving the tongue of the bell placed at the opening with a loosely distributed wire. In shafts which are used simultaneously for hauling and personnel lifting, operation of signal bells should be possible from any point for safety reasons.**

### **REMARKS:**

**Advantages are, the widely known auto techniques and therefore repairs can be done by local technicians, easy procurement of wearing spare parts, and their comparably low cost.**

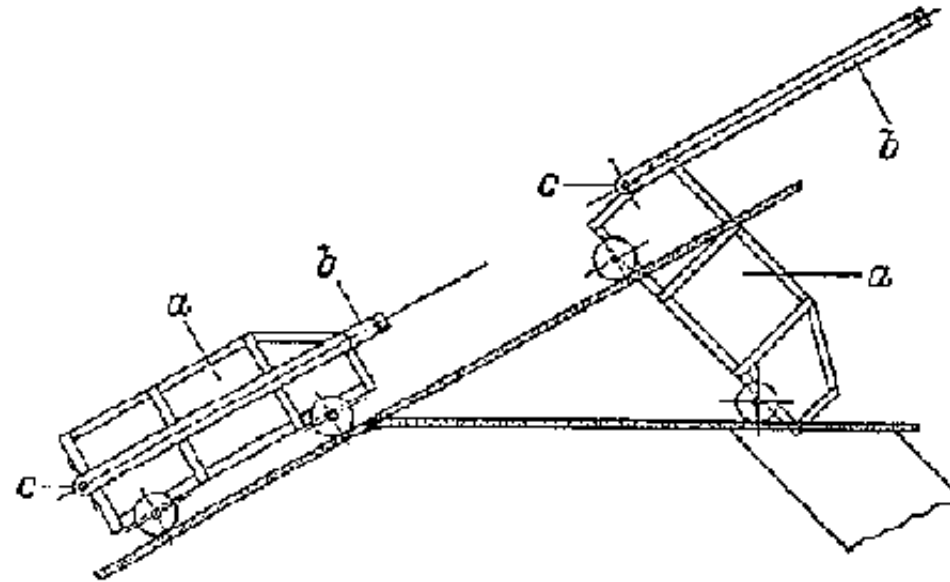
**To avoid abrasion of cable or rope in inclined shafts, it is important to install**

**pulleys by which the rope is free-wheeling. Under no circumstances should it drag along the floor. At the same time, to avoid corrosion, the wire should be oiled or greased. This can multiply the hauling cable's lifespan several times.**

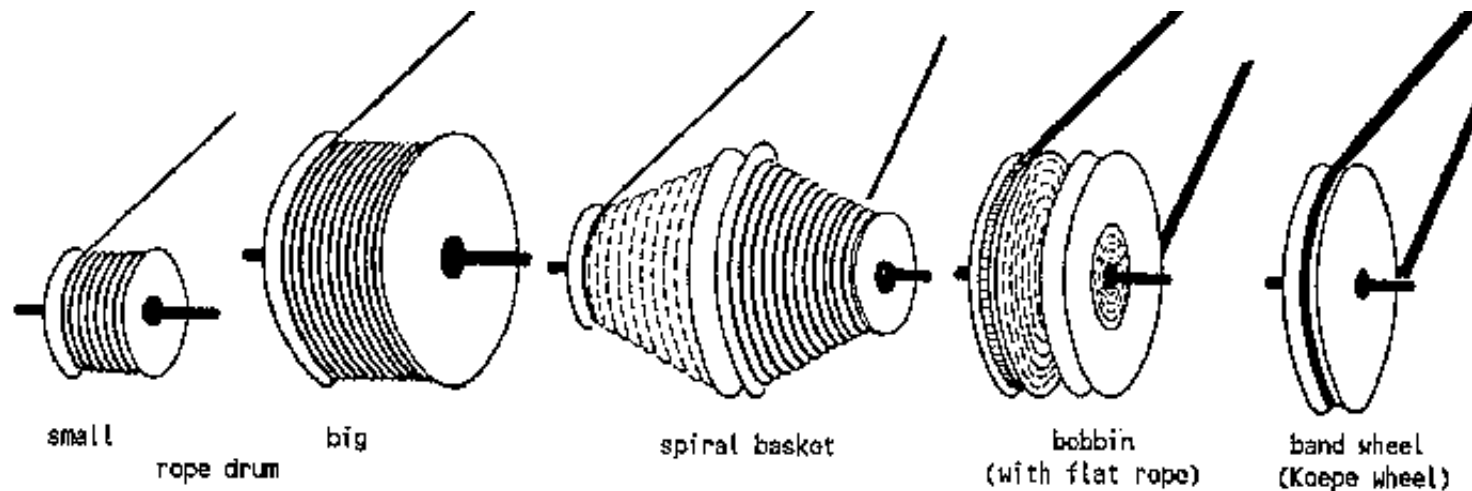
### **SUITABILITY FOR SMALL-SCALE MINING:**

**Car chassis is very suitable for hauling due to their availability everywhere at reasonable prices especially for second hand units. Another advantage is also the availability of very good repair and maintenance knowledge.**

**Development of hauling machines for deep shafts, respectively with steam engine or electric motor drive. Small rope drum for shafts of low depth was enlarged for deep shafts - was redesigned into a spiral basket to get a small load arm for huge loads (hoisting cage in the depth + weight of rope) - was redesigned into bobbin with the same principle such as that of spiral basket- changed into the new principle of band wheel (Koepe wheel): both hoisting cages are on a common rope (weight equalization by under-rope in shaft).**



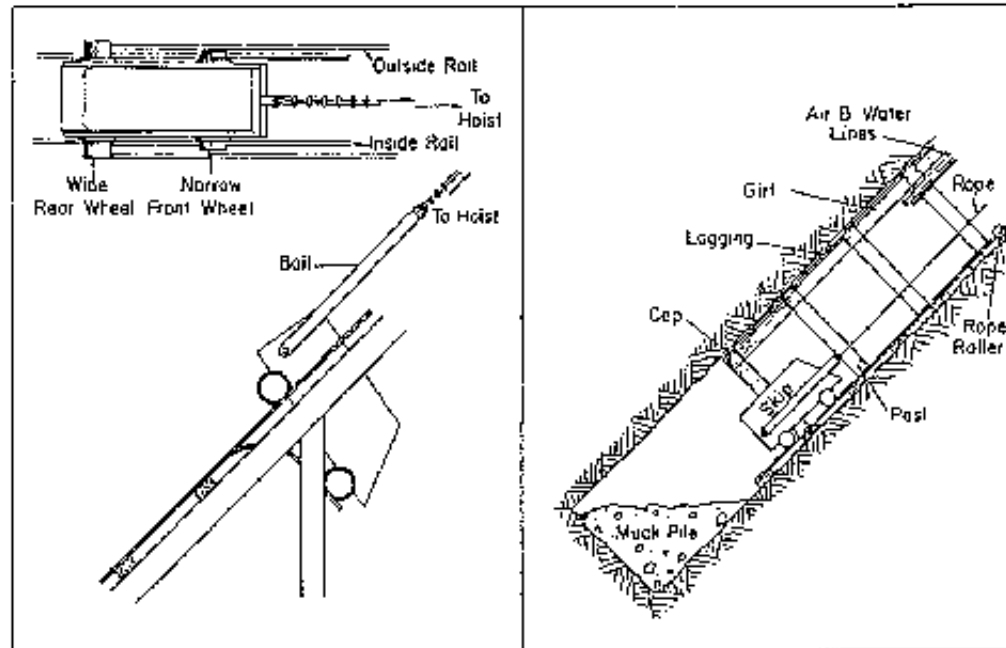
**Fig.: Tipping bucket for inclined haulage. Source: Fritzsche.**



**Fig.: Development of a rope drum. Source: Wagenbreth**

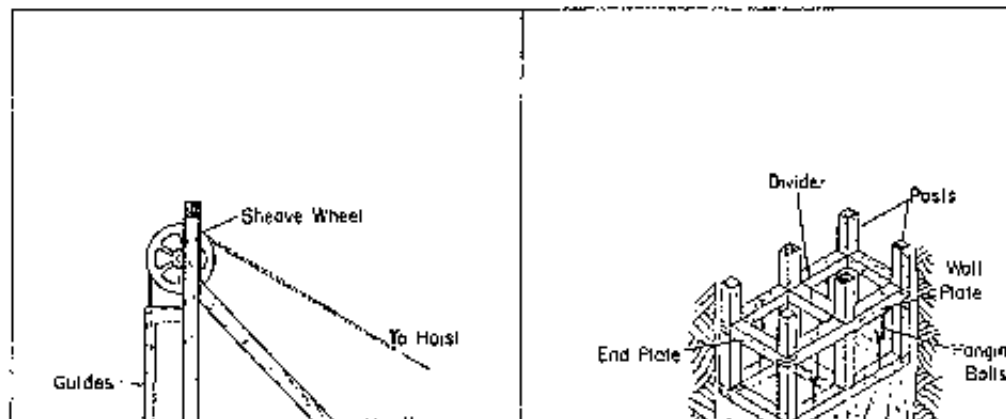
**Development of hauling machines for deep shafts, respectively with steam engine or electronic motor drive. Small rope drum for shafts of low depth - was enlarged for deep shafts - was redesigned into a spiral basket to get a small load arm for**

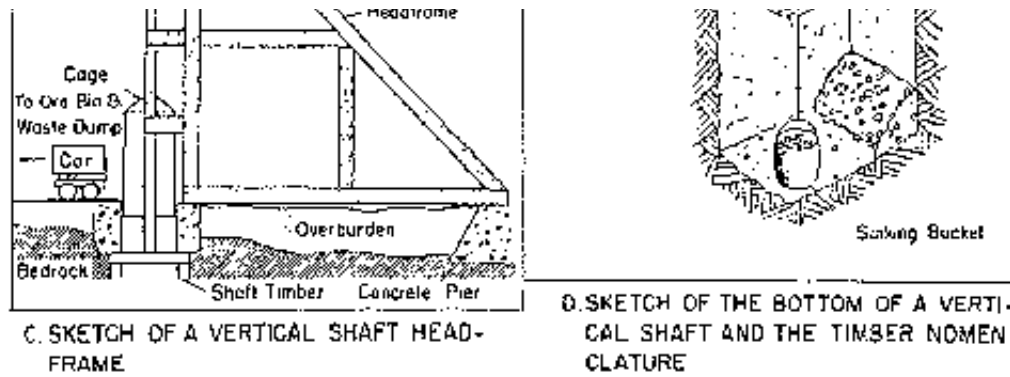
**huge loads (hoisting cage in the depth + weight of rope) - was redesigned into bobbin with the same principle such as that of spiral basket - changed into the new principle of band wheel (Koepe wheel): both hoisting cages are on a common rope (weight equalization by under-rope in shaft).**



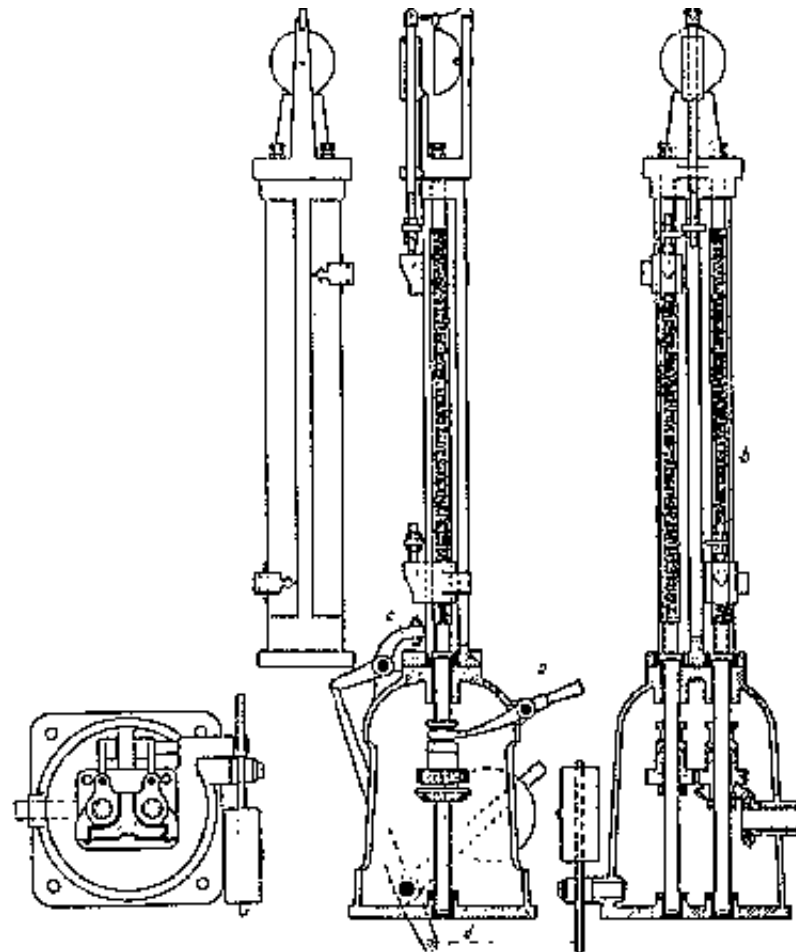
A. SKETCH OF THE DUMPING ARRANGEMENT FOR A SKIP USED IN AN INCLINED SHAFT

B. SKETCH OF THE BOTTOM OF AN INCLINED SHAFT SHOWING VARIOUS PARTS OF THE SHAFT

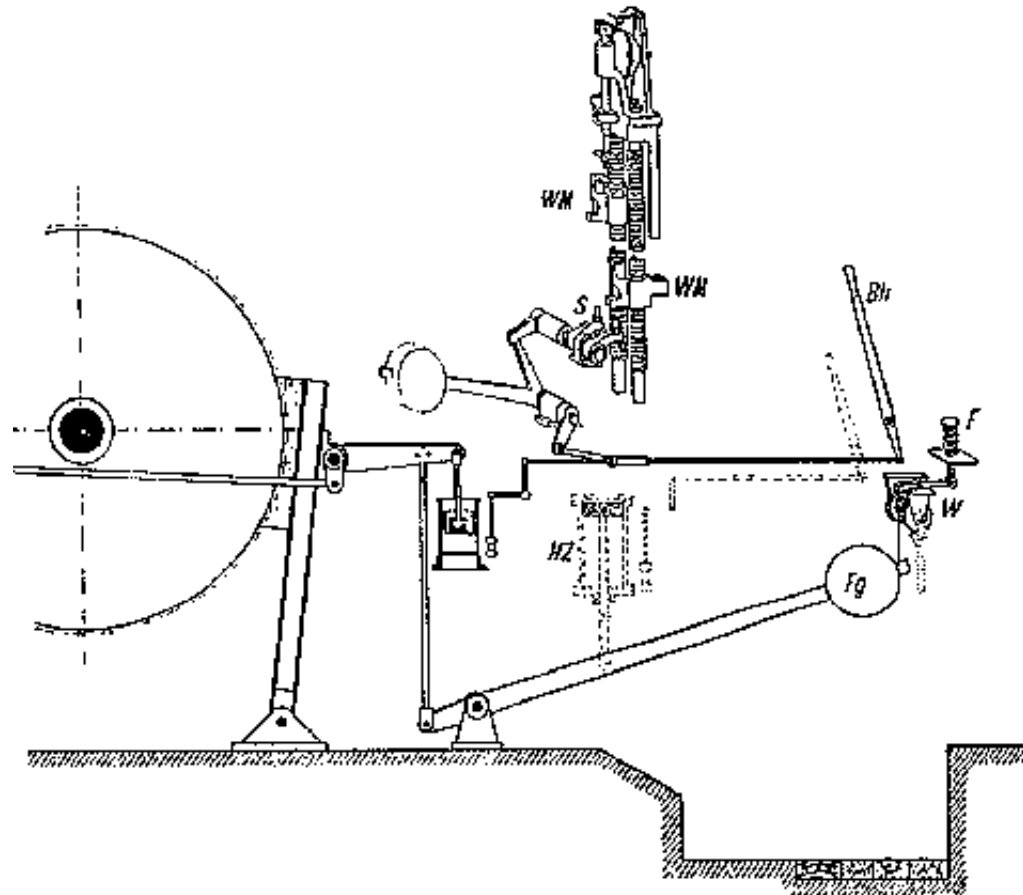




**Fig.: Hauling systems. Source: Stout.**



**Fig.: Double spindle depth indicator. Source: Hoffmann**



**Fig.: Break, depth indicator, end release. Source: Hoffmann**

### 9.3 Block and pulley

**Deep Mining General, Open-Pit Mining  
Underground Mining Hauling**

germ.: Flaschenzug

span.: polipasto, aparejo

<b>TECHNICAL DATA:</b>	
Dimensions:	several pulleys, dimension depends on the weight of material being handled
Weight:	few kg
Form of Driving Energy:	manual, animals, electric, hydromechanic, pneumatic
Other Opportunities:	pedal drive
Mode of Operation:	intermittent
Technical Efficiency:	mechanical remedy for conveying and lifting material
<b>ECONOMICAL DATA:</b>	
Investment Cost:	< 200 DM with pulleys which are available in the market
Operating Cost:	none
Consequential Cost through Coupling Effects:	rope and bucket should be available

### **CONDITIONS OF APPLICATION:**

Operating Expenditures: manual  
 low |-----|-----| high  
mechanized

Maintenance Experience: low |-----|-----| high



Regional Distribution:	not applied for haulage in small-scale mining
Environmental Impacts:	low  ----- -----  very high
Suitability for Local Production:	very good  ----- -----  bad
Under What Conditions:	wood or metal manufacture
Lifespan:	very long  ----- -----  very short

## **Bibliography, Source: Born**

### **OPERATING PRINCIPLE:**

**With several pulleys, the weight of the bucket is distributed into several rope units.**

$$F_{\text{tension}} = \frac{F_{\text{total}}}{n_{\text{pulleys}}} + \Sigma \text{friction}$$

### **AREAS OF APPLICATION:**

**Remedy to make such works as haulage and transport easier.**

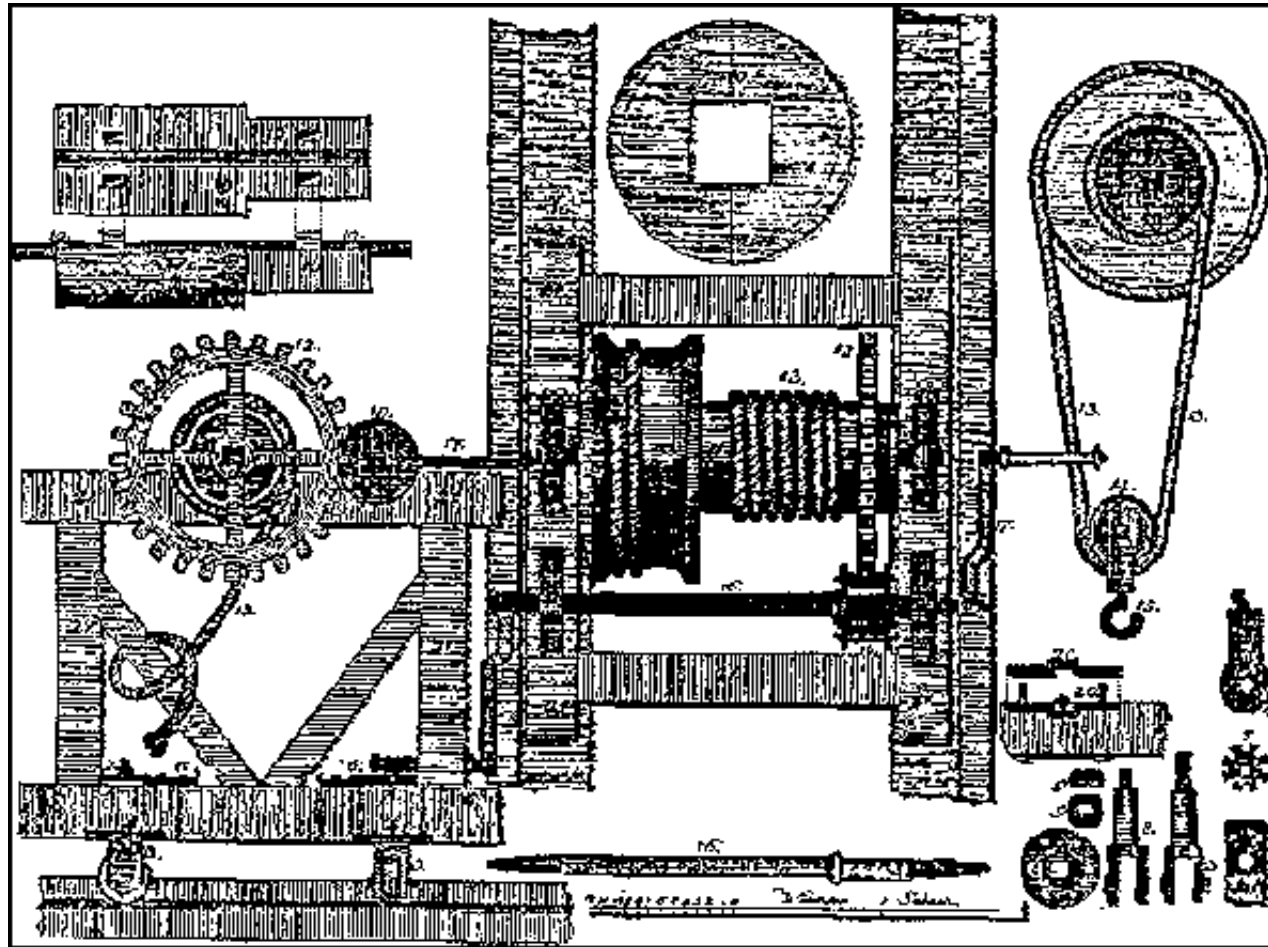
### **REMARKS:**

**Block and pulley demand an increased length of rope since the pulling distance doubles with each pulley causing respectively half the tension. Still, the use of block and pulley is meaningful in adjusting the cycle of the winding period and haulage capacity to the operating cycle of loading and unloading.**

**In ecuadorian mining of aluvial gold deposits, large stones are pulled up into the surface with block and pulley with simple tripod during shaft sinking.**

### **SUITABILITY FOR SMALL-SCALE MINING:**

**Suitable for the small-scale mining industry as an auxiliary equipment. Also contributes to a continuous operation in haulage work.**



**Fig.: Block and pulley. Source: Born.**

## 9.4 Trackless and track bound haulage

### Deep Mining General Open-Pit Mining General Underground Mining Hauling

germ.: Gleislose und gleisgebundene Frderung unter Tage

span.: Transporte en interior mine sobre y sin rieles, aparejo

Producer: Buena Fortuna, COMESA, DERENA, Eduardo, FAHENA, FAMESA, Famia Ind., FIMA, Fundicion Callao, FUNSA, FUNVESA, H.M., IAA, INCOHEC, inc. Met. Van Dam, Krug, M.M. Soriano, MAENSA, MAEPSA, MAGENSA, MEPSA, Metal Callao, E.P.S.: Metalurgica Lacha, PROPER, Volcan

<b>TECHNICAL DATA:</b>	
Extent of Mechanization:	not mechanized
Form of Driving Energy:	gravity and muscular strength
Other Opportunities:	roof switch: probably pneumatic tension reel, battery locomotive, compressed air locomotive
Mode of Operation:	intermittent
Throughput/Capacity:	efficiency of hand pushed wagons on properly made laying of rail track inclusive of way back approx. 1800 - 2000 kg × km/mh
<b>ECONOMICAL DATA:</b>	
Investment Cost:	mine car: 500 DM/piece (used); steel rails and switches, type S

Consequential Cost through Coupling Effects:	10: 30 DM/m (used) steel rails and switches: Jim-Crow (Santiago), track gauge, slope rate
----------------------------------------------	----------------------------------------------------------------------------------------------

**Bibliography, Source: Siegert, Bernewitz, Stout, Villefosse, Delius, Goschen, Gerth/Salzmann, Treptow, Bergbaumuseum Eisenerz Steiermark, VOEST, Hutte**

### **OPERATING PRINCIPLE:**

**For transporting in underground mining, trackless and track bound haulage are to be distinguished:**

#### **Trackless haulage:**

**This can be done without mechanized remedies by back-pack over a short distance for hand picked and high-grade, selective mine ore, or by wheelbarrow or carts with rubber wheels. The shuttle-belt conveying method originating from the mining at Mansfeld's thin copper shales where the workable thickness has only 90 cm, is also known for immediate transporting to the main galleries. Therefore, a hoist pulls a piece of conveying belt where the ore is piled on to the main conveying system. This method makes sense where conveying belts are in operation and sufficient construction material is available. The wheelbarrow is designed to lead the load weight to the wheels by arranging the axles position in front of the center of gravity. The miner handles the steering and driving.**

**Biaxial mine cars work analogously. Trackless hauling needs a properly cleaned, balanced and stable ground to guaranty transporting without friction as much as**

**possible. Boards are lined along the bottom as support on which cars run with or without track nail. This leads to the so-called track bound haulage.**

### **Track bound haulage:**

**If laying of rails is made properly, track bound haulage guaranties friction-free transporting of loaded cars even without locomotives. Still, comparably high expenditures for infrastructure of rail tracking becomes inevitable. On the other hand, keeping the tracks clean is easy and they allow transporting of heavy tools, machines as well as construction materials.**

**The rails could be made of wood or metal: wooden rails are less expensive, resistant against acidic water, but allow less axle load in comparison to steel rails and mouldering appears fast in a humid environment.**

**Steel rails and switches (riel de coville, linea decauville) are comprised of:**

rails	steel
fishplates and screws	
sleepers	wood, steel
screws, wing plates	
switches	steel
crossings	steel
turn sheets	steel

### **Mining cars:**

**Mining cars are composed of a drive system, normally with four equally sized wheels and coupling devices with buffers as well as a container. Unloading of mining cars is done by dumping devices or gates to be opened forward, backward or to the side. Rigid and closed cars can be unloaded by a rotary car dumper.**

**The most common way to move mining cars in small-scale mines is to push them forward by hand, wherein the loaded car almost runs alone by itself along the track, and the empty one has to be pushed slightly upwards.**

**If the roadway cross-section is wide enough in main roads, mining car transport can be supported by horses. Mining horses can pull 6 - 10 fully loaded cars if rail track laying is made properly. Until the beginning of this century, this kind of transporting was done in Central Europe.**

**For haulage in long and straight roadways, mining cars can be driven by a revolving rope on which clamping devices fasten the cars. The circulating haulage cable or chains can run along the roof or bottom and are guided by track carrier rollers.**

**Finally, mining cars are pulled by locomotives which operate with an electric drive as trolley or battery locomotives, with compressed air and, as an exception, driven by diesel engines. All locomotives are very costly, heavy and involving much expense in technique, maintenance and repair, etc.**

**Turn sheets:**

**To change direction, the mining car is pushed on a turntable which is comprised either of a flat conical disc or of a plate With adopted rails. If the car stands on the**

**plate, it is turned around by hand and the car is pushed on the railway to a new direction.**

### **Vertical switch:**

**Vertical switches are used to connect ramps with floors or sublevels which can be tipped up or down to let cars go under. Thus, the use of mining cars for roadway haulage as containers for ramp or inclined shaft haulage, is possible without reloading. The haulage cable has to be hooked at the mining car with a safety hook.**

### **Roof shunts:**

**Roof shunts are used in vein ore small-scale mines, where only one railway goes to the heading. To handle two or more cars coming in and going out, it should be possible to put an empty car at the side if the car at face is loaded. The roof shunt now offers an opportunity to hook the empty car and lift it up from the rails with block and pulley or by a pneumatic hoist and switch it sideways. In case the loaded car has already passed, the lifted car is then put back on track.**

**Haulage in ramps and shafts is done either trackless or track bound analogously. In a trackless haulage, a mine car either simply runs on proper ground (only short distance) or a haulage container slides along wooden bars. In a track bound haulage, the rails are laid within the ramp. In steep ramps, the track system, especially the rail sleepers also as a manway. What is important is to install passing places in case miners have to pass by the mine cars. The mine car then runs along the railway pulled by a hauling cable.**

**REMARKS:****Mining cars:**

**Villefosse introduces an English mine car without its own dumping device that can be opened at the backside and dumped at the unloading point. Counter weights with right dimensions simplify the handling. The car has brakes.**

**For mines with shaft haulage, mine cars can also be designed so that the kibble can be carried on its chassis thus, avoiding multiple reloading.**

**With rail nail, two big wheels under the center of gravity plus two small ones. Driving is done on two wheels.**

**For hauling in ramps and slopes and in case the hauling cable or rope breaks, it is proposed to install fishing hooks or gripping devices which fall into the bottom or in front of sleepers to apply brakes or derail the car, thus avoiding its speeding down.**

**Steel rails and switches:**

**For haulage with cars pushed by hand without drive, the right falling gradient should be  $> 0.5^\circ$  to the opening. The same also applies for water supply and drainage.**

**Falling gradients of railways for full mine cars (by Gerth, Salzmann):**

straight railway 1.2 %



curves	1.8 %
switches	1.8 %
switches in curves	2.0 %

### **Track gauge: normal 600 mm**

$$\text{Superelevation in curves : } h = \frac{8v^2[\text{km/h}]}{R[\text{m}]} [\text{cm}]$$

**In roadways with 1.5° to 3° falling gradient, haulage without driving machines can be done by stopping the cars with brake billet or brake devices. Higher gradients even make difficult the upward movement of empty cars.**

**To manage higher gradients in slopes, counterweights or shuttle operation are appropriate to pull up empty cars by using the weight of loaded cars running downward.**

### **Roof shunts:**

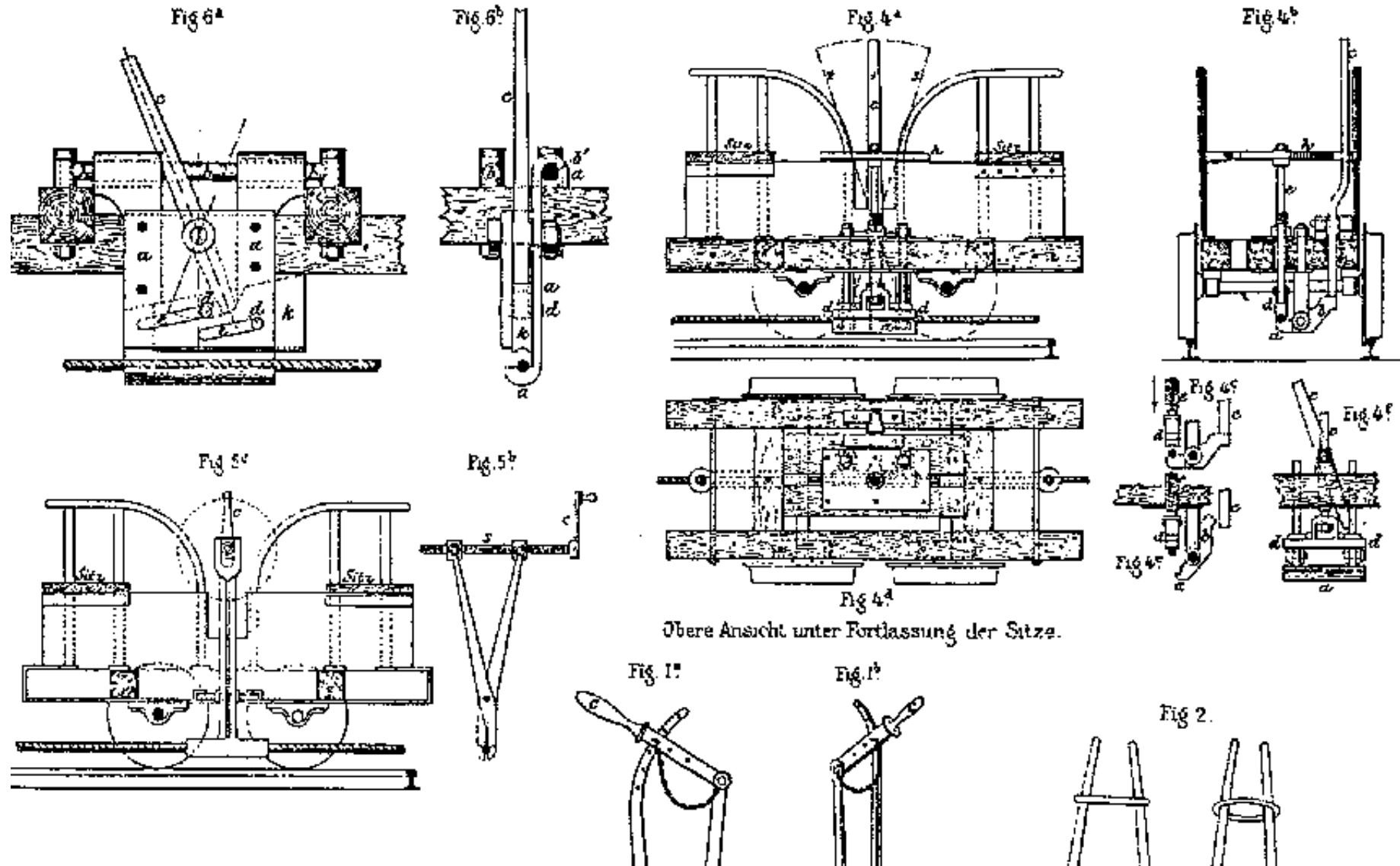
**Roof shunts need a very small space. They can be used wherever the width of gallery allows without making changes in the railway.**

### **Haulage in working:**

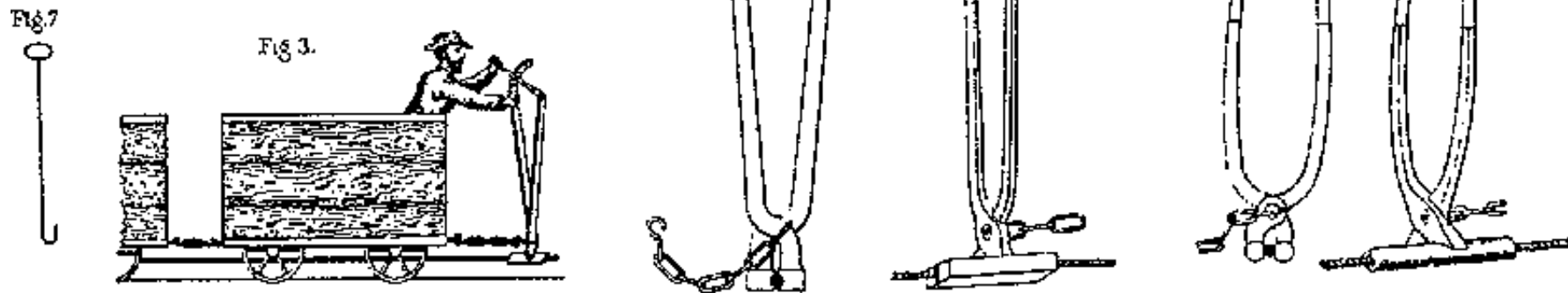
**Haulage by hand trams with 1/3 - 1/4 of the capacity of that of mining cars in 3 - 30 falling ways along the bottom or on wooden tramways which can also be moistened to reduce friction. Trammed by a shoulder belt.**

# Haulage in steeper roadways (15° - 40°): application or use of chutes made of wood or of iron plates.

In galleries or rise drifts with > 45° falling, gradient materials will fall along roller tracks.

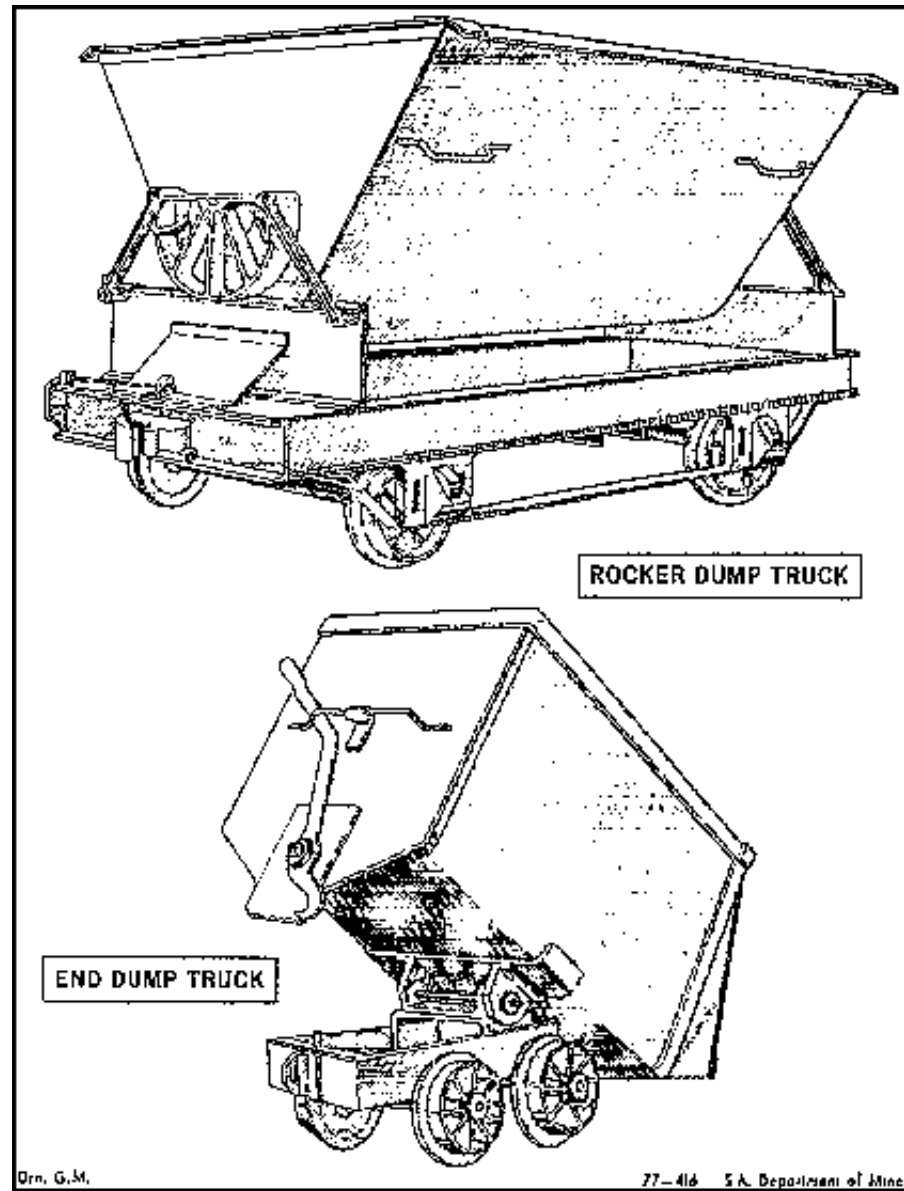


Obere Ansicht unter Fortlassung der Sitze.

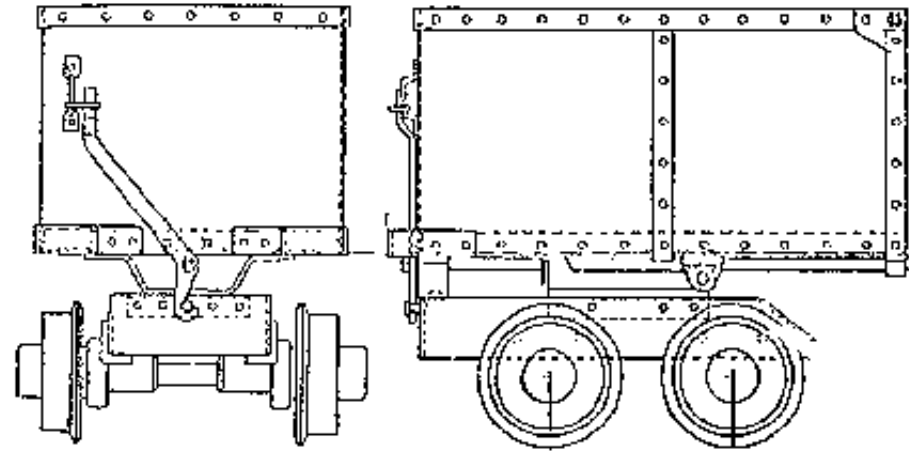


**Fig.: Hauling with a cycling ground rope. Source: Lengemann.**

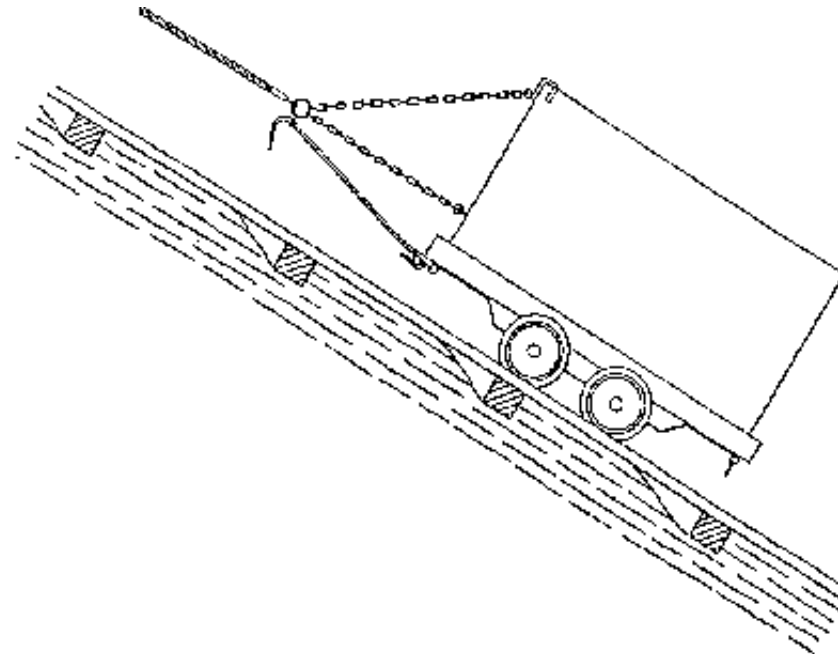
**Fig. 1 and 2 clamping device. Fig. 3 demonstrates, how to handle the clamping devices shown in fig. 1 and 2. Fig. 4 operators car with clamping device by Ramsay. The rope can be clamped between jaws a, b and d with the hand wheel h (Fig. 4a,4b,4c), if lever c is in the position 1 (fig.4a). The rope is being disconnected, if the lever c is brought into position 2 and 3; the lower jaw a, b that is designed as a lever loses its support and goes back into the position shown in Fig. 4e and Fig. 4f. Fig. 5 operators car with clamping device of mine Ironstone of Tredegar corporation in Wales. The screw spindle s that is rotated by hand crank c clamps or disconnects the rope. Fig. 6 clamping device by Hanson is fixed at the iron rods bb' of operators car. The clamping of the rope is done with wedge k that is guided by bolts in the slots e and handled with lever c. At the clamping devices shown in Fig. 4 and 5 an automatic disconnection from the rope can be realized by placing barriers at the ends of the track which hit lever c or the handle of crank c. Since an operator is not needed anymore seats are useless. The hooks shown in Fig. 7 are to connect the rope with the clamping devices that are shown in Fig. 4 - 6.**



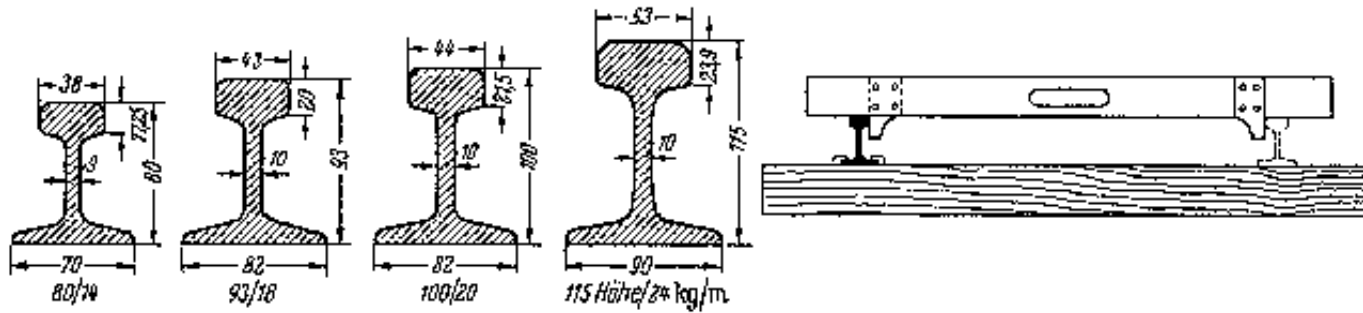
**Fig.: Mining cars; above rocker dump truck; below, end dump truck. Source: Armstrong**



**Fig.: End dumping truck; left, back view; right, side view. Source: Bernewitz**



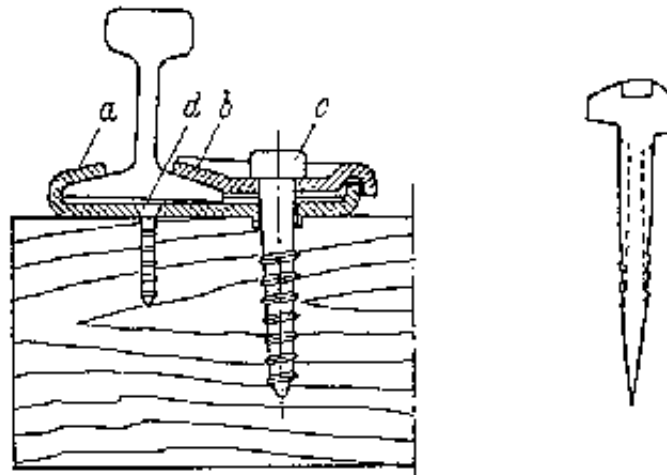
**Fig.: Mining car with fishing hook. Source: Treptow**



**Figures**

**Fig.: Wings rails, common shape. Source: Fritzsche.**

**Fig.: Gauge for rail laying. Source: Fritzsche.**

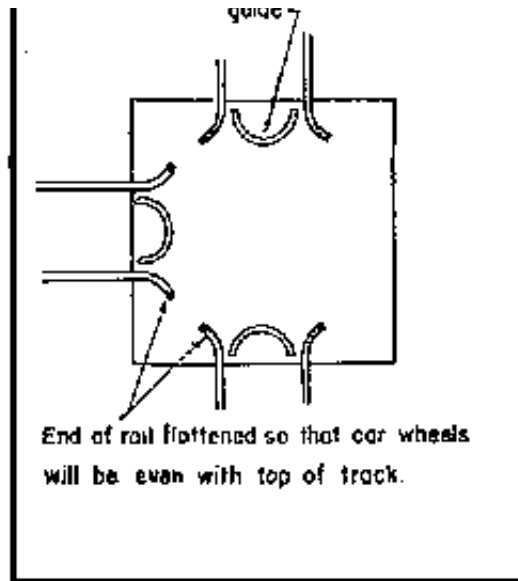


**Figure**

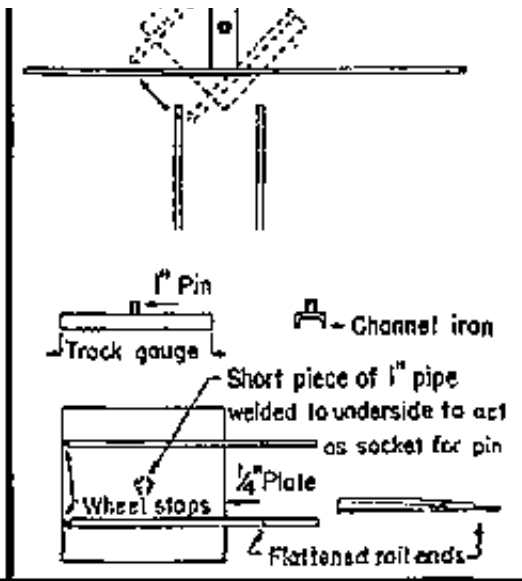
**Fig.: Attachment device composing of three elements; Scheidt Company, Essen-Kettwig. Source: Fritzsche**

**Fig.: A hammer head nail. Source: Fritzsche.**

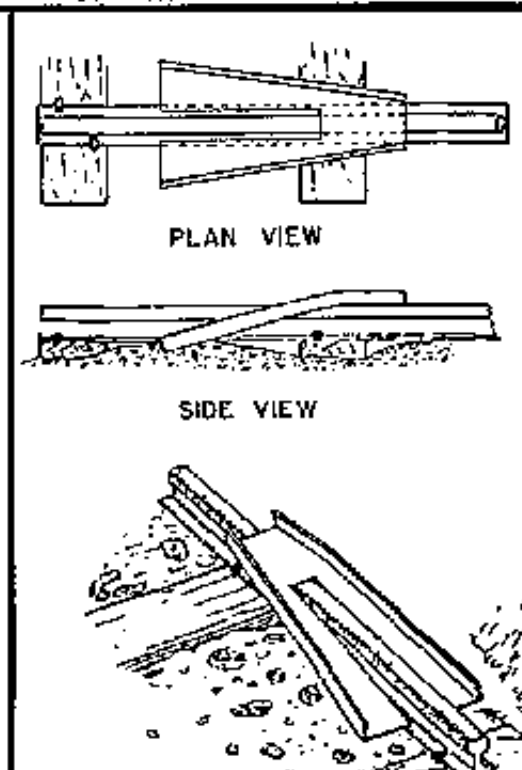
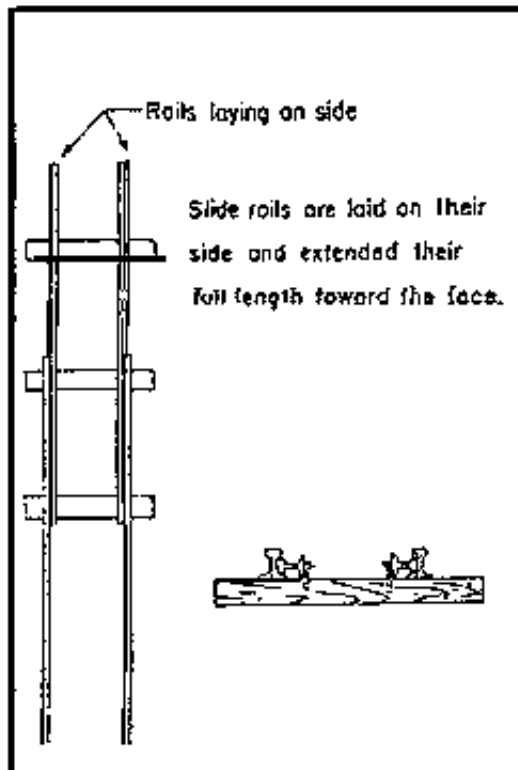




A. TURN SHEET



B. TURNTABLE FOR SMALL CARS.



C. TRACK EXTENSION IN FACE. D. SMALL CAR RERAILER.

**Fig.: Swiches and rails. Source: Stout.**

Above left: rigid turning device for mining cars;

Above right: simple turntable;

Below left: track extension in face;

Below right: retailer.

## 9.5 Passenger lifting moving ladder

### Deep Mining Underground Mining Hauling

germ.: Fahrkunst

span.: ascensor rosario en vaiven

<b>TECHNICAL DATA:</b>	
Dimensions:	up to 800 m depth (Samson Mine in Harz)
Weight:	very high
Driving Capacity:	for example 5 kW for more then 200 m depth in Samson Mine
Form of Driving Energy:	electric or mechanic ( very low R.P.M. needed, e.g. water wheel)
Throughput/Capacity:	freuency: 6/min



Operating Materials:	
Which:	lubricants
<b><u>ECONOMICAL DATA:</u></b>	
Investment Cost:	high
Consequential Cost through Coupling Effects:	aggregates for power supply

### **CONDITIONS OF APPLICATION:**

Operating Expenditures:		low  ----- ----- high
Maintenance Experience:		low  ----- ----- high
Replaceable Equipment:	all hoisting systems for passengers	
Regional Distribution:	historical technique, today only in Samson Mine in Harz, in Samson-Museum	
Experience of Operators:		very good  ----- ----- bad
Environmental Impacts:		low  ----- ----- very high
	only from energy supply	
Suitability for Local Production:		very good  ----- ----- bad
Under what Conditions:	wood manufacture	
Lifespan:		very long  ----- ----- very short

**Bibliography, Source: Samson-Museum, St. Andreasberg, Treptow, Gentz,H., Die Fahrkunst des Oberharzer Bergbaus in Bergbau-Rundschau, Jg. 7, 83 ff.**

## **OPERATING PRINCIPLE:**

**Passenger lifting moving ladder is a system of hauling passengers in a vertical or inclined shaft. Two pairs of ropes or rods (wood, steel) are driven counter wise up and down by an approx. 1.5 - 2 m wheel. Frequency is very low (approx. 5 - 10 min<sup>-1</sup>). Foot boards and handles are attached on the rope pairs every 3 - 4 meters. At the moment the movement reverses, foot boards of both rope pairs are facing each other in one level due to the counter movement. Upward or downward haulage is then possible by transferring systematically from one pair to the other. Ropes lead through intermediate platforms in the shaft which serve as safety installations. Every 30 - 50 m, a catch fork secures the rope pairs against falling by broken rope. In inclined shafts, rope pairs are guided over slide boards or rollers.**

## **REMARKS:**

**In deep mining in the Harz region, the introduction of the moving ladder considerably reduced travelling and therefore contributed to increased efficiency in mining operations. Invented by Drell in Zellerfeld/Harz in 1833.**

**In vein ore mining, haulage shafts usually are drifted in ore. Only moving ladders allow a mechanized passenger lifting in these shafts where falling gradient often changes.**

**The balanced weight of both rope pairs of the moving ladder has its real advantage of having to overpower only friction, the weight of travelling miners, and weight of 3 · 4 m rope. The driving energy may remain low.**

**In Harz, the ropes were preserved with a mixture of grease and beeswax. This**

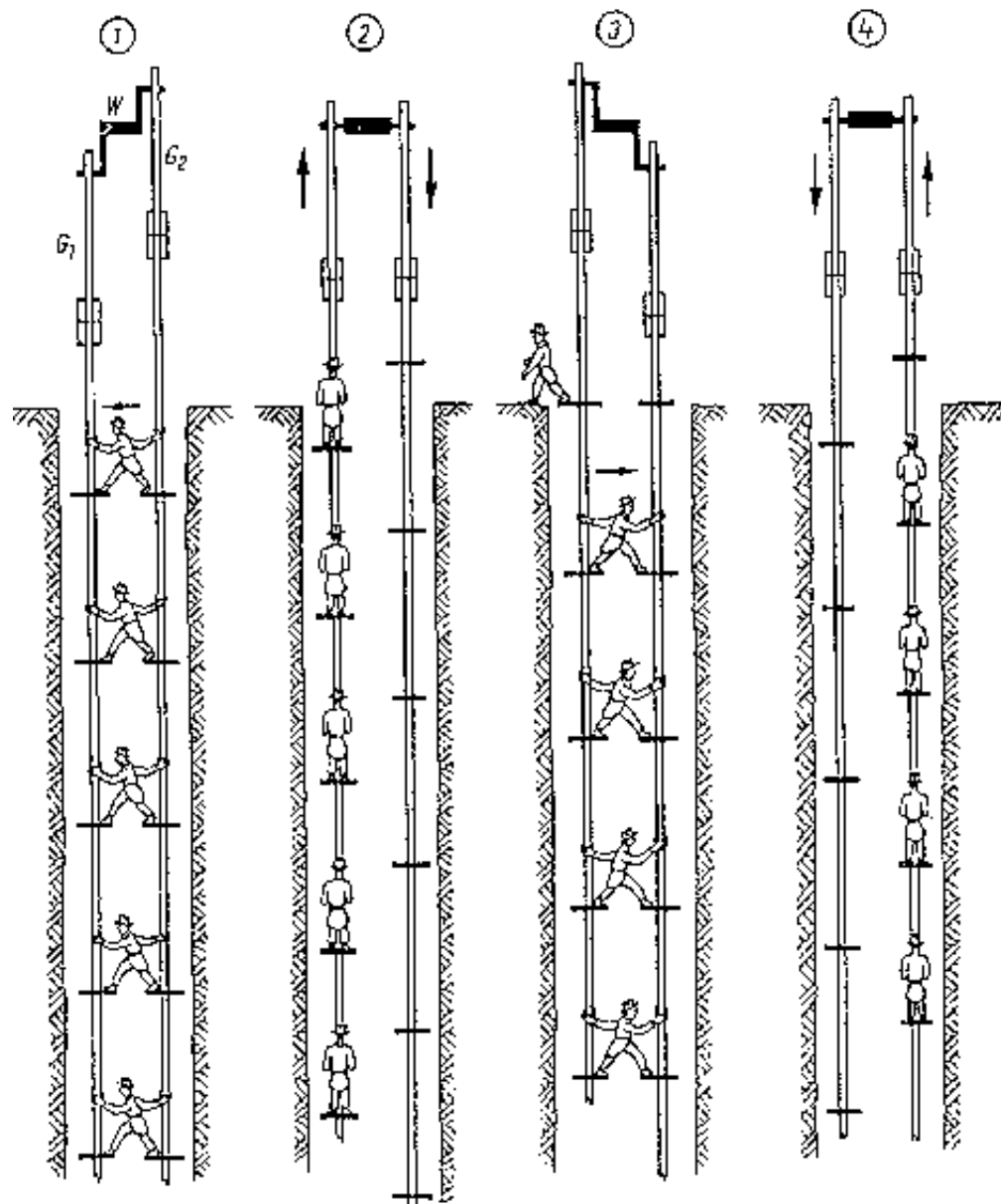
**mixture gave a more than 50 years of protection from corrosion.**

**Wire cables were designed so as to reduce into a smaller diameter downwards. This reduced the weight of the ropes.**

### **SUITABILITY FOR SMALL-SCALE MINING:**

**Moving ladder is the right mechanized passenger lifting system for deeper shafts, but needs the installation of a haulage system for materials in a parallel shaft.**

**Schematic draw of function of a moving ladder during miners going out of the shaft W crankshaft, driven by water wheel or steam engine, G1G2 both, the up and down moving rods of the ladder, 1 and 3 dead centers of rod movement: The miners step over to then upwards going rod or they step out at surface, 2 the left rod is lifted with miners, 4 the right rod is lifted with miners. Additionally for protection in the passenger lifting shafts ladders have been installed.**



**Fig.: Moving ladder. Source: Wagenbreth.**

**Schematic draw of function of a moving ladder during miners going out of the shaft W crankshaft, driven by water wheel or steam engine, G<sub>1</sub>G<sub>2</sub> both, the up and**

**down moving rods of the ladder, 1 and 3 dead centers of rod movement: The miners step over to then upwards going rod or they step out at surface, 2 the left rod is lifted with miners, 4 the right rod is lifted with miners. Additionally for protection in the passinger lifting shafts ladder have been installed.**

