

Forming Techniques for the Self-Reliant Potter (GTZ, 1991, 194 p.)

6. Mouldmaking and Plaster of Paris

 **(introduction...)**

 **6.1. STAMPS**

 **6.2. Moulds for plastic clay pressing, biscuit clay moulds**

 **6.3. Plaster substitutes**

 **6.4. Plaster of Paris**

 **6.5. Plaster mould making**

Forming Techniques for the Self-Reliant Potter (GTZ, 1991, 194 p.)

6. Mouldmaking and Plaster of Paris

The use of moulds in ceramics is as old as ceramics itself. In fact, it seems likely that people were pressing soft clay onto hard objects even before they discovered how to fire it (baskets sealed with clay, etc.), or pressing hard objects into soft clay to make designs. When useful objects started to be made from clay, it was a logical step to use simple moulds so as to easily get the same shape every time.

What is a mould?

A mould is simply the shape of the space which surrounds an object to be

produced. Because space itself has no form, the mould must be made from a rigid material such as wood, metal, biscuit-fired clay, stone, or, most commonly, plaster of parts. Moulds include those which are used to actually form a product (moulds for containers, sculpture, etc.) and stamps, which are used to produce a relief design on an already-formed product.

Porous moulds

Moulds made from plaster absorb moisture from plastic clay or from liquid clay.

This causes the clay to shrink after forming in the mould and it makes it easier to remove the moulded item. Biscuit clay moulds are also porous but to a much lesser

6.1. STAMPS

Stamps are also called "chops", and are the oldest tools used for decorating or writing on clay products. Usually, they are made from wood or biscuit-fired clay.

roller stamps

These are special stamping devices, which are used for making bands of decoration quickly. They are made from biscuit-fired clay or plaster, and mounted on a wooden or wire axle so they can be rolled on a pot.

metal stamps

It is also possible to use metal stamps for impressing your company name, for

example. This is usually a good idea, because customers like to buy names that they know or that their friends have recommended to them. These stamps can be ordered from printing shops.

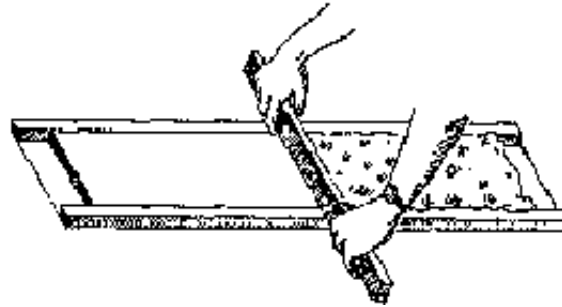

FIGURE 6.1-A Making a plaster roller stamp.(A)

A) Make a long smooth clay slab.

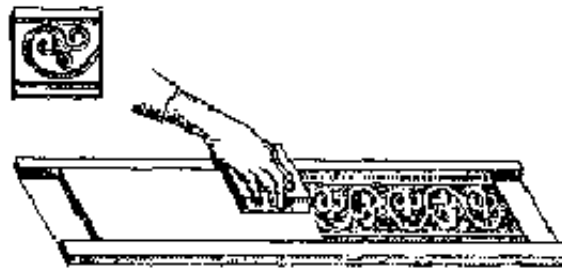

FIGURE 6.1-A Making a plaster roller stamp.(B; C)

- B) A pattern is impressed by band or by a stamp as shown**
C) The clay slab is left to dry until it can be easily removed.

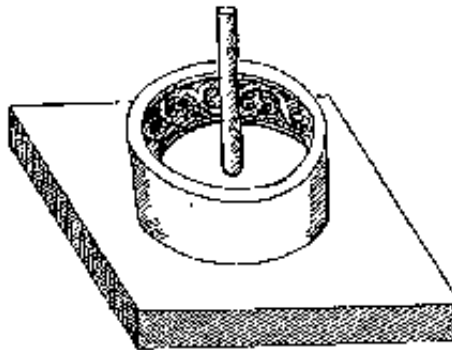
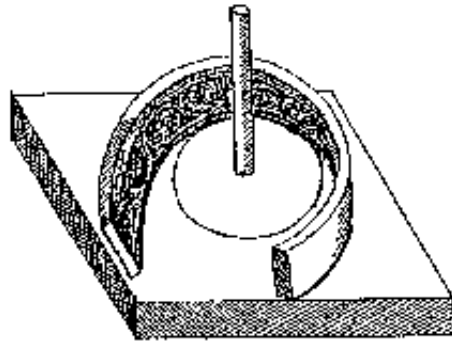

FIGURE 6.1-A Making a plaster roller stamp.(D)

- D) Form the slab into a cylinder with a stick set in a clay slab exactly in the center.**

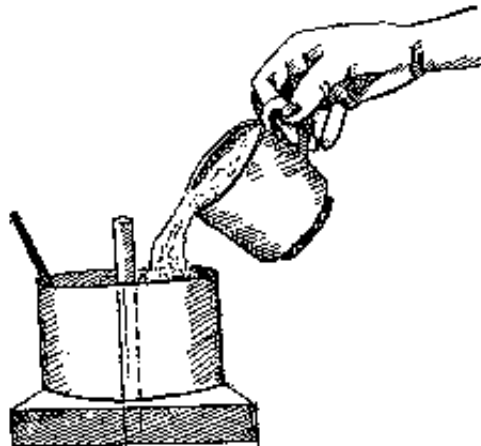

FIGURE 6.1-A Making a plaster roller stamp.(E)

E) Fill the cylinder with plaster.

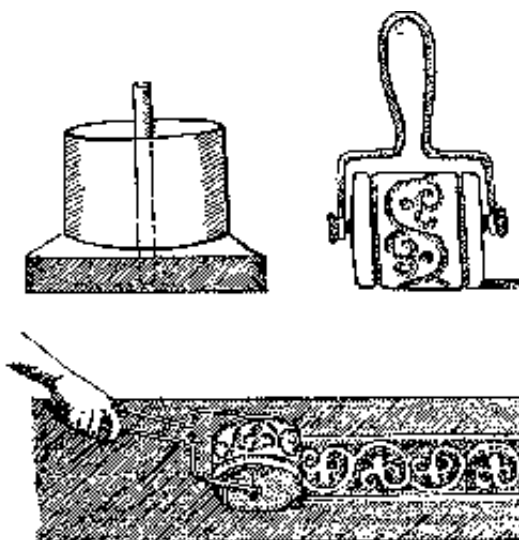

FIGURE 6.1-A Making a plaster roller stamp.(F; G)

F) After setting, the clay is removed and the cylindrical plaster roller is ready to be fitted with a handle

G) The roller used for decorating a clay surface.

6.2. Moulds for plastic clay pressing, biscuit clay moulds

6.2.1. ONE-PIECE MOULDS

6.2.2. PIECE MOULDS

6.2.1. ONE-PIECE MOULDS

moulds for simple forms

These are moulds used to produce simple open forms, such as bowls, plates and tiles. They consist of one simple curve, and often have relief designs carved into them. Hump moulds are used for forming slabs of clay. They are mostly used for forming shallow bowls, or they may be used on the potter's wheel for making plates.

Moulds for jigger use are also one-piece moulds, and are described below.

fired pots as moulds

The simplest kind of one-piece biscuit mould is another fired pot. Most traditional potters who use the coil and beating method use curved sections of broken pots to shape new ones. In parts of Nepal, water jars are still made by covering an old water jar with cloth, then applying clay all around it. When the clay is leather-hard, the pot is cut in two pieces, removed from the mould, and joined back together. This makes quite a rough product, but it works successfully in small villages where women make pots only for their own household.

detailed biscuit moulds

More sophisticated and detailed one-piece moulds are made from biscuit-fired clay.

The process is not complicated. First, the object to be moulded (model) is selected: this may be a model in stone, wood, or usually also biscuit-fired clay. Stone or wood usually needs a light dusting of talcum powder or clay powder to keep the mould from sticking to it. A slab of clay about 3 cm thick is carefully pressed around the model, making sure that it is pushed into all the details. Excess clay is then cut off, and the mould is left to dry until it can be carefully removed. After drying completely, it is biscuit-fired in the usual way and is then ready for use. As with all moulds, the model has to be free from undercuts that will prevent the mould from being removed. Undercuts are places that hold the clay, such as deeply carved lines, or parts that stick out from the model.

biscuit mould shrinkage

It should be remembered that the mould will shrink (up to 10 %) and that the casting taken from the mould will also shrink up to 10 % or more, so the total shrinkage compared to the model can be 20-25 %! For this reason, the size of the model needs to be considered carefully.

wooden moulds

Moulds can be made from wood. Fig. 6.2.1C shows a cylindrical wooden mould that forms the inside of a water filter container. First the bottom is made from a slab of clay and the mould is placed on this. Another slab of clay is wrapped

around the mould and the slabs are joined together (see chapter 4.2.2). After joining from the outside the wooden mould is pulled out and the joins are worked over from the inside. The outside finishing can be done on a wheel, while the mould is still in place.

hinged mould

A mould forming the outside of a flowerpot (Fig. 6.2.1-D) can be made from pieces of wood hinged together. The pot is formed by joining slabs inside the mould. The pot is released by unfolding the hinged mould.

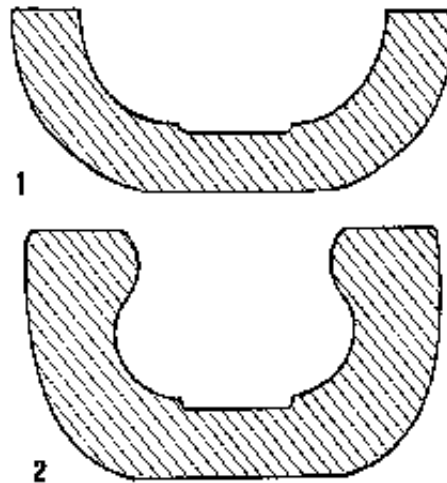

FIGURE 6.2.1-B A mould (1) without undercuts allows easy release. The other mould (2) has undercuts and cannot be released. This shape has to be made with a two-piece mould.

6.2.2. PIECE MOULDS

two-piece-mould

Simple closed shapes can be formed in two piece moulds, such as vases, bottles and even more complicated forms. Early South American pottery was formed exclusively in two-piece biscuit moulds.

As above, the mould is made from a model, which is either bone-dry clay or biscuit clay. The main thing is to carefully locate the midline of the model, and to actually draw this line on the model. Then, a 3-cm thick slab of clay is wrapped and pressed around half of the model, extending slightly beyond the midline. This is allowed to dry until leatherhard, and then is accurately cut with a knife along the midline. Several slight indentations are made on the edge of the mould, to serve as "keys" to lock in the second half. The second half is then pressed onto the model, and also must be carefully pressed up against the other mould half. It is next dried until leather-hard (it may be necessary to cover the first half in plastic) and both halves are carefully removed, checked to see that they still fit correctly, dried and fired.

using two-piece moulds

Forming in a two-piece mould is the same as described for pipes, above. Slabs are carefully pressed in both halves of the mould, then are trimmed off just above the mould edge. After they are slipped and scratched, the mould is pressed together, and the inside seam is worked together with a wooden tool (if possible).

two-piece water jar mould

An interesting variation on this process is used for making water jars in parts of northern India. The mould consists of two halves of the jar, divided along the

belly. One half has an opening in its center the size of the water jar neck. This mould half is fastened on the potter's wheel, and clay is centered and thrown in it. The same is done in the other half. The neck half is then joined to the bottom (on the wheel), and the neck is opened up and pulled to form the mouth. The assembly is allowed to dry until leatherhard, when the mould is removed and any finishing is done. The mould for the shoulder of the pot usually has a relief design carved into it.

plaster moulds

These simple moulds can also be made from plaster of parts. The only difference is that the model needs to be leather-hard clay, or it has to be coated with a separator (see plaster moulds below). Usually the easiest is leather-hard clay, which the plaster can be removed from easily - note, however, that in this process you lose your model.

The midline is located as above, and a strip of clay is placed with one edge coming just up to it. This strip has keys pushed into it. Plaster is applied on this half, and after setting, the clay divider is removed and the plaster is coated with liquid soap separator. Plaster is then mixed and applied to the other side. After it sets, the mould can be smoothed and the plaster carefully removed.

plaster throwing

The main trick is applying the plaster so that it gets all the details. This is done by "throwing" the wet plaster on the model, which is done "backhanded" while the plaster is still thin. This first thin coat is allowed to set, and when the plaster is a

bit thicker, a second coat is applied the same way. When the plaster starts to become plastic, it is applied and smoothed by the handful, until the mould is 3-5 cm thick.

multipiece mould

Complicated forms with many undercuts can be made in a mould made up of many pieces. The mould is made in a similar way as described for casting moulds (chapter 6.5.2). Forming in the mould is done by building up a layer of soft plastic clay inside the mould. The mould is opened when the clay is hard enough to support itself.

6.3. Plaster substitutes

There is no really good substitute for plaster of parts, but in areas where this is very expensive, of poor quality, or unavailable, moulds for pressing plastic clay can be made as follows:

cement mould recipe

PARTS BY VOLUME

Common cement 1 part

Common clay 40 mesh 1 part

Common brick grog 40 mesh 5 parts

Fiber 0.5% by weight

Almost any fiber can be used (jute, coir, cotton, animal hair, nylon, etc). This should be in the form of separate fibers, cut into about 3-6-cm lengths. The

purpose of the fiber is to give the mould strength.

The materials are mixed with water to standard cement consistency, and this is then applied to the model like plaster. It is not suitable for very detailed moulds.

These moulds are useful for large items, such as pipes. For small items, it is probably better to use biscuit clay.

6.4. Plaster of Paris

6.4.1. GYPSUM

6.4.2. PLASTER OF PARIS PRODUCTION

6.4.3. SHIPPING AND STORAGE

6.4.4. MIXING PLASTER OF PARIS

The word "plaster" means a substance which, like clay, can be moulded to almost any shape when soft, but either dries or cures to a hard material. Clay and cow dung mixtures used for surfacing walls and floors are called "clay plaster", and this material simply dries (with some shrinkage) to a hard material. However, it can be made plastic again by adding water. Lime plaster and gypsum plaster have the special quality of "curing" after they are mixed, which means they undergo a chemical reaction that makes them hard, so that even if placed in water, they will not become soft again. On heating to 120°C gypsum releases about 20 % of its weight as water. This chemical reaction can be written thus:



In words: gypsum + heat = plaster (and water which goes into the air).

When the plaster is mixed with water the process is reversed and the plaster returns to its original gypsum state and becomes hard.

“Plaster of Paris” is the type of plaster used for making moulds for ceramics. It was developed in France around 1770, which gives it its name. With the use of plaster of parts, the ceramics industry was revolutionized, because it made possible mass production by slip casting, which was previously unknown. Plaster of parts has the special property of easily absorbing large quantities of water, and there is no other material that can be substituted for slip casting.

6.4.1. GYPSUM

The raw material for making plaster of parts is gypsum, which is hydrous calcium sulfate ($Ca_2SO_4 \cdot 2H_2O$). Gypsum deposits are found in most countries. Very simply, making plaster is done by grinding the gypsum, and then heating it until chemically-bonded water evaporates at $110^\circ C$. This is similar to the process of making lime, which is known in most countries. It can be done on a very simple level, but industrially is done on a large scale and controlled in a sophisticated way.

6.4.2. PLASTER OF PARIS PRODUCTION

It is normally not worthwhile to produce your own plaster if ready-made plaster is available. In several countries this is not the case and the potter may have to make his own plaster from gypsum. Often he will be able to sell his plaster in the local market to other potters or to manufacturers of writing chalk.

raw gypsum

Gypsum is a soft rock that may occur as transparent or slightly white to grey crystals, and sometimes as fibrous granules. Several geological varieties exist: selenite is a clear crystal; satin spar is white and fibrous; alabaster is massive and normally white; and gypsite is a mixture of gypsum and white sand. The crystal form can be scratched with a finger nail, which produces a white line. Gypsum is also used by the cement industry, and in some places farmers use it as a source of calcium for the soil. Deposits of gypsum are rarely pure and the gypsum content may be only 65 % of the bulk material, the rest being impurities of lime, clay or sand. The purer the raw gypsum the better the finished plaster product will be. If possible, check the deposit of gypsum before taking delivery and explain to the supplier that you only want the clear crystals.

recalcing plaster

Old plaster moulds can be ground and recalced, since already-set plaster is gypsum (chemically speaking). This should only be tried if raw gypsum is not easily available or very costly, since the quality will not be as good as with freshly-calcined gypsum.

Production moulds get contaminated with deflocculants and clay. First the moulds are cleaned of clay, dust and deflocculant crystals deposited on the mould surface. The moulds are then crushed and the fine lumps are washed in water, which will remove the soluble deflocculants. After drying, the material is processed as described below. The quality of recycled plaster is not as good as plaster made from raw gypsum and the extra cost of cleaning the old plaster should be

compared with the cost of fresh raw gypsum.

gypsum calcination

First, wash away sand, clay and other impurities from the raw gypsum. The gypsum is then pulverized in a hammer mill. Smaller quantities are simply heated in a pan and when the gypsum starts to boil it is stirred gently until all of it has been boiled. It is difficult to judge when the gypsum has been heated enough - it is better to overheat slightly.

first & second set

Gypsum starts boiling around 120°C s. Original S. 112 and more water is released.

Plaster that has been through this "second set" is less plastic than "first set" plaster on the other hand it is stronger. With simple equipment like a pan it is not possible to control when the "first set" is over, because some of the plaster in the bottom of the pan starts boiling again before all gypsum has been through the "first set". Generally, it is better to have some "second set" plaster, rather than risking uncalcined gypsum, which will weaken the plaster moulds and shorten the time it takes for the plaster to harden after mixing with water.

calcining kettle

For making larger quantities, a kettle for calcining can be made locally. A cylindrical pan made of brickwork or sheet metal is set inside an oven heated from below. Mechanical agitators stir the gypsum to ensure even heating. A thermometer inserted in the gypsum enables the operator to know how the

calcination is progressing. At around 120°C boiling starts and the temperature in the upper layers will drop to around 100°C until the first set is finished. Then the temperature will rise again to 170°C when the second boiling starts. If heating is too fast, it may be difficult to recognize that the boiling of the "first set" has stopped before the second starts. In Burma we went through the "first set", and after seeing the temperature rising again we heated until the gypsum started to boil. We then let this second boiling go on for about 15 minutes (600 kg batch) before ending the heating. The agitators were left to stir for another 20 minutes to allow all moisture to evaporate.

screening & storing

After cooling, the plaster is screened through 60-100 mesh and packed in bags, which are stored in a dry place. If the plaster becomes moist it will set and be spoiled in the bag.

Freshly-boiled plaster requires more water to become fluid, resulting in moulds that are porous and weak. After some weeks ageing the plaster will absorb a little moisture from the air and this will enable a plaster mixture to be produced with less water. For this reason it is better to store the freshly calcined plaster for 1-4 months before using it. In industrial production, a small amount of dissolved deliquescent salt is added to the plaster during calcination and this has the same effect.

industrial production

Plaster is widely used in industrialized countries. Large-scale plants either use big

kettles holding up to 20 tonnes or rotary kilns. In principle the process is the same as the one taking place in a simple pan, only much better controlled and yielding a plaster of consistent quality.

setting times

Plaster is often available with different setting times. For example, U.S. suppliers can provide "20-minute casting plaster" or "30 minute casting plaster", and offer more than 30 different types of plaster and gypsum cement. For specialized model making, these products are often useful.

Setting time can be retarded and speeded up by addition of chemicals. Retardants are sodium carbonate, vinegar, dextrin. Accelerators are warm water and salt. For specialized model making, this is often useful, but normally it is better to use the plaster without any addition since this reduces its strength. Small amounts of uncalcined gypsum will speed up the setting time. Shorter setting time is a sign that your plaster is not stored properly and has become too old.

gypsum cement

A special plaster is produced by calcining the gypsum under pressure in an autoclave to 120°C. The calcining thus takes place under humid conditions and this produces plaster with a special crystal structure (alpha plaster) that makes the finished set plaster much stronger, as more plaster can be added to the water. This type of plaster is, of course, more expensive, but the extra cost is justified when used for model making and for block and case mould production. It is essential for moulds used in the ram press.

Plaster suppliers offer many different qualities made from mixtures of ordinary plaster (beta plaster) and gypsum-cement plaster (alpha plaster). However, in many countries only one quality is available.

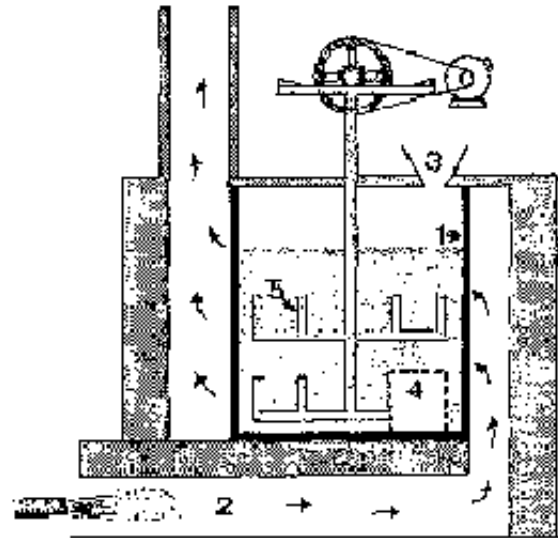

FIGURE 6.4.2-C.1 A steel kettle (1) is placed on top of a firebox (2) inside a brickwork cylinder. Gypsum is loaded at (3) and plaster is discharged through a door at (4). Stirrers (5) rotate at 15 r.p.m.

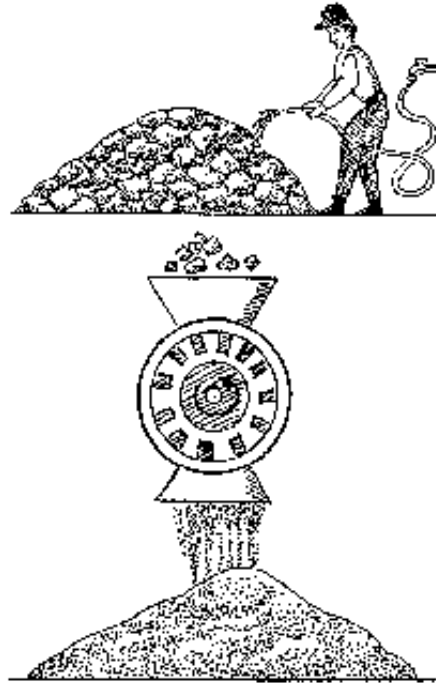

FIGURE 6.4.2-D Work flow of gypsum calcining (A; B)

- A) The raw gypsum is cleaned.**
- B) Gypsum is crushed in a hammer mill.**

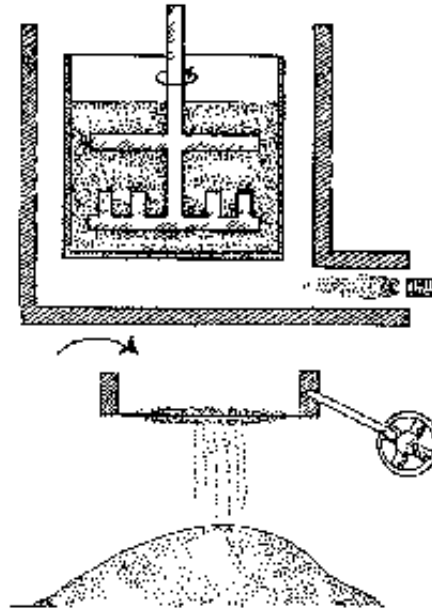

FIGURE 6.4.2-D Work flow of gypsum calcining (C; D)

C) Gypsum is changed to plaster in a calcining kettle.

D) Screening on a fine sieve. Residue is reground in a hammer mill.

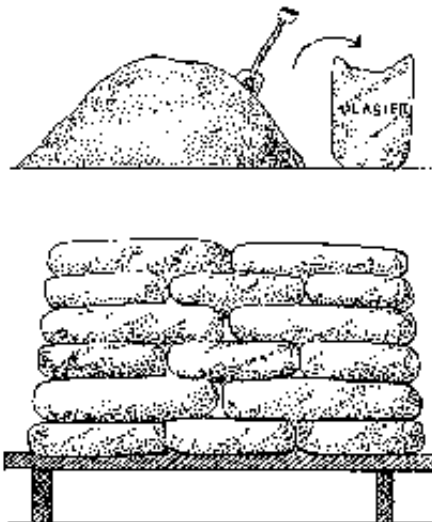

FIGURE 6.4.2-D Work flow of gypsum calcining (E; F)

E) Screened plaster is packed in bags.

F) Plaster is stored in a dry place.

6.4.3. SHIPPING AND STORAGE

Because plaster of parts is easily damaged by water, care should be taken with shipping and storage.

If you must order plaster of parts in some quantity, it is better not to order more than 6 months' supply at a time. Request the supplier to provide it in polythene-lined bags, or in sealed drums. Plaster should be stored above the floor: bags may be placed on top of boards, to allow air circulation below and prevent any water from getting into the bags. It should not touch the wall. It also should be stored so that the oldest plaster is used up first.

6.4.4. MIXING PLASTER OF PARIS

When mixing plaster, it is very important to always use the same amounts of water and plaster powder. If more water is used, the strength will be less and the water absorption greater. Less water will make a thicker mixture, which will be stronger and which will have less water absorption. This will cause problems in the slip casting section, with moulds casting at different speeds.

plaster to water ratio

The strongest mixture of standard quality pottery plaster is 70 parts (by weight)

water to 100 parts plaster. This is used for case moulds. Working moulds used for jiggering and casting are mixed with 75 - 80 parts water to 100 parts plaster. Where plaster is expensive it is better to use a high proportion of plaster, because the working moulds will last longer.

Plaster used for bats or dewatering trays are mix with 90 parts water to 100 parts plaster.

Gypsum cement (alpha plaster) can be mixed with only 40 parts water to 100 parts plaster. This produces a very hard plaster with high expansion and low absorption, ideal for master and case moulds.

The right ratio of water to plaster cannot be fixed. It will vary from one source to the next and from batch to batch. So every new batch should be tested and compared with the last batch.

rules for plaster work

RULE 1: ALWAYS WEIGH THE PLASTER AND THE WATER !

Most mould makers get lazy after a time, and start to just estimate the amounts. Sooner or later, they will make mistakes, and the casting section will have problems. PROBLEMS COST MONEY!

RULE 2: NEVER PUT WET HANDS OR TOOLS IN THE PLASTER BAG !

Always use a dry bowl or spoon when taking plaster from the bag. Any moisture will cause the plaster to set in the bag.

RULE 3: AFTER STARTING TO MIX, NEVER ADD MORE WATER !

After you start to mix plaster, the chemical reaction begins immediately. Sometimes, if the plaster starts to get thick too soon, the mould maker will try to add water to make it thinner. This doesn't work - the mould will be soft and may never set.

RULE 4: DO NOT PUT AIR BUBBLES IN THE PLASTER !

Air bubbles are Enemy Number One of the mould maker. If they are on the surface of the mould, the quality will be very bad. Follow the instructions below for mixing plaster very carefully. Air bubbles do not come from the plaster - they come from the hands of the mould maker.

Here is the detailed work process for mixing plaster of paris:

1 containers

For good quality moulds, it is important to have clean tools. Always use a clean container to mix the plaster. Plastic buckets are best, because they are easy to clean. Dirty tools and mixing containers will result in poor quality moulds. Tools should be washed immediately after use.

2 weighing

Always weigh the water first, and then add the correct amount of plaster by weight. Experienced mould makers think that they can estimate amounts correctly. This is not true: usually mistakes will be made, and the quality of

moulds will be uneven. Temperature of water is also important. Cool water means slow setting; hot water means fast setting.

3 sieving

Plaster should be sifted into the water through a coarse sieve to remove big particles.

4 mixing time

The time for mixing and pouring should always be the same. After plaster is added to water, it should be left without stirring for 2 minutes. This allows the plaster particles to absorb water. At the same time, air bubbles rise to the surface.

5 by hand or machine

Hand-mixing is satisfactory for amounts under 3 kg. Larger amounts should be powermixed. The mixer should force plaster from the bottom tip-not suck air into the mixture.

In hand-mixing plaster, it is important to stir the plaster quickly, but not to mix air into the plaster. First put your hand slowly into the plaster. All mixing should be done from the bottom with the fingers. The hand should not come above the surface of the plaster.

6 pouring plaster

Pouring the plaster into the mould should be smooth and steady, so that air

cannot enter. It is best to place a small board in the mould first, and to pour the plaster over it - this spreads out the stream of plaster without introducing air bubbles. Experienced mould makers hit the table with their body while pouring plaster - this helps to release bubbles. The best way to remove bubbles is by using a brush, which is gently moved about the surface of the model immediately after pouring in the plaster.

7 setting of plaster

Plaster goes through several stages of becoming hard:

- liquid: As the chemical reaction starts to occur, the liquid will become gradually stiffer.**
- plastic: This is the stage when plaster is like "cheese", and can still be shaped.**
- solid: After pouring, the plaster surface is glossy. When it starts to become solid, the surface will appear dull.**
- final crystallisation: The plaster becomes hot, and expands slightly (about 0.3 %).**

8 clean-up

Remember that it is easiest to clean up plaster before it gets hard. Discard any excess plaster in a suitable container or old plaster bag. Buckets and tools should be washed immediately in a bucket of water always kept ready for that purpose.

NEVER put plaster in a sink or drain, as this will block it.

Old, hardened plaster that falls from tools or buckets into fresh plaster will speed up the setting time, and cause bad quality moulds.

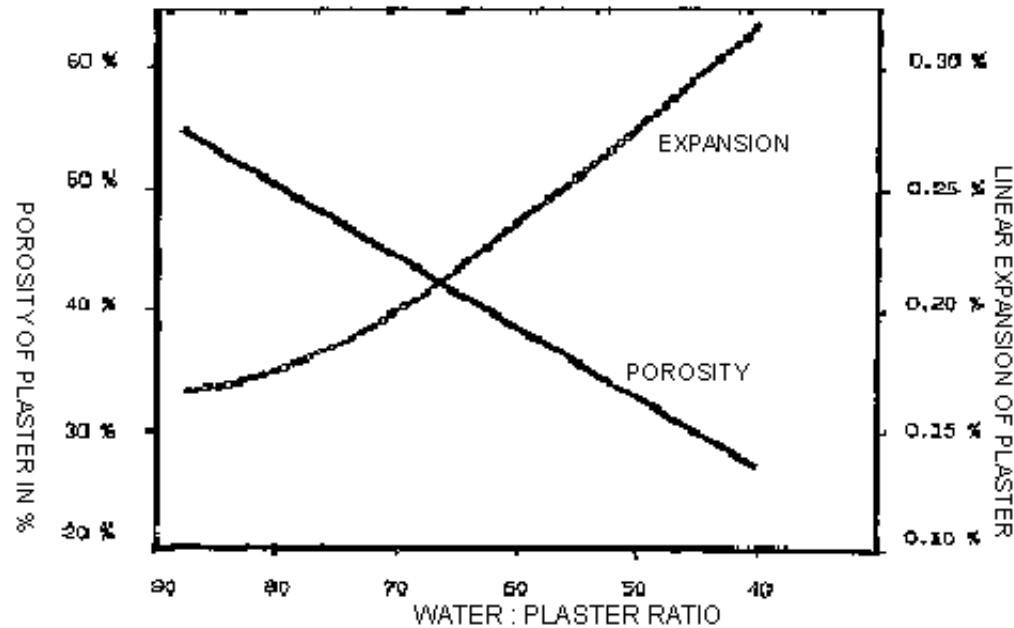

FIGURE 6.4.4-A Graph of plaster porosity and expansion. With increase of plaster content expansion increases, but porosity decreases.

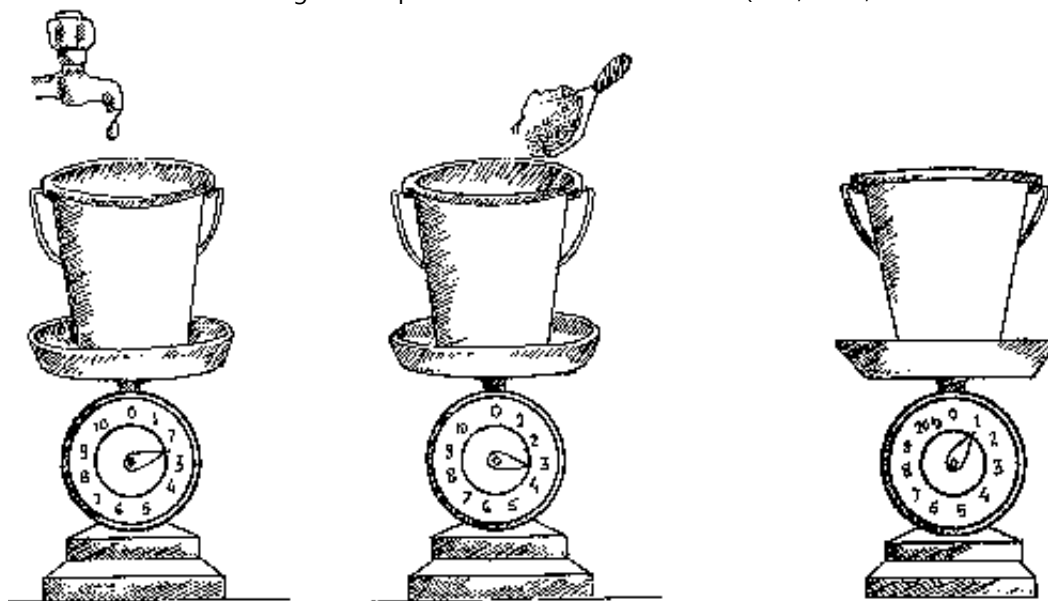

FIGURE 6.4.4-B Plaster mixing work flow (A; B; C;)

- A) Measured amount of water is filled in the mixing bucket.**
- B) Correct amount of plaster is added to the water,**
- C) The mixture is left to soak for 2 minutes.**

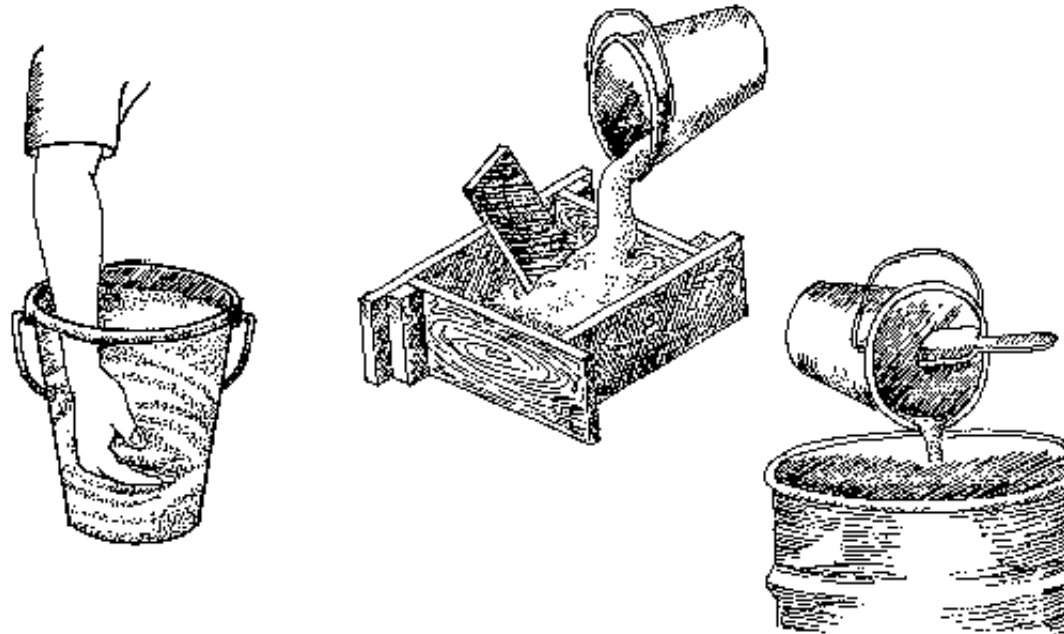

FIGURE 6.4.4-B Plaster mixing work flow (D; E; F)

D) The mixture is stirred for 2 minutes. Stir with upward movements that release air bubbles.

E) The plaster is poured onto a piece of wood to release air bubbles.

F) The bucket and other tools are cleaned immediately

6.5. Plaster mould making

6.5.1. MODEL

6.5.2. MAKING MOULDS FOR PRODUCTION

6.5.3. MOULD PROBLEMS AND SOLUTIONS

Mould making from plaster of parts is a highly specialized skill, and small-scale producers who produce by slip casting or by jigger often have a full-time mould

maker, and an area that is set aside specifically for mould making. Because the same mould needs to be reproduced sometimes hundreds of times, there is a well-established system for doing this, which involves several stages. It is a bit complicated to remember the different names for each stage. When we talk about "positive", this means the shape itself: for example, the positive of an apple looks just like the apple. "Negative" means the shape of the space around the apple, just as the inside of a shoe is the "negative" of the foot.

steps in mould making

- model (positive): This is the original design from which all the other moulds are made. It looks exactly like the intended product. It is usually made from plaster of parts, which may be built up by hand and carved, formed on a variety of hand-operated devices, or turned on a special plaster wheel.**
- master mould (negative): This is the mould made from the model, and is also called the "block". Both the model and the master mould are kept in a special place - if they are lost or damaged an entirely new set of moulds needs to be made.**
- double case mould: This is identical except it has an additional outer casing for making case moulds. If large-scale production is planned, several double case moulds are made, since frequently a mould is damaged.**
- case mould (positive): This is made from the master mould or the double case mould, and looks exactly like the model, except that it also includes the outer casing. For largescale production several hundred working moulds are needed and**

when producing these it is practical to have as many case moulds as can be cast from one plaster mix batch.

- working moulds (negative): As many of these as are needed can be produced from the case mould.

6.5.1. MODEL

In detail, the process of making the different moulds is:

The way of making the model depends mostly on whether it is to be

- asymmetrical, free-form, or not round: for example, sculpture, rectangular objects, handles, spouts, etc.;

- circular and symmetrical: for example, plates, bowls, vases and other standard container shapes.

not round model

Complicated sculptural objects (human figures, etc.) are usually made first in plastic clay (as above) because it is easier to model small details and to make alterations. These models are generally made from solid clay (as opposed to hollow), which is built up around a wire armature to give it strength.

This process will not be described here in detail, as there are entire books on this subject alone.

If the object is to be produced on a large scale, a master mould is then made.

Another material used for models is wax, which is usually the same kind of soft modeling wax that is normally used by bronze casters. This is built up and worked with hot metal tools.

Simpler forms, such as rectangular dishes, oval vases, and the like, are often made by casting a block of plaster and then carving it to shape, or by building up plaster on an armature to the rough form, and then filing it to shape.

round model

- plastic clay process: Round models can be made in plastic clay, as above. The disadvantage of this is that the model is destroyed in making the master mould. However, the master mould can be used to make as many case moulds as needed. Using plastic clay is very fast, and allows a number of variations on a design to be made quickly, before selecting the final one. Because only the outside of the model is used for mould making, throwing is normally done thicker than usual. This method is very useful for larger items, or for items that do not have a lot of fine detailing. The model is set up leather-hard before the master mould is made. Remember that the model needs to be about 10 % larger than the final product - if accuracy is required, the drying plus firing shrinkage (total shrinkage) of your production clay should be used.

the plaster wheel

The most common method of making round models is in plaster of parts. There are several advantages to this method:

- If the original design has been made as a drawing on paper, the size can be

calculated very accurately, and a cardboard profile made of the contour, which is then used to check the model.

- No shrinkage to consider since the original model can be made to the same size as the working mould.**
- The plaster model can be kept permanently in storage, and, if needed, can be used to produce a new master mould.**
- The model can be carefully detailed, and altered millimeter by millimeter if required.**

Normally, this work is done on a special plaster wheel, which is basically a motorized potter's wheel, with either fixed or variable speed. The wheelhead is fitted so that plaster can be attached to it, and a special brace is attached so that the worker can hold his arms steady.

making the model

To start work, a cylinder of flexible material called a "cottle" is mounted on the wheelhead.

This is filled with plaster of paris, and as soon as it has set enough to hold its shape, the cottle is removed and rough shaping is done immediately while the plaster is still wet and soft. The shaping is done with a set of special tools, which can be made by a welding shop, and can be worked on a grinder when special shapes are needed.

The work is more or less the same as using a wood lathe, except that the plaster is turning vertically. Usually, an experienced wood or metal turner can easily learn to turn plaster, as it is softer and easier to work than other materials. A master plaster turner is amazing to watch, as plaster literally flies in all directions as he quickly develops the shape.

Once the rough shaping is done, it does not matter if the plaster gets hard, although it is best to keep it covered with plastic so it does not dry out until the shape is final. The shape can be checked very accurately if a stiff paper or sheet metal profile is made. In this way, fine shaping can even be done over a period of several days if necessary.

In this process, plaster is always removed down to the correct curve, and new plaster should not be added. If too much plaster is removed, it usually is better and saves time to start over again. Even though more plaster can be added to already-set plaster, it often will not join really well, may be harder or softer, and usually results in a rough area when cutting through the joined place. If it cannot be avoided, plaster can be joined by scratching the already-set plaster surface and soaking it completely with water before pouring fresh plaster onto it.

If necessary, a standard potter's wheel can be used as a plaster wheel. This is not really recommended, but if you produce only a few models, there is no point in investing in a special plaster wheel.

WARNING! ALL PLASTER WORK SHOULD BE DONE AWAY FROM CLAY WORKING AREAS. EVEN SMALL PINHEAD SIZE PIECES OF PLASTER THAT GET INTO THE CLAY WILL CAUSE YOUR POTTERY TO LOW OUT PIECES! So make a separate area

for working with plaster, and be careful that plaster does not get into the clay.

the turning box

This is a wooden frame which is fitted with a metal shaft that can be rotated by a hand crank. It is used in combination with a profile. The metal shaft is first prepared by wrapping it with paper or cloth, and providing it with a metal pin. The paper prevents plaster from sticking to the shaft, and the pin is fixed so that it keeps the plaster from spinning freely while working, but it can be removed when finished so the plaster can slide off the shaft. Plaster is first built up on the shaft by applying it and rotating at the same time. When it is a little smaller than the profile, more plaster is applied, and the profile shapes it to the final form.

WARNING: This seems like a simple device, but in fact requires a lot of skill to operate correctly. It is not recommended unless you can find an experienced person to teach you.

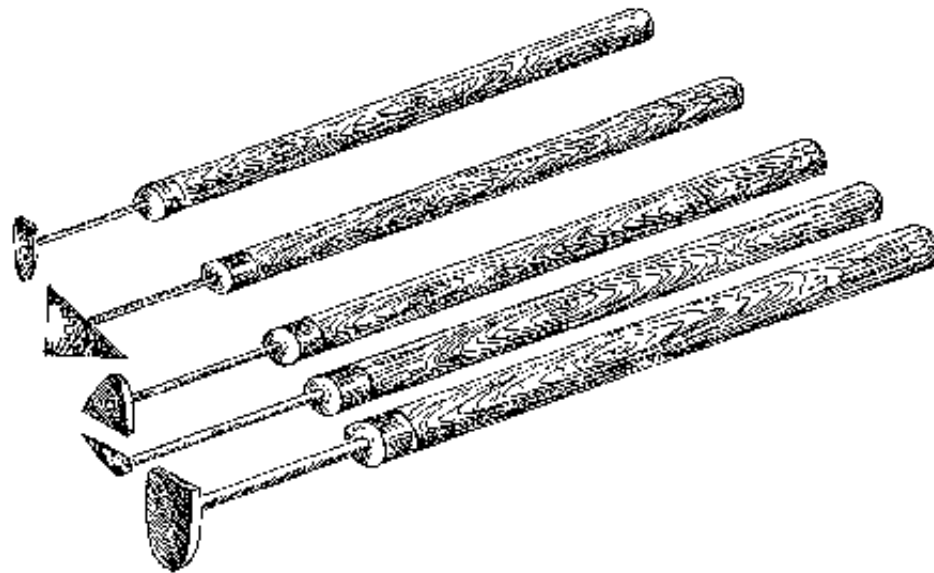

FIGURE 6.5.1-D Various shapes of tools for plaster wheel

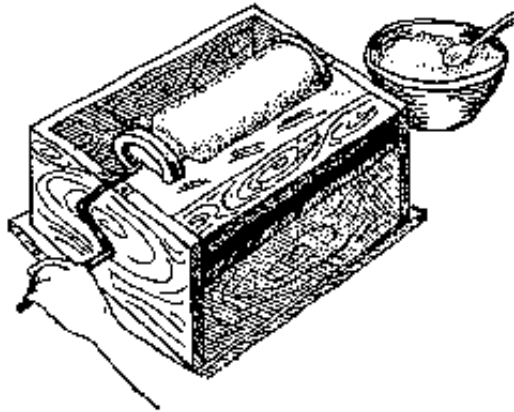

FIGURE 6.5.1-E Plaster turning box with a profile of a vase to be modeled.

6.5.2. MAKING MOULDS FOR PRODUCTION

Although making moulds is virtually always the same process: **MODEL, MASTER MOULD, CASE MOULD, WORKING MOULDS**, the specific steps are different for making jigger moulds, two-piece moulds, and multiple-piece moulds.

Some important points to remember are:

- **Mixing and pouring plaster:** according to section on plaster.
- **Cottle:** This is the word used for the device that holds the liquid plaster around the mould.

Round cottles are made from sheet metal or linoleum (Fig. 6.5.1-C), which is rolled into a cylinder with the appropriate diameter, and held in shape with wire. A separator is not required for these materials. The height is not important - it must

be higher than the intended depth of plaster, and not so high that pouring the plaster is difficult to control.

Rectangular cottles are made from wooden planks, or, for smaller sizes, pieces of glass or rigid plastic. Wood should be soaped to keep the plaster from sticking. For most purposes, a "universal cottle" is used, which can be adjusted to any shape. Special clamps can be made to hold the cottle in position and are very convenient if many moulds are to be made, but this is rarely done. In practice, bricks, clay, etc., are generally used to hold the cottle.

Cottles are sealed with plastic clay to prevent plaster from leaking out. Take care with this step, as the pressure of liquid plaster is sometimes surprising, and a lot of work can be lost if all the plaster runs out of the cottle.

- Separator: Plaster can be poured onto clay, linoleum, glass and wet wood without sticking. But if it is poured onto another plaster surface, it will stick unless a separator has been used. Modern separators are often made from silicon compounds in spray cans, which are very expensive. However, liquid soap is the standard one and works very well if correctly applied. The standard soap is thick brown potash soap diluted with water (about 0.25 kg soap to 1 liter water). If this is not available, bar soap used for laundry can be prepared by boiling 500 g soap in 2 liters water. After it has cooled another 2 liters water are added.

- Applying separator: The separator can be applied with a soft brush or with a sponge. The first coat is done with a very thin separator which will reduce the absorption of the plaster. Wipe the soap off with a sponge. The next applications are done with a thicker soap separator. After each application, excess soap is

wiped off with a sponge. Do not clean the sponge or your hands in water. This is done 5 times on a fresh mould and 3 times on a mould that has already been used. The last coat is wiped off very carefully so that no excess soap is left on the surface because that will spoil the surface of the new cast.

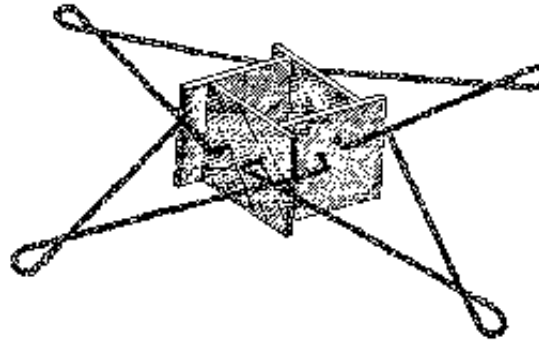

FIGURE 6.5.2-A Universal cottle with clamps made from iron bars.

- Mould sealer: Normally five coats of soap will be enough to seal the plaster surface. However, some potter's prefer to apply a special sealer to the mould surface before using a separator. The sealer is usually shellac, which is thinned with denatured alcohol. 3 to 4 coats of shellac are needed, but each application should be allowed to dry completely before applying the next, otherwise the earlier shellac layers will be partly dissolved by the new coat and form bumps on the mould surface.

If shellac is not available thin enamel paint can be used instead. The mould should be dry before applying the paint. Either dry it in the sun for several days, or in a heated cabinet that is below 50°C.

- Pouring plaster: Never pour plaster directly onto the face of the case mould. The

point of pouring will become more dense and for a slip casting mould this would produce an uneven cast. Pouring should be done without splashing so that no air bubbles are trapped. Place a piece of wood inside the cottle and pour onto that. Immediately after pouring, air bubbles can be released by moving a soft brush gently over the mould surface.

- Opening the mould: This is a step which often can cause difficulty, especially with single-piece moulds with vertical sides (such as cup moulds for the jigger). If you have correctly done the sealing and soap application, and the mould does not have any undercuts, it should be possible to separate the mould. The mould should be opened when the plaster is hottest. The heat makes the mould "sweat" a little, softening the soap separator and this helps release.

Normally this can be done by inserting a thin knife blade in the seam, and gently tapping it with a wooden mallet. Do this all along the seam, and repeat it all around until the mould comes away. The greatest difficulty is often found with jigger moulds, which are rather deep and often create a strong suction which resists all attempts to open the mould. If you have compressed air available, this is the best solution to the problem. A hole (quite small, about 2 mm will do) is drilled through the mould up to the model - don't worry if you penetrate the model, as this can be filled with a bit of plaster later. The hole can also be made by inserting a nail in the plaster before it stiffens (Fig. 6.5.2-C. Then apply a rubber or plastic hose to the hole and force in air. If nothing else is available, a bicycle pump often works, but the metal end should be removed.

- Case mould: Although case moulds are normally made from plaster of parts, wax is sometimes used for limited production. It has the advantage of being easier to

remove from the master mould, and can be used to produce a large number of working moulds. Plain paraffin wax (the same used for making candles) can be used, but a better mixture is 2 parts paraffin to 1 part beeswax (if available). The master mould is set up as usual, and sufficient wax is melted to fill the mould. Hot wax shrinks when it cools, so to minimize this, the wax should be cooled in its melting container until a crust starts to form at the edge. It is then ready for pouring. As with slip clay, pouring must be done quickly and without hesitation - otherwise rings will form on the wax surface.

In modern European practice, case moulds are made from silicone rubber (a 2-component product, which when mixed sets to make a rubber-like material that is flexible).

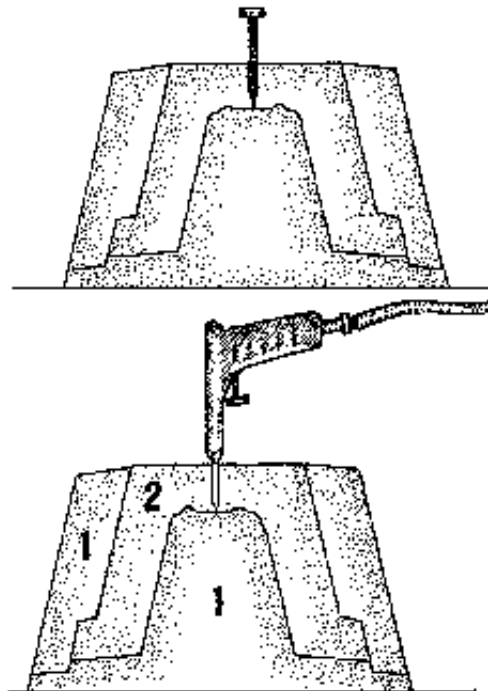

FIGURE 6.5.2-C (A; B)

- A) A nail is inserted in the soft plaster of a jigger cup mould.**
- B) Compressed air enters between the case mould (1) and the working mould (2) and forces them apart.**

one-piece moulds

- jigger mould: One-piece working moulds are very frequently used for jigger work. However, in order to produce them, it requires a fairly complicated master mould. All steps from making the model to producing working moulds for a jigger cup are shown in Fig. 6.5.2-E.**
- plaster expansion: The plaster expands about 0.2 % on setting. The expansion of the working mould may crack the case mould. There are two solutions to this. The first is to make the case mould stronger by using more plaster for the same amount of water and by inserting reinforcing metal bands in the case mould during its casting. If extra gypsum cement plaster (alpha plaster) is available this is used for case moulds.**

The second option is to allow the case mould to crack. Before casting the first working mould a vertical incision is made in the case mould from the outside so that a neat, straight crack is produced during the first casting. A metal wire is then tightened around the case mould, but during each casting the case mould will still yield a little to the expanding working mould. The advantage is that it is easy to release the working mould, but the disadvantage is that the working mould is not running perfectly true when placed in the jigger head. The working moulds can be trimmed on the plaster wheel to run true, but this of course adds to the cost of production. However, in many countries this method is the only practical solution,

when plaster is of poor quality.

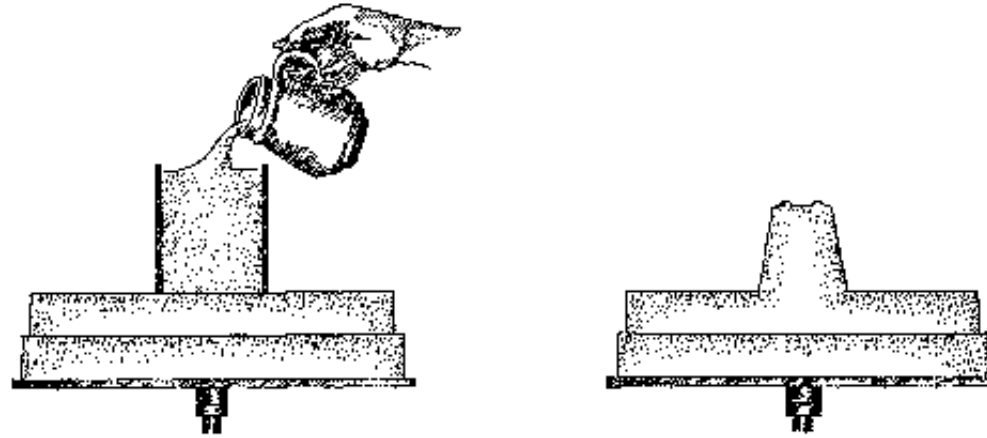

FIGURE 6.5.2-E Work flow of making a jigger mould (A; B)

- A) Place a cottle on the plaster wheelhead and cast a rough cylinder.**
- B) Turn a model of the cup on the wheel, seal it with shellac and apply a soap separator.**

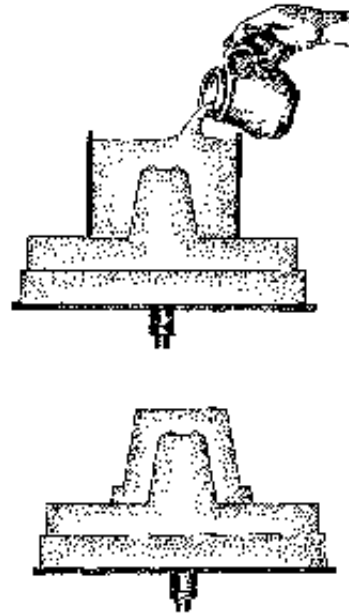

FIGURE 6.5.2-E Work flow of making a jigger mould(C;D)

C) Place a cottle around the model and make a cast.

D) The master mould, also called block mould, is cut on its outside to fit the jigger head on the jigger machine.

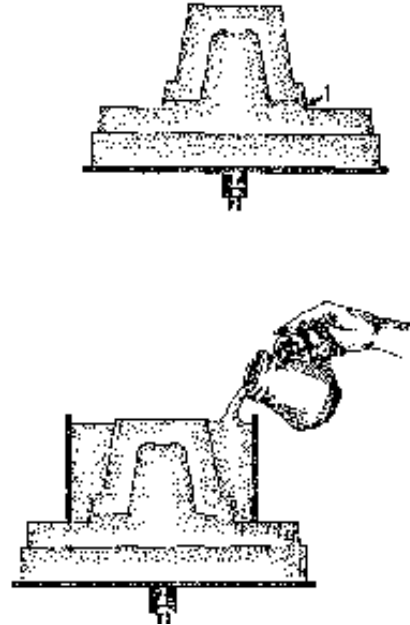

FIGURE 6.5.2-E Work flow of making a jigger mould (E; F)

E) Cut the base of the model down, slightly sloping as shown at (1). Apply sealer and separator.

F) Make a cast of the master mould. This is the CASE MOULD.

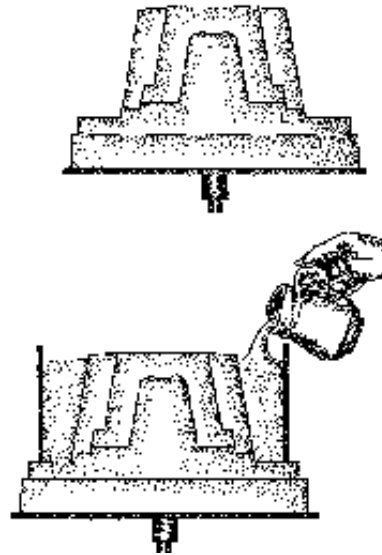

FIGURE 6.5.2-E Work flow of making a jigger mould (G; H)

G) Cut the CASE MOULD so it is slightly sloping and cut the base of the model down a bit further. Apply sealer and separator.

H) Make a cast of the case mould. This is the DOUBLE CASE MOULD.

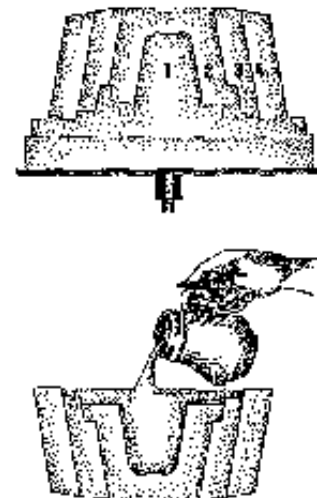

FIGURE 6.5.2-E Work flow of making a jigger mould (I; J)

I) After turning the outside of the double case mould the whole set is ready: model (1), master mould (2), case mould (3), double case mould (4).

J) Take the moulds #24 off the plaster wheel, turn them upside down and cast an extra model.

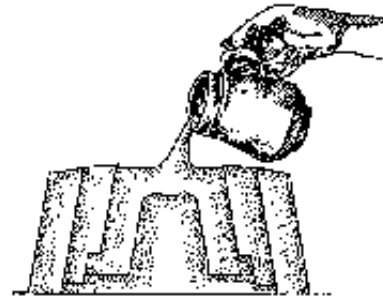

FIGURE 6.5.2-E Work flow of making a jigger mould (K; L)

K) Cast an extra set of model, master mould and case mould and store them for future reproduction. Then cast a number of case moulds from the other set of moulds.

L) Produce working moulds from the case moulds

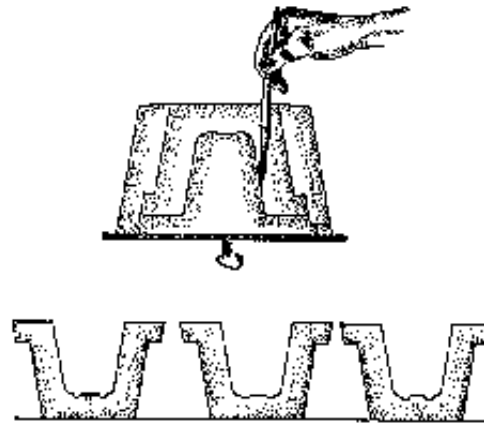

FIGURE 6.5.2-E Work flow of making a jigger mould (M; N)

M) Before the plaster starts setting turn the case mould on a potter's wheel while touching the mould surface with a soft brush.

N) Dry the working moulds completely before use. The first few cups formed in the new moulds may be difficult to release.

two-piece mould for slip casting

This is probably the most common type of mould for slip casting most simple shapes, like flower vases, small decorative objects, etc. Although moulds for slip casting should be of uniform thickness so that water is absorbed equally from all areas, in fact they are often made square or rectangular in section for ease of producing and handling the working moulds.

The model may sometimes be prepared from clay, but normally is made from plaster of parts, as above. It is important to remember that moulds for slip casting require a "spare", which is the slip pouring spout that holds an extra reservoir of slip and permits accurate finishing of the mouth.

multiple-piece mould

The vase we made above in the two-piece mould had to have a flat bottom, because otherwise it would have an undercut in the bottom and could not be released from the mould. An indented bottom can easily be made with the help of a third mould piece. This type of mould is shown in Fig. 6.5.2-H.

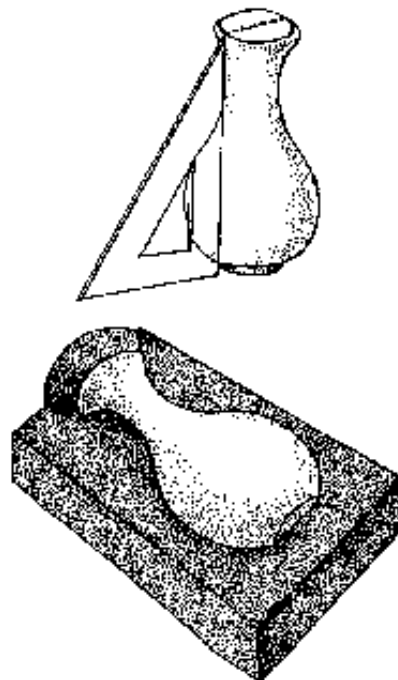

FIGURE 6.5.2-I Steps in making a two-piece slip casting mould (A; B)

A) Mark the midline of the vase with a pencil. Seal the model.

B) Set the model in plastic clay up to the marked midline. Make the clay surface smooth and make a clay plug at the mouth to form the spare.

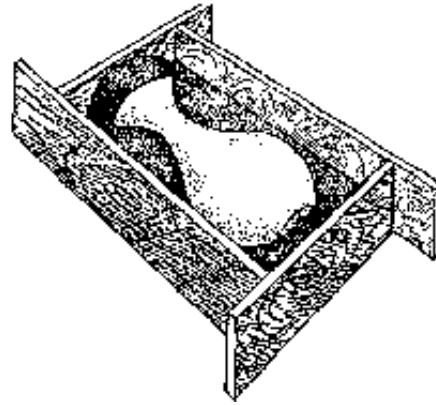

FIGURE 6.5.2-I Steps in making a two-piece slip casting mould(C)

C) Place a casting cottle around the model. Allow about 4 cm between cottle and largest diameter of the vase. Seal gaps with clay. Apply separator to the model.

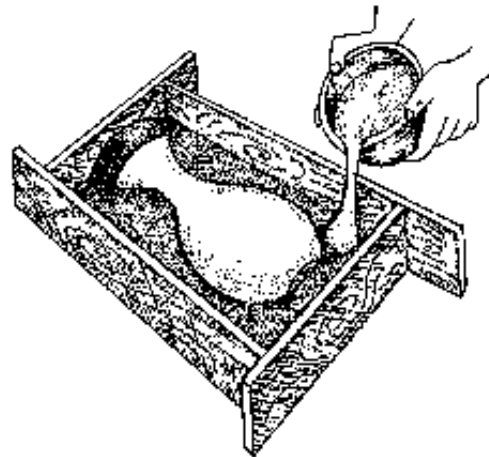

FIGURE 6.5.2-I Steps in making a two-piece slip casting mould(D)

D) Pour plaster slowly into one corner. Vibrate the mould gently or move a soft brush over the mould surface to remove air bubbles.

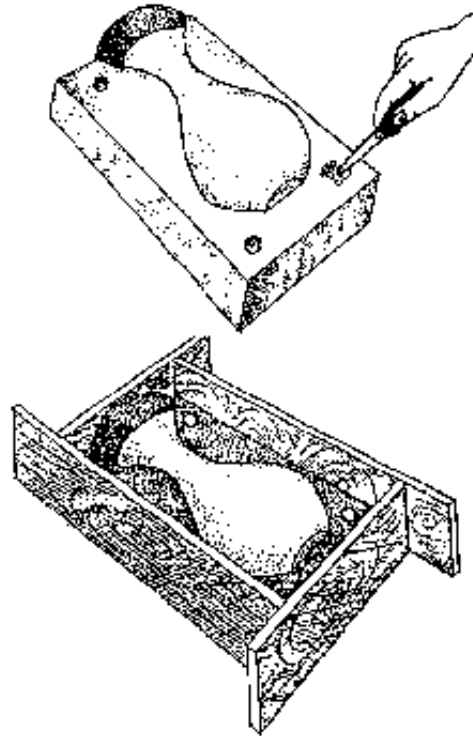

FIGURE 6.5.2-I Steps in making a two-piece slip casting mould (E; F)

E) Remove cottle and clay and turn the new mould over, keeping the model in place. Clean clay from all plaster surfaces. Make keys or notches in the plaster, place a new clay plug at the mouth.

F) Replace the cottle and soap the model as usual, taking extra care to soap the notch holes.

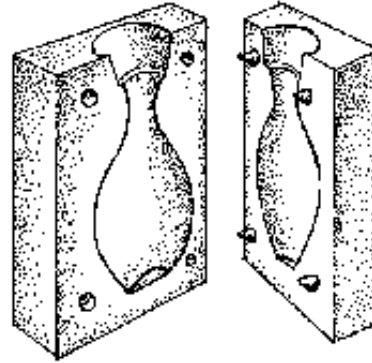

FIGURE 6.5.2-I Steps in making a two-piece slip casting mould(G)

G) After separating the two moulds, we have a set of master moulds also called block moulds. Make an extra set of these to keep in store together with the model.

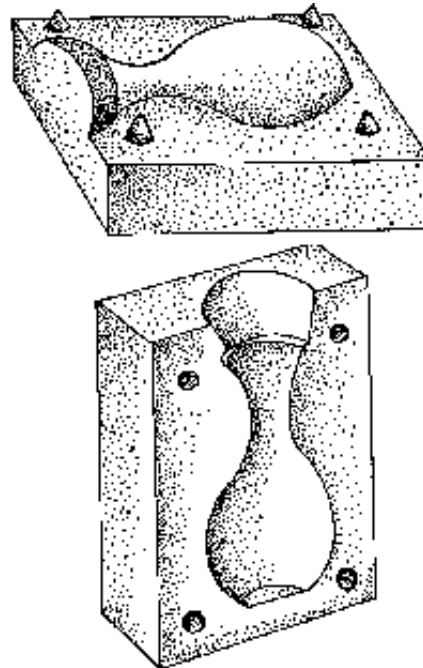

FIGURE 6.5.2-I Steps in making a two-piece slip casting mould (H; I)

- H) From the two master moulds make as many sets of case moulds as needed.**
I) From the case moulds working moulds are produced.

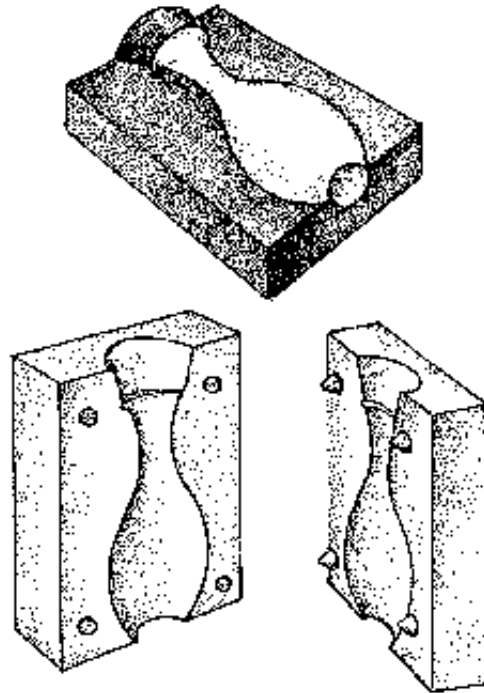

FIGURE 6.5.2-J Steps in making a three-piece casting mould.(A; B)

- A) Set the model in clay as before' but with the bottom at the edge as shown. Otherwise proceed as above.**
B) The two master moulds without bottom part.

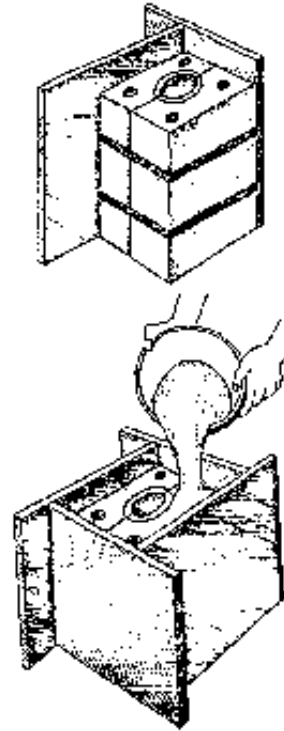

FIGURE 6.5.2-J Steps in making a three-piece casting mould.(C; D)

- C) Assemble the two master moulds with the model inside. Hold it together with rubber bands, turn it upside down' cut notches and place a cottle around it.**
- D) Soap well and pour plaster to cast the third mould piece.**

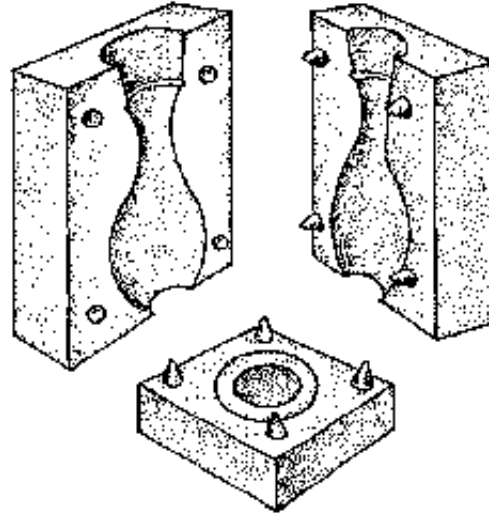

FIGURE 6.5.2-J Steps in making a three-piece casting mould.(E)

E) The three master mould pieces after separation.

multiple moulds for irregular shapes

Pottery shapes can also be square, triangular, oval or even completely irregular as for example a sculpture. Slip casting of such items requires moulds divided into many sections.

The first step is to determine how many pieces of mould are required, and where the separation lines will be. This is largely a matter of experience and good judgement. There must not be any “undercuts” which prevent the mould from being pulled away from the model. When the lines have been determined, they can be drawn on the model with pencil.

A multiple-piece mould can also be made without using a cottle. First the largest area defined by the separation lines has a clay dam built around it, which normally

can be about 4 cm high. The plaster is applied by splashing it on layer by layer until about 4 cm thick. The clay is then removed and the plaster face is "keyed" as described above. The area next to the new cast is then dammed in by clay and the process is repeated.

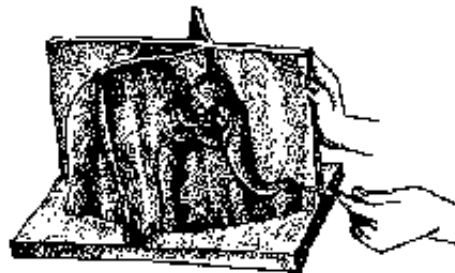
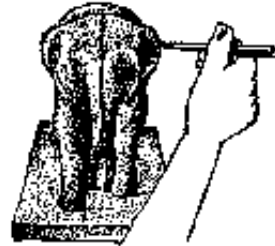

FIGURE 6.5.2-K Steps in making a multiple-piece mould (A; B)

- A) Draw separation lines on the model.**
- B) Build up clay walls along the separation lines.**

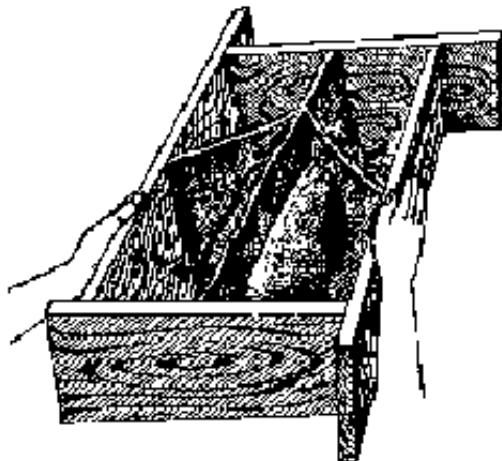

FIGURE 6.5.2-K Steps in making a multiple-piece mould(C)

C) Place a cottle around it and extend the clay walls to the walls of the cottle.

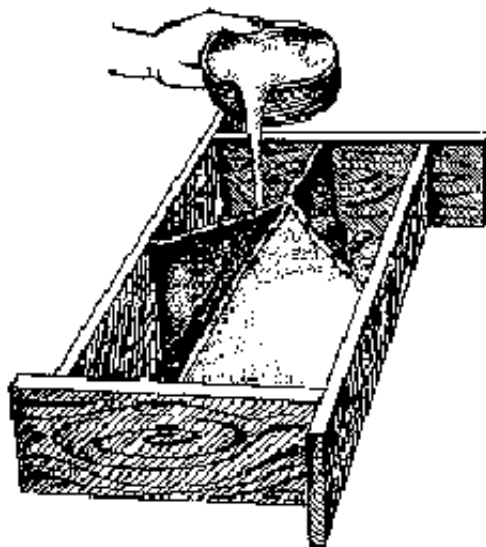

FIGURE 6.5.2-K Steps in making a multiple-piece mould (D)

D) Pour plaster into sections not bordering each other.

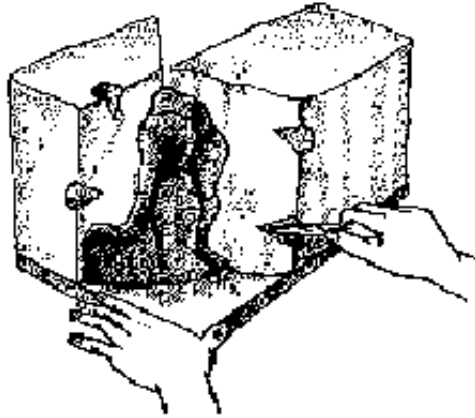

FIGURE 6.5.2-K Steps in making a multiple-piece mould (E)

E) Open the cottle, remove clay walls and cut key notches in the plaster.

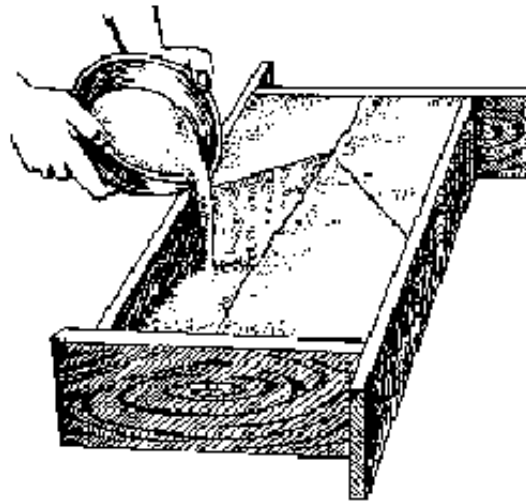

FIGURE 6.5.2-K Steps in making a multiple-piece mould (F)

F) Replace the cottle, apply separator and pour plaster into the other sections.

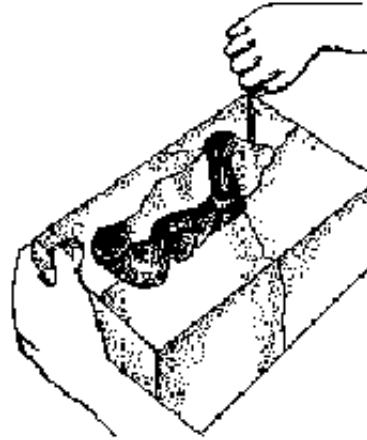

FIGURE 6.5.2-K Steps in making a multiple-piece mould (G)

G) Remove the cottle, turn the mould upside down, cut key notches and pour plaster into the last section.

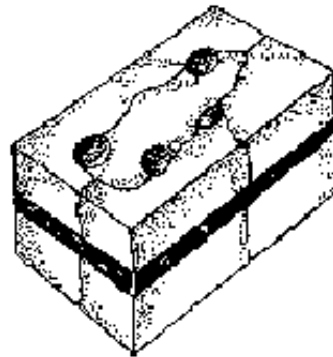

FIGURE 6.5.2-K Steps in making a multiple-piece mould (H)

H) The finished casting mould. The casting slip is poured through the four legs of the figure

6.5.3. MOULD PROBLEMS AND SOLUTIONS

Problem: Plaster sets too fast.

Cause:

- i. plaster is not properly calcined, contains gypsum
- ii. equipment dirty
- iii. high ratio of plaster to water
- iv. mixing water too hot.

Cure:

- i. replace the plaster
- ii. clean equipment
- iii. increase water content
- iv. try with cooler water.

Problem: Plaster sets too slowly.

Cause:

- i. plaster is contaminated with clay, sand, etc.
- ii. too much water in the mixture.

Cure:

- i. discard the plaster
- ii. reduce water content of the mixture.

Problem: Air bubbles on the mould surface. This is one of the most common problems with plaster moulds

Cause: improper mixing and pouring.

Cure: Follow instructions on mixing and pouring procedure given in 6.4.4.

In let plaster soak completely before stirring. Vibrate mould gently or move a soft particular, brush over the mould face after pouring.

Problem Rough mould surface, or soft mould surface.

Cause: i. soap used as separator was not wiped off before pouring
ii. coarse grains in the plaster.

Cure: i. wipe the separator off with a squeezed sponge
ii. screen the plaster through 100 mesh, regrind the plaster, complain to supplier.
Make a thicker mix so the large particles do not settle on the surface.

Problem: Mould is too soft and breaks down easily.

Cause: i. too much water in the mixture
ii. plaster is contaminated or too old
iii. moulds were dried at high temperature.

Cure: i. correct water/plaster ratio
ii. discard plaster
iii. dry moulds below 50°C.

Problem: Casting or jigger items stick to the mould the first few times in use.

Cause: salts in the plaster deposited on the mould surface during drying.

Cure: Dust the mould with talc or grog dust before using it the first few times. Drying moulds from the outside only will reduce the problem



[Home](#) > [ar.cn.de.en.es.fr.id.it.ph.po.ru.sw](#)

 **Forming Techniques for the Self-Reliant Potter (GTZ, 1991,**

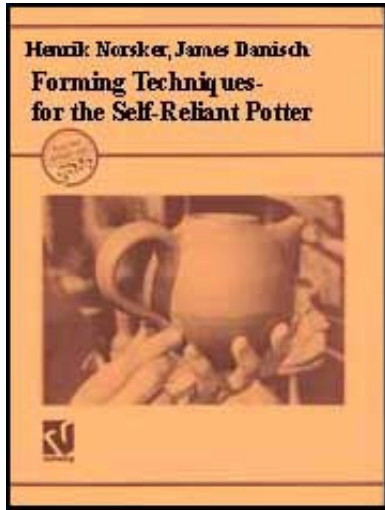

194 p.)

- ➔ □ **7. Slip casting**
- 📄 **(introduction...)**
- 📄 **7.1. Casting body**
- 📄 **7.2. Slip building and fiberslip**

Forming Techniques for the Self-Reliant Potter (GTZ, 1991, 194 p.)

7. Slip casting

Slip casting is a specialized way of using plaster moulds for mass production of ceramics. The word "slip" means a single clay or a mixture of clays and other materials that has been mixed with enough water to make it liquid, so that it can be poured into a plaster mould.

Slip casting is a fairly new process in the history of ceramics, as it only became practical after the invention of plaster of parts 200 years ago.

drain casting

The slip casting process shown in Fig. 7-A produces a hollow item which outside has the shape of the mould. This process is called drain casting because the moulds are emptied of excess slip.

solid casting

In this method the mould forms both the inner and outer face of the cast. The advantage is, that all casts will be identical and the cast can have walls of varied thickness. Solid casting moulds are more complicated to make and they are mainly used for high quality ware and for items that need to be of uniform size. Fig. 4.4.1-D shows an example of solid casting of handles.

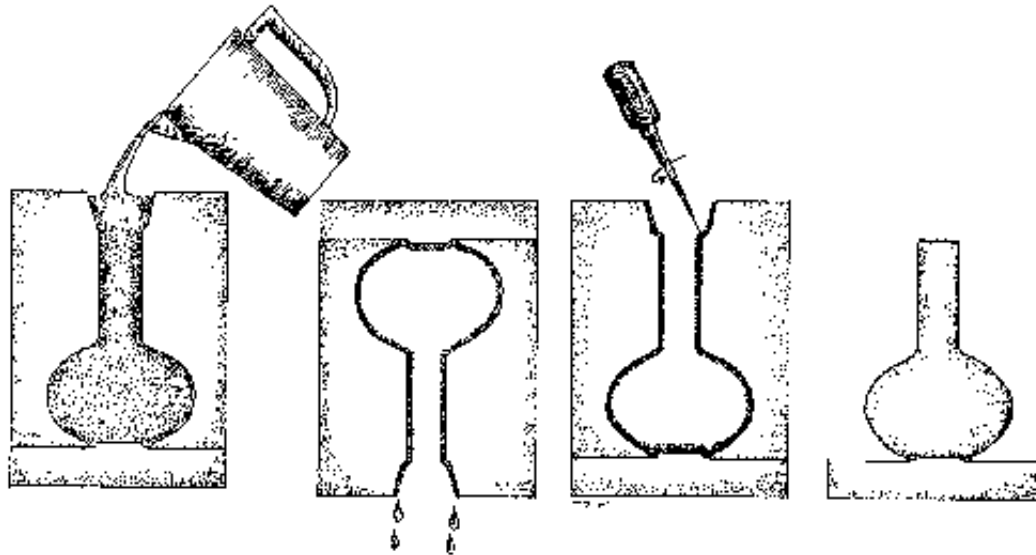

FIGURE 7-A The slip casting process (A; B; C; D)

A) A three-piece plaster mould is filled with casting slip. Water is absorbed by the plaster and the clay that was mixed with that water forms a layer of clay on the inside.

B) After 20-40 minutes the mould is emptied. A layer of clay, forming a vase, remains inside the mould.

C) The mould absorbs more water from the clay and when the vase is hard enough to handle the "spare" is trimmed and the vase is released from the mould.

D) The vase is placed on a board for finishing and the mould is reassembled and used for another casting.

7.1. Casting body

7.1.1. GUIDELINES FOR DEVELOPING A CASTING BODY

7.1.2. CASTING SLIP PREPARATION

7.1.3. CASTING PROBLEMS, CAUSES AND CURES

Slip casting gives potters more problems than other forming techniques. A good casting slip is often difficult to develop, and preparation of the clay slip has to be done carefully following the same procedures each time. The following factors play a role in making a casting slip:

fluidity

The clay body needs to be fluid enough to be poured into the plaster moulds, and after the clay sets on the mould surface, the remaining clay must drain out without leaving "runs" or "tears" on the inner surface of the cast. Fluidity is the opposite of viscosity; a stiff liquid is said to have high viscosity, and a very fluid liquid has low viscosity. The viscosity of a clay slip is adjusted by addition of water or deflocculating chemicals like soda ash (sodium carbonate) and water glass (sodium silicate).

density

The clay slip should contain as little water as possible. A high amount of water produces a less dense cast and increases drying shrinkage of the clay. It will also lengthen the casting time, and the plaster moulds will have to absorb more water, which reduces the number of items that can be cast per day and the life of the moulds. Water content of the slip should be 25 % to 45 % by weight of the slip. Density is measured by weighing 1 liter of the slip. 1 liter of water weighs 1 kg, and we say it has a density of 1; clay slip will have a density higher than 1.

permeability

As soon as the clay slip is poured into the mould, the plaster starts to suck water from the slip, and a denser layer of clay body is built up next to the plaster. As this layer thickens, it takes a longer time for the plaster to draw water from the slip, so the casting rate is lowered. If the casting slip has a high proportion of fine plastic clay, it will lengthen the casting time considerably. Therefore, casting slips should normally contain less plastic clay than plastic bodies. As a rule, a casting slip should contain 50 % clay and 50 % nonplastic materials (by dry weight).

clay body strength

The finished cast should be strong enough to handle when it is taken out of the mould, and there should be no sticking to the mould. The green strength of the clay body needs to be enough for handling without breaking.

deflocculation

Clay particles are extremely small and shaped like plates. In a plastic clay a thin film of water surrounds each clay particle and enables the particles to slide over

one another when pressure is applied during forming. As more and more water is added, the clay particles start to move more freely, and gradually the clay becomes a slip. An increase of water lowers viscosity. Equal amounts of water and clay make a slip.

So much water makes the slip impractical to cast. This problem is solved by adding chemicals, which changes the behavior of the clay particles.

Clay particles behave in two different ways when freely suspended in water. If an acid is added to the water the clay particles will attract each other, and it is said that the clay slip is "flocculated". With addition of an alkali (e.g. soda ash), the clay particles will repel each other and this state is called "deflocculated".

Fig. 7.1-B shows clay particles enlarged approximately 100,000 times. In an acid environment, clay particles carry electrostatic charges on their surface: positive charges at their edges and negative charges on their two faces. The clay particles behave like small magnets, and the positive edges are attracted to the negative faces. This results in packing of the clay particles, and in increased viscosity.

When the clay slip is deflocculated by addition of an alkali the particles become negatively charged all over and they will then repulse one another (Fig. 7.1-C). This repulsion makes the slip fluid with less water.

thixotropy

This means the property of clay to become more viscous when it is left undisturbed. When a slip is left all night, it often becomes thick and viscous. If it is stirred, it again will become fluid. Thixotropy is useful in a casting slip because it

helps the newly-cast items to keep their shape in the mould. However, too high thixotropy makes it difficult to empty the moulds. Water glass decreases thixotropy, whereas soda ash does not affect it.

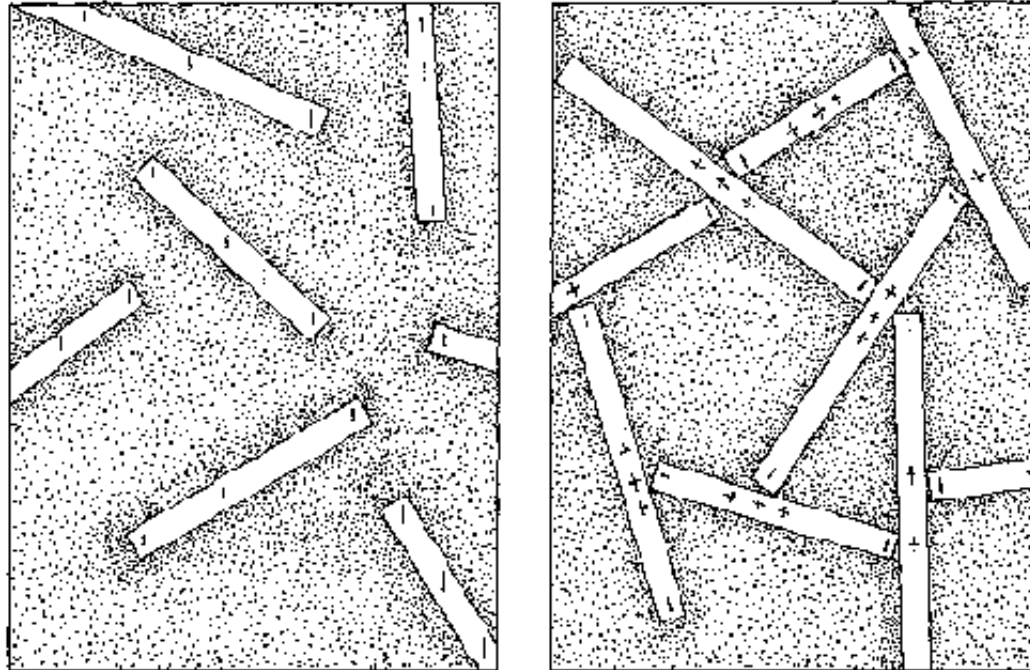

FIGURE (A; B)

- A) Clay particles are attracted to one another in a flocculated slip.**
- B) Clay particles are repelled by each other in a deflocculated slip.**

7.1.1. GUIDELINES FOR DEVELOPING A CASTING BODY

As a starting point, a casting body can be developed from a plastic body. However, the body needs to be adjusted keeping the following points in mind:

- A casting body should contain approximately 50 % clay material and 50 % nonplastic materials.**
- Very fine clay particles will reduce the casting rate by blocking the flow of water from the slip into the plaster mould. Plastic clays should be substituted for less plastic ones and the clay part should be made up from more than one type of clay.**
- Natural clays contain soluble salts, and these will act as flocculants, increasing the necessary amount of deflocculants. Some clays prove impossible to deflocculate. The salts may come from the water, and, as a rule, you should never use recycled water from clay preparation for casting slip mixing.**
- Clays containing sulfates are also difficult to deflocculate. Sulfates can be neutralized by additions of barium carbonate, usually 0.2-1 %.**
- Addition of frit as a body flux may also introduce flocculants, since the frit may be slightly soluble. As a remedy try to use another frit or use glass powder.**
- Clays containing montmorillonite (like bentonite) contain high amounts of colloidal silica that may cause the slip to gel and in general are difficult to deflocculate. This is called "livering".**
- The standard deflocculant is a 3 to 1 mixture of sodium silicate and soda ash. The ratio of sodium silicate should be higher for a body of low plasticity, whereas more soda ash is used for bodies containing higher amounts of plastic clay.**

Sodium silicate tends to cause the cast item to stick to the mould, produces stringy slip that drains unevenly and results in a hard cast. Too much soda ash

produces casts that never get hard, clay bodies that thicken up more quickly, and causes the mould to wear out faster. Soda ash should be purchased fresh, and kept in an airtight container. Old soda ash absorbs water from the air and becomes soda bicarbonate, which will no longer work as a deflocculant.

- The amount of deflocculant should be as low as possible and not higher than 0.3 % (based on dry weight of body). High amounts cause excessive wear of moulds and make the cast stick to the mould.

testing

After developing a suitable body, the right amount of deflocculant is found by doing a simple test. First, weigh all ingredients accurately. Mix the measured body with water until the body becomes just fluid. Then, dissolve a mixture of sodium silicate and soda ash in hot water.

Example:

5 g soda ash + 15 g sodium silicate in 200 ml water equals 0.01 g deflocculant for each 1 ml water. So each 1 ml of solution added to 1 kg body means an addition of 0.01 % deflocculant.

What we want to find is the amount of deflocculant producing the most fluid slip. The fluidity is tested by filling a large funnel to the rim with slip while closing the outlet with a finger. The time (in seconds) it takes for the slip to drain out after releasing one's finger is a relative measure of its fluidity. First the run-through time for slip without deflocculants is found and then the deflocculant solution is added to the slip 5 ml at a time. With each addition the slip is stirred well and run

through the funnel. Initially, the slip will run faster with increase of deflocculant, but as the concentration of deflocculant increases, the slip will become less fluid. At that point the test is stopped and the results are plotted on a graph as shown in Fig. 7.1.1-B. A line is drawn between the dots, and from this graph the amount of deflocculant with lowest viscosity is read. Normally a point a little to the left of this is used, since it is important to use as little deflocculant as possible.

trial batch

Now prepare a 10-kg test batch of casting body following the standard procedure and using the amount of deflocculant found from our funnel test. In the above test we did not find the right amount of water for the slip. This is now done by adding only 33 % water and the deflocculants to the dry body (which means a water content of 25 % of slip). Leave it for 24 hours. After that, additional water is added during blunging until the slip has the right consistency. The slip is tested by casting some items. If it works and if you have measured all components accurately, you have the final recipe for your casting slip.

ageing

A deflocculated casting slip should be used within 2-3 weeks. Carbon dioxide from the air enters the slip and this acts as a flocculant which will make the slip less fluid. The ageing can be slowed down by keeping the slip in an airtight container or by sealing the slip surface with a thin layer of oil.

grog

Grog can be added to a casting slip. It will stay in suspension in the deflocculated

slip. The finished surface will be as smooth as if no grog was used. Grog is used for casting large items, especially sanitary ware. It is also used for casting of refractory kiln furniture.

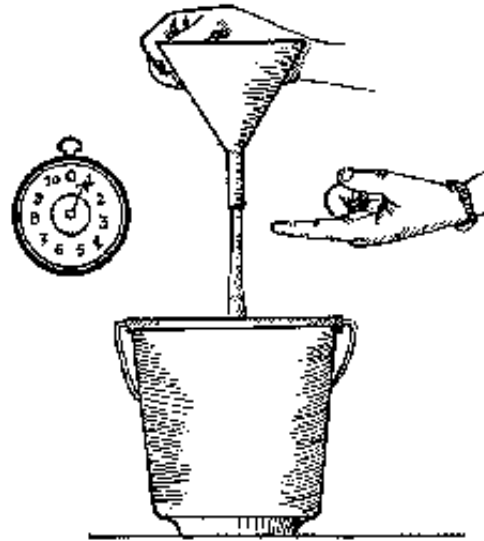

FIGURE 7.1.1-B Funnel used for testing fluidity of casting slip.

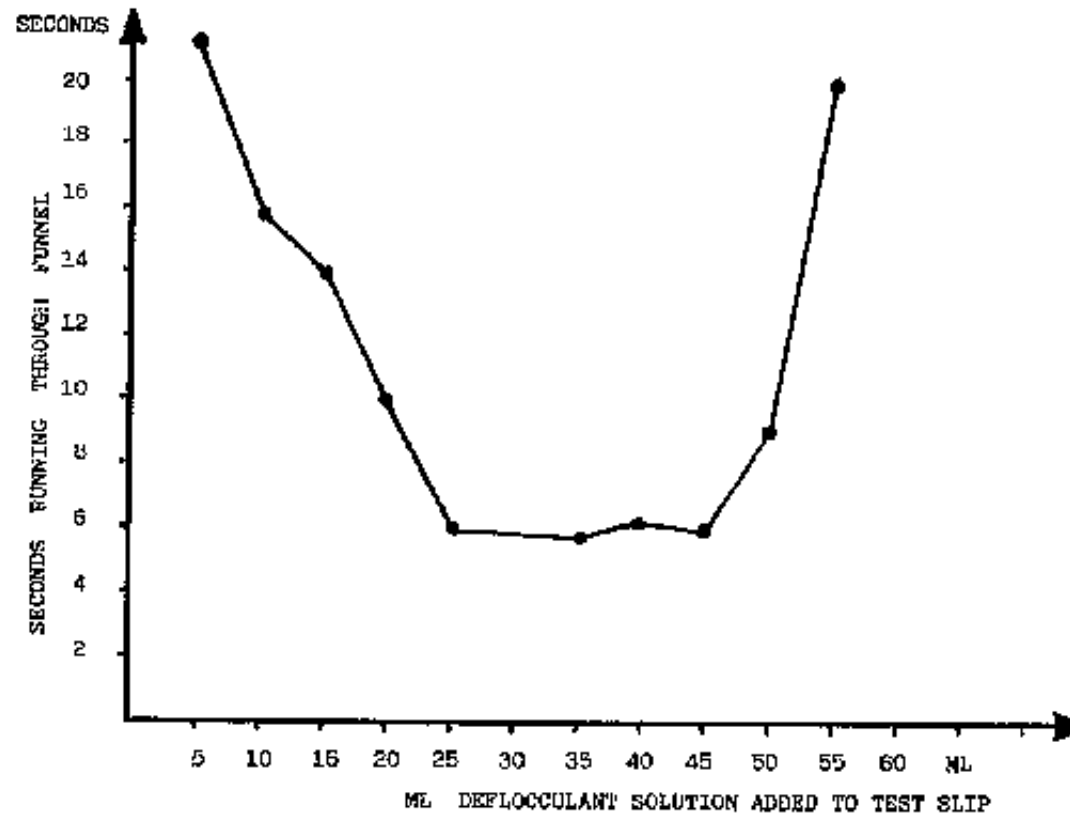

FIGURE 7.1.1-C Results of a fluidity test presented as a graph. 25 ml solution (0.25 % of dry body) is the right amount of deflocculant in this example.

7.1.2. CASTING SLIP PREPARATION

- 1) Dry all body materials and weigh them accurately.**
- 2) Fill the right amount of water in the blunger. Gradually add soda ash dissolved in hot water, then add half of the body. After some blunging add the remaining body and the sodium silicate.**

3) Leave the slip to age for 24 hours.

4) Screen it through 60 mesh. Check fluidity with the funnel test and density by weighing 1 liter of slip. Cast a few items to be sure the slip is working correctly.

recommended procedure for casting

1 Before casting examine the moulds for clay or dust on the inside.

2 Clean dirt from the moulds with an air hose or a soft dry brush. Never use water it will damage the mould.

3 Arrange the moulds in the order of casting: heavy moulds first, then medium size, then small size.

4 Join the moulds tightly together with rubber.

5 Stir the slip just before casting and check that it does not contain air bubbles.

6 Pour the slip slowly and evenly into the mould without stopping and splashing. The slip should hit the bottom of the mould.

7 Top up the mould every 5-10 minutes.

8 Let the mould set until the casting has reached correct thickness.

9 A good mould can be used 2 to 4 times per day, depending on weather conditions. Before each casting, the mould must be dried in the sun or in

the drying cupboard Otherwise moulds wear out fast.

10 After correct thickness is reached, drain out the excess slip. If the slip is drained into its main container, do this through a coarse screen that will retain pieces of plaster and dry clay.

11 Then keep the mould upsidedown until the clay is stiff enough to remove.

12 Take the cast product out when the clay starts to pull away from the plaster mould.

helpful hints

Costing: In costing greenware, the guideline is to charge 10 % of the mould cost for each casting. This can be adjusted according to how complicated the mould is.

7.1.3. CASTING PROBLEMS, CAUSES AND CURES

Problem: Slip gelling in the mould.

“To gel” or “gelling” means slip becoming too thick in the mould, so that excess slip cannot be poured out.

Cause: Underdeflocculated slip.

Cure: Adjust the slip batch by adding more sodium silicate in very small amounts (to prevent overdeflocculation).

Cause: Slip that has not been mixed sufficiently.

Cure: Mix the batch for a longer time.

Cause: Too much free iron or alkaline in the clay itself, or too much organic matter in the clay (black ball clays often cause this problem).

Cure: Reduce the amount of clay causing the problem, by experimenting with variations on the body recipe.

Problem: Uneven casting thickness. This means the walls of the casting are thick and thin.

Cause: Difference in mould absorption due to difference in the thickness of a mould thick areas absorb water faster than thin areas, causing excess buildup of slip.

Cure: Check the quality of your mould. It may be necessary to change the thickness of the mould - thick areas in the mould may need to be made thinner.

Cause: Moulds are too old and are starting to harden.

Cure: Throw out nonabsorbing moulds. Average mould life is 150-200 castings.

Problem: Greenware cracking in the mould. This means the greenware cracks before it is removed from the mould.

Cause: The most common cause is too much water in the slip.

Cure: The amount of deflocculant needs to be corrected, or there may be problems with some of the clay ingredients - in this case, it may be necessary to change raw materials.

Cause: Slip with insufficient plastic ingredients.

Cure: It may be necessary to add more plastic clay to the body.

Cause: Poorly designed moulds.

Cure: If this problem seems to occur with one or two particular moulds, then the moulds are probably the cause of cracking. They may have undercuts which catch the slip.

Cause: Greenware is allowed to remain in the mould too long.

Cure: Check your casting process. Are you leaving the greenware in the mould too long after draining it? It should be removed as soon as it is stiff enough to be handled without damage.

Problem: Greenware sticking to the mould. Cause: New moulds with greasy or soapy surfaces.

Cure: Dust the inside of the moulds with talcum powder. The problem should disappear after making a few casts.

Cause: Too much organic material or large amounts of fine particles in the clay. Black ball clay often has too much organic material.

Cure: It may be necessary to substitute some of the ball clay for china clay.

Cause: Underdeflocculated slip which does not shrink and takes longer to dry in the mould, or overdeflocculated slip with too much sodium silicate (this is the most common cause).

Cure: Adjust the amount of deflocculant.

Cause: Moulds are saturated with water.

Cure: Completely dry the mould at a temperature below 50°C. (If mould becomes

too hot, the plaster will disintegrate).

Problem: Stiff and brittle greenware. This means leather-hard or dry greenware that breaks too easily.

Cause: Overdeflocculated slip. If you experience slow casting times and greenware with a sandy surface, overdeflocculation is usually the problem.

Cure: Overdeflocculated slip usually needs to be thrown out. The amount of deflocculation, especially sodium silicate, must then be reduced.

Cause: Clay particle size may be too coarse.

Cure: Slip plasticity can be improved by ageing it at least 24 hours. If this does not solve the problem, then the recipe needs to be adjusted with more plastic clay.

Problem: Pinholes in the surface of greenware or fired ware.

Cause: Trapped air bubbles in the slip. Bubbles in slip occur if the slip is mixed at too high a speed.

Cure: Bubbles in slip can be prevented if slower mixing speed is used.

Cause: The slip has too low fluidity. Cure: Increase deflocculants and/or water.

Cause: There is a high carbonate content in the water used to make the slip.

Cure: It may be necessary to use water from a different source.

Cause: There is a high content of organic material in the clay which releases gas when it decomposes. Especially black clay contains a high amount of organic materials. Cure: Screen the slip through a 60-mesh sieve. This will release the trapped gas.

Cause: The soda ash in slip decomposes because of too long storage time.

Cure: Throw out the slip.

Cause: Fast pouring into the mould may introduce air bubbles and the return of excess slip after casting may do the same.

Cure: Pour the slip slowly without stopping until the mould is full and stir the slip before casting to release air bubbles.

Cause: Poor quality moulds with pinholes on the surface.

Cure: Improve mould-making process, by mixing plaster more carefully to prevent any air bubbles.

7.2. Slip building and fiberslip

There are a few specialized ways of working with slip that are not found in most ceramics books: one is using deflocculated slip for joining plastic clay, and the other is making large slabs by mixing fiber into the slip, called "fiberslip".

As already mentioned in the section on plastic clay, there is an advantage in using deflocculated slip for joining leather-hard clay, because the shrinkage is the same as plastic clay - this is especially true when joining large pieces, which tend to crack at the seams in drying. The process is:

- Mix deflocculated slip, using the same body recipe as your plastic clay. This type of slip is most easily deflocculated with "Calgon" (sodium hexametaphosphate) in amounts up to 1%. Calgon is mixed first with water, and then the clay body is gradually added while blunging.

- **When joining, it is not necessary to scratch the surfaces to be joined (this may not be true with all clay bodies, and needs to be tested). Apply slip to both surfaces with a brush, and press them together immediately. Excess slip can be removed from the seams after it has set a bit.**
- **For extra reinforcement of the joints, they can actually be “taped” together. The tape is made by cutting strips of very open weave fabric, such as cotton mosquito netting or cotton gauze; or if available, a very open weave fiberglass cloth. These tapes are dipped in slip, and applied to the joined pieces. The tape provides very high green strength and resistance to drying cracks. In the firing, it burns up, leaving only the slip. The disadvantage of this method is that the tape produces a texture at the joints - however, if used on the inside of items such as large planter boxes, this is not a problem. It also is possible to incorporate it as decoration on the outside.**

building forms with slip

It is also possible to build with slip, using moulds. This process is suited for making slabs, or for producing forms that are too large for practical casting in the normal way:

- **Deflocculated slip is prepared as usual, but as little water as possible is added. The slip should be just thin enough for the mixer still to work successfully - it will not pour as easily as regular casting slip. It can be used like this, or, for extra strong and more easily workable slip, it can be mixed with 0.5 % chopped nylon fibers - these are sometimes available in bulk, and should be cut to about 2 cm. It is important that they be single, unwoven fibers. It also is possible to make these**

fibers yourself, by chopping nylon rope. Nylon fibers work the best, because they are very fine and easy to separate. One half percent seems like a very small amount, but it is surprising how it increases the viscosity of the slip, and it gives incredible green strength.

Alternatively, finely-chopped jute fiber can be used. In India, this is often used in unfired clay sculpture.

- Building with this "fiberslip" is best done inside plaster moulds. The slip is simply spread on by hand or with a trowel, and built up to the necessary thickness (which will be about the same as plastic clay). The advantage is that slabs do not need to be made, and there are no problems with joining. Drying shrinkage is less than plastic clay, and cracking problems cannot occur because of the fiber. The nylon fiber is so fine that even though it burns up in firing, the finished appearance is no different from regular clay.

- Because the green strength is so great, it is a useful technique for large pots that are difficult to transport when green.

fiberslip for sculpture

Another way of using fiberslip is for slab making or for sculpture. Again, this is a process that ordinarily would not be used, but for large-scale work, where there are shrinkage problems, it is worth trying:

- The same slip as above is used, preferably with the addition of chopped nylon fiber.

- **The process of building up slabs is the same as making fiberglass, where glass cloth is used to reinforce plastic resin. With fiberslip, various kinds of cloth can be used: the main requirement is that they be very open weave so the slip can penetrate through them. Fiberglass cloth is good if it is about the same weave as mosquito netting; nylon net or cotton mosquito netting can be used; or "cheesecloth" (open-weave cotton gauze) also works well.**
- **To make a slab, first a paper (newspaper) separator is laid on a flat surface. Next, a piece of cloth the desired size is laid on this. Then, a layer of slip about 2-4 mm thick is spread on the cloth. Another piece of cloth is laid on the slip, and the process is continued until the slab is the desired thickness. When the slab is leather-hard, it can be cut (with a sharp knife) and assembled with slip and tape as above.**
- **For making large sculpture, the process can be quite useful. An armature (support) can be made from wood, wire, etc. and then covered with wire netting. This is then covered with cloth, and fiberslip is built up on the surface as for making a slab. Usually, the outer layers will be fiberslip only (with no reinforcing cloth) so that the surface can be caved and modeled. The pieces can be fired together - the armature will burn and melt in the process, but as it is inside the sculpture, this does not present a problem. Clay with low shrinkage is best for the process, such as plastic clay with a large grog percentage, or low-firing white clay such as 50 % ball clay/50 % talc.**

