





























































- ➔  **Forming Techniques for the Self-Reliant Potter (GTZ, 1991, 194 p.)**
-  **(introduction...)**
-  **Acknowledgements**
-  **1. Introduction and scope**
-  **2. Products and options**
 -  **(introduction...)**
 -  **2.1. Market sectors and forming considerations**
 -  **2.2. Investment decisions**
 -  **2.3. Choosing your product line**
-  **3. Main product lines and forming options**
 -  **(introduction...)**
 -  **3.1. Household ware, crockery, decorative and novelty items**
 -  **3.2. Tiles**
 -  **3.3. Refractories and miscellaneous industry support products**
 -  **3.4. Pipe**
 -  **3.5. Electrical products**
 -  **3.6. Miscellaneous products**
-  **4. Plastic clay forming**
 - 

-  **4.1. Plastic clay preparation**
-  **4.2. Hand-forming**
-  **4.3. Potter's wheel**
-  **4.4. Joining techniques**
-  **4.5. Jigger**
-  **4.6. Extrusion**
-  **5. Semidry foaming**
 -  *(introduction...)*
 -  **5.1. Advantages and disadvantages**
 -  **5.2. Press machines**
 -  **5.3. Semidry pressing with leather-hard clay**
 -  **5.4. Pressing with powder clay**
-  **6. Mouldmaking and Plaster of Paris**
 -  *(introduction...)*
 -  **6.1. STAMPS**
 -  **6.2. Moulds for plastic clay pressing, biscuit clay moulds**
 -  **6.3. Plaster substitutes**
 -  **6.4. Plaster of Paris**
 -  **6.5. Plaster mould making**
-  **7. Slip casting**
 -  *(introduction...)*
 -  **7.1. Casting body**

- ☐  **7.2. Slip building and fiberslip**
- ☐ **8. Finishing and quality control**
 -  **(introduction...)**
 -  **8.1. Importance of finishing**
 -  **8.2. Steps in finishing**
 -  **8.3. Methods of finishing**
 -  **8.4. Quality control**
- ☐ **9. Drying of ware and moulds**
 -  **(introduction...)**
 -  **9.1. Drying systems**
 -  **9.2. Drying of plaster moulds**
- ☐ **10. Work flow and factory layout**
 -  **(introduction...)**
 -  **10.1. Work flow example**
-  **Glossary**
-  **Tables of weights and measures**
-  **Table of sieve mesh sizes**
-  **Density**
-  **Twaddell scale**
-  **Dry content of liquid**
-  **Pint weights**
-  **Bibliography**

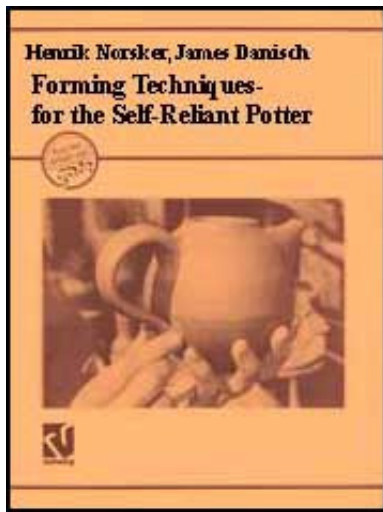

Forming Techniques for the Self-Reliant Potter (GTZ, 1991, 194 p.)

(introduction...)

Acknowledgements

1. Introduction and scope

2. Products and options

3. Main product lines and forming options

4. Plastic clay forming

5. Semidry foaming

6. Mouldmaking and Plaster of Paris

7. Slip casting

8. Finishing and quality control

9. Drying of ware and moulds

10. Work flow and factory layout

Glossary

Tables of weights and measures

Table of sieve mesh sizes

Density

Twaddell scale

Dry content of liquid

Pint weights

 **Bibliography**

Henrik Norsker, James Danisch

**A Publication of the Deutsches Zentrum fr Entwicklungstechnologien - GATE in:
Deutsche Gesellschaft fr Technische Zusammenarbeit (GTZ) GmbH - 1991**



[Home](#) > [ar.cn.de.en.es.fr.id.it.ph.po.ru.sw](#)

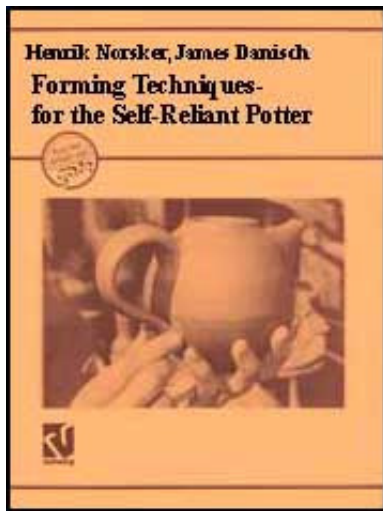

 **Forming Techniques for the Self-Reliant Potter (GTZ, 1991, 194 p.)**

➔  **8. Finishing and quality control**

 **(introduction...)**

 **8.1. Importance of finishing**

 **8.2. Steps in finishing**

 **8.3. Methods of finishing**

 **8.4. Quality control**

Forming Techniques for the Self-Reliant Potter (GTZ, 1991, 194 p.)

8. Finishing and quality control

Finishing is the process of completing all the details on a product - since this book is about forming, we will discuss finishing only up to the stage when the product

is ready for firing.

Quality control is an activity that ought to be a part of the production process, but which is very often neglected. First the producer has to decide what is an acceptable quality of the finished product and then he has to find out where in the production process control is needed to ensure that his products are up to standard. Finishing should always be followed by an inspection of quality.

8.1. Importance of finishing

Your customers will expect your products to be finished correctly, so that each piece has the same quality. It is the responsibility of the producer to guarantee his products, and to check the work at each production step.

Workers need to be instructed on their individual responsibilities for finishing, and the supervisor should be strict in rejecting products that do not meet the expected standard. The ideal system is: "Every worker is a quality controller", but this seldom works without careful instructions and an incentive scheme.

There are several ways of paying workers:

- fixed salary: Workers are paid a fixed monthly wage, regardless of production quantity. This is not usually a satisfactory system, as workers will tend to work as little as possible.**
- piece rate: This was the standard system for many years in the ceramics industry. However, with the introduction of labor unions, and the idea that factory owners should provide better treatment for labor, the system is not**

used so much nowadays.

- basic salary plus incentive for high production: many factories now use this system. Each worker has a fixed minimum production quantity, which is the amount of work he must produce in order to pay his production costs. If he produces more than the minimum quantity, he is paid extra according to the labor cost per piece.

These systems can be introduced by considering each main step in production as a separate industry. For example, the jigger section is responsible for producing finished greenware. This greenware is inspected and counted by the supervisor, and the workers in the jigger section are paid according to the amount of acceptable greenware. Similarly, the glazing section is paid according to the amount of correctly-glazed ware, and the firing section is paid according to the percentage of successfully-fired ware.

8.2. Steps in finishing

The steps in finishing vary according to the production method. For example:

Forming on the potter's wheel

- Before removing from the wheel: The rim must be smoothed, and the bottom is undercut to make trimming easy.**
- Leather-hard: The foot ring is trimmed and smoothed with a sponge. No further finishing should be required.**

- **Bone-dry: The product is inspected for cracks and imperfections, and any poor quality products are thrown in the scrap container.**

Slip casting

- **After the casting has started to pull away from the mould, the spare line is cut.**
- **Leather-hard: The mould line is cut away and smoothed with a sponge.**
- **Bone-dry: No further finishing should be required - only inspection and rejection of poor quality products.**

Joining

- **After forming of the individual parts: They are joined and all excess clay from the joining, fingerprints and marks are sponged away.**
- **Drying: The items are turned or paired to avoid cracking and warping.**
- **Bone-dry: inspection of quality.**

Press moulding

- **After pressing: Tile edges are fettled and in the case of plastic-pressed products press seams are cut and sponged.**
- **Bone-dry: inspection of quality.**

8.3. Methods of finishing

The methods of finishing have been discussed according to various forming systems potter's wheel, extrusion, jigger, slip casting, etc. Here are some general hints:

- Finish ware as soon as possible. It is usually easiest to finish ware as soon as it is possible to pick it up without damage. Potter's wheel products should be trimmed as soft as possible - waiting too long slows down the process and causes damaged products. If ware becomes too dry, it is best to throw it out, as trying to rewet it usually takes longer than starting over again. Trying to finish bone-dry ware with sandpaper is rarely satisfactory - it takes a long time, produces dust which is a health hazard, and leaves a rough surface.**
- Use the correct tool. Although one tool can be used for many finishing jobs, it is best to have specific tools in order to make finishing easier. For example, special tools can be easily made for jobs that need to be repeated many times: if you need to produce several hundred 2-inch posts, then it makes good sense to make a wooden cutting box which is set up for cutting the correct length.**
- Tools should be in good condition. Clay trimming tools should be sharpened regularly. Tools should be cleaned after use, and kept in a convenient location.**

8.4. Quality control

Acceptable quality varies according to the product. Common ware, such as low-cost storage jars, is often very roughly finished. Fine quality porcelain is rejected for even the slightest flaw, and often up to 50 % of products are not acceptable as top quality.

setting a standard

The producer must keep a constant watch on quality, and should try continuously to improve his product. A customer who receives even one batch of poor quality products is likely to look for another supplier. The level of quality depends on what quality competitors in the market are supplying and the expectation of the customers. Small tea shops will demand strong teacups, but will be more concerned about the price of the cup than its looks. So for that market quality means a cup with a strong handle, a rounded rim and no chipping or crazing of the glaze.

Quality does not mean that the products are beautiful; it means that the customer gets the product he expects. Good quality is not necessarily more costly or difficult to produce, but it pays attention to details and good management.

controlling quality

Once you have decided what your standard is for a particular product you can simply sort your finished products into two groups: acceptable and unacceptable. The rejected products could be sold at a lower price. This method is costly, because you have invested a lot of time, labor and materials in a product you will have to sell cheap or even throw out. The most cost-effective method is to look at the whole production process and decide where mistakes could be discovered early. As soon as a mistake is discovered the product can be rejected and no more time and money are wasted on a faulty product. Let us look at an example that shows where inspection could prevent faults in the finished product (table on p. 164).

In a small industry where the producer or the supervisor is directly involved in the production he would check the production at most of the steps listed above. He could make inspection a part of another activity to save time. If the supervisor packs the biscuit kiln all products will have to go through his hands and this is a good opportunity to check all products.

In larger industries more formal quality control procedures are needed. In the example above inspection could be reduced to a check of the casting slip and a check when the products are completely dry. At that point both the quality and the quantity can be assessed as part of a piece rate pay system. The factory manager should make frequent spot checks at all steps in the production to make sure that the quality control system works.

fulfilling orders

The biggest problem for small producers is accepting more orders than they can complete in time. Rush orders are likely to be poorly finished, and customers will never accept excuses for poor quality. For that reason, producers must learn to correctly estimate production time, and should never tell customers that they can do it faster. At the time of taking orders the producers should also show their customers what quality they can expect. In ceramics production, especially in small industries, there will always be variations in color, texture, etc. The customer should be shown these and not only a few chance samples, that will be hard to reproduce.

Customers come back again if they know they can trust a producer to tell them the truth.

Slip-cast cup: quality control points

OPERATION	POSSIBLE FAULT	INSPECTION
Slip preparation	Pinholes	Air bubbles in slip before casting
Slip casting	Cup too thick/thin	Casting time
Trimming rim	Uneven rim, sharp edge	Rims
Attaching handles	Handles easily come off	Dryness of cup
Finishing/drying	Warping, rough surface, handles out of position, cracking	When dry, before biscuit firing, all rejects put in clay scrap bin.
Unpacking biscuit	Cracking, overfiring	Cracks and warping
Glazing	Crawling, pinholes, running, etc.	Dirty biscuit ware, glaze thickness
Firing	Over/underfiring, etc.	Cones, draw trials
Transfer to store	All the above-mentioned standard.	Sorting according to





[Home](#) > [ar](#).[cn](#).[de](#).[en](#).[es](#).[fr](#).[id](#).[it](#).[ph](#).[po](#).[ru](#).[sw](#)

 **Forming Techniques for the Self-Reliant Potter (GTZ, 1991, 194 p.)**

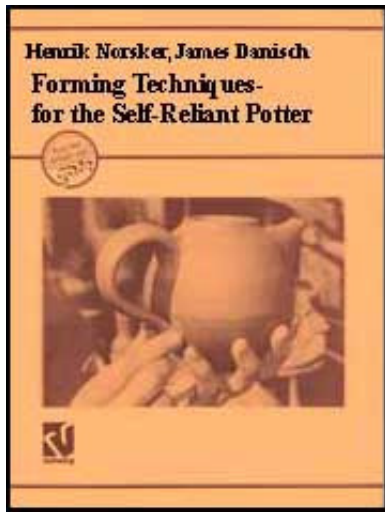
  **9. Drying of ware and moulds**



-  **(introduction...)**
-  **9.1. Drying systems**
-  **9.2. Drying of plaster moulds**

Forming Techniques for the Self-Reliant Potter (GTZ, 1991, 194 p.)

9. Drying of ware and moulds

Drying takes place when the water in the clay transfers to the surrounding air. When the air outside the clay contains as much moisture as the air inside the clay, the process of drying stops.

leather-hard

As the water leaves the spaces between the clay particles, these move closer together. That causes the clay to shrink as the water disappears; but when the particles all touch each other, little more shrinkage will take place. This stage is termed leather-hard, and there is still plenty of water left between the clay particles. The graph shows the relationship between drying shrinkage and water content of a clay.

rate of drying

Clay dries faster in warm, dry and windy weather. The rate of drying can be slowed down by covering the clay with plastic sheets or wet cloth, which causes the air surrounding the clay to become more humid.

The clay ware should dry evenly so that it shrinks evenly. A handle on a cup tends to dry faster than the cup itself, and the different rate of shrinkage will produce a crack in the handle - unless care is taken to let the whole cup dry slowly.

warping

Warping is caused by uneven drying. A tile will dry more on its upper surface so this will shrink and bend the tile upward. Cracking and warping are reduced by turning the products frequently during drying. Warping of plates and bowls is avoided by stacking them on top of each other rim to rim.

Thin clay ware dries faster and more evenly than thick ware, and is therefore less prone to cracking and warping. Thick-walled designs should be allowed to dry extremely slowly or should be made from clay with a high content of coarse materials like grog and sand.

Small products can be dried rapidly without problems. Large items require special care in drying, especially in dry weather or hot climates.

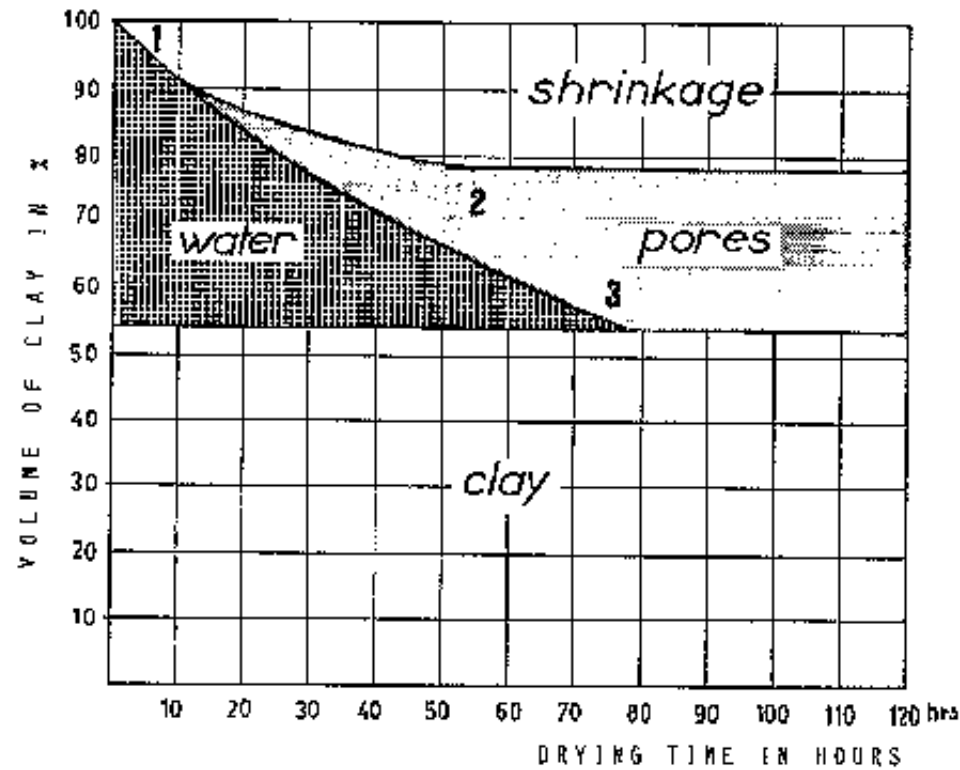

FIGURE 9-A Example of relationship between water content, shrinkage and pores. After 50 hours the clay has become leather-hard and shrinkage stops. The condition of the clay at points 1-3 is illustrated in Fig. 9-B.

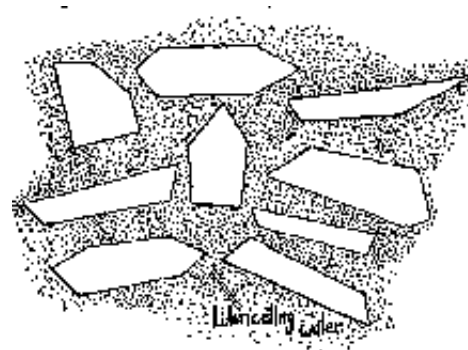

FIGURE 9-B Three stages of clay from forming to dry (enlarged about 100,000

times).(1)

1) Water surrounds all particles, the clay is plastic.

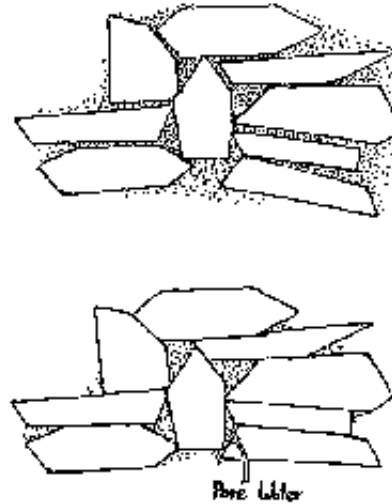

FIGURE 9-B Three stages of clay from forming to dry (enlarged about 100,000 times).(2;3)

2) The clay is leather hard. Particles touch one another.

3) Clay is dry. Only a little water remains in the clay pores. The water remaining between the clay particles in the pores continues to move out of the clay to the surface, from where it evaporates. When no water remains in the pores the clay is called bone-dry.

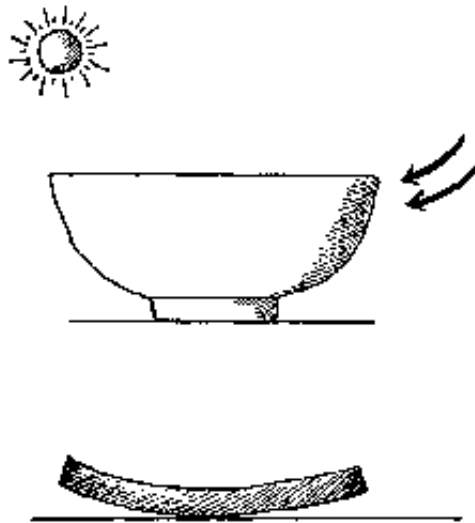

FIGURE 9-C Drying hints.(A; B)

A) Keep drying items away from sun and wind.

B) Rotate items several times a day if they seem to be drying unevenly. Flatware like tiles are sure to warp if not turned.

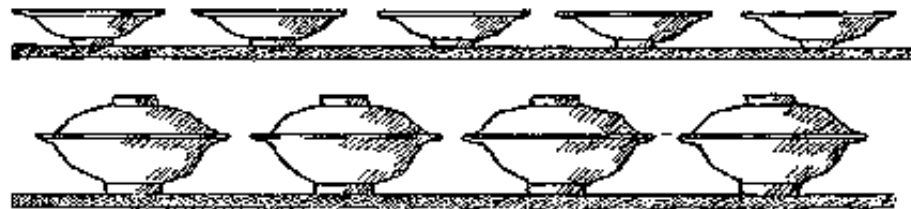

FIGURE 9-C Drying hints.(C)

C) Placing bowls, plates, cups, etc., rim to rim prevents warping.



FIGURE 9-C Drying hints.(D)

D) Large items should be dried very slowly, and can be loosely covered with plastic sheets.

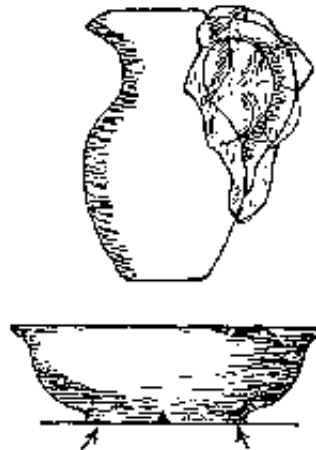

FIGURE 9-C Drying hints.(E; F)

E) Added parts, such as large handles, can be wrapped in plastic or painted with liquid wax emulsion, so that they do not dry faster than the rest of the pot.
F) Items with large bottoms may crack across the center of the bottom, because the bottom sticks to its support and when it shrinks the periphery cannot follow. Sticking can be prevented by placing the pot on sheets of paper or dusting its support with sand or fine grog.

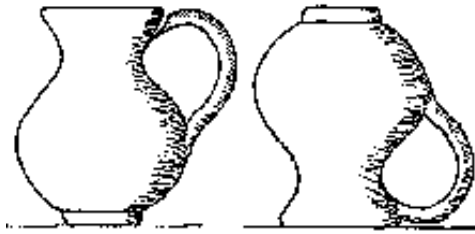

FIGURE 9-C Drying hints.(G)

G) After attaching handles let the pot dry upside down. Otherwise the rim will dry faster and this may crack the handle.

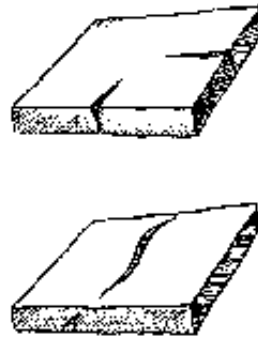

FIGURE 9-C Drying hints.(H; I)

H) Typical crack of plastic-formed tiles dried in bungs. Edges dry first, but the center of the tile is under pressure and cannot accommodate the shrinkage of the edges so they crack. Stack tiles more openly. Dust pressed tiles crack in the same way, but more easily because they have less green strength and additional problems with lamination.

I) For plastic-formed tiles: the edges dried first and the center accommodated the shrinkage. When the center shrunk the rigid edges caused it to crack. Semidry pressed tiles: the pressure in the center caused less stress due to differences in particle orientation.

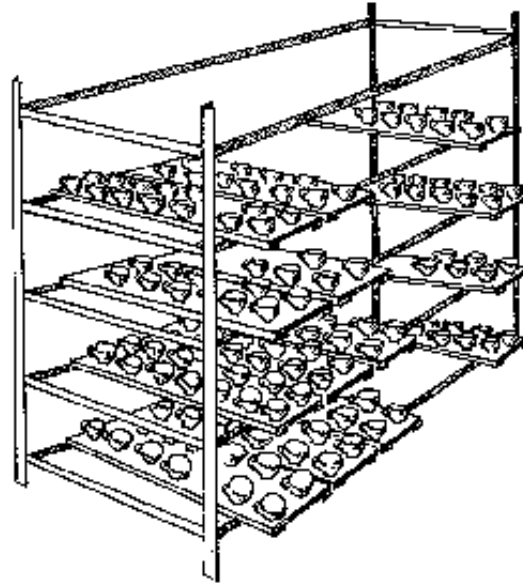

FIGURE 9-C Drying hints.(J)

J) Pots with handles or spouts attached should be dried slowly. Place them on the bottom of the rack where it is cooler and drying is slower. Cover with plastic if necessary.

9.1. Drying systems

Air can absorb water until saturated. How much it can absorb depends on how much it holds already and on its temperature. The higher the temperature, the more water can be contained in the same volume of air. There are three basic approaches to air drying of clay ware:

- A large amount of unheated air is circulated around the ware. Example: outside drying sheds for drying of bricks and roofing tiles.**

- A small amount of air is heated to a high temperature. This is seldom used except in the ceramics laboratory.

- A medium amount of air is heated moderately. Example: batch dryers for clay ware and plaster moulds. Rapid circulation of air is more energy-efficient for drying than high temperature.

Thin-walled crockery will dry by itself on the ware racks. Drying of heavy articles like bricks, tiles or pipes may need the help of dryers, especially in the rainy or cold seasons.

The simplest way of speeding up drying is to carry the ware outside and leave it in the sun to dry. Trolley racks make this easier.

Artificial drying is most often done by heating air and circulating it around the drying ware. For heavy clay products like sanitary ware, it is sometimes done by placing the ware on a heated floor. Infrared light is a technically good solution, but electricity is expensive. The cheapest way is to make use of the waste heat from kiln firings.

kiln drying racks

Racks for holding drying ware can be arranged around the kiln or on top of it, so that the heat radiating from the kiln during firing and cooling dries the ware. The warm kiln will create a draught of warm air that also helps drying.

drying chamber

For medium-scale industries with large outputs, or for drying plaster moulds, a drying chamber is useful. Inside the chamber a ware rack is made for ware boards, or better still, the chamber is made to hold one or more ware trolleys so that drying goods can be taken in and out quickly.

cross draught chamber

Warm air from a cooling kiln or from an additional stove is introduced from one side and a fan provides a draught across the chamber through the ware racks. A constant movement of air over the drying ware is as important as heat. The air is not saturated with water by just passing through the chamber once, so in order to economize, most of the air should be recirculated by the fan. A centrifugal fan is most appropriate for this.

The centrifugal fan can at the same time draw hot air from the kiln via a duct system. However, combustion air should not be used directly. It contains soot that will dirty the ware, along with moisture and sulfuric acids that may corrode the duct system.

tunnel dryer

The same principle can also be used in a tunnel dryer where the ware trolleys enter at one end and are taken out at the other. The trolleys should move in the same direction as the drying air.

cabinet dryer

A more simple drying chamber can be made as a cabinet with a ware board rack

inside, a heating device in the bottom and a hole at the top for moisture to escape. Heating can be done by electricity or by a stove. Combustion air, except from burning gas, should not enter the drying chamber since the ware will be dirtied by soot. The hot combustion gas can instead be led through the chamber in stove pipes. Combustion itself takes place in a small stove or firebox next to the drying chamber.

mangle dryer

For large potteries a mangle dryer is a cost-effective way of drying ware and moulds. An endless chain is carrying shelves loaded with ware inside a drying chamber. The shelves are loaded at one end next to the forming unit and emptied at the other end. The size of the shelves and the speed and length of the chain are designed according to the capacity of the forming unit. This type of dryer is mainly used in jigger ware production and its initially higher cost is justified by longer mould life, lower labor cost, and saving on space, racks and ware boards.

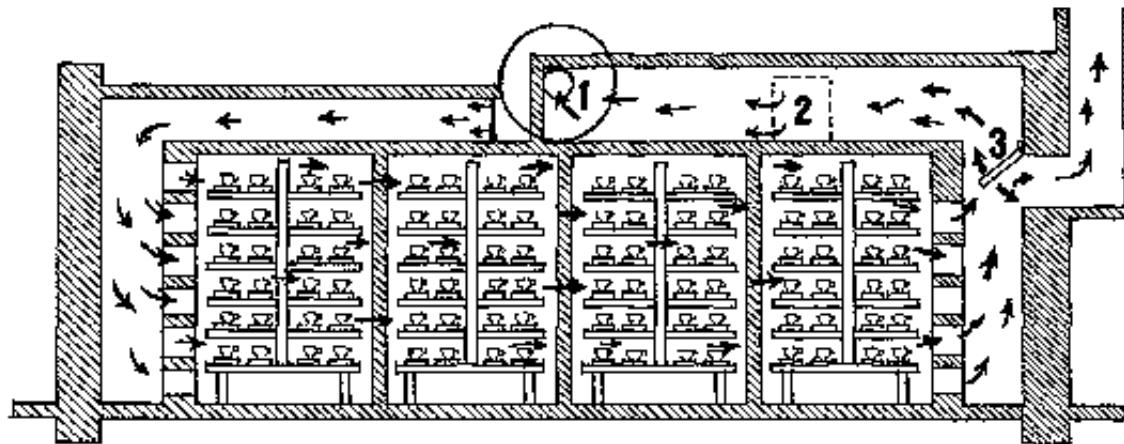

FIGURE 9.1-C Drying chamber with a fan (1) recirculating air and drawing waste

heat through a duct (2) from the kilns. A damper (3) regulates amount of air to be recirculated.

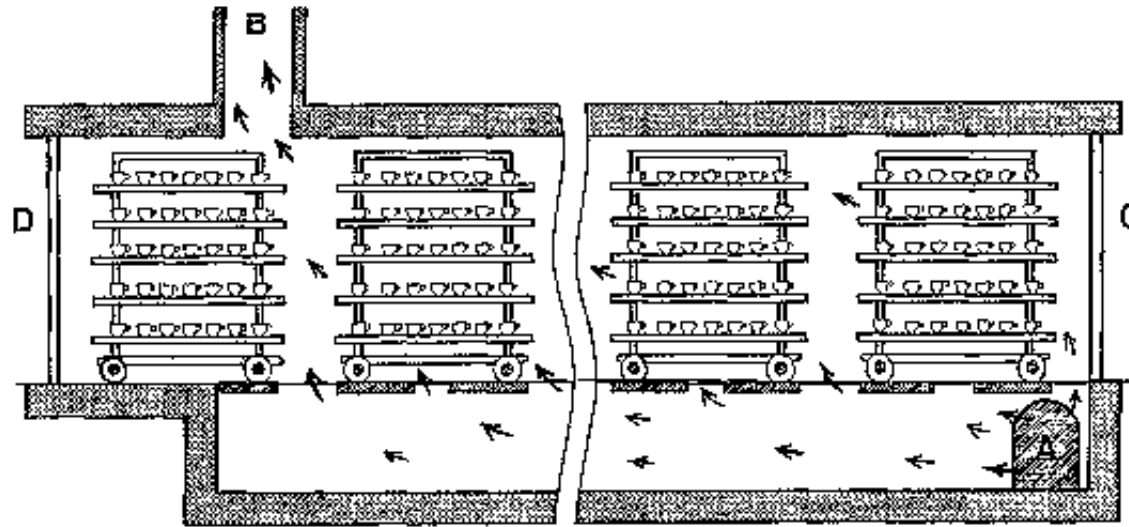

FIGURE 9.1-D Trolley tunnel dryer. Waste heat enter at (A) and exits at (B). Ware trolleys enter at (C) and are taken out at (D).

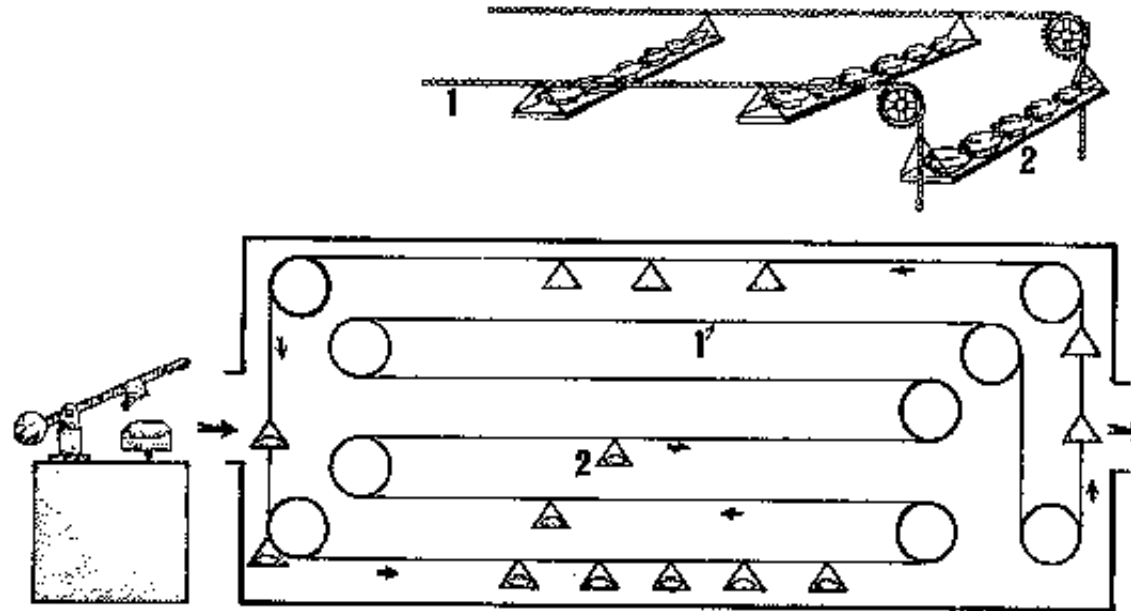

FIGURE 9.1-E Mangle dryer. The endless chain (1) carries shelves (2) with ware and moulds.

9.2. Drying of plaster moulds

Plaster moulds used in casting or jigger production need to be dried regularly. Working with wet moulds slows down production and moulds that are constantly wet become soft and "rotten". Hardness and strength of wet moulds are only half of that of dry moulds. This reduces the number of times moulds can be used, and consequently increases production cost per unit. Moulds need to be dried at least once a day if they are to last long.

cost of drying:

Drying of plaster moulds follows the same principles as for drying clay ware.

However, the need for drying is more urgent, because the production requires a constant supply of dry moulds. If no artificial drying is used, it means that a large number of moulds has to be in stock. This takes up a lot of space, increases labor cost since the workers will have to carry farther for the moulds, and more money will be tied up in a large stock of moulds. All of this costs money, and with jigger or casting production of some scale, it may be more economical to use artificial drying.

recalcination of moulds:

Plaster should not be overheated, because it will then start to recalcine. Gypsum starts to calcine from around 100°C, and since set plaster is actually gypsum, the plaster moulds also become calcined on heating. At temperatures above 50°C, the plaster moulds will start to soften and become chalky at the edges. This will of course weaken the moulds and reduce their service life.

dryer operation:

When operating the dryer it is very important to make sure that the temperature inside the dryer does not exceed 50°C. An ordinary thermometer is placed inside the dryer and its temperature is checked regularly. As long as the moulds are wet, they do not become hot even if the air is above 50°C, but once they are dry they will suffer damage, especially on their edges and corners which dry out first. Recalcination and cracking due to thermal shock can be reduced by painting mould edges with a 10 % solution of corn sugar. It is safer to take the moulds out of the dryer when they are still slightly damp.

deflocculants:

Plaster moulds used in slip casting should be dried only from their outer surface. That means they should be kept assembled as for casting so that only a little water will evaporate from the inner mould surface. The casting slip and therefore also the water in the casting moulds contains deflocculants, and when the water evaporates, the deflocculants remain on the mould surface. Deflocculants attack plaster, so it is better if they are concentrated on the outside of the mould, where they do little harm. If the mould dries from its inner surface it will wear out faster.

dryer location:

One advantage of using a mould dryer is that less time is spent on handling moulds. The dryer should be located close to the forming area. Jigger moulds may be placed in the dryer with the clay items inside, so when the moulds are taken out of the dryer they are emptied before returning to the jigger operator. The jiggered items are then put on ware boards which are brought to another area for finishing. Before deciding on where to place the dryer, the work flow of the whole process should be worked out.

Additional information on drying is given in sections 4.2.4. and 4.3.6.



[Home](#) > [ar](#).[cn](#).[de](#).[en](#).[es](#).[fr](#).[id](#).[it](#).[ph](#).[po](#).[ru](#).[sw](#)

 Forming Techniques for the Self-Reliant Potter (GTZ, 1991, 194 p.)

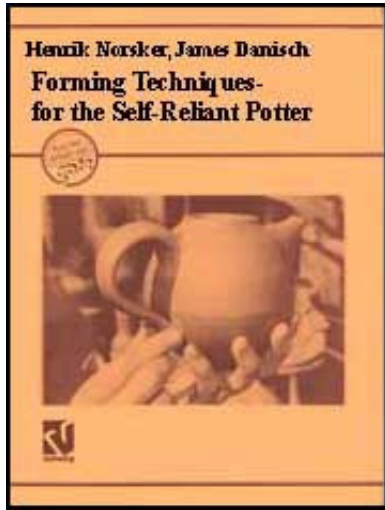

- ➔ 10. Work flow and factory layout
 - 📄 (introduction...)
 - 📄 10.1. Work flow example

Forming Techniques for the Self-Reliant Potter (GTZ, 1991, 194 p.)

10. Work flow and factory layout

Work flow is simply all the steps that are necessary from beginning to end of any production process. For anybody engaged in production, it is very useful to take the time to list all the steps, and to find out where time and energy are being wasted.

The various steps in a production work flow can all be broken down into the following, and shown in a graphic way with symbols:

Analyzing your work flow is very helpful for increasing production efficiency. When you understand all the steps, you can often make work easier and increase profitability by:

STEP	SYMBOL	EXPLANATION
------	--------	-------------

Raw materials' storage	V	
Operation	O	action which changes the form of a material, like cutting, pressing, throwing, etc.
Transport	D	moving material from one location to another
Delay	>	necessary step which takes significant time, like drying
Operation/delay	#	operation that takes significant time, like firing
Inspection	*	quality control check
Finished goods' storage	^	

- ORGANIZING THE WORKPLACE

The location where forming or finishing work is done should be furnished with a good source of light and enough space around the workplace to allow easy movement. Remove all unnecessary equipment and rubbish which will hamper work. Only equipment that is needed should be kept at the workplace. Frequently-used tools could be hung on the wall. Keen racks for storing products nearby.

- TRANSPORTING EQUIPMENT

Ceramic products go through many operations so they are moved around a lot. Carrying one pot at a time is a waste of time. Most pottery can be carried on ware boards about 120 cm long and 10 - 20 cm wide. A ware

board can carry 20 cups at a time and they can be stored on stationary racks or on trolley racks.

Raw materials and heavy products like bricks and pipes can be moved on carts.

- MAKING TRANSPORTATION DISTANCES AS SHORT AS POSSIBLE

If you can rearrange your workshop so that clay only has to be carried 10 meters instead of 50 meters, this saves a lot of wasted effort. Another example is a pipe factory, where pipe has to be carried over rough ground and around heaps of coal, etc., to get to the kiln. This creates a lot of extra work, and disturbs the workers, as well as possibly being the cause of injuries. It would make good economic sense to take a day to construct a clear pathway, as the work would go much better afterwards.

- REDUCING DELAYS AS MUCH AS POSSIBLE

Often there is not much that can be done about delays. For example, it may not be possible to shorten firing time. Another frequent delay is drying - in this case, it is worth getting some help to compare the cost of artificial drying with air drying.

Even though the initial investment may be high, sometimes the time saved makes it financially advisable. This may be especially true for jigger production, where a forced air dryer can cut down on the number of moulds required and increase daily production capacity at the same time.

However, we do not recommend investing in expensive equipment unless the benefits have been carefully analyzed beforehand. Factory owners often buy the latest equipment just because it is new, and regret it later when it does not meet expectations.

production capacity

Once you have analyzed your production flow and made a good plan for reducing time wasted on internal transport, etc., you will also find that some sections in your production are bottlenecks. That means they delay the flow of products causing other sections to be idle while they wait for materials or semifinished products. There are various possibilities for curing bottlenecks or increasing production capacity in general:

- reorganize work procedures and workplace**
- increase number of workers**
- introduce incentive pay scheme**
- work in two or three shifts**
- increase capacity of machinery.**

Several options may be used at the same time. Before you start to change anything try to make two or three different plans and then compare the cost of them.

consultants

There are actually industrial consultants who make very detailed work flows, to the point of finding out how many seconds each step takes, and then try to find

ways to shorten the time. This is useful up to a point, but most small producers either operate a family business, or have quite a small number of workers, who are not likely to cooperate if they are asked to take 5 seconds for an operation that normally takes them 6 seconds. People are not machines, after all, even though management would often like to see them that way.

Work flow is the starting point for planning factory layout. This is true for planning new factories, as well as remodeling old ones (which often have expanded gradually and have become inefficient in the process).

10.1. Work flow example

The following work flow analysis of a jigger cup production in Burma is an example of how production can be reorganized with simple means.

original situation

Before the reorganization of the production, jigger moulds were placed on racks behind the jigger machines and two assistants for each jigger machine would run between the rack and the jigger machine with 2 to 3 moulds at a time. After being taken out of the moulds, the jiggered cups were carried by hand in stacks 15 to 20 cups high to fettling machines. This system was very laborintensive and the stacking caused many cracks.

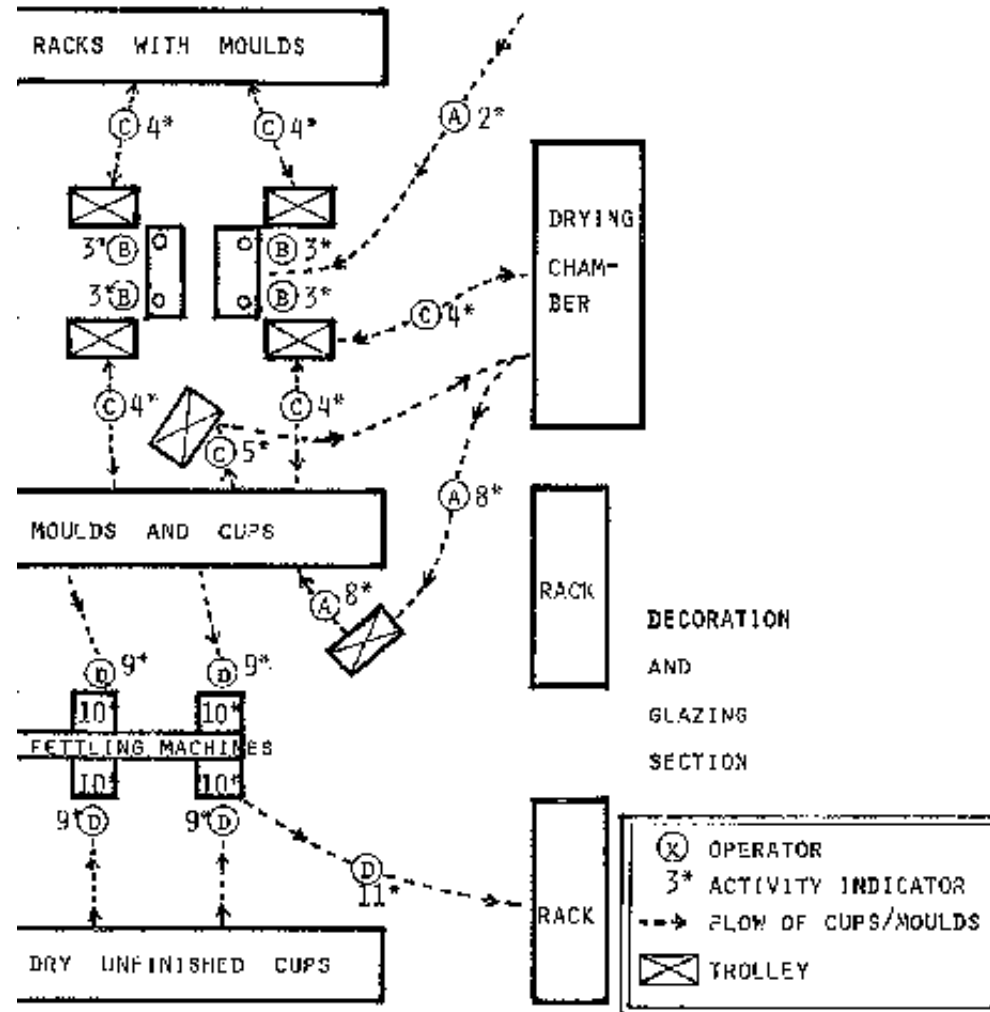

FIGURE 10.1-A Work flow plan of the jiggering production analyzed below.

reorganization

A system for internal transport of products was established. Ware boards for carrying cups and moulds were introduced together with stationary racks and

trolleys to hold the boards. One board could carry 6 cup moulds. A trolley could hold 36 boards or a total of 216 cup moulds. In the work flow analysis 216 cups are used as the batch unit.

A drying chamber was constructed so that it could accommodate four trolleys with ware and moulds. The jigger machines were relocated and placed so that they were close to both drying chamber and the fettling machines. The layout is shown in the process flow plan in Fig. 10.1-A, which corresponds with the work flow chart in Fig. 10.1-B.

The jigger operator (B) would always have one trolley next to her and she would pick one mould at a time directly from the board on the trolley. When the moulds on one side were filled with jiggered cups she would just turn the whole trolley and start with fresh moulds. An assistant (C) would replace the boards with filled moulds with fresh ones from the rack next to the jigger machines. During the rainy season the assistant would take the whole trolley to the drying chamber and replace it with another. With this system one assistant could service two jigger machines.

Another worker (A) would supply clay to all jigger machines and would also transfer dried cups to the fettling machines. The stationary racks were placed between the jigger section and the fettling section so that jiggered products placed in the rack from one side could be taken out by the fettling operators on the other side.

The work flow chart below shows the minutes it takes for each operator to finish one batch, equal to 216 cups. The production capacity is planned according to the

daily output of the four jigger machines. If another step in the production flow cannot finish this quantity per day it becomes a bottleneck. A work flow chart shows such bottlenecks and indicates how to solve them.

The longest time it takes on average for one group of operators to finish one batch is 20 minutes. That means that during a workday of 7 hours, 21 batches or 4536 cups can be produced. If the fettling unit could produce more by having an extra machine or working overtime, average batch time could be 16 minutes. This would increase production to 5040 cups per day. This could be achieved by having the fettling unit work 45 minutes extra per day.

The flow chart also shows that operator A only spends 11 minutes per batch. He could therefore be given an additional task like looking after the drying chamber.

ACTIVITIES		OPERATORS				MINUTES
		A	B	C	D	
1 clay storage	V					
2 clay to jigger machines		D				1
3 jiggering cups			O			64
4 replacing filled moulds				D		15
5 emptying moulds of cups				O		15
6 cups to dryer				D		2
7 cups drying	>					240
8 dryer to fettling rack		D				10

9 rack to fettling machine					D	3
10 fettling cups					O	74
11 cups to decoration rack					D	3
Minutes per type of operator:		11	64	32	80	
Number of respective operators:		1	4	2	4	
Average batch time per operator		11	16	16	20	



[Home](#) > [ar.cn.de.en.es.fr.id.it.ph.po.ru.sw](#)

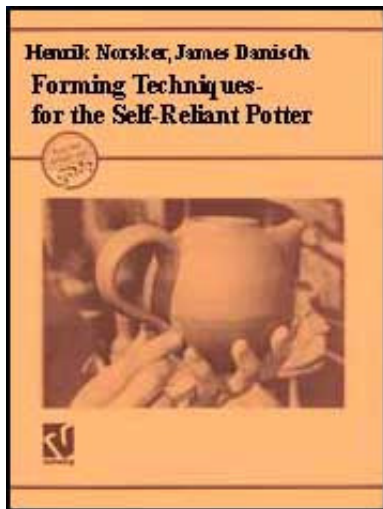

Forming Techniques for the Self-Reliant Potter (GTZ, 1991, 194 p.)

 **(introduction...)**

 **Acknowledgements**

 **1. Introduction and scope**

2. Products and options

3. Main product lines and forming options











4. Plastic clay forming

5. Semidry foaming

6. Mouldmaking and Plaster of Paris

7. Slip casting

8. Finishing and quality control

-  **9. Drying of ware and moulds**
-  **10. Work flow and factory layout**
-   **Glossary**
-  **Tables of weights and measures**
-  **Table of sieve mesh sizes**
-  **Density**
-  **Twaddell scale**
-  **Dry content of liquid**
-  **Pint weights**
-  **Bibliography**

Glossary

Absorption	Takes place when water is soaked up by biscuit-fired clay.
Accelerator	A material that increases speed of a chemical reaction.
AC motor	Motor for alternating current, which is the type of current normally supplied to house holds.
Acrylic plastic	An artificial material made from carbon polymers.
Adhesion	Bonding between two surfaces.
Ageing	Also called maturing. Storing of plastic clay under moist conditions increases plasticity.
Armature	Internal framework to support a sculpture or other structure.
Ball clay	A fine-grained, plastic clay firing to a white or buff color.

Bat	A small slab of plaster of parts used as a base for pots during forming and drying. A slab of clay used in production of saucers and plates on a jigger machine.
Batch	A quantity of products or a mixture of materials treated as one set.
Bone-dry clay	Clay that has been dried above 100_C. No moisture remains between the clay pores.
Bullring kiln	Also called bull trench kiln. A continuous kiln for firing bricks. Bricks are stacked in a ring-shaped trench and covered with a sealing layer. Chimneys are placed on top of the kiln and moved as the firing zone moves around continuously.
Calcine	To heat a (ceramic) material to a temperature high enough to release carbon dioxide, chemical water or other gases.
Calgon	Deflocculant used in casting slips. Chemically termed sodium hexametaphosphate.
Chuck	A tool used to hold pots or other items while they are worked on.
Clay body	A mixture of different clays and other materials like grog, feldspar and talc. Clay is a natural product; clay body is man-made.
CMC	An organic binder based on cellulose. Chemically termed carboxymethyl cellulose sodium salt.
Coir	The outer husk of coconut used for making ropes.
Continuous kiln	A kiln fired continuously. In tunnel kilns the ware is moved through the firing zone. In ring kilns (Hoffmann kilns) the firing zone is moved.
Crockery	Clay pots used in the household.
DC motor	Direct current motor. A battery supplies direct current.

De-airing	Removing air from plastic clay by exposing it to a strong vacuum. It improves plasticity and reduces lamination problems.
Deliquescent	A material (salt) that easily absorbs moisture from the air.
Density	The modern term for specific gravity. The number of times a material is heavier than the same amount of water. If a slip has a density of 1.7 it means that 1 liter slip weighs 1.7 kg.
Dewatering	Removing water from a clay slip in order to get a plastic clay.
Extrude	Shaping of a plastic material like clay by forcing it through a die.
Fettling	Trimming rough edges of pottery before firing.
Fireclay	A clay that can withstand high temperatures though it may not fire to a white color. It is used for making refractory materials.
Flux	Material that lowers the melting point of a clay body.
Frit	Is made by melting several glaze materials to a glassy mass which is ground and used in a glaze. Frit added to a body or a glaze lowers its melting point.
Fulcrum	The point against which a lever turns.
Granule of clay	A small grainlike mass of clay particles.
Grog	Fired clay that has been crushed. Grog is added to clay to reduce drying cracks or to reduce thermal shock cracks in kiln furniture or firebricks.
Household ware	Pottery used in the household.
HP	Abbreviation for horsepower, a measurement of how much work a machine can do. 1 HP = 0.7457 kilowatts.
Hydrostone	A special hard plaster that is capable of making plaster mixtures with much

	less water than normal plaster .It is used for making models, master and case moulds and press moulds.
Kiln furniture	Shelves or slabs, saggers; posts or stands, used for placing ware in the kiln during firing.
Kneading	Manually work up clay for the purpose of mixing it better, getting air pockets out of it, and making it softer. Kneading is done immediately before clay is used for forming.
Lamination	Separation of materials in layers. Often seen in pressed tiles and in extruded clay products.
Low tension insulator	A glazed ceramic item used for insulating electric wires for currents below 440 volts.
Overglaze	Decoration with colorants on top of other already-fired glazes. The firing of over glaze decorations is done at a lower temperature than the original glaze firing.
Plastic	A plastic material (like clay) has the ability to be moulded easily. Acrylic plastic is often just called plastic.
Porosity	Ability of fired clay to absorb water. After firing the pores between the clay particles can hold water.
Refractories	Materials or products like firebricks, kiln slabs, etc., which can withstand high temperatures without melting.
Relief designs	A clay surface can be moulded so that some parts stand out from the rest of the surface. It is a picture in three dimensions.
r.p.m.	Abbreviation of revolutions per minute. A potter's wheel may rotate at 200 r.p.m.
Sanitary	Ceramic ware used in bathrooms and for disposal of sewage.

ware	Mixture of clay and water. Used in casting and for joining leather-hard clay pieces.
Smokeless stove	A stove for cooking provided with a small chimney that takes the smoke from the cooking fire outside the house.
Smoking	A potter's term used for the first period of firing a kiln with greenware. During this period all moisture is released from the clay and the water vapor looks like smoke.
Tableware	Items like plates and cups used for eating at the easily.
Vitrified	When clay is fired to a high temperature it starts to melt. It is vitrified when after firing it is hard and brittle and absorbs little water.
Warping	Deformation of ceramic items caused by uneven drying or overfiring.
Wax	A long strip of clay extruded from a die.
Wedging	A manual method of preparing plastic clay. A lump of clay is thrown forcefully onto a solid table. It is then cut in two, one half then being thrown down on the other half. This is repeated 20-50 times.











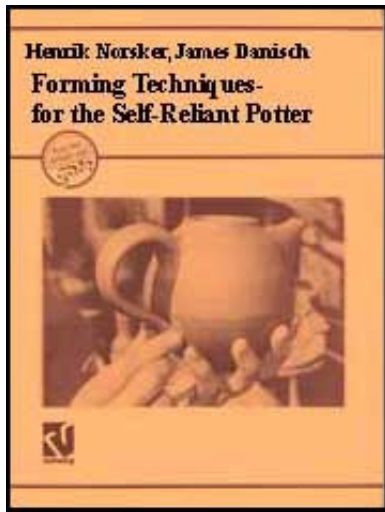











[Home](#) > [ar](#).[cn](#).[de](#).[en](#).[es](#).[fr](#).[id](#).[it](#).[ph](#).[po](#).[ru](#).[sw](#)

 **Forming Techniques for the Self-Reliant Potter (GTZ, 1991, 194 p.)**

 ***(introduction...)***

 **Acknowledgements**



-  **1. Introduction and scope**
-  **2. Products and options**
-  **3. Main product lines and forming options**
-  **4. Plastic clay forming**
-  **5. Semidry foaming**
-  **6. Mouldmaking and Plaster of Paris**
-  **7. Slip casting**
-  **8. Finishing and quality control**
-  **9. Drying of ware and moulds**
-  **10. Work flow and factory layout**
-  **Glossary**
-   **Tables of weights and measures**
-  **Table of sieve mesh sizes**
-  **Density**
-  **Twaddell scale**
-  **Dry content of liquid**
-  **Pint weights**
-  **Bibliography**

Tables of weights and measures

Metric System:

1 kilometer, km =1000 meters, m

1m =100 centimeters, cm

1cm =10 millimeters, mm

1mm =1000 micron, μ

1 cubic meter, m^3 =1000 liters, l

1l =1000 cm^3 or ml

1ml =1000 mm^3

1 tonne =1000 kilograms, kg

1kg =1000 grams, g

1g =1000 milligrams, mg

to convert:	to:	multiply metric by:	to convert:	to:	multiply U.K. & U.S. by:
length:					
m	feet	3.280	feet	m	.305
m	inches	39.370	inches	m	.025
cm	inches	.394	inches	cm	2.54
mm	inches	.039	inches	mm	25.400
area:					
hectare	acres	2.471	acres	hectare	.405
m^2	sq. feet	10.764	sq. feet	m^2	.093
cm^2	sq. inches	.155	sq. inches	cm^2	6.451
volume.					
m^3	cu. feet	35.314	cu. feet	m^3	0.0283

m ³	cord (wood)	.276	cord	m ³	3.625
cm ³ (cc)	cu. Inches	.061	cu. inches	cm ³ (cc)	16.387
1	cu. Inches	61.020	cu. inches	l	.016
1	U.K. gallon	.219	U.K. gallon	l	4.546
1	U.S. gallon	.264	U.S. gallon	l	3.785
weight					
kilograms	pounds	2.205	pounds	kilograms	.453
grams	ounces	0.035	ounces	grams	28.349



[Home](#) > [ar](#).[cn](#).[de](#).[en](#).[es](#).[fr](#).[id](#).[it](#).[ph](#).[po](#).[ru](#).[sw](#)

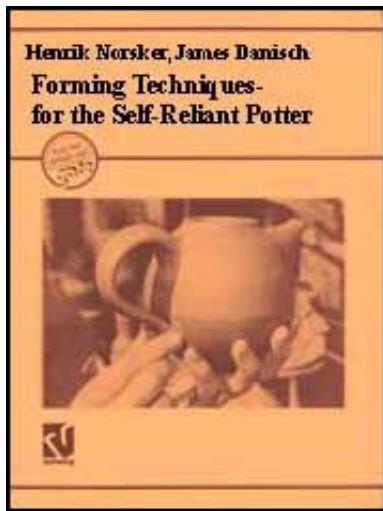

Forming Techniques for the Self-Reliant Potter (GTZ, 1991, 194 p.)

 **(introduction...)**

 **Acknowledgements**

 **1. Introduction and scope**

2. Products and options

3. Main product lines and forming options

4. Plastic clay forming

5. Semidry foaming

6. Mouldmaking and Plaster of Paris









- 7. Slip casting**
- 8. Finishing and quality control**
- 9. Drying of ware and moulds**
- 10. Work flow and factory layout**
-  **Glossary**
-  **Tables of weights and measures**
-  **Table of sieve mesh sizes**
-  **Density**
-  **Twaddell scale**
-  **Dry content of liquid**
-  **Pint weights**
-  **Bibliography**

Table of sieve mesh sizes

Table of Standard Sieves

Germany		Britain		United States		France
DIN		B.S.I.		U.S. standard		AFNOR
Openings		Openings		Openings		Openings
mm	mesh/cm		mesh/in.	mm	mesh/in.	mm
6.000						
				5.613	3	

5.000						5.000
				4.76	4	
4.000				4.00	5	4.000
		3.353	5	3.36	6	
3.000						3.150
		2.812	6	2.83	7	
2.500		2.411	7	2.38	8	2.500
2.000		2.057	8	2.00	10	2.000
1.500	4	1.676	10	1.68	12	1.600
		1.402	12	1.41	14	
1.200	5	1.204	14	1.19	16	1.250
1.000	6	1.003	16	1.00	18	1.000
		0.853	18	0.84	20	0.800
0.750	8	0.699	22	0.71	25	0.630
0.600	10	0.599	25	0.59	30	
0.500	12	0.500	30	0.50	35	0.500
0.430	14	0.422	36	0.42	40	0.400
0.400	16					
0.340	18	0.353	44	0.35	45	
0.300	20	0.295	52	0.297	50	0.315
0.250	24	0.251	60	0.250	60	0.250

0.200	30	0.211	72	0.210	70	0.200
0.177	35	0.178	85	0.177	80	
0.150	40	0.152	100	0.149	100	0.160
0.120	50	0.124	120	0.125	120	0.125
0.100	60	0.104	150	0.105	140	0.100
0.090	70	0.089	170	0.088	170	
0.075	80	0.076	200	0.074	200	0.080
0.060	100	0.066	240	0.062	230	0.063
0.053	110	0.053	300	0.053	270	0.050
0.040	130			0.037	400	0.040

Mesh means the number of threads per linear cm or inch of sieve cloth. Openings indicate the distance in mm between to threads.



[Home](#) > **[ar](#)**.**[cn](#)**.**[de](#)**.**[en](#)**.**[es](#)**.**[fr](#)**.**[id](#)**.**[it](#)**.**[ph](#)**.**[po](#)**.**[ru](#)**.**[sw](#)**

 **Forming Techniques for the Self-Reliant Potter (GTZ, 1991, 194 p.)**

 **(introduction...)**

 **Acknowledgements**

 **1. Introduction and scope**

 **2. Products and options**

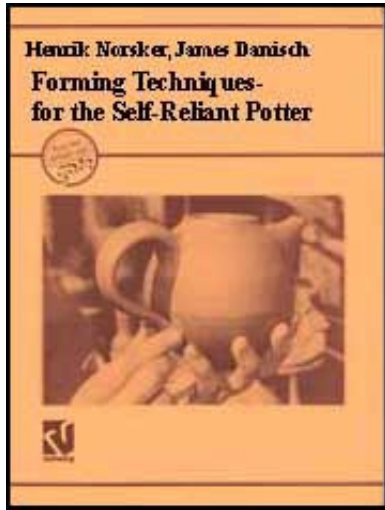

- 3. Main product lines and forming options
- 4. Plastic clay forming
- 5. Semidry foaming
- 6. Mouldmaking and Plaster of Paris
- 7. Slip casting
- 8. Finishing and quality control
- 9. Drying of ware and moulds
- 10. Work flow and factory layout
- Glossary
- Tables of weights and measures
- Table of sieve mesh sizes
- Density
- Twaddell scale
- Dry content of liquid
- Pint weights
- Bibliography

Density

Specific gravity (SG) of a material, a mixture of materials or a clay slip is expressed as how many times it is heavier than the same amount of water, i.e. how many kg per 1 liter volume or gram per cm³. Density is the weight per volume unit and in the metric system this equals specific gravity (g/cc or kg/l) but in many countries slip densities are still measured in ounces per pint.

The density of a clay slip is found by weighing 1 liter of the slip. If it weighs 1.6 kg the slip has a density of 1.6.



[Home](#) > [ar](#).[cn](#).[de](#).[en](#).[es](#).[fr](#).[id](#).[it](#).[ph](#).[po](#).[ru](#).[sw](#)

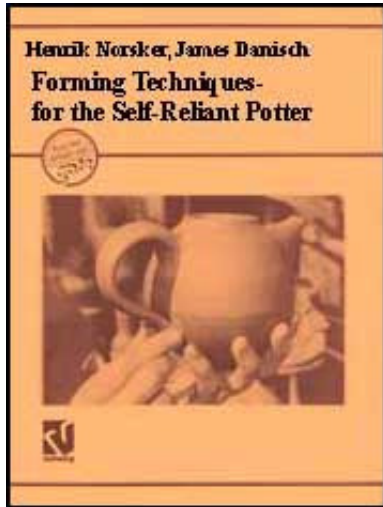

Forming Techniques for the Self-Reliant Potter (GTZ, 1991, 194 p.)

 **(introduction...)**

 **Acknowledgements**

 **1. Introduction and scope**

2. Products and options

3. Main product lines and forming options

4. Plastic clay forming

5. Semidry foaming

6. Mouldmaking and Plaster of Paris

7. Slip casting

8. Finishing and quality control







9. Drying of ware and moulds

10. Work flow and factory layout

 **Glossary**

 **Tables of weights and measures**

 **Table of sieve mesh sizes**

-  **Density**
-   **Twaddell scale**
-  **Dry content of liquid**
-  **Pint weights**
-  **Bibliography**

Twaddell scale

Clay and glaze suspensions have normally densities between 1.0 and 2.0. On hydrometers used for measuring glaze and slip densities the densities between 1.0 and 2.0 have been divided into 200 units. These units are called degrees Twaddell and the formula for calculating these is:

$$\text{°TW} = (\text{density} - 1) \times 200$$

$$\text{Density} = \text{°TW} / 200 + 1$$



[Home](#) > [ar](#).[cn](#).[de](#).[en](#).[es](#).[fr](#).[id](#).[it](#).[ph](#).[po](#).[ru](#).[sw](#)

 **Forming Techniques for the Self-Reliant Potter (GTZ, 1991, 194 p.)**

 **(*introduction...*)**

 **Acknowledgements**

 **1. Introduction and scope**

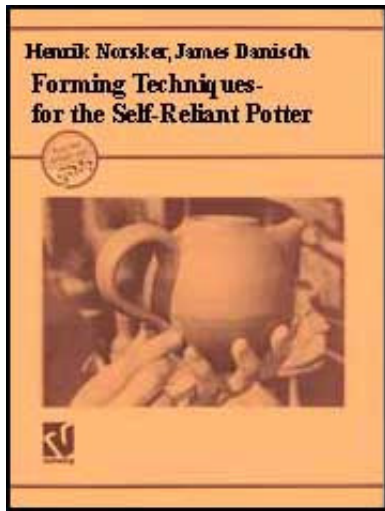

- 2. Products and options
- 3. Main product lines and forming options
- 4. Plastic clay forming
- 5. Semidry foaming
- 6. Mouldmaking and Plaster of Paris
- 7. Slip casting
- 8. Finishing and quality control
- 9. Drying of ware and moulds
- 10. Work flow and factory layout
- Glossary
- Tables of weights and measures
- Table of sieve mesh sizes
- Density
- Twaddell scale
- Dry content of liquid
- Pint weights
- Bibliography

Dry content of liquid

MAJ. BROGNIART'S FORMULA FOR DRY CONTENT OF LIQUID

If we know the specific gravity of the material in a liquid suspension and the density of the suspension we can calculate the dry weight of this material from:

Dry weight= (1q-1000) x S/S-1

W = dry weight of material in 1 liter of liquid

lq = weight in grams of 1 liter liquid

S = specific gravity of dry material

Most clays have a specific gravity of 2.5.

Example: This formula is very useful. Let us suppose we have an already-prepared clay slip and we want to add 5 % iron oxide based on dry clay content. First we measure exactly 1 liter slip and we find it weighs 1.7 kg. Now we calculate dry content of 1 liter slip using Brogniart's formula:

Dry weight = (1700-1000) x 25 / (2.5-1) = 1,166 grams

We have, say, 30 liters slip so dry clay content in 30 liters is:

30 x 1.166 kg = 35 kg. Addition of 5% iron oxide to dry clay content = 1.75 kg.



[Home](#) > [ar](#).[cn](#).[de](#).[en](#).[es](#).[fr](#).[id](#).[it](#).[ph](#).[po](#).[ru](#).[sw](#)

 **Forming Techniques for the Self-Reliant Potter (GTZ, 1991, 194 p.)**

 **(introduction...)**

 **Acknowledgements**

 **1. Introduction and scope**

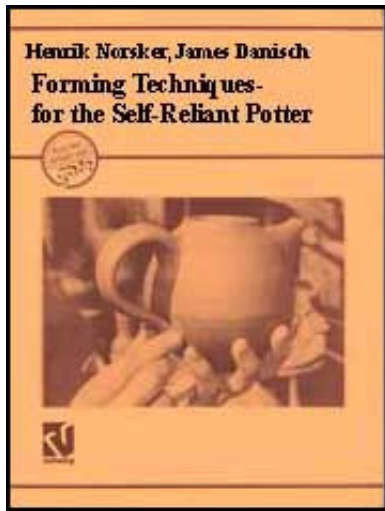

- 2. Products and options**
- 3. Main product lines and forming options**
- 4. Plastic clay forming**
- 5. Semidry foaming**
- 6. Mouldmaking and Plaster of Paris**
- 7. Slip casting**
- 8. Finishing and quality control**
- 9. Drying of ware and moulds**
- 10. Work flow and factory layout**
- Glossary**
- Tables of weights and measures**
- Table of sieve mesh sizes**
- Density**
- Twaddell scale**
- Dry content of liquid**
- Pint weights**
- Bibliography**

Pint weights

Conversion Table for Pint Weights

oz/pt UK	oz/pU	S.G.	°TW
22	18.3	1.10	20

22.8	19	1.14	28
23	19.2	1.1	30
24	20	1.20	40
25	20.8	1.25	50
25.2	21	1.26	52
26	21.7	1.30	60
26.4	22	1.32	64
27	22.5	1.35	70
27.6	23	1.38	76
28	23.3	1.40	80
28.8	24	1.44	88
29	24.2	1.45	90
30	25	1.50	100
31	25.8	1.55	110
31.2	26	1.56	112
32	26.7	1.60	120
32.4	27	1.62	124
33	27.5	1.65	130
33.6	28	1.68	136
34	28.3	1.70	140
34.8	29	1.74	148
35	29.2	1.75	150

35	29.2	1.75	150
36	30	1.80	160
37	30.8	1.85	170
37.2	31	1.86	171
38	31.6	1.89	179



[Home](#) > [ar](#).[cn](#).[de](#).[en](#).[es](#).[fr](#).[id](#).[it](#).[ph](#).[po](#).[ru](#).[sw](#)

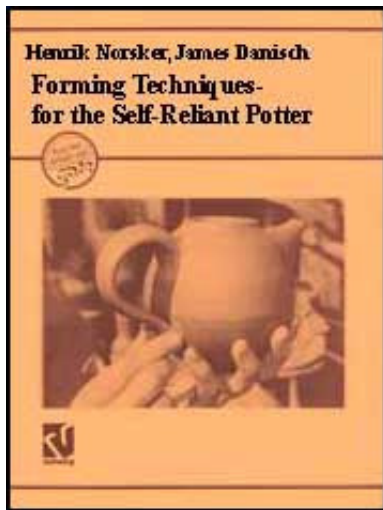









Forming Techniques for the Self-Reliant Potter (GTZ, 1991, 194 p.)

 **(introduction...)**

 **Acknowledgements**

-  **1. Introduction and scope**
- 2. Products and options**
- 3. Main product lines and forming options**
- 4. Plastic clay forming**
- 5. Semidry foaming**
- 6. Mouldmaking and Plaster of Paris**
- 7. Slip casting**
- 8. Finishing and quality control**
- 9. Drying of ware and moulds**
- 10. Work flow and factory layout**

-  **Glossary**
-  **Tables of weights and measures**
-  **Table of sieve mesh sizes**
-  **Density**
-  **Twaddell scale**
-  **Dry content of liquid**
-  **Pint weights**
-  **Bibliography**

Acknowledgements

Deutsches Zentrum fr Entwicklungstechnologien - GATE

Deutsches Zentrum fr Entwicklungstechnologien - GATE - stands for German Appropriate Technology Exchange. It was founded in 1978 as a special division of the Deutsche Gesellschaft fr Technische Zusammenarbeit (GTZ) GmbH. GATE is a centre for the dissemination and promotion of appropriate technologies for developing countries. GATE defines "Appropriate technologies" as those which are suitable and acceptable in the light of economic, social and cultural criteria. They should contribute to socio-economic development whilst ensuring optimal utilization of resources and minimal detriment to the environment. Depending on the case at hand a traditional, intermediate or highly-developed can be the "appropriate" one. GATE focusses its work on the key areas:

- Dissemination of Appropriate Technologies: Collecting, processing and disseminating information on technologies appropriate to the needs of the

developing countries: ascertaining the technological requirements of Third World countries: support in the form of personnel, material and equipment to promote the development and adaptation of technologies for developing countries.

- Research and Development : Conducting and/or promoting research and development work in appropriate technologies.

- Environmental Protection. The growing importance of ecology and environmental protection require better coordination and harmonization of projects. In order to tackle these tasks more effectively, a coordination center was set up within GATE in 1985.

GATE has entered into cooperation agreements with a number of technology centres in Third World countries.

GATE offers a free information service on appropriate technologies for all public and private development institutions in developing countries, dealing with the development, adaptation, introduction and application of technologies.

Deutsche Gesellschaft für Technische Zusammenarbeit (GTZ) GmbH

The government-owned GTZ operates in the field of Technical Cooperation. 2200 German experts are working together with partners from about 100 countries of Africa, Asia and Latin America in projects covering practically every sector of agriculture, forestry, economic development, social services and institutional and material infrastructure. - The GTZ is commissioned to do this work both by the Government of the Federal Republic of Germany and by other government or semi-government authorities.

The GTZ activities encompass:

- appraisal, technical planning, control and supervision of technical cooperation projects commissioned by the Government of the Federal Republic or by other authorities**
- providing an advisory service to other agencies also working on development projects**
- the recruitment, selection, briefing, assignment, administration of expert personnel and their welfare and technical backstopping during their period of assignment**
- provision of materials and equipment for projects, planning work, selection, purchasing and shipment to the developing countries**
- management of all financial obligations to the partner-country.**

Deutsches Zentrum fr Entwicklungstechnologien - GATE

in: Deutsche Gesellschaft fr Technische Zusammenarbeit (GTZ) GmbH

P. O. Box 5180

D-6236 Eschborn

Federal Republic of Germany

Tel.: (06196) 79-0

Telex: 41523-0 gtz d

Fax: (06196) 794820

The authors:

Henrik Norsker has been making pottery since 1970. He left his pottery workshop in Denmark in 1976 to establish a pottery school in a village in Tanzania. Since

then he has continued working in developing countries with promotion of small scale ceramics industries. Besides Tanzania he has been employed in ceramic projects in Burma, Bangladesh and Nepal.

James Danisch has been making, selling and experimenting with ceramics since 1963. He has taught college level ceramics in Scotland and California, and has conducted workshops in the US, South America and Canada. From 1984 to 1992, he has been working with small scale and rural ceramics development in Nepal. His articles on ceramics have been published in several magazines, and he has studied traditional and modern techniques in Europe, Nepal, India, Thailand, Burma, South America and Mexico.

Books by the same author include:

**The Self-Reliant Potter: Refractories and Kilns
GATE / Vieweg, 1987**

**Clay Materials - for the Self-Reliant Potter
GATE / Vieweg, 1990**

Die Deutsche Bibliothek - CIP-Einheitsaufnahme

Norsker, Henrik:

**Forming techniques - for the self-reliant potter: a publication of Deutsches Zentrum fr Entwicklungstechnologien - GATE in: Deutsche Gesellschaft fr Technische Zusammenarbeit (GTZ) GmbH / Henrik Norsker; James Danisch.
Braunschweig: Vieweg, 1991
ISBN 3-528-02061-X**

NE: Danisch, James:

All rights reserved.

**© Deutsche Gesellschaft für Technische Zusammenarbeit (GTZ) GmbH, Eschborn
1991.**

**Published by Friedr. Vieweg & Sohn Verlagsgesellschaft mbH, Braunschweig
Printed in the Federal Republic of Germany by Lengericher Handelsdruckerei,
Lengerich**

ISBN 3-528-02061-X



[Home](#) > [ar](#).[cn](#).[de](#).[en](#).[es](#).[fr](#).[id](#).[it](#).[ph](#).[po](#).[ru](#).[sw](#)

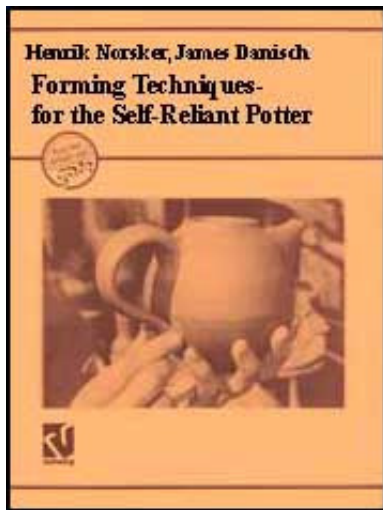

 **Forming Techniques for the Self-Reliant Potter (GTZ, 1991,
194 p.)**

 **(introduction...)**

 **Acknowledgements**

 **1. Introduction and scope**









2. Products and options

3. Main product lines and forming options

4. Plastic clay forming

5. Semidry foaming

6. Mouldmaking and Plaster of Paris

- 7. Slip casting**
- 8. Finishing and quality control**
- 9. Drying of ware and moulds**
- 10. Work flow and factory layout**
-  **Glossary**
-  **Tables of weights and measures**
-  **Table of sieve mesh sizes**
-  **Density**
-  **Twaddell scale**
-  **Dry content of liquid**
-  **Pint weights**
-  **Bibliography**

Bibliography

Hugh Allen. The Kenya Ceramic Jiko - A Stovemaker's Manual, London 1990.

H.N. Bose. Modern Pottery Manufacture, Bhagalpur 1947.

Barry Brickell. A New Zealand Potter's Dictionary, Auckland 1985.

Michael Cardew. Pioneer Pottery, New York 1971.

Charles Chaney and Stanley Skee. Plaster Mold and Model Making, New York 1981.

Kenneth Clark. The Potter's Manual, London 1983.

Harry Davis. The Potter's Alternative, Australia 1987.

E. Eipeltauer. The Preparation of Raw Gypsum and Its Conversion into Various Hemihydrates National Research

Council of Canada, Technical Translation 899, Ottawa 1960.

R.W. Ford. Ceramics Drying, Oxford 1986.
Robert Fournier. illustrated Dictionary of Practical Pottery, New York 1975.
Donald E. Frith. Mold Making for Ceramics, Radnor 1985.
Frank Hamer. The Potter's Dictionary of Materials and Techniques, New York 1975.
David Hamilton. The Thames and Hudson Manual of Architectural Ceramics, London 1978.
David Hamilton. The Thames and Hudson Manual of Pottery and Ceramics, London 1974.
Josef Hoffmann. Technologie der Feinkeramik, Leipzig 1987.
John B. Kenny. The Complete Book of Pottery Making, Radnor 1974.
Glenn C. Nelson. Ceramics, New York 1960.
Henrik Norsker. The Self-Reliant Potter: Refractories and Kilns, Wiesbaden 1987.
Henrik Norsker. Clay Materials - for The Self-Reliant Potter, Wiesbaden 1990.
Ernest Albert. Sandeman Notes on the Manufacture of Earthenware, London 1921.
Alfred B. Searle. The Clayworker's Hand-Book, London 1929.
Felix Singer & Sonja S. Singer. Industrial Ceramics, London 1979.

CERAMICS JOURNALS

Ceramics Monthly, Box 12448, Columbus, Ohio, U.S.A. Interceram, Verlag Schmid, P.O. Box 6609, 7800 Freiburg, Germany

Tile & Brick International, Verlag Schmid New Zealand Potter, P.O. Box 12-162, Wellington, New Zealand.

Ceramic Review, 21 Carnaby Street, London, U.K. Studio Potter, Box 70, Goffstown, N.H., U.S.A.



[Home](#) > [ar](#).[cn](#).[de](#).[en](#).[es](#).[fr](#).[id](#).[it](#).[ph](#).[po](#).[ru](#).[sw](#)

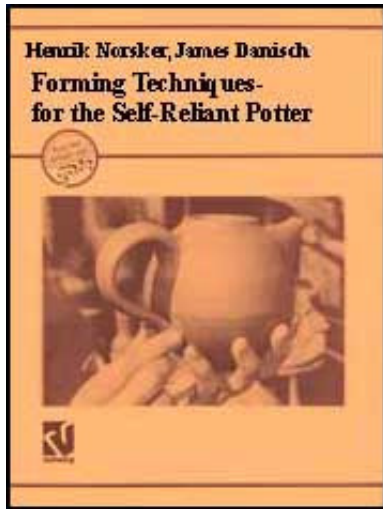

Forming Techniques for the Self-Reliant Potter (GTZ, 1991, 194 p.)

 **(introduction...)**

 **Acknowledgements**

  **1. Introduction and scope**

 **2. Products and options**

 **3. Main product lines and forming options**

 **4. Plastic clay forming**

 **5. Semidry foaming**

 **6. Mouldmaking and Plaster of Paris**

 **7. Slip casting**

 **8. Finishing and quality control**

 **9. Drying of ware and moulds**

 **10. Work flow and factory layout**

 **Glossary**

 **Tables of weights and measures**

 **Table of sieve mesh sizes**

 **Density**

 **Twaddell scale**

 **Dry content of liquid**

 **Pint weights**
 **Bibliography**

1. Introduction and scope

This book is intended as a practical guide for cottage and small-scale ceramics production, primarily in developing countries, using locally-based technology and available raw materials, where machinery usually needs to be made locally in order to be practical. However, we think it may also be of use in developed countries, as many "studio" potters are shifting from one-person production to a group approach, creating interest in the revival of jiggers, handmade tiles, etc.

It is assumed that the reader is already producing ceramics, or is looking into the possibility of starting ceramics as a business.

Much of the material is based on the direct experience of the authors in developing countries, in particular Nepal, Burma, Tanzania, India, Bangladesh and Thailand, where we both have been involved for several years in ceramics development projects, and have looked closely at the various problems and solutions, past and present. Information about forming systems and machinery designs is for the most part not available in books. Nor has there been much documentation of successful systems that small factories use in developing countries. We hope that this book will help to fill the gap.



[Home](#) > [ar](#).[cn](#).[de](#).[en](#).[es](#).[fr](#).[id](#).[it](#).[ph](#).[po](#).[ru](#).[sw](#)

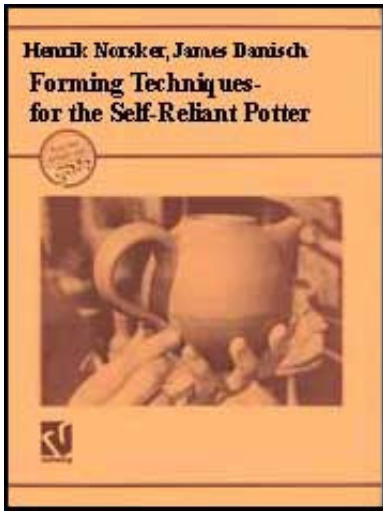

Forming Techniques for the Self-Reliant Potter (GTZ, 1991, 194 p.)

2. Products and options

 **(introduction...)**

 **2.1. Market sectors and forming considerations**

 **2.2. Investment decisions**

 **2.3. Choosing your product line**

Forming Techniques for the Self-Reliant Potter (GTZ, 1991, 194 p.)

2. Products and options

This chapter presents a summary of various articles that the small producer can make.

2.1. Market sectors and forming considerations

2.1.1. THE EXPORT MARKET

2.1.2. THE LOCAL MARKET

In developing countries, there are two main market sectors: the export market and the local market. They require different kinds of products in most cases.

2.1.1. The export market

CAUTION!

Exportation from many countries is very difficult, due to customs regulations. Before dreaming about huge profits from exports, it is important to find out about rules and costs, and to be sure that you have a reliable buyer.

profitability

Because of high labor costs in industrialized countries, it has become profitable in developing countries to produce ceramics for export. There is now a very large market for floor and wall tiles, tableware, and decorative or novelty items, which are very competitive in the world market in spite of high shipping costs. Any product which is labor-intensive (for example, requiring hand-painting or large amounts of handling) has a good scope for export, because it takes advantage of low labor costs.

success in Thailand

For example, factories in northern Thailand producing cheap novelty items for export have orders for the coming two years, and are finding it difficult to increase their capacity enough to supply the demand. Many of these factories are small-scale and use simple forming techniques, such as slip casting or jiggering. The products are often designed by the customer, and most of these products do not require special finishing and quality control. For example, 1,000,000 "Elvis Presley" figurines were ordered from Thailand for a U.S. promotion campaign. They were produced by slip casting with something like a 500% profit margin.

traditional products

Another market sector is “ethnic” arts, for example ceramic dolls dressed in the traditional costumes of their country. Although this is not a large volume market, it can be profitable for a small producer. In Nepal, one small pottery makes most of its profit sending hand-painted dolls to Japan. Similarly, decorative pottery (like candlestands, ashtrays, etc.) that is done with traditional shapes and decoration has its own market for export.

labor-intensive products

Anything handmade has an export market for example, special designs of handmade tile can fetch a high price in the West. Similarly, there are some businesses which import high-quality tableware from Europe, hand-paint it with overglaze, and send it back to the country of origin for a high profit.

joint venture factories

Another export sector which is growing rapidly is joint-venture floor and wall tile production. This is usually done on a large scale, using high capital-investment foreign machinery, and as such is outside the scope of this book.

punctual delivery

Products for export need to be selected very carefully, and problems of quality control and punctual delivery must be thought about. Western buyers expect to get their orders on time, and will not accept excuses for late delivery. This means that the producer must have a realistic idea about whether he has the capacity to produce an order, and he has to make an accurate estimate of the time it will take. It may be tempting to accept a big order, but if it requires ten times your normal

capacity, it would be foolish to do so.

Be sure of your ability to produce

Traditional designs already being made in your country, but adjusted for export, are easier to control for quality, because they are familiar to the workers. Orders for designs that have not been tried before should never be accepted- the rule is, do not try to fool the customer, because it will only backfire on you in the end.

2.1.2. The local market

The local market usually already has a demand for glazed ceramics, except in remote areas where they may still be unknown.

However, needs for new products are changing fast, in line with modern times. It is easy to see that in every country the introduction of plastic and aluminum has revolutionized the way people live. In the same way, a ceramics producer who keeps his eyes open to how things are changing will find a good market for new products.

example: Nepal

Nepal had no glazed ceramics production until very recently. However, the market had developed based on household ware imported from India, which is mostly low-quality- white stoneware. Because there are no suitable local raw materials for stoneware, Ceramics Promotion Project developed low temperature glazed red clay technology. Now, small producers are finding a good market. The new industry has found customers ranging from tourist hotels to local housewives.

Because the products are low-cost, they can be sold even though the quality still has to be improved. This is a good example of introducing a new variation into an existing market.

local market possibilities

There are at least three main possibilities for the local market:

Import substitution: where feasible, local production of goods that are usually imported.

Improving existing products.

Introducing new products.

Import substitution is only feasible if locally made products can be made more cheaply than the imports, or if import duties keep the cost high. Wherever there is a tourist trade, obvious customers are hotels and restaurants. Hotels often like to have locally-made ceramics as decoration and advertisement, such as ashtrays and flower vases. A small producer who can capture the orders of even one large hotel has a guaranteed business, as smart hotels encourage customers to take ashtrays home as souvenirs - it is good advertising for them.

Where there is already local production, a clever producer may find ways to produce the same quality at a lower cost, or to improve the product in a way (better glaze, more attractive decoration) that attracts customers.

New products are often risky for the producer, since the market is unknown.

However, part of being a successful producer is being able to see a need that nobody else has seen. For example, everybody needs containers for drinking water, and replacing traditional jars with new designs fitted with a tap appeals to customers wanting to be modern. Likewise, there is a lot of money in rural sanitation projects, and these projects generally are interested in promoting local production efforts.

hotels and restaurants

Within the local market, there are also several different sectors. Mainly, there is the profitable hotel and restaurant trade, which is low in volume but has a high profit margin. In the beginning, producers will try to capture that until the market is saturated. In the long run, most producers will be supported by the local market for cheap household items, which is large in volume but has a much lower profit margin.

2.2. Investment decisions

Because risk is high in starting any new industry, it usually is best to start small and expand gradually.

A profitable ceramics business can be run in the corner of a room, and requires only a table, clay, glaze and a small electric kiln. The total investment may be less than US\$100, and the products would be small, handmade decorative and novelty items (like animals, dolls, etc.).

At the other extreme, perhaps the most costly "small"-scale investment would be a sewage pipe factory, where equipment and kilns could total US\$ 750,000. This is

also a profitable business, but requires large volume production in order to pay back the machinery.

questions to ask

Before deciding to invest in ceramics, you should answer the following questions, which are standard questions for any new business:

1. Is there a market for the product? If so, what is the size of the market? If the product is being made locally, how much of the market sector can you expect to capture? If the product is imported, can you equal the quality or make it significantly cheaper?

2. Do you know enough about the business? Can you get machinery? Technical assistance?

3. Is there enough skilled labor available?

4. Is the amount of investment required too much? Are you able to get a loan? If so, what is the payback period - and are you able to get the business running smoothly in time?

2.3. Choosing your product line

2.3.1. MACHINERY CONSIDERATIONS

For new producers of ceramics, there is one main rule to follow: KEEP IT SIMPLE. Choose only one product line, and make that successful before trying to diversify.

Avoid trying too many kinds of forming at once (don't start jiggering, slip casting and semidry pressing at the same time). As with most businesses, if there is one successful unit, it will soon be copied. If the market sector is large enough, this is a safe way to go. On the other hand, the really successful producers are usually the ones who start a new business before anyone else does. There is more risk in this, but by definition being a businessman means being willing to take greater risks than most people.

expanding your product line

For existing producers wanting to expand their product line, it is important to think about the total system. In other words, if you are already producing cups by jigger, it is easy to make new moulds for producing soup bowls, with little additional investment. On the other hand, this may mean purchasing additional jigger machines, getting additional workers, and expanding kiln capacity. If you want to produce glazed tiles by semidry pressing, this requires a greater investment, since the clay processing, production line and even the kilns will have to be different.

2.3.1. MACHINERY CONSIDERATIONS

Depending on the size of your industry, there are several options for machinery.

Ready-made machinery

Most countries have suppliers for ceramics machinery that is appropriate for local conditions. In big countries such as India, there are many suppliers producing

different qualities. Try to get the right machine for the work to be done. Before choosing an expensive machine, you should get as much advice as possible regarding what capacity and quality you need. For example, nondeairing pug mills can be very cheap, and are often satisfactory if you do not run the machine all the time and do not mind doing periodic maintenance and repairs (they usually are made from low quality steel and have cheap bearings). However, if you expect to be running your pug mill at full capacity for 2 shifts per day, it probably is a cheaper long-term investment to get a more expensive, better quality pug mill.

Talk to other producers using machinery to get a better idea. Never believe a machinery salesman until you have talked to his other customers.

Used machinery

It is often possible to buy already-used machinery at low cost from factories that are upgrading their machinery or that have gone out of business. Many small producers have started out this way.

If you are starting a small-scale industry which requires heavier machinery, it is often possible to get used machines from Europe at a low cost. Their condition is generally certified, and many are almost new. European factories have to upgrade their equipment quite frequently in order to compete, and many have gone out of business because of competition from imports! So there are some good bargains available. Catalogs and price lists are available from advertisements in "Interceram" and "Tile & Brick International" magazines (see Appendix).

Making your own machinery

It is not recommended to make your own machinery unless you have another machine to copy, or a lot of money to spend. Even simple machines like hand extruders need some attention to detail. We have made a lot of prototype machinery in Nepal (potter's wheels, pug mills, vibrating screens, etc., many of which are shown in this book), and have rarely had a successful prototype the first time. On the other hand, an inventive mechanic could probably follow plans and have a good chance of success - but he will probably have to try the machine out and make some changes before it works correctly.

Make it strong

In any case, it is most important to get the details right: for example, use good bearings if available, and always make things stronger than you think is necessary. Even simple machines like hand extruders can have problems: the metal piece that holds the die in place can break if the steel is too thin, the handle can bend if too thin, etc.



[Home](#) > [ar](#).[cn](#).[de](#).[en](#).[es](#).[fr](#).[id](#).[it](#).[ph](#).[po](#).[ru](#).[sw](#)

 **Forming Techniques for the Self-Reliant Potter (GTZ, 1991, 194 p.)**

  **3. Main product lines and forming options**

 **(*introduction...*)**

 **3.1. Household ware, crockery, decorative and novelty items**

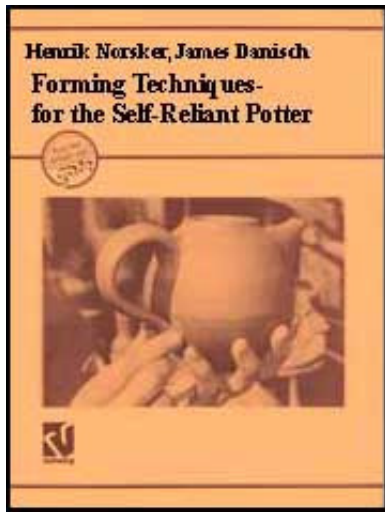

- 📄 **3.2. Tiles**
- 📄 **3.3. Refractories and miscellaneous industry support products**
- 📄 **3.4. Pipe**
- 📄 **3.5. Electrical products**
- 📄 **3.6. Miscellaneous products**

Forming Techniques for the Self-Reliant Potter (GTZ, 1991, 194 p.)

3. Main product lines and forming options

This chapter focuses on a catalog of products, and what is required for forming them. The specific forming systems are discussed in detail in later chapters.

3.1. Household ware, crockery, decorative and novelty items

3.1.1. HAND METHODS

3.1.2. POTTER'S WHEEL

3.1.3. PRESS MOULD

3.1.4. SLIP CASTING

3.1.5. JIGGER

3.1.6. OTHER FORMING METHODS

Household ware and crockery mean approximately the same thing. These are

products such as cups, plates, storage jars, teapots, bowls, lamp bases, etc. Decorative and novelty items are such things as flower vases, figurines, wall hangings and souvenirs. These products are capable of being produced in one and the same factory, as long as the forming methods are the same.

Household items are usually the easiest to produce without introducing complicated forming techniques. In most countries, there is already a tradition of ceramic household items, although they may not be glazed. From the point of view of forming, this does not present a major change in technology. The following is a list of forming methods, and some typical products that can be successfully made.

3.1.1. HAND METHODS

Hand methods refer to using slabs, coils and pieces of clay to assemble various forms, using only the hands and simple tools.

novelty items

There are few highly marketable items that can be made by these methods, but there are some successful microbusinesses that produce very small novelty items by hand, such as animals, flowers, etc. The process for animals is to make the body from a piece of clay, and then to add feet, ears, tail, etc., all by hand. The main point is to use fine detail, which makes the product attractive to the customer. These items are made at very low cost (mainly labor) and have a high profit margin. They are easy to export, being small.

3.1.2. POTTER'S WHEEL

The potter's wheel still remains a very important production tool. It can be used for unique items, or for series of identical products. It depends on having highly-skilled "throwers" to produce quality items. Although handmade items are no longer so attractive in the local market, industrialized countries have a big demand for handmade products, and there is growing local prestige market and a tourist market for handcrafted ceramics.

Typical products are cups, containers, bowls, candlestands, lamp bases, flowerpots and novelties, as well as hundreds of other household and decorative items.

3.1.3. PRESS MOULD

Press moulding is the process of forming plastic clay by forcing it by hand into plaster, cement or wooden moulds. It is used to produce items with detailed relief decoration, or large forms that cannot be made any other way. Like all moulded products, it has the advantage of producing large numbers of identical items with low investment. In pressmoulding, several shapes are often pressed separately and then assembled into complicated sculptural forms.

Typical products are tiles with relief designs, sculpture (animals, gods), large flowerpots with relief designs, water containers, pipes, etc.

3.1.4. SLIP CASTING

Slip casting is the process of pouring liquid clay slip into plaster of parts moulds. It has the advantage of producing large quantities of identical forms, and is

especially good for products that are not round (square pots, irregular shapes, etc.).

Typical products are flower vases, lamp bases, relief design tableware, figurines, etc.

3.1.5. JIGGER

This is a machine that is really a semiautomatic potter's wheel, which uses plaster moulds to produce identical items. It is most useful for hollow ware, which means open forms (cups, bowls, plates) that have a big mouth, and is best for round shapes. This machine is frequently called a "jigger-jolly", but for simplicity's, in this book it will always be called "jigger".

The jigger is the standard method for making dinner plates, soup bowls, teacups, and similar forms.

3.1.6. OTHER FOAMING METHODS

Other methods usually are combinations of the above. For example, cups produced by jigger may have handles made by slip casting.

3.2. Tiles

3.2.1. SCOPE FOR THE SMALL PRODUCER

3.2.2. HANDMADE TILES

3.2.3. PLASTIC-PRESSED TILES

3.2.4. SEMIDRY PRESSED TILES

3.2.5. GLAZED AND UNGLAZED TILE CONSIDERATIONS

Tiles refer to flat plates of clay that can be set together to cover walls and floors, or specially shaped tiles for roofing. There are many kinds of tiles, glazed and unglazed, with relief designs and plain. Tiles are popular all over the world for use in and on buildings.

3.2.1. SCOPE FOR THE SMALL PRODUCER

Nowadays, most standard glazed tiles are produced by very large-scale, automated factories, which are able to make their profit through large volume and low amount of handling. Because the industry is so large and aggressive, it is impossible for the small producer to compete directly in terms of quality and cost.

competing with big industries

However, there is also a good market for special decorative tiles, which may have relief designs or painted glaze designs. These are in great demand in industrialized countries, where they have a high profit margin. Another product is unglazed red clay tiles, which are very popular for floor and wall covering. These are best for the local market, since they normally are not transported for long distances (which increases their cost too much). They have a low profit margin, but like the brick industry, they are profitable because of large volume production. Similarly, unglazed roofing tiles are also marketed in the local area.

3.2.2. HANDMADE TILES

Handmade tiles are a good business in many countries. There are two types:

- unglazed red clay tiles, which can range from 30 cm x 30 cm x 3 cm for floors, down to about 10 cm x 10 cm x 1.5 cm.**
- glazed relief design tiles, which usually range from 15 cm x 15 cm x 2 cm down to small sizes.**

These tiles are made in frames or plaster of parts moulds, and require only a small investment in machinery.

3.2.3. PLASTIC-PRESSED TILES

These tiles are usually plain-surfaced, but are more uniform in size and finishing compared to handmade tiles. They are made with a press machine which uses metal dies, and the machine may be hand-operated or motorized. They use clay in the plastic state. They are relatively easy to produce, but require quite a large amount of transporting and hand finishing.

The process is most suitable for unglazed floor and wall tiles, but can also be used for glazed tiles and is the normal system for making roofing tiles.

3.2.4. SEMIDRY PRESSED TILES

These are tiles made with clay powder having a low moisture content of up to 10%, or using leather-hard clay (a variation of plastic pressing). They are usually plain-surfaced, and are faster to produce compared to plastic-pressed tiles. However, they require more control in clay preparation, and may need more

investment in machinery. They use the same type of press machine as above (with higher pressure), but have the advantage of being almost dry after they are pressed. This reduces drying problems and minimizes the amount of handling and transport required.

The process is commonly used for glazed and unglazed wall and floor tiles.

3.2.5. GLAZED AND UNGLAZED TILE CONSIDERATIONS

As mentioned above, the small producer is not advised to compete directly with standard glazed tile manufacturers. It is much easier to enter into unglazed tile production, which will give better results with fewer problems. There is always a good scope for unglazed floor tile, facing brick, etc. There are many successful businesses in Thailand making unglazed relief tile for the outside of buildings. Likewise, there is good scope for unglazed roofing tile - in countries like Nepal and Burma, there is not enough good quality roofing tile to meet the demand.

relief tile

Glazed relief tile has a good scope for the small producer, and requires only investment in a few plaster of parts moulds. Even small orders can be profitable, since there can be a good profit margin added. A producer who is already making household items can consider making relief tile, without having to change any of his equipment.

3.3. Refractories and miscellaneous industry support products

3.3.1. FORMING METHODS

3.3.2. KILN FURNITURE

Refractories are all of the products that are necessary for firing ceramics. "Refractory" means "capable of withstanding high temperature", and the refractories industry produces firebricks, insulating bricks, kiln shelves (setter slabs), etc. Additionally, ceramics factories need special items like porcelain balls and lining bricks for ball mills, and porcelain jars for pot mills. Where a substantial ceramics industry already exists, there is often enough business to support a refractories factory. If you have a fairly large ceramics industry and are purchasing expensive imported refractories, it is worth thinking about producing certain items yourself as a sideline, and possibly selling them to nearby factories as well.

Miscellaneous industry support products are pot mill jars, balls and brick linings for ball mills, mortars and pestles, chemical storage containers, etc.

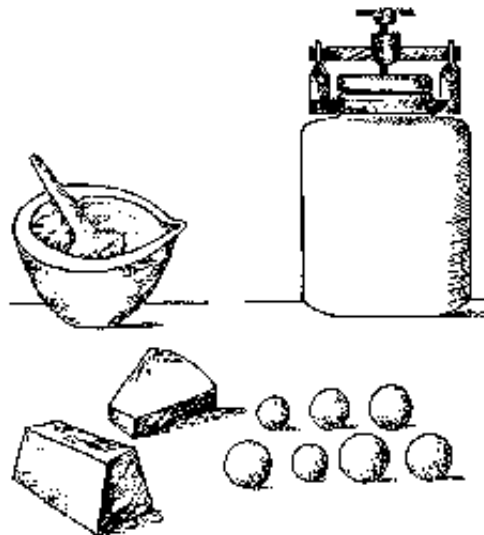

FIGURE 3.3-A Examples of ceramic products: a mortar and pestle, a jar mill and

lining bricks and pebbles for ball mills.

3.3.1. FORMING METHODS

Refractories can be made by simple methods, including hand-extrusion, semidry pressing, hand-moulding and casting.

3.3.2. KILN FURNITURE

Kiln furniture refers to setter slabs (kiln shelves), saggars and various stands, specialized setters for plates, tiles, etc. These are generally formed as follows:

- Extrusion: A hand extruder can be used for producing stands to support kiln shelves.**
- Semidry pressing: Kiln shelves are made with semidry (about 10 % water) clay. They cannot be made in standard screw press machines, which do not have sufficient pressure. The classical and still best way to make them is in a metal frame, handbeating the clay to make it uniform and dense. Other specialized shapes, such as "thimbles" for tile setting, are made in presses. Firebricks are made either by pressing in screw presses, or, for better quality, beating clay by hand into metal moulds.**
- Hand-moulding: Setters for plates can be moulded by hand on the potter's wheel. Porcelain balls for ball mills are often made simply by rolling clay in the hands. Saggars are usually made by wrapping clay slabs around wooden forms and beating them into shape. Insulating bricks are usually**

“slop-moulded” in wooden forms (as is done everywhere for common bricks), and are sometimes pressed in a screw press when they have stiffened to give them a more uniform size.

- Slip casting: Ball mill jars are sometimes cast, or simply thrown on the potter’s wheel (which makes a stronger jar because it aligns the clay particles better). Setter slabs (shelves) are also sometimes cast.

For more information, see Refractories and Kilns, in this series of books.

3.4. Pipe

3.4.1. KINDS OF CERAMIC PIPE

Ceramic pipe can be glazed or unglazed, depending on its use and required strength. There are several uses for pipe:

- Simple, low-pressure water pipe: This is usually unglazed, is used only for short distances, and can be made on the potter’s wheel or in a two-piece mould. Another system involves wrapping plastic clay slabs around a wooden form. It requires almost no investment, and is suitable for traditional (no kiln) firing systems.

- Perforated drainage pipe: This is unglazed, has holes along one side, and is used for collecting excess water under roads, or in soak pits (leach fields) for septic tanks. It can be made on the potter’s wheel, extruded, or in a two-piece mould. It

has the same requirements as water pipe.

- Chimney pipe for stoves: This is unglazed, and also is made on the potter's wheel or in a two-piece mould. It is the same as making water pipe.**
- Sewage pipe: This is glazed and fired to higher temperatures, and is best made in quantity by an extruder machine. Sewage pipe is also suitable for carrying irrigation water, and is capable of withstanding relatively high pressure. It is suitable for small-scale industry, and requires high capital investment.**
- Semicircular roofing tiles: These are thrown as small pipe and later cut in half. This is the usual way to make village roofing tiles, which is slowly disappearing because the roof is very heavy and requires too much wood for construction.**

3.5. Electrical products

3.5.1. SEMIDRY PRESSING

Electrical products suitable for small producers are low-tension insulators and fuse holders. These are relatively easy to produce and do not require too much quality control. These products are formed by:

3.5.1. SEMIDRY PRESSING

- Fuse holders are made in small toggle presses or screw presses. These hand-operated presses require low investment. They often are made as a cottage industry, where there is one central clay supplier and firing center. The fuse holders are pressed in homes, usually by one person using one toggle press. Each**

morning, these workers come to the center with their finished goods and collect enough clay for the day's production. They are paid by the piece.

- Low-tension insulators are formed in presses. They can be made according to the same system as fuse holders. They sometimes are extruded and then shaped on a potter's wheel.

3.6. Miscellaneous products

3.6.1. WATER FILTERS

3.6.2. AGRICULTURAL ITEMS

3.6.3. SANITARY WARE

3.6.1. WATER FILTERS

With more and more education on hygiene and the need for clean drinking water, water filter units are becoming popular. The water containers can be made cheaply, on the potter's wheel or by using plaster moulds and hand-pressing. The filter candles are more complicated, because they require a special clay body, and have to be fired to an accurate temperature. They can be formed by casting, or by pressing in a metal mould.

3.6.2. AGRICULTURAL ITEMS

Agricultural items include animal feeding containers and irrigation pipes (as mentioned above). These are usually made by hand, on the potter's wheel, or by using simple moulds.

3.6.3. SANITARY WARE

Although the small producer should not expect to make high quality vitrified china sanitary ware, there is good scope for simple products intended for the low-cost market. These can be formed with a low investment, but, in the case of toilet pans, require a large kiln Products include:

- simple toilet pans, footrests and traps, using red or white clay, which are formed by hand in press moulds;**
- large unglazed red clay rings used for lining pit toilets, which are formed in hand press moulds.**



[Home](#) > [ar](#).[cn](#).[de](#).[en](#).[es](#).[fr](#).[id](#).[it](#).[ph](#).[po](#).[ru](#).[sw](#)

 **Forming Techniques for the Self-Reliant Potter (GTZ, 1991, 194 p.)**

  **4. Plastic clay forming**

 **4.1. Plastic clay preparation**

 **4.2. Hand-forming**

 **4.3. Potter's wheel**

 **4.4. Joining techniques**

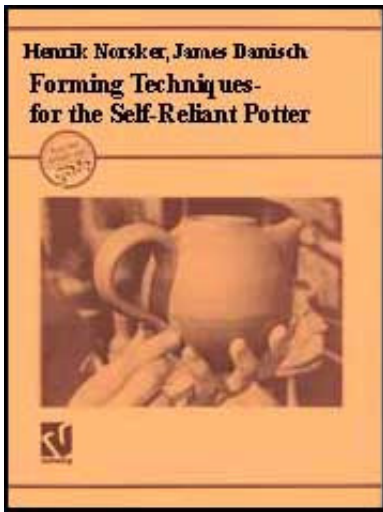

4.5. Jigger

4.6. Extrusion

Forming Techniques for the Self-Reliant Potter (GTZ, 1991, 194 p.)

4. Plastic clay forming

4.1. Plastic clay preparation

4.1.1. DRY PROCESS

4.1.2. WET PROCESS

This is a brief review of plastic clay preparation. A complete explanation of clay mining and processing is found in "Clay Materials - for The Self-Reliant Potter", also in this series.

definition of plastic clay

Plastic clay means clay that has about 30 % water content. It can be manipulated into any shape, and is the standard consistency for most forming processes.

Nowadays, the word “plastic” is understood to mean the range of modern materials used for familiar products such as plastic bags, buckets, etc. Originally, “plastic” meant a material that did not have any form of its own, but could easily be formed into any shape.

There are two methods of preparing plastic clay, depending on the kind of product and quality of the raw materials. These are:

4.1.1. DRY PROCESS

This process is used mainly for red clay products, which do not require extremely fine clay. It is cheaper to set up than the wet process (described below). It also is satisfactory for white clay products, where already washed raw materials can be obtained. The work flow is shown in Fig. 4.1.1-A.

NOTES ON PLASTIC CLAY:

- For most traditional pottery, the (dry) clay lumps are simply soaked with water, allowed to set, then kneaded by hand and foot. Large lumps, rocks and roots are removed during the hand kneading (wedging) process. Only for more refined glazed products may screening be necessary.**
- Many industries making whiteware do not do their own clay processing. If washed and ground raw materials can be easily obtained from a supplier, this is usually cheaper than doing your own clay processing.**

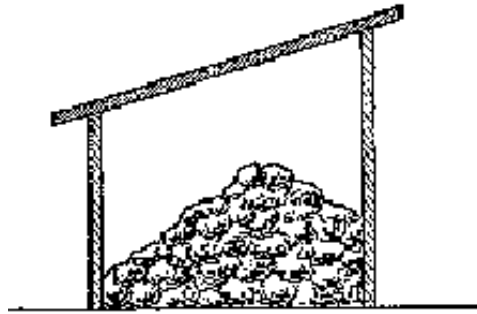

FIGURE 4.1.1-A Work flow for dry process clay making (A)

A) Dry clay storage. Store enough dry clay to last throughout the rainy season.



FIGURE 4.1.1-A Work flow for dry process clay making (B)

B) Drying in the sun directly on the ground, or, better still, on raised brick platforms which can be covered by plastic in case of rain.

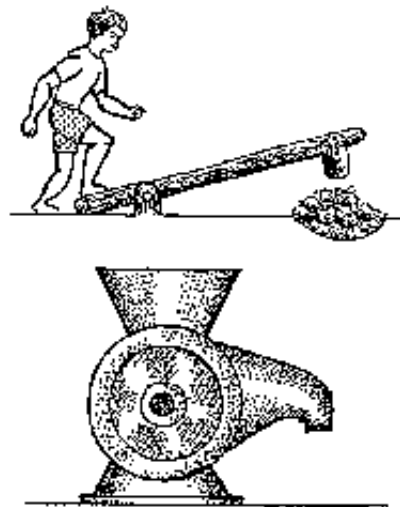

FIGURE 4.1.1-A Work flow for dry process clay making (C)

C) Making clay powder by hand, with a rice huller or a hammer mill.

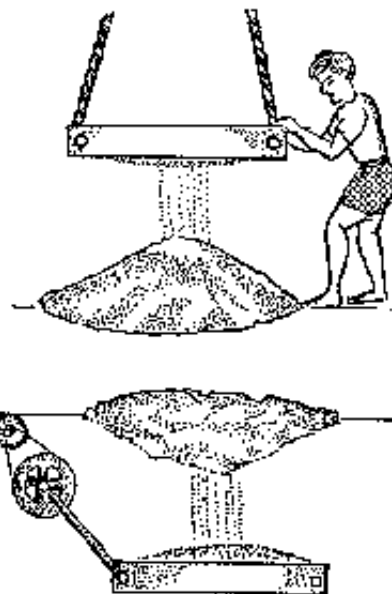

FIGURE 4.1.1-A Work flow for dry process clay making (D)

D) Screening to remove coarse particles (16-100 mesh depending on required fineness) by hand sieve or motorized vibrating screen.

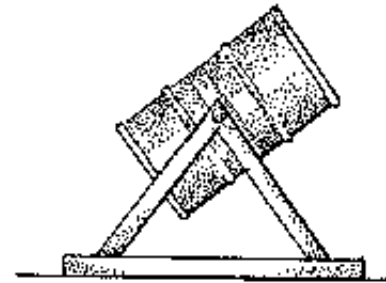

FIGURE 4.1.1-A Work flow for dry process clay making (E)

E) Mixing with other materials (clays, feldspar, talc, quartz) manually or in a drum mixer.



FIGURE 4.1.1-A Work flow for dry process clay making (F)

F) Soaking is necessary to allow all clay particles to absorb water (for a minimum of 24 hours).

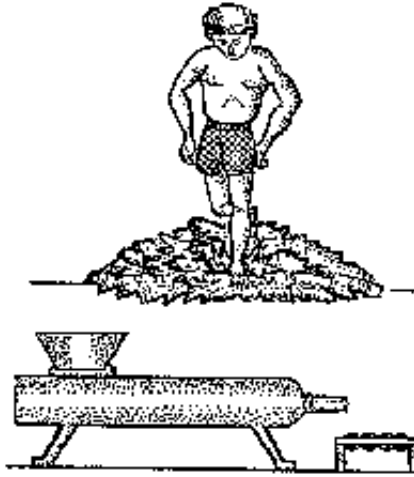

FIGURE 4.1.1-A Work flow for dry process clay making (G)

G) Kneading can be done manually (or with the feet) or in a pug mill.

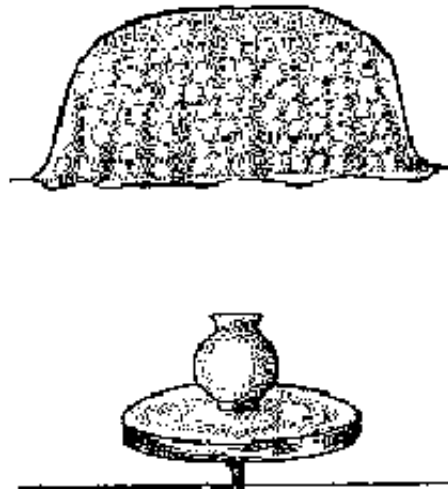

FIGURE 4.1.1-A Work flow for dry process clay making (H; I)

H) Maturing under a plastic cover for a minimum of 3 days, or, better still , several weeks.

I) The plastic clay will need a little kneading before being used for forming.

4.1.2. WET PROCESS

The wet process is used to make finer clay, and is necessary for white bodies where it is necessary to remove iron particles. It is easy and cheap when done by hand for cottage industries, but is complicated and expensive when it is done on an industrial scale.

To do it BY HAND requires only two tanks of brick lined with cement. The work flow is shown in Fig. 4.1.2-B.

Clay preparation BY MACHINE (Fig. 4.1.2-C) follows the same principle as by hand. The machines make the initial costs much higher, but the two methods could be combined. The filter press is the most costly part and it could be replaced by dewatering trays.

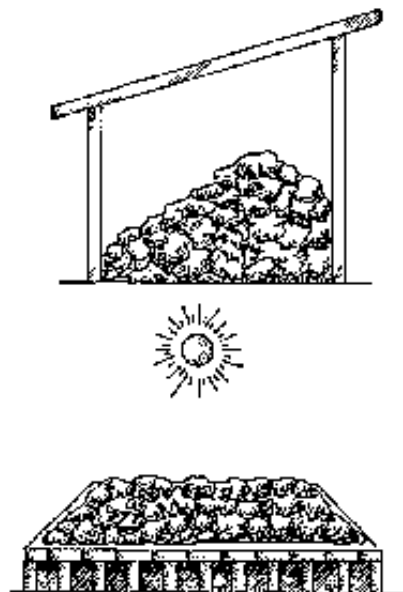

FIGURE 4.1.2-B Work flow of manual wet clay process.(A; B)

A) Clay storage shed.

B) Clay that is completely dried is easier to soak , but drying is not necessary.

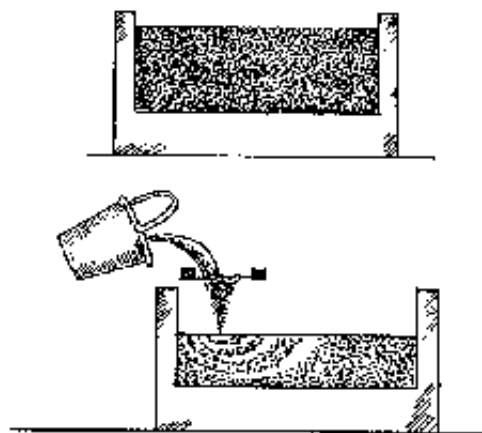

FIGURE 4.1.2-B Work flow of manual wet clay process.(C; D)

C) Soak clay and water in a tank , until it makes a fluid slip. NEVER STIR CLAY BEFORE IT IS COMPLETELY SOAKED.

D) The clay slip is screened and transferred to another tank.

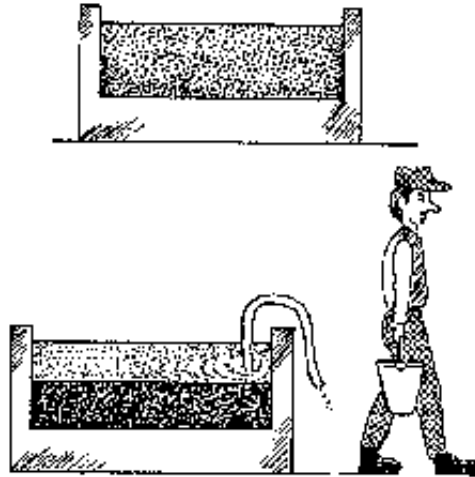

FIGURE 4.1.2-B Work flow of manual wet clay process.(E; F)

E) The clay is left in the settling tank.

F) When the clay has settled, clear water is siphoned off and the thick clay slip is transferred to a dewatering tray.

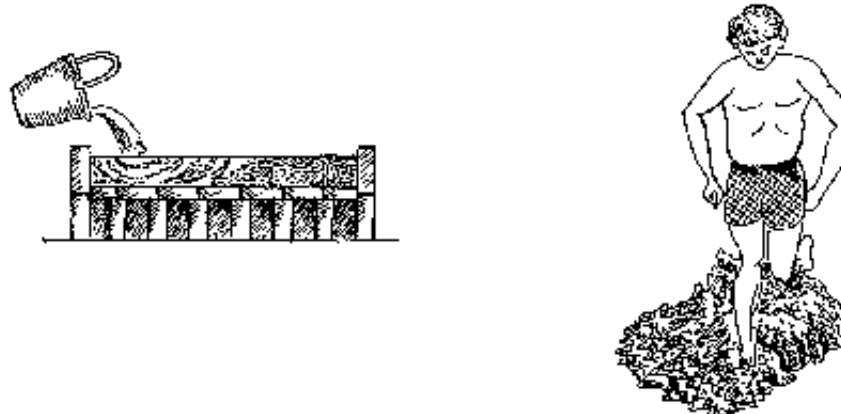

FIGURE 4.1.2-B Work flow of manual wet clay process.(G; H)

G) Dewatering tanks can be common bricks, or cloth placed in a depression in the ground.

H) Kneading by hand or foot.

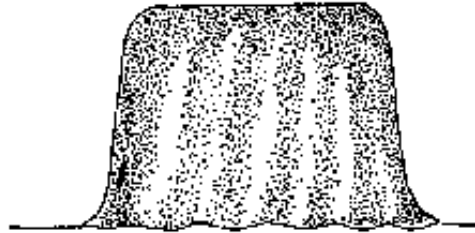

FIGURE 4.1.2-B Work flow of manual wet clay process.(I)

I) Clay is matured in order to increase its plasticity.

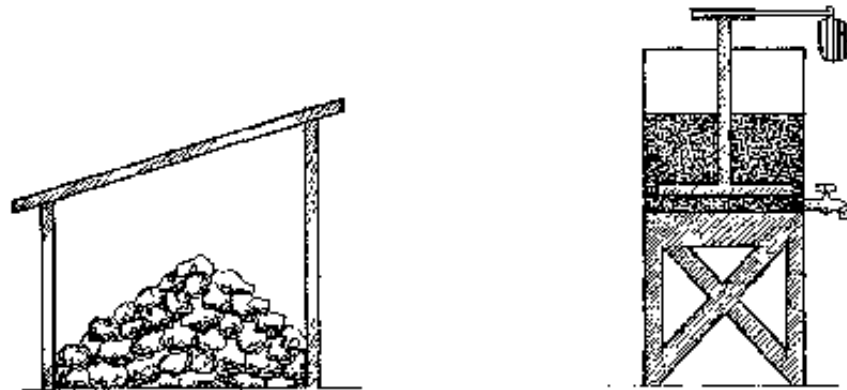

FIGURE 4.1.2-C Work flow of wet process by machine.(A; B)

A) Clay storage open or covered.

B) Electric-powered blunger turns the clay into slip.

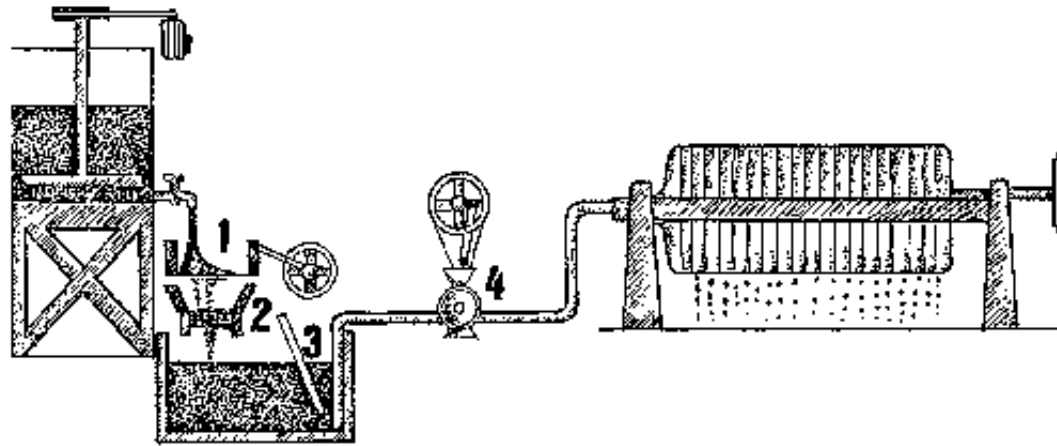

FIGURE 4.1.2-C Work flow of wet process by machine.(C1;2;3)

C1) From the blunger the slip runs through a vibrating sieve (1) and a strong magnet (2) which removes iron particles.

2) From an underground tank with a stirrer (3) the clay slip pumped (4) under high pressure into a filter press.

3) In the filter press water runs off and the clay is retained by filter cloth



FIGURE 4.1.2-C Work flow of wet process by machine.(D; E)

D) The filter press clay "cakes" are removed from the press and taken to the pugmill.

E) Pugging is often done in a de-airing pug mill.



FIGURE 4.1.2-C Work flow of wet process by machine.(F; G)

F) Pugged clay is transferred to clay storage.

G) Clay is stored under moist conditions.

4.2. Hand-forming

4.2.1. TOOLS FOR HAND-FORMING

4.2.2. THE BASICS: HOW TO MAKE COILS AND SLABS

4.2.3. ASSEMBLING COILS AND SLABS

4.2.4. USEFUL HINTS

Hand-forming methods use only the hands and a few simple tools. They are the oldest methods of making ceramics, but still are useful in modern times. They require a very small investment.

Typical products made by hand-forming are:

- Small items, such as animal figurines and small sculpture**
- Large items, such as storage jars for grain and water, special flowerpots, basins for washing clothes, and big sculpture.**

4.2.1. TOOLS FOR HAND-FORMING

The basic operations in hand-forming are cutting, scraping, joining, smoothing and slab making. Tools are easy to make by yourself. Useful tools are:

- for smoothing and cutting: carved wooden tools;**
- for cutting, smoothing, scraping: metal tools, which can be made from old hacksaw blades and heavy wire. Various shapes made from old plastic buckets, etc.**
- for shaping: wooden paddles for beating clay and flattening slabs;**
- for joining, finishing: sponges for wetting clay.**

4.2.2. THE BASICS: HOW TO MAKE COILS AND SLABS

Coils are long cylinders or “snakes” of plastic clay. Depending on how they are to be used they can be as small as a matchstick or as large as a man’s arm. There are three techniques which need to be mastered:

Coilmaking

Coils are easily made by rolling plastic clay on a smooth surface. The difficult part

is keeping the coil even in diameter and round. This requires some practice. It is helpful to remember to roll the coil from the center to the outside, and to roll it as far as possible each time (from the tips of the fingers to the base of the hand) - this will help to keep it round.

A method requiring more expertise is to start with an elongated ball of clay between the hands, and by rolling the hands back and forth, to gradually cause a coil to move downwards. This is a very useful method when working on large pots, and, when mastered, is very fast.

Coils can also be made by using a hand extruder (see page 78).

Slabmaking

There are several ways of making slabs, all of which require a flat surface to work on:

Small slabs can be made by simply pounding a piece of clay with the hand and a wooden paddle. Or, when the slab is partly flattened, it can be rolled with a wooden cylinder (such as is used for rolling pastry dough).

Large slabs can be started by slamming a ball of clay down on the floor, turning it over, and repeating the process until it is sufficiently thin. With practice, slabs almost 1 meter by 1 meter can be made quickly with this method.

Large, thick slabs for big flowerpots, etc., are best made on a flat floor - it is helpful to sprinkle dry clay powder to keep the slab from sticking. Partly-flattened lumps of clay are joined by walking and jumping on them. They then are thinned

as much as required by further jumping and beating with a wooden paddle.

Another way to make slabs is the “cutting method”. This is often used for making rough slabs for tiles. A large rectangular lump of clay is prepared and set on a flat surface. Then a series of long wooden sticks, cut the thickness of the desired slab, is piled up on either side of the clay. These are used as guides for a cutting wire. After each slab is cut, one stick is removed from each pile, and the next slab is cut. This is a cheap and fast method.

Slabs are sometimes made by pouring deflocculated slip. This process is described in the section on slip casting.

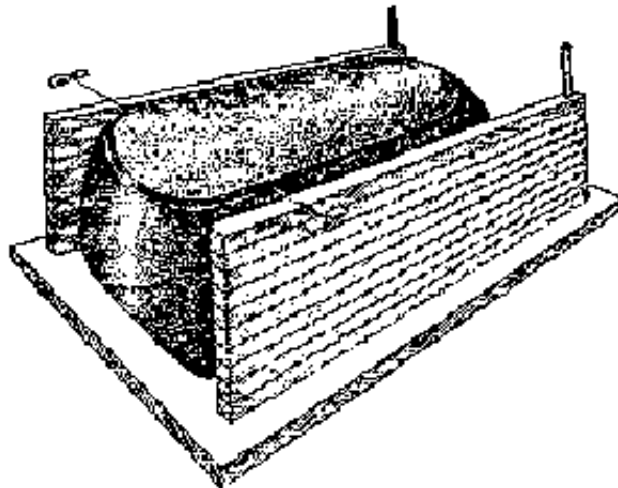

FIGURE 4.2.2-B Cutting slabs with wooden stick guides.

4.2.3. ASSEMBLING COILS AND SLABS

No matter how you make slabs, they are used as basic building elements for a large variety of shapes. Because slabs are most appropriate for flat surfaces, they

are most frequently used for the bottoms of large pots, and for constructing rectangular shapes.

rectangular forms

Rectangular shapes are made by first letting the slabs dry to the leather-hard (half-dry) stage. Pieces of the appropriate size are cut and assembled.

joining parts

Joining leather-hard slabs must be done carefully, so that the joints do not separate while drying. The safest method is shown in Fig. 4.2.3-B.

coils

Forming pots by coil is a standard method, which is still used in many countries for making traditional pottery as well as more modern items. Usually the coil method is combined with beating and scraping, and is often used in combination with the potter's wheel (see below).

The coil method is best used for large round or curved shapes, such as flowerpots, that are too big to make on the potter's wheel.

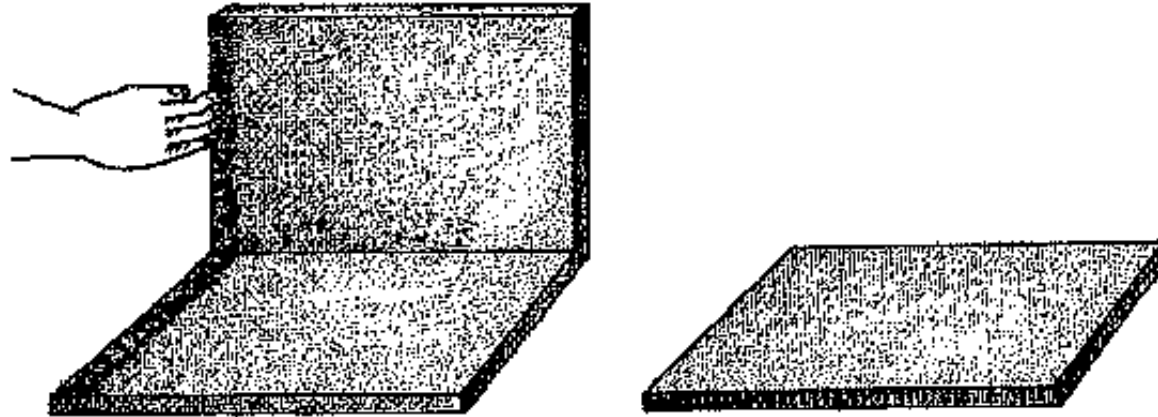

**FIGURE 4.2.3-B Slab joining step by step.(A)
A) Apply a coat of slip to the surfaces to be joined.**

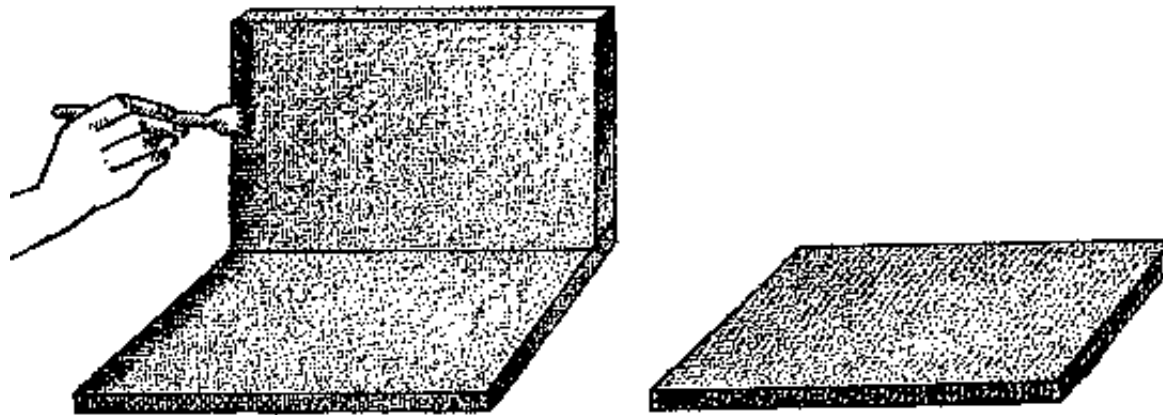

**FIGURE 4.1.2-C Work flow of wet process by machine.(B)
B) The slip then is worked into the clay by scratching the surface - this is most easily done with a tool such as an ordinary fork, or a piece of sheet metal with a serrated edge.**

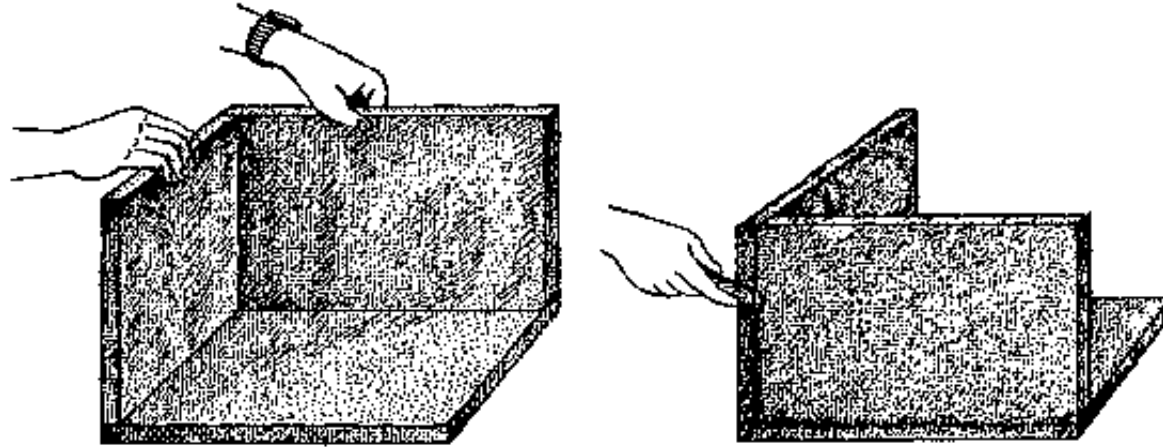

FIGURE 4.1.2-C Work flow of wet process by machine.(C; D)

C) The pieces are then pressed together while the slip is still wet. REMEMBER TO FIRST APPLY THE SLIP , THEN TO SCRATCH IT -this works much clay particles to join very securely. When the better than doing it the other way around.

D) After joining the pieces, gently beat all the seams with a wooden paddle. This helps the seams with a wooden paddle.This helps the joining slip is no longer wet, the seams can be finished with wooden and metal tools.

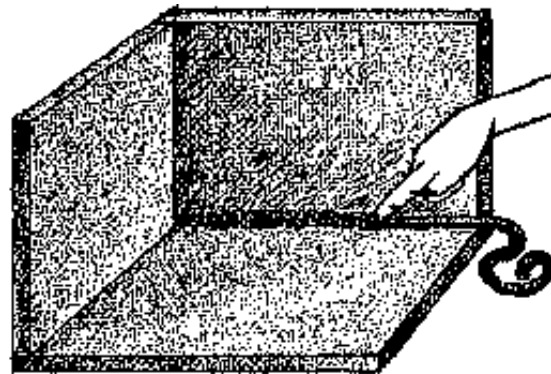

FIGURE 4.1.2-C Work flow of wet process by machine.(E)

E) Joins of large pieces can be reinforced with a clay coil on the inside.

The basic method is:

- Make a base for the pot from a slab. This usually is placed on a wooden plank or a plaster plate (bat), and it is easiest to put this on top of a turntable of some kind (although not essential).**
- A supply of coils is then made and kept near the working area to be used immediately (coils should not be stored, as they are likely to dry out). Otherwise, many potters make coils as they go along. The diameter of the coils depends on the size of the pot, but usually will be between 2 and 5 cm.**
- Join the first coil to the bottom slab very carefully - this is best done with clay slip and scratching as for slab pots (see above). For large forms, the coil is pinched between the fingers to make it slightly thinner and to raise it up.**
- Then build up the walls of the pot by adding a coil all around. It works best to add the coil to the inside of the wall, and then to pinch the two coils together. This makes a strong joint, since it is overlapped, and, because the wall tends to move out when pinching it, it makes it easier to control the shape.**
- Repeat the process until the pot is tall enough. Large pots can be built up over a period of several days to allow the clay walls to harden in order to carry the additional weight.**

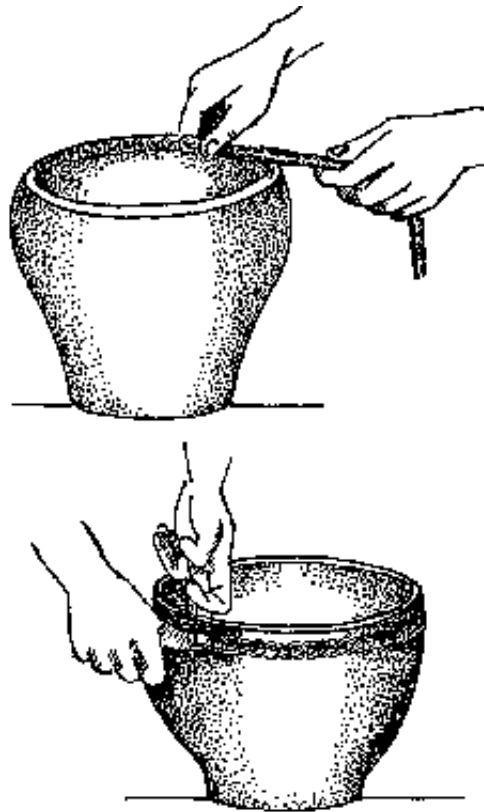

FIGURE 4.2.3-C A coil is added all around while one hand pinches the inside. Once the coil is on, pinching and smoothing are done on the outside.

remember

Usually coil pots are made narrower and thicker than their final shape. As they start to dry, the final shape is given by beating the walls of the pot, which makes the clay thinner and expands the form. This is done by holding a rounded piece of fired clay inside and beating the pot with a flat wooden pallet from the outside (Fig 4.2.3-C). The surface is then smoothed by sponging and scraping. It is difficult to make coil pots round and symmetrical - this comes with practice,

and an expertly-made coil pot is difficult to distinguish from a wheel-thrown pot.

4.2.4. USEFUL HINTS

- Clay for coiling and slab making should be less plastic than clay for throwing.**
- If coils are added too rapidly the lower part may sag. When making large pots, allow the walls to dry while keeping the rim moist.**
- When joining different parts make sure they have the same moisture content otherwise the pot may crack when drying.**
- Allow large pieces to dry slowly by covering them with plastic. Parts of the pot tending to dry faster, like handles, can be covered with wet cloth or plastic so they will dry at the same rate as the rest of the pot.**

4.3. Potter's wheel

4.3.1. CLAY REQUIREMENTS FOR THE POTTER'S WHEEL

4.3.2. TYPES OF POTTER'S WHEELS

4.3.3. FORMING ON THE POTTER'S WHEEL

4.3.4. TOOLS FOR THE POTTER'S WHEEL

4.3.5. FINISHING ON THE POTTER'S WHEEL

4.3.6. DRYING

The potter's wheel was invented in order to make pots faster than is possible by hand methods. It is a very old tool, and has many variations from country to country. All potter's wheels work on the same principle, which is that a rotating

plate (wheelhead) spins a lump of clay around, which then can be pushed and shaped by the hands of the potter. There are many local variations in size, method of propulsion, height, etc.

Shapes that can be made on the wheel are necessarily round, but they may be altered after forming by beating or stretching to make oval or square shapes.

The process of forming clay on the wheel is called "throwing" in English. Nobody knows why this word is used - its meaning has nothing to do with "throwing" a rock. Usually the forming process is referred to as "throwing a pot" or "turning a pot", and the skilled worker who does so is called a "thrower" or "turner".

4.3.1. CLAY REQUIREMENTS FOR THE POTTER'S WHEEL

Almost any kind of plastic clay can be used on the wheel, and sometimes clay is used that is very difficult to shape (such as porcelain). Ideally, though, most potters prefer clay that is quite plastic, free from rocks and roots, and strong enough to hold any shape. These requirements are met by clay that has been carefully prepared, and then matured for several weeks or months (even years in some cases) to develop plasticity.

clay for small and big pots

For small pots, the clay can be fairly soft, but not so soft that it loses its shape when removed from the wheel. Potters who make large items often prefer clay that has up to 30 % grog or sand to reduce shrinkage, and prepared as stiff as possible in order to prevent it from collapsing. Grog can be very fine (even dust) if

smooth finishing is necessary, but often is up to 20 mesh in size. It is always best to have a variety of grog sizes for example from 60 to 30 mesh.

4.3.2. TYPES OF POTTER'S WHEELS

There are many types of potter's wheels, and generally they are chosen to suit work habits of the particular culture. There are two main categories: unmotorized and motorized. All potter's wheels have the following main parts:

Flywheel: a heavy circular disc that provides momentum. It sometimes is also used as the working surface. Flywheels can be made from wood, cement, steel, clay/cow manure, car tires or combinations of these.

Wheelhead: a circular disc that is used as the working surface to which the clay is attached. Wheelheads are made from steel, aluminum, wood, plaster of parts, cement, etc.

Axle: the shaft to which the flywheel and wheelhead are attached. Axles are usually made of wood or steel.

Bearing(s): the device in which the axle rotates. Bearings may be metal bushing types, ball bearings, wood, leather, or stone.

Power source: this is either the foot, the hand or a motor.

UNMOTORIZED WHEELS

Unmotorized wheels usually depend on a heavy flywheel to keep them moving

once started. The main types are:

Lightweight "turntables": These are used for making small pots, and are nothing more than a round wooden plate about 20 cm in diameter fastened at the center to a round stick that turns in a hole in the ground. The potter attaches a small lump of clay, which is shaped with one hand while he rotates the wheel with the other hand. Often, the "coil and throw" method is used (see below).

Advantages: very cheap; often one potter will have a dozen or more wheels which he works on in rotation.

Disadvantages: is only suitable for fairly small products.

Asian low wheel (single bearing): This type of wheel has a combined flywheel and wheelhead, which may be from 60 cm to 100 cm in diameter. It can weigh up to 50 kg. The axle is usually wooden and very short, and has a pointed end which rotates in a single stone bearing. Sometimes the axle is fixed to the flywheel and the bearing is set into the ground, and sometimes it is done the opposite way. The wheel is usually rotated with a stick that is placed into a socket on the edge of the wheel. After it is started, the weight of the wheel keeps it going level, based on the gyroscopic principle (like a toy top). It is suitable for small products such as simple cups which are made very quickly entirely by throwing; larger products are partly thrown on the wheel and finished by beating and stretching.

These wheels are traditionally made from wood, or from a wood and bamboo frame which is covered with a heavy layer of clay mixed with straw, cow's dung, hair and sugar.

Nowadays, the wheel is often made from a cast cement disc, or from a truck tire, mounted on a wooden crosspiece which is attached to the bearing.

Advantages: easy to make with low technology and local materials.

Disadvantages: Because of only the one bearing, the wheel does not stay level. This makes finishing on the wheel very difficult. Large pots cannot be made by throwing alone.

Asian low wheel (two-bearing type): This wheel also sits near the ground, and also uses its flywheel as the wheelhead. It has a slightly longer axle set in the ground, and the flywheel is fitted with two bearings (which may be wooden, or preferably ball bearings). As above, the wheel is rotated with a stick.

Advantages: Because the wheel is stable, it permits throwing larger forms quite thin, and accurate finishing of the bottom is possible. Because the potter works in a squatting position, there is no strain on his back (this is also true for the single-bearing type above).

Disadvantages: The large diameter fly wheel keeps the potter from getting close to his work. This is not really a problem for a skilled potter.

European kick wheel: This type of wheel has a long axle, and a separate flywheel and wheelhead. The flywheel may weigh from 30 to 150 kg. The potter works in a sitting position, and can rotate the wheel with his feet while working on the clay, which makes the speed easy to vary as required.

Kick wheels may be constructed with wooden or metal frames, and the flywheel

may be made of wood, cement, or steel. The main requirement is an extremely sturdy frame that will not vibrate when the flywheel is kicked.

Advantages: The potter can get closer to his work because of the small wheelhead, which makes it easy to brace the arms for stability. It is also a convenient wheel for finishing,

Disadvantages: Puts strain and stress on the potters back because of the awkward sitting position, makes it difficult to see the shape of the pot because the eyes are above it, causes uneven strain on the leg muscles because one leg works harder than the other. It is a very heavy machine and is difficult to move to another location.

Treadle wheel: This is in principle like a kick wheel, but the axle has an eccentric which is driven by an attached foot treadle, and the flywheel is much lighter in weight (10-20 kg). The potter can work either standing or sitting, and unlike with other wheels keeps his foot working the treadle continuously.

Advantages: The body is not excessively strained because of the standing position, and the wheel speed can be easily varied with the foot treadle.

Disadvantages: mechanically more complicated than the above wheels, but not difficult to construct with simple machine shop facilities.

Two-person wheels: These wheels use one person to turn the wheel, while the potter works the clay. This can be done with the Asian two-bearing wheel, where one person rotates the wheel with his foot; or sometimes a special wheel with a flywheel and separate wheelhead is equipped with a hand-driven crank which

drives a cycle chain and gear attached to the axle. A third version is shown in Fig. 4.3.2-F

Advantages: This system is often used for making very large pots by the coil and throw system, when a single thrower cannot manage to turn the wheel and throw at the same time. It also is used where labor is very cheap: otherwise it is a very costly method.

Disadvantages: Requires too much manpower; if electricity is available, it is usually cheaper in the long run to invest in a motorized wheel.

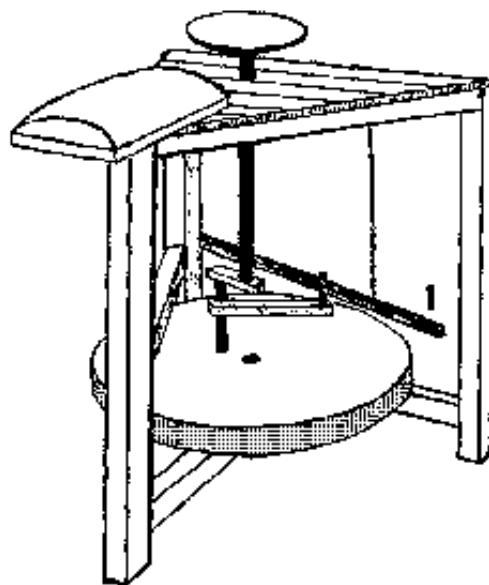

FIGURE 4.3.2-E The treadle wheel is operated by pushing the foot treadle (1) back and forth. The foot treadle can be placed either on the left or the right.

MOTORIZED WHEELS

There are many variations on motorized wheels. The two main types use fixed speed motors or variable speed motors.

fixed speed motors

These wheels all use standard AC electric motors. Usually, the smallest size motor for continuous production is 0.5 HP. If large pots are being made (up to 25 kg), it is better to increase to 1.0 HP or for very large pots (25 kg and more) 2.0 HP.

Sometimes motors are directly coupled to the wheel, which allows only one speed to be used. This means the wheel is either running full speed or stationary. (IMPOR-TANT: do NOT try to make an AC motor work with a variable resistor (rheostat) - this will burn up your motor at low speeds). Fixed speed wheels are suitable for producing the same product repeatedly (for example, factories making only large flowerpots sometimes use this system). In fact, some factories have one large motor connected to several potter's wheels with a shaft and belt system.

The advantages of a one-speed wheel are the low cost and mechanical simplicity. The disadvantage is lack of versatility.

changing the speed

Potter's wheels that have to produce a variety of sizes use several different systems to convert fixed speed motors into variable speeds:

Friction drive: This simplest system is also called the "power-assisted kick wheel". It is simply a kick wheel which has a motor added. The motor is provided with a rubber wheel on its shaft, and is mounted in such a way that the wheel can be

pressed against the flywheel by use of a pedal. Essentially, this replaces kicking with the foot, which can be done if there is a power failure. The speed of the wheel is controlled by engaging and disengaging the motor. This is a simple system to install, and is very reliable - it only requires periodic replacing of the rubber drive wheel.

A variation of this wheel was developed in Nepal. It has the advantage of low cost and light weight, because the flywheel and wheelhead are combined. The maximum speed of the wheel is about 200 r.p.m., which has proven to be suitable for all sizes of product.

Cone drive: Another old system that is often used in factories is the "cone drive" system. Between the motor and wheelhead is a pair of cones that rotate against each other, and move up and down to vary the speed. This is a fairly complicated system to manufacture, as well as being expensive, and has mainly been replaced by electronically-controlled DC motors.

Ring cone system: A variation on the cone drive system is called the "ring cone" system - the motor has a metal cone mounted on its shaft, and the whole motor can be moved in and out, so that the cone drives a rubber ring connected to the wheelhead at variable speeds. This type of wheel usually is made to run from almost 0 r.p.m. up to a maximum of 300 r.p.m.

If you have to construct your own wheel (with the help of a simple machine shop), it is probably best to use the friction drive system, as this can be managed by a mechanic who is unfamiliar with potter's wheels.

variable Speed Motors

There are two types of variable speed motors. The older type uses the principle of movable brushes to provide variable speed with constant torque. These motors are expensive, and are difficult to find nowadays. They have been replaced by variable speed electronically-controlled DC motors, which are also quite expensive.

DC motor wheels

The advantage of a DC motor is that it provides variable speed with constant torque, and can be controlled very accurately. The potter's wheel is mechanically simple, because the motor is coupled with a V-belt to the wheelhead. Unless you have a lot of money to spend, this type of wheel is not recommended, especially in rural areas where repairs are a problem. There is no doubt that this is the system for the future, however.

4.3.3. FORMING ON THE POTTER'S WHEEL

It is not the intention of this book to give detailed instructions for using the potter's wheel. There are many books which describe the basic technique, and it is something that can only be learned with the help of an experienced teacher. It should be remembered that throwing is a highly-skilled technique, and usually requires years of practice before the potter deserves to be called a "master potter".

There are a few advanced techniques, however, which are not often described in

books, and which can be easily understood and learned by an experienced thrower: some of these are described below.

OPEN FORMS

Open forms are those where the mouth diameter is larger than any other diameter of the pot. This includes cups, bowls, flowerpots, plates, etc.

Here is a list of suggestions for successful shaping:

general shaping techniques

When producing a large number of identical shapes, weigh the clay lumps before starting to work. A measuring tool is set according to the size of mouth and depth of the pot. Keep a record of the weight and measurements and a drawing of all your standard products.

Open forms are likely to warp in drying and fir-ing: a rim that is a little bit thicker than the wall of the pot, and which is given a convex curve, will help to hold the shape of the pot. The rim should be rounded (without sharp corners) to prevent chipping in use.

Never use clear water for throwing. It will "cut" the clay and cause the pot to collapse more easily during throwing. Instead use a fairly thick clay slip for throwing.

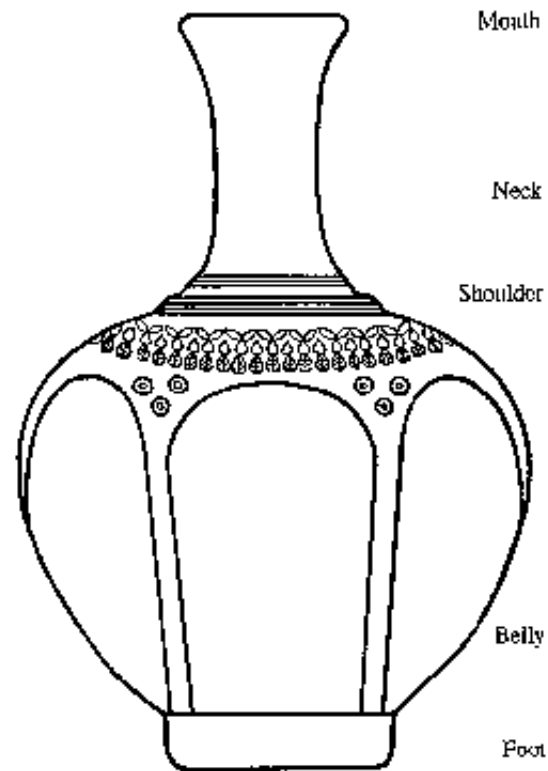

FIGURE 4.3.3-A The various parts of a pot are named after the human body, as shown in the drawing. From the bottom up, they are 1) the foot (if it is a ring, called foot ring), 2) the belly, 3) the shoulder, 4) the neck, 5) the mouth (or rim).

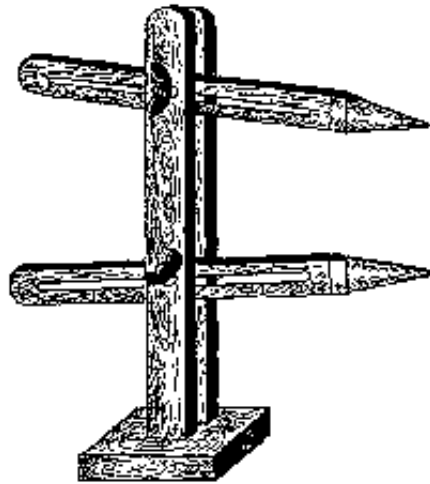

FIGURE 4.3.3-B A post gauge placed next to the wheelhead is used when throwing many pots of the same size. The upper pointer measures the height and width and a second pointer may be used for marking the width of the belly.

big bowls

Bowls of 10-25 kg require a special technique, and to be made in one piece a motorized wheel is best. The clay should be as stiff as possible and addition of grog helps.

A wooden or plaster bat should be fixed to the wheelhead first, so that the pot can be removed when it is finished without collapsing it. If you forget to do this, it is helpful to fasten a piece of newspaper over the mouth of the bowl, using a little water to stick it on. There are a variety of "lifters" which help to remove large pots from the wheel: a large flat wooden scraper can be pushed under the pot, or two flat pieces of sheet metal can be used.

CLOSED FORMS

Closed forms are those where the mouth diameter is smaller than the largest diameter of the pot: this includes bottles, vases, etc.

big bottles and jars

Big jars for storage, lamp bases, etc., of 10 to 25 kg can be thrown very thin in one piece if the clay is stiff enough and a motorized wheel is used. It requires a special technique in order to get enough height and to keep the mouth small. For best results, a plaster or wooden bat should be fastened to the wheelhead, so the finished pot can be removed without collapsing.

- If the clay is the correct stiffness, and the throwing is well done, the result will be a jar with a wall about 0.5 cm thick above the belly, and about 1 cm thick below the belly. The only thick area will be the bottom 5 or 10 cm, which requires some trimming.

- Another way to make big jars is by joining 2 or more sections, or using a combination of coiling, throwing and beating. Fig. 4.3.3-E shows how potters in Swebo, Burma, are doing this.

JOINED FORMS

Joined forms are assembled from separately-thrown sections: they include large bottles, cups with stands, candlestands, and other forms that cannot be made in one piece. They also include forms with lids - although these are not physically joined, they need to be made to the same degree of accuracy. All joined forms require careful measuring. It is also important to make all the pieces at the same time, so that they shrink at the same rate and will fit correctly. IT NEVER WORKS

TO MAKE LIDS AFTER THEIR POTS ARE ALREADY DRY!

lids

The main purpose of a lid is either to keep things from getting into a pot, or to keep the contents of the pot from getting out. For this reason, lids should fit accurately.

interlocking systems

There are many different kinds of lids, which differ mainly in the way they fit together. This is called the interlocking system. Lids may fit inside the mouth, outside the mouth, etc. Measuring tools should always be used for fitting lids correctly. A skilled potter can make lids that fit tightly without much trimming, but usually it is best to make the lid slightly oversize and then fit it accurately when trimming. Also, if you plan to glaze both the mouth of the pot and the lid, there needs to be enough space for the thickness of the glaze.

knobs

The knob is a small round handle attached to the lid, used for lifting it off the pot. Knobs may be small and solid, or are made hollow for larger sizes. Instead of a knob a pulled handle can be placed on top of the lid.

lids that are thrown right side up

Some lids are thrown in the same position as they will sit on the pot. Often, the knob is made at the same time. This type of lid only needs a small amount of

trimming.

lids that are thrown upside down

These lids are thrown like bowls. The rim becomes the part that interlocks with the mouth of the pot. This type requires more trimming to finish the knob. There are many ways to make the knob: A) it can be separately thrown and attached after trimming, B) a small piece of plastic clay is centered on the trimmed lid and shaped into the knob, C) the knob is thrown as the base of the lid (Fig. 4.3.3-G (1) & (2)) and trimmed to shape, D) a handle is pulled and attached to the top of the lid (Fig. 4.3.3-G (3)).

lid and pot thrown in one piece

Skilled throwers can throw small containers with lids in one piece. The lid is made as a continuation of the container as shown in Fig. 4.3.3-H (1). The thrown piece is left until leather-hard and then cut and trimmed.

cups with stands (goblets)

Although these are often attempted in one piece, they never are really satisfactory because it is difficult to remove clay from the stand when finishing. They are best thrown (at the same time) as a cup, and a stand which is made upside down. When both are leather-hard, it is easy to center the cup upside down on the wheel, join the stand, and then remove excess clay while making a smooth connection.

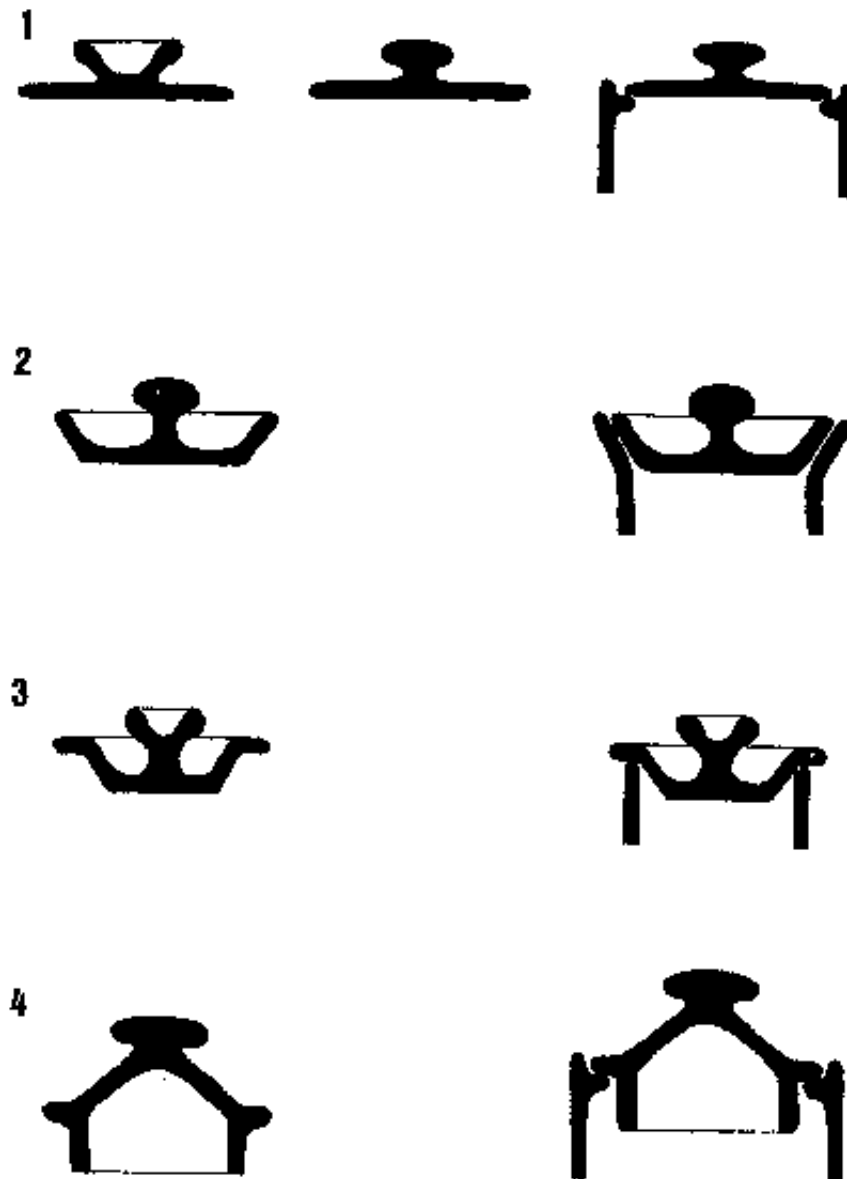

FIGURE 4.3.3-F Lids that are thrown right side up. Their interlocking with the pot is shown in the right column.

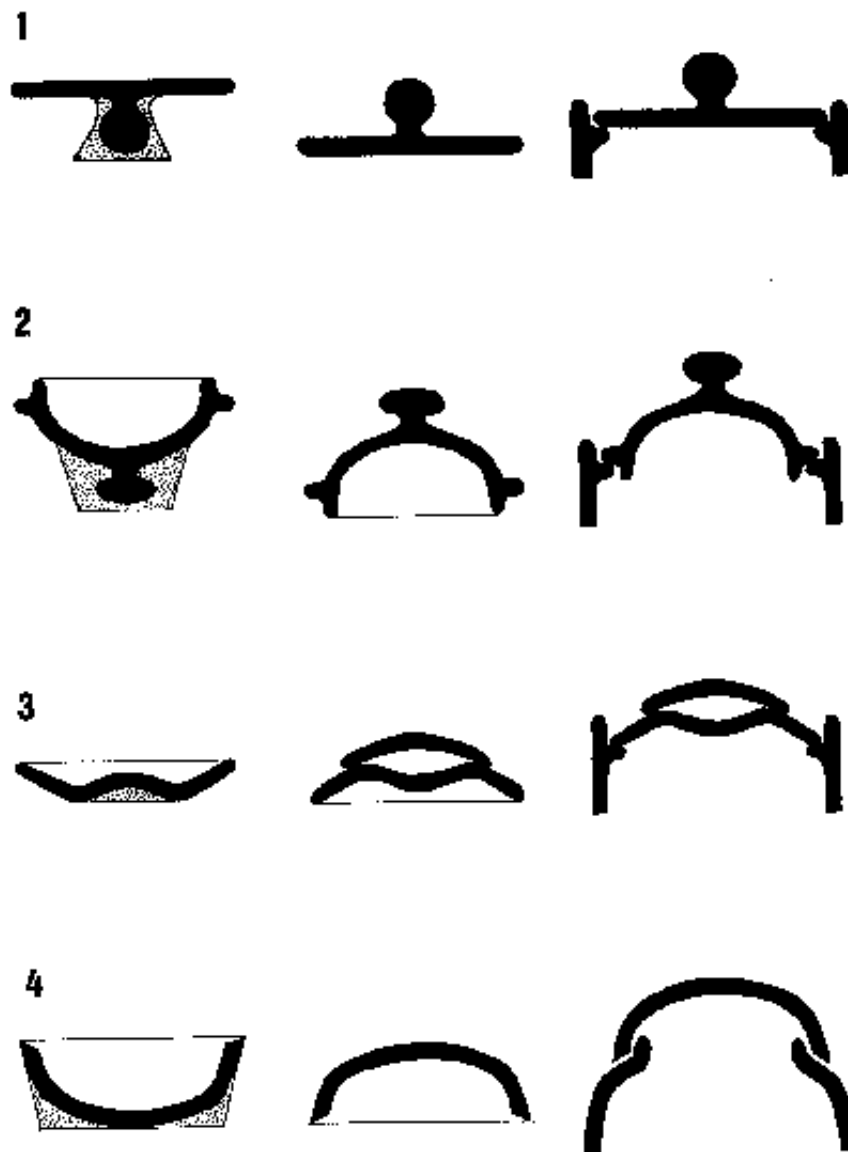

FIGURE 4.3.3-G Lids that are thrown upside down. The left column shows how the lids are thrown on the wheel. In the middle is shown how they are trimmed and right column shows the interlocking with the pots.

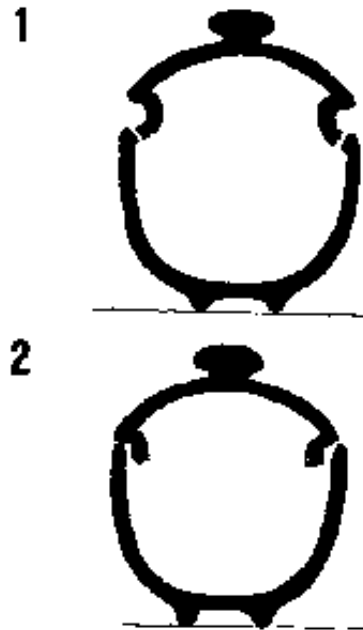

FIGURE 4.3.3-H Lid and pot thrown in one piece (1). When leather-hard, the lid and pot are separated and trimmed to fit.

two-piece bottles

Unless you are a highly-skilled thrower, it is difficult to make large bottles with small, tall necks in one piece. It is much easier to throw the body and close it in to the base of the neck, and then separately throw the neck. When the parts have stiffened enough to be picked up without deforming, they are joined - this is best done by finishing the foot of the bottle, centering it on the wheel, and then joining the neck while the wheel is rotating.

4.3.4. TOOLS FOR THE POTTER'S WHEEL

The tools that you use for the potter's wheel are mainly a matter of personal

preference. The main categories of tools are:

wetting and smoothing: sponges of various sorts (the best are natural sea sponges), a piece of cloth, a piece of soft leather.

cutting: A needle tool is essential for cutting rims and checking wall thickness. This can be made from a big needle, a nail, a piece of wire. A knife can be used, or a sharpened piece of wood or bamboo.

shaping: For smooth surfaces, wooden, plastic, rubber or metal "ribs" are used, mainly on the outside but sometimes on the inside of the pot.

finishing: A triangular piece of sheet metal or a sharp wooden knife is useful for undercutting the bottom before removing the pot from the wheel.

measuring: A variety of wooden sticks, calipers, etc., are used for accurate measuring of mouth size, lid size, depth of pot, etc.

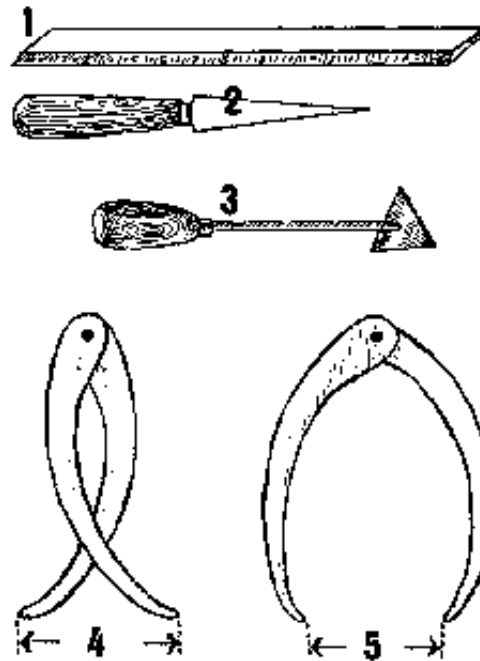

FIGURE 4.3.4-A Tools for throwing: ruler (1), pointed knife (2), V-shaped cutter for the base (3), calipers for measuring both inside (4) and outside (5).

4.3.5. FINISHING ON THE POTTER'S WHEEL

Finishing requires just as much skill as throwing, and profitable production depends on efficient finishing. By "finishing", we mean the process of removing excess clay from the bottom of the pot, and forming the foot ring that the pot sits on. This is sometimes called "trimming". The amount of finishing and the style of finishing depend upon the quality of the product being made. Common pottery normally is not finished very much, if at all, but high quality pottery also needs high quality finishing.

Different qualities of finishing are described below, starting with the simplest (for

common pottery) and going on to the most complicated. Quality finishing takes a lot of time and is too costly for common pottery often, making a foot ring takes longer than the making of the pot itself.

common pots

Cheap storage jars and other low-cost items are simply cut off the wheel and dried. With some clays, this results in cracks in the base, which are caused by not compressing the bottom of the pot enough when opening up the clay. This happens frequently when making multiple small pots from a single large lump of clay. If this is a problem, it usually can be corrected while throwing in the opening-up stage: the bottom is opened out as usual, then the fingers move from the outside in to the center of the bottom, while pressing downward. This compresses the clay particles in the bottom.

Another way to correct the problem is to beat the bottom of the pot when it is leather-hard (half dry). This is done by placing the pot on a plaster of parts bat, and using a round wooden stick with a flat end to compress the bottom from the inside.

rolled foot

The foot of a pot can be rounded and finished when leather-hard by rolling it on a flat surface. It is also a good idea to slightly press in the bottom to make it sit better and to help prevent drying cracks.

better quality pots

These require foot rings. The purpose of the foot ring is to give the pot a stable base to sit on, and especially to make setting in the kiln easier. The foot ring is usually not glazed(except for high biscuit, low glaze firing tableware), and it makes a logical stopping place for the glaze.

The process of making the foot ring involves removal of excess clay. This is called "trimming" or "turning" (the same word is used for lathe work. This is confusing, because the same word is sometimes used for throwing!). Trimming needs to be done when the clay is at just the right stage of leather-hardness - otherwise it is difficult and the result will not be satisfactory. There are many different tools used, and choosing a tool is mostly a matter of individual preference. The main types of tools are wooden tools, metal tools, and wire loop tools - a variety is shown here.

centering for trimming

The first step is to center the pot UPSIDE DOWN on the wheelhead. This requires a lot of practice before it can be done quickly and easily.

- One method is to slowly rotate the pot, and hold a pointed tool steadily near the foot: it will make a line where the pot is farthest from center - this line is pushed toward the center of the wheel, and the process is repeated until the tool makes an even line all around the foot. This is a slow process, and normally is done only for special shapes, or pots with fairly small mouths that do not sit stably on the wheelhead. The pot is then secured to the wheelhead with pieces of plastic clay.

- For small and medium open forms, experienced throwers use the "tap cantering"

method. A small amount of water is first placed on the wheelhead in the area of the pot's mouth. The pot is then placed upside down as much on center as possible, and the wheel is rotated at medium speed. While slightly pressing the bottom of the pot with one hand, the potter gently taps the pot with his other hand until it is on center (this process is impossible to describe in writing, and must be learned from an experienced potter). It needs to be done quickly and surely, and if the pot is at the right of stage of dryness, the water will stick it securely to the wheelhead.

chucks

When trimming a large number of identical shapes, or shapes that will not sit on the wheelhead (closed forms), the potter makes use of a "chuck". This is a cylinder of bisque-fired or dry clay, or sometimes plaster of parts, which is used to hold closed forms inside it, or open forms outside it. The potter makes his own chucks according to his products.

When using chucks, the main problem is to hold the pot firmly without damaging it. The chuck needs to be centered on the wheel, and then a coil of plastic clay is fastened inside it, and also must be centered accurately. A plastic clay chuck, on the other hand, is sometimes covered with a piece of cloth or plastic to keep it from sticking to the pot.

In either case, the pot is placed on the chuck, and then is centered by making sure its bottom is perfectly level. If done correctly, the entire pot will then be on center, and can now be trimmed.

Trimming itself is done in many different ways, all of which work satisfactorily if the potter is skilled. Usually, the foot ring is located first, and then excess clay is removed from the inside. A skilled potter knows when the bottom is thin enough just by the feel of his tool. If he is in doubt, he can tap gently on the center of the bottom with a finger, and the sound will tell him if the thickness is correct. Then the excess clay is removed from the outside of the foot ring, and the ring is smoothed with a fingertip or a damp sponge.

It is usually helpful to use a smooth wooden tool to compress the bottom, working from the outside to the center. With sensitive clay, this also helps to prevent cracks in the base.

Before removing the trimmed pot from the wheel, it should be smoothed with a damp sponge (although many potters like to leave the marks of the trimming tool).

After the completed pot is removed from the wheelhead, the rim should be smoothed with a sponge, and is usually placed upside down for drying.

If very high foot rings are required, they are either made separately as for goblets (above), or another technique is to throw the foot ring directly on the pot. After centering the leather-hard pot upside down on the wheelhead, either a ball of plastic clay is joined to the bottom and thrown to the necessary shape; or, for larger pots, a thick ring may be thrown separately, joined to the bottom, and then thrown to the final shape.

The foot ring should in any case be made wide enough to give stability to the pot. A bowl with a narrow foot ring easily tilts, spilling its contents.

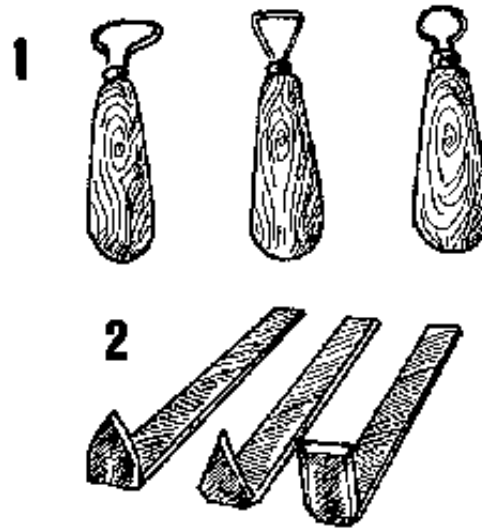

FIGURE 4.3.5-A Trimming tools: wire loop tools (1) and tools (2) made from metal strips.

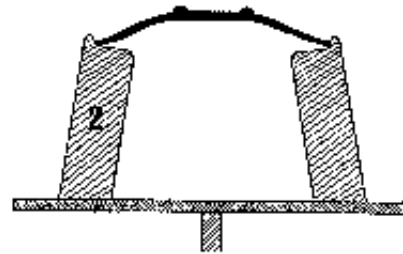
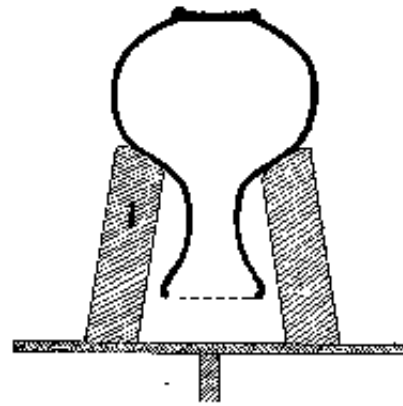

FIGURE 4.3.5.-B Chuck used for trimming a vase with a narrow mouth (1). Another chuck (2) is used for trimming saucers of identical shape.

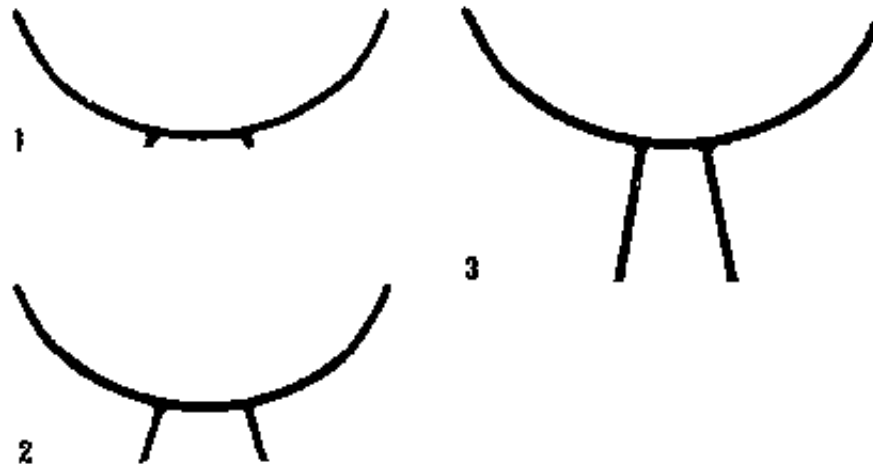

FIGURE 4.3.5-D A bowl's function and appearance depend on its foot. Here three different types are shown .(1) is made by turning away excess clay , (2) is made by throwing on the pot and (3) is made by joining individually-made leather-hard parts; bowl and foot ring.

4.3.6. DRYING

The main problems occurring during drying are warping and cracking. As with all clay products, the best way to prevent these problems is by drying slowly and evenly. This means avoiding wind direct sun, and covering products in dry weather.

helpful hints for drying

Open forms (cups, bowls, plates) of the same size are best dried stacked rim to rim. This helps to prevent warping.

- When drying pots to the leather-hard stage for trimming, they need to be watched very carefully to be sure that the rims do not get too dry. When the rims are leather-hard, it is a good idea to turn the pots upside down until the foot is ready for trimming.**
- Large open pieces can have their mouths covered with plastic to keep them from drying too fast.**
- Covering pots with wet cloth and plastic can keep them from drying indefinitely.**

Pots that have accidentally become too dry for joining should usually be thrown in

the scrap bucket. However, they can sometimes be wetted by dipping them in clean water.

4.4. Joining techniques

4.4.1. HANDLES

4.4.2. JOINING COMPLICATED FORMS

4.4.3. SPECIAL JOINING TECHNIQUES

Many products require joining of several parts. In general, when clay is joined it often causes problems of cracking or separation during drying. It needs to be done carefully and skillfully in order to be successful. This section discusses special problems in joining.

4.4.1. HANDLES

Handles are formed in a variety of ways. The small workshop usually makes handles by hand or extrusion, and then joins them to leather-hard (and already-trimmed) products:

coil

A coil is rolled to the desired diameter, and then it is shaped by pressing and smoothing with a damp sponge.

pulling

A piece of plastic clay is slightly elongated and then is stretched into a handle by

repeatedly pulling it with a wet hand (like milking a cow). The wetting should be done with clay slip, not clean water. Some prefer first to attach a lump of clay to the pot then do the pulling while holding the pot with their other hand. The handle can also be pulled first and then joined.

extruding

Handles are extruded from a hand extruder (see below). This is a fast method for making large numbers of handles. Fig. 4.4.1-B shows a method for unskilled workers to produce quality handles. A skilled potter will not need templates to produce evensized handles.

pressing

Handles are pressed from plastic clay, using a small plaster two-piece mould.

slip casting

This is a standard method for industries producing large volumes of crockery by casting or jiggering. The handles are cast in moulds that produce many handles with one pouring.

drying items with handles

Products to have handles added should be turned upside down as soon as possible after throwing. This allows them to dry slowly and evenly. Many products with handles are damaged by cracking that occurs when a wet handle is joined to a dry product. Dry products can be wetted with clean water before joining the handle,

but this should only be done in emergencies. After joining the handles, turn the pot upside down for even drying.

4.4.2. JOINING COMPLICATED FORMS

The main point to remember about joining separate parts is that the clay must have reached the correct stage of dryness meaning leather-hard. In general, all parts should be at about the same dryness.

When joining, always:

- FIRST coat both surfaces to be joined with clay slip.**
- Scratch both wetted surfaces with a fork or serrated-edge tool, which works the slip into the clay.**
- Press the two surfaces together firmly.**
- If possible, beat the joined area lightly with a wooden paddle, and work the seam together with a rounded wooden tool.**

Another important point is that drying should be slower than usual, so that the different areas of the pot dry evenly.

Some potters do not need to take this much care when joining different parts, because they have a tolerant clay body. But if you have cracking problems you should follow all the steps mentioned above.

4.4.3. SPECIAL JOINING TECHNIQUES

deflocculated slip

If a lot of joining has to be done on a regular basis (for example, a factory that produces rectangular flowerpots using the slab method), it is worthwhile using deflocculated casting slip as “glue”, which is made from the same body as the slabs. This permits faster joining, because the surfaces require a minimum of scratching before joining. It also has about the same water content as plastic clay, so even a thick layer of it will shrink about the same amount in drying, which helps to prevent cracks. (See slip casting and fiberslip below).

pegged joining

When joining big handles or handles that have to carry a heavy load, it is a good idea to use an interlocked joint, similar to a carpenter’s joint. A hole can be cut in the pot, and the end of the handle shaped to fit into it. The surfaces are slipped and scratched a usual (this is a particularly good use for casting slip), then fitted together, and the end of the handle inside the pot is pressed and finished like a metal rivet. This is not usually needed, but if there are problems with specialized products, it does give them an added amount of strength.

4.5. Jigger

4.5.1. APPROPRIATE USE OF THE JIGGER

4.5.2. AVERAGE PRODUCTION QUANTITIES

4.5.3. JIGGER WORK FLOW

4.5.4. JIGGER MACHINE PRINCIPLES AND CONSTRUCTION

4.5.5. MOULD MAKING FOR THE JIGGER

4.5.6. FORMING PROCESS

4.5.7. FINISHING

4.5.8. DRYING

4.5.9. JIGGER PROBLEMS AND SOLUTIONS

The jigger is nothing more than a potter's wheel which has been modified to produce uniform products semiautomatically or automatically. It has been a standard forming tool in the ceramics industry for many years, and is likely to be around for a long time in the future, as it continues to develop into a more and more sophisticated (even computer-controlled) machine. Roller head machines are now replacing the jigger machine for flatware production in larger industries.

Basically, the jigger machine consists of a spinning wheelhead which is fitted to hold plaster of parts moulds, and a movable arm which holds a metal profile. Clay is placed in or on the mould, and the operator purls down the profile, which forces the clay into the shape of the product. The forming method is called jiggering .

The forerunner of the jigger is still used in many countries, usually for making plates with shallow relief designs. Plaster moulds for the inside curve of the plate are centered and fastened to a potter's wheel, a slab of clay is placed on the mould, and the potter smooths and shapes the back of the plate and foot ring. Excess clay is trimmed from the rim, and the product is set aside to dry. The rim is finished when it is stiff enough to hold its shape.

4.5.1. APPROPRIATE USE OF THE JIGGER

It is a necessary tool for industries which produce tableware, such as cups, plates, bowls, and other open shapes. It is mostly used for products that are round and simple in shape, but there even have been jiggers developed for making oval

shapes.

It is not suitable for small, one-man industries, as it is only cost-effective if its full capacity for production is used. One jigger can produce several hundred pieces per day, and the factory needs enough kiln capacity to manage these quantities.

Most forms made on the jigger can also be produced by slip casting, but this is actually slower and requires more finishing time. The jigger requires a large number of moulds, but because the moulds are relatively thin, they can be dried and reused faster than slip casting moulds - they also do not absorb as much water, since plastic clay is used in the process.

4.5.2. AVERAGE PRODUCTION QUANTITIES

Average production quantities for the basic jigger vary greatly according to the skill and management of workers, as well as being different for large and small products.

However, the following figures can serve as a guide to setting production quotas:

Thailand/Burma:	1200 teacups per day
India:	2000 mugs per day
Nepal:	800 cups per day
Europe:	1600 sugar bowls per day
	2400 saucers per day

Semiautomatic jiggers in Europe produce from 8 to 14 articles per minute.

Mould life also varies greatly, depending on the quality of the product, the quality of the plaster of parts, and care taken in handling the moulds. Average figures are several hundred times for one mould - high quality products require more frequent mould replacement.

4.5.3. JIGGER WORK FLOW

JIGGER WORK FLOW AND REQUIREMENTS

raw materials

Plastic clay for jigger work can be any standard clay body. However, it is prepared much softer than clay for wheel throwing. This allows it to be easily shaped in the mould. The clay does not need to be as plastic as for throwing, although plastic clay gets a smoother finish.

mould use

The same mould can be used several times per day, depending on how fast it is dried. Most small producers air-dry their moulds, which usually limits use to twice per day, depending on how dry the air is. Producers using an artificial dryer can use moulds up to 4 times in a single shift.

finishing

The method of finishing depends on the properties of the clay body. Normally, the only finishing necessary is smoothing the mouth. In many factories, this is done at the bone-dry stage, using sandpaper. This is not recommended, because the dust

is a health hazard for the operator; it should only be done if a good exhaust fan and dust mask are used. Instead, finishing should be done with a wet sponge at the leather-hard stage (Fig. 4.3.5-C).

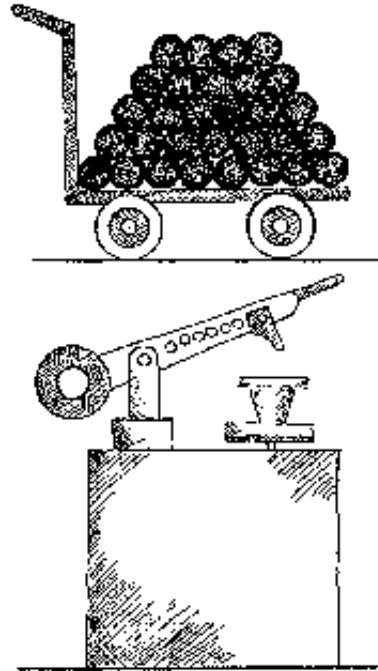

FIGURE 4.5.3-A Work flow of jiggering (A;B)

A) Clay, softer than used for hand throwing, is brought to the jigger. One worker prepares even lumps of clay ready for forming.

B) A plaster mould is placed in the chuck and forming is done by bringing down the inside template.

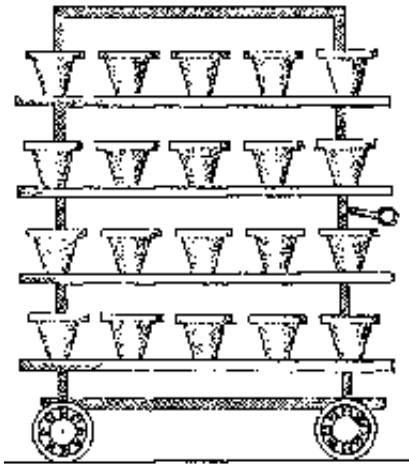

FIGURE 4.5.3-A Work flow of jiggering (C)

C) The operator takes empty moulds from a trolley rack next to the jigger and returns them when they are filled. When all moulds are finished the rack is replaced with a new one.

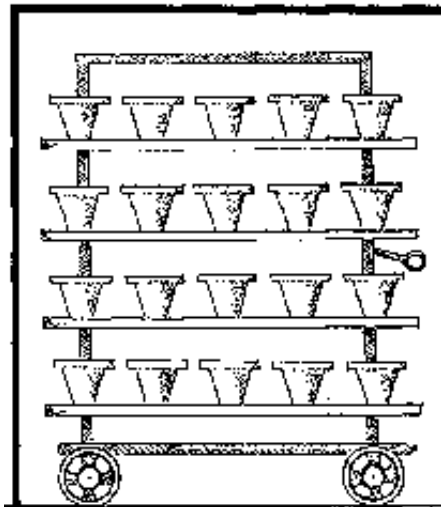

FIGURE 4.5.3-A Work flow of jiggering (D)

D) The trolley rack with full moulds is placed in a dryer.

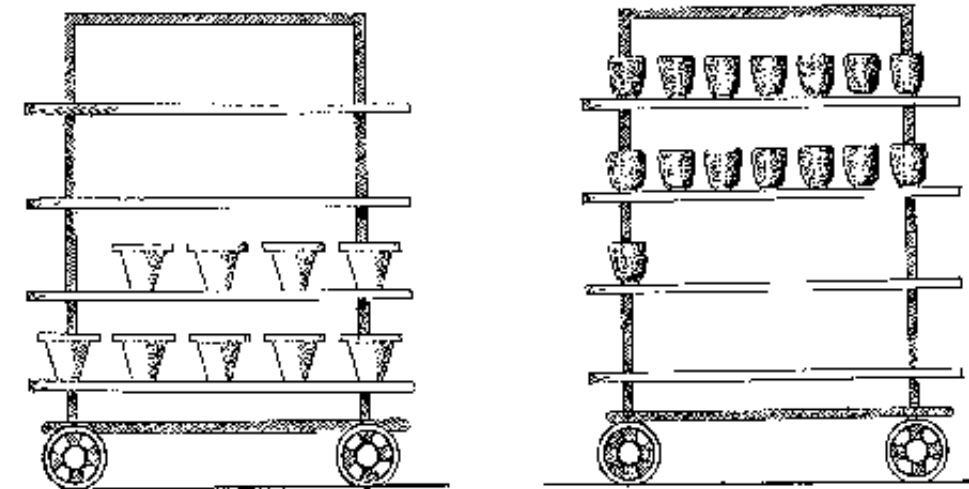

FIGURE 4.5.3-A Work flow of jiggering (E)

E) After the formed items have dried a little they are taken out of the moulds and placed on ware boards. The moulds are returned to the jigger machine.

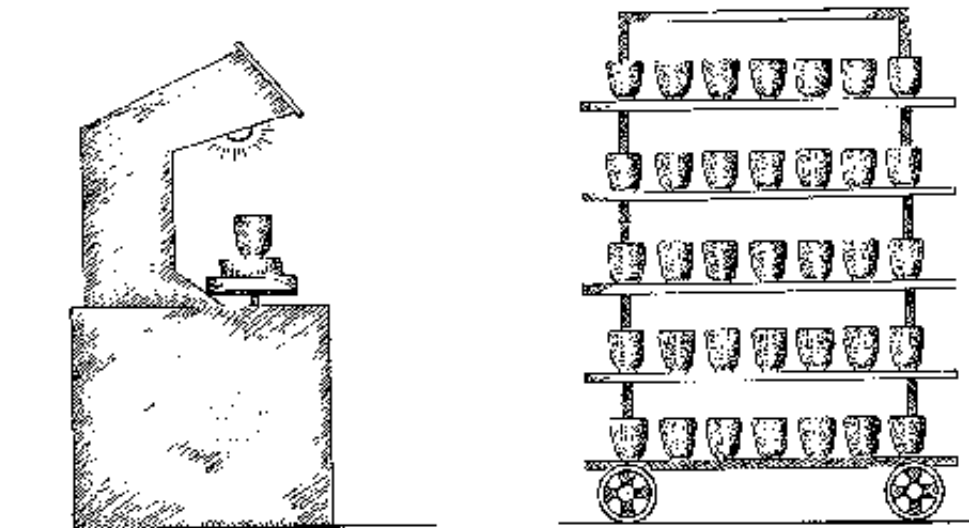

FIGURE 4.5.3-A Work flow of jiggering (F; G)

F) Finishing of the rim is done in a spinning chuck.

G) The leather-hard items are ready for next production step: attaching handles or drying.

4.5.4. JIGGER MACHINE PRINCIPLES AND CONSTRUCTION

We describe here only the simplest types of jigger machines, since the more sophisticated ones cannot be made by a simple machine shop. The machine shown from Nepal was constructed using only a machine lathe and an electric arc welder.

main parts of the jigger

Wheelhead: This is equipped with a chuck for holding the plaster mould, as shown. There are two options: 1) chucks made of mild steel or cast iron, 2) a flat wheelhead on which a plaster chuck is fitted. The wheelhead is usually set to rotate at 250-350 r.p.m. Small products like cups can be rotated faster - some machines go up to 400 r.p.m. It is very Important for the chuck to run true.

Because plaster chucks wear out fast, causing the moulds to go off center, they are sometimes reinforced on the inside rim with a rubber lining, a metal ring or a lead collar the latter is melted and poured in place.

Axle and bearings: The axle should be 2.5 cm in diameter, and good quality ball bearings should be used.

Drive system: Machines which have individual motors use pulleys and V-belts to reduce the motor speed and provide mechanical advantage. In factories where several machines are needed for larger production, one large motor often drives a long shaft, and the machines are connected to the shaft with flat belts. In this

case, a simple clutch system is necessary for each machine, in order to stop it when necessary.

Clutch: The clutch is optional. Many machines have wheelheads with no clutch. A skilled operator can insert and remove moulds without stopping the wheel. Clutches are of two types: a spring clutch is used with V-belt drives, whereas a sliding belt system is used with flat-belt drives.

Variable speed drive: This is also optional. Most producers make standard products, and one speed is sufficient for products ranging from plates to cups. In more sophisticated machines, a friction drive allows the speed to be reduced for larger items. A cheaper solution is to fit multiple size pulleys on motor and axle so speed can be adjusted by changing the V-belt.

Jigger arm: There are numerous jigger arm shapes. The main requirement is that it be very rigid (it must not vibrate in use), so cast iron is the preferred material. The bearing where it rotates also must be very solid: the usual system is a cone-type bushing, where the cone tension can be adjusted with lock nuts.

Profile or template: Normally, the profile is made from mild steel, which is carefully ground to the exact shape. The steel needs to be at least 3 mm thick. Metal profiles are sometimes backed up with wood to give them better rigidity. The profile will wear down with use, and it is necessary to regrind it from time to time. Additionally, master profiles should be kept for standard production items, so that new working profiles can be made as necessary.

The profile has to be adjusted so it is exactly on center and does not leave a

“bump” or spiral in the center of the article.

For limited production items, profiles are sometimes made from acrylic plastic or even from wood. These, of course, have a much shorter working life than mild steel.

The profile is mounted with adjustable nuts and bolts, which allow it to be accurately positioned and shifted as necessary.

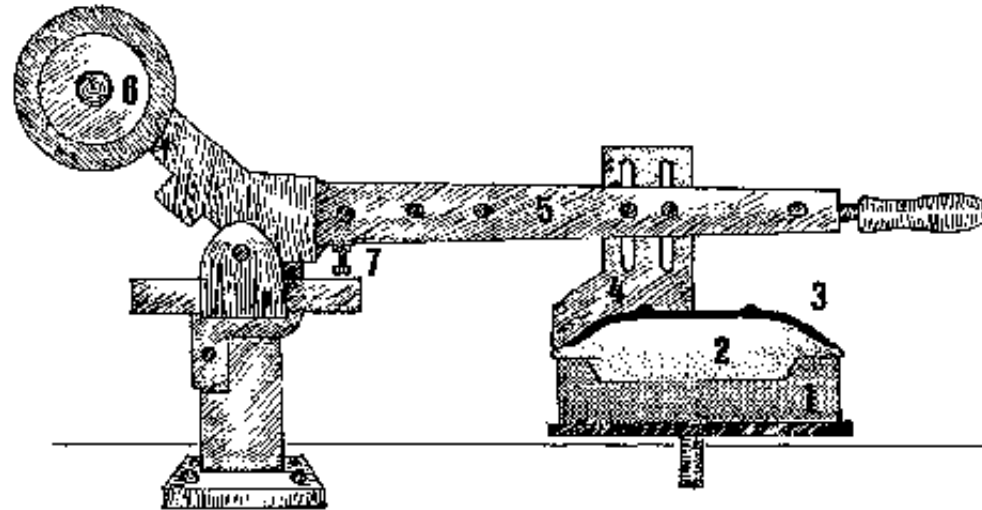

FIGURE 4.5.4-A Jigger system for forming plates. Main parts are: wheelhead with chuck (1), mould (2), plate(3), profile (4), jigger arm (5), counter balance (6), stop adjustment(7).

4.5.5. MOULD MAKING FOR THE JIGGER

As with slip-casting moulds, jigger moulds require a plaster model, master mould, and case mould from which the working moulds are made. (Refer to section 6. on

mould making).

limitations on shape

One-piece moulds: Usually, moulds are only made in one piece. Because the product needs to be easily removed from the mould when leather-hard, shapes must be designed for this purpose. Moulds must not have any undercuts which might catch the clay. Also, there should not be any sharp edges - foot rings must be rounded and not very high.

Cylinder shapes are not very successful because the working moulds are very difficult to separate from the case mould. Instead, straight-sided shapes should be slightly tapering.

Two-piece moulds: Sometimes, two-piece moulds are used for shapes that curve in slightly at the top, or have a foot ring that curves out slightly. Usually, it is more efficient to form this kind of shape by slip casting.

decorated moulds: Moulds are often made with shallow relief designs. This is particularly effective with plates. Some factories use this technique, and then finish the plate by hand-carving when leather-hard. This gives an effect that seems 100 % handmade, and greatly increases the retail price of the product.

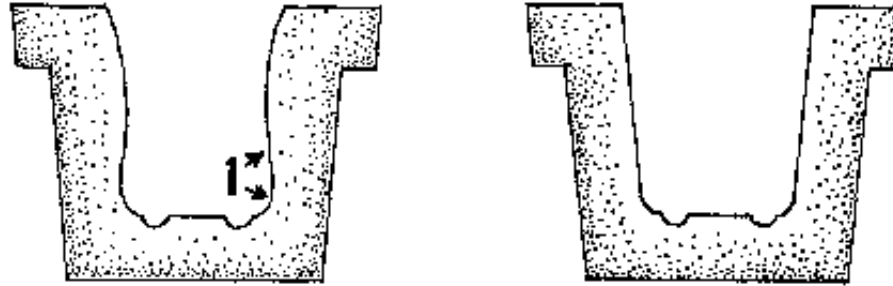

FIGURE 4.5.5-A The left jigger mould has undercut at (1) This will make it impossible to release the pot from the mould. The right jigger mould has no undercuts and its slightly tapering shape makes mould release easy.

4.5.6. FORMING PROCESS

adjusting profiles:

The profile has to be adjusted so that the jiggered item has the right shape and thickness. This is done by cutting the jiggered item in half with a knife. The thickness should match that of the original sample. The profile may get out of position and its surface will wear out, so the production supervisor should cut control samples at least once a day to make sure products are up to standard.

profile on the inside:

- Prepare balls of clay in advance. They should be weighed for accuracy, but experienced operators will be able to judge the correct quantity by taking lumps from clay on the bench. If clay is prepared in a pug mill the extruded clay wad can be cut in slices of a length corresponding with the required weight. They are then placed in a convenient location for the worker.

- **Also prepare ware boards and moulds in advance, which means they MUST BE CLEAN, and set in a convenient location.**
- **Place a mould in the chuck. (Normally, the machine is running and does not need to be stopped to insert or remove working moulds).**
- **Place or throw a ball of clay in the mould. It is pressed into the bottom and then opened up with one hand for large items. With small shapes, the profile can be brought directly down on the ball of clay.**
- **Bring the jigger arm down into the mould, which will force the clay into shape. Excess clay is removed from the top of the mould and from the profile. Before removing the profile, the inside of the article must be wet with water to smooth the surface.**
- **Remove the mould from the chuck and set it on a ware board.**

profile on the outside:

- **Prepare slabs of clay in advance. This is usually done by cutting slabs from a block of clay using wooden sticks and a cutting wire (see slabs, above). Slabs can also be beaten out on a wet plaster bat with a wet plaster beater. (If the beater is dry, the slabs will stick - it is soaked in water every night for the next day's work). Plates made from such slabs need more finishing work. For better quality plates slabs are prepared by throwing on a potter's wheel or on a bat making jigger machine as in Fig. 4.5.6-B.**
- **Put a mould in the chuck with the already-prepared slab on it.**

- **Sponge and press the slab with the hand while it rotates to stick it firmly to the mould.**
- **Bring the jigger arm down to form the back surface of the plate, at the same time letting water drip from a sponge to smooth the surface.**
- **Remove excess clay.**
- **Remove the mould and plate and set the latter on a ware board.**

4.5.7. FINISHING

Finishing is a separate operation and is best done by a separate worker if there is enough production. This keeps forming and finishing going continuously.

Finishing can be done on a jigger wheel, or on a potter's wheel. The wheel is set up with a chuck, which often is thrown from plastic clay to fit the inside of the form. It is best, however, to make a chuck from plaster which exactly fits the product.

All clay products are best finished when they are leather-hard. In this case, the piece is set in the chuck, the wheel is rotated, and the outside is finished with a wet sponge. Normally, the area most needing finishing is the mouth or rim.

4.5.8. DRYING

Drying of jigger products requires no special techniques, but the general recommendations for potter's wheel products should be followed, such as setting

pieces rim to rim to prevent warping. Wet jigger moulds will not release the jiggered item and in order to increase production artificial drying of moulds should be considered (see chapter 9.2).

4.5.9. JIGGER PROBLEMS AND SOLUTIONS

Problem: Clay sticks to the moulds.

Solution: This is sometimes a difficulty with new moulds. They may be dusted with a small amount of talc or fine grog powder to prevent sticking. Usually, the problem stops after a mould has been used a few times.

Problem: Breakage of moulds.

Solution: Early breakage of moulds may be caused by poor quality plaster of parts. Sometimes, adding about 5 % cement to the plaster mix will help the strength, although it is better to look for another plaster supplier, if possible. Or moulds may be too thin, especially in the top rim, and should be made thicker. Moulds are often reinforced by setting a wire ring inside the rim during mould casting.

Problem: "Feathering" in the bottom of the inside (cups, bowls), or on the bottom of saucers - this Looks like a spiral or "butterfly".

Solution: Correct adjustment of the profile. Metal of profile too thin, which causes "chattering". Jigger arm too thin, which causes vibration. First make the profile thicker or place a wooden plate on its back. If this is not enough try to reinforce the jigger arm.

Problem: Rapid wearing out of plaster chucks.

Solution: Metal rings can be cut accurately from 2-mm mild steel, and set into the rim of the chuck for long chuck life. A rim of rubber inside the chuck is often used but it is difficult to make it run true. An old method is to pour melted lead into the chuck. Melted lead does not harm the plaster and it is easy to trim.

Problem: Uneven thickness of products.

Solution: Wrong setting of the profile causes uneven thickness of a product's cut-through profile. Profile is refixed or it may need to be reground. A plaster mould running off center causes the jigger item to be thick on one side and thin on the other. The problem may be that the jigger head or plaster chuck is off center or that the clearance between mould and head has become too great. The plaster mould may from the beginning be off center due to faulty original models or case moulds.

4.6. Extrusion

4.6.1. HAND EXTRUDERS

4.6.2. MOTORIZED EXTRUDERS

4.6.3. TYPICAL EXTRUDED PRODUCTS

Extrusion means the process of forcing plastic clay through a shaped mouth, called an extrusion die or nozzle. The verb is "to extrude". The simplest extruders are hand-powered for forming handles, etc., and the most complicated ones are very sophisticated machines for producing large products like pipe.

4.6.1. HAND EXTRUDERS

Hand extruders consist of a cylinder to hold clay, and a piston to force it through a die attached to one end. A medical syringe (with the needle removed) can be used to produce very small coils for decoration - so this is actually a very simple extruder. Hand extruders can be used for small solid extrusions (like handles), and can also extrude hollow pipe up to about 15 cm in diameter. There are two systems for providing the necessary pressure:

- Screw system: This uses a long screw attached to the piston to compress the clay. This machine is sometimes called a "wad box".**
- Lever system: A lever arm is attached to the piston, and pulling it down forces the clay through the die. There are two ways to drive the lever arm: by a "ratchet" system, where the end of the lever is engaged in slots on the support arm, or by the faction system, where a metal ring holds the lever arm in position. In either case, the principle is the same as a "bumper jack" for automobiles, and this type of jack can actually be modified to power an extruder.**

Dies for the extruder can be made from mild steel, acrylic plastic, or waterproof plywood. The extruder cylinder is fitted with a screw on cap which holds the dies, so it is easy to change them as required.

Clay for hand extruders needs to be fairly soft, so that it can be pushed through the die easily. If pipes are being extruded, they can only be made relatively short, because the soft clay is difficult to transport without collapsing. These "pipes" are normally used as cylinders for making products like flowerpots.

4.6.2. MOTORIZED EXTRUDERS

Motorized extruders are simply pug mills equipped with extruder dies according to their purpose. Most pug mills are used for the purpose of producing plastic clay body for other forming methods, but almost any pug mill can be used for extruding products such as small hollow bricks. Specially-designed pug mills are used for extruding stoneware pipes and split tiles, which require higher pressure and more control.

There are several different kinds of pug mills that can be made with simple technology. The main parts are:

- Motor: ranging from 1 HP for very small mills up to 30 HP and more for the largest ones.**
- Reduction gear system: Because speeds range from 15 to 25 r.p.m., reduction is usually done with gears. This may be a combined V-belt, pulley and gear system, or direct gear system. Frequently, either an automobile transmission or differential gearbox is used.**
- Axle and blades: The main problem with the axle design is that any gears or bearings should be isolated from the clay. Blades can be made simply from flat mild steel. When thorough mixing is required the blades are spaced widely at the beginning and more closely at the outlet. For high output it is made the other way around, but in both cases at least two blades are spaced opposite each other at the outlet, like a propeller, to produce compression and proper extrusion. High quality units use stainless steel for both shaft and blades to avoid contamination**

of white clay bodies with iron oxide.

- De-airing chamber: This is optional. De-airing treatment improves plasticity and reduces lamination problems, but proper maturing and brief kneading after pugging will do the same. It consists of an input screen which feeds clay "noodles" into the box, and a vacuum pump which removes air from the clay. It is fairly complicated to make your own de-airing chamber, as it needs to be absolutely airtight. Correct design is also very important, since a common problem is that clay does not exit from the chamber fast enough, resulting in blockage.

De-airing chambers have a door which can be opened for cleaning, and the better ones have an easily removable screen, for the same reason.

- Extruding mouth: For clay production, either a round or rectangular extruding mouth is used. This is a cone section with a cylindrical mouth. The purpose of the cone is to compress the clay, which improves its quality. The diameter of the outlet mouth is normally about 2/3 of the barrel's diameter.

Pug mills can be fitted with a variety of special extrusion dies for directly making products. Common dies are for solid bricks, hollow bricks (of various shapes and sizes), split tiles, and pipes. NOTE: Many of these products require very stiff clay and therefore specialized pug mills.

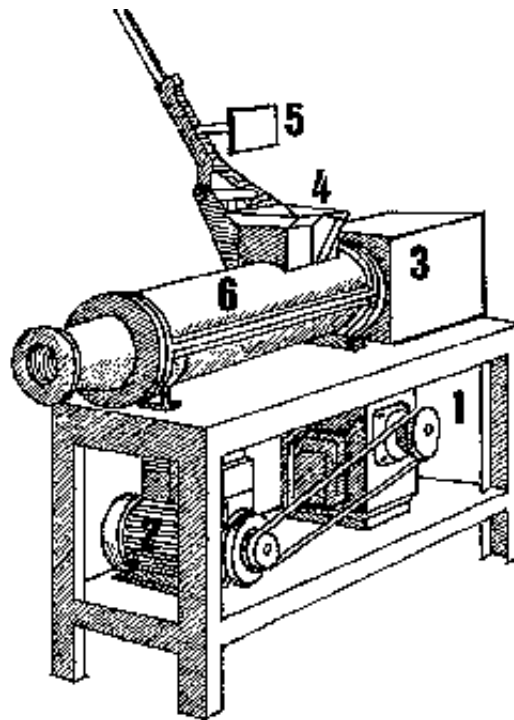

FIGURE 4.6.2-A Horizontal pug mill with main parts named: gearbox (1), 3-HP motor (2), bearing house (3), feed hopper (4), plunger (5), mixing barrel (6).

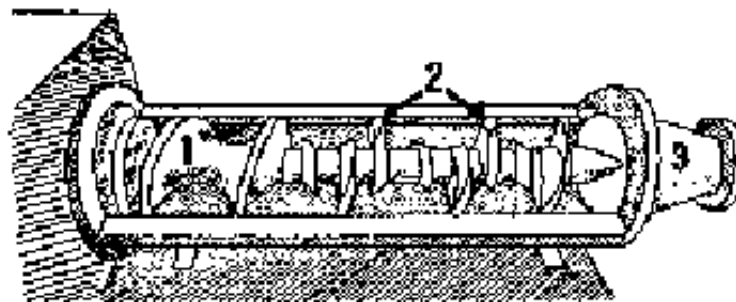

FIGURE 4.6.2-B Interior of pug mill barrel with feed auger under hopper (1), mixing blades (2) and extrusion cone mouth (3).

Common types of pug mills

Vertical pug mill

- drum type, non de-airing, side extrusion. This is a pug mill which uses a drum up to 60 cm in diameter for mixing clay. The earliest version of this mill used an animal to turn it, and the mill often consisted of a wooden box, which contained a wooden shaft mounted with a series of wooden blades (which sometimes had wires running between them to cut the clay). More modern versions are made from metal drums, and have a metal axle and blades which are powered by an electric motor. The speed of the pug mill is quite slow - about 8-15 r.p.m., and the speed reduction can be obtained by a combination of V-belts and pulleys, which are connected to an old automobile differential gearbox. The clay is extruded from a rectangular opening about 10 x 15 cm at the bottom. The limitation of these pug mills is that they can only extrude rather soft clay, and cannot be used for direct product extrusion, but the low cost and simplicity of the machine make it very popular for small producers.

The pug mill shown in Fig. 4.6.2-C is larger than usual, and is used mainly for mixing clay for insulating bricks (50 % by volume rice husks and sawdust), which normally needs to be quite soft. It can be filled with dry clay body mixture and water, unlike ordinary pug mills, which are usually fed with already plastic clay. It is equipped with a door on the extruder mouth, which is closed while the clay is mixing, and then opened to empty the mill. It has a 5-HP, 3-phase motor.

Vertical pug mill

- single shaft, non de-airing, bottom extrusion. This is also a simple kind of pug mill, and is capable of being made by a small producer. It consists of a cylinder

and a series of blades which mix the clay and force it out of the end. It cannot practically be used for forming, because compression is too low.

Horizontal pug mill

- single shaft, non de-airing. This is as simple as the horizontal pug mill, but sits horizontally. It can be fitted with simple dies and a cutting table, for products like hollow bricks.

Horizontal pug mill

- single shaft, de-airing: Has a vacuum box which removes air from the clay. This requires a screen, which extrudes small "noodles" of clay into the vacuum box. After the air is removed, the clay is recompressed and extruded. This is used for producing high quality clay body, and can also be used for hollow bricks and split tiles. De-airing pug mills are rather sophisticated to construct, and should not be attempted by the inexperienced. Single shaft pug mills are a bit difficult to feed, because the clay tends to get stuck in the feeding mouth. Many of them are fitted with a metal roller, which helps force the clay into the blades, or with a plunger like the one shown in Fig. 4.6.2-A.

Horizontal pug mill

- double shaft, de-airing: This is the same as above, but in the first mixing chamber, it uses two shafts fitted with screw blades that turn toward each other. This makes feeding it easier, and it also mixes the clay better. The clay is compressed and extruded by a third shaft.

- **Combined vertical drum mixer and horizontal extruder, non de-airing:** This type of machine is widely used in small-scale tile and hollow brick industries. It uses a drum to thoroughly mix (already plastic) clay, and then feeds the clay into a horizontal extruder.
- **Combined horizontal mixer and vertical pipe extruder, de-airing:** This is a mixer which feeds a vertical pug mill equipped with a die for pipes. The machinery is heavy duty, because the clay for pipes must be quite stiff.

4.6.3. TYPICAL EXTRUDED PRODUCTS

Extrusion in recent years has gained more and more popularity, as it becomes very sophisticated. It probably finds its main use in the heavy clay industry, for production of hollow construction bricks and blocks, and for split tiles. While most of these products are too complicated for the small producer, there is good scope for the smaller and simpler types of hollow bricks.

Most small producers can benefit from the use of a simple hand extruder, which is a small investment that can quickly pay for itself in increased production of handles or decorative elements.

Clay for hand extruders should be prepared as for wheel throwing; i.e. thoroughly kneaded so there are no air bubbles. The clay is then formed into a cylinder slightly smaller than the extruder pipe, and placed in the pipe (which previously has been cleaned and fitted with the appropriate die). Clay is then extruded and cut to the needed length.

Extruded products

kiln shelf stands

Also called "posts", these are easily made with a hand extruder (Fig. 4.6.3-A). Plans are given here for typical cross sections, and the construction of dies for hollow forms is shown.

A typical clay body for stands is fireclay with about 30 % fine grog (60 mesh and below).

The extruding step is quite easy - usually long pieces (30 to 45 cm) are made, but stands require accurate cutting and finishing so they are easy to use. Cutting is best done when the clay is softly leather-hard. First, the extrusion is straightened and trued by gently rolling it on a flat surface. A wire cutter can be used with a cutting box similar to a standard carpenter's miser box. When enough stands of the same size have been made, they should be placed together vertically on a flat surface, and accurately sized by placing a flat wooden plank on top of them. This is beaten gently to make the stands exactly the same size. They then are ready for drying.

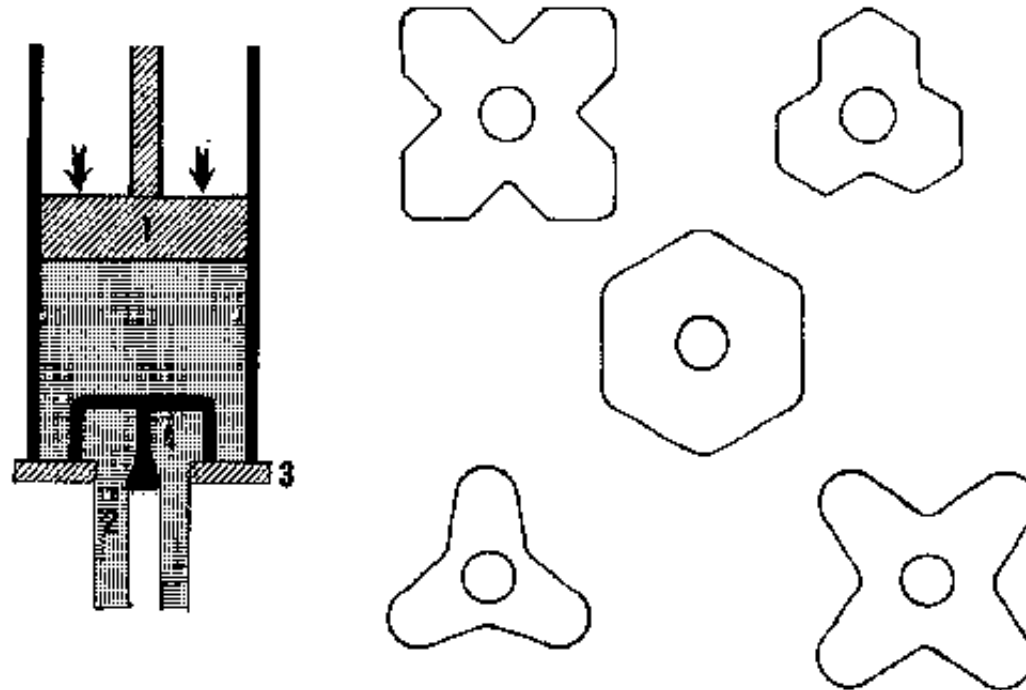

FIGURE 4.6.3-A Cross section of kiln shelf stand with hollow extrusion die.

tiles

The most common type of tile made by extrusion is the split tile, which is made by special pug mill extruders that are capable of using very stiff clay. The tiles are extruded in pairs which are cut in two after firing.

Particle orientation and lamination_ produced by the auger action cause the tile to warp in drying or firing. This tendency can be reduced by striking the right balance between stiffness and plasticity of the clay body, auger speed and length of reducer and extrusion die. Sometimes wires are set inside the barrel after the last extruder blades in order to reduce lamination by cutting up the clay.

It is nearly impossible for the inexperienced potter to make his own tile extrusion dies. In industrialized countries this job is left to specialists who will tailor dies for the particular extruder and clay body used by the customer. It is not recommended for the small producer to try to make his own extrusion dies for split tile making.

However, for small decorative tiles that do not need to be especially flat or exactly equal in size, the hand extruder can be used. The pug mill can be used for extruding clay slabs to be used for leather hard pressing, because the pressing breaks up the auger lamination by realigning the clay particles.

handles

One of the best uses of the hand extruder is for making handles. Lengths of clay are extruded, and then cut to the desired size (see chapter 4.4.1).

bricks

Bricks are made with a horizontal pug mill, or with a combined vertical drum pug mill with horizontal extruder. There are two systems - using soft clay and using stiff clay which require different machinery. De-airing is not normally used for common quality bricks made by small factories, although it certainly is necessary when special quality bricks (glazed bricks, for example) are desired. In large brick industries, where large and complicated bricks are made, very heavy duty de-airing extruders are used.

hollow bricks

When bricks are formed by extrusion they can be extruded hollow as shown in Fig. 4.6.3-C. This has the advantage of reducing the amount of clay used for each brick and thereby also reducing fuel cost. The bricks are still strong enough for normal construction and they are better heat insulators compared to solid bricks.

clay for hollow bricks

The clay used is fairly rough clay suitable for common bricks, but may need slightly higher plasticity. It normally is not washed, and in fact may often contain some roots and rocks. For this reason, if the pug mill extruder has a screen, it is generally removed so that it does not become blocked.

hollow bricks - soft clay system

Machinery for the soft clay system does not need to be heavy duty, so it is quite inexpensive. It produces a brick from clay the consistency of wheel-throwing clay, so it is feasible to fit a die on a standard pug mill. The main disadvantage is that the product is difficult to handle, so it requires large numbers of boards on which the wet bricks are placed for drying. The holes are normally made to run through the largest face of a standard size brick (as in Fig. 4.6.3-C), because this gives it the greatest strength when used in construction. Extruders with a small barrel can be made to extrude bricks with the holes running through the end faces (Fig. 4.6.3-D). These will be less strong but they are quite suitable for filling in walls in reinforced concrete constructions and for single storied houses.

hollow bricks - stiff clay system

The stiff clay system requires more expensive machinery, which must be strong

enough to extrude almost leather-hard clay. The advantage is that the bricks are strong enough to handle immediately after extrusion, and can even be stacked for drying. It also permits easily making larger size bricks.

Extruding machinery can be powered either by an electric motor, where a 3-phase line of suitable capacity is available, or by a petrol or diesel engine. For a typical soft clay extruder, a 10-HP motor is required, and for the larger stiff clay extruder, up to a 30-HP motor.

Hollow bricks production need not be done in a factory, and the bricks are usually made during the dry season in monsoon countries. The only requirement is a simple shed roof to cover the machinery and motor. Kilns may be the periodic type, which may or may not be covered with a roof, or a continuous type of kiln is used (usually a "bull-ring" kiln). Standard brick kilns can be used for hollow bricks with no conversion. Another system for firing uses rice husks as fuel. Bricks are stacked inside a semipermanent kiln wall which is also made of hollow bricks, and gaps between the bricks are filled with rice husks. The "kiln" is left open at the top, and the fire is started from one side on the bottom. As the rice husks burn and settle, more rice husks are filled from the top. This type of firing may take several days.

pipe

Clay pipe has been used since ancient times for carrying both fresh water and sewage. It also is used as stovepipe for cooking stoves, and as perforated pipe for drainage and irrigation.

Ceramic pipe can be made with diameters up to about 1 meter. It usually is produced in lengths up to one meter, as longer pipes are difficult to dry and fire without bending.

Additionally, a variety of special shapes are made: bends (elbows), tees, siphons, etc.

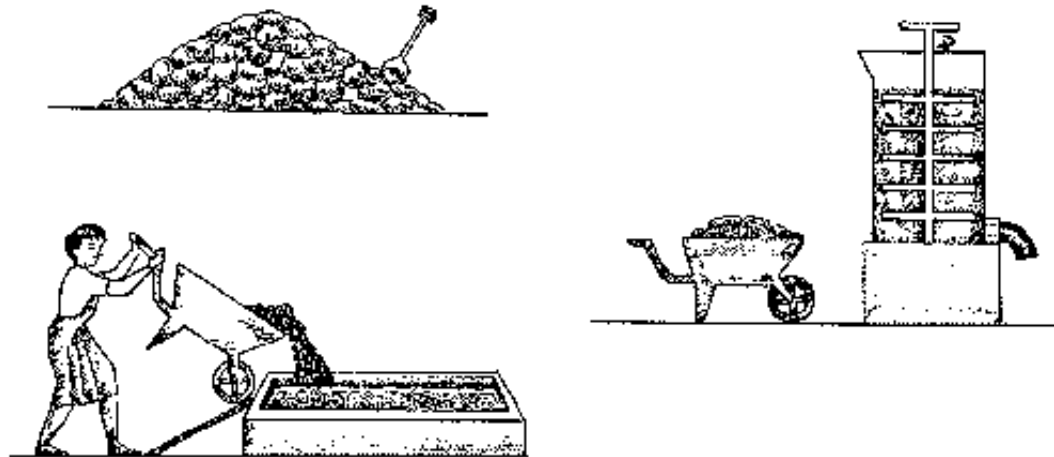

FIGURE 4.6.3-E Hollow brick work flow.(A; B; C)

A) Clay is stored in the open. If possible the brickwork is put up next to the clay pit.

B) Clay is soaked with water into the pug mill

C) Clay is mixed in a U-mixer or a drum mixer.This normally feeds directly.

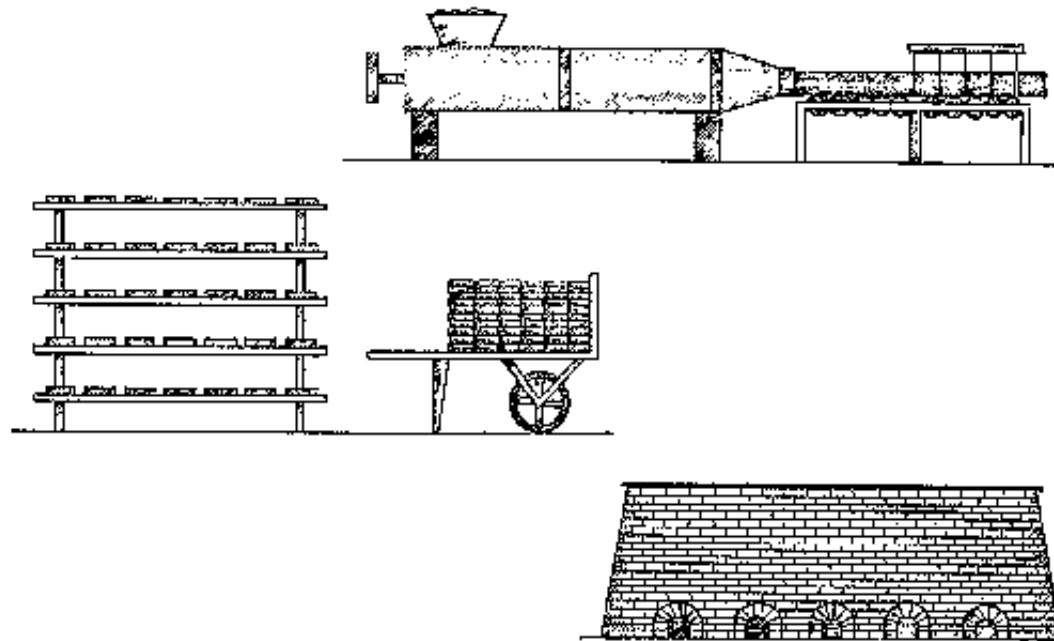

FIGURE 4.6.3-E Hollow brick work flow.(D; E; F)

D) The premixed clay is extruded onto a cutting table from where the cut bricks are taken for drying.

E) Soft extruded bricks are initially dried on boards and as soon as they can be handled they are dried in normal stacks.

F) Hollow bricks are fired in ordinary brick kilns

parts of ceramic pipe

- **Barrel:** This means the main tube of the pipe.
- **Flange:** This is the expanded end of the pipe, sometimes called the "collar".
- **Socket:** the inside of the flange

- Nipple: the small end of the barrel, which fits inside the flange.

pipe forming and appropriate products

wheel throwing

This is generally used for relatively thin pipe for stove chimneys, or for short distance, low pressure water lines. Pipes made this way are relatively rough, but quite suitable for these uses and can easily be made by traditional potters as a new product. (Smokeless stoves are very popular in development work, and provide new sources of income for traditional potters). These pipes are generally 10 to 15 cm in diameter, and are easily made 60 cm long.

The process is to make the pipe in 2 pieces, each about 30 cm long, on the potter's wheel. One piece is a straight pipe, and the other one is thrown with a flange on the top. The sections are joined when leather-hard.

These pipes are generally fired at low temperatures, using common clay and traditional firing systems. There is no reason, however, why they cannot be made from stoneware clay and glazed, where small quantities are required.

Average daily production: from 10 to 30 pieces.

slab construction on wooden moulds

This technique uses a wooden form shaped to the inside of the pipe. Slabs are prepared using any standard method (see slab construction, above) and then are wrapped around the form and joined. A special shaping device fits into the top of

the form, and by rotating it around the slab, the flange is finished.

These pipes can be used in the same way as hand-thrown pipe. They have the advantage of being more uniform than wheel-thrown pipes.

Average daily production: about 30 pieces, by 2 persons.

slab construction in plaster moulds

This uses a two-piece mould made from plaster of parts, or clay/cement (see moulds below). Rather stiff clay is made into slabs, and cut into two long strips which are fitted into the two halves of the mould. The edges are trimmed so that they come slightly above the edges of the mould. Then they are coated with slip and scratched. The two halves of the mould are placed together and pressure is applied. Then the seam is pressed together from the inside, using a sponge and the hands. If the clay is stiff enough, the mould can immediately be placed upright so the pipe sits on its small end (not on the flange). The mould is carefully removed and can immediately be used again. This is quite a fast process for an experienced worker.

This process is suitable for straight pipes, and also is commonly used for special fittings, such as bends.

More complicated shapes such as tees, Y-connectors, junction boxes and reduction fittings are usually made by piecing together sections of straight pipes that have been cut to the appropriate contour.

Average daily production: about 30 pieces.

extrusion

The standard industrial process for making stoneware sewage pipe and water pipe is by extrusion. This is done with rather heavy machinery, and depends on fairly large production quantities to make it profitable (starting from a minimum of about 8 tonnes per day). Therefore it is recommended only if there are a sure market and sufficient supply of raw materials. Additionally, sewage pipe because of its low profit margin tends to be produced for a fairly local market, since transportation cost over long distances is not competitive.

Because pipe manufacturing on this scale requires a major investment and specialized equipment, it is recommended that first the process be studied in an existing factory. Additionally, machinery manufacturers should be consulted for their recommendations, bearing in mind that they have a vested interest. Before deciding to order machinery, the wise producer will first visit other factories using their machinery and discuss problems with the operator. It is also important to find out about servicing the machinery. If your factory is far from the equipment supplier, you should make sure that the machinery can be maintained and repaired by local mechanics.

pipe production hints

There are variations in the work flow, depending on what kind of clay, firing system, etc., are used. For example:

- different clays require different grinding machinery. A hard, nonplastic clay usually requires a pan grinder to break it down. For this kind of dry grinding, the

type of pan grinder with a perforated pan works well, but a solid pan type may be a better choice, because it also can be used for wet or semi-dry mixing if necessary. For softer clays, a rotary hammer mill or pin mill of sufficient capacity will do a good job, as well as being cheaper.

- Screening: Since pipe clay is rather coarse, a rotary screen is sufficient for removing particles bigger than 16 mesh (standard insect screen can be used). This can easily be fabricated locally, is cheap and easy to maintain. Alternatively, a very simple vibrating screen can be used.

- An alternative to soaking the clay and then using a standard pug mill is to use a double shaft mixer (U-mixer), which mixes powdered clay body and water efficiently. However, a standard pug mill can be used for other purposes if desired - for example, for producing hollow bricks.

- The pipe extruding machine is really the only specialized machine required for this process. It is essentially a vertical extruder equipped with a die for the pipe barrel. It is equipped with a special die that first moves up under the extruder to form the pipe flange under pressure, then moves downward as the pipe barrel is extruded.

- A clutch system disengages the extruder while the pipe is cut or even just pulled off the machine. Then the flange die moves back into position under the extruder and another pipe is formed.

- The trimming and finishing machine is simply a rotating horizontal metal cylinder that fits the inside diameter of the pipe. A leather-hard pipe is pushed onto it, and

then is cut to the correct length with a special knife tool, that also makes grooves at the end of the barrel for gripping the mortar better.

- Drying the pipes is normally done in the open air, with the pipes lying vertically on the floor. It is important to rotate them several times a day, as they will bend if they dry unevenly. Factories located in monsoon countries have difficulty with drying during the rainy season. If a continuous kiln is used, it can be built under a high roof so that the top of the kiln can be used as a hot floor dryer. More sophisticated drying systems are normally not used, as they increase the cost of the pipes too much.

- Grog: Pipe clay body normally contains about 10 % grog. This grog is obtained from pipe that is damaged in firing, which in a successfully running factory is normally about 10 %. The grog can be made in the same pan grinder used for grinding clay body.

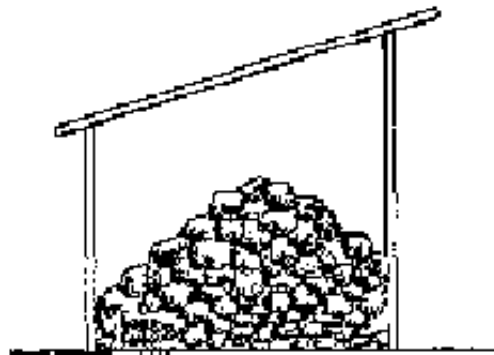

FIGURE 4.6.3-G Pipe extrusion work flow.(A)

A) Clay is stored dried.

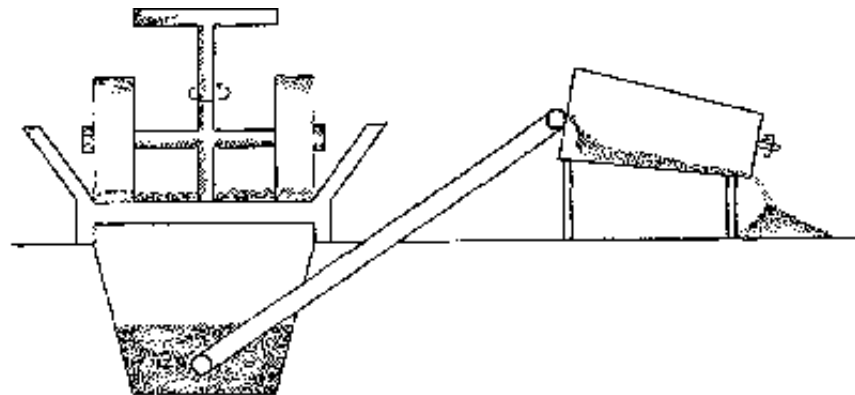

FIGURE 4.6.3-G Pipe extrusion work flow.(B)

B) Clay and grog are mixed and crushed in a pan grinder and then screened

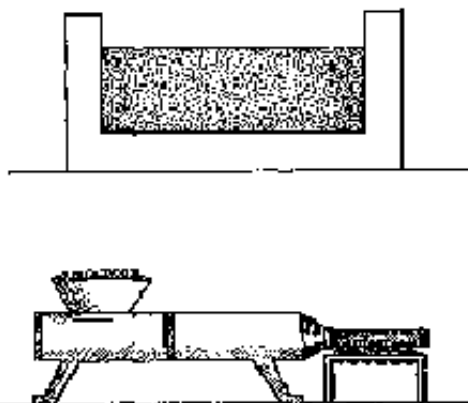

FIGURE 4.6.3-G Pipe extrusion work flow.(C;D)

C) The screened pipe body is soaked with water.

D) The soaked clay is premixed in a pug mill.

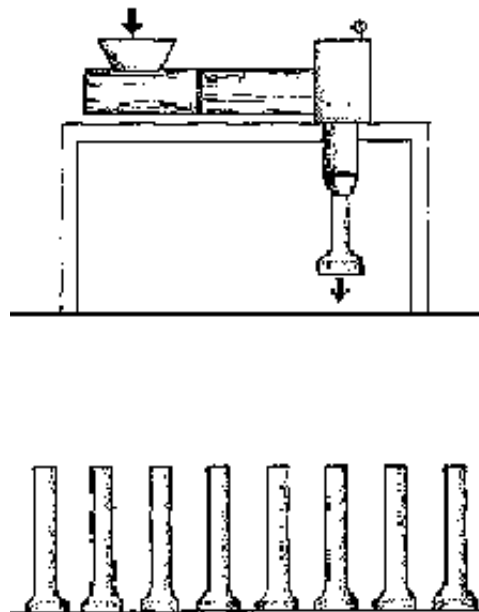

FIGURE 4.6.3-G Pipe extrusion work flow.(E;F)

- E) Combined horizontal pug mill with vertical extruder forms pipes with flanges.**
- F) The extruded pipes are left to dry until leather-hard.**

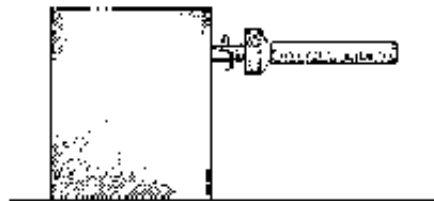

FIGURE 4.6.3-G Pipe extrusion work flow.(G;H)

- G) The leather-hard pipes are cut to size on a trimming machine.**
H) The pipes are left to dry in the open ,in a dryer or on top of the kiln.

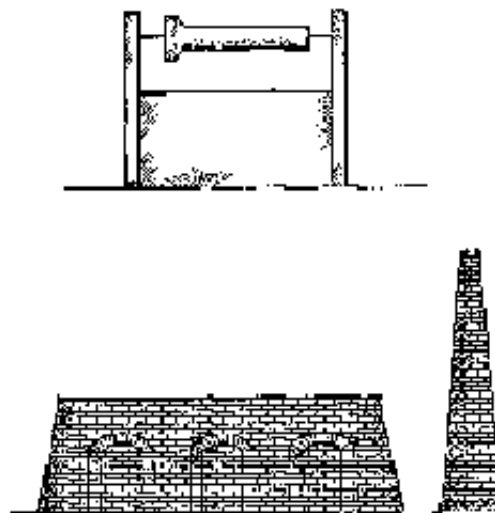

FIGURE 4.6.3-G Pipe extrusion work flow.(I;J)

- I) Before firing the pipes are glazed with a slip glaze.**
J) The pipes are fired to vitrification in special kilns.



[Home](#) > [ar](#).[cn](#).[de](#).[en](#).[es](#).[fr](#).[id](#).[it](#).[ph](#).[po](#).[ru](#).[sw](#)

 **Forming Techniques for the Self-Reliant Potter (GTZ, 1991, 194 p.)**

➔  **5. Semidry foaming**

 **(introduction...)**

 **5.1. Advantages and disadvantages**

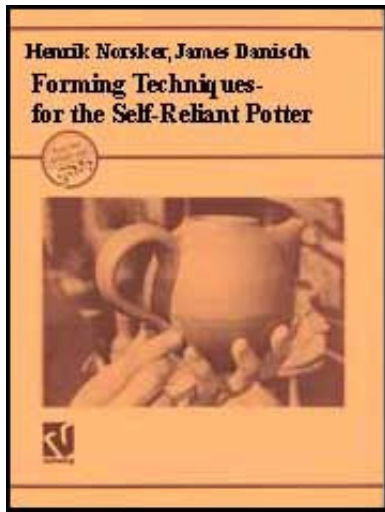

- 📄 **5.2. Press machines**
- 📄 **5.3. Semidry pressing with leather-hard clay**
- 📄 **5.4. Pressing with powder clay**

Forming Techniques for the Self-Reliant Potter (GTZ, 1991, 194 p.)

5. Semidry foaming

This type of forming is done with press machines, which work on the principle of applying high pressure to force the clay into a mould. Press moulding of soft clay is mainly used for forming roofing tiles with complicated interlocking shapes, but there are drawbacks with soft clay pressing: clay easily sticks to steel dies, the soft products are difficult to handle, high drying shrinkage causes warping and cracking during drying. Dies for soft clay pressing are often made from plaster provided with air holes so release is done by forcing compressed air through the mould.

Semidry forming processes were developed to reduce some of these problems associated with plastic clay forming.

Semidry powder pressing

Semidry powder means clay with 7 to 12 % water content that is prepared in powder form. The clay looks like powder, but when some of it is squeezed in the hand, it sticks together and holds its form. Because of this characteristic, semidry forming is limited to products that can be made under pressure in a mould or die, such as tiles, simple electrical articles (fuse holders, low tension insulators) and kiln shelves.

leather-hard pressing

Leather-hard means clay with about 15 % water content. It is prepared to approximately the final shape when plastic, then allowed to dry until leather-hard before pressing.

Semidry forming either requires beating by hand, or the use of a press machine with a metal die.

dry pressing

This uses clay with only 2 to 7 % water content. Because this requires great pressure, the machinery is too expensive for small producers.

5.1. Advantages and disadvantages

The major single user of semidry pressing is the wall and floor tile industry. Tile making is an attractive industry, as use is growing rapidly all over the world, and the market is increasing for exports from developing countries. Tiles at first glance seem a simple product to make, since they are just flat squares of clay. However, the big problem is keeping them flat and square through the various stages of

drying and firing, and keeping them the same size in firing (unless the temperature is perfectly even, there will be differences in firing shrinkage).

In order to reduce these problems as much as possible, there is clearly an advantage in semidry pressing, which at least prevents most drying shrinkage problems.

large tile industries:

However, as mentioned in the introduction, the small producer cannot compete with highly-automated, large-scale industries. The state of the art for large-scale wall tile production is based on using local red-firing clays, automatically dry pressing them under tremendous pressure, and then fast-firing them (under 45 minutes) in roller hearth kilns. Very accurate temperature control produces accurately-sized tiles, with a very small rejection rate. These production lines are often computerized, and all the handling of tiles is done on automated conveyor belts - even grading and selecting and packaging of the finished products.

market niches:

This leaves the small tile producer with the possibility of other market niches, such as hand-decorated tile (relief, engobe, underglaze, overglaze) and especially unglazed floor and wall tile made from local red-firing clay. These tiles can be produced with relatively inexpensive machinery, and periodic kilns can be used for firing with profitable results. Semidry pressing is then feasible (either powder or leather-hard system). Marketing can be aimed either at the local construction industry, or at the specialty export sector.

Nowadays in developing countries, there is a rapidly growing middle and upper class that is interested in adding status to their homes. This means that there is a growing market for items like tiles for the outside of houses, either glazed or unglazed, facing bricks (which are tiles made to imitate good quality bricks), floor tiles for interior and exterior, and even glazed roofing tiles. All of these are made by semidry pressing.

Because the work flow for semidry pressing is very different from plastic clay, and different clay preparation machinery is used, it usually is not combined in the same factory as plastic clay forming, or else a separate section of the factory is set up exclusively for this process.

electrical insulators:

For making simple electrical goods like fuse holders, where a nonhollow form is required, semidry pressing is also the method of choice. Hollow electrical goods are generally slip-cast. A successful fuse holder factory can make use of cottage industry, as described in the introduction. By only producing clay body and firing finished goods, this type of industry reduces labor problems and factory space, by simply purchasing the unfired fuse holders.

5.2. Press machines

5.2.1. DIES

5.2.2. HAND-OPERATED SCREW PRESS

5.2.3. FRICTION PRESS

5.2.4. TOGGLE PRESS

5.2.5. ECCENTRIC PRESS

5.2.6. SIMPLE LEVER PRESS

5.2.7. HYDRAULIC PRESSES

Because press machines are needed for most of these products, this section will describe various types that are available.

5.2.1. DIES

All press machines depend on a mould, which, because of the heavy pressure used, is made of steel. This type of mould is called a "die".

tile dies

Inexpensive dies are made from mild steel, which is easy to machine but does not have a long life (1-2 months for dies that are used daily). They are suitable for very simple tiles that do not have details like curved edges, and for small pressings like fuse holders.

Better dies are made from hardened steel, and are correspondingly expensive. They make up for their cost by having a long working life, and can be machined to have sophisticated rounded edges.

A set of dies consists of a top die, also called a plunger, and a bottom die. The bottom die is shaped like a shallow box. It has a metal frame of mild steel which makes up the sides, and in good dies, this frame is removable from its support, which is designed to fasten to the base of the press. The frame wears down after many thousands of pressings, and periodically must be replaced. The floor of the

die can slide up and down in the frame, and is provided with a lifting device that fits into it from the bottom. After pressing a tile, the lifter is operated, and the tile is raised up to the level of the frame for easy removal.

The top die is fitted to the screw in such a way that it does not rotate. Correct alignment of top and bottom dies is EXTREMELY important, as an expensive die can be damaged beyond repair very easily. If the press is operated without any clay in the die, this will also damage the die.

In some tile dies the frame is lifted for releasing the pressed tile instead of the bottom plate. This arrangement is used on the friction press in Fig. 5.2.3-A.

pressure requirements

The size of tile that can be powder-pressed depends on the amount of pressure applied. One source¹ gives the following data:

dry	2-7 % water	300-500 kg/cm ²
semidry	9-12 % water	100-250 kg/cm ²
plastic	15-20 % water	100-150 kg/cm ²

Successful pressing also depends on the type of clay body used, and needs to be tried out.

Standard friction presses are rated at 40 to 80 tonnes total pressure. This equals 80000 kg force applied to the die. Because the pressure of the die is distributed across the total area to be pressed, the kg per square centimeter will be less with

larger dies. For example, a tile die measuring 15 cm x 15 cm has an area of 225 cm². Then:

$$40000\text{kg}/225\text{ cm}^2 = 178\text{ kg per cm}^2$$

This may not be sufficient pressure to produce a strong 15 x 15 cm tile.

However, a tile die measuring 10 x 10 cm has an area of 100 cm². Then:

$$40000\text{kg}/100\text{cm}^2 = 400\text{ kg per cm}^2$$

This would make a compact and strong tile on the same press.

For smaller tiles, dies capable of pressing up to 4 tiles at the same time can be made.

other dies

Dies for fuse holders and other small shapes sometimes are fairly complex, and are made from mild steel by machining. They often have removable pins for producing necessary holes in the pressing. These pins are removed after each pressing, and replaced for the next.

Dies are also used for pressing "thimbles" small devices for separating tiles during firing.

Large dies are used for pressing saggars, firebricks, and items like flowerpots.

semiautomatic presses

For semi-automatic production, presses are equipped with rotating heads that have up to 6 bottom dies. As one die is pressed, the next one is being filled, and the previously-pressed tile is removed. This increases production quantities greatly. This type of press is often used for roofing tiles.

manual forming

For making kiln shelves (setter slabs), powder clay is used in a metal frame, which is made from reinforced angle iron. It is fitted with a sheet metal bottom plate. This is not used in a press machine, because the size requires more pressure than ordinary presses can supply. Instead, the clay is beaten into the frame by hand (see kiln shelves, below).

5.2.2. HAND-OPERATED SCREW PRESS

This machine uses a long screw to supply pressure to a metal die. The screw turns in a brass bearing, and the quality of this bearing determines the usefulness of the machine. The machine is available in a variety of sizes, and depends on a heavy hand-turned flywheel to supply the necessary pressure.

teamwork

It is quite a heavy machine, and must be fixed to a foundation to keep it from shifting in use. This type of press can be used for any product, with either powder or leatherhard clay. Small screw presses are used for tiles, and have a two- or three-man team: one man manages the clay and die, and the other two turn the flywheel. The largest sizes press saggars and firebricks, and may have as many as

3 workers turning the flywheel, while two workers manage the clay and heavy die.

production capacity

Daily production figures quoted from Europe (8-hour day) can be up to 2000 tiles, or one every 14 seconds. This is with a very experienced and motivated work crew. An inexpert crew might manage half that amount. It also assumes that there are no delays, such as lack of clay, machinery breakdowns, etc.

5.2.3. FRICTION PRESS

This is simply a motorized version of the screw press, which has two movable "friction wheels" which can be moved horizontally. These wheels are driven by a motor through a belt system, and in one position move the press down, and in the opposite mode move it up. They are usually made of cast iron or mild steel, and the flywheel is provided with a leather or fiber surface (the same as used for flat belt drives) which provides the necessary friction.

80-tonne press

Friction presses also come in a variety of sizes. They normally are rated according to "tonnes", which means the amount of tonnes/force they can supply. A common size for up to 15 by 15 cm tiles is "80 tonnes". This size of press commonly uses a 3-5 HP 3-phase motor. Larger presses are available. Friction presses do not necessarily apply more pressure than hand screw presses. The advantage is that they do it with less manual labor.

When selecting any screw press, it is important to be sure that it has sufficient

stroke length. This is the distance the top die travels from top to bottom of each stroke. For pressing saggars, there needs to be enough distance to remove the sagger easily.

Typical production figures for friction presses with inexperienced workers are about 125 presses per hour (double stroke).

Friction presses are often equipped with double bottom dies. In this system, the dies slide back and forth, so that one is being pressed while the other is emptied and refilled. This greatly increases production quantities.

5.2.4. TOGGLE PRESS

The toggle press is used for light pressing, such as fuse holders and other very small items. It works on a rack and pinion gear principle.

5.2.5. ECCENTRIC PRESS

The eccentric press is also commonly used for tile production, but only with leatherhard clay. It works on the principle of an eccentric shaft which rotates and activates a piston on which the die is mounted. This supplies a very high mechanical advantage, so high pressure can be supplied with a relatively small motor. However, it has the drawback of a short stroke length. For leather-hard tiles, it is an efficient and low-cost machine. It cannot be used for powder pressing, because it is too difficult to fill the die.

5.2.6. SIMPLE LEVER PRESS

There are two types of lever press which can be used for pressing soft clay, as for tiles with relief designs. These are used for low production, custom-made tiles.

lever press

One is simply a long lever arm attached to a fulcrum, with a plaster mould or a metal die connected. A slab of clay is placed on the table, the mould is pressed into it, and excess clay is then trimmed from the sides.

ratchet press

The other type uses a mechanical principle which is the same as an automobile jack, except that it is operated by a lever arm rather than a screw. Mechanical advantage comes at the top of the stroke, where rather high pressure is obtained. This is also used with plastic clay.

soil block press

Another type of lever press is commonly used for pressing soil blocks for house construction. There are many variations on this, with the original known as the "Cinva-Ram". This type of press could be used for firebrick pressing, and even for tiles, but those who have tried it say that it is slow and produces uneven work.

5.2.7. HYDRAULIC PRESSES

Hydraulic presses use hydraulic cylinders to provide pressure. They have the advantage of producing very high pressure, but also are very expensive, and unless specially equipped, are slower than friction presses.

hydraulic ram press

A specialized type of hydraulic press is known as the “ram press”. It uses plastic clay and special moulds made of hydrostone, that are fitted with air tubes to release the pressing. This was a patented process until recently, and only used in the U.S.

5.3. Semidry pressing with leather-hard clay

This process is used for all types of tiles floor, wall, and roof. The general work flow is shown in Fig. 5.3-A.

leather-hard clay requirements

Clay for leather-hard pressing varies according to the type of product. As usual, large tiles (such as roof tiles) should have a higher percentage of nonplastic materials like sand or grog added. The clay can be prepared by hand, or for larger production by machines (see chapter 4.1).

blanks:

As seen in the work flow, the first step is preparing “blanks”. A blank is simply a slab of clay, which can be made in a number of ways. Frequently, slabs are cut from a clay block using the sticks and cutting wire method. However, since the tile blanks should all be a uniform size, frequently a wooden or metal mould is used.

dry separator:

The mould is sprinkled with a dry separator, which usually is dry clay powder kept in an open-weave cloth bag (such as a jute bag). This is quickly done by shaking the bag in the mould. Then a piece of clay is pressed into the mould, and the excess is cut from the top with a cutting wire. The mould is inverted onto a ware board, so that the blank neatly falls out.

wet separator:

The water release method is also used, where the blank is formed in a metal frame with water used as a separator.

finishing:

The leather-hard tiles, after pressing, are set on ware boards to dry further. In some cases the edges of the tiles are made smooth immediately after pressing, but this may also be done just before firing. This process is called fettling.

warping:

During drying the tiles may need to be turned once or twice to avoid warping. When they are distinctly leather-hard, they are checked for warping. Warping can be corrected by placing the tile in a single bottom die, and gently beating it. They then are dried completely.

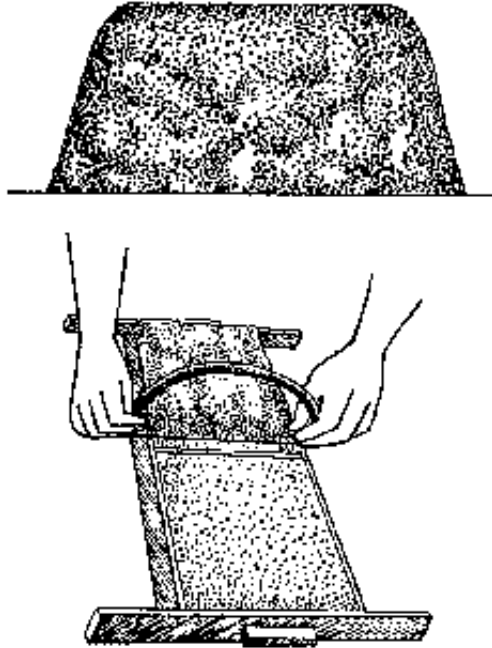

FIGURE 5.3-A Work flow for leather-hard pressing.(A; B-1)

**A) Plastic clay is taken from store.The clay is prepared as described in chapter 4.1.
B-1) Blanks are formed in a mould.Excess clay is cut off by a wire.**

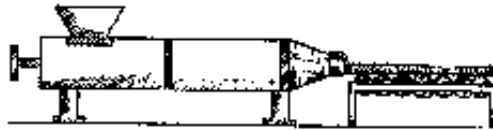

FIGURE 5.3-A Work flow for leather-hard pressing.(B-2)

B-2) Blanks can also be extruded and then cut.

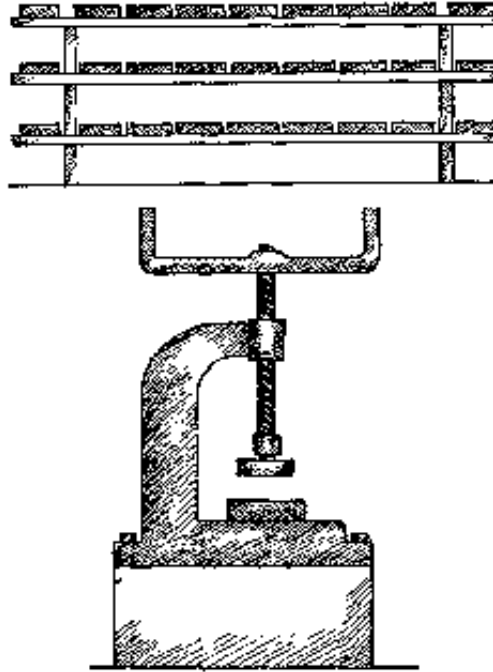

FIGURE 5.3-A Work flow for leather-hard pressing.(C; D)

- C) Blanks are placed on ware boards and left to dry until leather-hard.**
D) The blanks are taken to the press machine for pressing.

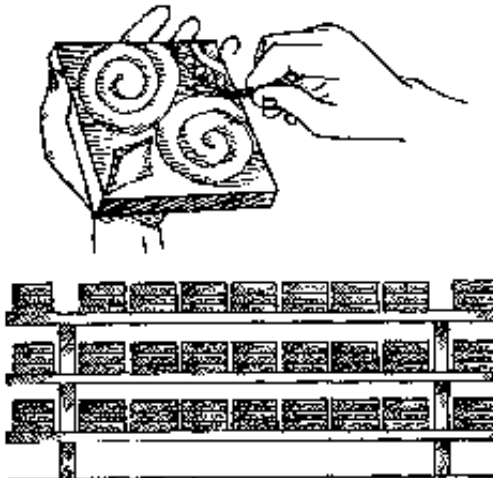

FIGURE 5.3-A Work flow for leather-hard pressing.(E; F)

- E) After pressing the tiles are placed on boards and then finished by hand.**
- F) Drying completely.**

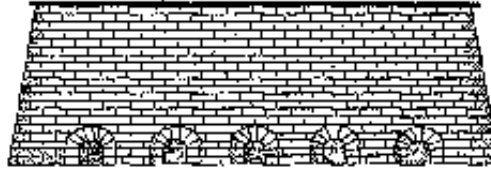

FIGURE 5.3-A Work flow for leather-hard pressing.(G)

- G) Kiln firing is started with a long smoking periccol.**

5.4. Pressing with powder clay

5.4.1. SEMIDRY POWDER PRESSING WORK FLOW

5.4.2. HINTS FOR SUCCESSFUL PRESSING

5.4.3. SAFETY SAFETY SAFETY !

5.4.4. PRESSING PROBLEMS AND SOLUTIONS

5.4.5. REFRACTORIES

As mentioned before, the advantage of pressing with semidry powder is that the pressed product is almost dry, and has almost no shrinkage, and thus minimum warping. Besides the actual pressing, the clay body needs to be specially prepared in the form of granules containing 6 to 10% water. Various methods for doing this are described below. The work flow for semidry powder pressing is:

5.4.1. SEMIDRY POWDER PRESSING WORK FLOW

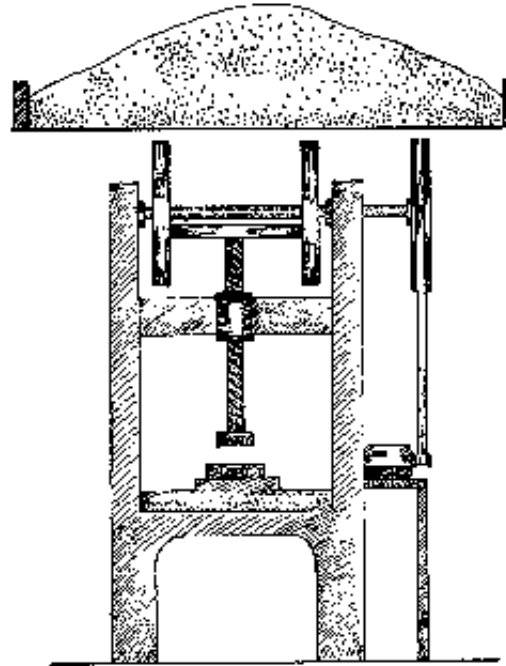

FIGURE 5.4.1-A Work flow of semidry pressing.(A; B)

- A) Granules of clay with right moisture content are taken from store to press machine.**
- B) Measured amount of body is filled in the die, leveled off and pressed twice.**

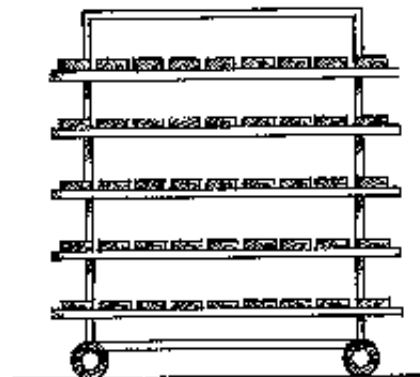

FIGURE 5.4.1-A Work flow of semidry pressing.(C)

C) The pressed tiles are placed on boards.

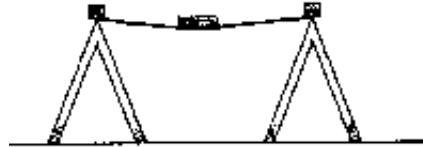
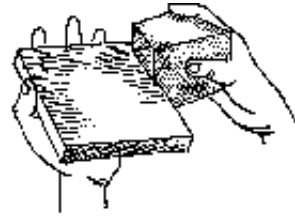

FIGURE 5.4.1-A Work flow of semidry pressing.(D)

D) Tile edges are fettled with a damp sponge or by moving the tile back and forth on a coarse screen

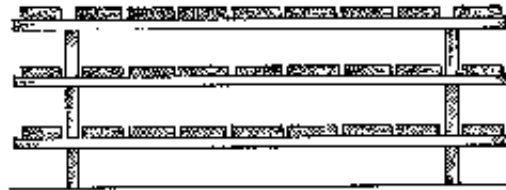

FIGURE 5.4.1-A Work flow of semidry pressing.(E; F)

- E) The tiles are dried completely.**
- F) Firing after a long soaking period.**

granulation

There are three main processes for preparing clay granules, with the following work flows:

- DRY PROCESS

This is the simplest of the processes in terms of equipment required and number of steps taken.

Many variations in this work flow are possible. The optimum process depends on the nature of the clay, the force of the press and the size and shape of the tile. It may be possible just to grind the clay, adjust its moisture content and then press it. Granulation can also be done in a pin mill without a screen. The pan mill and the final screening to remove the fines may be left out if the press body does not tend to cause lamination. Granules can also be produced in a pan mill with perforated bottom. The mixing can be done in the pan mill if this is operated in batches instead of continuously.

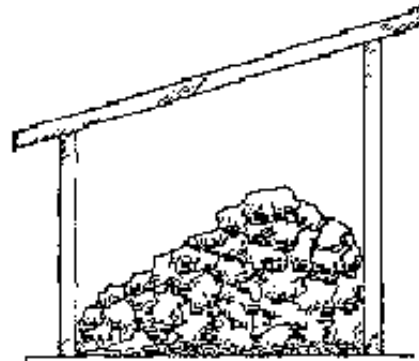

FIGURE 5.4.1-B Work flow of dry process granulation (A)

A) Clay from storage.

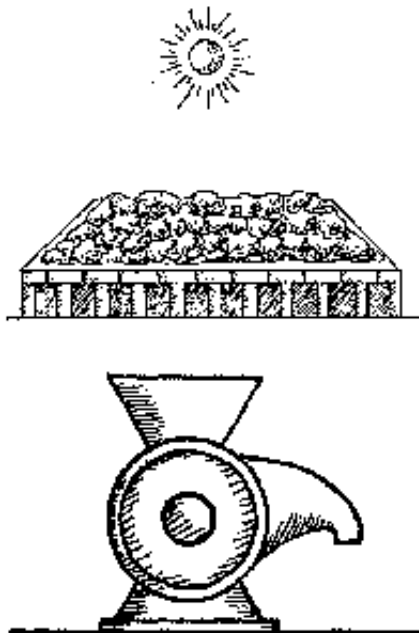

FIGURE 5.4.1-B Work flow of dry process granulation (B; C)

B) Clay is dried to less than 10% moisture content.

C) Clay is powdered in a hammer mill or pin mill.

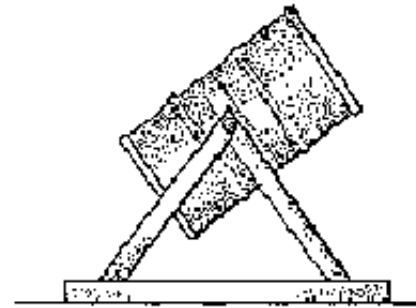
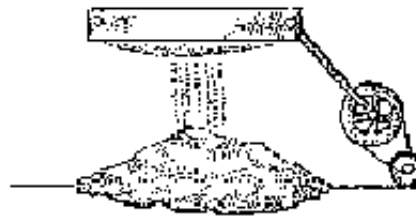

FIGURE 5.4.1-B Work flow of dry process granulation (D; E)

D) Powdered clay is screened. This may not be necessary.

E) Clay is mixed with possible other materials in a drum mixer or with a shovel.

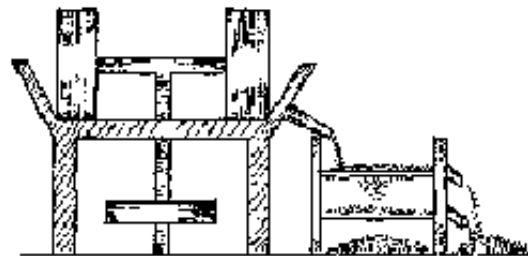

FIGURE 5.4.1-B Work flow of dry process granulation (F; G)

F) Clay body with addition of water is mixed in a pan mill

G) Screening through 10 mesh and 40-60 mesh. Material coarser than 10 mesh and finer than 40-60 mesh is returned to the pan mill.

**FIGURE****FIGURE 5.4.1-B Work flow of dry process granulation(H)**

H) Granules with a moisture content slightly higher than needed for pressing are left to mature for several days.

**FIGURE 5.4.1-B Work flow of dry process granulation(I)**

I) Moisture content is checked before pressing. Granules are taken to press machines

- WET PROCESS

This starts with the standard wet process of preparing clay (see chapter 4.1.2). Following that process the plastic clay is here used as the starting point of the granulation process.

Although complicated and requiring expensive equipment (filter press, blunger,

agitator, diaphragm pump) this prepares reliable body that works with any suitable body composition.

spray drying

Clay body is first prepared as in the wet process, but instead of being pumped into a filter press, it is pumped into a spray drying tower, where it is sprayed into a stream of hot air that dries it to the correct moisture content, as well as producing more or less spherical granules. It then goes directly to the press. This is the state of the art system which is appropriate only for relatively large-scale industries, due to cost and sophistication of the machinery.

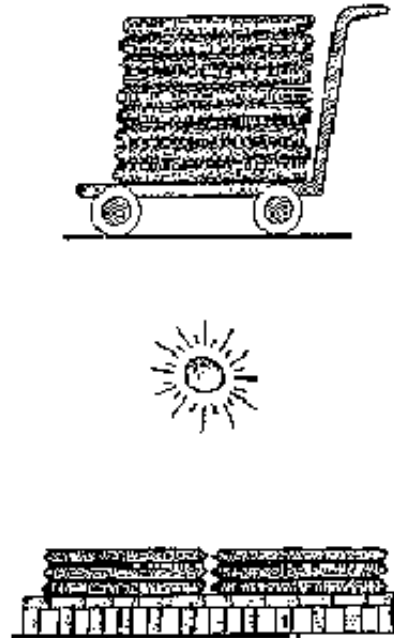

FIGURE 5.4.1-C Work flow of wet process granulation (A; B)

A) Clay cakes are taken from filter press to drying area.

B) The clay is air-dried to a water content slightly higher than needed for pressing.

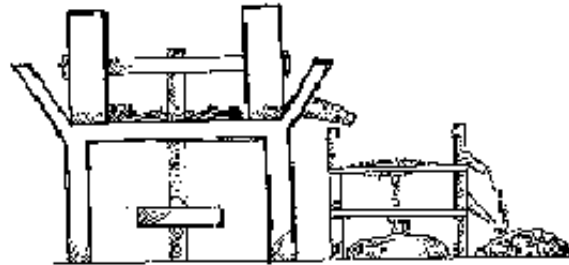

FIGURE 5.4.1-C Work flow of wet process granulation (C)

C) The clay with a water content of 10 - 15% is granulated in a pan mill or pin mill.



FIGURE 5.4.1-C Work flow of wet process granulation (D)

D) Granules are matured for a few days until the moisture content is correct.



FIGURE 5.4.1-C Work flow of wet process granulation (E)

E) Moisture content is checked before taking the granules to pressing machines.

5.4.2. MINTS FOR SUCCESSFUL PRESSING

There are some aspects of the process which are worth discussing in detail, as they are problems that have come up in our experience and that are not discussed in available books.

granulating

The main purpose of granulating is to get the clay particles into coarse condition, so that they consist of small "clumps" or "balls" of clay body larger than 40 to 60 mesh. This is important to prevent lamination problems (discussed in pressing, below).

Granulating is not necessary for all clay bodies. Generally, bodies which are fairly coarse - containing coarse fireclay and grog (ranging approximately up to 30 mesh) - can be dry-blended and then mixed with the correct amount of water. With such easy-to-press bodies, the water is usually estimated by volume, and is sprinkled evenly into the dry body while stirring and turning it with a shovel. It is correct when body squeezed in the hand holds its shape.

A simple form of granules can be produced by adding all water to the grog which is then mixed with the dry clay body. The clay will stick to the grog and form small granules and at the same time the water will be distributed evenly.

The body is often mixed with kerosene oil about 1-2% (sometimes up to 5% is necessary) as well as water, which prevents sticking to the die. This type of body may also press successfully without maturing, although it is always better to

mature clay before forming it. Both green and fired strength of the pressed tile increase considerably if the body is allowed to mature for some days.

Bodies that contain high amounts of fine clay (ball clay, clay high in montmorillonite), or slippery materials such as some kinds of talc, cause greater problems for powder pressing, and require granulation. For tiles, this is corrected in two ways: by adding grog to the body, and by adding wetting agents (soap) to the water.

pressing work flow

Pressing itself has a fairly complicated work flow:

- Inspection: Checking that die is clean. Clay tends to stick to the die, and needs to be removed with a stiff brush (fiber or brass wire type) periodically.**
- Lubrication of die: The die needs to be lubricated periodically with light oil to prevent clay from sticking. Frequency of lubrication and type of oil that is successful depend on the clay body. Commonly used oils are kerosene, diesel oil, waste crankcase oil (either plain or thinned with kerosene), coconut oil, palm oil thinned with kerosene, etc. This can be applied with a piece of cloth.**
- filling the die: In order to get the same thickness of tile every time, the die must be filled the same amount. This is done by adjusting the bottom plate, so that when filled to the top and levered, the tile is the correct thickness. It is easy to make a filling device, which is simply a metal or wooden frame that contains clay powder. Sliding the frame over the bottom die automatically fills the die, and sliding it back on the press table scrapes the clay level.**

- **pressing stroke: With coarse bodies, it is possible to press only one time. However, with most bodies, two pressings are required for each tile. The first press stroke is done rather slowly - its purpose is to allow air to come out of the clay powder. Then, a second press stroke is done rapidly, which fully compresses the clay.**
- **lifting the bottom die: This is done as the top die is raised to its highest position.**
- **removing the tile: The tile is lifted carefully from the die, and placed on a ware board. If the bottom die is plain, without relief pattern or rounded edges, the filling frame can be used to push the tiles to the other side, where it is picked up by an assistant or by a conveyor belt.**

5.4.3. SAFETY SAFETY SAFETY!

ALL PRESS MACHINES ARE DANGEROUS! It is very easy to lose a finger or even a hand. Workers need to be instructed in correct use of the machine. The main point is that BOTH HANDS MUST BE USED TO PULL THE PRESS LEVER, so that there is no chance of having a hand under the die. It is much safer for the same person who fills the die to also pull the press lever. If two persons are working with the press (as is common with presses having two sliding dies), there needs to be a system of signaling between the workers.

safety switches

Many countries now have safety regulations for workers using dangerous machinery. It is common for press machines to be equipped with two switches,

which must be held down in order for the press to move -one is on the press lever, and the other is located some distance away so that both hands are out of the way before the machine will operate. This is difficult to do with a friction press, but it is highly recommended that the manufacturer be required to equip his machinery with such a safety device.

dust

Semidry bodies produce a lot of dust during body preparation and during pressing and fettling. Inhalation of clay dust over a long period of time will damage the lungs. Therefore, workers should be equipped with dust masks and good ventilation is needed in work areas.

5.4.4. PRESSING PROBLEMS AND SOLUTIONS

lamination problem

The main problem with powder pressing is lamination in tiles, which means that the tile will split apart in horizontal layers. These layers are caused mainly by sideways slipping of the clay under pressure, which causes clay particles to line up in the same direction and not to get good adhesion. It is made worse when air cannot escape quickly enough from the body, which also causes separation of clay layers. Another factor in lamination is suction caused when the die is lifted: if the die does not release easily from the clay, it will actually tear the tile apart.

Lamination can be difficult to cure. Possible solutions that can be tried are:

- Changing the clay body, which means reducing the amount of slippery

substances such as talc, or changing the type of talc from “plate-type particles” to “rough particles” (there are many varieties of talc), or using talc with a rougher particle size.

- Adding coarser clays and/or grog, which gives the clay more “tooth” and helps prevent it from slipping.**
- Adding organic binders, such as starch, sugar, CMC gum.**
- Adding wetting agents to the water, such as liquid soap, or sodium lauryl sulfate (which is the common wetting agent in liquid soap).**
- Maturing the clay for a longer period.**
- Changing from dry clay processing to the leather-hard method.**
- Prepressing the clay body into bricks or blocks (with a slightly higher water content), then drying them to the necessary water percentage, and breaking and granulating them.**
- increasing the granule size.**

cracking problem

Cracking of tiles normally only shows after firing. Its main cause is lamination. Other causes: the green strength is too low to withstand stresses from handling and drying. The cure is to increase: thickness of the tile, moisture content of press body, the proportion of plastic clay, the pressing force or maturing time of body.

The pressure can be increased by reducing the size of the tile, by increasing the speed of the flywheel or by pressing and extra time.

- Uneven thickness is corrected by ensuring that the same amount of clay is used for each tile, by keeping moisture content constant, and by applying the same pressure to each tile.

- Crumbling corners are caused by too low moisture content, by attempting to press too thin tiles, by lack of pressure or by uneven filling of the die.

- Top center section separating from the rest of the tile is a form of lamination. The pressure in the center is always less than at the edges, where the clay powder is better compacted when the material bounces back from the die frame. The cure is to strengthen bonding by increasing moisture content and if that is not sufficient by granulating the press body.

5.4.5. REFRACTORIES

Kiln shelves (sometimes called setter slabs) for low and medium temperatures can be made from a simple body of 50% fireclay and 50% grog (with the dust fraction removed). This is prepared by blending by hand with about 10% water- as described above, a small amount squeezed in the hand will stick together and hold its shape. This is aged for at least 24 hours, and then is filled into the metal frame described in dies, above. The clay is beaten with a wooden mallet, taking care to beat it well into the corners. More clay is added, and again beaten until the frame is filled level and the clay is as compressed as possible. Then the frame is turned over, and the opposite side is also beaten thoroughly. The shelf is removed from

the frame, and set aside for drying.

Other refractory products for kiln construction can be made in a similar way. Fig. 5.4.5-A shows a die and moulding table for production of large refractory firebricks. A similar system could be used for kiln shelf production.

Sufficient beating is very important, in order to closely pack all the clay particles. This makes a shelf that will not easily bend in firing or crack during handling. Standard press machines do not provide enough pressure for the large surface area of kiln shelves (an 80-tonne press used for a 30 x 30 cm shelf can supply only 88 kg per cm²). For more information on making refractories see "The Self-Reliant Potter: Refractories and Kilns" also in this series.

