



➔  **Glazes - for the Self-reliant Potter (GTZ, 1993, 179 p.)**

 **(introduction...)**

 **Acknowledgements**

 **1. Introduction and scope**

 **(introduction...)**

 **1.1. Glaze making using local materials as far as possible**

 **1.2. Glaze and clay systems**

 **2. The nature of glazes**

 **2.1. Glass and glaze, benefit of glaze**

 **2.2. Glaze making is difficult**

 **2.3. History of glazes**

 **2.4. Classification (earthenware, stoneware etc.)**

 **3. Temperature ranges and requirements**

 **3.1. What is temperature?**

 **3.2. Low temperature range 900-1100°C**























 **3.3. High temperature range 1100-1300°C**

 **3.4. Firing systems and glaze effects**























 **4. Decisions**























 **(introduction...)**























 **4.1. Selecting your best firing temperature**

-  **4.2. Market factors**
-  **4.3. Strength requirements**
-  **4.4. Investment and production costs**
-  **5. Simple glaze theory**
  -  **5.1. Basic chemistry**
  -  **5.2. Glaze structure**
  -  **5.3. Effect of heat**
  -  **5.4. Melted glaze behavior**
  -  **5.5. Interface between glaze and body**
  -  **5.6. Cooling and crystal formation**
  -  **5.7. Transparency and opacity**
  -  **5.8. Shiny or matt glaze**
-  **6. Obtaining glaze materials**
  -  **6.1. Materials suppliers**
  -  **6.2. Materials from natural sources**
  -  **6.3. Other sources of materials**
  -  **6.4. Storing, packaging and labeling**
-  **7. Frits and fritmaking**
  -  ***(introduction...)***
  -  **7.1. Why make frits?**
  -  **7.2. Frit production**
  -  **7.3. Frit kilns**



-  **Preparation of glazes**  
*(introduction...)*
-  **8.1. Raw materials requirements**
-  **8.2. Grinding glaze materials**
-  **8.3. Weighing, mixing, using batch cards**
-  **8.4. Sieving**
-  **8.5. Suspending and binding agents**
-  **8.6. Density specific gravity**
-  **8.7. Old glazes, problems**
-  **8.8. Test your glazes!**
-  **8.9. Commercial production of glazes**
-  **9. Glaze application**
  -  *(introduction...)*
  -  **9.1. Work place, cleaning area**
  -  **9.2. Application methods**
  -  **9.3. Density, binders, glaze thickness**
  -  **9.4. Waxing**
  -  **9.5. Single-fire glazing**
  -  **9.6. Handling, drying before firing**
  -  **9.7. Salt glazing**
-  **10. Decoration**
  -  *(introduction...)*
  -  **10.1. Decoration and design**

-  **10.3. Glaze decoration**
-  **10.3. Engobe decoration**
-  **10.4. Terra sigillata**
-  **11. Glaze problems**
  -  *(introduction...)*
  -  **11.1. Introduction to glaze problems**
  -  **11.2. Trouble-shooting checklist**
  -  **11.3. Specific problem explanations**
-  **12. Developing glazes**
  -  *(introduction...)*
  -  **12.1. Modifying existing glazes**
  -  **12.2. Basic equipment**
  -  **12.3. Testing methods**
  -  **12.4. Developing a base glaze**
  -  **12.5. Modifying a base glaze**
  -  **12.6. Colored glaze**
-  **13. Glaze oxides**
-  **14. Quality control**
  -  *(introduction...)*
  -  **14.1. Raw materials control**
  -  **14.2. Glaze preparation control**
-  **15. Health and safety**
  -  *(introduction...)*

-  **15.1. Machinery**
-  **15.2. Dust**
-  **15.3. Toxic materials**
-  **16. Glaze formula calculations**
  -  **(introduction...)**
  -  **16.1. Glaze formula chemistry**
  -  **16.2. Seger formula**
  -  **16.3. Frit calculation**
-  **Appendix**
  -  **Glaze Recipes**
  -  **Color Pigments**
  -  **Ceramics Elements and Oxides**
  -  **Common Glaze Raw Materials**
  -  **Chemical Analysis of Glaze Materials**
  -  **Table of Standard Sives**
  -  **Table of Seger Cone Formulas**
  -  **Table of Seger Cones**
  -  **Table of Orton Cones**
  
  -  **Conversion Table for Pint Weights**
  -  **Density**
  -  **Dry content of a liquid**
  -  **Twaddell scale**
  -  **Properties of fuels**



## Metric system Temperature conversion formula



## Bibliography



[Home](#) > [ar](#).[cn](#).[de](#).[en](#).[es](#).[fr](#).[id](#).[it](#).[ph](#).[po](#).[ru](#).[sw](#)



### **Glazes - for the Self-reliant Potter (GTZ, 1993, 179 p.)**



#### **(introduction...)**



#### **Acknowledgements**



#### **1. Introduction and scope**



#### **2. The nature of glazes**



#### **3. Temperature ranges and requirements**



#### **4. Decisions**



#### **5. Simple glaze theory**



#### **6. Obtaining glaze materials**



#### **7. Frits and fritmaking**



#### **8. Preparation of glazes**



#### **9. Glaze application**



#### **10. Decoration**



#### **11. Glaze problems**



#### **12. Developing glazes**



#### **13. Glaze oxides**



#### **14. Quality control**



-  **15: Health and safety**
-  **16: Glaze formula calculations**
-  **Appendix**
-  **Bibliography**

**Henrik Norsker, James Danisch**

**A Publication of the Deutsches Zentrum fr Entwicklungstechnologien - GATE in:  
Deutsche Gesellschaft fr Technische Zusammenarbeit (GTZ) GmbH - 1993**

***The authors:***











**Henrik Norsker has been making pottery since 1970. He left his pottery workshop in Denmark in 1976 to establish a pottery school in a village in Tanzania. Since then he has continued working in developing countries with promotion of small scale ceramics industries. Besides Tanzania he has been employed in ceramics projects in Burma, Bangladesh and Nepal.**

**James Danisch has been making, selling and experimenting with ceramics since 1963. He has taught college level ceramics in Scotland and California, and has conducted workshops in the US, South America and Canada. From 1984 to 1992, he has been working with small scale and rural ceramics development in Nepal. His articles on ceramics have been published in several magazines, and he has studied traditional and he has studied traditional and modern techniques in Europe, Nepal, India, Thailand, Burma, South America and Mexico.**





## **Glazes - for the Self-reliant Potter (GTZ, 1993, 179 p.)**

- ➔  **8. Preparation of glazes**
  -  **(introduction...)**
  -  **8.1. Raw materials requirements**
  -  **8.2. Grinding glaze materials**
  -  **8.3. Weighing, mixing, using batch cards**
  -  **8.4. Sieving**
  -  **8.5. Suspending and binding agents**
  -  **8.6. Density specific gravity**
  -  **8.7. Old glazes, problems**
  -  **8.8. Test your glazes!**
  -  **8.9. Commercial production of glazes**

## **Glazes - for the Self-reliant Potter (GTZ, 1993, 179 p.)**

### **8. Preparation of glazes**

**Glazes should be prepared in a systematic manner in order to prevent mistakes. Most problems with glazes come from simple things, like incorrect weighing, mistakes in identifying raw materials or not sieving the glaze correctly.**

**Glaze mistakes are expensive, as they can result in the loss of an entire kilnload. For this reason, it is important to have the right person in charge of making glazes**



**-cleanliness, orderliness, careful record-keeping, and reliability are required.**

**Most small producers do not need a large variety of glazes -in fact, many use only one or two standard glazes and achieve variety by changing the colors, doubleglazing or using engobe decoration.**

**Designing a glaze is somewhat like choosing a paint in the paint store. First of all, you must decide if you want a glossy or matt surface, transparent or opaque. Then you can add different colors.**

### **Base glaze**

**The base glaze is simply the combination of materials that melts at the desired temperature. It is either transparent or opaque, matt, semimatt, glossy etc. without any particular color**

### **Glaze additions**

**These are usually coloring oxides that are added to the glaze. In Nepal a glaze supplying system serving small producers was established. A base glaze was supplied in 5kg bags and 8 different colors were supplied in small bags that produced standard colors when added to 5 kg base glaze. The small bags contain coloring oxides mixed with a small amount of base glaze so the colors disperse more easily in the base glaze.**

### **8.1. Raw materials requirements**

**Raw materials need to be as reliable as possible and always ground to the same**

**mesh. If obtained from a glaze supplier, the materials are usually ground to at least 100 mesh. Because materials that are finely ground melt more easily, some ingredients may be as fine as 400 mesh. This is particularly true of quartz -200-mesh quartz will produce a different result than 400-mesh quartz.**

**When you get new raw materials, they always should be tested before using them in production. The best way is to try them in a standard glaze that you know well and to compare the results with the known glaze.**

## **8.2. Grinding glaze materials**

### **8.2.1. COARSE MATERIALS**

**There are several steps in grinding glaze materials. Since many of them (feldspar, quartz, limestone) come as rocks, they first need to be reduced to pebble size. Feldspar and quartz rocks are first calcined to make them soft enough to crush. Calcining means firing to just above 600°C. This can be done in the cold spots of a biscuit firing or for large productions in a special kiln. Crushing of small amounts can be done with a hammer (use eye protection), and large amounts are usually done in a jaw crusher.**

### **8.2.2. BALL MILLING**

#### **Ball mill operation**

**Ball mills are used for fine grinding of ceramic materials. The material has to be**

**reduced to sand size (2 mm or less) before grinding in a ball mill.**

**Some typical uses of ball mills are:**

- **grinding clay that does not easily slake**
- **preparation of casting slips**
- **grinding of body additions like feldspar, quartz and glass powder**
- **grinding of frit granules grinding of glazes**
- **grinding of engobes and terra sigillata**
- **preparing color pigments for glaze, engobes or bodies.**

**There are two main types of mills:**

- **Large mills with an axle system are called ball mills.**
- **Small mills are called pot mills or jar mills.**

**These are usually small (up to 5 liter) porcelain jars or plastic jars, which rotate on two rubber-covered rollers.**

**Conical ball mill**

**For large production conical ball mills are used. Various sizes of pebbles are used and the material is fed from one end and discharged at the other. Variation of the centrifugal force caused by a conical 30° slope at the discharge side classifies both pebbles and material so only fine material is discharged.**

**Vibro energy mill**

**This is a new type of grinding machine consisting of cylindrical grinding chamber suspended on springs and vibrated at high frequency with the help of an excentric mounted on an electric motor. The chamber is completely packed with very hard small cylinders between which the material is filled. The vibrations make the small cylinders grind against each other and the material to be ground. The vibrating mill is better at ultrafine grinding and is more energy-efficient than ball mills.**

## **Lining**

**The grinding action takes place between the pebbles, and not between the pebbles and lining. Therefore a ball mill with a steel drum can work without a lining (except for white body, where rust particles will cause discoloration). Pebbles constantly falling on a steel drum make a lot of noise. A lining will reduce the noise and at the same time prolong the life of the steel. Traditionally, linings are made of porcelain or stoneware bricks set in a cement mortar, using high alumina cement and coarse silica sand. Common cement can be used if necessary but may cause pinhole problems in glazes. The bricks should be dense and vitreous. A porcelain body for lining bricks and pebbles (fire to 1250°C or higher) is:**

China clay 40%  
Quartz 25%  
Feldspar 30%  
Bond clay 5%

**One type of brick is made concave to fit the curve of the drum and another type is made for the end walls of the drum.**

**Linings can be made from granite, quartzite or similar hard rocks (not limestone or marble). They are cut to shape and set in a high alumina cement mortar. They last far longer than porcelain bricks. Stoneware bricks can be used for the end walls, which are worn out more slowly.**

**Instead of a hard lining, thick rubber sheet glued to the inside makes a very long-lasting and quiet lining.**

## **Pebbles**

**Pebbles or balls can be made from vitreous clay bodies. However, it is often cheaper to collect stones of granite, quartz or quartzite along riverbeds. Flint, a variety of quartz, is excellent for pebbles. The hardness is tested with a penknife to make sure it is above 5.5 (see Mohs' scale). Pebbles of limestone are not satisfactory, as they contaminate the glaze. The shape should not be flat or elongated but spherical. (Cylinders of equal diameter and length are sometimes used to obtain particles with less variation in particle size.) Size should be between 2.5 and 5 cm in diameter.**

**Pebbles wear out, so occasionally take out all the pebbles for inspection. Those that are broken or flat should be discarded. In large mills, pebbles are removed when they are less than 2-3 cm. In small mills pebbles smaller than 1.5-2 cm are discarded.**

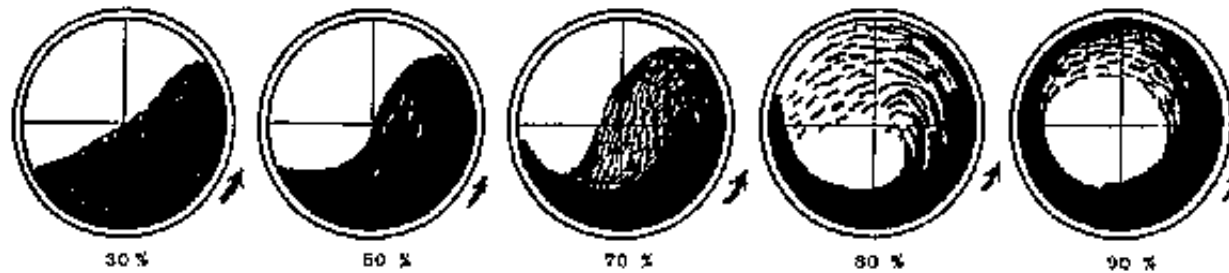

**Figure 8.2.2.E. A cross section of a ball mill running at speeds from 30-90% of critical speed. At 30% the grinding takes place mainly between pebbles and lining, at 70% a good cascading rolling produces efficient grinding, and at 90% very little grinding takes place.**

**As the pebbles grind down, they contribute a small amount of material to the glaze. Usually this is not enough to make a difference in the glaze. However, if you have glaze problems that cannot be traced to any other cause, the ball mill pebbles should be checked.**

### **Ball mill speed**

**Grinding of material takes place between the pebbles of the ball mill as they roll down the slope of the cylinder. If the speed is too high, the grinding action stops because centrifugal force stops the pebbles from falling.**

**This happens when the cylinder is running at its critical speed. Critical speed is calculated from the inside diameter of the cylinder:**

$$\text{Critical speed in rpm} = \frac{29.9}{\sqrt{r}}$$

**(r = internal radius in meters)**

**The actual speed of the ball mill should be 60 -80 % of critical speed. Small ball mills can be closer to 80 % and large ones closer to 60 % Appropriate speed can be read from Fig. 8.2.2.F.**

**The most efficient grinding is achieved when the pebbles roll as shown in the center ball mill of Fig. 8.2.2.E. The pebbles cascade in a steady stream, and grinding takes place between the pebbles. The speed of the ball mill at 80% is too high. The pebbles have started to fall freely and this causes excessive wear as the pebbles hit one another and the lining.**

**Unfortunately it is not possible to look inside during milling, but if the pebbles make a low, rumbling sound the speed is correct. If they make a loud banging noise, the speed is too high or there is too much water, charge or pebbles in the mill. Porcelain jar mills crack if they run at too high a speed.**

## Ball Mill Speeds

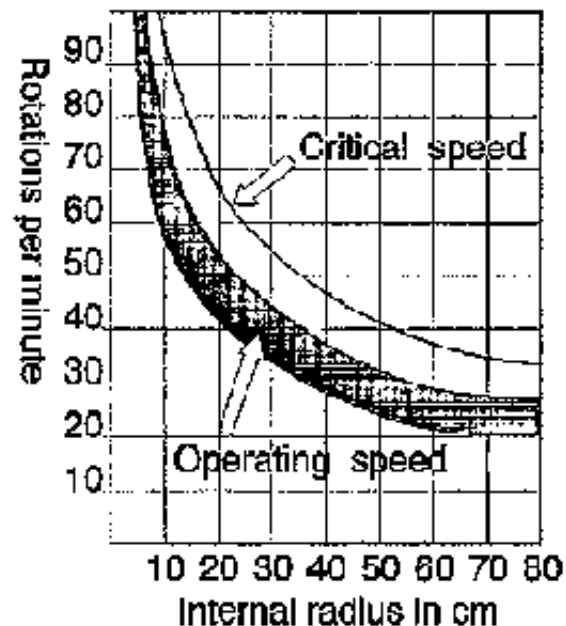

**Figure 8.2.2.F. Graph of ball mill speeds.**

### Charge

**With a speed of 60 -80% of critical speed the charge should be:  
(by volume)**

Pebbles: 45 -55 %

Water: 12 -20 %

Material: 20 -25 %

**When the mill is filled to maximum capacity, the speed should be closer to 60% of critical speed. The water content should be enough to produce a thin slip. After filling, about 30 % of the volume should remain empty. If you measure all the**



**materials separately, total volume may seem to be 85% of ball mill capacity. However, since the water and material fill the spaces between the balls, this will still result in 30% empty space.**

## **Example**

**A ball mill with new lining measures inside:**

**width 0.64 m, diameter 0.445 m**

volume of ball mill =  $\pi \times r^2 \times w \cdot \text{or} \cdot 320\text{liters}$

critical speed =  $\frac{29.9}{\sqrt{r}} \cdot \text{or} \cdot 52.8 \cdot \text{rpm}$

**60%-80%  
of critical speed = 31.7 rpm -42.3 rpm**

**Charge:  
(by volume)**

Pebbles 144-176 l.

Water 38-64 l.

Material 64-80 l.

**A typical glaze has a density (specific gravity) of approximately 2.7. That means that the glaze charge should be 24-30 kg.**

## **Ball milling time**

**The time for ball milling varies with the hardness of materials. Soft materials such as frits may require only 2-3 hours, whereas hard materials like quartz can take 24 hours or more.**

**When you ball-mill standard materials, it is important to mill each batch for the same amount of time. For this reason, it is a wise investment to purchase a timer switch for the mill. This will avoid human errors. Too much ball milling can cause glaze crawling.**

## **Operating procedure**

### **Before each operation:**

- 1) Check that the ball mill is clean inside.**
- 2) Check that pebbles fill half of the ball mill -refill if necessary.**
- 3) Fill in materials (20-25% of mill volume).**
- 4) Fill water until pebbles and material are just covered.**
- 5) Be very careful about correct ball milling time. If possible, use an automatic timer.**

### **After operation:**

- 6) After emptying the ball mill, clean it thoroughly with water by filling it and running it with the pebbles. If the same material is to be ground, cleaning is not needed.**

## **Every month:**

- 7) Empty the pebbles out and remove all pebbles that are too flat or less than 2 cm in diameter.**
- 8) Inspect the inside lining for signs of wear, and repair as necessary.**

## **8.3. Weighing, mixing, using batch cards**

### **Weighing glaze ingredients**

**First, you must have an accurate scale. This can be a small balance, such as is used by jewelers, or a triple beam balance, which is faster to use. Spring scales are not accurate enough, nor are postal scales. For large quantities, the most accurate low-cost balance is the common beam balance which uses standard weights.**

### **Batch cards**

**For best results, a batch card system should be used. These are simply cards that have the glaze recipe written on them. As each ingredient is weighed, it is checked off on the list. When all materials are weighed, the batch card is given a number (usually the date). The same number is written on the glaze container. This makes it easier to find out the problem when the glaze does not work correctly.**

**Glaze Batch Card**

Batch no. *24*... Date: *8/5/84*

Recipe:	Kg	Check
<i>Feldspar</i>	<i>16</i>	<input checked="" type="checkbox"/>
<i>Kaolin</i>	<i>1.0</i>	<input checked="" type="checkbox"/>
<i>Pyroxene</i>	<i>2.4</i>	<input checked="" type="checkbox"/>
<i>Cobalt oxide</i>	<i>0.2</i>	<input checked="" type="checkbox"/>
<i>Nickel oxide</i>	<i>0.1</i>	<input checked="" type="checkbox"/>

Ball mill no.: *2* Hours: ... *12*

Sieve mesh no.: *100*

Specific gravity: ... *1.7*

Testfired Date: *12/15*

Released for production: *Pitkram*



**Figure 8.3.0.B. Example of a glaze batch card used for quality control.**

## Water

The ingredients are then added to a container which already has the approximate amount of water in it. **CAUTION:** The water must always be clean. After mixing, the water is adjusted. It is always best to start with less water than required. If the glaze is too fluid, it is difficult to remove excess water.

## Containers

**Containers for glaze should be plastic or wooden. Metal containers cause contamination and rapid settling of glazes.**

## **8.4. Sieving**

**Glazes are normally sieved through a 100mesh screen. The glaze should be poured through without forcing it. Never use your hand to force glaze through a sieve, as this will quickly break down the wire mesh. A brush should be used instead.**

## **8.5. Suspending and binding agents**

**Because glazes are mixtures and not solutions, they tend to settle at the bottom of the container. Normally, the clay content of the glaze will be sufficient to keep them in suspension during application. However, some glazes tend to settle as a cement-like layer on the bottom and are difficult to stir. These glazes require the addition of a suspending agent.**

### **Suspending agent**

**The most common suspending agent is bentonite, in 1-2% additions. This will normally not be enough to affect the glaze when fired. Dry bentonite cannot be added to wet glaze, as it will just form lumps and be impossible to mix in thoroughly. Instead it should either be mixed separately with water into a thin slip and then added to the glaze or it should be added to the dry glaze and mixed in well before adding water.**

### **Binder**

**Another common problem is that some glazes tend to be powdery, and come off when loading the kiln. For this problem a binder is added.**

**Bentonite also works as a binder and is the simplest to use. Another common binder is CMC gum (carboxymethyl cellulose), which is available in either liquid or powder form. The liquid can be used directly, about 1%. The powder needs to be dissolved in water (1:10) overnight and then is added to the glaze as liquid.**

**Organic binders such as gum arable, wheat flour, sugar or starch (0.1-0.5% of dry glaze) are sometimes used. These have the disadvantage of fermenting. They should be used immediately after mixing, or if stored a few drops of chlorine bleach or formaldehyde can be added as a preservative.**

**Addition of 1% raw borax produces a hard surface that does not powder when painted on.**

### **Flocculation**

**Addition of a flocculation agent will make the glaze more creamy. The pottery will absorb the water more easily so glaze is picked up faster.**

**This works better in combination with clay or bentonite. Common flocculants are: Epsom salts (magnesium sulfate), calcium chloride, calcium nitrate and borax. They are prepared by adding 100 g flocculant to 200 ml hot water and the solution is added to the glaze one tablespoonful at a time (up to 1% of dry glaze weight). Plaster of parts (already set) can also be used.**

**Flocculation is also used for nonporous ware often in combination with a binder. The creamy glaze forms a thick loose layer that stays on the nonporous surface.**

## **Deflocculation**

**When the glaze is deflocculated it becomes more fluid with the same amount of water. This is sometimes used for glazing nonporous ware that cannot absorb water. Sodium silicate and soda ash are the most common deflocculants and they are prepared in the same way as flocculants.**

**CAUTION: Binders, deflocculants or flocculants should only be added after the glaze is ball-milled.**

### **8.6. Density specific gravity**

**Most potters judge the consistency of their glaze by experience and feel, or by test application to a few pieces of biscuit to see if the thickness is correct. The standard test is to check thickness with a fingernail, which is a very accurate test for an experienced glazer. Then adjust the water as necessary.**

**A more accurate method is to measure the specific gravity of the glaze with a hydrometer, such as is commonly used to judge the amount of water that has been mixed with milk. When reading the depth the hydrometer sinks, take care that it is really showing the correct density. If the glaze is thick you have to vibrate the bucket repeatedly to make sure the hydrometer sinks in.**

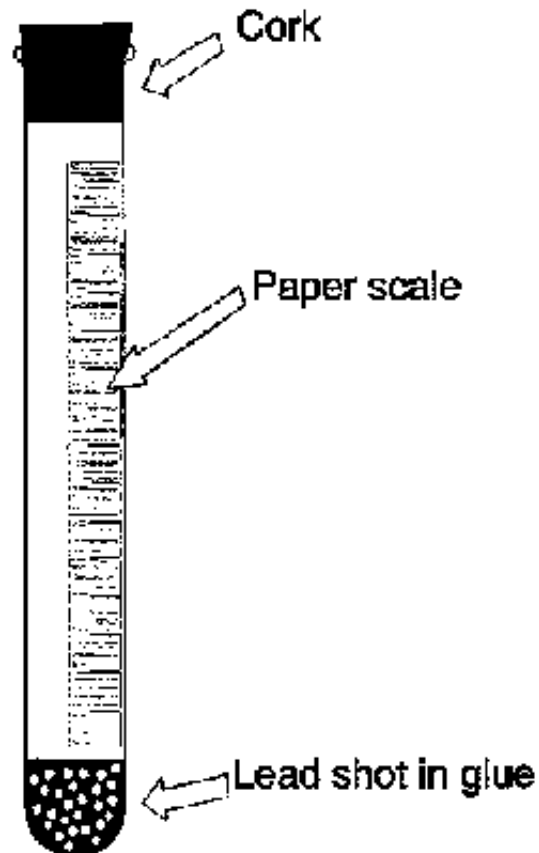

**Figure 8.6.0.B. Hydrometer made from a glass test tube.**

**Specific gravity (s.g.) is a measure of the density of a liquid compared to water, which has a standard specific gravity of 1. Glazes will always be heavier than water. The specific gravity is found by weighing a specific volume, say 1000 ml (milliliters). If this weighs 1500 g the s.g. is 1.5. Weighing is more accurate than using a hydrometer.**

**After you find out the correct amount of water by trial and error, the specific gravity can be measured and future batches of the same glaze made to the same specific gravity.**



**CAUTION: This is not always a reliable method because the water absorption of your biscuit will vary with its firing temperature. The water will still need to be adjusted by trial and error. Trial application and testing with a fingernail still constitute the most reliable method.**

## **8.7. Old glazes, problems**

**If you keep wet glazes around for a long time, they will usually have problems with settling or drying up. These glazes can still be used but it will be necessary to adjust the water and to resieve them. If the glaze is extremely thick, it is sometimes best to dry it out completely, crush it and remix it.**

**Before using a glaze that has set in the bucket for a few days, it should always be sieved through 60 or 100 mesh.**

**Too much water in the glaze is also a problem. The glaze can be allowed to settle and excess water carefully taken off the top. CAUTION: With soluble glazes, this can remove some of the ingredients and result in a glaze that no longer works correctly. In this case, the water should be allowed to evaporate until the thickness is correct.**

**Glazes made with raw borax, or incomplete borax frits, will often grow crystals. These cannot be sieved. The glaze should be dried out, the crystals crushed and remixed.**

**Some glazes will develop mold and begin to smell. Although they can still be used, it is probably better to just throw them out.**

## 8.8. Test your glazes!

The wise potter will never glaze a kilnload with untested glaze. Enough glaze should be kept on hand, so that each new batch can be test-fired in the regular glaze firing before it is used for application.

## 8.9. Commercial production of glazes

Glazes that are sold commercially are usually in dry powder form. They are made as standard glazes by ball milling, then are dried and packaged.

These glazes are simply mixed with the correct amount of water and sieved before using.



[Home](#) > [ar](#).[cn](#).[de](#).[en](#).[es](#).[fr](#).[id](#).[it](#).[ph](#).[po](#).[ru](#).[sw](#)



### **Glazes - for the Self-reliant Potter (GTZ, 1993, 179 p.)**

#### **9. Glaze application**

 **(introduction...)**

 **9.1. Work place, cleaning area**

 **9.2. Application methods**

 **9.3. Density, binders, glaze thickness**

 **9.4. Waxing**

 **9.5. Single-fire glazing**

 **9.6. Handling, drying before firing** **9.7. Salt glazing**

**Glazes - for the Self-reliant Potter (GTZ, 1993, 179 p.)**

## **9. Glaze application**

**Glaze application is a skill that takes some time to learn. In order to get consistent results, it needs to be done carefully and the same way every time. Thin and thick application will give different results, and careless application is always ruinous.**

**Glazing should be done just before loading the kiln, as glazed pieces that lie around gather dust and get damaged. Some glazes tend to crawl if fired right after glazing. If you have such problems, allow the glazed ware time to dry completely before firing.**

### **9.1. Work place, cleaning area**

**Before glazing, you should have a neat and clean area to work in. Dust thoroughly and remove small children. The biscuit to be glazed should be organized in one place, with all like items grouped together (cups, bowls, vases etc.). Ware boards are cleaned and arranged, ready to take the glazed ware to the kiln. The glaze should be sieved and checked just before starting the application. Clean water and sponges should be available.**

**Large items are usually glazed first, as they require a full bucket for even application.**

## **Correct application depends on many different factors:**

- Density of the glaze**
- Viscosity of the glaze**
- Particle size (depending on grinding time)**
- Expertise of the worker**
- Porosity of the biscuit**
- Thickness of the piece**
- Dipping time.**

**Although some of these factors can be controlled accurately in large industries, the small producer will have to depend on experience. Mistakes will be made at first, and it is important to be able to understand what went wrong, so it can be corrected.**

### **9.2. Application methods**

**The particular method of applying glaze depends on the type of ware -small, big, sculpture, tiles, open forms, closed forms etc.**

**Generally the inside of an object is glazed before the outside, to prevent handling defects.**

**Loading systems need to be considered carefully. Most pots are loaded on shelves directly, so the feet must be left unglazed. If foot rings are to be glazed, then each piece must be individually set on special kiln furniture in the kiln.**

#### **9.2.1. PAINTING**

**Glaze is sometimes applied with a brush. This is not recommended because it takes a great deal of skill to obtain an even coat, as well as a lot of time. Painting is used on sculptural objects that cannot be dipped or sprayed. Three to four coats are brushed on, letting each coat dry before applying the next. In order to see each coat, sometimes organic color dye (food coloring) is added.**

### **9.2.2. DIPPING AND POURING**

**Dipping and pouring constitute the most common method.**

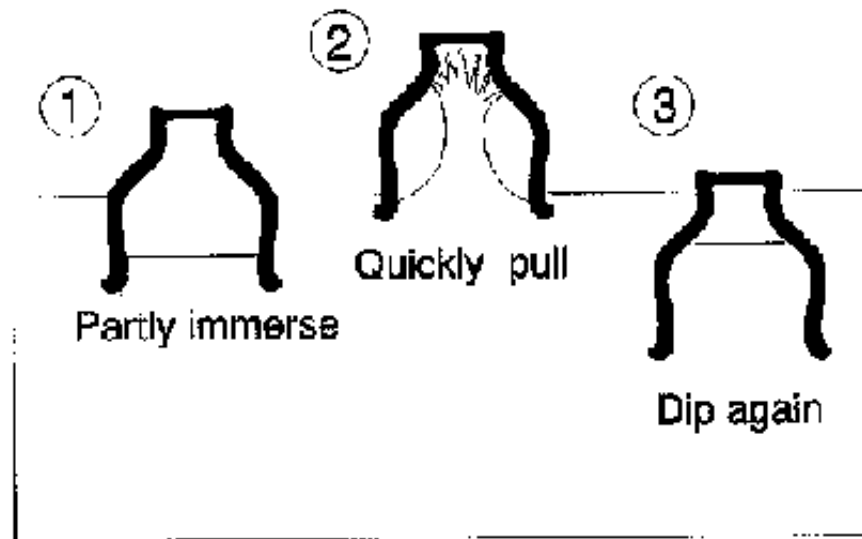

**Figure 9.2.2.D. Three steps of glazing the inside and outside of a cup in one dip.**

**The glaze needs to be stirred frequently during application time.**

#### **Cups and bowls**

**Cups can be glazed inside and out in one movement (after some practice). Hold**

**the cup by the foot and dip it at a slant to let glaze inside, while the outside is also coated with glaze. Then quickly pull up and push down. This results in a "fountain" of glaze that covers the entire inside.**



**Figure 9.2.2.H. Dipping tiles in glaze.**

## **Tiles**

**To dip tiles, hold them by the edges and dip them in the glaze while moving sideways. This also requires practice!**

## **Double dipping**

**Applying a second coat of the same or a different glaze over the first is known as double dipping. This often happens inadvertently. When glazing the inside, sometimes there will be runs of glaze on the outside. These should be sponged clean before doing the outside. Larger items are often partly dipped to cover the top, then turned over and dipped again to coat the bottom. This usually results in a line of double glaze, which will look different. If the overlapping area is chosen carefully, it can become a part of the design. Otherwise, it will look like a mistake.**

**For decorative effects, a pot is sometimes dipped partly in one glaze and then again in a different glaze. This results in a third color where the two overlap.**

## **Waterfall glazing**

**In the commercial glazing of tiles, the "waterfall" system is used. This consists of a conveyor belt, which carries the tiles under a thin waterfall of glaze that pours over them. The thickness of application is controlled by the speed of the conveyor belt and the amount of glaze flow. Excess glaze runs into a tank, which is again pumped up to the waterfall. These machines are often equipped with automatic cleaners that take excess glaze off the sides of the tiles.**

### **9.2.3. SPRAYING**

**Spraying is used for items that cannot easily be dipped or poured. It requires an air compressor and a spray gun, as well as a spray booth equipped with an exhaust fan. This is not recommended for the small producer, unless it is required for frequent use or for special decorative effects. Ordinary spray guns for paint can be used, but they wear out quickly because glaze is abrasive. Special spray guns for glaze are equipped with silicon carbide spray heads.**

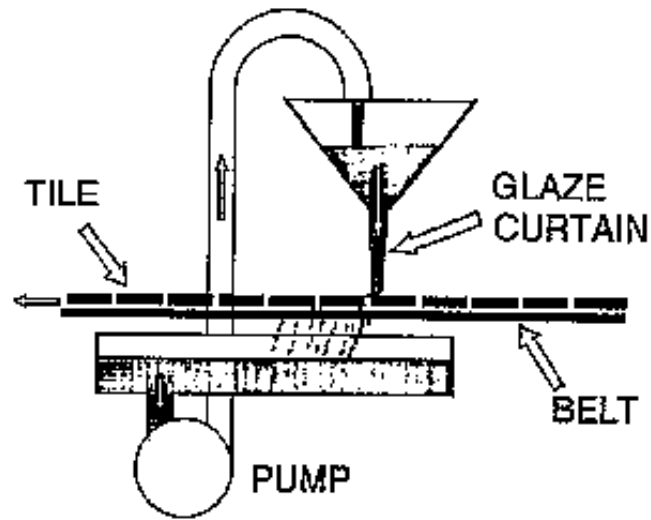

**Figure 9.2.2.J. Waterfall glazing of tiles. The tiles run through a curtain of glaze which is continuously recycled with the help of a pump.**

**Spraying has the disadvantage of wasting a lot of glaze that goes into the air. This is dangerous to inhale, and a spray booth should be provided with an exhaust fan to the outside, as well as having a filter to catch excess glaze. If a great deal of spraying is done, the excess glaze can be collected from the filter and the inside of the booth and reused.**

**As usual, the inside of the item is glazed first (usually by pouring), and the spraying is done in several even, systematic coats. Each one must be applied before the first one dries, or the glaze may lift off the pot. Each coat should be lightly applied, so that it looks a bit powdery.**

**It is difficult to judge the correct thickness of glaze and to get it even all over, especially in difficult areas like under handles. In time the glazer will learn to measure the thickness by feeling it with a fingernail.**



## **Airbrush**

**An airbrush is a very small spray gun that can be adjusted from a pencil-thin spray to a wide pattern. These are not used for glaze application, but are often used for decorative effects-with underglazes and overglazes.**

### **Care of the spray gun**

**Spray guns are very sensitive. They tend to get clogged, so make sure that your glaze is sieved before putting it in the gun. Clean the spray gun immediately after use by rinsing it out and spraying clean water through it until there is no sign of glaze. Glaze left in the spray gun will corrode it and make it unusable.**

### **Glaze fountain**

**For glazing the inside of large items a glaze fountain as shown in Fig. 9.2.3.D is helpful. The pot is placed over a nozzle from which an electric pump provides a powerful upward shower of glaze when activated with a switch on the floor.**

### **9.3. Density, binders, glaze thickness**

**As described above, it is important to have the correct a nouns of water in your glaze. The glaze should always be checked and corrected by test dipping some biscuit before starting and then relying on your experience to judge if the thickness is correct. Checking specific gravity with a hydrometer or by weighing is a good practice but should not be relied on.**

**It is best not to use binders unless you have no choice. CMC gum is the most**

**satisfactory.**

## **Nonporous biscuit**

**As previously mentioned, differences in biscuit firing temperature cause differences in porosity and can cause problems in glaze application. Overfired biscuit is especially difficult to glaze, as it will not absorb water. In the making of whiteware, the biscuit temperature is usually higher than the glaze temperature. This results in a semivitrified body that has special glaze application problems. If it is necessary to reglaze pots that have firing defects, they also require special handling.**

**If you only have a few pieces, they can be heated until almost too hot to handle and then dipped, poured or sprayed (spraying is most satisfactory). The heat will make excess water evaporate.**

**If glazing vitrified ware is part of your standard production, then it is best to flocculate your glaze. This is the opposite of deflocculation (as used with casting slip) and results in a thick, pudding-like glaze with the normal water content.**

## **9.4. Waxing**

**In order to keep glaze from being applied to the foot of your pots, it is often more efficient to wax the bottoms as compared to sponging them clean. The coating of wax prevents glaze from sticking. There are two common waxing methods:**

### **Hot wax**

**Paraffin wax is kept melted in a shallow metal pan over an electric heater or a smoldering charcoal fire (an open fire should not be used as the paraffin may start to burn). It should be hot, but not so hot that it starts to smoke. Before applying the glaze, the foot rings are dipped in the paraffin.**

### **Liquid wax resist**

**It is much easier to use liquid wax resist, which is a wax emulsion in a water base. It can be thinned with water but after drying cannot be dissolved. This is commercially available in some countries specifically for glaze application. It is also possible to use liquid floor wax.**

**Liquid wax resist is also used for decoration.**

### **9.5. Single-fire glazing**

**Single-fire glazing is sometimes called "raw glazing", but this term is confusing as "raw glaze" also is used for unfritted lead or borax glazes. Glaze is applied directly to bone-dry or leather-hard ware and fired once up to the glaze temperature. Not all glazes and bodies are suitable for single firing, and each combination needs to be tested.**

**Glazes that work on biscuit ware will often also work on bone-dry clay with a small addition of a plastic clay or bentonite. Glazes for leather-hard glazing will need more clay so the glaze layer will shrink along with the clay during drying. The leather-hard method is less practical, since each batch of leather-hard pots must be glazed immediately, causing problems in the work flow.**

**The advantage of single firing is that it avoids the fuel and extra handling needed for biscuit firing. The main problem with single firing is crawling caused by different shrinkage rates of clay and glaze in the early stages of the firing. Single-fire glazes usually have a high percentage of clay.**

**Delicate ware cannot usually be single-fired successfully, as it tends to be damaged by the water.**

**Single-fire glazing needs to be done quickly and carefully, without letting glaze stand inside the pot for a long time. Dipping and pouring can be used, and spraying is also effective.**

**Firing needs to be done more slowly than usual, so that pots do not explode. The early stages of firing should be done as with biscuit firing.**

**Single firing is used most often in large tile industries, where it saves fuel.**

## **9.6. Handling, drying before firing**

**Good glaze application requires careful handling. Many pots are spoiled by fingerprints or glaze that is knocked off during handling. Pots should be allowed to dry before loading in the kiln.**

**The kiln loader should be responsible for checking each pot as he places it in the kiln. This means inspecting the foot to see if it is clean and rejecting pots with damaged or thick glaze. The loader should constantly clean his hands of glaze dust especially when loading ware with different colored glazes. Otherwise colored fingerprints will mark the pots.**

## 9.7. Salt glazing

**In salt glazing, no glaze is actually applied to the pot before firing. The ware is single-fired up to the maturing point of the clay and rock salt is then introduced directly into the firebox. The salt breaks down into sodium and chlorine gas. The sodium combines with silica on the surface of the pot to make a durable glaze and the chlorine goes up the chimney, combining with water in the air to form hydrochloric acid. This is an irritant, as well as causing damage to vegetation and metal structures in the immediate vicinity. Another problem is that the salt erodes the firebricks in the kiln rather fast.**

**Salt glazing normally is done on stoneware at temperatures above 1100°C. Salt is often mixed with borax to lower the melting point (see also page 19).**



[Home](#) > [ar](#).[cn](#).[de](#).[en](#).[es](#).[fr](#).[id](#).[it](#).[ph](#).[po](#).[ru](#).[sw](#)

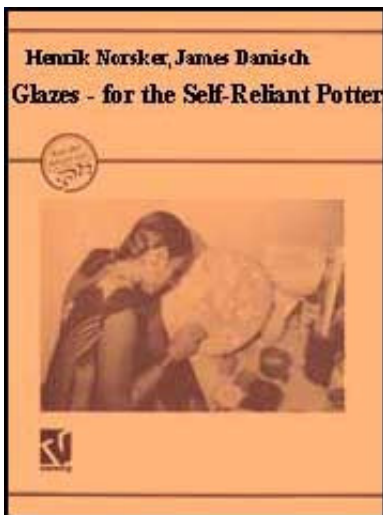

### **Glazes - for the Self-reliant Potter (GTZ, 1993, 179 p.)**

#### **10. Decoration**

 **(introduction...)**

 **10.1. Decoration and design**

 **10.2. Glaze decoration**

 **10.3. Engobe decoration**

 **10.4. Terra sigillata**

## **Glazes - for the Self-reliant Potter (GTZ, 1993, 179 p.)**

### **10. Decoration**

**Decoration is a very big field, which deserves a separate book to cover it in detail. Here we will only discuss some of the main techniques for using glazes and engobes.**

#### **10.1. Decoration and design**

**The main reason for decorating pots is for pure enjoyment. As pottery is something that is used intimately every day, it should be attractive and interesting, besides being simply functional. Decorated pottery also has a better market value and often more than pays for the extra time taken.**

**Good decoration is always related to the design of the pot. It should be used to emphasize and enhance the shape of the pot, rather than being applied randomly.**

**There are several approaches to decoration;**

#### **Banding**

**Plain or decorative bands of color are painted around the pot, usually by spinning the pot on a banding wheel and applying color with a brush. The bands are placed where they emphasize changes in the curve of the pot, for example, at the rim, the**

**belly, the shoulder.**

### **Area decoration**

**Decoration is placed inside a defined area, such as a circle. Again this should be done to emphasize the natural curves of the pot.**

### **Overall patterns**

**These are patterns that are repeated around the pot, often expanding and contracting as the pot does.**

### **Contrasting shapes**

**These are strongly shaped areas of pattern or color that contrast with the shape of the pot.**

## **10.1.1. MOTIFS, STYLES, LOCAL INPUTS**

**There are as many motifs and styles of decoration as there are cultures in the world. In traditional cultures, motifs are selected from mythology and familiar designs. Nowadays, with the mixing of cultures around the world, pots are often designed for what can be marketed for export, and design tends to be based on fashion rather than tradition.**

**The potter selling to tourists will generally choose traditional motifs, since tourists are interested in the culture of the area.**

## **10.2. Glaze decoration**

**Glaze decoration is done with the glaze itself or with colorants under the glaze or on top of the glaze.**

### **10.2.1. UNDERGLAZE**

**Underglaze decoration is decoration that is applied under the glaze. It is affected by the transparency and fluidity of the glaze.**

**Underglazing is usually done under a transparent glaze in order to show it clearly. However, beautiful effects can be obtained under opaque or semiopaque glazes.**

**A variety of pigments and oxides may be used.**

#### **Metallic oxides**

**The more fusible metallic oxides can be used directly as underglaze pigments, mixed thinly with water. The satisfactory ones are red iron oxide, cobalt carbonate, manganese dioxide and copper carbonate. Designs made with oxides alone will often run with the glaze. Refractory oxides, such as chrome oxide and rutile, can cause crawling.**

#### **Oxides mixed with glaze**

**Metallic oxides can be mixed about 50/50 with glaze, which will prevent the problem of crawling. However, the decoration will usually flow with the glaze and should be designed with this in mind.**



## Underglaze pigments

**These are pigments that are specially prepared by fritting metallic oxides in a base glaze that fires hard but is not fluid. Rather than preparing them yourself, it is usually better to purchase commercial underglazes from a supplier. These are supplied for venous firing temperatures and firing conditions in a wide range of colors. Not all colors can be used under all conditions, and suppliers can usually tell you which are suitable for oxidation and reduction and what type of base glaze will develop the best colors.**

### 10.2.2. ON-GLAZE

**On-glaze decoration is applied on top of the unfired glaze. It may be done with a contrasting color of glaze or with metallic oxides or glaze pigments.**

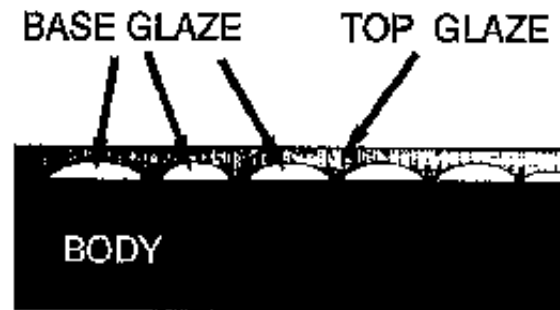

**Figure 10.2.2.C. Double glazing with the high-surface-tension glaze on top. This draws itself into islands leaving the bottom glaze in irregular patterns.**

**Application is done by brushing or spraying. Even more than underglaze, on-glaze decoration will tend to flow with the glaze. If distinct patterns are desired, a stiff, viscous glaze will give the best results.**

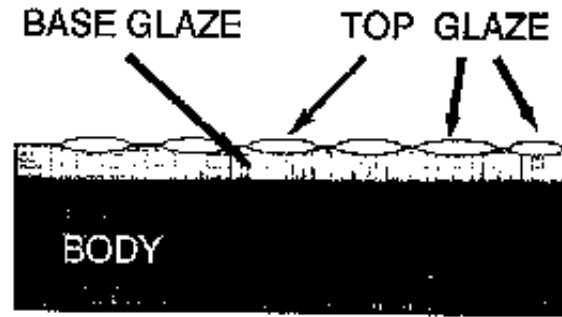

**Figure 10.2.2.D. Double glazing with the low-surface-tension glaze on top. This produces a different effect.**

## **Double glazing**

**Glazes high in surface tension (see page 30) tend to form into small islands on melting. This may cause crawling, but it can also be used as a decorative effect by applying two different glazes on top of each other. The glazes must have different degrees of surface tension. This is achieved by adding clay or talc to one of the glazes. The colors should be contrasting. The best results are obtained with a light-colored glaze at the bottom.**

## **10.2.3. OVERGLAZE**

**Overglaze decoration is often called "china painting". The pot is glaze-fired as usual and then is decorated with special low-temperature enamels that fire at around 700°C. The enamels are prepared from color pigments and low-temperature frits and are best purchased from commercial suppliers. They are available in every color and have the advantage of firing to true colors, making them suitable for elaborate painting effects. They also stay where they are applied, as there is no chance of the glaze running at this low temperature.**

**Overglaze is available as powder, which must be mixed with a medium. This is best done by grinding the pigment and medium on a glass plate with a thin palette knife.**

**Sometimes plain water is used -this works well when filling areas with solid colors. It helps to add some water-soluble glue (white glue) to provide dry strength.**

**For more elaborate painting, pigment is mixed with special oils. The best is oil of lavender, which is thickened as desired with a thicker oil. The consistency is controlled very much like with oil paint.**

**Some suppliers have ready-mixed overglaze, which comes in tubes. This can be used directly, without grinding.**

**Special metallic or iridescent overglazes are known as "luster". These are available commercially as liquid gold, platinum and a variety of mother of pearl colors. They also are fired at 700°C. NOTE: Lusters take on the same surface as the glaze, i.e. a matt glaze will produce a matt luster and a shiny glaze will give a mirror-like effect.**

**Overglazes are applied by brushing or by spraying.**

**Overglaze transfers or decals**

**Most commercially sold decorated dinnerware is decorated with decals (sometimes called transfers), which are made from overglaze that is silkscreen-printed onto decal paper. These are available from suppliers in a range of standard**

**designs and can also be custom-made (in large quantities). They are applied to already glaze-fired ware.**

**The decal is soaked in water until the design can easily be slid off the paper. The wet paper is placed in the correct location and is carefully slid from under the design, leaving the design adhered to the pot. The design is carefully smoothed, dried and fired like standard overglaze.**

#### **10.2.4. REGLAZING, MULTIPLE GLAZING**

**Reglazing means applying glaze and firing an article that already has been fired once. It is sometimes necessary when glazes do not work correctly the first time - they may be too thin, underfired or not the right color.**

**Multiple glazing is the process of glazing and firing an article two or more times in order to get special glaze effects that cannot be achieved in one firing. It often involves first glaze firing the pot at a high temperature and then glaze firing with lower temperature glazes, in order to get special colors or textures. For example, a pot may be fired to cone 10, then be refired with cone 06 glazes to get bright colors. It may be fired several times at cone 010 for overglazes and lusters.**

**Reglazing or multiple glazing makes an article more expensive, but it can also be sold at a much higher price.**

#### **Reglazing hints**

**Because already fired ware is no longer porous, it is difficult to apply enough glaze. It helps to first heat the article (as hot as you can hold in your hand), and**

**spraying is the most effective way to apply more glaze.**

**For multiple glazing, glaze can be specially prepared by adding cellulose gum (CMC). This thickens the glaze and gives it better handling strength.**

### **10.3. Engobe decoration**

**Engobe is a specialized type of clay slip that is used for decoration under the glaze. The engobe shows through a transparent or semitransparent glaze and can have the range of color that is possible in glaze.**

#### **10.3.1. ADVANTAGE/DISADVANTAGE COMPARED TO GLAZE DECORATION**

**Engobes stay where they are applied and do not run with the glaze. This makes it possible to do designs with sharp edges or a lot of detail.**

**Engobes are often used on dark clay bodies in order to provide a bright, white background for glazes.**

#### **10.3.2. ENGOBE MAKING, ADJUSTING TO BODY**

**Engobe is generally prepared as a white base and then colored with appropriate coloring oxides. If you are already using a white clay body, this becomes an engobe simply by thinning it with water. A dark body will require a white engobe formula that fits it correctly.**

**The main problem with engobe is getting a good fit between engobe and clay body. It must have about the same amount of shrinkage as the body or it will tend**

**to flake off or crack. The engobe should also mature at the same temperature as the clay body in order to provide a strong clay-glaze interface. Engobes can be applied at three different stages:**

### **Leather-hard**

**This is the best stage for applying engobes, as it permits the widest range of decorating techniques (brushing, incising, inlaying, stencil etc. -see below). The engobe must have enough clay in it to shrink at the same rate as the body.**

### **Bone-dry**

**Engobes for bone-dry application need to have less shrinkage, so that they adhere to the body.**

### **Biscuit**

**Engobes for biscuit application are more like underfired glazes.**

**Some typical engobe recipes are (from. D. Rhodes: Clay and Glazes for the Potter):**

<b>Temperature range</b>	<b>Cone 08 - 1</b>			<b>Cone 1 - 6</b>			<b>Cone 6 -11</b>		
<b>Body condition</b>	<b>DAMP</b>	<b>DRY</b>	<b>BISC</b>	<b>DAMP</b>	<b>DRY</b>	<b>BISC</b>	<b>DAMP</b>	<b>DRY</b>	<b>BISC</b>
Kaolin	25	15	5	25	15	5	25	15	5
Ball clay	25	15	15	25	15	15	25	15	15
Calcined kaolin		20	20		20	20		20	20

Leadless frit	15	15	15			5			5
Nepheline syenite				15	15	20			5
Feldspar							20	20	20
Talc	5	5	15	5	5	5			
Quartz (flint)	20	20	20	20	20	20	20	20	20
Opacifier (zircon)	5	5	5	5	5	5	5	5	5
Borax	5	5	5	5	5	5	5	5	5

**Usually engobes designed for plastic clay will not fit on bone dry or biscuit clay and vice versa.**

### **Engobe composition**

**Engobe is made up of a mixture of plastic and nonplastic ingredients. Recipes for engobes look like those for glazes with a high percentage of refractory ingredients.**

**For white engobes, the plastic ingredients are china clay and ball clay. The amount of ball clay can be adjusted to get correct shrinkage.**

**The nonplastic ingredients are feldspar and quartz, and for low-temperature engobes frit is sometimes added to lower the vitrification point.**

**Small amounts of borax are often added to give better dry strength and to fuse the other ingredients together.**

**Engobes are often deflocculated like a casting slip, and in fact you can often use a casting slip which fires at the same temperature as your clay body.**

### **10.3.3. COLOR OXIDE ADDITIONS TO ENGOBE**

**Coloring oxides are added to engobes as a percentage, as with glazes. However, since the color is diluted by the glaze over it, larger amounts are required. You should also remember that the oxide reactions will depend on the type of glaze being applied and on whether oxidation or reduction firing is used. Typical colors and oxide amounts are:**

#### **Red iron oxide**

1-5% light green to light brown

5-10% brown

10-15% dark brown to black

#### **Copper oxide or carbonate**

1-5% green or blue, red in reduction

#### **Cobalt oxide or carbonate**

1-5% light to dark blue

#### **Chrome oxide**

1-5% green



1-5% green

## **Manganese dioxide**

1-10% purple-brown

## **Nickel oxide**

1-5% grey or gray-green

## **Titanium dioxide or rutile**

1-10% tan, or mottled colors

## **Commercial glaze stains**

1-50% produces the color of the stain

**As with glaze colorants, the most interesting colors are usually obtained by mixing combinations of oxides.**

### **10.3.4. APPLICATION METHODS**

**A wide variety of decoration techniques can be used with engobe. Leather-hard ware permits the largest variety of techniques and usually has fewer technical problems compared to application on bone-dry or biscuit ware. Work flow for leather-hard engobe decoration is:**

- **Apply the engobe.**
- **Biscuit-fire.**
- **Apply the glaze.**
- **Glaze-fire.**

## **Dipping, pouring**

**This is done the same as with glazes. The engobe should be just thick enough to completely cover the clay. Too thick application will often crack, especially on rims. If applied leather-hard, pouring and dipping should be done quickly, so that the pot does not get too soft from absorbing water.**

## **Brushing**

**Brushing is one of the most satisfactory methods, especially for making bands or areas of engobe. The technique requires some skill in order to get an even coating. The brush should be fully loaded with engobe and should spread it evenly.**

## **Spraying**

**The engobe must be thin enough to flow through the spray gun. It should be applied in several even coats, taking care to keep a smooth surface and to cover all areas equally.**

## **Scratching or "sgraffito"**

**To get fine lines, engobe is applied to an area and, after it sets, it is scratched with a sharp tool. This is called "sgraffito", which means "scratching". The clay color**

**shows as a line.**

## **Inlay**

**Lines are scratched on the leather-hard pot and then filled with engobe. The excess engobe is removed with a metal scraper after it sets, or with sandpaper after the pot is bone-dry. This results in a smooth surface, with the engobe lines contrasting with the clay color.**

## **Stencil**

**Paper or plastic stencils are placed on the leather-hard pot, and engobe is brushed or sprayed over them. Afterwards the stencil is removed leaving the design of the stencil.**

## **Trailing**

**Usually called "slip" trailing, the engobe is applied by allowing it to flow from a device with a small opening, which produces raised line decoration. It is easiest to use a rubber bulb (such as an ear syringe available in pharmacies) or plastic containers used for soap or cosmetics. The opening can be made smaller by inserting small metal tubes.**

## **Engobe hints**

**Engobes will show most clearly under a fully transparent glaze. However, semitransparent or even opaque glazes can give beautiful effects, clouding the engobe colors.**

**Sophisticated decorators can take advantage of different glazes over the engobe to produce different colors. Complicated effects can result from applying different glazes to different areas of the decorated piece.**

### **10.3.5. ENGOBE PROBLEMS**

**Often engobe will come off the pot. This almost always is caused by a different shrinkage rate of clay body and engobe and usually happens before firing. In many cases the engobe is applied too thick.**

#### **Engobe shrinks more than clay body**

**In this case, the engobe will develop cracks and will flake off, with the flakes curling away from the ware. The solution is to reduce the amount of plastic clay or substitute raw clay with calcined clay. Deflocculating usually helps.**

#### **Engobe shrinks less than clay body**

**In this case, the engobe will flake off, especially on rims and sharp edges, and the flakes will be flat. The solution is to add more plastic clay or to substitute calcined clay with raw clay.**

#### **Flaking after firing**

**This is caused by differences in firing shrinkage between clay and engobe. Usually adding flux to the engobe will help.**

#### **Spit-outs**

**Application of engobe to biscuit ware sometimes causes the engobe to lift off in small bubbles. This may only show up after glaze firing, but it arises during application. If the biscuit ware is very porous, it absorbs the water in the engobe so fast that air inside the body comes under pressure. When the air is released, it may blow out the engobe layer where the air escapes. The solution is to reduce the absorption by dipping the biscuit in water some time before engobe application.**

#### **10.4. Terra sigillata**

**The technique of coating pottery with terra sigillata was used by Roman and Greek potters and is still used by traditional potters in India and Nepal. It produces a thin, opaque and low gloss finish to pottery.**

##### **10.4.1. PREPARING TERRA SIGILLATA**

**Terra sigillata is made from clay. For temperatures below 1100°C local sedimentary clays are more suitable. The finer the clay particles the better. Such clays normally contain iron and fire to a red color. It is more difficult to produce white-firing terra sigillata from ball clay or kaolin.**

by weight: Clay 0

Water 0

**Sodium metaphosphate + 0.5%**

**The best result is obtained when ball milling the clay. Some clay can be prepared**

**without ball milling. After ball milling the batch is transferred to a container and left for 24 hours. The coarse particles will settle and the upper 2/3 of the batch is siphoned off. A bucket with a tap placed 1/3 up is useful for regular production of terra sigillata.**

**Colors can be made by adding color oxides or pigments. First the terra sigillata is dried and the color oxide is added in amounts similar to what is mentioned for engobes (by dry weight). Then water is added and the batch is again ball-milled for 4 hours. It is then ready for use.**

#### **10.4.2. APPLICATION**

**The terra sigillata should be adjusted to a density of 1.15 to 1.20 for application on leather-hard clay. For dry and biscuit ware more water is added to obtain a density of 1.05 to 1.10. The ware should be clean and dust-free before application.**

**Application can be done by dipping, brushing and spraying. After drying the gloss can be improved by polishing the surface with a cloth.**

#### **10.4.3. ADVANTAGES**

**The use of terra sigillata makes it possible to produce attractive decorations on low-fired pottery without using glazes. The coating gives a dense, glossy and impervious surface. A very beautiful glossy black can be produced by placing the terra sigillata items in a ridded pot filled with sawdust. This is fired in a normal firing either in a kiln or in a traditional pottery firing. The strong reduction will change the normal red color to black.**





**The use of terra sigillata coatings as an intermediate layer between body and glaze is reported to reduce crazing and bubbles in the glaze.**



[Home](#) > [ar](#).[cn](#).[de](#).[en](#).[es](#).[fr](#).[id](#).[it](#).[ph](#).[po](#).[ru](#).[sw](#)



## **Glazes - for the Self-reliant Potter (GTZ, 1993, 179 p.)**

- ➔  **11. Glaze problems**
  -  **(introduction...)**
  -  **11.1. Introduction to glaze problems**
  -  **11.2. Trouble-shooting checklist**
  -  **11.3. Specific problem explanations**

## **Glazes - for the Self-reliant Potter (GTZ, 1993, 179 p.)**

### **11. Glaze problems**

**Anybody with even a little experience with glazes will realize that problems often arise. Knowing what to do about them requires a lot of experience, and even expert glazers often find it difficult to establish the source of a problem.**

#### **11.1. Introduction to glaze problems**

**It is one thing to develop a nice glaze but quite another to keep it working. One potter may want a glaze that crazes, whereas another wants his glaze to be craze-free. A glaze fault may not mean that the glaze is ugly, just that it reacts differently and does not look like the desired effect.**

**When a glaze suddenly starts to react differently from what we want, we call it a glaze fault. Solving the problem is seldom easy, and usually several factors are involved. The first thing to check is what changes have occurred since the glaze last worked without problems. The following things should be checked:**

**1. Was the right recipe used and were the materials weighed out correctly? (Always use batch cards for glaze weighing).**

**2. Were the right raw materials used? Was there any chance of mistaking one material for another? Was the labeling of materials in stock correct?**

**3. Have new raw materials or a new frit batch been used since the last fault-free glaze batch was produced? If so, check if the new material is different from the original material in stock.**

**4. Has the body been changed in any way? For example: new preparation method, change of clay material, change of body recipe, higher or lower biscuit firing?**

**5. Was the preparation of the glaze done as usual? For example: same ball milling time, same screening, same specific gravity of glaze slip?**

**6. Was there any change in glaze application and were the products clean**



**and dust-free before application?**

**7. Were there changes in the kiln setting? Was the glazed ware dry before firing started? Were there any changes in fuel, firing schedule, firing atmosphere (reducing/oxidizing) and was the correct top temperature reached (setting of cones, draw trials) ?**

**Once we know which conditions have changed, we may already be close to establishing what caused the glaze problem. The following trouble-shooting lists may be helpful to find solutions to the problem.**

## **11.2. Trouble-shooting checklist**

### **11.2.1. GLAZE SLIP PROBLEMS**

**Problem: The glaze or part of the glaze settles too fast in the bucket.**

**Causes:**

- High amount of frit in the glaze.**
- Glaze materials too coarse.**
- Water content of glaze slip too high.**
- Ball milling time was too short.**
- Too little clay in the slip.**
- Metal buckets cause fast settling.**

## **Solutions:**

- **Add 5-10% plastic clay or 0.5-2% bentonite.**
- **Reduce amount of frit by removing some of the insoluble materials from the frit recipe and adding these to the glaze batch instead.**
- **Longer ball milling of glaze materials.**
- **Add a small amount of vinegar (acetic acid) to the glaze.**
- **Use plastic buckets or wooden containers.**

**Problem: Glaze slip is too thin, low viscosity.**

## **Causes:**

- **Water content too high.**
- **Alkali materials from frit or feldspar have been dissolved in the water, so the slip is deflocculated.**

## **Solutions:**

- **Let the glaze stand for a day and decant the clear water off the top. Because some materials may be removed with the water, it is better to allow excess water to evaporate.**
- **Add flocculant (magnesium sulfate, calcium chloride), but only if the ware has too low a porosity. This is often done in production methods which use high-fired biscuit and lower temperature glaze.**

## **11.2.2. PROBLEMS OF APPLICATION AND DRYING**

**Problem: Glaze layer too thin after dipping.**

**Causes:**

- **Water content of glaze slip too high.**
- **Clay body absorbs too little water.**

**Solutions:**

- **Increase density of slip (decrease water).**
- **Biscuit-fire at a lower temperature.**
- **Glaze only one side of the article at a time and allow it to dry before glazing the other side.**
- **Add flocculant to the slip so that glaze layer becomes thicker.**

**Problem: Glaze layer becomes too thick.**

**Causes:**

- **Glaze slip density is too high (too little water).**
- **The glaze does not contain enough clay materials.**
- **The biscuit body absorbs the water too fast.**
- **The glaze slip releases its water too fast.**
- **Dipping or pouring is done too slowly.**

**Solutions:**

- **Reduce density by adding water.**
- **Add plastic clay, bentonite or cellulose (CMC) binder.**
- **Biscuit-fire to a higher temperature or moisten the pots before glazing.**
- **Dip.**

**Problem: Glaze layer cracks during drying.**

**Causes:**

- **Glaze has too high a drying shrinkage due to high content of clay or zinc oxide or due to over-grinding in the ball mill.**
- **The glaze is applied too thickly.**
- **Single-fire glaze was applied to biscuit ware.**
- **In double glazing, the second glaze may tend to crack.**
- **Glaze is poured over a sprayed glaze.**

**Solutions:**

- **Less ball mill grinding of glaze materials.**
- **Calcine zinc oxide or add it to the frit.**
- **Replace part of the clay with calcined clay or introduce alumina ( $\text{Al}_2\text{O}_3$ ) as feldspar.**
- **Reduce viscosity of glaze by adding water.**
- **Apply single-fire glaze to leather-hard pots.**
- **When double glazing, reduce clay content of the second glaze.**
- **When double glazing, apply the second glaze before the first one dries completely.**

## **Problem: Glaze layer does not stick to the body.**

### **Causes:**

- **Glaze adhesion to body is too low due to:**

**greasy or dusty body surface  
too fast and too thick application  
too high body porosity  
too fine grinding of glaze  
dusty surface from underglaze colors.**

- **In single-fire glazing, the glaze shrinks less than the moist body.**

### **Solutions:**

- **Clean the body surface by brushing or sponging.**
- **Reduce speed of dipping and, if spraying, apply less glaze at a time.**
- **Biscuit-fire at a higher temperature.**
- **Add cellulose binder (CMC) when single-fire glazing.**
- **Add clay, borax, soda ash or glaze to the underglaze colors.**
- **Reduce grinding time of glaze.**

**Problem: Glaze dusts off easily after drying.****Causes:**

- Too little binding power of the glaze and low adhesion to body.

**Solutions:**

- Add 2-5% plastic clay or 0.5-1% bentonite.
- Add a binder like cellulose (CMC) or 12% borax.

**11.2.3. PROBLEMS IN GLAZE MELTING****Problem: Glaze runs.****Causes:**

- Firing temperature too high.
- Viscosity of glaze too low.
- Glaze layer too thick.

**Solutions:**

- Adjust firing temperature.
- Add alumina (clay, feldspar) or silica (quartz, zircon) to the glaze.
- Glaze thinner.

## **Problem: Glaze does not melt properly.**

### **Causes:**

- **Firing temperature too low.**
- **Too much silica or alumina.**
- **Not enough glass formers ( $\text{SiO}_2$  or  $\text{B}_2\text{O}_3$ ) and too much  $\text{CaO}$ ,  $\text{MgO}$ ,  $\text{BaO}$ .**
- **Glaze materials too coarse.**
- **Evaporation of fluxes in the firing (extended firing time).**

### **Solutions:**

- **Fire at higher temperature.**
- **Slower firing and longer soaking at the end.**
- **Increase amount of fluxes, reduce content of alumina.**
- **Longer milling of glaze materials.**
- **Add the evaporating fluxes to the frit.**

## **Problem: Pinholes or eggshell surface.**

**This is one of the most common glaze problems and often the most difficult to cure. It is usually caused by gas escaping from the body or glaze, leaving small holes that do not have time to smooth over.**

### **Causes:**

- **Firing temperature too low, glaze does not have time to melt completely.**
- **Firing temperature too high, glaze reacts with body, forming gas bubbles.**

- **Glaze has high surface tension and viscosity, which do not allow gas bubbles to escape.**
- **Glaze is too thick, not allowing gases to escape.**
- **Release of gases from body or engobe.**
- **Early reduction firing forms carbon and sulfates in the body, which cause pinholes when they are later released.**
- **Body contains organic particles which burn out, leaving small pits.**
- **Body contains air bubbles from incorrect slip casting.**
- **Glaze contains zirconium opacifier, which causes large amounts of gas.**
- **Contamination from ball milling, usually by linings set in lime cement.**
- **Contaminated water used to mix glazes.**
- **Dirty biscuit or dust on the glaze.**

## **Solutions:**

- **Fire to the correct temperature.**
- **After final glaze temperature is reached, "soak" the kiln by holding at the same temperature for about half an hour.**
- **Reduce viscosity and surface tension by changing the glaze recipe.**
- **Less reduction, especially in early stages of firing.**
- **Thinner glaze application. Higher biscuit firing.**
- **Body must be prepared to eliminate organic materials (sometimes long aging to decompose the material and repugging will solve the problem).**
- **Slip must be mixed and poured carefully to eliminate air bubbles.**
- **Increasing viscosity of zirconium-opacified glazes by addition of clay or talc may reduce the problem.**
- **Ball mill linings should be fastened with high-alumina cement mortar.**



- **Use only clean water to mix glazes.**
- **Biscuit should not be stored too long and should always be cleaned before glazing. Glazed ware should be put in the kiln as soon as possible.**

### **Problem: Glaze crawls.**

**Normally this is caused by cracking or lifting of the glaze layer before firing (see section 11.2.2. for additional causes and solutions).**

### **Causes:**

- **The viscosity and surface tension of the melted glaze are too high.**
- **Too fast firing.**
- **During firing, the body released gases (steam, carbon, sulfur), which lifted the glaze layer off.**
- **Drying and sintering shrinkage high.**
- **Glazed ware was still wet when fired.**

### **Solutions:**

- **Reduce surface tension and viscosity by firing higher.**
- **Reduce alumina, magnesia and zircon.**
- **Increase biscuit temperature.**
- **Correct what causes cracking and lifting of dry glaze (see above).**
- **Reduce grinding time of glaze.**
- **Reduce drying and sintering shrinkage by calcining part of clay and zinc oxide content.**
- **Dry the glazed ware before firing.**

- **Add 1-2% borax to the glaze.**
- **Add clay, borax or frit to underglaze colors.**

**Problem: Glossy glaze turns matt.**

**Causes:**

- **Glaze is absorbed by the body (glaze layer is too thin).**
- **Flux materials evaporate in firing.**
- **Sulfates from fuel are deposited on the glaze surface.**
- **Too much steam in the kiln. Glaze is underfired**
- **Crystals form due to very slow cooling.**
- **Glaze slip was not properly mixed.**

**Solutions:**

- **Glaze thicker.**
- **Glazed ware set next to biscuit ware or on new shelves, which may attract volatile fluxes from the glaze. Do not mix glaze and biscuit firing.**
- **Introduce volatile fluxes in the frit.**
- **Fire with more draft and less reduction and cool quickly.**
- **Always stir glaze immediately before application and screen it through at least 60 mesh.**

**Problem: Matt glaze turns glossy.**

**Causes:**

- **Glaze is overfired.**
- **Too fast cooling.**
- **Oxides from the body combine with the glaze.**

### **Solutions:**

- **Slower firing, or longer soaking period at the end of the firing.**
- **Cool slowly, closing all dampers and fire-boxes.**
- **Use another matting agent.**

### **Problem: Glaze color changes.**

#### **Causes:**

- **Wrong firing temperature, often over-firing.**
- **Change in reduction/oxidation atmosphere.**
- **Impurities in glaze or body.**
- **Coloring oxides not ground fine enough.**
- **Color pigment from engobe or underglaze melts into the glaze.**

#### **Solutions:**

- **Better control of firing temperature, oxidation/reduction.**
- **Check materials for impurities.**
- **Control the grinding time of coloring oxides.**
- **Add clay or quartz to underglaze pigments and engobes.**

## **11.2.4. PROBLEMS AFTER FIRING**

**These are problems that only appear right after firing or after the article has been used for some time.**

**Problem: Crazeing of the glaze**

**Causes:**

- **Thermal expansion of the glaze is higher than the body, which causes the glaze to contract more in cooling. This may be caused by:**
  - **Too much alkali (soda and potash).**
  - **Too little silica, alumina or zinc oxide.**
  - **Too little cristobalite formation in the body.**
  - **Lack of strong clay/glaze interface.**
  - **Glaze is too thick.**
  - **Fast cooling.**

**Solutions:**

- **Apply glaze more thinly.**
- **Higher glaze firing temperature (to increase cristobalite).**
- **Higher biscuit firing temperature.**
- **Reduce amount of soda and potash in glaze by replacing with boron (to decrease thermal expansion of glaze).**
- **Add additional boron, silica, zinc oxide or calcium carbonate to the glaze (to decrease thermal expansion of glaze).**

- **Add quartz or talc to the body. Quartz forms cristobalite in the body, which has a high thermal expansion.**
- **Longer soaking at top temperature, slower cooling.**

### **Causes:**

- **Moisture expansion (sometimes called delayed crazing). Porous bodies expand when they absorb moisture from the air and force the glaze to craze. This is a common problem with earthenware.**

### **Solutions:**

- **Fire at higher temperature or add flux to the body, making the body more vitreous.**
- **Add calcium carbonate, talc or dolomite to the body.**
- **Reduce the thermal expansion of the glaze.**

### **Problem: Shivering of glaze**

**This is usually seen as particles of glaze falling off the pot after firing (sometimes after a few weeks). It happens most often on sharp edges, but the entire glaze may shiver or the pot may crack.**

### **Causes:**

- **Thermal expansion of the glaze is less than the body, which leaves the glaze under strong compression. This may be caused by:**
- **Too high content of silica, boron or zinc oxide in the glaze.**

- **Too high content of silica in the body.**
- **Too low content of soda or potash in the glaze.**

### **Solutions:**

- **Reduce the amount of quartz in the glaze.**
- **Reduce the amount of quartz in the body.**
- **Add more soda or potash to the glaze.**

### **Problem. Lime popping**

**This is seen as small pieces of glaze popping off the pot, often several weeks or even months after firing. Under each flake of glaze a small white particle can be seen imbedded in the body.**

### **Causes:**

- **Small pieces of limestone or plaster in the clay body. These slowly absorb moisture from the air and expand, forcing the glaze off the pot.**

### **Solutions:**

- **Find the source of the lime pieces.**
- **Replace contaminated material or screen it through 40 mesh.**
- **Plaster that has gotten into the clay. All contaminated clay must be thrown out, and better care taken in clay mixing. The problem often comes from recycled clay, which has picked up plaster in the forming section.**

## **11.3. Specific problem explanations**

### **11.3.1. CRAZING AND SHIVERING**

**As already mentioned, crazing and shivering are caused by differences in thermal expansion/contraction between the glaze and body.**

#### **Crazing**

**Crazing appears as cracks in the glaze. This occurs during cooling, if the glaze contracts more than the clay. Cures for crazing are mentioned above.**

#### **Shivering**

**Shivering is the opposite of crazing and occurs during cooling if the clay contracts more than the glaze. Cures for crazing are mentioned above.**

#### **Thermal expansion**

**All materials expand when heated. This is called thermal expansion. Some materials expand more than others, and the degree of expansion can be measured. Numbers are used as a scale of thermal expansion, and this is called the coefficient of expansion (CE). The glaze layer on a pot has one coefficient of expansion and the body has another.**

#### **Glaze-body tensions**

**After a pot is fired and taken out of the kiln, it will be exposed to a sudden decrease in temperature. The glaze layer and the body will contract, but most often at different rates. Below is shown what happens when 1) glaze contracts more than body and 2) body contracts more than glaze.**

**This figure shows a body (white) with a glaze on top (black). The glaze and the body have contracted at the same rate. We say: they have the same coefficient of expansion (CE).**



**Figure**

**This figure shows a glaze that has a higher coefficient of expansion (CE) than the body.**



**Figure**

**The glaze contracted more, so it is shorter and therefore the glaze is under a tensile stress (it is pulled apart). If the body is very thin it will bend as shown. The arrows show the direction of the stress the glaze is under.**





Figure

**More often the tensile stress is relieved by cracks in the glaze as shown in this figure. This is called crazing. The stress caused by high CE of the glaze may be relieved by crazing as soon as the pot is taken out of the kiln or it may take days, months or years. The longer it takes, the closer is the CE of body and glaze.**

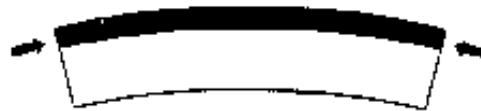

Figure

**This figure shows a body with higher CE than the glaze. The body contracted more than the glaze. The glaze is under compression, and if the clay is thin it may bend as shown to relieve the pressure. If body contraction is only slightly greater than glaze contraction, nothing will happen.**



Figure

**If a glaze contracts much less than the body, the compression on the glaze becomes too much and the glaze will start to flake off like this (shivering). This may not happen by itself, but only if something hits the pot. Typically, the rim of a cup will easily chip off.**



**Figure**

**High compression of the glaze may also be relieved by cracking of the body.**

## **Moisture swelling**

**When the body has been exposed to humidity for a long period, water enters the body, which expands slightly (moisture swelling). This expansion causes the glaze to go into tension and it will craze. This kind of crazing is called delayed crazing.**

## **Solutions**

**As we saw above, crazing and shivering are caused by different rates of contraction and expansion (different CE's). The problems are cured by adjusting the CE of body and glaze, so that the two contract and expand more closely. It is best if the glaze is left under slight compression.**

## **Coefficients of expansion for various materials**

**Ceramic materials have different coefficients of expansion (CE). The following list shows the relative values for the most common:**

Na<sub>2</sub>O High CE contracts more in cooling.

K<sub>2</sub>O

CaO I

	.
BaO	
TiO <sub>2</sub>	
Fe <sub>2</sub> O <sub>3</sub>	
Al <sub>2</sub> O <sub>3</sub>	
PbO	
CuO	
MnO	
ZrO <sub>2</sub>	
SnO <sub>2</sub>	
P <sub>2</sub> O <sub>5</sub>	
ZnO	
MgO	
SiO <sub>2</sub>	↓ contracts less in cooling.
B <sub>2</sub> O <sub>3</sub>	Low CE

## Adjusting CE of glaze

**From this list we can see that if we replace soda (Na<sub>2</sub>O) with boron (B<sub>2</sub>O<sub>3</sub>) in a glaze we will lower the CE of the whole glaze. This can be done without changing the melting point of the glaze. Addition of silica will lower the glaze's CE but will also raise its melting point.**

**If shivering occurs, it means the CE of the glaze is too low. Adjusting it means adding soda ( $\text{Na}_2\text{O}$ ) and reducing boron ( $\text{B}_2\text{O}_3$ ).**

## **Adjusting body**

**Adjustment of body CE is not done according to the CE of the materials listed above. The contraction rate of the body depends to a much higher degree on the sudden reversible contraction of silica crystals when these change their crystal structure (cristobalite).**

## **Quartz change**

**Quartz is a crystal form of silica. Quartz is created in the body during firing when the clay crystal changes form and releases some of its silica. When quartz is heated it changes its crystal structure at  $573^\circ\text{C}$ . This happens very suddenly and is accompanied by a 1% expansion. On cooling to below  $573^\circ\text{C}$  it contracts again.**

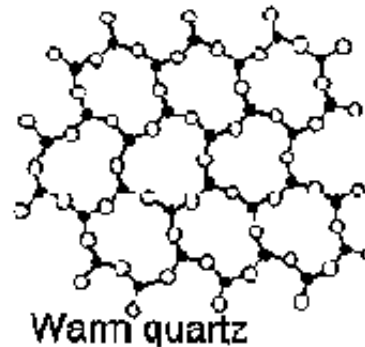
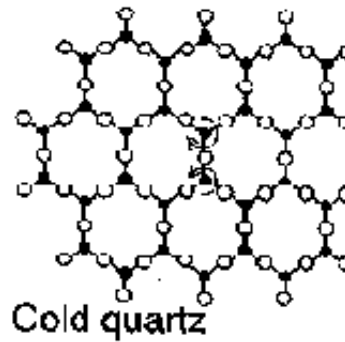

**Figure Figure 11.3.1.B The volume change of quartz is caused by a rearrangement of the bond between the atoms. At 573°C the angle suddenly shifts as shown.**

## **Cristobalite**

**Cristobalite is another crystal form of silica. It changes its size around 220°C and the volume change is nearly 3%. Cristobalite is created at temperatures above 900°C from silica released from the clay ( $\text{Al}_2\text{O}_3 \cdot 2\text{SiO}_2$ ) or talc ( $3\text{MgO} \cdot 4\text{SiO}_2$ ) or from quartz.**

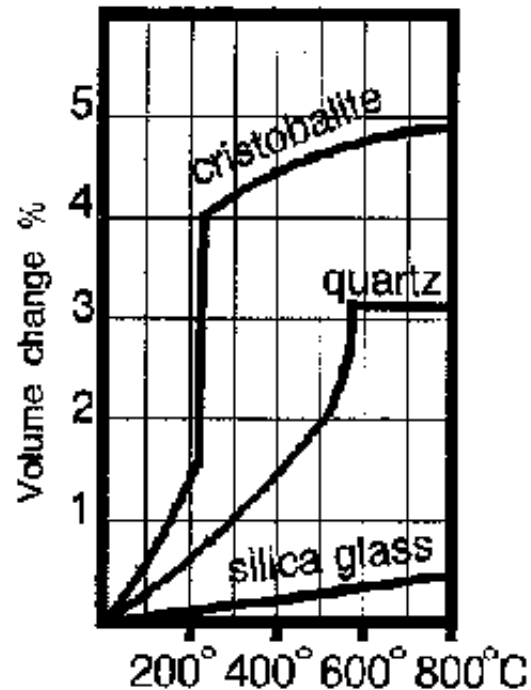

**Figure 11.3.1.C. The graph shows volume changes of three forms of silica. The two crystal forms change dramatically but silica in glass hardly changes.**

### **Body-glaze contraction**

**The two graphs below show how the body and its glaze contract during cooling. The graph in Figure 11.3.1.D shows a body that does not contain any cristobalite. At 573°C the body contracts suddenly due to the contraction of quartz, but at this temperature the glaze is still fluid enough to follow the contraction of the body.**

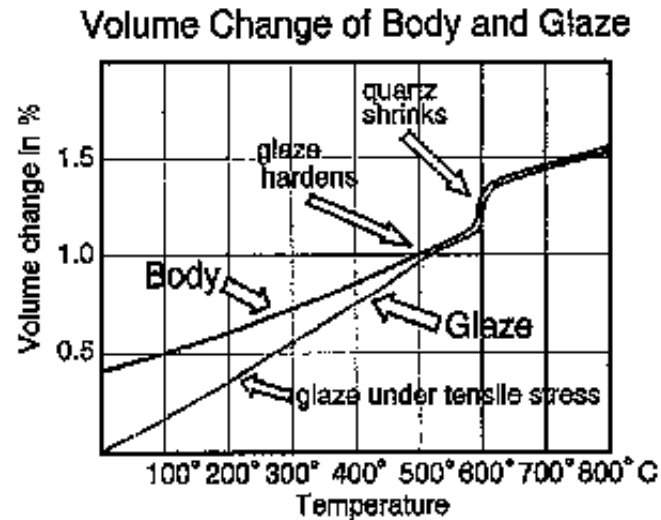

**Figure 11.3.1.D. Contraction of body and glaze during cooling. Glaze contracts more so it will craze.**

**Around 500°C the earthenware glaze hardens and from then onwards contracts according to its own CE. In this example the glaze has a higher CE than the body; it contracts more. This leaves the glaze under tensile stress; the glaze is smaller than the body. This will cause the glaze to craze.**

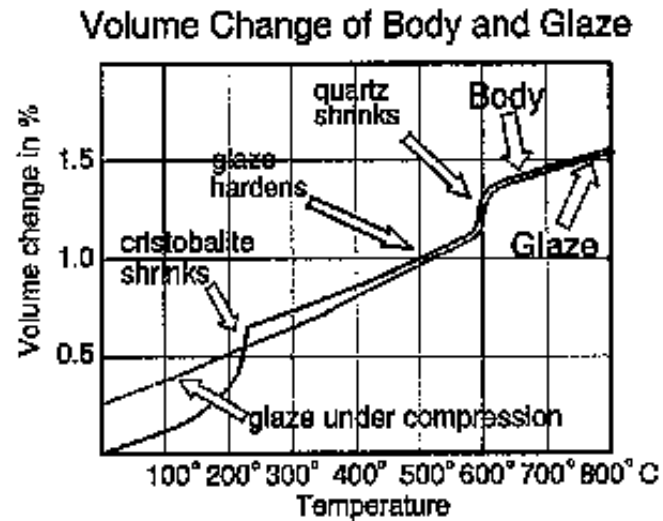

**Figure 11.3.1.E. The body in this graph contains crisotobalite and shows a sudden contraction at 220°C. This causes an overall higher contraction of body compared to glaze.**

**The graph in Figure 11.3.1.E shows contraction of a body containing crisotobalite. As above, the glaze first follows the quartz contraction, then hardens and starts to contract more than the body. However, at 220°C the crisotobalite change causes the body to contract, and at this temperature the glaze is hard so it is left under compression. This compression will prevent the glaze from crazing.**

### **Moisture crazing**

**After firing, the porous earthenware body will absorb moisture and this causes the body to expand. If the glaze is not under sufficient compression it will craze. Such delayed crazing may occur a long time after firing. The moisture expansion of the body is reduced by making the body more vitreous. Additions of talc or limestone to the body reduce moisture crazing.**



## **Crazing cure**

**For both types of crazing the cure is:**

- Add quartz (or silica), talc or limestone to the body.**
- Biscuit-fire to a higher temperature.**
- Glaze-fire to a higher temperature.**
- Add silica to the glaze.**
- In the glaze, replace fluxes with high thermal expansion, like soda ( $\text{Na}_2\text{O}$ ) and potash ( $\text{K}_2\text{O}$ ), with boron oxide ( $\text{B}_2\text{O}_3$ ).**

**It may seem strange that the cure for crazing is to add silica to both body and glaze. The reason is that adding silica to glaze makes it contract less, but silica added to the body causes the body to contract more.**

## **Crazing test**

**There are several ways to test how the expansion of glaze and body fit each other. The most simple ones are:**

- Rings of clay with a diameter of 5 to 10 cm are made with a small gap and biscuit-The gap is measured, the ring is glazed on its outer surface and refired. After firing the gap is measured to see if the ring has contracted or expanded. If the gap has become greater the glaze will craze.**
- Glazed samples are exposed to thermal shocks by repeated heating and cooling.**

**The thermal shocks can be from boiling water into ice water. The number of cycles**

**the sample can withstand before crazing indicates its craze resistance.**

**Another method is to heat the sample at first to 100°C then cool it in 20°C water. This is repeated while raising the temperature in steps of 10 or 20 degrees. The higher the heating temperature the sample withstands without crazing the longer it will be able to stay craze-free under normal conditions.**

**A rough guide is:**

120°C craze-free for 8 days

150°C craze-free for 100 days

180°C craze-free for 2 years

200°C craze-free for life

**Even if a sample survives the thermal shock test it may still craze due to moisture swelling. This can be tested in an autoclave which is simply a pressure cooker that can withstand higher pressures. A pressure cooker can be used instead. The glaze sample is placed in the pressure cooker with some water. It is kept under pressure for a period and then checked for crazing. The time it can withstand pressure without crazing indicates the time it may stay craze-free under normal circumstances. The following rough guide is for testing in an autoclave under a pressure of 3 atmospheres (about 3 bars). If using a pressure with, say, a pressure of 1.5 atmospheres the testing time in the table should be doubled:**

<b>Hours in autoclave</b>	<b>Expected craze-free life</b>
1	1 -2 years

2	2 -3 years
3	4 -6 years
4	9 -10 years
5	13-15 years

**All the tests provide only a rough indication of craze resistance. When you do the test you will develop your own procedure' which then should always be followed faithfully. In this way you will be able to compare your crazing test with your previous results.**

### **11.3.2. CRAWLING**

**Crawling appears as areas of clay that are not covered by the glaze. It may be small areas or, in extreme cases, the glaze may pull up into a pattern of small balls or islands, leaving bare clay in between.**

**Crawling is caused by:**

**Poor adhesion of glaze**

**Dusty or oily biscuit prevents the glaze from sticking to the body. Refractory oxides (chrome, rutile) or underglazes that act as a dust layer prevent the formation of an interface. Adding clay, borax or frit to the underglaze colorants helps.**

**High surface tension**

**High surface tension of the glaze in melting pulls it into islands before the clay/glaze interface forms. This is caused by certain oxides, especially magnesia, clay and zinc oxide. The solution is to replace magnesia by other materials, to calcine part of the clay or to use calcined zinc oxide instead of raw.**

### **Cracking of glaze layer**

**Extensive shrinkage of glaze in drying and early stages of firing, usually caused by too much clay content or by overgrinding the glaze, causes the glaze to crack and separate from the body. A thick glaze layer is more likely to crack.**

### **11.3.3. PINHOLING AND BLISTERING**

**Pinholes appear as tiny holes in the glaze surface. Blisters look like frozen bubbles or craters. They are a problem in utilitarian ware, as they collect dirt. They may be only on the surface of the glaze or may penetrate to the clay layer.**



a) Section of glaze and body with two air holes. The one close to the surface rises.

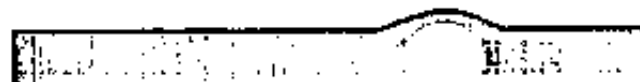

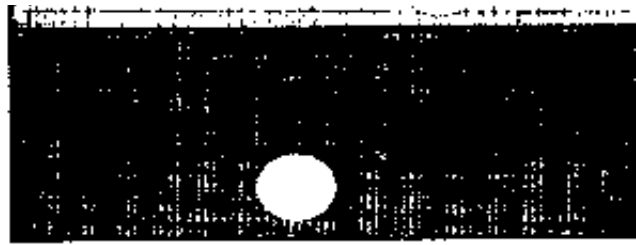

b) The air bubble pushes through the melted glaze.



c) The bubble has burst and left a crater.

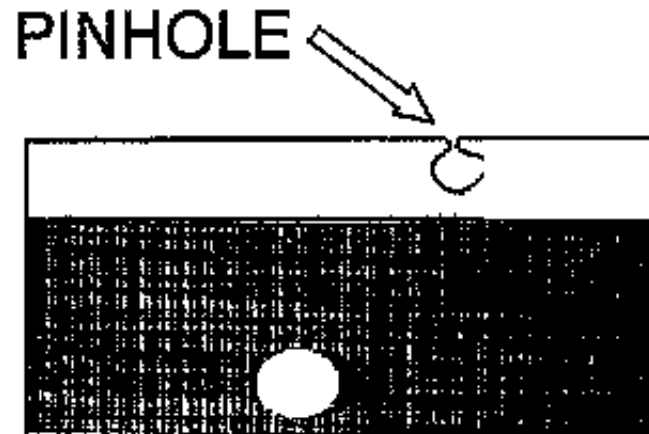

**Figure 11.3.3.A. Pinholing.**

## Pinholes

**During firing gas bubbles are formed in the melted glaze. The bubbles will move to the surface of the fluid glaze and be released.**

**If you watch any glaze melting, you can actually see this process. Some glazes (especially those containing raw borax) foam and boil until they finally smooth out. When the firing is stopped before the glaze has had time to heal over, a pinhole or crater is left (see Fig. 11.3.3.A). Since overfiring also causes pinholes it is better to keep the maximum temperature for some time (soaking period).**

**The main sources of the gas are:**

- After glazing, a large volume of air exists in the space between the solid glaze materials. The air gathers into bubbles during sintering and melting.**
- Release of sulfates and carbon in the body and from some of the glaze materials.**
- Air bubbles in the body introduced by improper handling of the casting slip.**
- Sulfates and carbon from the fuel may deposit in the body during the initial stages of firing. Above 900°C the gas will be released.**

**It is important to find out if the problem is in the glaze or in the body. Relatively large pinholes that go all the way to the body are usually caused by small holes in the body that do not accept the glaze-this is most common with slip-cast ware, or with common red clay that contains particles of organic matter, sand or mica.**

**Problems arise if the glaze starts to cool and solidify while bubbles or craters are still forming.**

**Detailed causes and solutions are given in section 11.2.3.**

#### **11.3.4. COLOR CHANGES**

**Potters are often plagued by changes in glaze color, either within the same kiln-load or from separate firings.**

**Often this problem can be traced to glaze preparation. The colors may not be ground finely enough, weighing may be incorrect, raw materials may have changed.**

**Otherwise, the problem usually is due to more or less reduction than usual. This is one of the most difficult conditions to control in firing and depends completely on the skill of the firemaster.**

**The problem is worst in glazes that contain color oxides that are sensitive to reduction. The most sensitive is copper, which is green in oxidation and red in reduction; and iron oxide, which is yellow, red to brown in oxidation and mottled red-brown, grey to blue or green in reduction. Other oxides change less.**

**Heavy reduction will darken the iron in the body, which will affect the glaze, also darkening it. Sometimes a pot will be dark on the reduced side and light on the oxidized side.**

**Other causes and solutions are given above.**





## Glazes - for the Self-reliant Potter (GTZ, 1993, 179 p.)

### 12. Developing glazes

 *(introduction...)*

 12.1. Modifying existing glazes

 12.2. Basic equipment

 12.3. Testing methods

 12.4. Developing a base glaze

 12.5. Modifying a base glaze

 12.6. Colored glaze

## Glazes - for the Self-reliant Potter (GTZ, 1993, 179 p.)

### 12. Developing glazes

**Most potters do not know much about glaze chemistry and are usually afraid to develop their own glazes. It is true that glaze chemistry is difficult to understand without a background in chemistry. Still, a simple knowledge of fluxes, stabilizers and glass formers and how they combine to make glaze is useful. It will give even the nontechnical potter an idea of how to approach glaze problems and develop new colors and textures. The reader with more technical background can make use of the Seger formula for a more sophisticated approach to glazes.**

**Remember that glaze chemistry is something new in the history of ceramics. Before it existed, potters found out how to make glazes by trial and error, without**



**modern methods of analysis or even accurate methods of weighing.**

**It is also true that once glaze recipes were developed they were closely guarded secrets. A special glaze that no one else could duplicate gave an advantage over the competition. The modern systematic, scientific approach to glaze development has largely made "secret" glazes obsolete because the action of the various glaze ingredients is now well known.**

**On the other hand, glaze making is very much like cooking. The same recipe may produce very different results when prepared by two different cooks! Standard glaze recipes as published in books often do not work because of differences in raw materials, firing technique etc. Just as a good cook should know how to substitute materials, a good glaze maker can develop an intuitive knowledge of glazes. Like most things, this only comes from hard-won experience. Potters should not be afraid to experiment with glaze development, although most of them simply do not have the time to take away from production. The following chapters describe standard approaches to glaze development and will be useful to those who want to experiment with glazes.**

### **12.1. Modifying existing glazes**

**The easiest approach to working with glazes is to start by modifying existing glazes. These may be new recipes from books, or recipes that you are already using. Although you can take a trial-and-error approach, this takes a lot of time and money, and results are largely a matter of luck. It is best to use some of the systematic methods presented below and knowing even a little about the nature of the various glaze materials will help you reach your goal more efficiently.**

## **There are three approaches to modifying glazes:**

- You have a goal for a particular surface, color, texture etc.**
- You have a glaze problem that needs to be corrected.**
- You have no special goal but just want to see what happens when you change the recipe.**

## **12.2. Basic equipment**

**The minimum equipment required for glaze testing is:**

- Accurate balance, either a triple beam balance or a goldsmith's balance with weight. Spring-type scales are not accurate enough for weighing glazes.**
- A mortar and pestle for grinding materials. These should be porcelain, so that they do not contaminate tests.**
- A 100-mesh sieve. This can be bought ready-made, or you can make your own using brass or stainless steel screen.**
- Firing can be done in your regular glaze firing.**

## **12.3. Testing methods**

### **12.3.1. TEST PIECES**

**The type of test piece you use is largely a matter of personal preference. In order to show glaze behavior under various circumstances, it should have:**

- **A horizontal and vertical surface.**
- **A textured area.**
- **A hole to tie it. This helps to keep similar tests together for future reference.**
- **An area for labeling. It is best to write the full recipe of the test on each test tile (with a brush and iron oxide and water, or chrome oxide or engobe etc.) since code numbers often get confused and notebooks get lost.**

**The first step in understanding your materials is to fire all available materials in small bowls at your standard glaze firing temperature.**

**A small quantity of each material (ground and sieved through 100 mesh) is placed dry in the bowl. This will show you which ones melt alone, and which ones remain as powder. Most of the materials will not melt but may change in color or may react with the clay. Only the strong fluxes will melt by themselves -other materials that do not melt may be fluxes, but only in combination with other materials.**

### **12.3.2. LINE BLENDING**

**Line blending is a systematic way of finding out the reactions of two different materials (or mixtures of materials).**

**The easiest way is to prepare the two materials by grinding, sieving and mixing them with water in two separate containers. To make the line blend, the materials are mixed by volume (using a small spoon) and applied on a test tile, starting with one material alone and adding the other material in equal steps. Since the tests are measured by volume it is important that the same amount of water is added to**

## the two line blend materials.

Glaze half of the test tile twice to show variation in glaze thickness.

<b>MATERIAL</b>	<b>PARTS BY VOLUME (number of spoonfuls)</b>										
material A	0	1	2	3	4	5	6	7	8	9	10
material B	10	9	8	7	6	5	4	3	2	1	0

### Line blend 10 steps

An example of a line blend in 10 steps, which gives the full range of combinations of 2 materials, is shown in the table above.

The most common use of the line blend is to find out the effect of one material in a standard glaze recipe. If material A is the standard glaze recipe, material B could be the standard glaze + a coloring oxide addition of 5-10%.

### Line blend 5 steps

Usually, 5 steps will be enough for the first test. In this example material A is the basic glaze, material B is the basic glaze + 10% copper oxide.

	<b>PARTS BY VOLUME</b>						
<b>Test Number</b>	<b>A</b>	<b>B</b>	<b>C</b>	<b>D</b>	<b>E</b>	<b>F</b>	
GLAZE		0	1	2	3	4	5
GLAZE							

+ 10 % CuO	5	4	3	2	1	0	
CuO in test	10 %	8 %	6 %	4 %	2 %	0 %	

## Mixing procedure

- **First prepare a line blend mixing card like the one above.**
- **Prepare the two mixtures as usual and add the same amount of water to each.**
- **Place the two materials in bowls in front of you, glaze A to your left and glaze B to your right.**
- **In the middle place an empty bowl into which you pour the spoonfuls from the two other bowls according to the number for each test on your line blend card. Keep track of the spoon counting by marking the line blend card.**
- **Stir the test mixture well.**
- **Mark a test tile with the mixture's test number (date + serial number).**
- **Glaze the test tile.**
- **Discard the remaining glaze and continue with the other line blend mixtures.**

## Calculation example

**In the case above it was easy to calculate the copper oxide addition in each of the tests. When more complex mixtures are used in a line blend the calculation becomes more complicated. Here is an example of mixing two glazes:**

Glaze A: Frit X 70  
           feldspar 15  
           quartz 5  
           kaolin 10  
 Glaze B: Frit Y 80  
           zircon 10  
           kaolin 10

	<b>PARTS BY VOLUME</b>					
Test Number	A	B	C	D	E	F
GLAZE A	0	1	2	3	4	5
GLAZE B	5	4	3	2	1	0

**After firing, test number D turned out to be the most interesting. We now want to test a larger amount of this and the recipe is calculated in this way (see table next page):**

<b>TEST D</b>	<b>PARTS</b>	<b>FRIT X</b>	<b>FRIT Y</b>	<b>FELDSPAR</b>	<b>QUARTZ</b>	<b>ZIRCON</b>	<b>KAOLIN</b>
GLAZE A	3	210	-	45	15	-	30
GLAZE B	2	-	160	-	-	20	20
TOTAL PARTS	5	210	160	45	15	-	50
NEW GLAZE D	1/5	42	32	9	3	4	10

**Materials in glaze A were multiplied by 3 and those in glaze B by 2.**

**The sums of each material were then divided by 5 and the final recipe is:**

Test D: Frit X	42%
Frit Y	32
Feldspar	9
Quartz	3
Zircon	4
Kaolin	10

**The recipe is based on a line blend test measured by spoonfuls. That is not very accurate so, before going any further, the test result should be retested by weighing the dry materials.**

### **12.3.3. TRIAXIAL BLENDING**

**Triaxial blending is a method of testing varying amounts of three different materials or colors.**

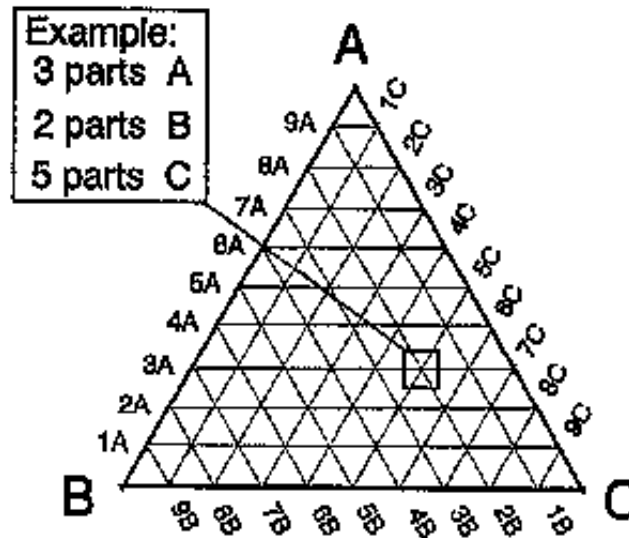
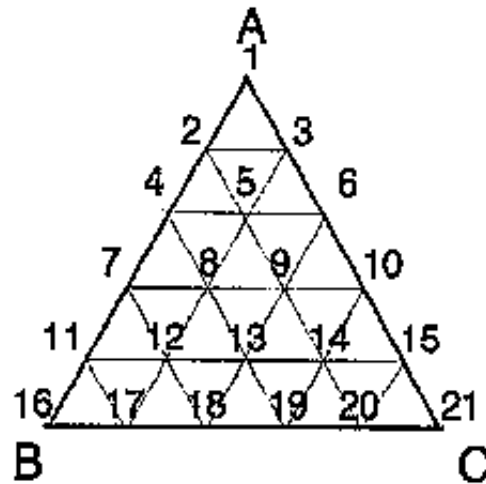

**Figure 12.3.3.B. A triaxial blending chart system with 10 steps. Composition of a test at an intersection is found by following the lines to the periphery of the triangle.**

**Each corner of the triangle represents 100% of the material. Each side of the triangle is the line blend of the materials at its ends, and the intersections inside the triangle represent combinations of all three materials. So the result is three line blends, plus all the combinations. Fig. 12.3.3.B is an example of a biaxial system with 66 tests.**

**The system is better explained by an example. You may have a basic opaque glaze and you want to see how it responds to 3 different coloring oxides: cobalt oxide, copper oxide and iron oxide. In this case we use a simple biaxial blend with only 21 tests as shown in Fig. 12.3.3.C.**





**Figure 12.3.3.C. triaxial system with 5 steps. The number at each point refers to the test number on the triaxial blending card.**

**The procedure is:**

- **Prepare a biaxial blending card as shown.**
- **Prepare 3 mixtures of basic glaze with oxide additions:**

**A glaze + 5% cobalt oxide**

**B glaze + 10% iron oxide**

**C glaze + 10% copper oxide**

- **Add same amount of water, screen 100 mesh.**

- Place 3 bowls with the mixtures in front of you: B on the left, C on the right, A in the center. Right in front of you place an empty bowl.
- Have all test tiles numbered and arranged in sequence near by.
- Collect teaspoonfuls of each mixture; A,B,C according to the numbers on the biaxial card. Mark each time you have finished collecting from each bowl.
- The mixture is collected in the empty bowl.
- Stir the mixture, pick the test tile with the right biaxial blend number.
- Glaze the test tile.

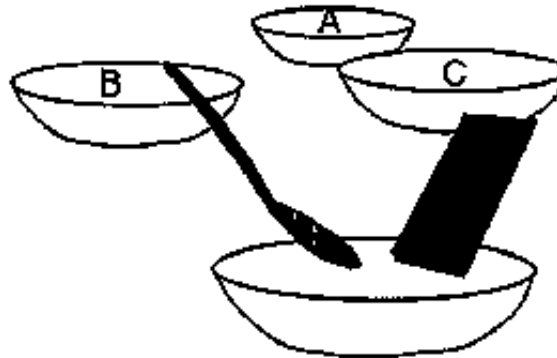

Figure 12.3.3.D. Arrangement of bowls for triaxial mixing.

Getting the right number of spoonfuls into the collection bowl for each test takes a lot of concentration. A mixing card as shown below helps you to keep track of your progress with the spoon counting.

	TRIAxIAL BLENDING CARD																				
TEST NUMBER	1	2	3	4	5	6	7	8	9	10	11	12	13	14	15	16	17	18	19	20	21
MATERIAL	NUMBER OF SPOONFULS																				
MIXTURE A	5	4	4	3	3	3	2	2	2	2	1	1	1	1	1	0	0	0	0	0	0

MIXTURE B	0	1	0	2	1	0	3	2	1	0	4	3	2	1	0	5	4	3	2	1	0
MIXTURE C	0	0	1	0	1	2	0	1	2	3	0	1	2	3	4	0	1	2	3	4	5

**If you want to know the recipe of one of the tests, say number 14, you calculate this in the same way as for line blends:**

		<b>PARTS</b>	<b>GLAZE</b>	<b>COBALT O.</b>	<b>IRON O.</b>	<b>COPPER O.</b>
MIXTURE A	1	100	5		-	-
MIXTURE B	1	100	-		10	-
MIXTURE C	3	300	-		-	30
TOTAL		5	500	5	10	30
D RECIPE	total/5	100 %	+ 1 %		+ 2 %	+ 6 %

**Once you get used to working with biaxial blends, you will be able to read the percentage directly from the triangular chart.**

**This biaxial blend was based on only 21 variations. Out of these only 6 were blendings of all three mixtures; the rest were simply line blends involving only two mixtures. A larger biaxial blend system would produce more intermixing of all three materials, but also a lot of extra work. However, you could use a system with 10 steps on each side as shown in Fig. 12.3.3.B, but leaving out the line blends A-B, A-C and B-C, and only blend the 36 tests in the center of the triangle.**

#### **12.3.4. KEEPING RECORDS**

**The key to experimenting with glazes is keeping accurate records and labeling them in such a way that the actual tests can be compared with your notebook.**

**As mentioned above, it is best to write the entire recipe on the test tile itself, along with the date of testing. This is possible with a simple test like adding coloring oxides to your basic glaze. For more complicated tests and line blend or biaxial blend tests, you will have to rely on the test number on the tile. Mark the date, the number and, if you do more than one test a day, add a serial number. In your notebook, the date and recipe are also written.**

**Make it a habit to take notes of the fired results immediately after unloading the kiln. Write down firing conditions, location of test tile in the kiln, and your impression of the glaze. Is it well melted, running, pinholes or tendency to crawl? Use a whole sheet of paper for each test or test series. Finally write down your conclusion like "make 1 kg test batch", "test again with 5% increase of clay". You could make a standard record form like the one in Fig. 12.3.4.B.**

**Testing is costly and the records help you to avoid unnecessary tests. When planning your next test, first take a look at your earlier results and compare them with your notes. When deciding which materials to add or which to decrease you may check with the oxide list below (page 122). As long as you work with one particular problem or line of research keep the test tiles close by for easy reference. Once you have finished the research you can store all the tests together by hanging them on a string in chronological order.**

Glaze Test Record									
name: .....					test no: .....				
prepared by .....					date: .....				
Material	1	2	3	4	5	6	7	8	9
Maturity									
Surface									
Viscosity									
Crawling									
Crazing									
Colour									
Firing temperature .....					°C Cone: .....				
Conclusion: .....									
.....									

Figure 12.3.4.B Example of glaze test record form.

**12.4. Developing a base glaze**

**The first step in developing a new glaze is to develop a base glaze, which is simply the combination of materials that melts at the desired temperature (without addition of colorants). Here, we describe an approach to making base glazes without knowing anything about the chemical composition of the materials.**

**Since all glazes require flux, stabilizer and glass former, these three materials are the starting point. There are a large number of fluxes available (divided into primary and secondary' fluxes), but the stabilizer is usually china clay (kaolin) and the glass former is usually quartz (silica). The main differences are between low temperature and high temperature glazes. Below only the main materials (not chemicals) are mentioned. This list is a rough guide only.**

### **Low temperature (900-1100°C)**

**Low temperature glazes require more flux and stronger flux than high temperature ones.**

- primary flux: red lead, white lead, borax or boric acid, soda ash, gerstley borate (calcium borate), or most often frit (either lead, borax, or lead borosilicate).
- zinc oxide, barium carbonate, limestone, marble dust, talc.
- secondary flux:
  - china clay or other clay.
- stabilizer:
  - glass quartz, window glass powder.
- former:

### **High temperature (1100-1300°C)**

- primary flux: feldspar, nepheline syenite, fusible clay, wood ash.
- secondary flux: zinc oxide, barium carbonate, limestone, marble dust, talc.
- stabilizer: china clay or other clay.

- glass former: quartz.

**In the appendix there is a selection of glazes that can be used as a starting point for developing new glazes.**

### **12.4.1. SELECTION OF MATERIALS**

**Materials necessarily have to be selected from what is available in your area, as most potters do not have access to suppliers with everything on hand.**

**When selecting materials to use in glazes, a general rule is to use materials that supply more than one oxide. For example, if magnesia ( $\text{MgO}$ ) and silica ( $\text{SiO}_2$ ) are both required, it is better to use talc ( $3\text{MgO} \cdot 4\text{SiO}_2$ ) than magnesium carbonate and quartz. This is because the elements are already combined and contribute to a better glaze melt.**

**The biggest trouble with glazes is not to develop a nice new glaze but to keep it nice. Most materials vary from batch to batch and some materials may not be in regular supply. Therefore try to base your basic glaze on materials that you can rely on. Chemical stores often have ceramic oxides, but in a chemically pure form that is always very expensive. Instead look for the natural mineral containing the same oxide.**

### **12.4.2. USING GENERAL RECIPES**

**There are hundreds of books on ceramics, most of which have recipes for glazes.**

**These are limited in their usefulness, as often the raw materials are not available or are different from what you have in your country. Most of the time, these recipes do not work as expected and require modification. Without knowing the chemical analysis of materials, it is still possible to develop good glazes, using standard ones as a starting point and then modifying them systematically using the methods below.**

<b>LINE BLEND</b>	<b>PARTS BY VOLUME</b>										
<b>TEST NO</b>	<b>A</b>	<b>B</b>	<b>C</b>	<b>D</b>	<b>E</b>	<b>F</b>	<b>G</b>	<b>H</b>	<b>I</b>	<b>J</b>	<b>K</b>
GLAZE	10	9	8	7	6	5	4	3	2	1	0
GLAZE + 30 % ZnO	0	1	2	3	4	5	6	7	8	9	10
ZnO% IN GLAZE TEST	0	3%	6%	9%	12%	15%	18%	21%	24%	27%	30%

### **12.4.3. TESTING 2, 3 OR MORE MATERIALS USING LINE OR TRIAXIAL BLENDS**

**Line blends are the best place to start. A recipe for a glaze is made up, and then one material is selected to test in a line blend. It is added in steps, starting with a small amount and working up to perhaps 50% of the total, as described in section 12.3.2. This will give a range that may produce interesting results.**

**For example, use the following recipe from Ali Sheriff, Tanzania, for an unfritted borax glaze:**

Boric acid        30%

Potash feldspar 25



Quartz	15
Dolomite	20
Ball clay	10

**You might decide to see the effect of adding zinc oxide to the glaze. As a start a 10-step line blend is usefull (see the table above).**

**From this line blend you will get a good idea of how zinc oxide works in your basic glaze. Try the same with some more materials that are available like talc, limestone and zircon. From these line blends you will have a general idea of the amount of oxides which can be added.**

**The next step could be to try 2 or more materials in a biaxial blend. You might decide to try zinc oxide and talc. In this case, one point of the triangle would be 100% glaze, another point zinc oxide and the third point talc.**

#### **12.4.4. EVALUATING AND CARRYING OUT TESTS**

**After you finish a test, the next step is to evaluate it and decide how to proceed. Usually there will be at least one result that looks promising and, if you are really lucky, you might get a usable result the first time. Usually the best result from the first test will be the basis for further tests.**

**For example if your zinc oxide line blend showed an almost-good glaze with 6% zinc oxide, you might want to try another line blend with smaller variations below and above 6% (see table below).**

<b>LINE BLEND</b>	<b>PARTS BY VOLUME</b>
-------------------	------------------------

TEST NO	A	B	C	D	E	F	G	H	I	J	K
A: GLAZE + 3% ZnO	10	9	8	7	6	5	4	3	2	1	0
B: GLAZE + 9 % ZnO	0	1	2	3	4	5	6	7	8	9	10
Zn % IN GLAZE TEST	3%	3.6%	4.2%	4.8%	5.4%	6.0%	6.6%	7.2%	7.8%	8.4%	9%

**If this is still not satisfactory, you might take the best result as the new base glaze and try to improve it in a new line blend, using another raw material. When deciding which materials to try, study the oxide list (page 122). Under each oxide you will find a list of its effects and you then choose accordingly. If your glaze is too stiff (high viscosity) you look for materials with low viscosity etc.**

## **12.5. Modifying a base glaze**

### **12.5.1. MATT GLAZE**

**Matt glazes have non-reflecting, dull surfaces, like eggshell, paper or river rocks (page 35). This kind of surface is called "matt". Matt glazes are especially popular for decorative ware, and for floor tiles because they are not slippery.**

**Matt glazes are developed in several different ways:**

#### **Underfired matt glaze**

**Most glazes that are fired below their maturing point become matt. In a similar**

**way, overloading the glaze with a glaze material will produce a matt surface, because the material will act as a refractory that cannot be dissolved in the glaze melt.**

- The addition of kaolin will produce a rather dull matt, but above 1200°C a smooth, alumina pleasing matt is possible.

matt:

-silica Excess amount of silica will cause small silica crystals to settle out of the melt during cooling. Alumina content should be low. If silica content is too high, the glaze will be matt from underfiring.

## **Crystalline matt glaze**

**During slow cooling, the glaze develops small crystals on the surface, which break up light and appear matt. These glazes are usually smoother than underfired matt glazes. If cooling is too rapid, crystals may not have time to develop, and the glaze will be glossy.**

- barium matt: Barium carbonate is a common material to produce matt glazes, usually in amounts of 15-40 %. It is almost impossible to achieve a transparent matt glaze, but with luck it can be done with barium carbonate. Barium matt glazes are sensitive to firing conditions and it is better used together with other matting agents like zinc oxide and titanium dioxide.

- zinc matt: For low temperatures zinc oxide is a reliable agent for matt glaze. At temperatures above 1150°C it tends to build too large crystals, but a high alumina ( $\text{Al}_2\text{O}_3$ ) content will reduce the size of the crystals. Pure zinc matt

glazes are soft and not acid-proof, so for dinnerware it should be used in combination with other matting agents.

- titanium matt: Addition of 8-15% titanium dioxide will make a transparent glaze matt. The oxide easily combines with any iron in the body producing yellow to brown colors.
- calcium matt: The range of addition is 10-30% whiting ( $\text{CaCO}_3$ ) or 20-40% wollastonite ( $\text{CaO SiO}_2$ ). Bone ash ( $\text{Ca}_3(\text{PO}_4)_2$ ) will produce smooth matt glazes for low temperatures when added to the frit.
- magnesium matt: Magnesium carbonate (magnesite  $\text{MgCO}_3$ ), talc ( $3\text{MgO } 4\text{SiO}_2 \text{ H}_2\text{O}$ ) 10-18%, dolomite ( $\text{CaCO}_3 \text{ MgCO}_3$ ) often produce smooth, "buttery" matt glazes above 1000° C.

**With a high amount of matting agent, the surface may turn too dull matt. This can be countered by either adding clay (alumina) that will reduce the crystal size or by reducing the matting agent.**

### **Combining matting agents**

**A combination of matting agents will produce matt glazes less sensitive to firing conditions, harder and with better acid resistance. Below recipes of four different mixtures are suggested. The materials are premixed and added together to the glaze in amounts of 10-30%:**

- Zinc oxide 50
- Kaolin 50
- Mixed and calcined above 800°C

- Titanium dioxide 40  
Whiting 30  
Zinc oxide 30

- Titanium dioxide 30  
Tin oxide 30  
Zinc oxide 30

- Barium carbonate 40  
Whiting 20  
Zinc oxide 20  
Talc 20

**The different mixtures are added to the glaze in line blends.**

### **12.5.2. OPAQUE GLAZE**

**"Opaque" means you cannot see through the glaze. Opacity is developed by:**

#### **Opacifiers**

**These are finely ground materials that do not enter the glaze melt but remain as small white particles suspended throughout the glaze. They reflect light and make the glaze opaque. Standard opacifiers are:**

- **Tin oxide ( $\text{SnO}_2$ ), addition 3-10%. Tin oxide is very expensive and is hardly used in the ceramics industry. It works well in combination with other opacifiers and produces a soft white color.**
- **Zircon (zirconium silicate,  $\text{ZrSiO}_4$ ) is the main opacifier, addition 10-30%. It is used instead of the more expensive zirconium oxide ( $\text{ZrO}_2$ ). Soda and potash content should be low. Very fine grinding promotes opacity. Commercial opacifiers are normally extremely finely ground zircon. It is better to add the zircon to the frit, but this may not be practical.**
- **Titanium dioxide ( $\text{TiO}_2$ ), addition 5-10%. Produces a creamish color and combines easily with iron in the body. Works well in combination with oxides of zinc, calcium and magnesium, especially in boron glazes. Opacifying effect depends on crystals forming during cooling.**
- **Bone ash (calcium phosphate,  $\text{Ca}_3(\text{PO}_4)_2$ ), addition 5-15%. In amounts above 5% it may cause blistering and crawling in low temperature glazes and it is better added to the frit.**

**A variety of combinations of zinc, calcium, magnesium and titanium dioxide produces opacity in boron glazes. Zircon may be added (5-10%) to increase opacity further. By such combinations it is possible to produce a reliable zircon-based opaque glaze without the pinholing trouble otherwise seen with zircon glazes.**

### **12.5.3. CRYSTAL, CRACKLE GLAZE:**

**Crystal (or crystalline) and crackle glazes are used for special effects.**

## **Crystalline glazes**

**Crystals develop in glazes that are low in alumina and that are cooled slowly. Usually these are small crystals that produce matt glazes.**

**Very large crystals, from a few mm to several cm long, can be formed in special glazes. These glazes are fired to their maturing point, soaked for several hours and then cooled very slowly. That gives the crystals time to grow. To further increase the size of the crystals, the temperature can be kept slightly below the glaze's maturing point for several more hours. The outcome is very uncertain and many test firings are needed before the right firing and cooling method is developed.**

**Large crystals only grow in a very fluid glaze melt. So the glaze should contain little alumina and little silica but a large amount of flux. The best fluxes are lead, lithium, soda and potash.**

**The main agents for crystal formation are zinc oxide (20-30%) and titanium dioxide (5-15%). Lithium, calcium, magnesium and barium are supportive additions.**

## **Crackle glazes**

**These are glazes that craze, which are popular for decorative pottery. Crackle glaze should not be used on pots for food.**

**Most glazes can be made to craze by decreasing the quartz or increasing high-expansion oxides like soda and potash (see page 95 on crazing). Rapid cooling of the kiln helps to produce fine patterns of crazing.**

**To enhance the crackle, pots can be soaked in strong tea, or ink can be rubbed into the lines. Reglazing and refiring crackled pots with a contrasting glaze sometimes result in interesting patterns.**

## **12.6. Colored glaze**

**Colored glazes are developed by adding coloring oxides. These are added to the base glaze as a percentage, based on the range for each oxide as listed below. Different oxides have different strengths, so some of them are used in much larger amounts than others.**

**For example, you might want a brown glaze. Looking at the list of oxides, you find that brown can be developed with iron oxide from 5-10%. This can be done as a line blend, adding 5,6,7,8,9 and 10% to the base glaze. The percentage is in addition to the total base glaze weight:**

Glaze      100 g

Iron oxide 6%

$$\mathbf{100g \times 0.06 = 6g}$$

$$\mathbf{Glaze + oxide = 106 g}$$

**Ready-made glaze pigments, called glaze stains, are also used to develop colors**



**that cannot be made easily with oxides alone.**

### **12.6.1. LIST OF OXIDE ADDITIONS**

**It is more or less impossible to give an accurate guide to colors in glaze, because there are so many variables of chemical reaction in different base glazes.**

**The firing conditions, temperature and oxidation/reduction also greatly influence the color of the glaze.**

**The table below should be considered a rough guide. See also chapter 13 for color reactions in different types of base glazes.**

<b>Single oxides</b>	<b>Percent</b>	<b>Effects</b>
Iron oxide, Fe <sub>2</sub> O <sub>3</sub>	1 - 5 %	Green, cream, light brown
	5 - 10 %	Brown, red-brown
	10 - 15 % %	Dark brown, black
Cobalt oxide, CoO	0.2 - 3 % %	Blue
Cobalt carbonate, CoCO <sub>3</sub>		
Manganese dioxide, MnO <sub>2</sub>	2 - 10 %	Brown, purple-brown
Manganese carbonate, MnCO <sub>3</sub>		
Rutile, TiO <sub>2</sub>	1 - 10 %	Yellow, tan, mottled colors

Chrome oxide, $\text{Cr}_2\text{O}_3$	1 - 5 %	Green
Copper oxide, $\text{CuO}$	0.5 - 5 %	Green, blue, red in reduction
Copper carbonate, $\text{CuCO}_3$		
Nickel oxide, $\text{NiO}$	0.5 - 3 %	Gray, green-brown
Ilmenite, magnetite (contains iron)	1 - 10 %	In granular form produces speck and spots in the glaze.
Antimony oxide, $\text{Sb}_2\text{O}_3$	1 - 5 %	Cream to yellow in lead glazes

## 12.6.2. LINE, TRIAXIAL BLEND PLANNING

**The most interesting colors often come from combining 2 or more oxides in the same base glaze. Usually it is best to test the base glaze first with various oxides alone and to use the best results in combination with each other. Line blends are useful for this kind of test, and biaxial blends can also be used for 3 oxides in combination (see page 105, 107 for details on line and biaxial blending).**

### One-color line blend

**For testing a color oxide, you prepare two mixtures for a line blend.**

### Example:

Mixture A: 100 parts your basic glaze

Mixture B: 100 parts basic glaze

10 parts titanium dioxide

**Make line blends with all the coloring oxides you have. After firing, you will have a good idea of the color range you can get with your basic glazes. Maybe you will already now have all the colors you need. If you want to try a combination of several oxides you can do this by line blends or biaxial blends.**

### **Two-color line blend**

**Choose one of the colors you got from your first set of line blend testing. Make this your basic glaze and then try another coloring oxide in addition to this.**

### **Example:**

Mixture A: 100 glaze

Mixture B: 100 glaze

4 copper oxide

5 iron oxide

**Note that when mixing several coloring oxides their total amount should normally not exceed 10% of the glaze.**

**This type of Line blending can be continued with any combination of oxides. Do it one step at a time with only one or two line blends at a time in your regular glaze firing. After firing you can choose the best results and do more tests along those lines.**

## **Triaxial blend**

**From your first set of line blends choose three coloring oxides and test their combinations in a biaxial blend. When setting up the biaxial blend, make the points A, B and C with oxide additions about 30% higher than what you expect to use in the final glaze.**

**You can even try four color oxides in one biaxial blend.**

### **Example:**

**Your line blend showed that 1.5% addition of cobalt oxide produced a nice blue, but you want to modify it with other color oxides:**

**Base glaze: glaze + 1.5% cobalt oxide**

**A: base glaze + 6% iron oxide**

**B: base glaze + 5% copper oxide**

**C: base glaze + 8% titanium dioxide**

**After doing the tests you have to calculate the final recipe. This is done by setting up a calculation table as shown on page 109.**

## **12.6.3. COLOR PIGMENTS**

**Glazes can be colored by adding metallic oxides directly to them. Some oxides can be used as on-glaze colorants by painting them directly on the unfired glazed object.**

**Ceramic pigments are produced from the same coloring oxides, but other materials are added in order to change the colors and make them more stable or cheaper.**

**The materials used for pigments can be divided into four groups:**

### **Color agent**

**- metallic oxides; for example, iron oxide, copper oxide.**

### **Modifier**

**- influences coloring effect of oxides. Examples of modifiers: titanium dioxide, zinc oxide, zirconium oxide, antimony oxide.**

### **Filler**

**- raises melting point of the pigment and stabilizes the coloring oxides. Examples of fillers: alumina, quartz, feldspar, clay body.**

### **Flux**

**- lowers melting point of the pigment. Examples of fluxes: borax, lead, frit or glaze.**

**Fluxes are added according to the use of the color pigment. The pigments can be adjusted for use as:**

### **Under-glaze colorant:**

**- The pigment is painted directly on the raw or biscuit-fired body and a glaze is applied on top.**

**Maiolica or on-glaze:**

- **Decoration on the unfired glaze layer.**

**Overglaze enamel:**

- **Applied to the already fired glaze.**

**In-glaze colorant:**

- **Added to a basic glaze as a coloring agent.**

**Production of Color pigments**

**Close production control, accurate weighing and the use of the right materials are especially important when producing color pigments. Even slight deviations may result in the change of a fired colour.**

**Four main processes are used in the production:**

- 1) Mixing of raw materials**
- 2) Calcination**
- 3) Washing**
- 4) Grinding**

**Mixing**

**If all raw materials of the recipe are already finely ground mixing can be done manually ensuring good mixing by screening the batch twice through 60 mesh. Normally materials will be coarse, so after weighing out the pigment recipe the batch is ball-milled.**

**After milling drying and calcination follow.**

## **Calcination**

**The calcination will burn away carbonates' water, sulfates and the coloring oxides will form new crystalline combinations with the other materials in the batch. This will stabilize the colors so that they will not be easily dissolved in the glaze.**

**The temperature of calcination is in the range of 700°C to 1400°C. In general, the color pigment should be calcined at least to the temperature at which it is going to be used and preferably higher. Some colors will disappear if fired high whereas other colors will only develop correctly at 1300°-1400°C.**

**Calcination is done in small saggars or clay pots with a lid. The pigments are fired in a small kiln (e.g. test kiln) to the desired temperature or in the hot spots of the normal production kiln.**

## **Washing**

**After calcination the sintered pigments are crushed to sand size and then washed with water in order to remove any soluble materials that may remain. The washing is normally not important except for pigments to be used in delicate decorations where possible soluble materials may cause a blurred final image.**

## **Grinding**

**The pigment is ground in a small ball mill. For enamel overglaze decorations it should be ground very fine. In normal practice it should pass 250 mesh. When**

**used as a glaze colorant, 150 mesh is fine enough, but in general the coloring quality is better with fineness.**

**For special decorative speckled effects the pigment can be made coarse "rained.**

**After grinding the pigment is dried, packed and labeled and a color test made before releasing for sale or production.**

**The basic pigment can now be used for mixing of underglaze, on-glaze or enamel colorants with additions of fluxes, clay, silica etc. as described below.**

### **Underglaze**

**These colorants are applied to raw body, body covered with engobe or to biscuit-fired body. Colored engobes can also be termed underglaze colors.**

**The colorants should not react with or be dissolved by the overlying glaze. A high content of clay, feldspar or whiting prevents this.**

**If applying to raw clay, shrinkage should be adjusted to fit with that of the body. For biscuit body some 5-10% raw clay will give better adhesion and strength to the dried surface. 3-5% raw borax reduces tendency of glaze crawling over the decoration and adds strength to the decoration before glazing. 10-20% addition of the glaze used for final glazing is normally also added.**

**Addition of glue like sugar, dextrin, CMC helps adhesion.**

### **Maiolica or on-glaze**



**These colorants are applied onto the already glazed but unfired pot. The colorants sink into the glaze during firing and melt together with the main glaze. More fluxes are added to maiolica colorants than to underglaze colorants and the lower the viscosity of the colors and the glaze is, the more the decoration will run and the contours of the decoration will be blurred.**

**About one part frit is added to one part pigment. With a low melting frit or a pigment containing a high amount of copper oxide the frit content is lowered.**

**Maiolica colorants can be made by adding a little glaze or frit to the raw color oxide. The maiolica technique can also be used by decorating with coloured glazes on top of the basic glaze. To prevent running, the melting point of the colored glaze can be raised by adding silica and clay. Color oxide mixed with water can also be used when thinly applied. The oxide will then melt together with the glaze. If the oxide layer is too thick the glaze cannot "wet" the oxide and the decoration will be dry and dark in color after firing.**

### **Overglaze enamel**

**Overglazes (or "China paints") consist of frit and pigment and they are fired at low temperatures of 700°-850°C. The flux content is 70-90% of the enamel color.**

### **Examples of lead-free fluxes for 400-600°C**

1) Borax 380 2) ZnO 37  
Quartz 100 Borax 60

Whitina 7

**The flux and the color pigment are melted together and ground.**

**The ground colorant is mixed with about 50% organic oil (linseed oil, olive oil) as a medium for painting on the fired glaze surface. Turpentine is used for thinning. If no proper oil is available turpentine which has had some of its volatile parts removed by boiling can be used as a medium. Another medium for suspending the colorant is water with the addition of white carpenter's glue.**

### **Glaze colorant**







**The color pigments can also be used for coloring basic opaque or transparent glazes. Coloring can be done by directly adding color oxides to the glaze. However, there are some benefits from doing the coloring with prepared pigments:**

- The color effect of oxides is increased and thus cost of expensive oxides like cobalt can be reduced.**
- Colors can be made more stable so they will be less influenced by kiln atmosphere and glaze materials.**
- More colors can be produced.**
- Blisters and pinholes produced by coloring oxides (MnO) can be avoided.**



**[Home](#) > [ar](#).[cn](#).[de](#).[en](#).[es](#).[fr](#).[id](#).[it](#).[ph](#).[po](#).[ru](#).[sw](#)**



-  **Glazes - for the Self-reliant Potter (GTZ, 1993, 179 p.)**
-  **(introduction...)**
-  **Acknowledgements**
- 1. Introduction and scope**
- 2. The nature of glazes**
- 3. Temperature ranges and requirements**
- 4. Decisions**
- 5. Simple glaze theory**
- 6. Obtaining glaze materials**
- 7. Frits and fritmaking**
- 8. Preparation of glazes**
- 9. Glaze application**
- 10. Decoration**
- 11. Glaze problems**
- 12. Developing glazes**
-   **13. Glaze oxides**
- 14. Quality control**
- 15. Health and safety**
- 16. Glaze formula calculations**
- Appendix**
-  **Bibliography**

## 13. Glaze oxides

**This list of glaze materials only includes materials that we can expect to obtain easily. It also lists mineral sources for the oxides, which may be helpful when consulting with geologists. The formula suggestions are only meant as a rough guide for those who work with formulas.**

**The following list can be used as a reference when developing or modifying glazes. If you have a problem with pinholes, then go through the list noting down all materials that are mentioned as having high viscosity or high surface tension or the opposite. Comparing your glaze recipe with your notes will give ideas of what materials to increase or decrease.**

**"MP" means "melting point".**

**ALUMINIUM OXIDE, ALUMINA,  $Al_2O_3$  (Stabilizer), MP 2050°C**

**Source:**

- Aluminum oxide, alumina, ( $Al_2O_3$ )
- Clay ( $Al_2O_3 \cdot 2SiO_2 \cdot 2H_2O$ )
- Feldspar( $K_2O/N_2O/CaO \cdot Al_2O_3 \cdot 6SiO_2$ )

**Mineral sources:**

**Kaolin, ball clay, bentonite, corundum, bauxite, silimanite, kyanite, gibbsite (hydrargillite), websterite (aluminite), alunogen.**

**Effect:**

- **Increases melting point, hardness, viscosity, surface tension.**
- **Reduces tendency of crystal formation.**
- **Reduces thermal expansion.**
- **Small additions help other opacifiers.**
- **Large amounts produce matt glazes.**

**Clay addition normally 5-15%. Clay helps to keep glaze materials suspended in the bucket. Large additions cause problems of cracking of raw glaze layer and crawling, pinholing.**

### **Formula:**

- Ratio in shiny glazes,  
Alumina: Silica = 1 :6-1 :10
- Ratio in matt glazes,  
Alumina: Silica= 1:4-1:2

### **Color effect:**

- **Increase of alumina makes red and yellow-brown iron oxide color more brownish.**
- **MnO colors turn brown and less violet.**
- **CoO colors turn darker.**

**BARIUM OXIDE, BARIA, BaO (flux), MP 1923°C**

### **Source:**

- **Barium carbonate ( $\text{BaCO}_3$ ). Poisonous if it enters the blood.**
- **Barium sulfate ( $\text{BaSO}_4$ )**
- **Selenite ( $\text{BaO}$ ,  $\text{SeO}_2$ )**

### **Mineral sources:**

**Witherite, barytes, celsian, bromlite, barytocalcite.**

### **Effect:**

- **BaO reduces boron's tendency to form opaque "clouds" and therefore helps to make boron glaze transparent.**
- **Reduces chemical resistance.**
- **High amounts (above 25%) produce matt glaze due to formation of crystals. BaO matt glazes are not stable.**
- **Lowers melting point.**
- **Slow in giving off  $\text{CO}_2$ . Sometimes sulfate problems in coal-or oil-fired kilns.**
- **Helps formation of crystalline glazes.**
- **Improves hardness.**
- **Small amounts improve gloss.**

### **Formula:**

- **Generally, below  $1100^\circ\text{C}$  BaO should be less than 0.10 mole.**
- **Above 0.3 mole BaO raises melting point of glaze.**

### **Color effect:**

- **CoO colors turn more violet, Cr<sub>2</sub>O<sub>3</sub> below 1% turns more yellow.**
- **CuO colors turn from green to blue-green.**
- **Iron colors are subdued.**
- **NiO colors turn more brownish.**

## **BORIC OXIDE, B<sub>2</sub>O<sub>3</sub> (stabilizer or glass former), MP 741°C**

### **Source:**

- **Borax (Na<sub>2</sub>B<sub>4</sub>O<sub>7</sub> · 10H<sub>2</sub>O)**
- **Boric acid (B<sub>2</sub>O<sub>3</sub> · 3H<sub>2</sub>O)**
- **Both materials are soluble in water and they are normally introduced in a frit.**
- **Colemanite, gerstley borate (2CaO · 3B<sub>2</sub>O<sub>3</sub> · 5H<sub>2</sub>O). The only insoluble mineral form of borax, only mined in the USA.**
- **Calcium borate (CaO · B<sub>2</sub>O<sub>3</sub> · 6H<sub>2</sub>O<sub>2</sub>), the chemical form of colemanite.**

**Boric oxide is sometimes classified as a stabilizer (USA) and sometimes as a glass former (UK).**

### **Mineral sources:**

**Borax (tincal), kernite, ulexite, colemanite, boracite, sassolin.**

### **Effect:**

- **Strongly lowers melting point. Mainly used below 1100°C.**
- **Improves formation of an intermediate layer between glaze and body.**

- **Boric oxide below 15% reduces tendency to craze, higher amounts increase crazing.**
- **Lowers viscosity and surface tension.**
- **Low thermal expansion rate.**
- **B<sub>2</sub>O<sub>3</sub> less than 10% lowers surface tension.**
- **High content of boric oxide forms opaque clouds especially in combinations with CaO and SnO<sub>2</sub>. This is reduced by addition of BaO or SrCO<sub>3</sub>.**
- **Extends the firing range.**
- **Reduces tendency to crystallize.**

#### **Formula:**

- **Boric oxide ratio to silica is normally 1:10 and should not be less than 1:2. In frits a ratio below 1:2 will leave the frit water-soluble.**

#### **Color effect:**

- **MnO colors turn a violet hue.**
- **Iron colors become yellowish-reddish.**
- **CoO colors become brighter.**
- **CuO colors change from green to bluish green.**

**Sometimes a small percentage of raw borax is added to glaze or to engobe. When the glaze layer dries, the borax recrystallizes and this gives strength to the raw glaze layer which means it will not be damaged during handling.**



## **CALCIUM OXIDE, CALCIA, CaO (flux), MP 2570°C**

### **Source:**

- **Calcium carbonate (CaCO<sub>3</sub>), limestone, whiting, marble.**
- **Wollastonite (CaO SiO<sub>2</sub>).**
- **Dolomite (CaCO<sub>3</sub> · MgCO<sub>3</sub>).**
- **Anorthite, lime feldspar (CaO · Al<sub>2</sub>O<sub>3</sub> · 2SiO<sub>2</sub>).**
- **Calcium sulfate (CaSO<sub>4</sub>), plaster of parts.**
- **Calcium borate (2CaO · 3B<sub>2</sub>O<sub>3</sub> · 5H<sub>2</sub>O).**
- **Calcium fluoride (CaF<sub>2</sub>).**
- **Calcium phosphate (Ca<sub>3</sub>(PO<sub>4</sub>)<sub>2</sub>) (bone ash).**

### **Mineral sources:**

**Glauberite, fluorspar, apatite, lime, calcite, chalk, limestone, marble, gypsum, alabaster, seashells, coral, portland cement.**

### **Effect:**

- **Combines readily with silica in glaze and, if CaO is present in body, it reacts with SiO<sub>2</sub> in glaze to form a strong interface, reducing crazing.**
- **Increases hardness, especially with boron glazes.**
- **Reduces tendency to craze.**
- **Primary flux for temperatures above 1100°C.**
- **Below 1100°C small additions act as secondary flux.**
- **High CaO produces opacity in boron glazes, and white matt wax-like**

**glazes can be produced.**

- **Too high CaO gives dull, matt finish.**
- **CaCO<sub>3</sub> gives off CO<sub>2</sub> at 825° C.**
- **In zircon white glaze CaO increases pinholes and a dull surface.**
- **Decreases lead solubility.**

**Formula:**

- **At cone 03 CaO not above 0.25-0.28 mole**
- **At cone 01 CaO not above 0.30-0.35 mole**

**Color effect:**

- **CaO turns Cr<sub>2</sub>O<sub>3</sub> colors yellow.**
- **MnO browns and violets are improved with CaO.**
- **CaO is important for production of iron-red, chrome-green and blue color pigments.**

**LEAD OXIDE, PbO (flux), MP 888°C**

**Source:**

- **Litharge (PbO)**
- **Red lead (Pb<sub>3</sub>O<sub>4</sub>)**
- **White lead, lead carbonate (2PbCO<sub>3</sub>Pb(OH)<sub>2</sub>)**

**Lead is a very good flux but it is very poisonous and expensive. It should never be used in ware that will contain food, but still is used frequently for decorative ware.**

**If you use lead, it should always be in frit form.**

**Mineral sources:**

**Cerussite (white lead), galena (blue lead), minium (red lead), anglesite, pyromorphite.**

**Effect:**

- **Smooth, shiny low-temperature glazes.**
- **Strong flux.**
- **Good for transparent glazes.**
- **Reduces viscosity and surface tension.**
- **Reduces hardness and chemical resistance.**
- **Evaporates easily during firing.**
- **Combined with boric oxide, it is a common flux for earthenware glazes.**
- **It is more dangerous with copper oxide, which increases lead release 10 times.**
- **Small amounts in high temperature increase smoothness.**

**Formula:**

**Simple lead-alumina-silicate combinations make glazes in the following ratios<sup>3</sup>:**

PbO · 0.10 Al<sub>2</sub>O<sub>3</sub> · 1.0 SiO<sub>2</sub> 900°C

PbO · 0.11 Al<sub>2</sub>O<sub>3</sub> · 1.1 SiO<sub>2</sub> 920°C

PbO · 0.12 Al<sub>2</sub>O<sub>3</sub> · 1.2 SiO<sub>2</sub> 940°C

PbO · 0.13 Al<sub>2</sub>O<sub>3</sub> · 1.3 SiO<sub>2</sub> 960°C

PbO · 0.14 Al<sub>2</sub>O<sub>3</sub> · 1.4 SiO<sub>2</sub> 980°C

PbO · 0.15 Al<sub>2</sub>O<sub>3</sub> · 1.5 SiO<sub>2</sub> 1000°C

....

PbO · 0.25 Al<sub>2</sub>O<sub>3</sub> · 2.5 SiO<sub>2</sub> 1200°C

### **Color effect:**

- **Good with almost all colorants.**
- **Lead transparent glazes produce pleasant colors for engobe decorations.**
- **With iron, rich tans, browns, reds.**
- **With copper, rich greens (caution: lead release is increased 10 times).**
- **With antimony oxide, yellow.**

### **LITHIUM OXIDE, Li<sub>2</sub>O (flux), MP above 618°C**

#### **Source:**

- **Lepidolite (lithium mica) 1.5%-6% lithium oxide.**
- **Petalite (Li<sub>2</sub>O · Al<sub>2</sub>O<sub>3</sub> · SiO<sub>2</sub>), 2%-4% lithium oxide.**
- **Spodumene (Li<sub>2</sub>O · Al<sub>2</sub>O<sub>3</sub> · 4SiO<sub>2</sub>), about 8% lithium oxide.**
- **Lithium carbonate (Li<sub>2</sub>CO<sub>3</sub>).**
- **A number of artificial lithium chemicals exist.**
- **High price.**

#### **Effect:**

- **A strong flux**
- **Lowers viscosity.**
- **Improves hardness.**
- **Improves gloss.**
- **High Li<sub>2</sub>O content furthers formation of crystals in the melted glaze.**
- **Already 1% additions of Li<sub>2</sub>CO<sub>3</sub> improve gloss and smoothness of glaze.**

### **Color effect:**

- **CuO turns to blue colors.**
- **In lithium glaze 1% SnO<sub>2</sub> + 0.5% CuO produces Chinese reds in reduction firings.**

### **MAGNESIUM OXIDE, MAGNESIA, MgO (flux), MP 2800°C**

#### **Source:**

- **Talc (3MgO · 4SiO<sub>2</sub> · H<sub>2</sub>O).**
- **Magnesite (magnesium carbonate)(MgCO<sub>3</sub>)**
- **Dolomite (CaCO<sub>3</sub> · MgCO<sub>3</sub>)**

#### **Mineral sources:**

**Soapstone or steatite, serpentine, meerscham, vermiculite, periclase magnesia, magnesite, brucite.**

#### **Effect:**

- **Raises melting point.**
- **High surface tension.**
- **Reduces crazing due to its low thermal expansion.**
- **Small amounts increase gloss.**
- **Larger amounts make matt glaze (best above 1100°C).**
- **With double glazing, good for special-effect crawling glaze.**

### **Formula:**

- **Below 1100°C, less than 0.1 mole MgO increases gloss and 0.2 -0.4 mole MgO produces matt glazes.**

### **Color effect:**

- **CoO blue turns violet with MgO.**
- **MgO glaze on red iron rich body turns the red color to a dirty yellow-brown color. Therefore transparent glaze should contain no MgO.**
- **Cr<sub>2</sub>O<sub>3</sub> green only accepts small amounts of MgO. Large amounts bleach the green color.**

### **PHOSPHORUS OXIDE, P<sub>2</sub>O<sub>5</sub> (glass former), MP 569°C**

### **Source:**

- **Bone ash, calcium phosphate (Ca<sub>3</sub>(PO<sub>4</sub>)<sub>2</sub>)**
- **Apatite, 3Ca<sub>3</sub>(PO<sub>4</sub>)<sub>2</sub>Ca(Cl F)<sub>2</sub>.**

**Mineral sources:**

**Bone ash (made from calcining animal bones), apatite, wavellite, vivianite.**

**Effect:**

- **P<sub>2</sub>O<sub>5</sub> can replace some of the SiO<sub>2</sub> in the glaze.**
- **Strong flux, especially with MgO, BaO and alkalis.**
- **Additions above 5% form opaque glaze, especially in combination with ZnO and in lead-free glazes.**
- **Additions of up to 4% may increase melting and reduce pinholes. However, bone ash often increases pinholes due to high release of gas (instead add the bone ash to the frit).**
- **High additions (above 10%) produce matt glaze.**
- **Additions above 25%-30% make the glaze too soluble (less acid-or weather-resistant).**

**Color effect:**

- **CoO blue turns more violet.**
- **In B<sub>2</sub>O<sub>3</sub> glazes iron colors turn yellowish.**
- **In alkaline glazes iron colors turn white with high amount of P<sub>2</sub>O<sub>5</sub>.**
- **CuO greens turn bluish and with high P<sub>2</sub>O<sub>5</sub> spotted.**
- **MnO colors turn more violet.**
- **Cr<sub>2</sub>O<sub>3</sub> colors are improved to lighter shades.**
- **Interesting special surface effects with high P<sub>2</sub>O<sub>5</sub>.**

## **POTASSIUM OXIDE, POTASH, K<sub>2</sub>O (flux), MP 896°C**

### **Source:**

- **Potassium carbonate, potash (pearl ash) (K<sub>2</sub>CO<sub>3</sub>), water-soluble.**
- **Potassium nitrate, saltpeter (KNO<sub>3</sub>), water-soluble -also used as fertilizer.**
- **Potash feldspar (K<sub>2</sub>O · Al<sub>2</sub>O<sub>3</sub> · 6SiO<sub>2</sub>), exists as minerals named orthoclase and microcline, melting at 1200°C.**
- **Nepheline syenite (3Na<sub>2</sub>O · K<sub>2</sub>O · 4Al<sub>2</sub>O · 8SiO<sub>2</sub>).**

### **Mineral sources:**

**Saltpeter, potassium bichromate, leucite**

### **Effect:**

- **Potash's effect is very similar to soda, but it is a slightly less powerful flux.**
- **Potash increases crazing, but a little less than soda does.**

## **SILICON OXIDE, SILICA, SiO<sub>2</sub> (glass former), MP 1710°C**

### **Source:**

- **Quartz, SiO<sub>2</sub>**
- **Clay, Al<sub>2</sub>O<sub>3</sub> · 2SiO<sub>2</sub> · 2H<sub>2</sub>O**
- **Feldspar, Na<sub>2</sub>O/K<sub>2</sub>O/CaO · Al<sub>2</sub>O<sub>3</sub> · 6SiO<sub>2</sub>**



- **Talc,  $3\text{MgO} \cdot 4\text{SiO}_2 \cdot \text{H}_2\text{O}$**
- **Zirconium silicate,  $\text{ZrSiO}_4$**
- **Wollastonite,  $\text{CaO} \cdot \text{SiO}_2$**

### **Mineral sources:**

**Flint, chalcedony, chert, sand, quartzite, diatomite, granite, part of all rocks.**

### **Effect:**

- **A glass former, a part of all glazes.**
- **Generally raises melting temperature.**
- **Low thermal expansion, addition reduces crazing.**
- **Addition to body also reduces crazing (see glaze faults).**
- **Increases viscosity of glaze melt.**
- **Increases acid and weather resistance.**
- **Increases hardness of glaze.**
- **High amounts make the glaze shiver.**

### **Formula:**

- **Addition of 0.1 mole  $\text{SiO}_2$  increases melting point by  $20^\circ\text{C}$ .**
- **Amount of  $\text{SiO}_2$  depends on other glass-forming oxides. In general, earthenware 1-2.5 mole  $\text{SiO}_2$  and stoneware 1-4 mole  $\text{SiO}_2$ .**

### **Color effects:**

- **SiO<sub>2</sub> has little influence on effect of coloring oxides.**

## **SODIUM OXIDE, SODA, Na<sub>2</sub>O (flux), MP about 800°C**

### **Source:**

- **Sodium carbonate (Na<sub>2</sub>CO<sub>3</sub>) as crystal soda or calcined soda -also named soda ash, soluble in water, absorbs moisture from the air.**
- **Sodium nitrate (NaNO<sub>3</sub>). Sodium saltpeter (Chile saltpeter), soluble in water.**
- **Sodium chloride (NaCl). Table salt, water-soluble, used in salt glazing, used in frit for reducing discoloration of frit by iron compounds.**
- **Soda feldspar or albite (Na<sub>2</sub>O · Al<sub>2</sub>O<sub>3</sub> · 6SiO<sub>2</sub>), a white mineral melting at 1170°C.**
- **Nepheline syenite, (K<sub>2</sub>O · 3Na<sub>2</sub>O · 4Al<sub>2</sub>O<sub>3</sub> · 8SiO<sub>2</sub>), mineral melting at 1100°-1200°C.**

### **Mineral sources:**

**Natron, halite, hauynite, plagioclase, oligoclase, sodalite, glauberite, cryolite, glauber salt.**

### **Effect:**

- **Strong fluxing agent.**
- **Improves gloss.**

- **Very high thermal expansion induces crazing.**
- **Lowers elasticity of glaze, which becomes brittle with high amount of Na<sub>2</sub>O.**
- **Low viscosity, causes glaze to run. Short melting range.**
- **Evaporates easily above 1100°C (salt glazing).**

### **Color effect:**

- **High amount of Na<sub>2</sub>O or K<sub>2</sub>O produces "alkaline colors", noted for their brightness and interesting shades.**
- **Copper oxide turns blue instead of green.**
- **Manganese oxide turns violet.**
- **Cobalt gives a light blue.**
- **Iron oxide produces red in connection with boron.**

### **Formula:**

- **In alkaline frits 1 mole alkali with at least 2.5 mole SiO<sub>2</sub>, otherwise the alkalis Na<sub>2</sub>O and K<sub>2</sub>O will remain water-soluble.**

**TIN OXIDE, SnO<sub>2</sub> (glass former group), MP 1930°C**

### **Source:**

- **Tin oxide, SnO<sub>2</sub> (artificial)**

### **Mineral sources:**

## **Cassiterite (tinstone), stannite, tin pyrites.**

### **Effect:**

- **Opacifier with 5-10% addition, less efficient in alkali-rich glazes.**
- **Opacifying effect increases with CaO, TiO<sub>2</sub> and ZrO<sub>2</sub>. Fine grinding improves opacifying effect.**
- **Increases viscosity and melting point.**
- **Increases hardness and acid resistance.**
- **Increases elasticity of glaze (reduces crazing)**

### **Color effect:**

- **In leadless glaze turns CuO bluish.**
- **Produces pink in combination with Cr<sub>2</sub>O<sub>3</sub> and CaO.**
- **Iron brown colors turn redder.**
- **Manganese brown turns more violet.**
- **Used for stabilizing colors in pigment production.**

## **TITANIUM DIOXIDE, TiO<sub>2</sub> (glass former group), MP 1855°C**

### **Source:**

- **Titanium dioxide, titania, TiO<sub>2</sub> (artificial)**
- **Rutile, TiO<sub>2</sub> (85-98% TiO<sub>2</sub>)**
- **Perovskite, CaO · TiO<sub>2</sub>**

- **Titanite,  $\text{CaO} \cdot \text{TiO}_2 \text{ SiO}_2$**
- **Ilmenite,  $\text{FeO} \cdot \text{TiO}_2$**

### **Mineral sources:**

**Rutile, anatase, brookite, titanite (sphere), ilmenite.**

### **Effect:**

- **Opacifier but not so reliable. Opacity improves with addition of ZnO and CaO.**
- **Above 10%  $\text{TiO}_2$ , glaze turns matt due to forming of small crystals if cooling is slow. Mattness depends very much on firing conditions.**
- **Reduces crazing.**
- **Increases acid resistance.**
- **Reduces lead solubility when introduced in small amounts.**
- **Used for crystal glazes in combination with ZnO.**

### **Color effect:**

- **Pure  $\text{TiO}_2$  produces white colors in alkali-rich, lead-free glazes.**
- **In lead glazes and high boron glazes with small amounts of iron oxide a slight yellow color is obtained.**
- **Rutile contains some iron. The pure  $\text{TiO}_2$  will work as rutile with an addition of about 5% iron oxide.**
- **On iron-rich bodies (red firing)  $\text{TiO}_2$  combines with the iron of the body**

**to form yellow-brown colors.**

- **TiO<sub>2</sub> addition turns CoO blue to gray-blue and with high CoO to green.**
- **Low CuO turns yellowish, high CuO bluish.**
- **Cr<sub>2</sub>O<sub>3</sub> becomes dirty greyish.**
- **MnO<sub>2</sub> turns greyish**
- **NiO red and blue colors changed to green.**

**ZINC OXIDE, ZnO (flux), MP 1975°C**

**Source:**

- **Zinc oxide, zinc white, ZnO**
- **Zinc borate, ZnO · B<sub>2</sub>O<sub>3</sub>**
- **Zinc chloride, ZnCl<sub>2</sub>**
- **Zinc phosphate, 3ZnO · P<sub>2</sub>O<sub>5</sub>**

**Mineral sources:**

**Sphalerite or blende (zinc sulfide), the original zinc ore, smithsonite, hydrozincite, willemite.**

**Effect:**

- **Above 1100°C a strong flux.**
- **In small amounts increases brilliance.**
- **High amounts produce matt glazes.**
- **Reduces viscosity, increases surface tension.**

- **Increases boron clouds and helps opacity in combination with other opacifiers.**
- **Reduces crazing due to its low thermal expansion and high elasticity.**
- **Its high drying shrinkage may cause crawling if added without prior calcination.**
- **In high amounts best agent for forming crystals.**
- **Produces special surface and color effect in high boron glazes.**

### **Color effect:**

- **Generally increases brightness of colors.**
- **Chrome-green turns gray.**
- **Cobalt blue becomes lighter with less of a violet hue.**
- **Manganese violet turns brown.**

### **ZIRCONIUM OXIDE, $ZrO_2$ (glass former group), MP 2700°C**

#### **Source:**

- **Zircon, zirconium silicate,  $ZrSiO_4$**
- **Zirconium oxide, zirconia,  $ZrO_2$**
- **Commercial opacifiers**
- **Commercial zircon frits.**

#### **Mineral sources:**

**Zircon is found in beach sands, baddeleyite ( $ZrO_2$ ).**

**Effect:**

- **Zircon additions of 10-20% produce opaque white glaze (due to its high price zirconium oxide is seldom used).**
- **Used in combination with ZnO, MgO, BaO, SnO<sub>2</sub> opacity is increased.**
- **Opacity is furthered by fine grinding and by adding zircon to the frit instead of the batch.**
- **Increases melting point.**
- **Increases hardness, viscosity and surface tension.**
- **Increases tendency to form pinholes.**
- **Reduces crazing.**



[Home](#) > [ar](#).[cn](#).[de](#).[en](#).[es](#).[fr](#).[id](#).[it](#).[ph](#).[po](#).[ru](#).[sw](#)

 **Glazes - for the Self-reliant Potter (GTZ, 1993, 179 p.)**

 **14. Quality control**

 **(introduction...)**

 **14.1. Raw materials control**

 **14.2. Glaze preparation control**





## **Glazes - for the Self-reliant Potter (GTZ, 1993, 179 p.)**

### **14. Quality control**

**A successful business depends on consistent results. This can only be done if quality control is made a habit. This means having regular procedures for storing glaze materials, checking new shipments, weighing, grinding; mixing, and checking each new e batch of glaze before using it in production.**

#### **14.1. Raw materials control**

**Raw materials suppliers have their own problems with getting consistent materials. Sometimes they may send you a different material without any notification, or the quality of material from the mine may change. If you have enough working capital and storage area, it is best to get raw materials in large quantities, up to one year's need.**

### **14.1.1. RAW MATERIAL TESTING**

**When you get a new shipment of raw materials, each one should be tested. For the individual potter this is simply done by testing each one in the standard glaze recipe to see if there is any change. About 200 g glaze is mixed using the old stock materials and replacing only one of the new materials at a time. If the test glaze is different from your standard glaze, it will be necessary to alter your glaze recipe.**

### **14.1.2. STORING OF GLAZE MATERIALS**

**All materials should be kept in bags or buckets so there is no chance of mixing up different materials. Mark the contents of all bags and buckets and the material's delivery date on labels that cannot easily be removed. Keep the glaze material store separated from working areas and make sure that only responsible persons have access to it.**

## **14.2. Glaze preparation control**

**Many glaze problems are caused by carelessness during mixing of the glaze. When preparing glazes and frit, make sure that the right recipe is used and that the weighing is done correctly.**

### **Batch cards**

**If you are running a small pottery and you are doing all glaze work yourself, you can rely on a very simple system. Still, write down your recipe, keep it next to the balance and after weighing each material tick it off on the recipe.**

**For larger productions use a batch card system. A batch card form is shown in Fig. 8.3.0.B. The card follows the glaze batch during its preparation and later when the glaze is used in production. It has three purposes:**

- It shows the glaze mixer the recipe, ball milling time, density of the glaze slip.**
- The supervisor can easily check if all instructions are followed.**
- If something goes wrong, the batch card helps to trace the cause of the problem.**

**The batch card number should be marked on the glaze bucket. To avoid mistakes tie a tile glazed with the same glaze to the bucket.**

## **Balance**

**The balance and the weights need to be checked now and then. The weights should be clean. The balance may become inaccurate because the scales get dirty or the pivots or beams get out of alignment. After cleaning the weights they and the balance are checked by weighing something with a known weight ( 1 liter of water weighs 1 kg).**

## **Graduated cylinder**

**Cylinders or flasks used for measuring volume are used for adjusting density of glaze slips. Unfortunately, measuring cylinders are often not graduated correctly by the manufacturer. The cylinder can be checked by filling it with water to its mark, say 250 ml and then checking if the water weighs 250g. In some cases they have been out by more than 10%.**

## **Ball milling**

**The fineness of the glaze particles influences the glaze very much. To keep this constant, make sure that the ball milling time is the same. The time should be noted on the batch card. If different glazes are milled in the same ball mill, the worker must enter on the card that he has cleaned the ball mill before loading it. The supervisor should check that the ball mill lining and pebbles are correct.**

## **Sieving**

**The glaze should be screened before use. On the batch card screen mesh size is mentioned. Check the residue on the screen. If you get more residue than usual, there may be something wrong with the ball milling.**

### **14.2.1. METHODS OF TESTING BATCHES OF GLAZE AND FRITS**

#### **Testing frit**

**Molten frit can be drawn from the frit kiln to see whether all ingredients are well melted and whether air bubbles are released. Air bubbles may not be a problem, since many of them will be released during grinding and the second glaze firing. But if air bubbles (pinholes) give trouble during glaze firing, it may be a good idea to extend fritting time, so that the air has time to escape. In continuous frit kilns, bars of refractory brick can be placed on the sloping floor to slow down the flow of frit.**

**After fritting is over, the melting temperature and the viscosity of the frit can be compared with previous batches of frit by melting a fixed amount of frit on a**

## sloped tile.

### Testing glaze





Each new batch of glaze should be made at least one firing before using it. This will give enough time to apply the glaze to a few test pieces and fire them in the regular glaze firing. Glaze at least three pieces and place one in a cold spot, one in a normal and one in a hot spot. If something is wrong with the glaze, this will prevent a whole kilnload from being ruined.

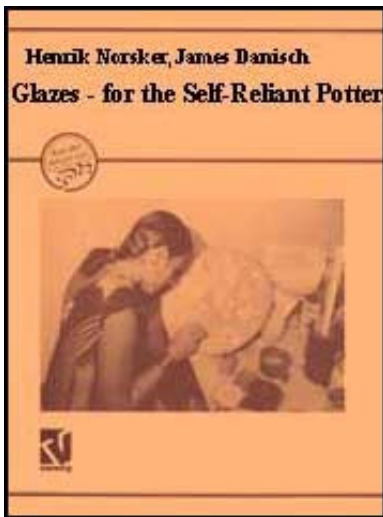

[Home](#) > [ar](#).[cn](#).[de](#).[en](#).[es](#).[fr](#).[id](#).[it](#).[ph](#).[po](#).[ru](#).[sw](#)



### **Glazes - for the Self-reliant Potter (GTZ, 1993, 179 p.)**

- ➔  **15. Health and safety**
  -  **(introduction...)**
  -  **15.1. Machinery**
  -  **15.2. Dust**
  -  **15.3. Toxic materials**

### **Glazes - for the Self-reliant Potter (GTZ, 1993, 179 p.)**

#### **15. Health and safety**

**As in all other types of industries, precautions are needed to avoid health hazards to the ceramics workers.**

### **15.1. Machinery**

**Moving parts of machinery used in the workshop should be enclosed to prevent hands, clothing or hair being caught in them. The belts and gears of ball mills, hammer mills etc. are especially dangerous.**

**Place the electrical switch next to machines, where the operator can reach it.**

### **15.2. Dust**

**Workers in the ceramics industry are constantly exposed to dust. Inhalation of dust from clay materials and quartz will cause silicosis. This is an incurable lung disease. The dangerous dust is so fine it cannot be seen.**

**The workshop floor should be cleaned regularly by scrubbing it with water. Dry sweeping should never take place. If it is not possible to wash the floors they can be swept after spreading wet or better still oiled sawdust. Tables, shelves and other surfaces collecting dust should be cleaned with a wet sponge at least once a week.**

**Dry blending of glaze and clay materials should be avoided. If it is done, the worker must wear a dust mask.**

**If the climate allows it, keep doors and windows open. Good ventilation will reduce the dust hazard.**

## **15.3. Toxic materials**

### **Hazard to workers**

**Some glaze materials are directly poisonous if eaten or inhaled. The effect is not immediate but accumulates in the body over the years. The most dangerous are raw lead materials. Lead compounds should only be used as a frit. Other toxic materials are:**

**Antimony oxide**

**Barium carbonate**

**Cadmium compounds (in color pigment)**

**Chromium dioxide**

**Cobalt oxide and carbonate**

**Copper oxide and carbonate**

**Nickel oxide**

**Zinc oxide**

### **Preventive rules are:**

- Wear a dust mask when dry mixing the materials.**
- Wash hands after working with these materials.**
- Wear special clothing only for working.**
- Never eat, drink or smoke in the workshop.**

### **Hazard to crockery users**

**The main danger for users of crockery is the release of lead from glazes. This may**

**happend if the glaze contains free lead and the glaze is used for storing acidic food. Glazes made with leadfrits may be perfectly safe' but it depends very much on the composition of the glaze. Unless your crockery can be checked regularly by a chemical laboratory, it is safer not to use lead glazes for items meant for food.**



[Home](#) > [ar](#).[cn](#).[de](#).[en](#).[es](#).[fr](#).[id](#).[it](#).[ph](#).[po](#).[ru](#).[sw](#)



 **Glazes - for the Self-reliant Potter (GTZ, 1993, 179 p.)**

➔  **16. Glaze formula calculations**

 **(introduction...)**

 **16.1. Glaze formula chemistry**

 **16.2. Seger formula**

 **16.3. Frit calculation**

**Glazes - for the Self-reliant Potter (GTZ, 1993, 179 p.)**

**16. Glaze formula calculations**

**Glazes are expressed in several different forms:**

**Recipe: a list of actual materials and weights, used directly to make the glaze.**



**Molecular formula: shows the relative proportion of molecules of flux, alumina and silica in the glaze. Must be converted to recipe to make the glaze.**

**Chemical analysis: shows the percentage of oxides in the glaze. Also known as ultimate composition.**

**Seeger formula: a special molecular formula, which makes it easier to compare glazes. It is also known as the "empirical formula".**

## **16.1. Glaze formula chemistry**

### **Why glaze formulas?**

**As you already know, glaze materials are complicated and if you only work with clay, limestone, talc, quartz etc. there is no way to theoretically understand how they combine in the glaze. For this reason, in order to make glazing scientific and systematic, it is necessary to use chemistry. This makes it possible to write materials as chemical symbols and to make calculations that help to invent new glazes and to alter existing recipes.**

#### **16.1.1. USING CHEMICAL SYMBOLS**

**Chemical symbols are a language for describing atoms, molecules and the way they are combined to make up the various materials used in chemistry and in glazes.**

**As already described at the beginning of the book, there are more than 100 elements, which are the basic building blocks of glaze materials. Each one has a**

**chemical symbol:****Calcium = Ca****Copper = Cu****Iron = Fe****etc.****16.1.2. CHEMICAL REACTIONS**

**Elements are usually not found by themselves in nature. The basic nature of elements is to combine with each other: this process is called a chemical reaction and takes place in nature through the effects of heat, pressure etc. When elements combine, they are called compounds and they can be described by chemical formulas, which show the number of atoms and how they are attached to each other.**

**For example, china clay is written as  $\text{Al}_2\text{O}_3 \cdot 2\text{SiO}_2 \cdot 2\text{H}_2\text{O}$ . Each element is followed by a number written below the line: this is the number of atoms in the compound.**

**$\text{Al}_2$  means 2 atoms of alumina and  $\text{O}_3$  means 3 atoms of oxygen. This is the compound aluminum oxide.**

**If no number follows the element symbol, it is understood to be only 1 atom.**

**The raised period (·) shows that the compounds are joined together chemically to form a complex compound. The large numbers before each compound mean the**

**number of molecules that combine. If there is no number in front, it is understood to mean 1 molecule.**

**$\text{Al}_2\text{O}_3$  means 1 molecule of aluminum oxide.**

**$2\text{SiO}_2$  means 2 molecules of silicon oxide.**

**So  $\text{Al}_2\text{O}_3 \cdot 2\text{SiO}_2 \cdot 2\text{H}_2\text{O}$  is a complex compound consisting of 1 molecule of aluminum oxide, 2 molecules of silicon oxide and 2 molecules of water.**

**These compounds cannot be broken down physically but can combine with other compounds when heated sufficiently in the kiln.**

### **16.1.3. MOLECULAR WEIGHTS**

**Each kind of molecule has a specific weight. We all know that 1 kg of lead is much smaller than 1 kg of aluminum. This is because the molecules are heavier and are packed together more closely.**

**Because it is impossible to weigh individual molecules, they have all been assigned molecular weights, which are relative to hydrogen, which has been given the molecular weight of 1. The molecular weights of all the other elements are based on how much heavier they are compared to hydrogen.**

**So the molecular weight of oxygen = 16, meaning it is 16 times heavier than hydrogen.**

### 16.1.4. FORMULA WEIGHT OF MINERALS

The molecular weights of all the elements in a compound can be added together to get the total molecular weight. This is called the formula weight. In our example of kaolin clay, we can look in the table of elements and oxides in the appendix to find out the individual molecular weights. Molecular weight is abbreviated to "MW". In order to simplify calculations we round up the MW figures. This is accurate enough since we seldom know the exact composition of our raw materials anyway.



ELEMENT	MW	NUMBER OF ATOMS		OXIDE WEIGHT	COMPOUND WEIGHT
Al	27	2	$2 \times 27 =$ 54		
O	16	3	$3 \times 16 =$ 48	102	$1 \times 102 = 102$
Si	28	1	$1 \times 28 =$ 28		
O	16	2	$2 \times 16 =$ 32	60	$2 \times 60 = 120$
H	1	2	$2 \times 1 = 2$		
O	16	1	$1 \times 16 =$ 16	18	$2 \times 18 = 36$

So the total MW of $\text{Al}_2\text{O}_3 \cdot 2\text{SiO}_2 \cdot 2\text{H}_2\text{O}$	= 258
--	-------

**This is known as formula weight.**

### 16.1.5. PERCENTAGE TO FORMULA

**Glaze formulas are often given as percentages of the various oxides. In order to find out the chemical formula, the rule is to:**

**Divide each oxide by its molecular weight!**

**In the appendix you will find the molecular weight of glaze oxide and materials.**

**Example:**

**Calculation of molecular formula of kaolin with the following chemical composition:**

OXIDE	SYMBOL	PERCENT	MW	CALCULATION
Silica	$\text{SiO}_2$	46.51%	60	$46.51/60 = 0.775$
Alumina	$\text{Al}_2\text{O}_3$	39.53%	102	$39.53/102 = 0.387$
Water	$\text{H}_2\text{O}$	13.96%	18	$13.96/18 = 0.775$

**The molecular formula is  $0.387\text{Al}_2\text{O}_3 \cdot 0.775\text{SiO}_2 \cdot 0.775\text{H}_2\text{O}$**

**Because this is difficult to use, we divide all the numbers by the smallest one.**

$$0.387/0.387 = 1\text{Al}_2\text{O}_3$$

$$0.775/0.387 = 2\text{SiO}_2$$

$$0.775/0.387 = 2\text{H}_2\text{O}$$

The formula comes out neatly as the familiar  $\text{Al}_2\text{O}_3 \cdot 2\text{SiO}_2 \cdot 2\text{H}_2\text{O}$ , or kaolin!

For using a material in glaze calculation we need to calculate its formula weight. This is done as shown above for kaolin.

## 16.2. Seger formula

About 100 years ago a German ceramist, Hermann Seger, developed Seger cones for measuring temperatures in kilns. He also proposed writing the composition of glazes according to the number of different oxides in the glaze instead of listing the raw materials used in the glaze.

For example: Aluminum oxide can be added to the glaze either in the form of clay ( $\text{Al}_2\text{O}_3 \cdot 2\text{SiO}_2 \cdot 2\text{H}_2\text{O}$ ) or feldspar ( $\text{K}_2\text{O} \cdot \text{Al}_2\text{O}_3 \cdot 6\text{SiO}_2$ ).

The oxides used in glazes are divided into three groups according to the way the oxides work in the glaze.

### Fluxes

This group of oxides functions as melter, and fluxes are also called basic oxides or bases. They are written  $\text{RO}$  or  $\text{R}_2\text{O}$ , where R represents any atom and O represents oxygen. So all the fluxes are a combination of one or two element atoms and one

## oxygen atom.

### Stabilizers

These work as stiffeners in the melted glaze to prevent it from running too much. They are considered neutral oxides and are written as  $R_2O_3$  or two atoms of some element combined with three oxygen atoms.

### Glass formers

These form the noncrystalline structure of the glaze. They are called acidic oxides and are written as  $RO_2$  or one element atom combined with two oxygen atoms.

Segger formulas allow all glaze formulas to be expressed in a table, keeping the groups separate in order to make comparison of different formulas easy (see below).

In the table form, the sum of the fluxes must always equal 1, which makes different formulas easy to compare.

### Examples

The organization of the Segger formula is always according to the table shown below.

FLUXES	STABILIZER	GLASS FORMERS
$RO, R_2O$	$R_2O_3$	$RO_2$
Alkalis:	$Al_2O_3$	$SiO_2$

K <sub>2</sub> O	B <sub>2</sub> O <sub>3</sub>	TiO <sub>2</sub>
Na <sub>2</sub> O	B <sub>2</sub> O <sub>3</sub>	
Li <sub>2</sub> O		
Alkaline earths:		
CaO		
MgO		
BaO		
Other:		
PbO		
ZnO		

**Note: B<sub>2</sub>O<sub>3</sub> is sometimes listed under stabilizers and sometimes under glass formers, since it has both characteristics.**

### **TABLE OF LIMIT FORMULAS\***

**NOTE: "KNaO" is a symbol for either sodium or potassium oxide.**

c012 - 08 Lead Glazes

PbO      0.7 - 1.0              Al<sub>2</sub>O<sub>3</sub> 0.05 - 0.2    SiO<sub>2</sub> 1.0 - 1.5

KNaO    0 - 0.3

ZnO      0 - 0.1

CaO      0 - 0.2



## c08 - 01 Lead Glazes

PbO 0.7 - 1.0      Al<sub>2</sub>O<sub>3</sub> 0.1 - 0.25      SiO<sub>2</sub> 1.5 - 2.0

KNaO 0 - 0.3

ZnO 0 - 0.2

CaO 0 - 0.3

## c08 - 04 Alkaline Glazes

PbO 0 - 0.5      Al<sub>2</sub>O<sub>3</sub> 0.5 - 0.25      SiO<sub>2</sub> 1.5 - 2.5

KNaO 0.4 - 0.8

ZnO 0 - 0.2

CaO 0 - 0.3

## c08 - 04 Lead-Boron

PbO 0.2 - 0.6      Al<sub>2</sub>O<sub>3</sub> 0.15 - 0.2      SiO<sub>2</sub> 1.5 - 2.5

KNaO 0.1 - 0.25      B<sub>2</sub>O<sub>3</sub> 0.15 - 0.6

ZnO 0.1 - 0.25

CaO 0.3 - 0.6

BaO 0 - 0.15

## c2 - 5 Lead Glazes

PbO 0.4 - 0.6      Al<sub>2</sub>O<sub>3</sub> 0.2 - 0.28      SiO<sub>2</sub> 2.0 - 3.0

KNaO 0.1 - 0.25

ZnO 0 - 0.25

CaO 0.1 - 0.4

## CZ - 5 Boron

KNaO	0.1 - 0.25	Al <sub>2</sub> O <sub>3</sub>	0.2 - 0.28	SiO <sub>2</sub>	2.0 - 3.0
ZnO	0.1 - 0.25			B <sub>2</sub> O <sub>3</sub>	0.3 - 0.6
CaO	0.2 - 0.5				
BaO	0.1 - 0.25				

## c2 - 5 Lead Borosilicate

PbO	0.2 - 0.3	Al <sub>2</sub> O <sub>3</sub>	0.25 - 0.35	SiO <sub>2</sub>	2.5 - 3.5
KNaO	0.2 - 0.3			B <sub>2</sub> O <sub>3</sub>	0.2 - 0.6
ZnO	0 - 0.1				
CaO	0.35 - 0.5				

## c8 - 12 Stoneware and Porcelain

KNaO	0.2 - 0.4	Al <sub>2</sub> O <sub>3</sub>	0.3 - 0.5	SiO <sub>2</sub>	3.0 - 5.0
ZnO	0 - 0.3			B <sub>2</sub> O <sub>3</sub>	0.1 - 0.3
CaO	0.4 - 0.7				
BaO	0 - 0.3				
MgO	0 - 0.3				

\* **D. Rhodes: Clay and Glazes for the Potter.**

**For example, a simple unfritted lead glaze would look like this:**

FLUXES	STABILIZER	GLASS FORMERS
RO, R2O	R2O3	RO2

PbO 1.0	Al <sub>2</sub> O <sub>3</sub> 0.1	SiO <sub>2</sub> 1.5
---------	------------------------------------	----------------------

**Remember that the flux column always totals 1.0.**

**A more complicated formula is the unfritted boron glaze:**

CaO .414 Al<sub>2</sub>O<sub>3</sub> .322 SiO<sub>2</sub> 2.291  
MgO .414 B<sub>2</sub>O<sub>3</sub> .931  
K<sub>2</sub>O .172  
1.000

**There are some basic rules for the ratio of oxides in the 3 different groups, according to glaze temperature. These are called limit formulas (see page 139). They should only be considered guidelines, as many glazes exceed the limits in practice.**

- **Addition of 0.1 part SiO<sub>2</sub> to a glaze will increase the melting point by about 20°C.**
- **Addition of 0.05 part B<sub>2</sub>O<sub>3</sub> will lower the melting point by 20°C.**

**The formulas of pyrometric Seger cones are listed in the appendix. These can also be used as a guide for glazes by choosing a cone formula 4 to 5 cones below the glaze firing temperature. If you need a glaze for cone 9, 1280°C, you can use the cone 5 formula for the glaze.**

### **16.2.1. BENEFITS OF USING SEGER FORMULA**

**The main usefulness of the Seger formula is that it presents glazes in a way that is easy to compare. It is used for:**

### **Originating new glazes**

**Glazes with desired characteristics of color, mattness etc. can first be written as Seger formulas, selecting oxides that are known to produce the effects.**

### **Comparing glaze recipes**

**It is difficult to look at two recipes and see how they are different. If they are converted into Seger formulas, the differences can easily be seen.**

### **Substituting materials**

**If a material is no longer available, other materials can be substituted by working out the quantities in the Seger formula.**

### **Modifying glazes**

**Glazes that change character, have problems etc. can be analyzed as Seger formulas, and directions for testing decided.**

**The Seger formula should be considered a guide only, as most theoretical glazes do not react as expected and still require empirical testing to develop them fully. If you want to use Seger formulas for your glazes it is nice to have exact chemical analysis of your raw materials, but this is seldom the case. Instead you will have to pick one of the materials listed in the appendix. They may be close enough for**

## practical work.

### 16.2.2. GLAZE RECIPE FROM FORMULA

To get the glaze recipe from the formula, there is a standard series of calculations.

#### Simple lead glaze example

PbO 1.0 Al<sub>2</sub>O<sub>3</sub> 0.1 SiO<sub>2</sub> 1.5

First decide which raw materials to use. For lead oxide, PbO, the choices are red lead, white lead or litharge. Al<sub>2</sub>O<sub>3</sub> is almost always obtained from china clay, and SiO<sub>2</sub> usually from quartz powder.

The calculation is helped a table like this:

Material and formula	Mol. Parts	PbO 1.0	Al <sub>2</sub> O <sub>3</sub> 0.1	SiO <sub>2</sub> 1.5
Litharge, PbO	1.0	1.0		
Kaolin, Al <sub>2</sub> O <sub>3</sub> · 2SiO <sub>2</sub> · 2H <sub>2</sub> O	0.1		0.1	0.2
Quartz, SiO <sub>2</sub>	1.3			1.3
TOTAL		1.0	0.1	1.5

**1.0 molecular part (MP) of litharge provides all PbO needed. We enter kaolin and its formula in the table and write 0.1 for MP. When we take 0.1 part kaolin, we get 0.1 Al<sub>2</sub>O<sub>3</sub> and we enter this on the right. In the kaolin formula we have 2 SiO<sub>2</sub> so**

**when we take 0.1 kaolin we get 0.2 SiO<sub>2</sub>. We list this under SiO<sub>2</sub>. We need 1.5 SiO<sub>2</sub> so 1.3 remains and we get this from quartz.**

**Next the required molecular parts, MP, of each material are multiplied by their molecular weights, MW, to get the batch weight of each material:**

<b>Material</b>	<b>MP</b>	<b>MW</b>	<b>Calculation</b>	<b>Batch weight</b>
Litharge	1.0	223	223 x 1	223
Kaolin	0.1	258	258 x 0.1	25.8
Quartz	1.3	60	60 x 1.3	78.0

**To change the recipe into percentages, all the figures are divided by the total:**

$$\text{Litharge } 223/326.8 = .68 = 68\%$$

$$\text{Kaolin } 25.8/326.8 = .08 = 8\%$$

$$\text{Quartz } 78.0/326.8 = .24 = 24\%$$

### **Boron glaze example**

**A more complicated formula is the unfritted boron glaze.**

CaO .414 Al<sub>2</sub>O<sub>3</sub> .322 SiO<sub>2</sub> 2.291

MgO .414 B<sub>2</sub>O<sub>3</sub> .931

K<sub>2</sub>O .172

**Again, the first step is to select materials. Because materials that supply more than one oxide usually work better in glazes, they are preferred if available. We need both CaO and MgO, which are supplied by dolomite,  $\text{CaCO}_3 \cdot \text{MgCO}_3$ . Potash feldspar supplies  $\text{K}_2\text{O}$  along with  $\text{Al}_2\text{O}_3$  and  $\text{SiO}_2$ . Quartz provides  $\text{SiO}_2$ . For boron, boric acid is selected.**

## **CALCULATION PROCEDURE**

- 1. Enter formula at top of calculation table.**
- 2. Select materials, enter formula and MW.**
- 3. Multiply each material's MW with its MW and enter result in part's weight.**
- 4. Enter MP of each oxide of the material under the formula to check oxide balance.**
- 5. Convert parts' weight into a percentage recipe.**

**As before we change the recipe to percentage:**

Dolomite  $76/384 \times 100 = 19.8$  20%

Potash

feldspar  $96/384 \times 100 = 25$  25%

Kaolin  $39/384 \times 100 = 10.2$  10%

Quartz  $58/384 \times 100 = 15.1$  15%

Boric acid  $115/384 \times 100 = 29.9$  30%

**When calculating from formula to recipe, there is no need to carry out results beyond round figures, particularly when we do not know the exact chemical**

## analysis of our materials.

Material and Formula	M.W.	M.P.	parts weight	Oxides in formula					

Figure 16.2.2.A Copy this example of a calculation table.

### 16.2.3. FORMULA FROM GLAZE RECIPE

Calculating from a recipe to the Seger formula is the same process in reverse. We will use the same raw boric acid glaze as an example. Again we use the calculation table and the following steps:

1. Enter recipe materials and their formulas in the left column and MW and recipe figures in MP's weight column.
2. Write oxides of the materials at top of table.
3. Divide each recipe figure with its MW and enter result under MP.
4. Multiply MP with each oxide in material formula and enter result under respective oxide in the right columns.



**5. Add together all oxides and list them according to RO-R2O3-RO2.**

**6. Add oxides in RO and divide all RO figures with the total.**

**Note that from dolomite only CaO and MgO are entered in the formula. CO<sub>2</sub> is released during heating and does not take part in the glaze melt. H<sub>2</sub>O of kaolin and boric acid likewise evaporates.**

**The oxides are set up in the standard Seger formula:**

K <sub>2</sub> O	.045	Al <sub>2</sub> O <sub>3</sub>	.084	SiO <sub>2</sub>	.598
CaO	.109			B <sub>2</sub> O <sub>3</sub>	.244
MgO	.109				
	.263				

**The formula is brought to unity by dividing all the figures by the total, .263, in the left column.**

K <sub>2</sub> O	.171	Al <sub>2</sub> O <sub>3</sub>	.319	SiO <sub>2</sub>	2.27
CaO	.414			B <sub>2</sub> O <sub>3</sub>	.928
MgO	.414				

**NOTE: The figures are not exactly the same as the original formula above, due to rounding off the figures. This is accurate enough for practical work.**

**If you have a chemical analysis of materials you want to use in a glaze, you first**

**have to calculate the formula of the material as described on page 137. Then you enter this formula and its formula weight in the table under MW.**

### **16.3. Frit calculation**

**Frit calculation is done in the same way as calculating a glaze, but the calculation is slightly more complicated. As with glazes it is important to follow the recipes accurately.**

**This also means that you have to make sure that the raw materials are not wet when you weigh them. Also remember that materials like calcined soda and borax will absorb moisture from the air if they are not kept in a sealed container.**

#### **16.3.1. MOISTURE COMPENSATION**

**If you have to weigh materials with a high moisture content you can compensate for this. Weigh 100 g of the material, dry it and then weigh it again. Moisture content is:**

$$\text{(wet weight - dry weight x 100) / dry weight} = x\%$$

**This x % is added to the amount you are weighing to compensate for its moisture content. Example:**

**100 g kaolin weighs 92 g after drying.**

$$\text{(100 - 92) / 92 x 100} = 8.7 \%$$

kaolin in recipe	3500 g
compensation 8.7 % x 3500	304.5 g
total amount needed	3804.5 g

### 16.3.2. FORMULA RULES FOR FRIT

**The practice of fritting was described in section 7. The main reason for fritting is to make glaze materials insoluble, which is possible if the frit materials are mixed in the right proportion. In formula terms they should fall within these limits:**

- Ratio flux:  $\text{SiO}_2$  should be between 1: 1.5 and 1:3.**
- The sum of  $\text{K}_2\text{O}$  and  $\text{Na}_2\text{O}$  should not exceed 0.5 molecular parts on the flux side, the rest being other fluxes like  $\text{PbO}$ ,  $\text{CaO}$ ,  $\text{ZnO}$ ,  $\text{BaO}$ .**
- $\text{B}_2\text{O}_3$  to  $\text{SiO}_2$  not less than 1:2, but with other materials like  $\text{PbO}$ ,  $\text{CaO}$ ,  $\text{MgO}$ ,  $\text{K}_2\text{O}$  in the frit the proportion can go down to 1:1.5.**
- A little  $\text{Al}_2\text{O}_3$  at least 0.05 mol. parts, reduces solubility but it should not exceed 0.2 mol. parts because it reduces the fluidity of the frit melt.**

### 16.3.3. FRIT BASED ON GLAZE FORMULA

**We have a glaze formula of an opaque boron glaze for 1100°C:**

$K_2O$  .23  $Al_2O_3$  .30  $SiO_2$  = 2.60

$ZnO$  .27                       $B_2O_3$  .80

$CaO$  .50

**Initially we calculate the recipe as it was done for the unfritted glaze. We get the  $K_2O$  from potash feldspar. Borax cannot be used for boric oxide because no  $Na_2O$  is needed in the formula and so boric acid is required. We get the  $CaO$  from whiting and the rest of the materials will be kaolin, quartz and zinc oxide.**

**We now decide what material to include in the frit batch and what to include in the ball milling only. This is done according to the above rules. We need to include all the soluble boric acid. Along with that we can also include whiting and zinc oxide and some potash feldspar but not all because its  $Al_2O_3$  will reduce the frit's fluidity.**

**A frit formula could be:**

$K_2O$  .1  $Al_2O_3$  .1  $SiO_2$  1.60

$ZnO$  .27                       $B_2O_3$  .80

$CaO$  .50

**One problem still remains. When the frit melts, a large amount of  $H_2O$  and  $CO_2$  is lost. Thus loss does not influence the recipe if we weigh the raw frit materials, melt the frit and use all the melted frit in the glaze, adding the other material according to the original amount of raw frit. But it is much more practical to**

**produce a large batch of frit at a time and later weigh the melted frit to produce smaller batches of glaze. We need to find out how much weight is lost.**

#### **16.3.4. FRIT LOSS CALCULATION**

##### **Practical loss**

**The loss can be found simply by weighing the amount of melted frit that is produced from a batch of frit. Example:**

**Raw frit batch weighs in total 500 kg.**

**After firing the (dry) frit weighs 280 kg.**

**Loss in % =  $(500 - 280) / 500 \times 100 = 44 \%$**

##### **Theoretical loss**

**The loss can also be calculated based on the formula of the frit. On heating, whitening changes to calcium oxide:**



**Only CaO enters the melted frit and we can calculate how much this weighs:**

**The MW of calcium carbonate is 100 and that of calcium oxide is 56 so loss is 44 parts. In percentage this is 44 % The number used to find the amount of oxide entering fusion is called the conversion factor, CF. In the material table in the appendix one column lists the conversion factor for all materials. At the bottom of**

**the left column there is a list for the most common frit materials.**

<b>Material</b>	<b>CF</b>	<b>% loss</b>
Barium carbonate	0.777	22.3
Borax (crystal)	0.526	47.4
Boric acid	0.563	43.7
Dolomite	0.523	47.7
Kaolin	0.861	13.9
Lead carbonate (white)	0.863	13.7
Lead oxide (red)	0.977	2.3
Magnesium carbonate	0.478	52.2
Pearl ash	0.682	31.8
Soda ash	0.585	41.5
Soda crystals	0.217	78.3
Whiting	0.561	43.9

### **Frit glaze example**

**We can now calculate the loss of our frit from before.**

<b>Frit Recipe:</b>	<b>Raw</b>	<b>CF</b>	<b>Melted</b>
Potash feldspar	55.6		55.6
Whiting	50.0	x 0.561	28.1

Quartz	00.0		00.0
Zinc oxide	21.9		21.9
Boric acid	98.4	x 0.563	55.4
Total	285.9		221.0

**Theoretically we get only 77.3 % melted frit from our raw frit batch. We found that 286.3 parts raw frit equal 221.2 parts melted frit so finally we can establish our glaze recipe based on melted frit:**

### **Final glaze recipe:**

Frit	221.0	69.9%
Potash feldspar	72.3	22.9%
Kaolin	18.1	5.7%
Quartz	4.8	1.5%

### **16.3.5. GLAZE RECIPE WITH STANDARD FRIT**

**Very often a ceramics producer gets the frit from a commercial supplier or wants to use only a few standard frits. Above we calculated a new frit based on the glaze formula. We will now calculate a glaze recipe from formula using a standard frit instead.**

### **Example of a standard frit formula:**

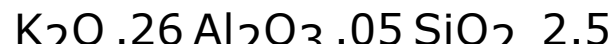

ZnO .13                      B<sub>2</sub>O<sub>3</sub> 1.0

CaO .61

**We will try to use the frit for the following glaze:**

K<sub>2</sub>O .30 Al<sub>2</sub>O<sub>3</sub> .40 SiO<sub>2</sub> 3.5

ZnO .20                      B<sub>2</sub>O<sub>3</sub> 0.8

CaO .50

**The calculation is done as with the unfritted glaze. First oxides are entered at the top of the table and we start to select materials to satisfy them. Before starting, we need to know the formula weight of the frit. In the appendix we get the MW of all the oxides and these we total.**

K <sub>2</sub> O	.26 x 94 =	24.4
Na <sub>2</sub> O	.13 x 62 =	8.1
CaO	.61 x 56 =	34.2
Al <sub>2</sub> O <sub>3</sub>	.05 x 102 =	5.1
SiO <sub>2</sub>	2.5 x 60 =	150.0
B <sub>2</sub> O <sub>3</sub>	1.0 x 70 =	70.0
Frit MW		291.8
This we round off to		292

**The frit is entered in the calculation table like other materials with many oxides.**



**The MP is selected according to the need of B<sub>2</sub>O<sub>3</sub> It takes 0.8 MP of frit to get the needed 0.8 B<sub>2</sub>O<sub>3</sub> and all the oxides listed in the frit formula are multiplied by this number and the results entered on the right of the table.**

<b>Glaze Recipe</b>	<b>Parts</b>	<b>%</b>
Frit	233.6	61.7
Potash feldspar	51.2	13.5
Soda feldspar	50.3	13.3
Kaolin	42.7	11.2
Whiting	1	0.3

### **16.3.6. HINTS FOR USING UNKNOWN LOCAL MATERIALS**

**We have already discussed above calculating local materials by guessing their closest theoretical formula. This will usually give a good starting point for making line blends, which then can be used to get a working glaze or frit.**

**What do you do when you have a recipe or formula but do not know the analysis of your local materials and cannot get pure ones? Usually you can create a glaze using the formula or recipe as a starting point, but it is unlikely to match the description in the book.**

**The most common local materials are usually:**

#### **Clays**

**Common clays can be used in most glazes instead of kaolin, since they all contain  $\text{Al}_2\text{O}_3$  and  $\text{SiO}_2$ . But they will have lower melting points and probably change the glaze color, since they will introduce  $\text{K}_2\text{O}$ ,  $\text{Na}_2\text{O}$ ,  $\text{Fe}_2\text{O}_3$ ,  $\text{CaO}$ ,  $\text{MgO}$  and perhaps other fluxes. Probably the easiest way to work with them is simply to substitute directly for the kaolin, fire a sample and then use it as the basis for line blends to get a working glaze.**

## **Feldspars**

**There are a tremendous number of different feldspars, all of which vary in the relative amounts of  $\text{K}_2\text{O}$ ,  $\text{Na}_2\text{O}$ ,  $\text{CaO}$ ,  $\text{MgO}$ ,  $\text{Al}_2\text{O}_3$  and  $\text{SiO}_2$  they supply. This means that directly substituting feldspars will affect the melting point of the glaze, and possibly its color response. Try them out as direct substitutions, and then the result can be altered using line blends. If the new glaze seems underfired (dry surface), the fluxes can be increased. If it seems overfired (too fluid), the clay content can be increased.**

## **CaO sources**

**Calcium is introduced into glazes from a large variety of raw materials: calcium carbonate, whiting, limestone, marble, seashells, coral, agricultural lime, etc. Usually, substituting will not make much difference, but again the result can be developed using line blends of the new material.**

## **Glass cullet**

**Glass cullet means waste glass, which can be used as the basis for cheap glazes.**

**The best glass to use is window glass, which can usually be obtained free of charge or cheap from glass suppliers. Window glass consists of soda-lime-silica and can be used as a frit in glazes. It melts at about 1100°C. With the addition of some flux and clay, it can be made into a low temperature glaze. However, because of its high CE, it will usually craze.**

## **Unknown materials**

**If you find new materials that are completely unknown, the easiest way to find out what they do is to first fire a small sample of the material alone, to see if it melts or not and what color it becomes. If it melts, it is a strong flux. If it does not melt, it may still be a flux. Check the test carefully to see if it has reacted with the clay body. If it develops a strong color, it will probably affect the glaze colour.**

**The material should also be tested by adding it to a known glaze recipe as a line blend.**



**[Home](#) > [ar](#).[cn](#).[de](#).[en](#).[es](#).[fr](#).[id](#).[it](#).[ph](#).[po](#).[ru](#).[sw](#)**

 **Glazes - for the Self-reliant Potter (GTZ, 1993, 179 p.)**

  **Appendix**













 **Glaze Recipes**

 **Color Pigments**

 **Ceramics Elements and Oxides**

 **Common Glaze Raw Materials**



-  **Chemical Analysis of Glaze Materials**
-  **Table of Standard Sives**
-  **Table of Seger Cone Formulas**
-  **Table of Seger Cones**
-  **Table of Orton Cones**
-  **Conversion Table for Pint Weights**
-  **Density**
-  **Dry content of a liquid**
-  **Twaddell scale**
-  **Properties of fuels**
-  **Metric system**
-  **Temperature conversion formula**

**Glazes - for the Self-reliant Potter (GTZ, 1993, 179 p.)**

## **Appendix**

### **Glaze Recipes**

**Glaze recipes are included in this book with a word of caution: Because of the wide variations in raw materials around the world, the same recipe will produce different results in different locations.**

**So please consider these recipes to be good starting points. They are not guaranteed to work without some modifications but will put you in the general**

**area of success. Most of the glazes are not described as glossy, matt, opaque etc. Try them out and modify them according to what you have learned in this book.**

**With regard to frits these vary from one manufacturer to another. As frit making is not economical for the small potter, it is suggested to substitute locally available frits. The recipes are compiled from many different sources, which are listed below.**

### **Fritted boron glazes for low temperatures**

#### **GLAZE #1.**

**Temperature: 980 °C**

<b>Frit recipe</b>	
Borax	15.5
Potash feldspar	34.8
Marble	17.9
Boric acid	31.8

<b>Glaze recipe</b>	
Frit	35.7
Potash feldspar	25.8
Kaolin	1.0
Quartz	17.2
Soda feldspar	20.3

<b>Glaze formula</b>					
0.25	K <sub>2</sub> O	0.40	Al <sub>2</sub> O <sub>3</sub>	3.50	SiO <sub>2</sub>
0.15	Na <sub>2</sub> O			1.00	B <sub>2</sub> O <sub>3</sub>
0.60	CaO				

**GLAZE #2.****Temperature: 980°C**

<b>Frit recipe</b>	
Borax	33.3
Potash feldspar	21.1
Marble	16.6
Kaolin	9.0
Quartz	20.0

<b>Glaze recipe</b>	
Frit	35.1
Potash feldspar	24.3
Magnesium carbonate	4.3
Barium carbonate	8.2
Kaolin	11.9

Quartz	17.2
--------	------

Glaze formula					
0.17	K <sub>2</sub> O	0.47	Al <sub>2</sub> O <sub>3</sub>	3.42	SiO <sub>2</sub>
0.16	Na <sub>2</sub> O			0.83	B <sub>2</sub> O <sub>3</sub>
0.25	CaO				
0.25	MgO				
0.17	BaO				

**GLAZE #3.****Temperature: 1080°C**

Glaze recipe	
Frit from glaze #2	35.9
Potash feldspar	16.7
Kaolin	15.5
Quartz	14.4
Marble	12.0
Dolomite	5.5

Glaze formula					
0.40	K <sub>2</sub> O	0.30	Al <sub>2</sub> O <sub>3</sub>	2.80	SiO <sub>2</sub>

0.50	CaO			0.60	B <sub>2</sub> O <sub>3</sub>
0.10	MgO				

**GLAZE #4.****Temperature: 1100°C**

<b>Frit recipe</b>	
Borax	10.0
Potash feldspar	33.5
Marble	15.3
Kaolin	4.0
Quartz	12.8
Boric acid	24.4

<b>Glaze recipe</b>	
Frit	94.0
Kaolin	6.0

<b>Glaze formula</b>					
0.34	K <sub>2</sub> O	0.34	Al <sub>2</sub> O <sub>3</sub>	3.5	SiO <sub>2</sub>
0.66	CaO			1.0	B <sub>2</sub> O <sub>3</sub>



**GLAZE #5.****Temperature: 1040 °C****Clear transparent glaze will craze on most bodies.**

<b>Frit recipe</b>	
Borax	47.50
Boric acid	10.50
Potash feldspar	10.50
Quartz	21.00
Kaolin	8.50
Zinc oxide	2.00

<b>Glaze recipe</b>	
Frit	62.00
Local red clay	12.00
Kaolin	8.00
Quartz	8.00
Potash feldspar	5.00
Barium carbonate	5.00

<b>Glaze formula</b>					
0.11	K <sub>2</sub> O	0.48	Al <sub>2</sub> O <sub>3</sub>	3.83	SiO <sub>2</sub>
0.53	Na <sub>2</sub> O				

0.16	BaO			1.36	B2O3
0.10	MgO				
0.10	ZnO				

**Calculation of this formula is based on chemical analysis of local glaze materials.**

### **GLAZE #6.**

**Temperature: 1040 °C**

**Semiopaque glaze.**

<b>Frit recipe</b>	
Borax	43.70
Marble	2.40
Talc	0.60
Zinc oxide	0.30
Kaolin	0.60
Rice husk ash*	40.00
Quartz	7.00

**\* About 30 parts quartz can replace the rice husk ash.**

<b>Glaze recipe</b>	
Frit	37.7
Wollastonite	5.0

Kaolin	16.0
Potash feldspar	6.0
Quartz	7.8
Zinc oxide	7.5
Zircon	20.0

<b>Glaze formula</b>					
0.04	K <sub>2</sub> O	0.37	Al <sub>2</sub> O <sub>3</sub>	4.37	SiO <sub>2</sub>
0.27	Na <sub>2</sub> O			0.16	ZrO <sub>2</sub>
0.39	ZnO			0.48	B <sub>2</sub> O <sub>3</sub>
0.30	CaO				

**Calculation of this formula is based on chemical analysis of the local glaze materials. The content of zirconium oxide in the zircon used in this recipe is only half of what is normal for standard quality zircon.**

### **GLAZE#7.**

**Temperature: 1040°C**

**Opaque, silky matt glaze.**

<b>Frit recipe</b>	
Borax	40.5
Marble	2.2

Talc	0.6
Zinc oxide	0.2
Kaolin	5,5
Quartz	43.7
Bone ash calcined	7.3

<b>Glaze recipe</b>	
Frit	57.0
Kaolin	9.0
Ball clay	8.0
Quartz	11.0
Marble	2.0
Zinc oxide	13.0

<b>Glaze formula</b>					
0.05	MgO	0.26	Al <sub>2</sub> O <sub>3</sub>	2.90	SiO <sub>2</sub>
0.25	Na <sub>2</sub> O				
0.53	ZnO			0,50	B <sub>2</sub> O <sub>3</sub>
0.17	CaO				

## Nonfritted borax glazes

**GLAZE #8.****Temperature: 1040 -1080 °C**

<b>Glaze recipe</b>	
Borax	7.2
Black local clay	15.00
Glass cullet	48.00
Barium carbonate	15.00
Manganese dioxide	15.00

**Black glossy glaze used for tiles and sewage pipes.**

<b>Glaze formula</b>					
0.25	Na <sub>2</sub> O	0.06	Al <sub>2</sub> O <sub>3</sub>	1.25	SiO <sub>2</sub>
0.17	BaO				
0.16	CaO			0.09	B <sub>2</sub> O <sub>3</sub>
0.11	MgO				
0.3	MnO				

**GLAZE #9.****Temperature: 1020 -1040 °C**

<b>Glaze recipe</b>	
Borax	50.00

Local red clay	5.00
Rice husk ash	30.00
Whiting	4.00
Yellow ochre	11.00

### Transparent, glossy glaze.

Glaze formula					
0.73	K <sub>2</sub> O	0.11	Al <sub>2</sub> O <sub>3</sub>	1.71	SiO <sub>2</sub>
0.17	CaO				
0.10	MgO			134	B <sub>2</sub> O <sub>3</sub>

### GLAZE #10.

Temperature 1050 -1100 °C

Glaze recipe	
Borax	30.00
Potash feldspar	25.00
Quartz	15.00
Dolomite	20.00
Ball clay	10.00

Glaze formula
---------------

0.41	CaO	0.29	Al <sub>2</sub> O <sub>3</sub>	2.29	SiO <sub>2</sub>
0.41	MgO				
0.17	K <sub>2</sub> O			0.91	B <sub>2</sub> O <sub>3</sub>

**GLAZE #11.****Temperature: 1260°C**

<b>Glaze recipe</b>	
Potash feldspar	16.6
Kaolin	11.0
Quartz	23.7
Marble	15.0
Borax	22.2
Soda ash	11.5

<b>Glaze formula</b>					
0.09	K <sub>2</sub> O	0.21	Al <sub>2</sub> O <sub>3</sub>	1.90	SiO <sub>2</sub>
0.48	Na <sub>2</sub> O				
0.43	CaO			0.36	B <sub>2</sub> O <sub>3</sub>

**Glazes for heavy clay products**

**GLAZE #12.****Temperature: 960 -980 °C**

<b>Glaze recipe</b>	
Sodium silicate	34.0
Glass cullet	11.0
Zircon	30.0
Quartz	10.0
Kaolin	5.0

**GLAZE #13.****Temperature: 920 -960 °C**

<b>Glaze recipe</b>	
Glass cullet	70.0
Local red clay	15.0
Whiting	15.0

**Opaque low-cost glaze.**

<b>Glaze formula</b>					
0.56	CaO	0.13	Al <sub>2</sub> O <sub>3</sub>	1.94	SiO <sub>2</sub>
0,32	Na <sub>2</sub> O				
0.12	Mg				



--	--	--	--	--	--

**GLAZE #14.****Temperature: 1000 °C**

<b>Frit recipe</b>	
Red lead	30.00
Quartz	26.30
Potash feldspar	12.20
Whiting	7.00
Borax	10.50
Magnesium carbonate	7.00
Zinc oxide	7.00

<b>Glaze recipe</b>	
Frit	92
Kaolin	8

<b>Glaze formula</b>					
0.31	PbO	0.12	Al <sub>2</sub> O <sub>3</sub>	1.50	SiO <sub>2</sub>
0.17	CaO				
0.20	MgO			0.13	B <sub>2</sub> O <sub>3</sub>
0.05	K <sub>2</sub> O				

	-				
0.07	Na <sub>2</sub> O				
0.20	ZnO				

**GLAZE #15.****Temperature: 1000 °C**

<b>Prit recipe</b>	
Red lead	17.80
Quartz	26.10
Potash feldspar	22.40
Whiting	10.30
Boric acid	16.40
Soda ash	3.00
Kaolin	4.00

<b>Glaze recipe</b>	
Frit	92.0
Kaolin	8.0

<b>Glaze formula</b>					
0.31	PbO	0.34	Al <sub>2</sub> O <sub>3</sub>	3.07	SiO <sub>2</sub>
0.41	CaO				

0.16	K <sub>2</sub> O			0.53	B <sub>2</sub> O <sub>3</sub>
0.11	Na <sub>2</sub> O				

**GLAZE #16.****Temperature: 1050°C**

<b>Frit recipe</b>	
Quartz	20.00
Potash feldspar	25.00
Whiting	7.00
Borax	25.00
Magnesium carbonate	5.00
Zinc oxide	8.00
Zircon	10.00

<b>Glaze recipe</b>	
Frit	92.0
Kaolin	8.0

<b>Glaze formula</b>					
0.21	CaO	0.22	Al <sub>2</sub> O <sub>3</sub>	2.11	SiO <sub>2</sub>
0.18	MnO			0.16	ZrO <sub>2</sub>

0.13	K <sub>2</sub> O			0.39	B <sub>2</sub> O <sub>3</sub>
0.19	Na <sub>2</sub> O				
0.29	ZnO				

**GLAZE #17.****Temperature: 950-1050°C**

<b>Frit recipe</b>	
Quartz	28.30
Potash feldspar	40.80
Whiting	7.00
Borax	13.00
Soda ash	5.10
Titanium dioxide	5.60

<b>Glaze recipe</b>	
Frit	94.0
Kaolin	6.0

<b>Glaze formula</b>					
0.32	CaO	0.42	Al <sub>2</sub> O <sub>3</sub>	4.20	SiO <sub>2</sub>
0.32	K <sub>2</sub> O			0.31	TiO <sub>2</sub>

0.36	Na <sub>2</sub> O			0.34	B <sub>2</sub> O <sub>3</sub>

**GLAZE #18.****Temperature: 1000 -1100 °C**

<b>Frit recipe</b>	
Red lead	30.56
Quartz	20.83
Whiting	18.05
Borax	25.00
Kaolin	5.56

<b>Glaze recipe</b>	
Frit	94.0
Kaolin	6.0

<b>Glaze formula</b>					
0.47	CaO	0.11	Al <sub>2</sub> O <sub>3</sub>	1.13	SiO <sub>2</sub>
0.35	PbO				
0.17	Na <sub>2</sub> O			0.34	B <sub>2</sub> O <sub>3</sub>

**GLAZE #19.**

**Temperature: 1050 -1130 °C**

<b>Prit recipe</b>	
Quartz	34.20
Whiting	5.90
Borax	30.10
Zinc oxide	1.20
Boric acid	4.00
Kaolin	11.00
Zircon	12.70
Barium carbonate	1.00

<b>Glaze recipe</b>	
Frit	95.0
Kaolin	3.0
Bentonite	2.0

<b>Glaze formula</b>					
0.03	BaO	0.34	Al <sub>2</sub> O <sub>3</sub>	4.78	SiO <sub>2</sub>
0.37	CaO			0.43	ZrO <sub>2</sub>
0.50	Na <sub>2</sub> O			1.19	B <sub>2</sub> O <sub>3</sub>
0.10	ZnO				

## Stoneware glazes

### GLAZE #20.

Temperature: 1200 -1250 °C

Glaze recipe	
Potash feldspar	72.0
Kaolin	7.0
Quartz	8.0
Whiting	13.0

Glaze formula					
0.50	CaO	0.60	Al <sub>2</sub> O <sub>3</sub>	3.72	SiO <sub>2</sub>
0.50	K <sub>2</sub> O <sub>3</sub>				

### GLAZE #21.

Temperature: 1200 -1250 °C

Glaze recipe	
Local feldspar	62.0
Kaolin	5.5
Quartz	10.0

Whiting	11.0
Zinc oxide	5.0
Zircon	6.5

<b>Glaze formula</b>					
0.274	K <sub>2</sub> O	0.485	Al <sub>2</sub> O <sub>3</sub>	3.147	SiO <sub>2</sub>
0.124	Na <sub>2</sub> O			0.084	ZrO <sub>2</sub>
0.286	CaO				
0.216	ZnO				

**Calculation based on analysis of local materials.**

**GLAZE#22.**

**Temperature: 1200 -1250 °C**

<b>Glaze recipe</b>	
Local feldspar	53.0
Kaolin	2.0
Quartz	28.0
Whiting	17.0
Zircon	+ 10.0

<b>Glaze formula</b>
----------------------



0.250	K <sub>2</sub> O	0.403	Al <sub>2</sub> O <sub>3</sub>	3.912	SiO <sub>2</sub>
0.113	Na <sub>2</sub> O				
0.637	CaO				

**GLAZE #23.****Temperature: 1250°C**

<b>Glaze recipe</b>	
Feldspar	40
Quartz	30
Whiting	20
Kaolin	10

<b>Glaze formula</b>					
0.74	CaO	0.41	Al <sub>2</sub> O <sub>3</sub>	3.71	SiO <sub>2</sub>
0.26	K <sub>2</sub> O				

**GLAZE#24.****Temperature: 1180-1200°C**

<b>Glaze recipe</b>	
Potash feldspar	46.5
Quartz	10.7

Barium carbonate	16.5
Colemanite	1.6
Zinc oxide	6.7

<b>Glaze formula</b>					
0.24	BaO	0.24	Al <sub>2</sub> O <sub>3</sub>	1.97	SiO <sub>2</sub>
0.28	CaO				
0.24	K <sub>2</sub> O	0.41	B <sub>2</sub> O <sub>3</sub>		
0.24	ZnO				

**GLAZE#25.****Temperature: 1200°C**

<b>Glaze recipe</b>	
Feldspar	51.1
Quartz	5.9
Kaolin	10.8
Whiting	18.6
Zinc oxide	8.7
Bentonite	4.9

<b>Glaze formula</b>	

0.48	CaO	0.37	Al <sub>2</sub> O <sub>3</sub>	2.03	SiO <sub>2</sub>
0.17	K <sub>2</sub> O				
0.05	Na <sub>2</sub> O				
0.02	MgO				
0.27	ZnO				

**GLAZE#26.****Temperature: 1200-1250°C**

<b>Glaze recipe</b>	
Dolomite	3.9
Kaolin	7.7
Nepheline syenite	53.8
Quartz	23.1
Whiting	11.5

<b>Glaze formula</b>					
0.51	CaO	0.56	Al <sub>2</sub> O <sub>3</sub>	3.56	SiO <sub>2</sub>
0.08	MgO				
0.10	K <sub>2</sub> O				
0.31	Na <sub>2</sub> O				

**GLAZE #27.****Temperature: 1250°C**

<b>Glaze recipe</b>	
Granite	63.6
Dolomite	27.3
Kaolin	9.1

<b>Glaze formula</b>					
0.41	CaO	0.31	Al <sub>2</sub> O <sub>3</sub>	1.99	SiO <sub>2</sub>
0.39	MgO				
0.10	K <sub>2</sub> O				
0.10	Na <sub>2</sub> O				

**GLAZE #28.****Temperature: 1200 °C**

<b>Glaze recipe</b>	
Wood ash	50
Kaolin	5
Dolomite	3
Whiting	10
Bentonite	2

Feldspar	20
Quartz	5
Nepheline syenite	5

Glaze formula					
0.51	CaO	0.09	Al <sub>2</sub> O <sub>3</sub>	0.73	SiO <sub>2</sub>
0.22	MgO				
0.15	K <sub>2</sub> O				
0.12	Na <sub>2</sub> O				

**GLAZE #29.****Temperature: 1240-1300°C**

Glaze recipe	
Feldspar	40
Ash	40
Pike clay	20

Glaze formula					
0.35	CaO	0.17	Al <sub>2</sub> O <sub>3</sub>	1.27	SiO <sub>2</sub>
0.25	MgO				
0.27	K <sub>2</sub> O				

0.13	Na <sub>2</sub> O				
------	-------------------	--	--	--	--

## Calculation based on oak ash.

### Sources of recipes

Many of the glaze recipes are taken from **Ceramic Glazes, Stefanov/Batschwarov, Bauverlag GmbH, Wiesbaden and Berlin, 1988**, and the original sources are also mentioned.

## Color Pigments

Below are listed some recipes for color pigments. In the chapter on color pigments you will find instructions on how to prepare them. These recipes will seldom work right away, but they can be used as starting points for developing color pigments based on local materials. As with all ceramic colors, the color depends very much on firing conditions, purity of the raw materials and composition of clay and glazes.

### Cobalt Blue Pigments

	Sky blue	Light blue	Royal blue	Green- blue	Dark blue	Dark blue
Cobalt oxide	5	10	20	10	45	44.6
Alumina	90	60	60	10		55.4
Zinc oxide	5	30	20	80		

Kaolin

55

## Green Pigments

	<b>Victoria green</b>	<b>Bluish green</b>	<b>Russian Green</b>	<b>Green Green</b>	<b>Olive Green</b>	<b>Olive</b>
Chrome oxide	25.0	25.8	15.0	30	19.6	32
Cobalt oxide		35.5	10.0			
Nickel oxide					8.7	16
Alumina		38.7				
Whiting	50.0					
Quartz	25.0		60.0	20	39.1	28
Feldspar			15.0	50		
Calcined borax					32.6	24

## Black Pigments

	<b>Black</b>	<b>Black</b>	<b>Black</b>	<b>Dark brown</b>	<b>Greenish black</b>	<b>Brownish black</b>
Chrome oxide	44	17	32.3		65.5	48.8
Cobalt oxide	22	20	20.6			
Iron oxide	24	35	41.2	45.5	34.5	51.2
Manganese oxide	10	20	5.9	54.5		
Nickel oxide		8				

## Pink/Yellow Pigments

	<b>Pink pink</b>	<b>Dark yellow</b>	<b>Deep yellow</b>	<b>Yellow yellow</b>	<b>Titan</b>	<b>Naples</b>
Antimony oxide			40			40
Chrome oxide	1	1.7				
Iron oxide			8			(+5)
Tin oxide	45					20
Quartz	30	54.5				
Whiting	24					
Red lead		3.5	40			40
Zinc oxide		40.3			50	
Soda ash			12			
Kaolin				11.3		
Feldspar				20.8		
Rutile				67.9	50	

## Red/Brown Pigments

	<b>Orange brown</b>	<b>Red-brown</b>	<b>Light red-brown</b>	<b>Yellow-brown</b>	<b>Chocolate red</b>	<b>Iron</b>
Rutile	37.5					
Iron oxide		22.8	17.8	13.7	27.3	50.0
Chrome		21.7	16.9	13.1	18.2	



oxide						
Zinc oxide	16.7	55.5	53.9	55.6	50.0	
Alumina			11.4	17.6		50.0
Kaolin	16.7				4.5	
Tin oxide	29.1					

## Violet/Turquoise

	<b>Deep violet</b>	<b>Dark violet</b>	<b>Blue violet</b>	<b>Turquoises blue</b>	<b>Turquoise</b>
Manganese oxide	40	70	45		
Cobalt oxide	7		10	27	
Cobalt carbonate					2
Chrome oxide				18	
Copper oxide					40
Alumina				55	
Quartz	53		25		
Tin oxide		15			75
Kaolin		25			
Zinc oxide			20		

## Ceramics Elements and Oxides

Element	Symbol	Atomic weight	Oxide	Formula	Molekular weight	
Aluminium	Al	27.1	Aluminium oxide	Al <sub>2</sub> O <sub>3</sub>	101.9	Alumina
Antimony	Sb	121.8	Antimony trioxide	Sb <sub>2</sub> O <sub>3</sub>	291.6	
Barium	Ba	137.3	Barium oxide	BaO	153.3	Baria
Boron	B	10.8	Boric oxide	B <sub>2</sub> O <sub>3</sub>	69.6	
Calcium	Ca	40.1	Calcium oxide	CaO	56.1	Calcia
Carbon	C	12.0	Carbon dioxide	CO <sub>2</sub>	44.0	
Chromium	Cr	52.0	Chromium oxide	Cr <sub>2</sub> O <sub>3</sub>	152.0	
Cobalt	Co	58.9	Cobalt oxide	CoO	74.9	
Copper	Cu	63.5	Cupric oxide	CuO	79.5	
Hydrogen	H	1.0				
Iron	Fe	55.8	Ferric oxide	Fe <sub>2</sub> O <sub>3</sub>	159.6	Iron oxide
Lead	Pb	207.2	Lead monooxide	PbO	223.2	Litharge
Lithium	Li	6.9	Lithium oxide	Li <sub>2</sub> O	29.8	Lithia
Magnesium	Mg	24.3	Magnesium oxide	MgO	40.3	Magnesia
Manganese	Mn	54.3	Manganese dioxide	MnO <sub>2</sub>	86.9	
Nickel	Ni	58.7	Nickel oxide	NiO	74.7	
Oxygen	O	16.0				
Phosphorus	P	31.0	Phosphorus oxide	P <sub>2</sub> O <sub>5</sub>	142.0	
Potassium	K	39.1	Potassium oxide	K <sub>2</sub> O	94.2	Potash
Silicon	Si	28.1	Silicon dioxide	SiO <sub>2</sub>	60.1	Silica
Sodium	Na	23.0	Sodium oxide	Na <sub>2</sub> O	62.0	Soda
Strontium	Sr	87.6	Strontium oxide	SrO	103.6	
Sulphur	S	32.1	Sulphur dioxide	SO <sub>2</sub>	64.1	
Tin	Sn	118.7	Tin oxide	SnO <sub>2</sub>	150.7	
Titanium	Ti	47.8	Titanium dioxide	TiO <sub>2</sub>	79.9	Titania
Vanadium	V	50.9	Vanadium oxide	V <sub>2</sub> O <sub>5</sub>	181.8	
Zinc	Zn	65.4	Zinc oxide	ZnO	81.4	
Zirconium	Zr	91.2	Zirconium oxide	ZrO <sub>2</sub>	123.2	Zirconia

**The molecular weights are listed with one decimal point. For glaze formula calculations you can use round up figures, eg. for iron with MW 55.8 you round it**

up to 56.

## Common Glaze Raw Materials

CF = conversion factor

MP = melting point, °C (degrees Celsius)

\* = decomposing temperatur

**NOTE: melting point and decomposing temperature are only relative indicators of how materials behave in glaze. Melting point are affected by combinations of materials! (See eutectics).**

Material	Formula	Molecular Weight	Oxides after firing	Oxide Weight	CF	MP (°C)
Alumina	Al <sub>2</sub> O <sub>3</sub>	101.9	Al <sub>2</sub> O <sub>3</sub>	101.9	1	2050
Alumina Hydrate	Al <sub>2</sub> (OH) <sub>6</sub>	156	Al <sub>2</sub> O <sub>3</sub>	101.9	0.653	300*
Antimony oxide	Sb <sub>2</sub> O <sub>3</sub>	291.6	Sb <sub>2</sub> O <sub>3</sub>	291.6	1	652
Barium carbonate	BaCO <sub>3</sub>	197.3	BaO	153.3	0.777	1450*
Barium sulfate (barytes)	BaSO <sub>4</sub>	233.4	BaO	153.4	0.657	1350*
Bentonite	Al <sub>2</sub> O <sub>3</sub> · 4SiO <sub>2</sub> · H <sub>2</sub> O	360.4	Al <sub>2</sub> O <sub>3</sub> SiO <sub>2</sub>	101.9 60.1	0.283 0.667	600*
Bone ash	see calcium phosphate					
Borax	Na <sub>2</sub> B <sub>4</sub> O <sub>7</sub> · 10H <sub>2</sub> O	381.5	B <sub>2</sub> O <sub>3</sub> Na <sub>2</sub> O	69.6 62	0.364 0.162	200*
Borax, anhydrous	Na <sub>2</sub> B <sub>4</sub> O <sub>7</sub>	201.3	Na <sub>2</sub> O B <sub>2</sub> O <sub>3</sub>	62 69.6	0.308 0.692	237
Boric acid	B <sub>2</sub> O <sub>3</sub> · 3H <sub>2</sub> O	123.7	B <sub>2</sub> O <sub>3</sub>	69.6	0.563	185*

Calcite	CaCO <sub>3</sub>	100.1	CaO	56.1	0.561	620*
Calcium carbonate	CaCO <sub>3</sub>	100.1	CaO	56.1	0.561	850*
Calcium phosphate	Ca <sub>3</sub> (PO <sub>4</sub> ) <sub>2</sub>	310.2	CaO	56.1	0.541	1550
			P <sub>2</sub> O <sub>5</sub>	142.0	0.459	
Chrome oxide	Cr <sub>2</sub> O <sub>3</sub>	152.0	Cr <sub>2</sub> O <sub>3</sub>	152.0	1	2435
Cobalt carbonate	CoCO <sub>3</sub>	119.0	CoO	74.9	0.629	800*
Cobalt oxide (black)	Co <sub>3</sub> O <sub>4</sub>	240.8	CoO	74.9	0.933	905*
Colemanite	2CaO · 3B <sub>2</sub> O <sub>3</sub> · 5H <sub>2</sub> O	412.0	CaO	56.1	0.272	1100
			B <sub>2</sub> O <sub>3</sub>	69.6	0.508	
Copper carbonate	CuCO <sub>3</sub> · Cu(OH) <sub>2</sub>	221.2	CuO	79.5	0.720	200*
Copper oxide black	CuO	79.5	CuO	79.5	1	1148
Copper oxide red	Cu <sub>2</sub> O	143.0	CuO	79.5	1.112	1230
Cristobalite	SiO <sub>2</sub>	60.1	SiO <sub>2</sub>	60.1	1	1713
Dolomite	CaCO <sub>3</sub> · MgCO <sub>3</sub>	184.4	CaO	56.1	0.304	600*
			MgO	40.3	0.219	
Enstatite	MgO · SiO <sub>2</sub>	100.4	MgO	40.3	0.401	1550
			SiO <sub>2</sub>	60.1	0.599	
Epsom salt	MgO · SO <sub>3</sub> · 7H <sub>2</sub> O	246.5	MgO	40.3	0.162	1120

**Table "Common Glaze Raw Material" 1**

Material	Formula	Molecular Weight	Oxides after firing	Oxide Weight	CF	MP (°C)
Feldspar, potash	K <sub>2</sub> O · Al <sub>2</sub> O <sub>3</sub> · 6SiO <sub>2</sub>	556.5	K <sub>2</sub> O	94.2	0.169	1200
			Al <sub>2</sub> O <sub>3</sub>	101.9	0.183	
			SiO <sub>2</sub>	60.1	0.648	
Feldspar, soda	Na <sub>2</sub> O · Al <sub>2</sub> O <sub>3</sub> · 6SiO <sub>2</sub>	524.3	Na <sub>2</sub> O	62.0	0.118	1200
			Al <sub>2</sub> O <sub>3</sub>	101.9	0.194	
			SiO <sub>2</sub>	60.1	0.688	
Feldspar, lime	CaO · Al <sub>2</sub> O <sub>3</sub> · 2SiO <sub>2</sub>	278.1	CaO	56.1	0.202	1550
			Al <sub>2</sub> O <sub>3</sub>	101.9	0.366	

			SiO <sub>2</sub>	60.1	0.432	
Flint	SiO <sub>2</sub>	60.1	SiO <sub>2</sub>	60.1	1	1600
Glass (bottle)	CaO .46 MgO .02 Al <sub>2</sub> O <sub>3</sub> .035 Na <sub>2</sub> O .51 K <sub>2</sub> O .01 SiO <sub>2</sub> 2.9	237.0	SiO <sub>2</sub> Al <sub>2</sub> O <sub>3</sub> CaO MgO Na <sub>2</sub> O K <sub>2</sub> O	60.1 101.9 56.1 40.3 62.0 94.2	0.735 0.015 0.109 0.003 0.134 0.004	1150
Gypsum	CaSO <sub>4</sub> · 2H <sub>2</sub> O	172.2	CaO	56.1	0.326	1360
Iron oxide (black)	FeO	71.8	Fe <sub>2</sub> O <sub>3</sub>	159.6	1.111	1420
Iron oxide (red)	Fe <sub>2</sub> O <sub>3</sub>	159.6	Fe <sub>2</sub> O <sub>3</sub>	159.6	1	1565*
Kaolin (China clay)	Al <sub>2</sub> O <sub>3</sub> · 2SiO <sub>2</sub> · 2H <sub>2</sub> O	258.1	Al <sub>2</sub> O <sub>3</sub> SiO <sub>2</sub>	101.9 60.1	0.395 0.466	610*
Lead bisilicat	PbO · 2SiO <sub>2</sub>	343.3	PbO SiO <sub>2</sub>	223.2 60.1	0.650 0.350	815
Lead carbonate (white)	2PbCO <sub>3</sub> · Pb(OH) <sub>2</sub>	775.7	PbO	223.2	0.863	400*
Lead oxide (Litharge)	PbO	223.2	PbO	223.2	1	160*
Lead oxide (red)	Pb <sub>3</sub> O <sub>4</sub>	685.6	PbO	223.2	0.977	500*
Limestone	(see calcium carbonate)					
Lithium carbonate	Li <sub>2</sub> CO <sub>3</sub>	73.9	Li <sub>2</sub> O	29.9	0.405	710
Magnesium carbonate (magnesite)	MgCO <sub>3</sub>	84.3	MgO	40.3	0.478	350*
Manganese carbonate	MnCO <sub>3</sub>	114.9	MnO	70.9	0.615	300*
Manganese dioxide	MnO <sub>2</sub>	86.9	MnO	70.9	0.816	1080*
Nepheline syenite	K <sub>2</sub> O · 3Na <sub>2</sub> O 4Al <sub>2</sub> O <sub>3</sub> · 8SiO <sub>2</sub>	1169.0	K <sub>2</sub> O Na <sub>2</sub> O Al <sub>2</sub> O <sub>3</sub> SiO <sub>2</sub>	94.2 62.0 101.9 60.1	0.081 0.159 0.349 0.411	1200
Nickel oxide	NiO	74.7	NiO	74.7	1	1990
Potash	K <sub>2</sub> O	94.2	K <sub>2</sub> O	94.2	1	700

**Table "Common Glaze Raw Material" 2**

Material	Formula	Molecular Weight	Oxides after firing	Oxide Weight	CF	MP (°C)
Potassium carbonate (pearl ash)	$K_2CO_3$	138.2	$K_2O$	94.2	0.682	896*
Silica (quartz)	$SiO_2$	60.1	$SiO_2$	60.1	1	1620
Silicon carbide	$SiC$	40.1	$SiO_2$	60.1	1.499	2700*
Soda	$Na_2O$	62.0	$Na_2O$	62.0	1	900
Sodium carbonate (soda crystals)	$Na_2CO_3 \cdot 10H_2O$ (natron)	286.2	$Na_2O$	62.0	0.217	860*
Soda ash	$Na_2CO_3$	106	$Na_2O$	62.0	0.585	860*
Sodium chloride	$NaCl$	58.5	$Na_2O$	62.0	0.530	800
Sodium silicate (water glass)	$Na_2SiO_3$	122.1	$Na_2O$ $SiO_2$	62.0 60.1	0.508 0.492	1088
Talc	$3MgO \cdot 4SiO_2 \cdot H_2O$	379.3	$MgO$ $SiO_2$	40.3 60.1	0.319 0.634	900*
Tin oxide	$SnO_2$	150.7	$SnO_2$	150.7	1	1127
Titanium oxide	$TiO_2$	79.9	$TiO_2$	79.9	1	1600
Wollastonite	$CaSiO_3$	116.2	$CaO$ $SiO_2$	56.1 60.1	0.483 0.517	1540
Zinc oxide	$ZnO$	81.4	$ZnO$	81.4	1	1975
Zirconium silicate (zircon)	$ZrSiO_4$	183.3	$ZrO_2$ $SiO_2$	123.2 60.1	0.672 0.328	2550
Zirconium oxide	$ZrO_2$	123.2	$ZrO_2$	123.2	1	2700

**Table "Common Glaze Raw Material" 3**

## Chemical Analysis of Glaze Materials

### Ashes

	SiO <sub>2</sub>	Al <sub>2</sub> O <sub>3</sub>	Fe <sub>2</sub> O <sub>3</sub>	CaO	MgO	K <sub>2</sub> O	Na <sub>2</sub> O	P <sub>2</sub> O <sub>5</sub>	SO <sub>3</sub>
Apple	2.7	—	—	70.9	5.5	11.8	1.9	4.5	2.7
Birch	11.5	—	1.3	29.6	14.3	22.6	9.0	7.9	2.0
Beech	3.9	—	0.6	42.0	8.2	24.3	8.3	6.2	2.1
Bone ash	2.9	—	0.3	52.4	1.3	—	—	40.9	—
Grass, washed	76.0	5.4	1.1	6.1	3.7	2.5	0.2	1.6	0.2
Oak	15.3	0.1	2.4	30.0	12.0	14.0	9.1	13.1	2.6
Oat straw	46.7	—	1.1	7.0	3.9	28.9	3.3	4.6	3.2
Poplar	3.5	0.2	1.2	16.5	10.2	54.2	2.3	10.2	1.3
Rice straw	83.2	1.4	0.4	3.7	1.4	2.5	0.4	0.7	0.4
Rice husk	96.0	1.0	0.04	0.2	0.5	0.2	0.9	0.02	—
Wheat straw	66.2	—	—	6.1	5.2	11.5	2.8	5.4	2.8
<b>Rocks<sup>2</sup></b>									
	SiO <sub>2</sub>	Al <sub>2</sub> O <sub>3</sub>	Fe <sub>2</sub> O <sub>3</sub>	TiO <sub>2</sub>	CaO	MgO	K <sub>2</sub> O	Na <sub>2</sub> O	L.o.I.
Basalt	49.1	15.7	5.4	1.3	8.9	6.2	1.5	3.1	1.6
Bauxite, India	6.8	55.0	4.5	7.8	—	—	—	—	23.8
Bentonite, India	54.5	18.7	3.7	0.2	2.3	2.6	1.3	2.1	7.6
Dolomite, Burma	2.6	0.7	0.3	—	30.8	19.8	—	—	45.4
Feldspar, Burma	65.2	19.1	0.1	—	—	—	11.9	3.5	0.2
Feldspar, Tanzania	67.0	19.7	0.1	0.1	1.25	0.1	2.85	3.21	—
Feldspar, India	64.0	18.8	0.4	—	0.6	—	12.0	3.1	0.2
Granite	70.2	14.5	1.6	0.4	1.9	0.9	4.11	3.5	—
Ilmenite	—	FeO:47.3	—	52.7	—	—	—	—	—
Kaolin, India, Bihar	47.5	38.7	0.6	0.9	0.2	0.1	0.1	0.1	12.4
Kaolin, Tanzania	48.0	35.5	1.6	0.7	0.1	0.1	0.2	0.2	13.2
Kyanite, Kenya	37.7	59.5	0.7	1.5	—	—	0.2	0.3	—
Lepidolite, U.S.A.	50.2	22.8	0.3	—	0.4	0.2	11.3	1.1	LiO <sub>2</sub> :4.9
Limestone, Assam	7.4	3.3	3.2	—	45.6	0.9	—	—	38.8
Limestone, Tanzania	13.0	0.2	0.1	—	32.3	16.5	0.1	0.4	37.3
Magnesite, Greece	5.0	0.85	0.8	—	1.0	43.5	—	—	48.2
<b>Nepheline</b>									
syenite	50.2	30.4	0.1	—	0.7	—	3.4	12.9	0.4
Pegmatite	80.2	11.4	0.2	0.2	0.1	—	6.1	0.9	1.1
Petalite	77.7	17.8	—	—	—	—	0.2	0.3	LiO <sub>2</sub> :4.2
Rhyolite	72.8	13.5	1.4	0.3	1.2	0.4	4.5	3.4	1.4
Talc, China	62.4	0.2	0.1	—	—	32.1	0.8	0.2	4.4
Volcanic ash	55.3	21.9	2.7	0.3	1.9	0.4	6.2	5.1	4.2
Zircon, Australia	33.0	0.1	0.1	0.1	—	—	—	—	ZrO <sub>2</sub> :66.9
Zircon, India	25.9	4.0	0.2	—	0.1	0.6	0.1	0.5	ZrO <sub>2</sub> :53.7

## Table "Chemical Analysis of Glaze Materials"

### Table of Standard Sives

Germany		Britain		United States		France
DIN		B.S.J.		U.S. standard		AFNOR
Openings mm	mesh/cm	Openings mm	mesh/in.	Openings mm	mesh/in.	Openings mm
6.000				5.613	3 $\frac{1}{2}$	
5.000				4.76	4	5.000
4.000				4.00	5	4.000
		3.353	5	3.36	6	
3.000						3.150
		2.812	6	2.83	7	
2.500		2.411	7	2.38	8	2.500
2.000		2.057	8	2.00	10	2.000
1.500	4	1.676	10	1.68	12	1.600
		1.402	12	1.41	14	
1.200	5	1.204	14	1.19	16	1.250
1.000	6	1.003	16	1.00	18	1.000
		0.853	18	0.84	20	0.800
0.750	8	0.699	22	0.71	25	0.630
0.600	10	0.599	25	0.59	30	
0.500	12	0.500	30	0.50	35	0.500
0.430	14	0.422	36	0.42	40	0.400
0.400	16					
0.340	18	0.353	44	0.35	45	
0.300	20	0.295	52	0.297	50	0.315
0.250	24	0.251	60	0.250	60	0.250
0.200	30	0.211	72	0.210	70	0.200
0.177	35	0.178	85	0.177	80	



0.150	40	0.152	100	0.149	100	0.160
0.120	50	0.124	120	0.125	120	0.125
0.100	60	0.104	150	0.105	140	0.100
0.090	70	0.089	170	0.088	170	
0.075	80	0.076	200	0.074	200	0.080
0.060	100	0.066	240	0.062	230	0.063
0.053	110	0.053	300	0.053	270	0.050
0.040	130			0.037	400	0.040

**Mesh means the number of threads per linear cm or inch of sieve cloth. Openings indicate the distance in mm between two threads.**

### Table of Seger Cone Formulas

Cone no.	Temperature °C	Formula			
022	600	Na <sub>2</sub> O 0.5		SiO <sub>2</sub> 2	
		PbO 0.5		B <sub>2</sub> O <sub>3</sub> 1	
021	650	Na <sub>2</sub> O 0.5	Al <sub>2</sub> O <sub>3</sub> 0.02	SiO <sub>2</sub> 1.04	
		CaO 0.25		B <sub>2</sub> O <sub>3</sub> 1	
020	670	Na <sub>2</sub> O 0.5	Al <sub>2</sub> O <sub>3</sub> 0.04	SiO <sub>2</sub> 1.08	
		CaO 0.25		B <sub>2</sub> O <sub>3</sub> 1	
		MgO 0.25			
019	690	Na <sub>2</sub> O 0.5	Al <sub>2</sub> O <sub>3</sub> 0.08	SiO <sub>2</sub> 1.16	
		CaO 0.25		B <sub>2</sub> O <sub>3</sub> 1	
018	710	Na <sub>2</sub> O 0.5	Al <sub>2</sub> O <sub>3</sub> 0.13	SiO <sub>2</sub> 1.26	
		CaO 0.25		B <sub>2</sub> O <sub>3</sub> 1	
		MgO 0.25			
017	730	Na <sub>2</sub> O 0.5	Al <sub>2</sub> O <sub>3</sub> 0.2	SiO <sub>2</sub> 1.4	
		CaO 0.25		B <sub>2</sub> O <sub>3</sub> 1	
		MgO 0.25			
016	750	Na <sub>2</sub> O 0.5	Al <sub>2</sub> O <sub>3</sub> 0.31	SiO <sub>2</sub> 1.61	
		CaO 0.25		B <sub>2</sub> O <sub>3</sub> 1	
		MgO 0.25			
015a	790	Na <sub>2</sub> O 0.432	Al <sub>2</sub> O <sub>3</sub> 0.34	SiO <sub>2</sub> 2.06	
		CaO 0.125			

		CaO	0.432			B <sub>2</sub> O <sub>3</sub>	1
		MgO	0.136				
014a	815	Na <sub>2</sub> O	0.385	Al <sub>2</sub> O <sub>3</sub>	0.34	SiO <sub>2</sub>	1.92
		CaO	0.385			B <sub>2</sub> O <sub>3</sub>	0.77
		MgO	0.230				
013a	835	Na <sub>2</sub> O	0.343	Al <sub>2</sub> O <sub>3</sub>	0.34	SiO <sub>2</sub>	1.78
		CaO	0.343			B <sub>2</sub> O <sub>3</sub>	0.68
		MgO	0.314				
012a	855	Na <sub>2</sub> O	0.345	Al <sub>2</sub> O <sub>3</sub>	0.365	SiO <sub>2</sub>	2.04
		CaO	0.341			B <sub>2</sub> O <sub>3</sub>	0.68
		MgO	0.314				
011a	880	Na <sub>2</sub> O	0.349	Al <sub>2</sub> O <sub>3</sub>	0.4	SiO <sub>2</sub>	2.38
		CaO	0.340			B <sub>2</sub> O <sub>3</sub>	0.68
		MgO	0.311				
010a	900	Na <sub>2</sub> O	0.338	Al <sub>2</sub> O <sub>3</sub>	0.423	SiO <sub>2</sub>	2.626
		K <sub>2</sub> O	0.011			B <sub>2</sub> O <sub>3</sub>	0.675
		CaO	0.338				
		MgO	0.313				
09a	920	Na <sub>2</sub> O	0.336	Al <sub>2</sub> O <sub>3</sub>	0.468	SiO <sub>2</sub>	3.087
		K <sub>2</sub> O	0.018			B <sub>2</sub> O <sub>3</sub>	0.671
		CaO	0.335				
		MgO	0.311				
08a	940	Na <sub>2</sub> O	0.279	Al <sub>2</sub> O <sub>3</sub>	0.543	SiO <sub>2</sub>	2.691
		K <sub>2</sub> O	0.038			B <sub>2</sub> O <sub>3</sub>	0.559
		CaO	0.369				
		MgO	0.314				

### "Table of Seger Cone Formulas" 1

Cone no.	Temperatur °C	Formula					
07a	960	Na <sub>2</sub> O	0.261	Al <sub>2</sub> O <sub>3</sub>	0.554	SiO <sub>2</sub>	2.984
		K <sub>2</sub> O	0.055			B <sub>2</sub> O <sub>3</sub>	0.521
		CaO	0.391				
		MgO	0.293				
06a	980	Na <sub>2</sub> O	0.247	Al <sub>2</sub> O <sub>3</sub>	0.561	SiO <sub>2</sub>	3.197
		K <sub>2</sub> O	0.069			B <sub>2</sub> O <sub>3</sub>	0.493
		CaO	0.407				
		MgO	0.277				

		MgO		Al <sub>2</sub> O <sub>3</sub>		SiO <sub>2</sub>		B <sub>2</sub> O <sub>3</sub>
05a	1000	0.229	0.277	0.571		3.467		0.457
		K <sub>2</sub> O						
		0.086						
		CaO						
		0.428						
		MgO						
		0.257						
04a	1020	0.204		0.586		3.860		0.407
		K <sub>2</sub> O						
		0.109						
		CaO						
		0.458						
		MgO						
		0.229						
03a	1040	0.182		0.598		4.199		0.363
		K <sub>2</sub> O						
		0.130						
		CaO						
		0.484						
		MgO						
		0.204						
02a	1060	0.157		0.611		4.572		0.314
		K <sub>2</sub> O						
		0.153						
		CaO						
		0.513						
		MgO						
		0.177						
01a	1080	0.134		0.625		4.931		0.268
		K <sub>2</sub> O						
		0.174						
		CaO						
		0.541						
		MgO						
		0.151						
1a	1100	0.109		0.639		5.320		0.217
		K <sub>2</sub> O						
		0.198						
		CaO						
		0.571						
		MgO						
		0.122						
2a	1120	0.085		0.652		5.687		0.170
		K <sub>2</sub> O						
		0.220						
		CaO						
		0.599						
		MgO						
		0.096						
3a	1140	0.059		0.667		6.083		0.170
		K <sub>2</sub> O						
		0.244						
		CaO						
		0.630						
		MgO						
		0.067						
4a	1160	0.043		0.676		6.399		0.119
		K <sub>2</sub> O						
		0.260						
		CaO						
		0.649						
		MgO						
		0.048						

5a	1180	Na <sub>2</sub> O	0.020	Al <sub>2</sub> O <sub>3</sub>	0.000	SiO <sub>2</sub>	6.800
		K <sub>2</sub> O	0.274			B <sub>2</sub> O <sub>3</sub>	0.056
		CaO	0.666				
		MgO	0.032				

## "Table of Seger Cone Formulas" 2

Cone no.	Temperatur °C	Formula					
6a	1200	Na <sub>2</sub> O	0.013	Al <sub>2</sub> O <sub>3</sub>	0.693	SiO <sub>2</sub>	6.801
		K <sub>2</sub> O	0.288			B <sub>2</sub> O <sub>3</sub>	0.020
		CaO	0.685				
		MgO	0.014				
7	1230	K <sub>2</sub> O	0.3	Al <sub>2</sub> O <sub>3</sub>	0.7	SiO <sub>2</sub>	7
		CaO	0.7				
8	1250	K <sub>2</sub> O	0.3	Al <sub>2</sub> O <sub>3</sub>	0.8	SiO <sub>2</sub>	8
		CaO	0.7				
9	1280	K <sub>2</sub> O	0.3	Al <sub>2</sub> O <sub>3</sub>	0.9	SiO <sub>2</sub>	9
		CaO	0.7				
10	1300	K <sub>2</sub> O	0.3	Al <sub>2</sub> O <sub>3</sub>	1.0	SiO <sub>2</sub>	10
		CaO	0.7				
11	1320	K <sub>2</sub> O	0.3	Al <sub>2</sub> O <sub>3</sub>	1.2	SiO <sub>2</sub>	12
		CaO	0.7				
12	1350	K <sub>2</sub> O	0.3	Al <sub>2</sub> O <sub>3</sub>	1.4	SiO <sub>2</sub>	14
		CaO	0.7				
13	1380	K <sub>2</sub> O	0.3	Al <sub>2</sub> O <sub>3</sub>	1.6	SiO <sub>2</sub>	16
		CaO	0.7				
14	1410	K <sub>2</sub> O	0.3	Al <sub>2</sub> O <sub>3</sub>	1.8	SiO <sub>2</sub>	18
		CaO	0.7				
15	1435	K <sub>2</sub> O	0.3	Al <sub>2</sub> O <sub>3</sub>	2.1	SiO <sub>2</sub>	21
		CaO	0.7				
16	1460	K <sub>2</sub> O	0.3	Al <sub>2</sub> O <sub>3</sub>	2.4	SiO <sub>2</sub>	24
		CaO	0.7				
17	1480	K <sub>2</sub> O	0.3	Al <sub>2</sub> O <sub>3</sub>	2.7	SiO <sub>2</sub>	27
		CaO	0.7				
18	1500	K <sub>2</sub> O	0.3	Al <sub>2</sub> O <sub>3</sub>	3.1	SiO <sub>2</sub>	31
		CaO	0.7				

# "Table of Seger Cone Formulas" 3

## Table of Seger Cones

°C	°F	German, Staffordshire, French Cone No.	New "H" series Staffordshire Cone No.	°C	°F	German, Staffordshire, French Cone No.	New "H" series Staffordshire Cone No.
600	1112	022	H 022	1100	2012	1 a	H 1
625	1157		H 022 A	1110	2030		H 1 A
650	1202	021	H 021	1120	2048	2 a	H 2
670	1238	020	H 020	1130	2066		H 2 A
690	1274	019	H 019	1140	2084	3 a	H 3
710	1310	018	H 018	1150	2102		H 3 A
730	1346	017	H 017	1160	2120	4 a	H 4
750	1382	016	H 016	1170	2138		H 4 A
790	1454	015	H 015	1180	2156	5 a	H 5
815	1499	014 a	H 014	1190	2174		H 5 A
835	1535	013 a	H 013	1200	2192	6 a	H 6
855	1571	012 a	H 012	1215	2219		H 6 A
880	1616	011 a	H 011	1230	2246	7	H 7
900	1652	010 a	H 010	1240	2264		H 7 A
920	1688	09 a	H 09	1250	2282	8	H 8
940	1724	08 a	H 08	1260	2300		H 8 A
960	1760	07 a	H 07	1270	2318		H 8 B
970	1778		H 07 A	1280	2336	9	H 9
980	1796	06 a	H 06	1290	2354		H 9 A
990	1814		H 06 A	1300	2372	10	H 10
1000	1832	05 a	H 05	1310	2390		H 10 A
1010	1850		H 05 A	1320	2408	11	H 11
1020	1868	04 a	H 04	1350	2462	12	H 12
1030	1886		H 04 A	1380	2516	13	H 13
1040	1904	03 a	H 03	1410	2570	14	H 14
1050	1922		H 03 A	1435	2615	15	H 15
1060	1940	02 a	H 02	1460	2660	16	H 16
1070	1958		H 02 A	1480	2696	17	H 17
1080	1976	01 a	H 01	1500	2732	18	H 18
1090	1994		H 01 A	1520	2768	19	H 19

### "Table of Seger Cones"

## Table of Orton Cones

**(United States, Ohio, The E. Orton Jr. Ceramic Foundation) Bending temperatures of large cones when heated at 150°/hour**

°C	°F	Cone No.	°C	°F	Cone No.
600	1112	022	1120	2048	02
614	1137	021	1137	2079	01
635	1175	020	1154	2109	1
683	1261	019	1162	2124	2
717	1323	018	1168	2134	3
747	1377	017	1186	2167	4
792	1458	016	1196	2185	5
804	1479	015	1222	2232	6
838	1540	014	1240	2264	7
852	1566	013	1263	2305	8
884	1623	012	1280	2336	9
894	1641	011	1305	2381	10
894	1641	010	1315	2399	11
923	1693	09	1326	2419	12
955	1751	08	1346	2455	13
984	1803	07	1366	2491	14
999	1830	06	1431	2608	15

1046	1915	05	1473	2683	16
1060	1940	04	1485	1705	17
1101	2014	03	1506	2743	18

**Note: The temperatures indicated in these cone tables may not be the same as when the cones bend in the individual potter's kiln. Cones are not used for measuring temperatures but for indicating the condition of clay and glazes.**

### Conversion Table for Pint Weights

oz/pt UK	oz/pt US	S.G.	°TW
22	18.3	1.10	20
22.8	19	1.14	28
23	19.2	1.15	30
24	20	1.20	40
25	20.8	1.25	50
25.2	21	1.26	52
26	21.7	1.30	60
26.4	22	1.32	64
27	22.5	1.35	70
27.6	23	1.38	76
28	23.3	1.40	80
28.8	24	1.44	88



29	24.2	1.45	90
30	25	1.50	100
31	25.8	1.55	110
31.2	26	1.56	112
32	26.7	1.60	120
32.4	27	1.62	124
33	27.5	1.65	130
33.6	28	1.68	136
34	28.3	1.70	140
34.8	29	1.74	148
35	29.2	1.75	150
36	30	1.80	160
37	30.8	1.85	170
37.2	31	1.86	171
38	31.6	1.89	179

## Density

**Specific gravity (SG) of a material, a mixture of materials or a clay slip is expressed as how many times it is heavier than the same amount of water, i.e. how many kg per 1 liter volume or gram per cm<sup>3</sup>. Density is the weight per volume unit and in the metric system this equals specific gravity (g/cc or kg/l) but in many countries slip densities are still measured in ounces per pint.**

**The density of a clay slip is found by weighing 1 liter of the slip. If it weighs 1.6 kg the slip has a density of 1.6.**

**Dry content of a liquid**

**Brogniart's Formula.**

**It is often useful to know the dry weight of materials in liquid clay slips or glazes. First find the weight of 1 liter of the liquid. The density (specific gravity, g/cm<sup>3</sup>) of the dry material has to be known. For clay materials it is close to 2.5 . Density of glazes has to be calculated from the density of the materials in the glaze recipe.**

**Dry weight in g = (W -1000) x D / D -1**

**W = weight in g of 1 liter liquid**

**D = density of dry material**

**Twaddell scale**

**Clay and glaze suspensions have normally densities between 1.0 and 2.0. On hydrometers used for measuring glaze and slip densities the densities between 1.0 and 2.0 have been divided into 200 units. These units are called degrees Twaddell and the formula for calculating these is:**

**°TW = (density -1) x 200**

**°TW Density = °TW/200 + 1**

## Properties of fuels

### Average properties of solid fuels

		<b>Wood</b>	<b>Peat</b>	<b>Lignite</b>	<b>Bituminous Coal</b>	<b>Charcoal</b>
Moisture content as found	%	25 - 50	90	50	2	
Moisture content at firing	%	10 - 15	15 - 20	15	2	2
Volatile matters	%	80	65	50	30	10
fixed carbon	%	20	30	45	65	89
ash	%	trace	5	5	5	1
Chemical analysis:						
carbon, C	%	50.0	57.5	70.0	86.0	93.0
hydrogen, H	%	6.0	5.5	5.0	5.5	2.5
oxygen, O	%	43.0	35.0	23.00	6.0	3.0
nitrogen + sulphur		1.0	2.0	2.0	2.5	1.5
Calorific value:						
cal/g						
dry fuel	gross	4450	5000	6400	8600	8300
	net	4130	4710	6140	8310	8170
normal fuel	gross	3780	3800	5170	8000	8050
	net	3420	3460	4870	7720	7910

## Properties of dry wood

		Specific gravity	Ash %	cal/g
Hardwood:	ash	.74	.6	4450
	beech	.68	.6	4500
	oak	.83	.4	4360
softwood:	fir	.45	.3	4770
	pine	.48	.4	4820
	elm	.56	.5	4470

### Note:

**Heat or calorific value is measured in calories per gram of fuel. One calorie is the heat required to heat 1 gram of water 1°C.**

**Gross calorific value is the heat that theoretically can be obtained, whereas net value is what is normally obtained when firing a kiln. Both values are included for comparison with other fuels.**

## Properties of liquid fuels

	Waste oil	Heavy fuel oil	Medium fuel oil	Light fuel oil	Kerosene
Specific gravity	0.9 - 1	1.1 - 0.94	0.93 - 0.91	0.9 - 0.81	0.78
flash point °C	250	200	150	105	55
viscosity	very high	high	medium	low	very low

caloritic value:						
cal/g	gross	10300	10055	10130	10300	11100
	net	9480	9536	9695		

## Metric system

			1 cubic metre, m <sup>3</sup>	=	1000 litres, l
			1 l	=	1000 cm <sup>3</sup> or ml
			1 ml	=	1000 mm <sup>3</sup>
1 kilometre, km	=	1000 metres, m			
1 m	=	100 centimetres, cm	1 ton	=	1000 kilograms, kg
1 cm	=	10 millimetres, mm	1 kg	=	1000 grams, g
1 mm	=	1000 micron, $\mu$	1 g	=	1000 milligrams, mg

to convert:	to:	multiply metric by:	to convert:	to:	multiply UK & US by:
<i>length:</i>					
m	feet	3.280	feet	m	.305
m	inches	39.370	inches	m	.025
cm	inches	.394	inches	cm	2.54
mm	inches	.039	inches	mm	25.400
<i>area:</i>					
hectare	acres	2.471	acres	hectare	.405
m <sup>2</sup>	sq. feet	10.764	sq. feet	m <sup>2</sup>	.093
cm <sup>2</sup>	sq. inches	.155	sq. inches	cm <sup>2</sup>	6.451
<i>volume:</i>					
m <sup>3</sup>	cu. feet	35.314	cu. feet	m <sup>3</sup>	0.0283
m <sup>3</sup>	cord (wood)	.276	cord	m <sup>3</sup>	3.625
cm <sup>3</sup> (cc)	cu. inches	.061	cu. inches	cm <sup>3</sup> (cc)	16.387
l	cu. inches	61.020	cu. inches	l	.016
l	U.K. gallon	.219	U.K. gallon	l	4.546
l	U.S. gallon	.264	U.S. gallon	l	3.785
<i>weight:</i>					
kilograms	pounds	2.205	pounds	kilograms	.453
grams	ounces	0.035	ounces	grams	28.349

## "Metric system"

### Temperature conversion formula

°C	0	10	20	30	40	50	60	70	80	90
	Degrees Fahrenheit									
0	32	50	68	86	104	122	140	158	176	194
100	212	230	248	266	284	302	320	338	356	374
200	392	410	428	446	464	482	500	518	536	554
300	572	590	608	626	644	662	680	698	716	734
400	752	770	788	806	824	842	860	878	896	914
500	932	950	968	986	1004	1022	1040	1058	1076	1094
600	1112	1130	1148	1166	1184	1202	1220	1238	1256	1274
700	1292	1310	1328	1346	1364	1382	1400	1418	1436	1454
800	1472	1490	1508	1526	1544	1562	1580	1598	1616	1634
900	1652	1670	1688	1706	1724	1742	1760	1778	1796	1814
1000	1832	1850	1868	1886	1904	1922	1949	1958	1976	1994
1100	2012	2030	2048	2066	2084	2102	2120	2138	2156	2174
1200	2192	2210	2228	2246	2264	2282	2300	2318	2336	2354
1300	2372	2390	2408	2426	2444	2462	2480	2498	2516	2534
1400	2552	2570	2588	2606	2624	2642	2660	2678	2696	2714
1500	2732	2750	2768	2786	2804	2822	2840	2858	2876	2894
1600	2912	2930	2948	2966	2984	3002	3020	3038	3056	3074
1700	3092	3110	3128	3146	3164	3182	3200	3218	3236	3254
1800	3272	3290	3308	3326	3344	3362	3380	3398	3416	3434
1900	3452	3470	3488	3506	3524	3542	3560	3578	3596	3614
2000	3632	3650	3668	3686	3704	3722	3740	3758	3776	3794

°C	1	2	3	4	5	6	7	8	9	10
°F	1.8	3.6	5.4	7.2	9.0	10.8	12.6	14.4	16.2	18.0

### "Temperature conversion formula"

**Conversion formulas:**

$$X^{\circ}\text{C} = X \times 9/5 + 32 \text{ }^{\circ}\text{F}$$

$$Y^{\circ}\text{C} = Y \times 32/9 + 5 \text{ }^{\circ}\text{C}$$

**Example:  $573\text{ }^{\circ}\text{C} = 1058^{\circ} + 5.4^{\circ} = 1063.4\text{ }^{\circ}\text{F}$**

**500 is found in the left column and the 70 is found at the top. The equivalent of 570 is the crossing point and then the final digit is added.**

