



➔  **How to Make? An Improved Soap .. Not just for more Foam (GTZ, 1993, 71 p.)**

 **(introduction...)**

 **Background**

 **Introduction**

 **A. Basic elements for making improved soap**

 **A.I. Raw materials**

 **A.II. Technology of improved soaps making**

 **B. Equipment and materials**

 **(introduction...)**

 **B.I. Material and equipment for preparation**

 **B.II. Material and equipment for the finish product**

 **C. Saponification of simple fats**

 **C.I. Peanut oil**

 **C.II. Copra oil**

 **C.III. Cotton oil**

 **C.IV. Shea butter**

 **C.V. Palm oil**

 **C.VI. Palmkernel oil**

 **C.VII. Tallows (cow and mutton)**

 **C.VIII. Fat (pork)**





## **How to Make? An Improved Soap .. Not just for more Foam (GTZ, 1993, 71 p.)**

  **(introduction...)**

 **Background**

 **Introduction**

 **A. Basic elements for making improved soap**

 **B. Equipment and materials**

 **C. Saponification of simple fats**

 **D. Saponification of fat mixtures**

 **E. Economic aspects of the improved soap production**

 **F. Ecological implications**

 **G. Local institutions**

 **Bibliography**

### **Siaka Kone**

**A Publication of the Deutsches Zentrum fr Entwicklungstechnologien - GATE in: Deutsche Gesellschaft fr Technische Zusammenarbeit (GTZ) GmbH - 1993**

**Illustrations and layout: S. Kone, R.Kiessling**

**A publication of Deutsches Zentrum fr Entwicklungstechnologien - GATE in: Deutsche Gesellschaft fr Technische Zusammenarbeit (GTZ), GmbH**

### **Eschborn 1993**



[Home](#) > [ar](#).[cn](#).[de](#).[en](#).[es](#).[fr](#).[id](#).[it](#).[ph](#).[po](#).[ru](#).[sw](#)



## **How to Make? An Improved Soap .. Not just for more Foam (GTZ, 1993, 71 p.)**

 **(*introduction...*)**

 **Background**

 **Introduction**

 **A. Basic elements for making improved soap**

 **B. Equipment and materials**

 **C. Saponification of simple fats**

 **D. Saponification of fat mixtures**

 **E. Economic aspects of the improved soap production**

 **F. Ecological implications**

  **G. Local institutions**

 **Bibliography**

## **G. Local institutions**

**1. Institute for Production Innovation (IPI) University of Dar Es Salaam P. O. Box 35 075 Dar Es Salaam Tanzania**

**2. Technology Consultancy Centre University of sciences and Technology Kumasi Ghana**

**3. University Technology Forum University of Zimbabwe P. O. Box MP 167, Mount Pleasant Harare Zimbabwe**

**4. Small Industry Research Institute P. O. Box 21 06 4/43 Roop Nagar Delhi 110 007 India**

**5. Appropriate Technology Development Association (ATDA) P. O. Box 311, Gandhi Bhawan Lucknow 22 600 1 U. P. India**



[Home](#) > [ar.cn.de.en.es.fr.id.it.ph.po.ru.sw](#)



 **How to Make? An Improved Soap .. Not just for more Foam (GTZ, 1993, 71 p.)**

 **(*introduction...*)**

 **Background**

 **Introduction**

**A. Basic elements for making improved soap**

**B. Equipment and materials**

**C. Saponification of simple fats**

**D. Saponification of fat mixtures**

**E. Economic aspects of the improved soap production**

**F. Ecological implications**

 **G. Local institutions**

  **Bibliography**

## **Bibliography**

- 01 ANDRE, E. : Les Corps Gras; Presse Universitaire de France, Paris, 1950**
- 02 BRAUN-KLUG : Die Seifenfabrikation, Sammlung Goschen Band 336; Berlin, Walter de Gruyter & Co,**
- 03 CAUBERGS, L. : La Savonnerie artisanale et semi-industrielle Serie des Manuels Techniques n° 14; ATOL, Louvain, 1985**
- 04 DONKER, P. : Small-scale Soapmaking; TCC and Intermediate Technologie Publications, London, 1986**
- 05 GRUNDMANN, W. : Praktischer Leitfaden für die Fabrikation von Haus- und Industrieseifen; Verlag für chemische Industrie, H. Ziolkowsky, Augsburg, 1925**
- 06 HACKER, G. : Zur Kern- & Feinseifenfabrikation, Ermittlungs- und Berichtsdienst für Industrie und Forschung; M. & S. Moser, Garmisch-Partenkirchen, 1951**
- 07 HEMPEL, Th. u.a. : Die Seife und ihre Herstellung; Verlag für chemische Industrie, H. Ziolkowsky KG, Augsburg, 1952**
- 08 HEFTER-SCHONFELD : Fette und Fettprodukte; IV- Seifen und seifenartige Stoffe; Wien, Verlag Julius Springer, 1939**
- 09 KRINGS, R. : Die Herstellung der Feinseifen und Toiletteseifen; Berlin, Allgemeiner Industrie-Verlag, 1933**
- 10 LENNERTS, L. : Olschrote, Ölkuchen, pflanzliche Öle und Fette Verlag Alfred Strothe, Hannover, 1984**
- 11 RICKMERS, P. : Die Öle und Fette in Wirtschaft und Technik; Verlag für chemische Industrie, H. Ziolkowsky KG, 1951**
- 12 ROMPP/RAAF : Organische Chemie im Probierglas; Franck'sche Verlagshandlung, Stuttgart, 1982**
- 13 Rivals, P. et al. : Matières Grasses et Industries Dérivées, Tome I: Constitution**

**Chimique, Analyse technique Matieres Grasses Natureles; Paris, Librairie J.-B. Bailliere et Fils, 1934**

**14 SCHRAUTH, W. : Deites Handbuch der Seifenfabrikation; Verlag Julius Springer, Berlin, 1917**

**15 SBP Chemical Engineering Series N° 44: Technology of Laundry & Toilet Soaps; Delhi (India)**

**16 ULLMANN'S Encyklopedie der technischen Chemie, 4.Auflage, Band 11; Verlag Chemie, Weinheim, S.455-523**

**17 WITTKA, F. : Moderne fettchemische Technologie; I- Verderben der Seifen, Ursachen und Verhutung; Leipzig, Johann AmbrosiusVerlag, 1939**



[Home](#) > [ar](#).[cn](#).[de](#).[en](#).[es](#).[fr](#).[id](#).[it](#).[ph](#).[po](#).[ru](#).[sw](#)



 **How to Make? An Improved Soap .. Not just for more Foam (GTZ, 1993, 71 p.)**

 **(introduction...)**

  **Background**

 **Introduction**

**A. Basic elements for making improved soap**

**B. Equipment and materials**

**C. Saponification of simple fats**

**D. Saponification of fat mixtures**

**E. Economic aspects of the improved soap production**





## **F. Ecological implications**



## **G. Local Institutions**

## **Bibliography**

### **Background**

**This work (manual) is conceived to guide practical users by providing them the most possible objective reliable data.**

**The goal aimed at is not the realization of an exhaustive work on the technology of saponification, but rather that of a practical guide, gathering the main and basic data on the techniques and methods of approach for the home and small-scale production of improved soaps.**

**Through the diversity of gathered information and methodologies, we hope any user, even without basic knowledge in chemistry can find an acceptable solution to the practical difficulties he would face.**

**So, we want to remind the users that the manufacturing of a good quality soap requires, in spite of the availability of reliable technical data, a certain experience and manual skills. Only practical exercise, which can improve soap making abilities and perseverance are thus necessary to obtain the expected results.**

**Informative discussions with Mme Sonderman, and M. Kiessling both members of GATE-Staff, have contributed for most of the expression of the specific nature of vulgarization of this book. The author thanks them sincerely.**

**NB : Gate is not in the possibility to verify the reliability of the technical details**



## contained in this book.

**You are requested to give feedback on the possible problems encountered during your soap making practices as well as your suggestions for an improvement of the described procedures. This would allow other people to benefit from your experience.**



[Home](#) > [ar](#).[cn](#).[de](#).[en](#).[es](#).[fr](#).[id](#).[it](#).[ph](#).[po](#).[ru](#).[sw](#)



### **How to Make? An Improved Soap .. Not just for more Foam (GTZ, 1993, 71 p.)**

 **(introduction...)**

 **Background**

  **Introduction**

**A. Basic elements for making improved soap**

**B. Equipment and materials**

**C. Saponification of simple fats**

**D. Saponification of fat mixtures**

**E. Economic aspects of the improved soap production**

**F. Ecological implications**

 **G. Local institutions**

 **Bibliography**

## **Introduction**

**Soap is a product obtained through the reaction of a base on a fat. Its classical usages at home level are washing and body hygiene. It is a product which can be manufactured as well at home and family levels as at semi-industry and industry levels.**

**The chemical process (saponification) of soap making is easy. Nevertheless the technological process to be adapted towards obtaining a good quality product is somewhat difficult (complex).**

**In fact the achievement of a good finish product requires the mastery of some basic knowledge concerning the choice and treatment of raw materials, as well as the correct execution of the saponification.**

**The adoption of a good procedure in carrying soap making operations at home level could allow from local raw materials, on-site production of a soap with practical acceptable qualities.**

**In the following lines, we would try to lay the foundations towards achievement of such a process for improved soap making at home level.**



**In this purpose, we will communicate the simple process of soap making as well as the basic techniques for conditioning of a finish soap; in particular the nature, the main proprieties and the simple techniques of pre-treatment of raw-materials are exposed.**



[Home](#) > [ar](#).[cn](#).[de](#).[en](#).[es](#).[fr](#).[id](#).[it](#).[ph](#).[po](#).[ru](#).[sw](#)



## **How to Make? An Improved Soap .. Not just for more Foam (GTZ, 1993, 71 p.)**

- ➔  **A. Basic elements for making improved soap**
  -  **A.I. Raw materials**
  -  **A.II. Technology of improved soaps making**

## **How to Make? An Improved Soap .. Not just for more Foam (GTZ, 1993, 71 p.)**

### **A. Basic elements for making improved soap**

#### **A.I. Raw materials**

**The raw material needed for making soap are fats (oil, grease or butter), alkaline, water and secondary products (salt, additive colors, scents etc.).**

##### **A.I.1. Fats**

###### **A.I.1.1 Nature and chemical characteristics**

**The natural fats used for soap making are triglycerol, which is an ester from an alcohol triple, glycerol with linear carbonic acid chains (fatty acid). According to their solidity at ordinary temperature, fats divide into oils (liquid at usual ambient temperatures) and butters (solid).**

**Some fats are extracted from plants while others are animals origin. On the chemical point of view, all are appropriate for saponification. However more or less fundamental differences exist between the proprieties of each of them. In the practice the number of fats used for soap production is limited. The main reasons for this limitation are economic and technical proprieties of fats and of the soaps generated from them, availability and price.**

**There exists two (2) main chemical parameters to characterize the appropriateness of triglycerol for saponification: Iodine Number and Saponification Value.**

**The Iodine Number of a fat expresses the weight of iodine in grams which can be fixed from 100 g of them. It indicates the presence of double links, thus the degree of insaturation of the carbonic chain.**

**Its value varies between 10 to 200. Note that the butters and greases, which are solid under normal conditions , have an Iodine Number inferior or equal to 70. Moreover the soap made from a high Iodine Number fat has the tendency to be soft. The Saponification Value of a fat is the quantity of caustic potassium (KOH) in mg needed to transform 1 g of it in soap. For most of the natural triglycerol, this index is situated at about 190-200. The important exceptions concern palmist, copra and cowbutters with value reaching 240-250. A high Saponification Value**

**indicates an easier transformation of the fat into soap.**

**In soap making process iodine number and saponification value play an important role in a sense that their values allow to predict some important proprieties of the soap obtained from the fats (or the mixture of fat).**

**The INS Factor (Iodine Number-Saponification Value), which represents the difference between these indexes, is an essential parameter enabling to characterize as well the (mixture of) fats as the soap obtained from the latter.**

**With increasing values of this factor, the following proprieties can be observed:**

- 1. The fat tends to be solid;**
- 2. The soaps made are tough (rough);**
- 3. The bleaching and foam forming proprieties tend to decrease**
- 4. The solubility of soaps tend to decrease;**
- 5. The soaps tends sharply to become rancid.**

**Copra and palmist fats constitute the exceptions to the above stated rules.**

**Table I. indicates the values of iodine and saponification indexes of the main fats used in soap making in tropical areas.**

**The majority of these fats are plant origin and are extracted from cultivated plants. However in certain rural areas, a high proportion of fatty materials used in traditional soapmaking are extracted from fruits of wild plants.**

**In Sahel and Savanna Zones, the following wild species are used in soap making:**

**Balanites aegyptiaca, Karitea (shea) (Byturospermum parkii), Cailcedra (Khaya senegalesis), Manan (Lophira lanceolata), Baobab (Adansonia digitata) etc.**

**Some essential using proprieties of an improved soap strongly depend on the nature of the fat being used for its composition.**

**Table II. indicates some important characteristics of soaps from selected fats**

**Table I. Iodine number and saponification values, INS Fac of principal fats used in soap making in tropical zone; weight of caustic soda to saponify 1 kg**

<b>FATS</b>	<b>SAPONIFICATION VALUE</b>	<b>IODINE NIMBER</b>	<b>INS FACTOR</b>	<b>CAUSTIC SODA NEEDED TO SAPONIFY 1 kg (in g)</b>
Butters/Fats				
Cocoa	195	38	157	1339,03
Coprah	256	8	248	1882,53
Karitea	187	61	126	1333,33
Fat (pork)	198	70	128	141,17
Tallow (cow)	197	40	157	140,46
Tallow (mutton)	195	39	156	139,03
Oils				
Peanuts	190	95	95	1335,47

Baobab	206	27	179	1446,88
Cotton	194	109	85	1338,32
Kobi	195	71	124	1339,03
Kapok	193	83	110	1337,61
Manan	191	70	121	1336,18
Neem	196	69	127	1339,73
Palm	200	51	149	1442,60
Palmist	248	17	231	1776,82
Physic oil	196	92	104	139,75
Castor oil	182	85	97	127,77
Sesam	190	111	79	1335,47
Soja	192	128	64	1336,90
Sunflower	190	135	55	1335,47

**Baobab (*Adansonia* sp.), Kobi (*Carapa* sp.), Kapok (*Eriodendron* s and Manan (*Lophira* sp.), are wild species of humid and semiarid tropical zones.**

**Table II. Characteristics of sodium soaps from the main soap making fats in tropical zone**

Soap from	Colour	Consistency	Foaming capacity Foam characteristics	Bleaching effect	Effect on the skin	Usage

Butters/Fats						
Coprah	Pale yellow to white	Very hard Crumbly	Strong, quick, foam less stable	Very good even at cold	Rough	Washing
Karitea	White	Hard	Slow	Middle	Very soft	Body hygiene, Washing
Fat	White	Hard	Strong, quick stable foam	Good	Very soft	Body higiene
Tallows	White to yellow pale	Very hard	Weak, slow, stable foam	Good	Very soft	Body hygiene, Washing
Oils						
Peanut	Tan	Quite hard	Weak, slow	Middle	Very soft	Body hygiene, Washing
Cotton	Grey- yellow	Soft	Middle, stable foam	Good	Smooth	Washing
Manan	Tan	Hard	Strong, stable foam	Good	Smooth	Washing, body hygiene
Neem	Dirty yellow	Hard	Strong, quick, stable foam	Very good	Smooth, antiseptic	Washing, body hygiene
Palm	Yellow	Hard	Strong, slow	Very good	Very	Body



Palm	Yellow pale	Hard	Strong, slow foaming, stable foam	Very good	Very smooth	Body hygiene, Washing
Palmist	Yellow pale	Very hard (Crumbly)	Strong, quick, foam less stable	Very good even at cold	Rough	Washing
Pourghere	White pale	Soft	Strong, quick, foam stable	Good	Smooth, antiseptic	Washing, body hygiene
Castor-oil	White	Very hard	Weak, foam stable	Good	Smooth	Washing, body hygiene
Sesam	Brown- clear	Soft	Strong, slow, foam stable	Good	Smooth	Washing

### A.I.1.2 Pretreatment

**The usual techniques for extraction generate fat products containing impurities. Moreover these fats present sometimes, at raw state, strong odors and more or less intense colorations. Soaps produced from such raw materials are least quality.**

**To obtain a good appearance and better usage quality soap from such materials, the precedent refining and bleaching are consequently necessary. To achieve this, there are some simple methods.**

**A simple method of refining (purification and deodorisation) consists in boiling**

**the fat in mixture with water during 5 h at least (one volume of fat for 1/2 a volume of water).**

**The addition of some natural products can considerably improve the performances of this method, for instance that of a mixture from okra powder (hibiscus esculentus). At the end of the operation, the impurities pass into the watery phase and the purified oil floods above.**

**A modification of this techniques consists in boiling the fat with 25% of its weight from a solution of 10% salt in water during 30 minutes.**

**The bleaching (decoloration) is also necessary as pretreatment method of some soap making fat with initial strong coloration.**

**Palm-oil, and in a less measure, that of cotton, should go through this stage before their saponification. The simple bleaching methods we can consider are as follows:**

- Thermic treatment (oxidation at hot air);**
- Bleaching by adsorption on special muds (argile, kaolin) or/and activated charcoal;**
- Chemical bleaching with strong oxides.**

**Thermic bleaching is achieved by boiling the fat body to 200-250 °C in a basin opened during 5 to 6 hours. The operation is carried until a white paper dipped into the oil doesn't show any more coloration.**

**As for bleaching by adsorption, the fat is boiled at 90 - 100 °C; you then add**

**around 5% of its weight in adsorbent muds (and eventually 1 to 2% of active charcoal). The product is mixed during 15 to 20 minutes.**

**The chemical bleaching is made with potassium bichromate (1 to 2 %) in presence of a strong mineral acid ( $H_2SO_4$  or diluted HCl). The temperature of the mixture should be maintained under 52 °C.**

**So this operation is thus somewhat more delicate than the two precited others.**

### **A.I.2. Alkali**

**For direct saponification of neutral fats (triglycerols) we need to put a strong basic solution (alkali) in the water. Caustic soda and caustic potasch are the most frequently used for this goal. The soaps obtained from these two bases are however different in some characteristics such as consistency, foam formation, solubility etc.**

#### **A.I.2.1. Caustic soda (NaOH)**

**This is the most alkali used for saponification of neutral fat. The soaps obtained (sodium soaps) are harder and less soluble than those obtained from potassium. Moreover they are less able to retain the humidity of the air.**

**The caustic soda is a chemical basic product used in various fields of crafts: tanning, dying etc. So it is easily available on the market, even in developing countries.**

**At pure natural stage, it is a white crystallin substance, which is easily soluble in**

**water with heat production. The concentrated caustic soda solutions are harmful to the skin and can cause serious burns. They should consequently be handled cautiously.**

**The caustic soda solution quickly retains the carbondioxid from the air, which leads to a change in the initial concentration. For this reason, usage of the densimeter enabling the determination of exact concentration of the alkaline solution available for saponification, is necessary.**

**To prepare the caustic soda solution by using the solid product from the market, you dibite the quantity of soda in the same weight of water (add small portions of the product to water by stirring well). Be cautious by wearing protecting glasses and gloves.**

**FOR SECURITY REASON, NEVER PRACTICE THE ABOVE MENTIONED OPERATION IN THE ADVERSE SENSE, BY POURING WATER ON CAUSTIC SODA !**

**The basic solution so obtained can be easily diluted by water addition and usage of a densimeter to control progression of the dilution. You so obtain the concentrated solution required for the chosen saponification process.**

**A simple and approximate method to determine the concentration of an alkaline solution consists in putting into it an egg of chicken. When this just floats over the surface, the solution contains respective:**

**180 g of caustic soda (NaOH)**

**230 g of caustic potassium (KOH)**

**for each liter.**

**Table III. gives the density and corresponding concentration levels of caustic soda and potassium solutions.**

**Table III: Density and concentration in free alcali of caustic soda (NaOH) and potassium (KOH) solutions**

Degré Baume (°Be)	Density at 15°C	1L of solution contains:		1Kg of solution contains:	
		(g NaOH)	(g KOH)	(g NaOH)	(g KOH)
1	1,007	6	9	6,,100	9
2	1,014	12	17	122,000	17
3	1,022	21	26	200,000	26
4	1,029	28	36	277,100	35
5	1,036	35	46	333,500	45
6	1,045	42	58	400,000	56
7	1,052	49	67	466,400	64
8	1,060	56	78	522,900	74
9	1,067	63	88	588,700	82
10	1,075	70	99	655,500	92
11	1,083	79	109	733,100	101
12	1,091	87	119	800,000	109
13	1,100	95	132	866,800	120

	1,100	112	152	800,000	120
14	1,108	104	143	944,200	129
15	1,116	112	153	1000,600	138
16	1,125	123	167	1009,700	148
17	1,134	134	178	1118,400	157
18	1,142	144	188	1226,400	165
19	1,152	156	203	1335,500	176
20	1,162	167	216	1443,700	186
21	1,171	177	228	1551,300	195
22	1,180	188	242	1559,100	205
23	1,190	200	255	1667,700	214
24	1,200	212	269	1776,700	224
25	1,210	225	282	1885,800	233
26	1,220	239	295	1995,800	242
27	1,231	253	309	2005,900	251
28	1,241	266	324	2114,200	261
29	1,252	283	338	2226,400	270
30	1,263	299	353	2336,700	280
31	1,274	316	368	2448,100	289
32	1,285	332	385	2558,000	298
33	1,297	348	398	2668,300	307
34	1,308	364	416	2778,000	318

35	1,320	384	432	2888,300	327
36	1,332	399	449	2999,300	337
37	1,345	420	469	3112,200	349
38	1,357	441	487	3224,700	359
39	1,370	462	506	3336,900	369
40	1,383	483	522	3449,600	378
41	1,397	506	543	3662,500	389
42	1,410	528	563	3774,700	399
43	1,424	553	582	3888,000	409
44	1,438	575	605	3999,900	421
45	1,453	602	631	4114,100	434
46	1,468	629	655	4228,300	446
47	1,483	658	679	4443,800	458
48	1,498	691	706	4661,500	471
49	1,514	721	731	4766,000	483
50	1,530	750	756	4900,200	494

**In general, 13 to 15% of the weight of the fat are necessary for saponification with caustic soda. The concentration of the alkaline solution to be used can vary between 8 and 50% according to the preparation method which is used.**

**Examples showing how to calculate the quantity of caustic soda solution needed for saponification by using the saponification value and the Baune-densimeter.**

**The amount of caustic soda necessary for complete saponification of a fat is obtained by using the following formula:**

**(Weight of fat (Kg) X saponification value X 0,713) / 1000**

**where**

**0.713 = ratio of molar masses of caustics soda and potassium (40 g: 50,1 g = 0.713) and**

**1000 = conversion factor from grams into kilograms.**

**To saponify for instance 5 Kg of peanut oil, you need:**

$$\frac{5\text{Kg} \times 190 \times 0,713}{1.000} = 0,68\text{Kg} \cdot \text{of} \cdot \text{pure} \cdot \text{causticsoda}$$

**For a mixture of fat, the easiest method consists in calculating the respective quantities for complete saponification of each component.**

**The addition of these values finally gives the total quantity of soda for saponification of the mixture.**

**Example: 100 Kg of a fat mixture composed of:**

cotton oil                      30 Kg

palm oil                         30 Kg

karitea (shea) butter 40 Kg



**For saponification of the various component, the following quantities of caustic soda are needed:**

**Cotton oil:**

$$\frac{30\text{Kg} \times 194 \times 0,713}{1.000} = 4,15\text{Kg}$$

**Palm oil**

$$\frac{30\text{Kg} \times 200 \times 0,713}{1.000} = 4,28\text{Kg}$$

**Karitea butter:**

$$\frac{40\text{Kg} \times 187 \times 0,713}{1.000} = 5,33\text{Kg}$$

**Total = 13,76 KG**

**When you use an alkaline solution, the quantity needed for saponification is obtained as follows:**

$$\frac{\text{Calculated quantity of pure soda (Kg)}}{\text{Concentration of the solution in pure soda (Kg/Kg or Kg/l)}}$$

**The exact concentration of the alkaline solution is obtained by measuring the density of the liquid with a Baume aerometer.**

**Knowing the degree of the solution and based on indications in Table III, you can determine the quantity of pure caustic soda contained in 1 Kg (or in 1 l).**

**Example:**

**The precedent mixture of 100 Kg needed, as noticed, 13,76 Kg of pure caustic soda for a complete saponification.**

**By using a solution at 24 °Be, the total quantity of that solution for a complete saponification will be:**

$$\frac{13,76\text{Kg}}{0,1767\text{Kg/Kg}} = 77,90\text{Kg}$$

### **A.I.2.2 Caustic potassium (KOH)**

**It is a strong base, which like caustic soda, allows direct saponification of neutral fats. As the latter, the concentrated solutions can cause serious burns on the skin. Caustic potasse is less currently used at home level than soda. So it's less available on the market.**

**However the home-soap-making uses it most exclusively as alkaline source in rural zones. For this purpose you treat vegetable ashes with water. Potassium made soaps are quite soluble in water and present a bright ability to adsorb it (hygroscopy). They are thus of soft consistency and even liquid.**

### **A.I.3. Water**

**The reaction environment for saponification is an emulsion between fat and water, in which the needed alkali is diluted. Appropriate water for soap making is soft water (rainwater for instance), as hardness elements of water, the magnesium and calcium ions present the propriety of deleting the washing action of soaps.**

**An easiest method for softening a hard water consists in adding concentrated alkaline solution, mixing it well and left still for 1 to 2 days. The Mg and Ca ions will then form in water insoluble byproduct that deposit at the bottom of the container**

#### **A.I.4. Secondary products**

**The secondary products used for making improved soap are: salt, additives (clay, kaolin, starch, silicate, carbonate etc). Usage of these products is not strictly necessary for soap making, but they can present some technical and trading advantages (improvement of usage qualities, decrease in production costs for instance).**

##### **A.I.4.1. Salt**

**Addition of salt to soda soap leads to achievement of very hard soaps. This practice is based on the fact that soap is not soluble in salted water. Glycerine which is soluble in water is then eliminated with other impurities of the raw materials. Soaps obtained from some fat like copra, palmist or castor oils can incorporate high quantities of salt without being greened out. In this case salt can be used as filling material.**

**The quantity of salt to be added for greening out varies according to the nature of**

**the fat and is about 10 g of salt for each 100 g of original fat material. The main advantage of greening out is that it gives purified soap.**

#### **A.I.4.2 Additives**

**These products are added to soap in order to either increase the quantity or to give it a hard consistency. To that aim you can use clay or kaolin or starch or silicates of soda or potassium etc. The later can contribute to improvement of washing qualities of the soaps containing it and protect them also form becoming rancid. Other types of additives like alcohol, sugar and glycerine are used to produce transparent soaps. Kaolin can be added to an optimal rate of about 5% of the mass of the initial fat to be saponified.**

#### **A.I.4.3 Colors**

**The color of the product may be important for good selling. To achieve this, the home level soap maker may use some natural colors. Among them you can use the extracts from niebe leaves (vigna sp) for the green color and extracts from red sorgho (Sorghum sp) for colors going form red-brown to orange.**

**The extraction of these colors is made with diluted alkaline solutions. The process consists in putting mashed leaves in maceration in alkaline solution until you achieve the color you wish. The obtained liquid can be used after filtering.**

**Non bleached palm oil also can be used (after being filtered) for colorations from light-yellow to orange.**

**According to local availability, other natural colors can be used. They should how**

**ever be stable to alkaline and oxidation.**

**The above mentioned extracts should be incorporated to the hot mass of soap at the rate of 0,1 to 5% of the initial fat weight.**

#### **A.I.4.4 Scents**

**In order to give a scent to the soap, the soap maker may use extracts from local plants containing perfumes (etheric oils). Extracts from citronel and lemongrass (Cymbopogon sp.), Eucalyptus (Eucalyptus sp) etc. are appropriate.**

**The extraction itself is a simple process which is done with steam according to the following scheme:**

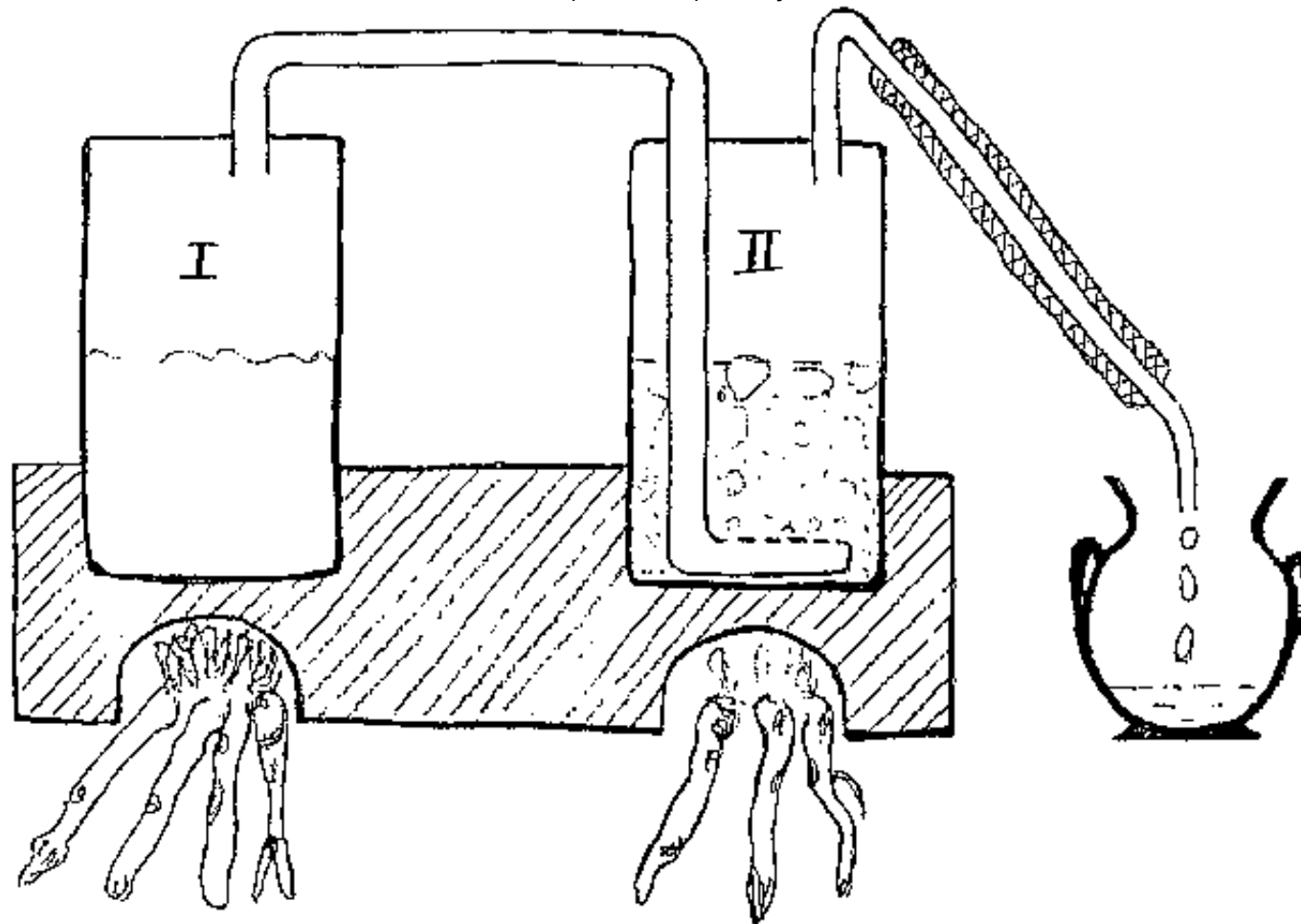

### Installation of steam distillation of etheric oils

- Putting water into containers I and II (metallic containers of 50 l for example);
- Heating intensively container I and moderately container II;
- After bringing containers I to boil, put the smashed vegetable material in container II;
- Put in place a vase to recuperate the liquid of condensation, connect the

- tube for condensation and close hermetically the container II;**
- Then connect I and II, close I hermetically and go on heating it intensively during about 15 minutes;**
  - After 15 minutes, stop the operation and recuperate the cloudy water of condensation.**

**The so achieved extract is incorporated into the soap by mixing it at rate of 1 to 100 g for 100 kg of raw fats.**

#### **A.I.4.5 Skin protecting agents**

**Soaps obtained from some fats are damageable to skin. These harsh side-effects are particularly valid for palmist and copra butter based soaps. For this reason addition of skin protecting agents to such soaps is necessary.**

**Among the natural products which can play this role by improved soaps you may consider: the portion of insaponifiable in the fat, a light surplus of non saponified fat (to be added for instance at the end of the operation) and addition of natural wax (about 3 - 5 % of beeswax for example).**

#### **A.II. Technology of improved soaps making**

**Soap fabrication from neutral fat (triglycerol) and alkali (for instance caustic soda, NaOH) is achieved according to the following reaction:**

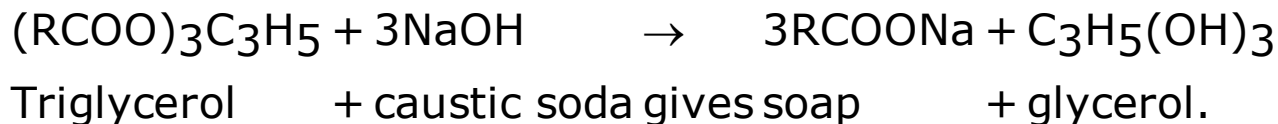

**According to the conducting temperature of the saponification reaction, we distinguish three (3) different methods of soap-making: the saponification at cold temperature, the semi-hot saponification process and the hot process.**

### **A.II.1. Cold saponification process**

**It is a simple process which requires less time and energy. Moreover the produced soap contains glycerine. This has a good effect on skin and can contribute to a better conservation of soaps during storage (prevention from dehydration). This soaps are well soluble and produce a lot of foam.**

**The main disadvantages of this method are:**

- All fats are not usable for saponification according to that process, particularly some proportion of copra butter and/or palmist oil should be incorporated into the fats mixture;**
- The soap produced contains all the impurities of the reaction mixtures;**
- A surplus of free alkaline is necessary to prevent the rancidity.**

**Operating method:**

**The (mixture of) fat is heated in the boiler up to 40°C. Then You add the necessary alkaline solution tin small portions at the beginning), by stirring well in the same direction. By using caustic soda, the appropriate solution must have a concentration of 20 to 35% of NaOH (or about 26 to 40 °Be. By correct operating, the reaction produces enough heat to ensure a complete saponification.**

**The auxiliaries (additives, color, scent) are incorporated when the reaction has**



**really started (the mixture then shows a consistency which looks like that of honey). The warm mass is then poured into big moulds where the complete saponification reaction is achieved.**

### **A.II.2. Semi-hot process**

**This method of saponification is also easily to implement if you practice the following way:**

- Heat fat (or mixture of fat) at about 55 - 70 °C;**
- Add (slowly and in small portions at the beginning) the alkaline solution necessary to saponification by stirring (the reaction produces heat and the temperature of the mixture can increase up to 90°C)**
- Leave the mass become cold to 60°C and mix in the auxiliaries;**
- Pour the soap in containers (for 24 to 36 hours) and leave it until it becomes cold and hard.**

**The above mentioned cold and semi-hot processes are quite well indicated for improved soap-making at home and small-scale levels considering their easy implementation and the quality of the products they can generate**

### **A.II.3. Hot or full boiling process**

**This method of saponification is mainly used for production of hard sodium soaps.**

**The implementation of operations is identical to that of semi-hot process until the real starting of soap formation (increased viscosity of the reaction medium). From this stage, you add by portions the remainder of the alkaline solution by stirring when being heated. After adding the calculated alkaline, you heat the mass up to ebullition during a few hours.**

**At the end of this operation practice, the graining out consisting in adding salted water or humid salt, must be carry out. The initial mass divides then into 2 phases: an inferior stage composed of salted water, glycerol and soluble impurities present in the mixture and a superior stage composed by the soap (insoluble in salted water).**

**The resulted soap undergoes again some special operations (cocking in a strong bleach, liquidation etc.) before being poured in moulds for hardening.**

**This process, when correctly executed can produce a soap of semiindustrial quality. According to its complexity and the high cost of investments for purchase of adequate equipments, this process can be recommended only for production of semi-industrial soap.**

**The above described process enable production of laundry and simple toilet soaps. To produce special soaps (high class toilet soap, transparent soaps, medical soaps, shaving soap etc.) the application of other soap making processes is necessary.**

#### **A.II.4 Control of saponification**

**To follow-up the execution of saponification and to control the quality of the soap**

**produced, you can practice two simple methods:**

- A sample of well soap should melt in water without turning it muddy;**
- The presence of small drops of fat bodies indicates a shortage in alkaline, thus incomplete saponification;**
- A well made improved soap shall present a light spicy taste due to the light surplus of alkaline necessary for a good preservation for rancidity**

**For the consumer a good soap should have the following qualities:**

- Have a clear color, fast white;**
- Be hard on touch;**
- Produce quickly abundant and stable foam;**
- Have a soft and good effect on the skin;**
- Be able to conserve during a long period without loosing the above mentioned qualities.**

**Soaps produced from simple fats scarcely have all these qualities.**

**The saponification of fat mixtures gives the operator the advantage to be able to influence the qualities of the final product by choosing fats with complementary properties as component.**

**For this reason, the best soaps are produced in practice by saponification of fat mixtures different origins. So, if you want to produce a hard consistency soap, the INS Factor of the mixture should have a minimum value of around 110. You therefore can choose fat which soaps have different qualities as concerning foaming, cleaning property, action or effect on the skin.**

**The limiting element to the extent of such compositions is the availability of the appropriate fat on a considered geographic area. The availability of the fat according to their source in the 3 main ecological zones which characterize the developing countries is the following:**

**Equatorial zone   Humid tropical zone   Semi arid tropical zone**

copra	peanut	peanut
fat (pork)	cotton	neem
palm	karitea(shea)	tallow (mutton, cow)
palmist	fat (pork)	
	palm	
	pourghere	
	castor plant	

**In chapters C to G the technical details about preparation of improved soaps at family and small-scale level (cold or semi-hot process) and based on locally available fats are explained.**



**[Home](#) > [ar](#).[cn](#).[de](#).[en](#).[es](#).[fr](#).[id](#).[it](#).[ph](#).[po](#).[ru](#).[sw](#)**

 **How to Make? An Improved Soap .. Not just for more Foam (GTZ, 1993, 71 p.)**

  **B. Equipment and materials**

 **(introduction...)**



**B.I. Material and equipment for preparation**

**B.II. Material and equipment for the finish product**

**How to Make? An Improved Soap .. Not just for more Foam (GTZ, 1993, 71 p.)**

**B. Equipment and materials**

**To produce soap at the family and small-scale levels you need the following equipment and materials:**

- **Boiler for pretreatment of fats;**
- **Boiler for saponification and material for mixing;**
- **Container for preparation of the alkaline solution;**
- **Balance and densimeter;**
- **Moulds to pour in the soap;**
- **Material to cut soap;**
- **Small material (gloves, plastic bols, glasses, pails.**

**Some of these materials are used for soap preparation while others are rather used for the finishing of the product.**

**The small materials such as plastic gloves and boot, glasses, pails etc. are used at every stage of production.**

**B.I. Material and equipment for preparation**

**B.I. MATERIAL AND EQUIPMENT FOR PREPARATION**

**B.I.1. Boiler**

**B.I.1.1 Boiler for pre-treatment of fats**

**A cone mounted with a cylinder would be the ideal shape for the boiler but the simple cylinder is also appropriate if it has a sufficient height. Two tapes at least should also be placed at different levels, one at the bottom in order to easily eliminate the impurities.**

**The material to be poured for confection should stand fire a lasting period .**

**Figure 1 represents the sketch plan of a boiler for pretreatment.**

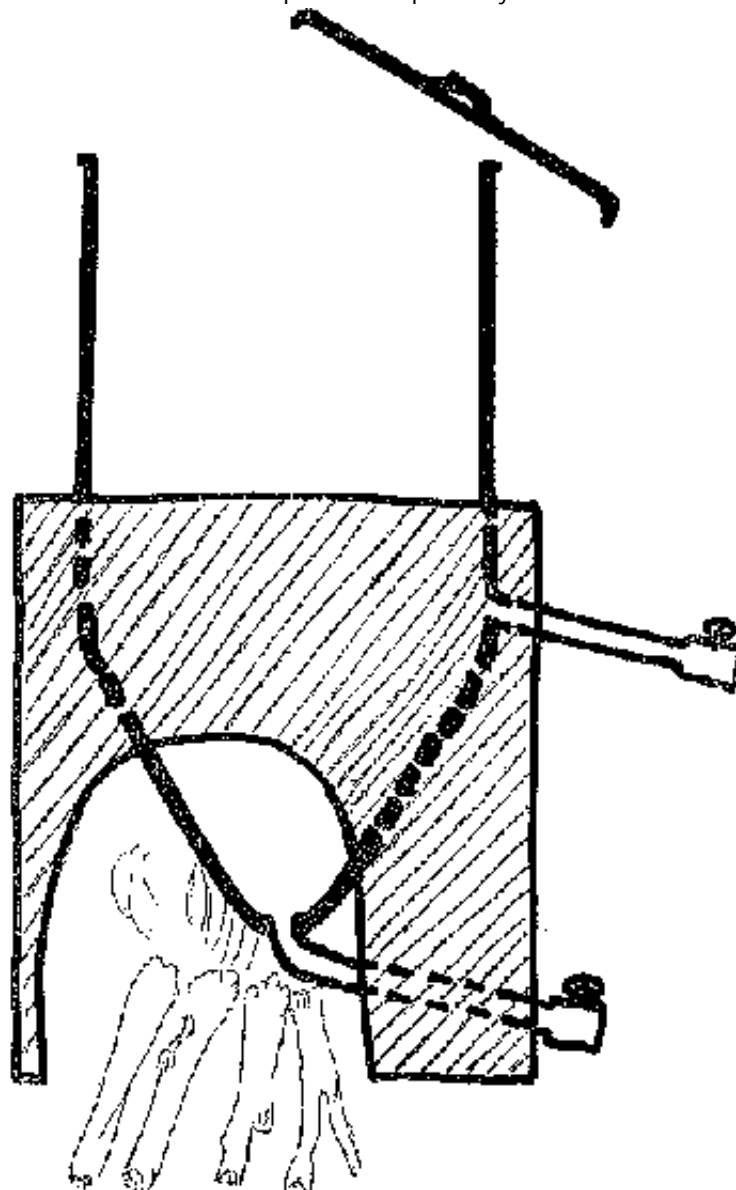

**Fig. 1 : BOILER FOR FAT RAFFINATION**

**B.I.1.2 Boiler for saponification**

**Any wide opening container standing direct contact with heating fire and made out**

**material supporting alkaline, can be used as a boiler for saponification.**

**In the practice, iron is the material indicated for developing countries. The pottery containers would also be appropriate if they were less fragile. They are nevertheless used sometimes in traditional soap making at home level.**

**The boiler may have various shapes. Though the classical shape, reducing at a minimum the risk of over pouring during the heating is a combination of an half cone with a out flow device at the bottom and a cylinder. This shape can easily be integrated in a direct heating stove.**

**Figure 2 represents the sketch plan of such a boiler designed at the TCC (Technology Consultancy Center) at Kumasi, GHANA.**

**Simple cylinder shape boilers are also appropriate.**

**The quantity (mass) of soap to be made by charge in a boiler varies from  $1/3$  to  $1/2$  of the boiler volume.**

**For the small loads (up to about 500 l) mixing may be done with a stick. For more important quantities, a mechanic mixing equipment is highly recommended.**

**Figure 3 shows the sketch plan of such an equipment.**



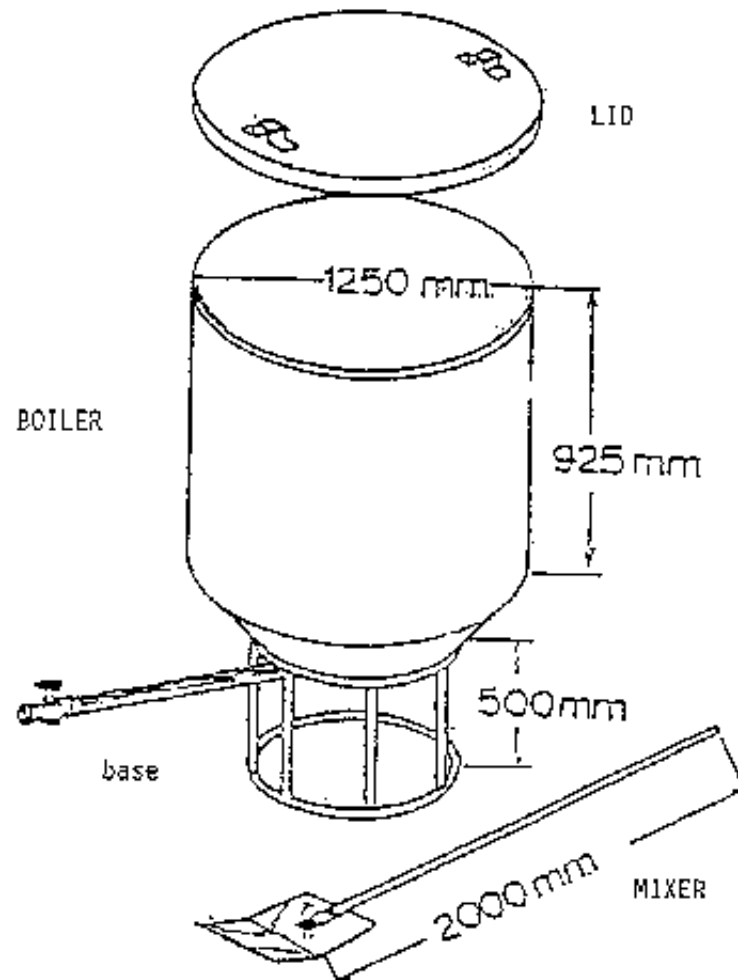

**Fig. 2 : BOILER FOR SAPONIFICATION, TYPE TCC**

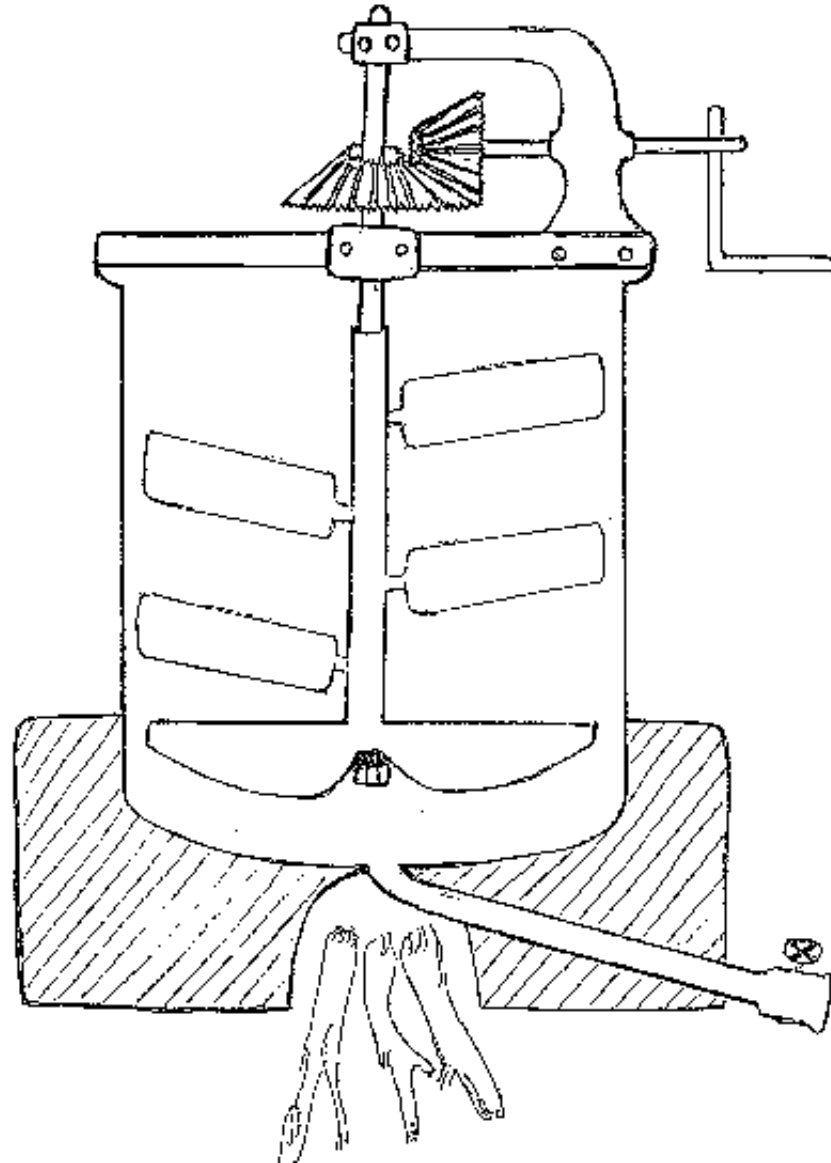

**Fig. 3 : BOILER FOR SAPONIFICATION WITH MIXTURE ELEMENT**

### **B.I.2 Container for the alkaline solution**

**Alkaline solution should be prepared in wide-opening containers, constructed in**

**material resistant to alkaline. An empty barrel for instance would be well appropriate. For storage, hermetic containers are necessary.**

### **B.I.3. Balance and densimeter**

**These two measuring instruments enable the determination of the quantities of raw materials entering in the preparation of soap.**

**The appropriate scale for traditional soap-making should be able to weigh at least 100 Kg during a single operation. Various models filling this fundamental condition are available on the market.**

**The Baume aerometer (or densimeter) enables the determination of the density of a liquid. It is also available on the market as industrially manufactured product. In case of unavailability you may refer to the solution which consists in putting one (1) egg or one(1) potato in the alkaline solution.**

**As the sketch indicates, when these objects float just at the surface, the solution has for instance an intake of 180 g of pure soda (NaOH) for each Kg (18%).**

## **B.II. Material and equipment for the finish product**

### **B.II.1 Moulds**

**They are used to flow in the (hot) fluid mass of the soap. They may be of various shapes and should better be constructed in wood. For the cold processed soaps the big measurements moulds are particularly indicated as they allow a better conservation of the heat from the reaction.**

**Figure 4 shows the sketch plan design of a mould which can be taken to pieces, type ATDA (see chapter G. No.5) for the easy recuperation of the soap bar after its herding.**

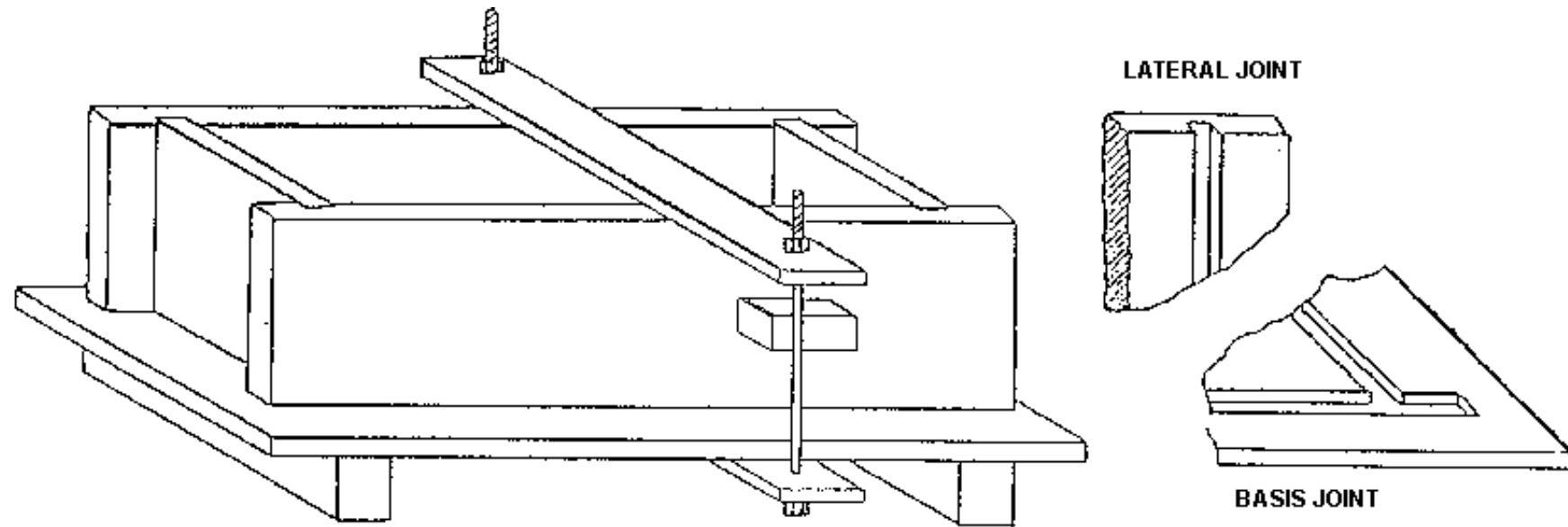

**Fig. 4: MOULD FOR COLDING AND HARDENING WITH CONSTRUCTION DETAILS**

### **B.II.2.Equipment used for cutting**

**After being taken out of the mould the blocks should be cut into portions themselves cut into bars.**

**The adequate simple techniques for cutting is the usage of wires (straight or not) and of a bar marker .**

**Figure 5 represents a sketch of these simple equipments .**

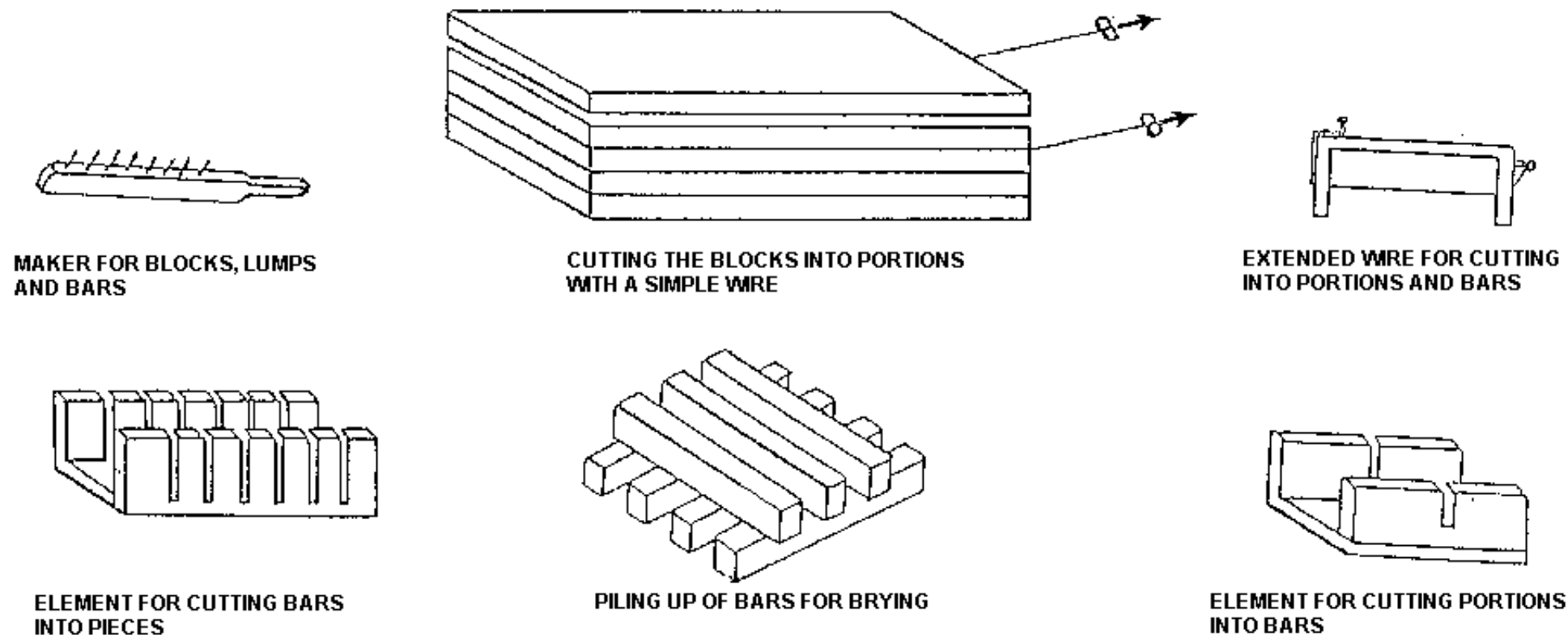

**FIG. 5: MATERIALS AND SIMPLE TECHNIQUES USED TO CUT AND DRY SOAP**

**For cutting the soap blocks and bars you may also use a cutting table, mainly when the produced quantities are important.**

**Figure 6 shows the sketch of such a table.**

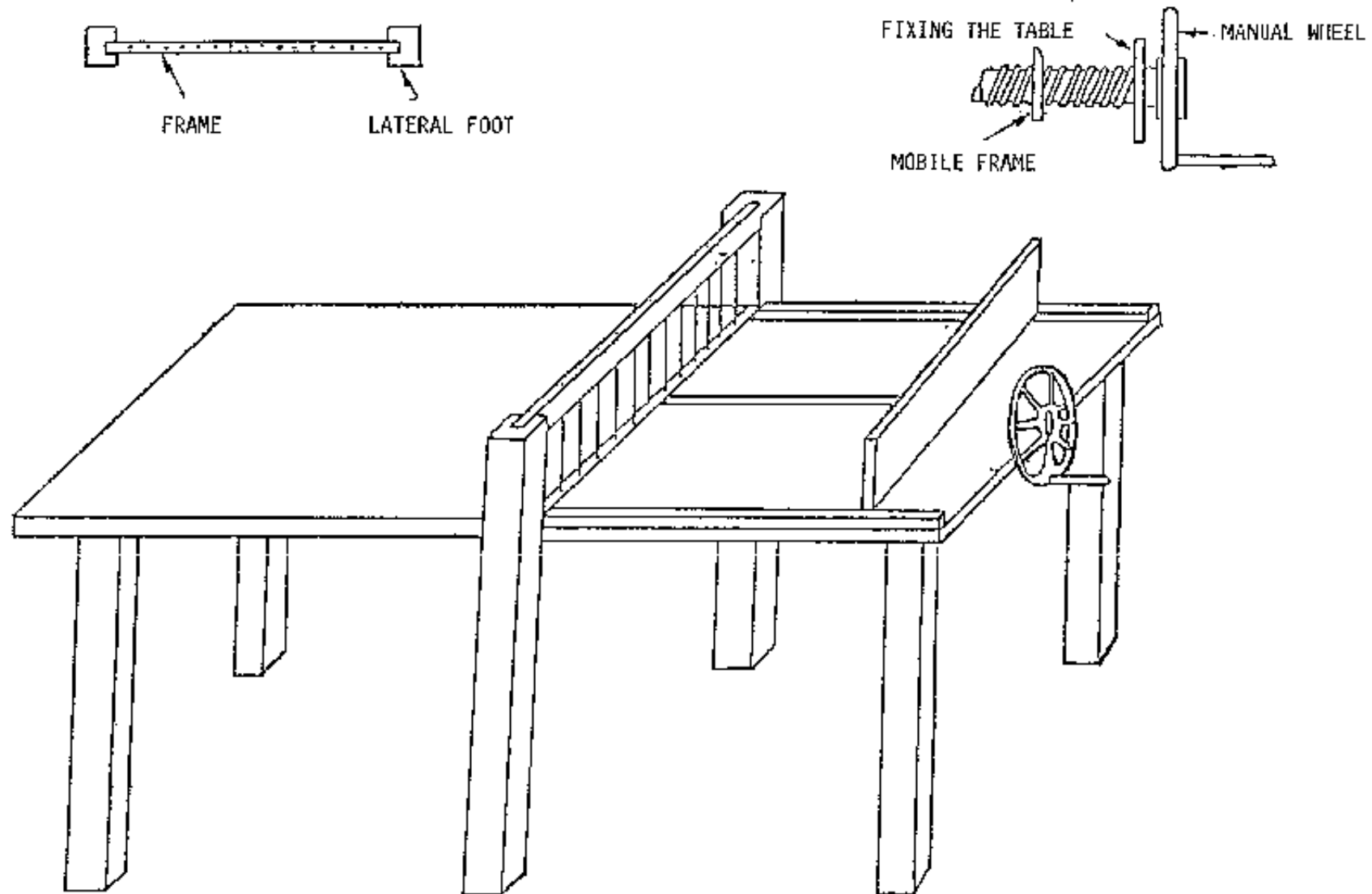

**FIG. 6: CUTTING TABLE WITH CONSTRUCTION DETAILS**

### **B.II.3. Packaging material**

**The soap bars should be piled up in a manner that the air can easily circulate between them; so they would dry under control. When the market requires it, a**

**cutting into pieces is then carried out. The shaping of each piece of soap by stamping is generally not necessary at this scale of production. Cartons or baskets can be used as packaging for the transport and commercialization.**















[Home](#) > [ar](#).[cn](#).[de](#).[en](#).[es](#).[fr](#).[id](#).[it](#).[ph](#).[po](#).[ru](#).[sw](#)



## **How to Make? An Improved Soap .. Not just for more Foam (GTZ, 1993, 71 p.)**

### **C. Saponification of simple fats**

-  **C.I. Peanut oil**
-  **C.II. Copra oil**
-  **C.III. Cotton oil**
-  **C.IV. Shea butter**
-  **C.V. Palm oil**
-  **C.VI. Palmkernel oil**
-  **C.VII. Tallows (cow and mutton)**
-  **C.VIII. Fat (pork)**
-  **C.IX. Neem oil**
-  **C.X. Pourghere oil**
-  **C.XI. Castor oil**
-  **C.XII. Sesame oil**

**How to Make? An Improved Soap .. Not just for more Foam (GTZ, 1993, 71 p.)**

## **C. Saponification of simple fats**

### **C.I. Peanut oil**

**It is extracted from peanut seeds (*Arachis hypogaea*). As edible oil, it possess the followings characteristics:**

#### **Physic-chemical characteristics:**

Density at 15°C:	0,911 - 0,925
Solidification point:	-2 to + 3°C
Iodine number:	84 - 105
Saponification value:	185 - 195
INS Factor:	80 - 111
Intake in insaponifiable:	0,5 - 1%
Intake of the alkaline solution indicated for saponification:	18 to 42 °Be

**The soap obtained from caustic soda is hard enough and of white color. It has a good washing power and develops a soft effect on the skin but foams little. It is stable at storage (doesn't become rancid).**

### **Preparation of soap**

#### **Pre-treatment**

**Raw peanut oil doesn't presents a strong color. It's scent is pleasant and is not very accentuated. The pre-treatment for saponification can thus be limited to the**



## **purification of the fragments and gums contained in the pressed oil.**

**To achieve this, you mix the latter with salted hot water and you boil the mixture for about 20 to 30 minutes.**

**Then you stop the heating and let the mixture become cold. Two stages are then formed: the upper stage composed of the purified oil should then be extracted for saponification.**

**The salted water to be added should have a concentration of 10 %. The quantity to be mixed with the raw oil is of 25% of the weight of the latter. To purify 100 Kg of raw oil according to that method you need: 25 Kg of salted water at 10% that is to say 2,5 Kg of cooking salt dissolved in 22,5 l of hot water.**

## **Saponification**

**The adequate techniques here indicated is the semi-hot process.**

### **Recipe:**

**100 Kg of purified oil**

**38,8 of caustic soda at 40 degree**

**5 Kg kaolin in fine powder**

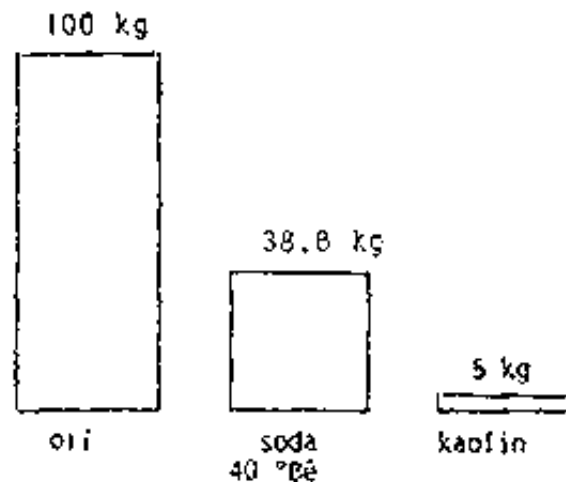

**Figure**

## How to carry out the operations

- **Weight the necessary quantity of purified oil;**
- **Heat the oil up to a temperature of 55 - 60 °C in a boiler;**
- **Add slowly by mixing the calculated quantity of alkaline (with an excess of 0,1 to 2 %) under the form of a solution at 40 °Be (36,95 % of NaOH);**
- **After adding all the alkaline, continue mixing during a few minutes until you see the appearance of an emulsion;**
- **Close the boiler into which an auto-heating phenomenon happens, due to the heat production accompanying the saponification reaction (in the big boilers in full charge, the temperature can increase up to 95°C );**
- **Leave it till the temperature decreases down to 60 °c and control the quality of the produced soaps;**
- **Let it cold down to 50 °C and mix in the additive substances (kaolin for example at 5 %) the perfumes and colors (all these additives should be**

**stable to alkaline);**

- Pour the mass into moulds and leave it become cold;**
- Cut them into bars and eventually into pieces.**

## **C.II. Copra oil**

**Extracted from coconut (Cocos nucifera), it has the following essential properties:**

Density at 15 °C:	0,914 - 0,916
Solidification poin:	20 - +28 °C
Iodine number:	7 - 10
Saponification value:	250 - 262
INS Factor:	240 - 255
intake in insaponifiable:	0,4 - 1,2%
Caustic soda solution indicated for saponification:	26 to 40 °Be

**The soda soap is white, very hard. It can incorporate big quantities of salted water. Easily soluble in water, it forms an abundant but less stable foam. The cleaning power is also very good, unfortunately the effect on the skin is rather harsh (rashes on the skin).**

## **Preparation of soap**

**The saponification of copra oil is easy, even at cold. The strong alkaline solutions are well appropriate to that end (25-40 °Be). The copra oil soaps are low stable to storage and have a great tendency to the deterioration of their structure and to**

**getting rancid.**

## **Pre-treatment**

**As a simple method of refining copra oil, the washing in boiling salted water can be used (see detailed description in the chapter peanut oil).**

## **Saponification**

**Copra oil is well appropriate for soap preparation by using the cold process.**

### **Recipe:**

**100 Kg of purified copra oil;**

**42,31 Kg of caustic potassium solution at 26 °Be**

**31,40 Kg of caustic soda solution at 40 °Be**

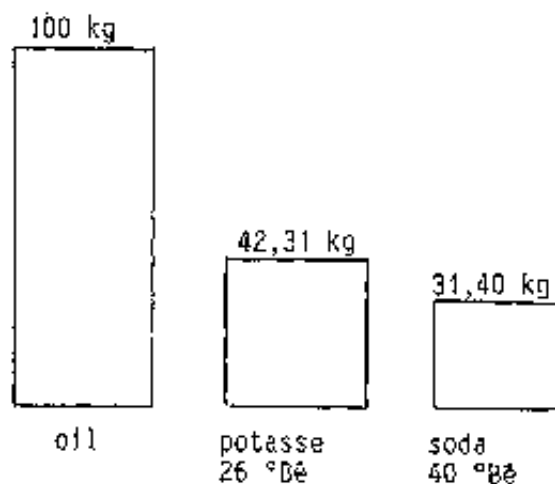

**Figure**

## How to carry out operations

- Weigh the necessary quantity of purified oil and eventually heat at 35- 40 °C
- Add slowly and in small portions, the alkaline solution necessary to saponification (a method consists in using two solutions with different concentrations: the low concentrated is vigorously mixed in order to ensure the formation of an emulsion and then the strong intake solution is incorporated into );
- Go on mixing until the mass gets a sticky (gluey) consistency;
- Add the additive products and eventually the scents and colors, by mixing;
- Pour the hot mass into big moulds;
- You then close the moulds in order to ensure auto-heating accompanying the saponification reaction;
- After cording and hardening of the blocs, take them out of the moulds and cut into bars (eventually in pieces).

### C.III. Cotton oil

It is extracted from cotton seeds (*Gossypum sp.*).

The physical and chemical characteristics are the following:

Density at 15 °C:	0,92 - 0,93
Solidification point:	0 to 4 °C
Iodine number:	100 - 117

Saponification value:	190 - 198
INS Factor:	73 - 98
Intake in insaponifiable:	0,50 - 1,50 %
Intake of caustic soda solution indicated for saponification (refined oil):	12 to 15°Be

**Caustic soda soap is yellow colored, soft and less soluble in water. It has a good washing power and produced an average stable foam. It's effect on the skin is rather smooth. Not well adapted to conservation, it shows a great tendency to formation of stains and to growing rancid during storage.**

## **Preparation**

### **Pre-treatment**

**The raw cotton oil presents a dark brown color due mainly to its intake in gossypol (a toxic polyphenolic substance). Moreover it produces a specific scent and should consequently under go a refining before saponification if you want to achieve a product with acceptable quality.**

**As simple method of purification you can use the refining by treating with a light alkaline solution. The alkaline contained in this solution forms with the free fatty acids of oil small flocks of soap, which adsorb and eliminate from the oil odorous and colourous substances as well as impurities. These flocks are then eliminated by settling.**

**The process consists in:**

- Weighing the quantity of raw oil and heating it at about 50 °C;
- Adding an alkaline solution of 20 °Be (about 10% of the raw oil weight) by stirring during 30 minutes;
- Leave it become cold (flocks will then be deposited) and settle the refined oil.

## Saponification

To achieve this the semi-hot process should be used.

### Recipe:

**100 Kg of purified cotton oil;**

**34,4 Kg of caustic soda solution at 12 °Be;**

**62,75 Kg of caustic soda solution at 24 °Be;**

**5 Kg of kaolin.**

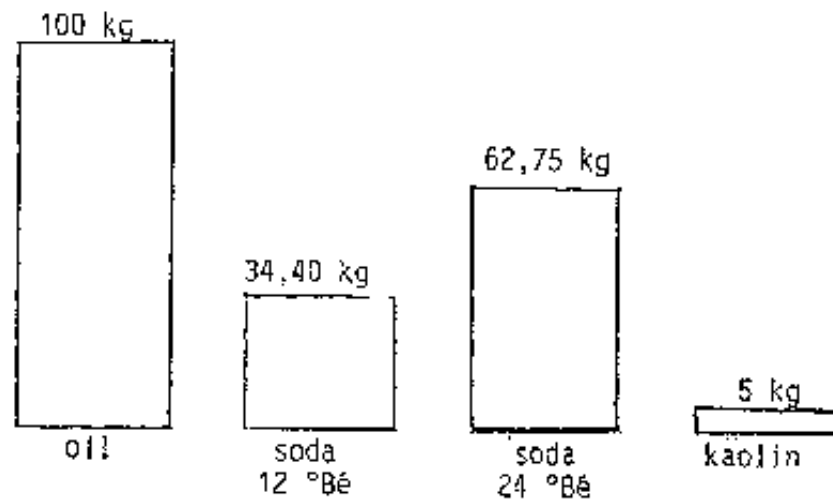

**Figure**

## How to carry out the operation

- Weigh the necessary quantity of purified oil;
- Heat the oil in the boiler at a temperature of 55 - 60 °C;
- Stop the heating;
- Add the necessary quantity of alkaline solution by stirring (in case you use caustic soda take a solution at 12 °Be)
- Go-on stirring during a few minutes until the appearance of an indication that the temperature has really gone up;
- Stir from time to time and let the temperature decrease to about 60°C, and then check the quality of the soap;
- Add and incorporate the auxiliaries;
- Pour the hot mass into moulds and leave it to become cold;
- Take the hardened blocks out of the moulds and cut them into bars and pieces.

### C.IV. Shea butter

It is extracted from the karitea nuts (*Butyrospermum parkii*). It is a picking product from the african savannas.

#### Physical and chemical characteristics:

Density at 15 °C :	0,917 - 0,918
Solidification point:	17 to 27 °C
Iodine:	55 - 67
Saponification index:	178 - 196



**Saponification index:****INS:**

Intake in insaponifiable:

Intake of alkaline solution indicated for saponification (refined oil): 10 to 24 °Be

170 - 150

111 - 141

2 - 11%

**Caustic soda soap is hard and of white color. Less soluble in water, it foams little and slowly, develops a very smooth effect on the skin and has a good washing power. Unfortunately it is less stable at storage (change of color and becomes rancid).**

**Preparation of soap**

**The shea butter has a tan color and a specific scent. It contains proportion of insaponifiable mainly composed of karitene.**

**As pretreatment before saponification, the washing with salted boiling water is indicated (see description of the process in Chapter C.I: peanut-oil)**

**Saponification**

**The semi-hot process is well indicated for the karitea butter**

**Recipe:****100 Kg of purified shea butter;****67,75 Kg of caustic potassium solution at 10 °Be;****50 Kg of caustic soda solution at 24 °Be;**

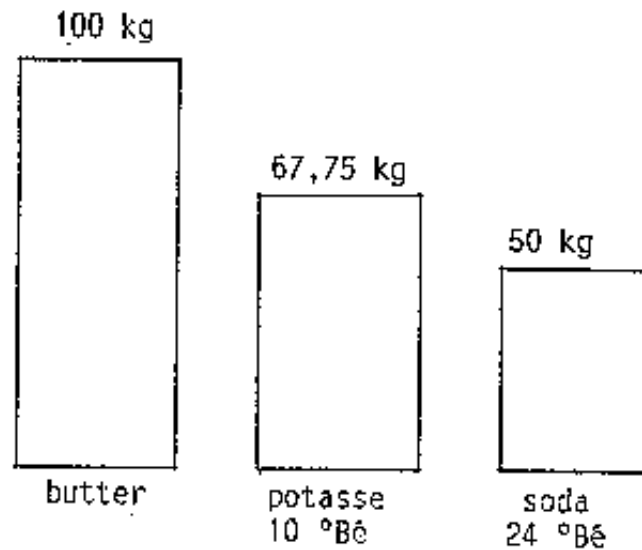
**Figure**

## How to carry out the operation

- Weigh the quantity of butter;
- Heat the weighed butter in the boiler at a temperature of 55 - 60°C
- Stop the heating;
- Add slowly and in small proportions the 10 °Bé caustic potassium by stirring well/formation of an emulsion);
- Add in portions the 24 °Bé caustic soda solution by stirring (the temperature increases)
- Stir from time to time;
- Let the temperature decrease to about 50 - 60 °C;
- Then add and incorporate the additives;
- Pour the soap into moulds;
- Leave it get cold and hard;
- Take out the moulds and cut into bars (and eventually into pieces).

## **C.V. Palm oil**

**It is extracted from the pulp of the palm fruit (Elais sp.). Industrial plantation are done in equatorial zones with abundant rains. In humid savannas, the palm tree grow naturally in the valleys along the rivers so that palm oil must be seen as picking product in this ecological zone.**

### **Physical and chemical characteristics:**

Density at 15 °C:	0,921 - 0,94
Solidification point:	24 to 30 °C
Iodine:	44 -58
Saponification value:	195 - 205
INS Factor:	137 - 161
Intake in insaponifiable:	< 0,5%
Intake of alkaline solution indicated for saponification (refined oil):	10 to 40 °Be

**The sodium soap is hard and of yellow-pale color. It is well soluble in water and slowly forms a lot of stable foam. It has a very good washing power and exerts a very smooth effect on the skin. Unscented, it develops an odor which recalls the oil of origin. It is stable at stockage (doesn't grow rancid).**

**Palm oil constitutes on of the fat most used in soap-making.**

### **Soap preparation**

#### **Pre-treatment**

**The raw oil has a strong color going from the yellow orange to redbrown. It should then undergo a refining (purification and decoloration) if you want to achieve good colored soaps.**

**The washing at salted boiling water constitutes a simple means of purification (see technical details of the process in the chapter "peanut oil").**

**For the bleaching (decoloration) the thermic treatment is a simple method.**

**It can be implemented as follows:**

- Heat raw oil in a wide-opening container up to 200 - 250 °C by stirring from time to time;**
- Carry on the operation until a piece of paper which is dipped into the oil doesn't show any coloration.**

## **Saponification**

**The refined palm oil, according to the above described process, is well appropriate for saponification. To achieve this you use the cold process as well as the semi-hot one.**

### **Recipe:**

**100 Kg of refined palm oil;  
35,50 Kg of caustic soda solution at 15 °Be;  
30,65 Kg of caustic soda solution at 40 °Be**

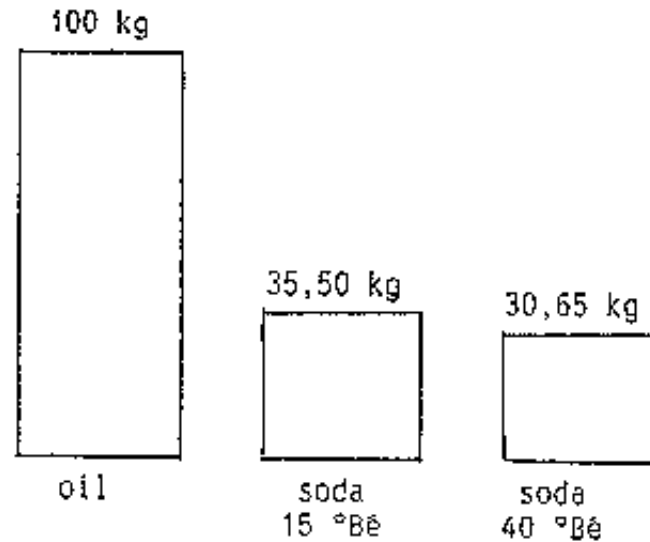
**Figure**

## How to conduct the operations

- Weigh the necessary quantity of refined oil and heat it in the boiler to a temperature of 55 - 60 °C;
- Stop the heating and add slowly in small portions the 15 °Be caustic soda solution (formation of emulsion);
- Then add the portion of the strong caustic soda solution (40 °Be) by stirring;
- Stir from time to time and let the temperature decrease progressively;
- Incorporate the additives when the mass gets a temperature of about 55 °C ;
- Then pour the soap into moulds;
- Leave it get cold and hard;
- Take out of the moulds and cut the lumps into bars and pieces.

## **C.VI. Palmkernel oil**

**It is extracted from the seeds of oilpalm fruit (Elais sp.).**

### **Physical and chemical characteristics:**

Density at 15 °C:	0,925 - 0,935
Solidification point:	19 to 30 °C
Iodine number:	14 - 20
Saponification value:	242 - 254
INS Factor:	222 - 240
Intake in insaponifiable:	0,2 - 0,8%
Intake of alkaline solution indicated for saponification (refined oil):	26 to 40 °Be.

**The soda soap is very hard and has a yellow-cream color. After graining out, it can even become breakable. The washing power is very good (even in cold water) and foaming appears quickly, but the foam is less stable. Stable at stockage, it develops unfortunately a harsh effect on the skin.**

### **Soap preparation**

**Palm kernel (palmist) oil has a white yellow color. It's soaping characteristics are similar to those of copra oil. As the latter it is easily saponifiable.**

### **Pre-treatment**

**The pre-treatment necessary to the saponification of palmist oil consists in the**

**purification of raw oil. This can be achieved by washing it in boiling salted water (see detailed description in the chapter "peanut-oil").**

## Saponification

### Recipe:

**100 Kg of purified oil;  
19,94 Kg of caustic potassium solution at 15°Be;  
38 Kg of soda solution at 40 °Be;  
5 Kg of salt.**

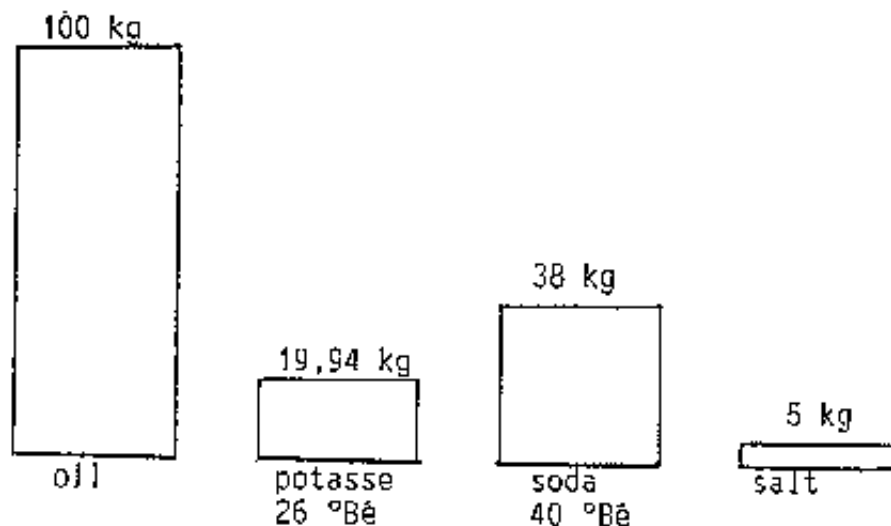

**Figure**

**The palmist oil is well appropriate for saponification at cold. In this purpose you can use two alkaline solutions of different concentration.**

### How to conduct the operations

- **Weight the necessary quantity of purified oil and heat it in the boiler at 35**
- **40 °C;**
- **Add slowly and in small portions (by stirring) the alkaline solution of weak concentration);**
- **After the appearance of a good emulsion, add the concentrated alkaline solution by stirring intensively;**
- **Go on mixing it until the mass of soap gets a high stickiness;**
- **Then add the auxiliaries and keep stirring in order to warrant their incorporation;**
- **Pour the hot mass into big moulds (immediately covered in order to keep in the heat of the reaction);**
- **When the blocks of soap get cold and hard take them at the moulds and cut into bars (and eventually into pieces).**

### **C.VII. Tallows (cow and mutton)**

**They are similar fats, deposited by these animals as food stock in special parts of the body (mainly in the abdominal cavity). They can be extracted by cooking in presence of an acid or a base.**

#### **Physical and chemical characteristics:**

	<b>COW</b>	<b>MUTTON</b>
Density at 15 °C:	0,936 - 0,952	0,936 - 0,960
Solidification point:	30 to 38 °C	32 - 45 °C
Iodine number:	32 -47	31 - 47
Saponification value:	193 - 200	192 - 198



Saponification value:

155 - 200

152 - 158

INS Factor:

146 - 168

145 - 167

Intake in insaponifiable:

0,3 - 0,8%

0,1 - 0,6%

Intake of alkaline solution indicated for saponification: 8 to 15 °Be

8 - 15°Be

**Sodium soaps of tallow are grey-white to yellow-cream. Very hard (breakable) and less soluble in water, they produce a little, but stable foam. They possess a good washing power and a very smooth effect on the skin. Mutton tallow produces a soap having a specific odor.**

## **Soap preparation**

### **Pre-treatment**

**Due to the specific odor they produce, tallows should undergo a deodorisation before their saponification.**

**The extended washing in salted boiling water (with addition of essential plants extracts) can give good results.**

### **Saponification**

**Saponification of tallow can be better made with light concentration alkaline solutions (8 to 15 °Be). It is however appropriate to use two solutions of different concentration semi-hot processing is also very well indicated.**

### **Recipe:**

**100 Kg of purified beef suet;**

**66,6 Kg of caustic potassium solution at 8 °Be;**  
**36,59 Kg of caustic soda solution at 35 °Be;**  
**5 Kg of kaolin.**

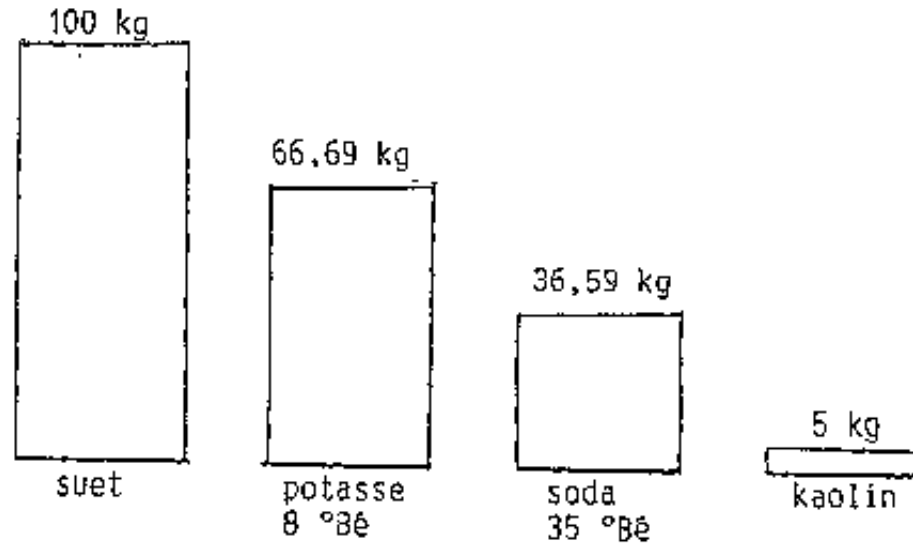

**Figure**

### **How to conduct the operations:**

- **Weigh the necessary quantity of purified tallow and heat it in the boiler up to a temperature of 55-60 °C ;**
- **Stop the heating and add slowly and by small portions the caustic potassium solution by stirring;**
- **Then add the portion of caustic soda solution by stirring on (the reaction produces a lot of heat);**
- **Let the temperature decrease progressively (add and mix in the secondary products when the temperature decreases down to 50 - 55 °C )**
- **Pour the soap into moulds;**

- **Leave it become cold and hard;**
- **Take out of moulds and cut into bars and pieces.**

### **C.VIII. Fat (pork)**

**It is obtained through melting (cooking) of pork fat.**

#### **Physical and chemical characteristics:**

Density at 15 °C:	0,914 - 0,922
Solidification point:	22 to 32 °C
Iodine number:	70
Saponification value:	193 - 202
INS Factor:	123 - 132
Concentration of insaponifiable:	0,1 - 1%
Concentration of indicated alkaline solution for saponification:	8 to 15 °Be;

**The soda soap is white, hard and presents a fine and compact structure. Well soluble in water, it produces quickly an abundant stable foam, has a good washing power and produces a smooth effect on the skin.**

#### **Preparation of soap**

##### **Pre-treatment**

**If necessary, washing in boiling water can be used as method of purification of fat (pork).**

## Saponification

**The soapmaking characteristics of fat are similar to those of tallow. As such, saponification should be done with light alkaline solutions.**

**The semi-hot process is well indicated as a technique of saponification.**

### Recipe:

**100 Kg of purified fat;**

**68,80 Kg of caustic soda at 8 °Be;**

**30,35 Kg of caustic soda solution at 35 °Be.**

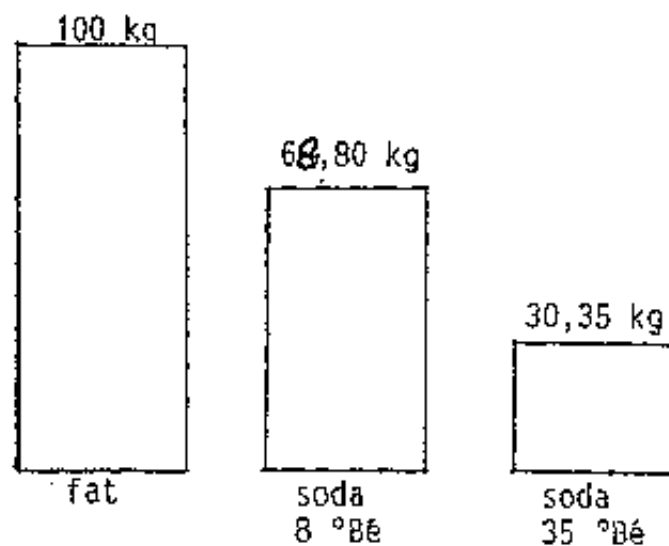

**Figure**

### How to conduct the operations:

- **Weigh the quantity of fat and heat it in the boiler at about 55 - 60 °C;**
- **Stop the heating and add slowly and in small proportions the low concentration alkaline solution by stirring well (appearance of an emulsion);**
- **Then add progressively the strong alkaline solution by stirring (increasing temperature shows good saponification process);**
- **Let the temperature decrease progressively down to 50 °C and add the secondary products;**
- **Pour the soap into moulds;**
- **Leave it become cold and hard;**
- **Take out of the moulds and cut the blocks into bars (and eventually into pieces).**

### **C.IX. Neem oil**

**It is extracted from neem seeds (*Azadirachta indica*), a very rustic and drought resistant tree. Neem is widespread in semi arid zones is used in many sahelians countries in reforestation programs The oil has a yellow-green color, a less pleasant scent and a bitter taste. It has medical and insect repellent qualities.**

#### **Physical and chemical characteristics:**

Density at 30 °C:	0,9143
Iodine number:	65 - 69
Saponification value:	196
INS Factor:	127 - 131
Concentration of insaponifiable:	2 - 2,5%

Concentration of appropriate alkaline solution for saponification: 26 to 45 °Be

**Soda soap is very hard, of dirty yellow color and of unpleasant odor. It produces quickly a great quantity of a stable foam, develops a good washing power and a smooth and antiseptic effect on the skin (sometimes used as medical soap).**

## **Preparation of soap**

### **Pre-treatment**

**Treatment with salted boiling water is the most simple method of purification of neem oil.**

**However due to its strong coloration and unpleasant odor the oil should be deeply refined before being saponified. The methods used to achieve this, such as: extraction with alcohol, treatment with alcohol alkaline solution, bleaching in chloride water are however somewhat complex in their implementation.**

**An easier alternative for production of good laundry soaps consists in practicing the graining out of formed soap. The coloring and scenting substances are then diluted in the water stage and are thus eliminated from the final product.**

### **Saponification**

**The hot process followed by the releasing is well indicated for production of improved soap from simply purified neem oil.**

### **Recipe:**

**100 Kg of purified neem oil;**  
**50 Kg of caustic soda solution at 30 °Be;**  
**10 Kg of salt.**

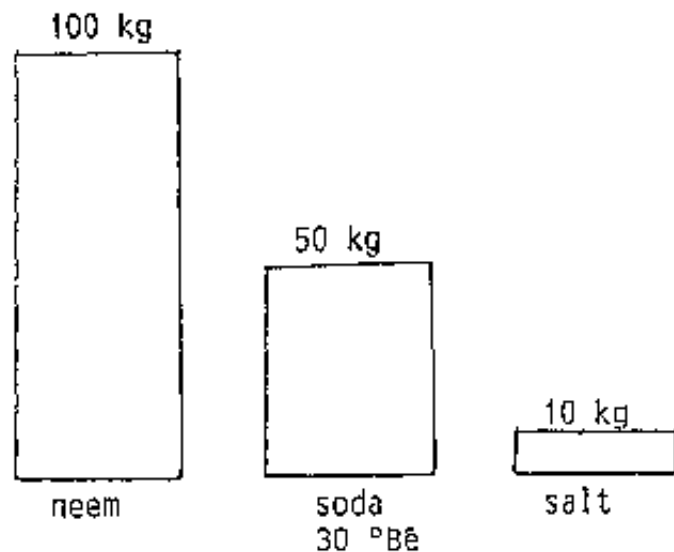

**Figure**

## How to conduct the operations

- Weigh the quantity of purified oil and heat it in the boiler up to 60 - 70 °C;
- Add slowly and in small portion the quantity of alkaline solution by stirring (continues heating without interruption);
- After adding all the alkaline, you heat the mass up to ebullition and keep this status up for a few hours (4 hours);
- Then grain out by mixing in the 10 Kg of salt precedently humidified (the initial mass builds then two (2) phases: the inferior liquid phase composed of water and glycerine containing the main scent and color substances);
- Eliminate water and melt again the soap;

- Then add the secondary substances by stirring and pour the hot masses into moulds;
- When it gets cold and hard, take out of the moulds and cut into bars or pieces.

## C.X. Pourghere oil

Extracted from physic nut (*Jatropha curcas*, L), a rustic tree, widespread in the inter-tropical regions, it is a non edible oil with marked purgative qualities.

### Physical and chemical characteristics:

Density at 15 °C:	0,920
Solidification point:	-13 to +5 °C
Iodine number:	95 - 110
Saponification value:	185 - 210
INS Factor:	75 - 115
Concentration of appropriate alkaline solution for saponification:	15 to 45 °Be

**The soda soap is white and soft. It quickly produces an abundant and stable foam, possesses a good cleaning power, and develops a smooth effect on the skin.**

## Preparation of soap

### Pre-treatment

**Pourghere oil presents neither a strong coloration nor a marked unpleasant odor, its pretreatment for soapmaking can be limited to simple purification (washing in**



**salted boiling water).**

## **Saponification**

**Traditionally the saponification of pourghere oil is carried out with a potassium alkaline solution extracted from plant ashes.**

**For production of improved soap, the semi-hot process is well indicated.**

### **Recipe:**

**100 Kg of purified pourghere oil;  
13,90 Kg of caustic soda solution at 15 °Be;  
36 Kg of caustic soda solution at 40 °Be;  
5 Kg of finely sprayed kaolin.**

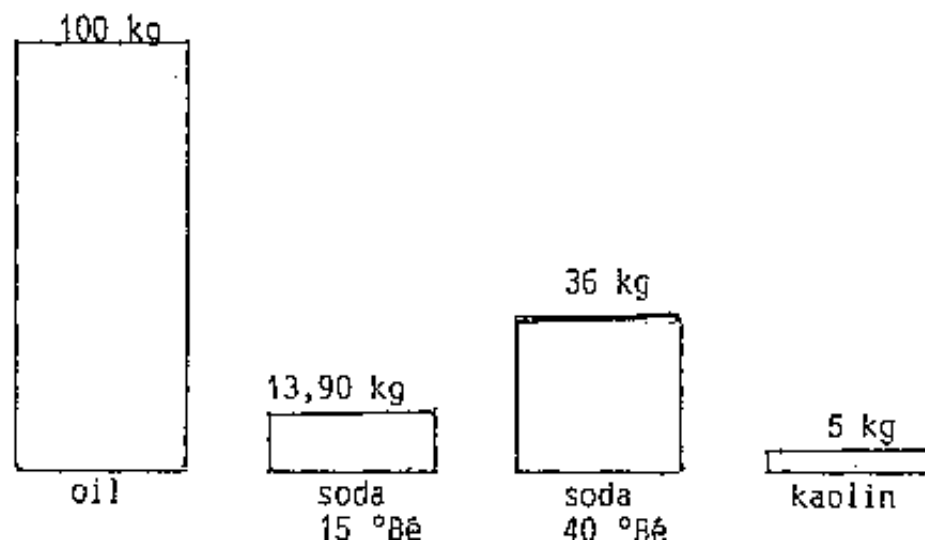

**Figure**

## How to conduct the operations:

- Weigh the quantity of purified oil and heat it in the boiler at 55 - 60 °C;
- Stop the heating and slowly add, in small portions, the low concentration alkaline solution by stirring;
- When an emulsion appears, add progressively (by stirring) the strong alkaline solution (the temperature of the mixture increases strongly and indicates a good achievement of the saponification);
- Let the temperature decrease down to 55 °C and mix in the kaolin (then eventually the color and the scent);
- Pour into moulds and let it get cold and hard;
- Take out of moulds and cut into bars and pieces.

## C.XI. Castor oil

**It is extracted from the seeds of castor plant (*Ricinus communis* L).**

### Physical and chemical characteristics

Density at 15 °C:	0,959 - 0,967
Solidification point:	- 10 to 12 °C
Iodine number:	82 - 90
Saponification value:	177 - 187
INS factor:	87 - 105
Intake of alkaline solution appropriate for saponification:	26 to 40 °gre.

**The soda soap is very hard and of white color. It is easily soluble in water, foams**

**little, possesses however a quite good cleaning power and has a smooth effect on the skin.**

## **Soap preparation**

**The soap making properties of castor oil is similar to those of copra oil. So saponification is thus easy to achieve at cold status with strong alkaline solutions (caustic soda for instance).**

## **Pre-treatment**

**Washing in boiling water can be used as simple purification method. The purified oil is uncolored or light yellow.**

## **Saponification**

**Castor oil is easily saponified and well adapted to the cold process**

## **Recipe:**

**100 Kg of purified oil;  
30,10 Kg of caustic potassium solution at 26 °gre;  
22,30 Kg of caustic soda solution at 40 ° gre;  
10 Kg of salt.**

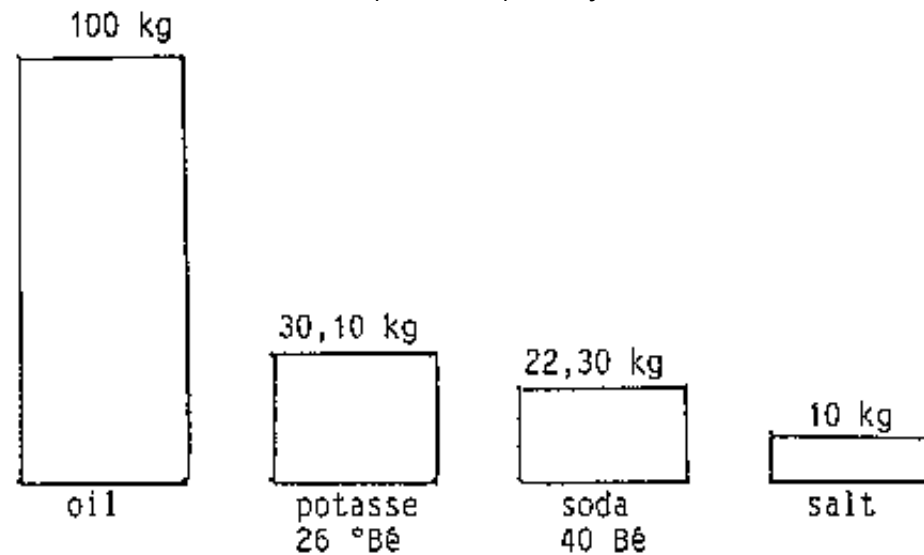

**Figure**

## How to conduct the operations

- Weigh the quantity of purified oil and heat at 35 - 40 °C in the boiler;
- Stop the heating and add slowly and in small portions the alkaline solution of weak concentration;
- After an emulsion is formed, add the strong alkaline solution until the mass gets an adequate stickiness;
- Then pour the hot mass into big moulds, close up (in order to provoke the auto-heating of the mass through the saponification reaction);
- When the blocks get cold and hard, take them out of the moulds and cut into bars and pieces.

## C.XII. Sesame oil

**It is extracted from sesame (*Sesamum indicum*) seeds. As high quality edible oil,**

**it is less used for soap making.**

## **Physical-chemical characteristics**

Density at 15 °C:	0,921 - 0,926
Solidification point:	- 6 to - 3 °C
Iodine number:	103 - 118
Saponification value:	187 - 193
INS Factor:	69 - 90
Intake of alkaline solution appropriate for saponification:	12 to 15 °gre.

**The soda soap is soft and of reddish to brown color. Well soluble in water, it produces a lot of foam and has a good cleaning power. It develops a smooth effect on the skin.**

## **Preparation of soap**

### **Pre-treatment**

**Sesame oil produced by hot pressing has a dark color and its usage for soap-making needs a pre-treatment.**

**To achieve this you wash it repeatedly in salted boiling water (refer to the detailed description of the process in the chapter peanut oil).**

### **Saponification**

**The semi-hot process of saponification is indicated for sesame oil.**

## Recipe:

**100 Kg of purified oil;**  
**42,42 Kg of caustic soda solution at 12 °gre;**  
**29,12 Kg of finely sprayed kaolin.**

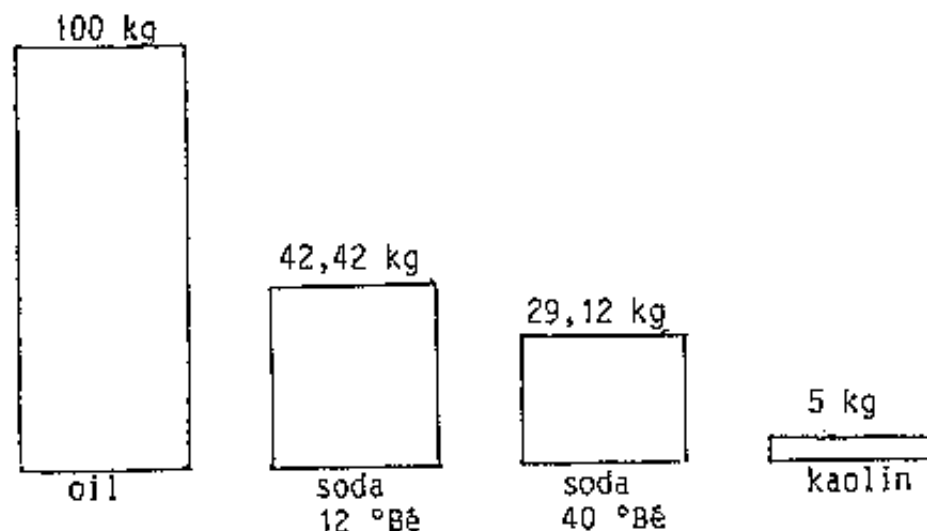

**Figure**

## How to conduct the operations:

- Weigh the necessary quantity of purified oil and heat it in the boiler up to 55 - 60 °C;
- Stop heating and add the quantity of weak concentrated alkaline solution in small portions by stirring;
- When an emulsion appears, add the high concentrated alkaline solution by stirring (the temperature increases progressively, which indicates a good achievement of the reaction);





- Leave it till the temperature decrease down to about 55-60 °C and add eventual auxiliaries
- Pour the hot mass into moulds and let it get cold and hard;
- Take the blocks out of the moulds and cut into bars and pieces.



[Home](#) > [ar.cn.de.en.es.fr.id.it.ph.po.ru.sw](#)



 **How to Make? An Improved Soap .. Not just for more Foam (GTZ, 1993, 71 p.)**

- ➔  **D. Saponification of fat mixtures**
  -  **D.I. General informations**
  -  **D.II. Equatorial zone**
  -  **D.III. Humid tropical zone**
  -  **D.IV. Semiarid tropical zone**

**How to Make? An Improved Soap .. Not just for more Foam (GTZ, 1993, 71 p.)**

**D. Saponification of fat mixtures**

**D.I. General informations**

**Soap-making fats have very different physical and chemical properties and this is**

**reflected on the quality and characteristics of the soaps they generate. By practicing composition of fat mixtures, the soap maker has the opportunity to manufacture soaps with various qualities for usage.**

**A soap used for instance for washing should be mainly composed of fats (at least 3/4 of the weight of the mixture) which soaps have good to very good cleaning properties.**

**Soap used for body hygiene on the contrary should mainly contain fat which develop a smooth to very smooth effect on the skin.**

**To make consistency soaps, you should use caustic soda solutions and choose as main components (at least 2/3 of the weight) of the mixture fat which produce hard to very hard soaps (refer to table II for details).**

**In practicing the various recipes, the soap maker may be limited i.e. by the availability of fats in his ecological zone and also by the cost.**

**In the upcoming lines, we propose recipes based on the locally available fats for each of the 3 main ecological zones of developing countries.**

**As soap-making techniques, the cold and semi-hot process are chosen due to their simplicity and also to the weakness of the energetic needs for their implementation.**

## **D.II. Equatorial zone**

**The main soap making fats available in this zone are: copra, palm, palmist oils as**



**well as pork fat. The first three fats are very easy to saponify even at cold, while the saponification of pork fat as such requires some cleverness.**

**For soaps used for body hygiene, the mixture of fat bodies should contain mainly palmoil and/or pork fat due to the smooth effect their soaps have on the skin.**

**For the cold process of soap making, some proportion of copra or palmist oil in the mixture is however indicated in order to ensure a quick starting of the cold saponification**

### **D.II.1. Cold process**

<b>Recipes (kg)</b>				
	<b>A</b>	<b>B</b>	<b>C</b>	<b>D</b>
Copra	-	10	-	-
Palmist	10	-	30	-
Palm	90	50	70	60
(Pork) fat	-	40	-	40
Caustic potassium at 15 °Be	-	19	53,90	-
Caustic soda at 35 °Be	50,70	-	-	49
Caustic soda at 40 °Be	-	36,6	28,70	-
Salt	-	-	5	-
Kaolin	5	-	-	-
Colors & scents	-	0,1	-	0,1
TNS Factor of fats mixture	157	151	174	141



- **Pour the hot mass into big moulds;**
- **Close well the moulds in order to keep in the heat of the reaction;**
- **After the blocks get cold and hard, take them out of the moulds and cut them into bars and (eventually into pieces).**

### D.II.2. Semi-hot process

<b>Recipes (Kg)</b>				
	<b>A</b>	<b>B</b>	<b>C</b>	<b>D</b>
Copra oil	-			
Palmist oil	10	-	20	-
Palm oil	90	80	80	50
Fat	-	20	-	40
Beewax	-	-	5	-
Caustic potassium at 15 °Be	-	-	35,90	18,60
Caustic soda at 15 °Be	46	-	-	-
Caustic soda at 35 °Be	-	49,50	-	-
Caustic soda at 40 °Be	28,70	-	32,70	36,60
Water	-	5	-	-
Filling material	5	-	5	-
Colors & scents	-	0,1	-	0,1
INS Factor of fat mixture	157	145	165	151

**The compositions A and D generate soaps used for washing while B and D produce soap to be used for body hygiene.**

## **Soap preparation**

**The fats for the composition of the mixture should be pre-treated. The simple techniques appropriate for this are described in each category of fat raw materials. Particularly palm oil should be bleached.**

### **How to conduct the operations:**

- Weigh the quantities of purified fats;**
- Put then into the boiler and heat at 55 - 60 °C;**
- Stop heating and add the alkaline solution in small portions by stirring (start with the weak alkaline solution);**
- Stir from time to time (the temperature increases progressively up to a maximum and then starts to decrease);**
- Let the temperature decrease down to 55 - 60 °C;**
- Add the secondary products (additives, color and scent) by stirring well for their incorporation;**
- Pour the hot mass into moulds;**
- Let it become cold and hard;**
- Take the blocks out of the moulds and cut into bars (and eventually into pieces).**

## **D.III. Humid tropical zone**

**It is the ecological zone presenting the widest range of fats for saponification.**

**Among them you can find those of animal origin such pork fat and tallows and those from cultivated plants such as cotton, peanut, physic nut and castor oils and those produced from wild plant fruits such as palm and Manan (Lophira lanceclota) oil and shea (karitea) butter.**

**All these fats produce good laundry soaps. For toilet soaps, the choice should be oriented towards the following fats: peanut, palm oils, karitea butter and pork fat.**

**However castor plant and palm oils are the only ones which are easily adapted to cold saponification. Preparation recipes according to that techniques should be composed of high proportions of one or the other of these two fats.**

### **D.III.1. Cold process**

<b>Recipes (Kg)</b>				
	<b>A</b>	<b>B</b>	<b>C</b>	<b>D</b>
Palm oil	40	40	20	-
Pourghere oil	-	-	50	20
Castor plant oil	60	40	30	40
Pork fat	-	20	-	40
Caustic soda at 35 °Be	-	47,70	47,70	47,70
Caustic soda at 40 °Be	38,70	-	-	-
Water	10	-	-	-
Filling material (salt)	5	-	5	-
Colors & scents	-	0,1	-	0,1

INS Factor of fat mixture	118	124	111	111
---------------------------	-----	-----	-----	-----

**The compositions A and C produce soap for the washing while B and D produce soaps used for body hygiene.**

## **Soap preparation**

**The pre-treatment of fats consists in the purification (and eventually bleaching). The usage techniques are those already precited.**

### **How to conduct the operations:**

- Weigh necessary quantities of purified fat and put them into the boiler;**
- Heat slightly up to 40°C, mix and make sure that all components are melted;**
- Stop the heating and add under stirring the weak alkaline solution by portions;**
- Go on stirring until the appearance of high slickness of the mass;**
- Add the secondary products (additives, color and scent) by mixing to ensure a good incorporation of all products;**
- Pour the mass into big moulds;**
- Close well the moulds for a good conservation of the heat from the reaction;**
- When the blocks get cold and hard take them out of the moulds and cut into bars (and eventually into pieces).**

## **D.III.2 Semi-hot process**

<b>Recipes (Kg)</b>						
	<b>A</b>	<b>B</b>	<b>C</b>	<b>D</b>	<b>E</b>	<b>F</b>
Peanut oil	-	50	-	-	-	-
Cotton oil	20	-	-	-	30	-
Karitea (Shea) butter	50	-	50	30	40	30
Pork fat	-	20	-	-	-	20
Palm oil	-	30	-	40	30	50
Pourghere oil	30	-	25	-	-	-
Manan oil	-	-	25	-	-	-
Beef suet	-	-	-	30	-	-
Caustic soda at 15 °Be	27,50	28	34	-	28	-
Caustic soda at 35 °Be	-	-	-	48,40	-	48-50
Caustic soda at 40 °Be	31,40	31,60	29,12	-	31,60	-
Water	-	-	-	5	-	5
Filling material (salt)	-	-	5	-	-	-
Colors & scents -	-	0,1	-	00,1	-	0,1
INS Factor of fats mixture	125	118	119	145	121	1338

**A, C and E compositions are used to make laundry soaps**  
**B, D and F give soaps for body hygiene**

### **Soap preparation**

**Karitea (shea) butter, pourghere, palm, cotton and peanut oils, pork fat and tallow constitute the main fats appropriate for semi-hot saponification.**

**Cotton and palm oils should be treated (bleached) before being incorporated into the fat mixture. The bleaching of palm oil is done by thermic treatment while cotton oil is bleached by treatment with alkaline (see the point on the saponification of this fat for technical details).**

**Karitea butter should also be deodorized. A prolonged cooking with 50% of the fat volume of water is efficient in this purpose.**

**For other above-mentioned fat the washing in salted boiling water is the simplest method for purification.**

**You must however notice in this scope that raw pourghere oil develops sometimes a great tendency to form stable emulsions which phase separation can require 48 hours.**

**In some cases, depending from the used extraction technique, filtering may enough for purification.**

**How to conduct the operations:**

- Weigh the quantities of purified fat and heat in the boiler at about 55 - 60 °C;**
- Stop the heating and add the alkaline solution in small portions by stirring (eventually start with light intake alkaline solution);**
- Go on stirring for a few minutes (the temperature starts increasing);**



- **Stir from time to time until the temperature of the mass gets to a maximum;**
- **Let the temperature get down to 55 - 60 °C and add the secondary products (additives, colors and scent) and mix well for good incorporation;**
- **Pour the mass which is still hot into moulds, let it get cold and hard;**
- **Take the blocks out of the moulds and cut into bars (eventually into pieces).**

#### **D.IV. Semiarid tropical zone**

**The range of fats used for soap making is very limited in this ecological zone. The neem and peanut oils and tallows scow, mutton) and eventually milk butter constitute the main available fats. Neem oil produces bad odor soaps which however have very good cleaning qualities.**

**Considering their properties, these fats are not well appropriate for saponification by cold process.**

**However in some sahelian zones, a traditional technique of saponification at cold is used: the cold saponification of the powder from kernel of *Balanites aegyptiaca*.**

**The process consists in:**

- **well mixing in a wide opening container the powder of kernel and a strong alkali (caustic potassium or soda) in a ratio of 15 to 20 volumes of powder for 1 volume of alkali;**
- **Pour progressively on the mixture an equal volume of boiling water by stirring;**

**- Let it then become cold and hard.**

### **D.IV.1. Semi-hot Process**

<b>Recipe (Kg)</b>				
	<b>A</b>	<b>B</b>	<b>C</b>	<b>D</b>
Peanut	50	40	-	30
Neem	-	-	50	40
Tallow (mutton)	50	-	50	-
Tallow (cow)	-	60	-	30
Caustic soda at 15 °Be	37	388	39	39
Caustic soda at 40 °Be	28,70	288,70	28,70	28,70
Water	-	-	12,50	110
Salt	-	-	1,25	1
Filling material (kaolin)	2	-	-	-
Color & scent	-	0,1	-	0,1
INS Factor of fat mixture	126	132	142	126

**A and C are used for washing soaps.**

**B and C give toilet soaps.**

### **Soap preparation**

**The fats can be treated using the precedently mentioned methods.**

**For recipes containing neem oil (C and D) this should be saponified apart and the obtained soap grained out (for details refer to point about neem oil).**

**The excess lye contains bad odorous and colourous matters and impurities. It must be drained out.**

**The pure soap is then melted and mixed with other fat . The saponification is then started a new by addition of the necessary additional quantity of alkaline.**

**How to conduct the operations to prepare compositions A and B:**

- **Weigh the necessary quantities of purified fat and put them into the boiler;**
- **Stop heating and add the light alkaline solution in small portions by stirring;**
- **GO on stirring during a few minutes (the temperature starts increasing);**
- **stir from time to time until the temperature of the mass reaches a maximum;**
- **Let the temperature of the mass get down to 55 - 60 °C and add the secondary products (additives, color, scent) and mix well to get incorporation;**
- **Pour the mass which is still hot into moulds let it get cold and hard;**
- **Take the blocks out of the moulds and cut into bars (and eventually' pieces).**



**[Home](#)"" """"> [ar.cn.de.en.es.fr.id.it.ph.po.ru.sw](#)**



## **How to Make? An Improved Soap .. Not just for more Foam (GTZ, 1993, 71 p.)**

### **E. Economic aspects of the improved soap production**

 **(introduction...)**

 **E.I. Packaging and trading**

 **E.II. Profitability**

 **E.III. Financial analysis of the soap making (survey forms)**

## **How to Make? An Improved Soap .. Not just for more Foam (GTZ, 1993, 71 p.)**

### **E. Economic aspects of the improved soap production**

**The small-scale soap making in peri-urban areas is mainly practiced as an income generating activity.**

**In this case it should solve usual problems of post-production such as storage and trashing. Moreover the determination of cost for investment and production as well as a reasonable profit margin constitute the basis for an economic viability of this activity.**

**The above mentioned considerations as well as the socio-economic implications (at community level) of aid to the valorisation of locally oleaginous resources define the main macro-economic aspects of this technology.**

## **E.I. Packaging and trading**

**The stability at storing of produced soap is one of the key elements of the success of soap-making activity.**

**In fact the product should stand conservation without any damaging of its external aspect or in usage qualities, as well as at producer level as retailer level (whole sale, retail).**

**Quality damages that an improved soap can undergo during storage include the followings: rancidity, appearance of stains (oxidations) and of leaks (dehydration) or softness (rehydration), loss of scent etc.**

**Any principles to be observed for improving the stability at storage of produced soaps are:**

- Choose good quality of raw materials (the fat should not presents a tendency to become rancid, for example);**
- Do an efficient pre-treatment of the fats;**
- Saponify according to the semi-hot method;**
- Use alcali stable additives ;**
- Incorporate stabilizers like thiosulfate (to be incorporated at a rate of 0,25% of the mass of the soap for example).**

**For conditioning before packaging, the soap bars should be piled the one on the others in a manner that the air could circulate between them. In so doing, they dry up efficiently and a balance could be established between their water content and the hygrometry of the local environment. According to the climate, this process**

**may extend over one to four weeks (refer to chapter II.3.).**

**The packaging for transportation and trading can be made with cartons or soft woodboxes. According to consumers' convenience, the soap can be delivered under the form of bars or pieces.**

**For trading itself home level soap manufacturer should refer to the local (usually traditional) structures of trading for domestic products. He should set up a delivery on advance system for "important customers" retailers.**

## **E.II. Profitability**

**To determine the profitability of the saponification activity, the following elements should be considered:**

### **1. Expenses**

- Expenses incurred by raw materials (fats, alkaline, additives);**
  - Costs of energy and water;**
  - Salaries (i.e eventually social costs);**
  - Trading costs (packaging, transportation);**
  - Property costs;**
  - Paying off of material and equipment;**
  - Taxes and impositions (eventually).**
- Sum of total Expenses = (A)**

### **2. Receipts (accounting)**

- **Sale of soaps;**
  - **Sale of eventual empty packages (barrils);**
- Sum of total receipts = ( B )**

**3. Profit/Loss = ( B ) - ( A )**

**The form Financial Analysis of the operation gives a guideline for the determination of the main elements for calculation of the profitability.**

### **E.III. Financial analysis of the soap making (survey forms)**

#### **1. Expenses**

##### **1.1 Raw materials**

##### **1.1.1. Fats**

<b>Nature</b>	<b>Raw quantity purchased</b>	<b>Weight</b>	<b>Purchase Cost</b>
Purification of fats			
<b>Nature</b>	<b>Gross Weight</b>	<b>Weight after Purification</b>	<b>Net cost of one Purified Kg</b>

Quantities of used fats			
Costs			

### 1.1.2. Alkali

Nature	purchased quantity	Weight (Kg)	Price of One Kg
Production of mother alkaline solution			
Weight of	Quantity	Weight of	Cost of one Kg
Alkaline (kg)	Water (1)	mother solution	mother solution
Quantity of the mother solution:			
Cost of the mother solution :			

### 1.1.3. Secondary products (Auxiliaries)

Nature	Quantity	Unit Price	Total Cost

### 1.2 Energy and water costs "purification of fats, saponification)

Nature/ Source	Quantity used	Unit price	Total cost
----------------	---------------	------------	------------



of energy			
Wood	.....	.....	
Wood charcoal	.....	.....	
Turf	.....	.....	
Water	.....	.....	

### 1.3 Salary costs

Nber Hd	Price Hd	Cost

### 1.4. Trading costs

Nber packaging	Unit price	Unit cost
Costs of transportation		
Total cost of trading:		

**1.5. Property costs (rental costs or paying off of housing)**  
**= annual costs : number of production sessions/year**

### 1.6. Paying off of material and equipment

Nature	Life of occupancy	Costs of acquisition	Annual Procurement

Total annual procurement:			

## 1.7. Taxes and impositions According to regulations

## 2. Receipts

Nature of product		Quantity (Nber)	Unit price		Receipts
Soap.....	.....Bars	.....		.....	
			Or		
.....	.....Pieces	.....		.....	
Empty barrils	.....	.....		.....	
Total					

**Financial summary of the operation = total receipts - total expenses**



[Home](#) > [ar](#).[cn](#).[de](#).[en](#).[es](#).[fr](#).[id](#).[it](#).[ph](#).[po](#).[ru](#).[sw](#)

**How to Make? An Improved Soap .. Not just for more Foam (GTZ, 1993, 71 p.)**

**F. Ecological implications**

**F.I. Problems**



## F.II. Perspectives

**How to Make? An Improved Soap .. Not just for more Foam (GTZ, 1993, 71 p.)**

### F. Ecological implications

#### F.I. Problems

**The small-scale soap-making in peri-urban zones face as main ecological problems: energetic procurement and production of waste waters.**

##### F.I.1. Energetic aspects

**Purification of fat raw materials and saponification require heating. Generally wood and charcoal constitute the energy sources used for this.**

**Under this aspects, soaps making at small-scale level may thus greatly contribute to deforestation as well as the satisfaction of domestic energetic needs. The**

**heating energy needs are very different according to the used processing methods for preparation.**

**They are low by cold process, middle by semi-hot and great by hot processing with graining out. At small-scale level, processing according to this last method is not strictly necessary for production of an acceptable quality soap. So it should be avoided for energy savings effectiveness.**

### **F.I.2. Waste waters**

**Waste waters usually produced by small-scale soap making are the following:**

- Purification waters of fat;**
- Material cleaning waters;**
- Glycerol contained waste waters from graining out;**
- Waste waters from etheric oils distillation.**

### **F.I.3. Soap usage and environmental pollution**

**Soap usage for washing or domestic cleaning presents the advantage to be less harmful to the natural environment (surface waters for example) than the synthetic detergents. The latter contain generally great quantities of phosphates and stimulate an unilateral increase of alga. The phenomenon can seriously disturb natural balance in the environment (up to the deterioration of the waters due to lack in oxigene balance). On the over hand, soap is [eight inactivated and assimilated by the organisms in aquatic milieu.**

### **F.II. Perspectives**

**Considering the continuing sensibilisation to environment problems, the measures to minimize the impact of above mentioned implications should be taken into consideration before starting a small-scale soap-making business.**

**In this purpose measures for waste waters depollution and optimized use from energy sources may be done by planing. Installing a biogas plant in place of classical septic tanks could be for instance a great contribution. The produced biogas is usable as combustibile and can efficiently replace the wood or wood charcoal.**

**Moreover in some climate areas, where external temperatures and the number of yearly sunny days are bright, efforts of research action are to be made for the design of a saponification method using sun as a source of energy. In fact the temperature of 35 - 55 °C necessary for the starting of saponification according to the cold and semi-ho/methods could be reached in appropriate boilers exposed to the sun rays in these zones.**

**Efforts of research-action for the mastering of such method and the achievement of a simple and efficient mixing system are well indicated.**

