

AT MICROFICHE
REFERENCE
LIBRARY

A project of Volunteers in Asia

Small-Scale Gold Mining

by E.H. Dahlberg

Published by:

Intermediate Technology Development Group (ITDG)

Available from:

Intermediate Technology Publications
9 King Street
London WC2E 8HN
ENGLAND

Reproduced by permission.

Reproduction of this microfiche document in any form is subject to the same restrictions as those of the original document.

SMALL-SCALE GOLD MINING

A manual based on experience
in Suriname

Dr. E. H. Dahlberg

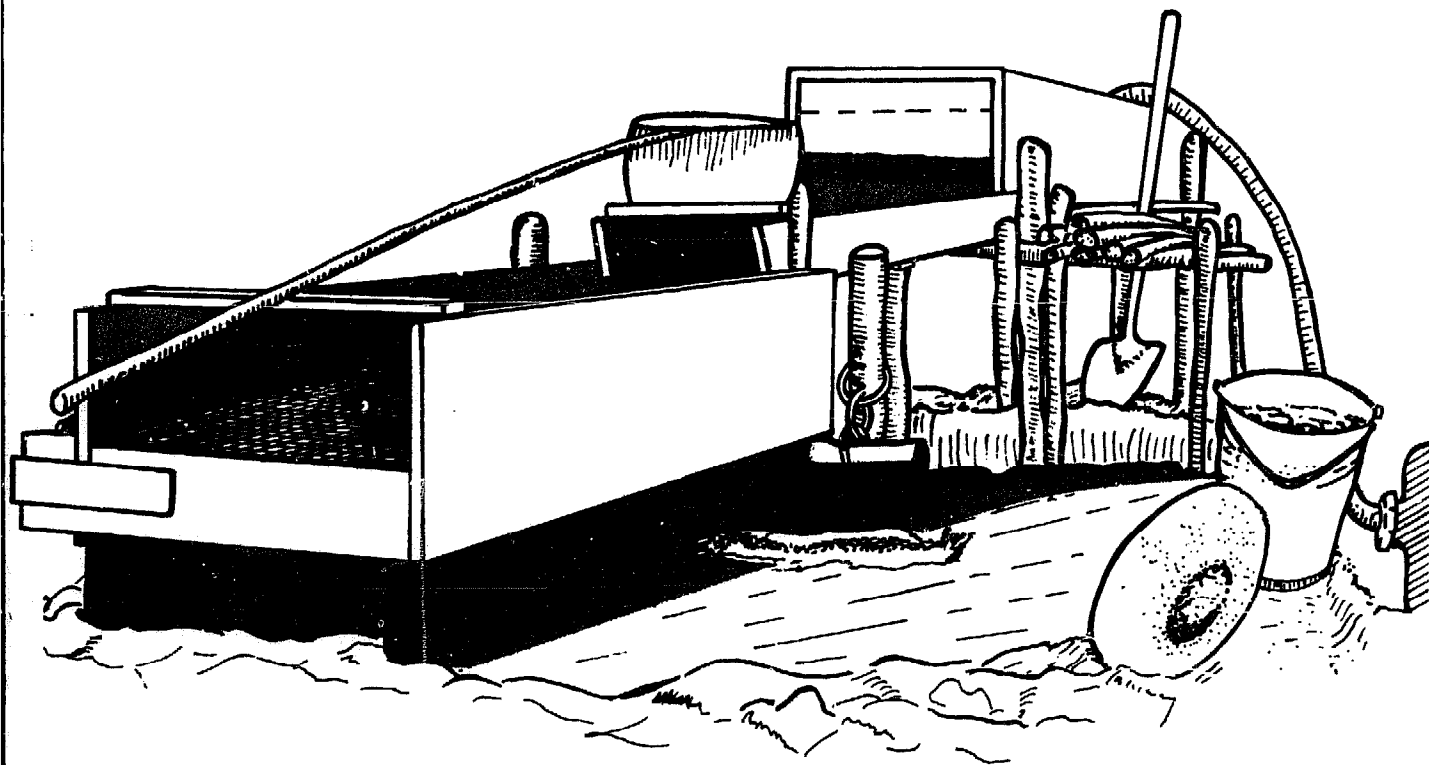

SMALL-SCALE GOLD MINING

A MANUAL BASED ON EXPERIENCE IN SURINAME

BY DR. E. H. DAHLBERG

Intermediate Technology Publications 1984

Intermediate Technology Development Group Limited
9 King Street
London
WC2E 8HN

© Intermediate Technology Publications Limited

This English edition has been published by arrangement with the Geologisch Mijnbouwkundige Dienst (Geological & Mining Service) of the Government of Suriname, and the translation and revisions have been sponsored by Intermediate Technology Industrial Services.

Printed by Steers Limited, Printers, Rugby.

FOREWORD

For some years now it has been the endeavour of the Intermediate Technology Development Group to assist small scale mining in the belief that it holds great potential for employment generation. This sector is relatively neglected by the technical development agencies, and it is very clear to us that improved, simple techniques for prospecting, mining and processing are a major priority for advancement.

When, therefore, the Manual of Gold Mining was sent to us from Suriname, we felt that the information it contained would be useful in many other countries.

Gold mining is one of the few operations that has continued to be successfully practised in spite of world recession and low metal prices. This has meant that it was taken up by many people with little knowledge of the techniques required and has sometimes led to inefficient and sub-economic efforts. It is the purpose of this manual to show firstly how systematic prospecting can ensure better grades and a longer life of the deposit and, secondly, how simple equipment, which can be made locally, can reduce the effort required and at the same time considerably improve the recovery of the gold. It deals only with alluvial operations but there are so many locations all over the world where this is the first introduction to mining activities, that we are certain that its simple, practical approach will make a fundamental contribution in many areas.

Several of the chapters, especially those dealing with mining regulations, are specific to Suriname, but we have not omitted them as it is always interesting to compare approaches in other countries. One of the methods described uses mercury and we have therefore added a chapter on mercury poisoning. We have also added a short list of references for those who wish to go deeper into any part of the subject.

Our thanks are due to Dr. E. H. Dahlberg for allowing us to translate and publish this volume.

ITDG, Rugby,
January, 1984

CONTENTS

Page

1.	Introduction	1
2.	Application for a Concession and Duties of the applicant	3
3.	Types of gold deposits in Suriname	5
4.	Exploration for Gold	12
4.1	Gold Concentrating Methods	12
4.2	Prospecting	27
4.3	Exploration	31
5.	Purity of gold	44
6.	Amalgamation of gold from mineral concentrates with mercury	44
7.	Treatment of poisoning	46
8.	References for further reading	49

1. INTRODUCTION

As a result of the increased price of gold, interest in gold mining in Suriname is growing once again. This development is encouraged by the GMD, because their primary function is to support mining activities. This manual was written for people who want to take up gold mining, and as such is part of the facilities provided by the GMD. The saying 'look before you leap' is more relevant here than in any other undertaking. Gold's lucrative character, interwoven with legendary stories of rich gold occurrences, has in the past resulted in many hasty mining ventures, doomed to failure.

The technical and commercial aspects must be very carefully thought through. In the following pages we shall try to acquaint the interested outsider with the nature of gold deposits and with factors which have to be borne in mind before starting out on a mining venture.

Suriname had a prosperous gold mining industry at the turn of the century on a large, medium and small scale. The collapse of that industry was caused by:

- the exhaustion of easily exploitable areas and a lack of prospecting and exploration activities to establish further reserves.
- lack of management expertise resulting in unsound mining plans and purchases of unsuitable equipment.
- the waste during mining of gold occurring in the form of fine particles resulting in substantial losses.
- poor control of selling of gold resulting in the formation of a black market and low prices for the producer.
- sub-leasing by the concession holder to small producers resulting in an unsatisfactory relationship.

- the freezing of the gold price on the world market.

This handbook will show, in logical order, the steps necessary to bring an economically exploitable gold deposit into production.

2. APPLICATION FOR A CONCESSION AND DUTIES OF THE APPLICANT

The G.M.D. (Geological and Mining Service)

Before embarking on an investigation it would be advisable to contact the head of the GMD to obtain information on the following:-

- (a) a list of areas which are open to prospecting
- (b) a list of areas which are likely to be promising from a geological and mining point of view.

Regarding (a) the GMD can issue a map which shows all existing concessions and their expiry dates as well as areas which have been reserved by the government and which may not be traversed by concession holders.

Regarding (b) the following criteria will apply:-

- the possibility of gold occurrence based on geological data
- the possible occurrence of gold based on verbal or written information
- occurrence of gold established by prospecting
- reserves of gold established by exploration

The annual cost of an exploration licence is 1 cent per hectare and for exploitation 10 cents per hectare.* The Mining Regulations limit the maximum size of concessions to 20,000 hectares.

* 1 Suriname Guilder = 100 cents = £4.5 (approx.)

At the end of every 3 months the concessionaire has to present a report to the head of the GMD with the following details:-

- list of people employed and their addresses
- the salaries paid to them
- technical details giving the number of pits dug, the amount of ground moved, the weight of gold found, and other information in accordance with paragraphs 4.2.2 and 4.3.1 below.

The report must be accompanied by a map giving the pit and sample locations. It must also be pointed out that the gold found by an exploration licence holder is not his property, but must be handed over to the head of the GMD.

Office of Lands Administration

After consultation with the GMD one or more areas are chosen, and a decision is made to apply for licences. The procedure is set out in Government Pamphlet (GB) 1952 No. 28 and 29 of the Mining Regulations. It will be necessary to consult a chartered surveyor who will advise whether any particular area can be applied for. The surveyor or applicant then sends the application to the Office of Lands Administration (a department of the Ministry of Development) and approval usually follows in 6 to 7 weeks. Before this approval, the head of the GMD can, by letter, give permission for exploration to start. If the geological and mining information is satisfactory, then an exploitation licence can be applied for at the same time as the exploration licence. In the case of a navigable stream or river, it is recommended to apply immediately for an exploitation licence in view of the complicated aspects of exploration, and so that favourable results can immediately be followed by mining.

3. TYPES OF GOLD DEPOSITS IN SURINAME

Gold occurs in Suriname in the following ways:-

- A. As a primary deposit in crystalline rocks, also called bedrock. This gold occurs either in or in the immediate vicinity of quartz veins (reefs).
- B. As a secondary deposit in the vicinity of gold bearing eroded bedrock. These are called colluvial deposits.
- C. As a secondary deposit in recent and abandoned stream and river beds which drain the water from colluvial deposits. They are called alluvial, stream or river deposits and occur in the areas of large streams and rivers.

The deposits under B and C are also called placer deposits.

A - primary gold deposits

In Suriname these occur on a regional scale at contact zones of quartz diorite and metamorphic volcanic rock which form the matrix or bedrock, see Figs. 1 and 2. Gold occurs mainly in the immediate surroundings of the quartz veins and adjoining rock as shown in Figs. 3 and 4. The quartz veins can be milky white or grey to blue. The museum of the GMD has a manual illustrating the various rock formations.

B - secondary colluvial deposits

These deposits occur in the immediate vicinity of gold bearing bedrock, at the foot of the slope along the stream bed. They were formed by the disintegration and selective transport of the primary rock over short distances by gravity and flowing surface water. They consist mainly of yellow-brown to red-brown lumps of clay containing iron nuggets and sharp pieces of quartz, as shown on Fig. 5.

C - secondary alluvial deposits

These occur in recent or abandoned stream beds and adjoining terraces which drain areas where gold-containing bedrock and secondary colluvial deposits occur.

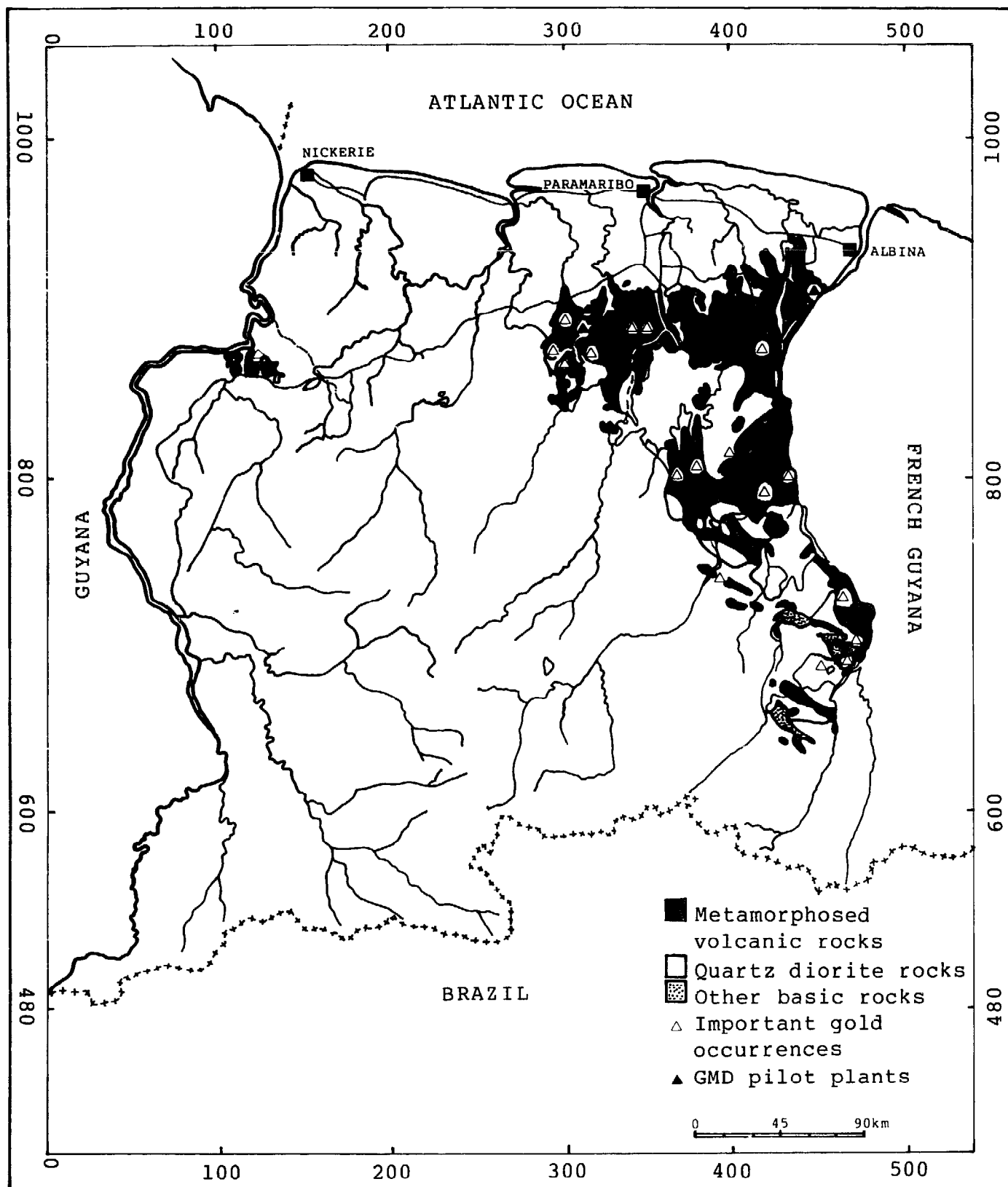

Fig. 1 Map of Suriname showing important gold occurrences and gold bearing formations

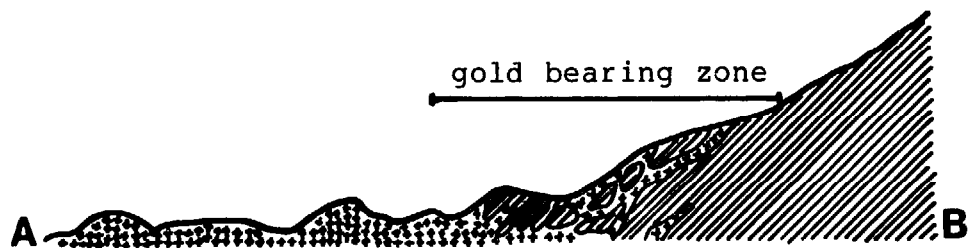
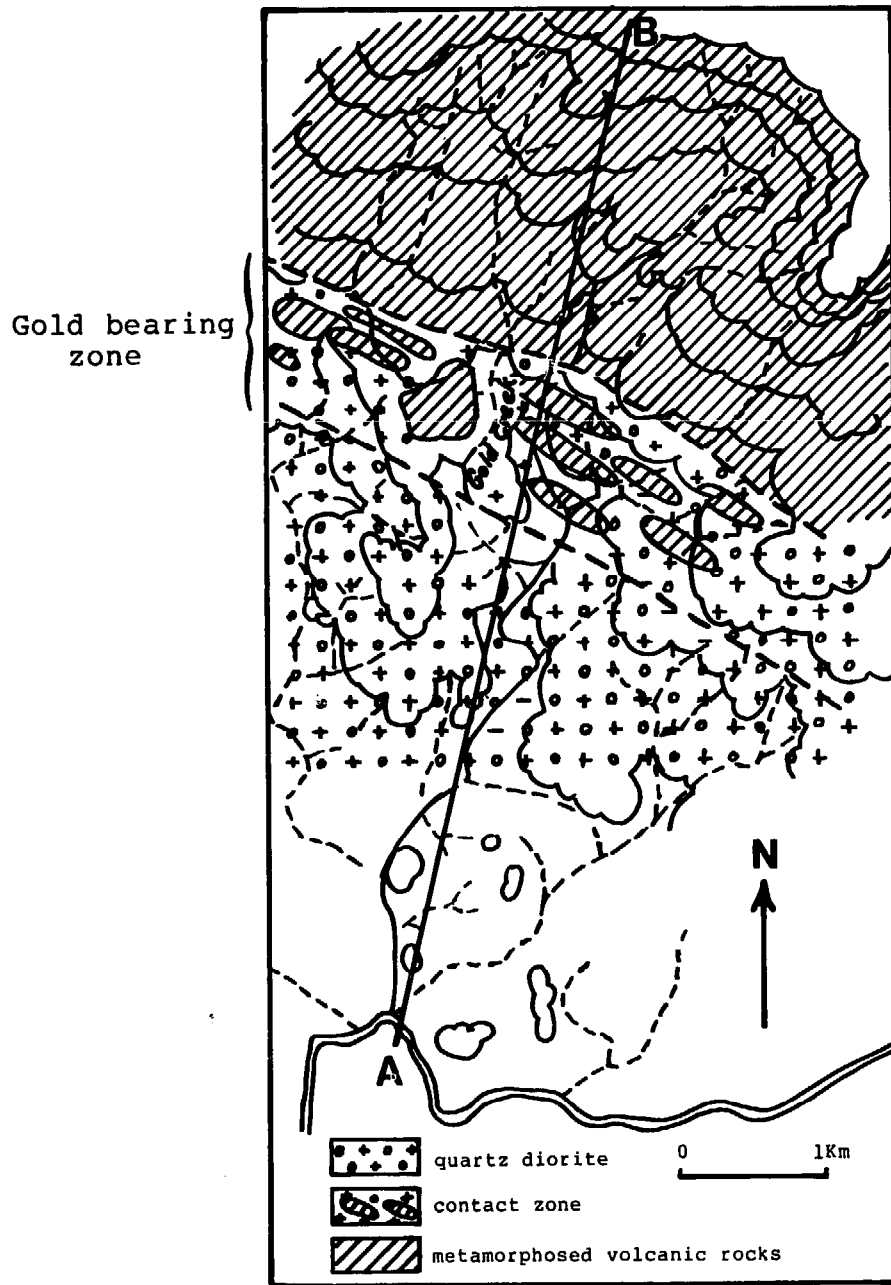

Fig. 2 Map and section with gold bearing contact zone between volcanic and dioritic rocks (According to Brinck, 1955)

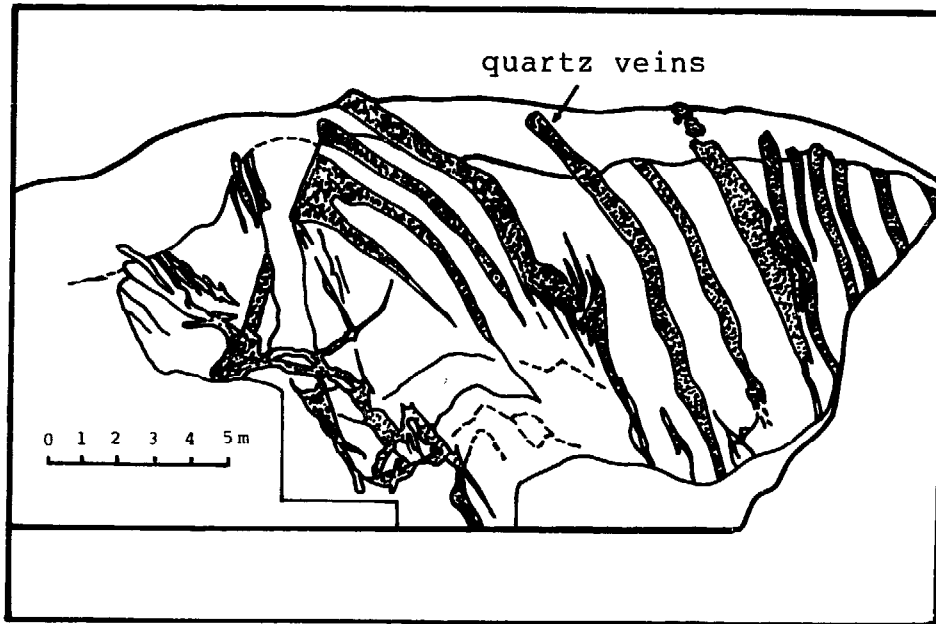

Fig. 3 Section with a series of quartz veins in weathered rock which can contain gold. Suitable for investigation with prospecting pits.

red-yellow weathered soil, sometimes with iron bands

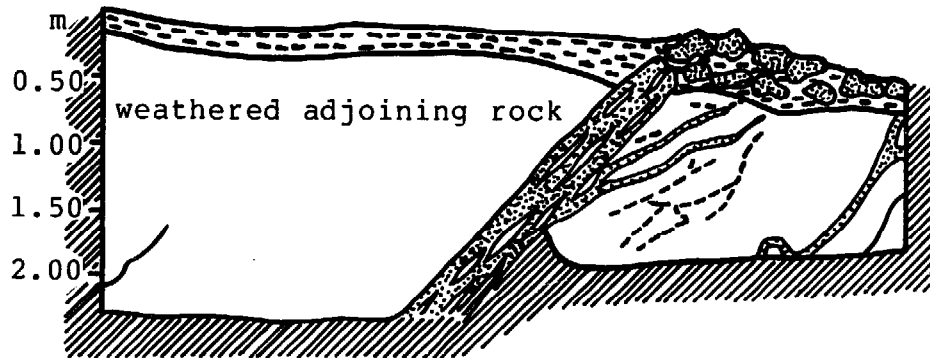

Fig. 4 Quartz veins which downhill become colluvial deposits with angular quartz fragments. The sections can be seen in prospecting pits.

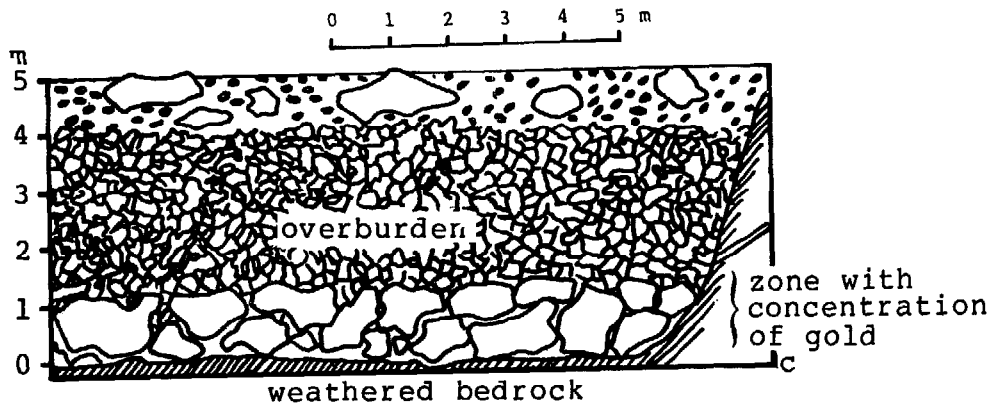
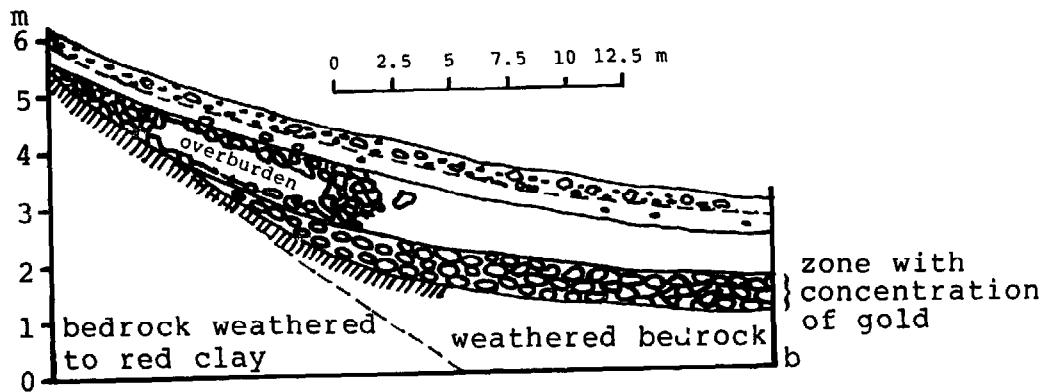
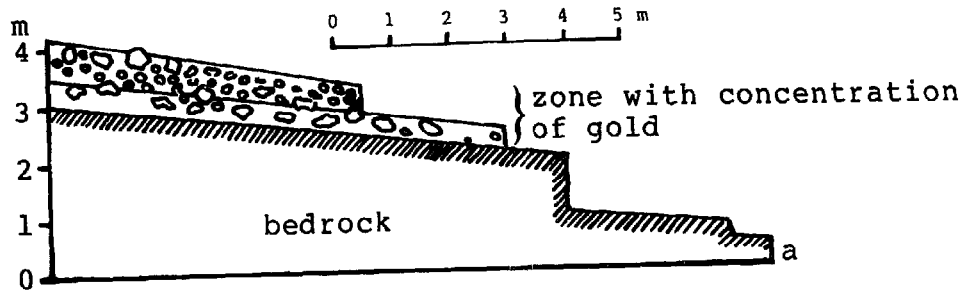

Fig. 5 Different types of gold bearing alluvial deposits (According to Brinck, 1955)

There are two types of alluvial deposits:-

- the older stream and river conglomerates which sometimes form terraces to depths of 80 metres above the stream bed, as shown in Fig. 6.
- the young gravel and sand deposits in recent streams and rivers as shown in Fig. 7.

The greatest gold concentrations are found at the base of the gravels and conglomerates and in the top 2cm of the underlying clay bedrock. If the bedrock is hard and not weathered then there can be gold enrichment in cracks, grooves, holes and other rough places of the river bottom.

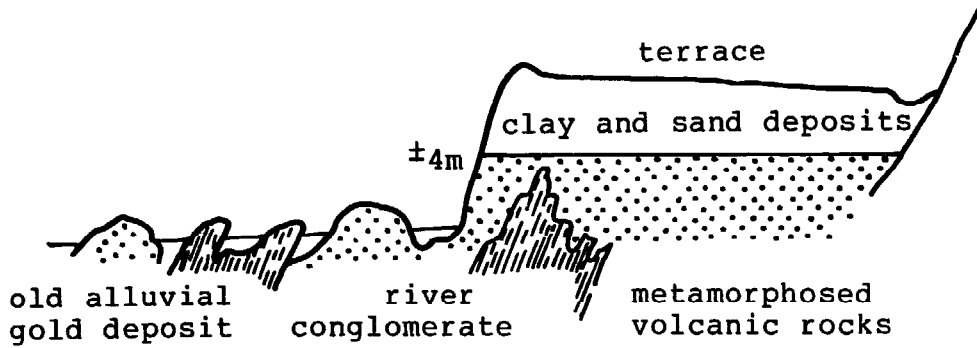

Fig. 6 River conglomerate forming a terrace as part of an old gold deposit (According to Brinck, 1955)

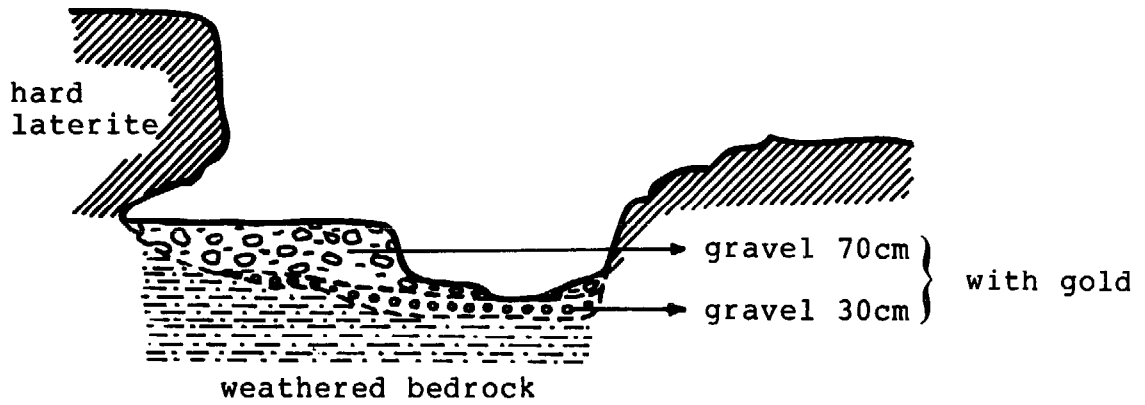

Fig. 7 Stream with young gold bearing deposit (According to Brinck, 1955)



Fig. 8 Concentration of material with a batea

4. EXPLORATION FOR GOLD

When searching for gold, there are two phases - prospecting and exploration. Before talking about the different prospecting and exploration methods the techniques and equipment which are used for the treatment of the ore and concentration of gold will be discussed.

4.1 Gold Concentrating Methods

As part of the support facilities for people who would like to undertake the mining of gold, the GMD has established facilities at Loksi Hati on the Saramacca river and at Jorka Creek on the Maroijne river where experienced GMD personnel give instructions in the various methods.

These consist of map reading, building of small camps, simple administration, digging of prospecting pits, de-sliming and various concentration techniques. In addition, instruction is given in the construction, maintenance and operation of the various types of equipment.

During the prospecting and exploration phase the students can also obtain advice from experienced prospectors and use some of the GMD facilities, such as mail services. Nominal costs are charged, depending on circumstances.

4.1.1 The Batea

The batea is a circular metal pan with a pointed bottom, similar to a Chinese hat, as shown in Fig. 8. Gold and heavy minerals are concentrated in the bottom of the pan, which is floated in slowly flowing water and is given a circular eccentric motion so that the light minerals spill over the edge into the river. Before starting the process it is necessary to remove all particles greater than 2.5cm in diameter and organic matter. The contents of a batea with a diameter of 45cm, such as used by the GMD, is 6 litres. An experienced man can treat 0.5m³ per day. Because of this low throughput only very rich deposits can be treated with a batea.

4.1.2 The Sluicebox

This piece of equipment has made the greatest contribution to the gold industry in Suriname and the rest of the world in the treatment of secondary alluvial and colluvial deposits. Its advantage is that it can handle greater quantities than the batea, so that deposits with lower gold contents can be treated. Another very important advantage is that finer gold particles can be recovered than with a batea. In a longtom operation the separation is achieved by a stream of water running in a launder in which slats are fitted to form riffles, so that the gold and heavy minerals are retained and the light minerals such as quartz are washed away. The construction is shown in Figs. 9, 10 and 11.

A sluicebox normally has a length of 2.5 to 3.5m and width of 15 to 100 cm. It has been found that two or three boxes in series will recover 90% of the mined gold (+1.5mm) of which 75% stays in the first box. If the gold is very fine then the recovery can be improved by placing more boxes in series, or by increasing considerably the width of the second box or by using an undercurrent. In paragraph 4.1.3 a description of the undercurrent is given. GMD uses a threefold installation as shown in Fig. 9. In the first part which is called the torpedo the clay lumps are broken up with a flat wooden implement which is moved from side to side whilst water is being added. A screen is fitted before the first sluicebox which allows only particles of less than 2.5cm to pass through. A 1cm screen is fitted before the second sluicebox. To retain the fine gold which passes the second sluicebox, the material flows through a final gold trap where a detergent such as liquid soap is added. A jute sack or fine coconut mat is fitted to the bottom of this box and this retains the fine gold.

In a two-man operation in which the material is shovelled into the longtom, care has to be taken to have available sufficient water to treat 2.3m³ during a 10 hour working day. In this case approximately 200 litres/minute of water (which cannot be re-cycled) is required. If the water cannot be fed by gravity then a 2 inch pump has to be used.

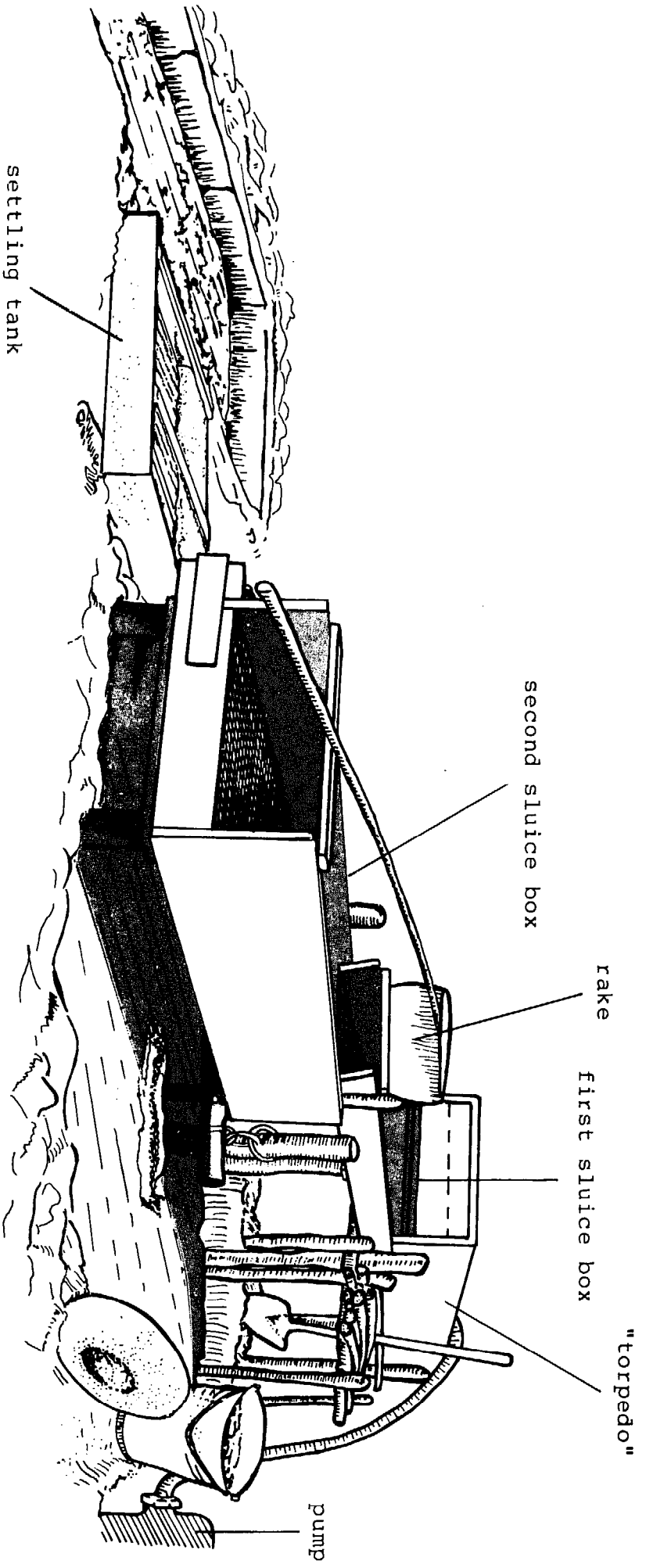
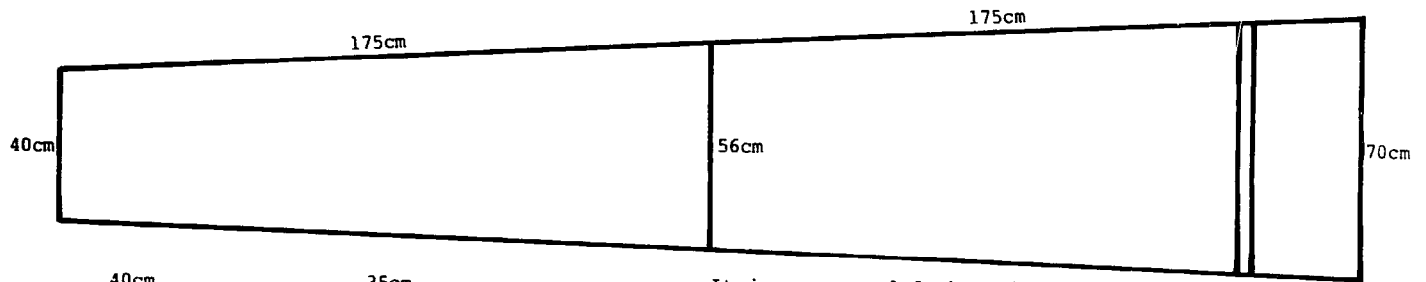
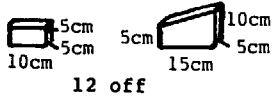
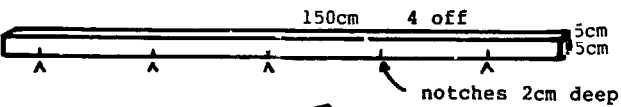
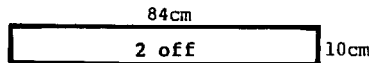
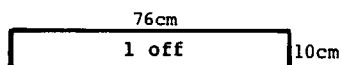
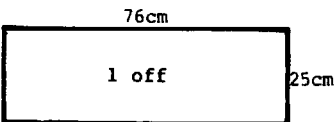
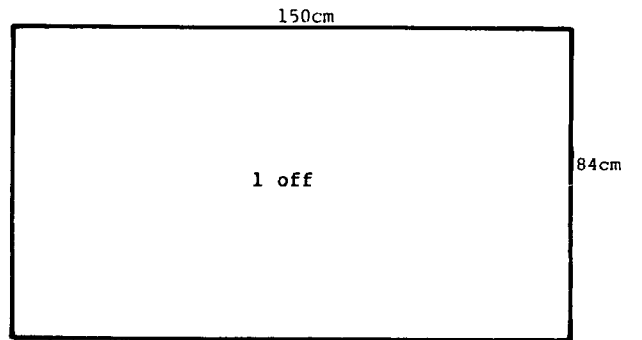
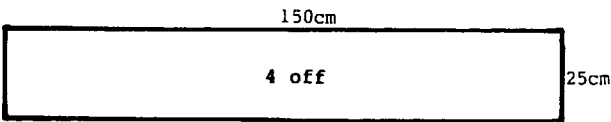
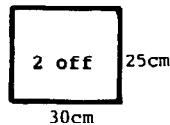
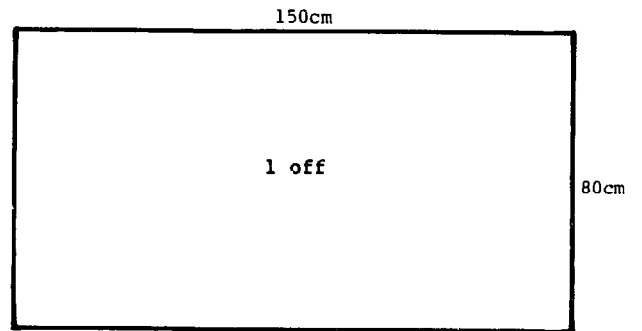
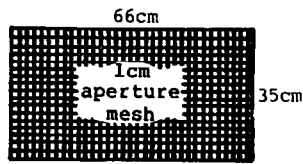
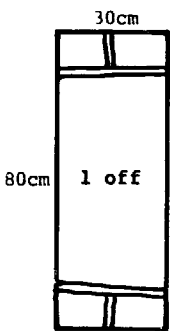
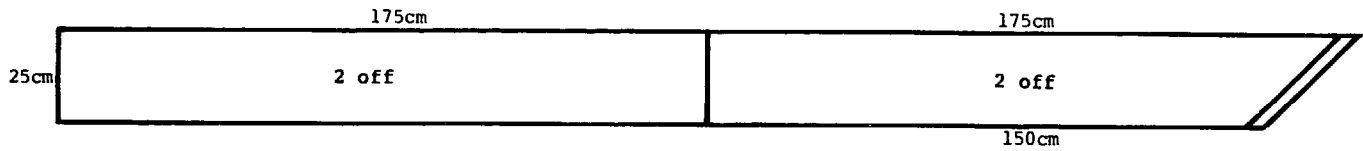
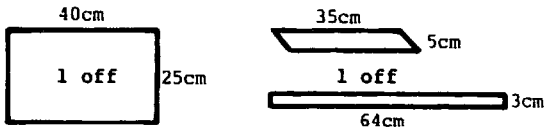

Fig. 9 Arrangement of sluiceway as used by GMD



It is recommended that the bottom be covered with an old piece of conveyor belting

board thickness 2cm



scale 1 : 200

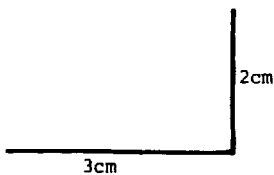

scale 1:1
aluminium strips
10 off

86cm long

mats or white jute bags 76x150cm
80x150cm

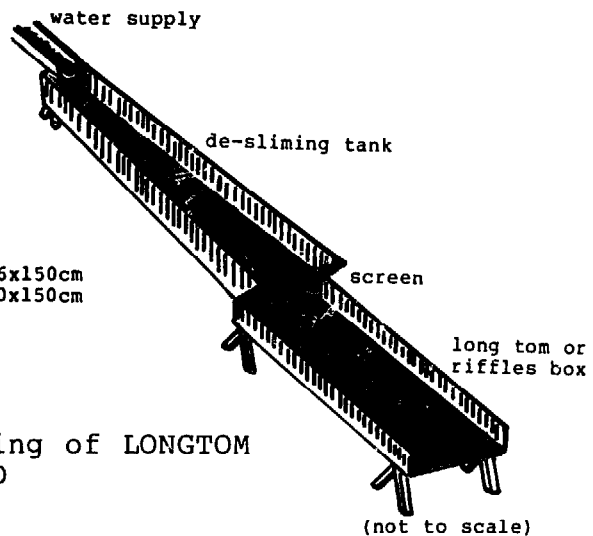

(not to scale)

Fig. 10 Construction drawing of LONGTOM as used by the GMD

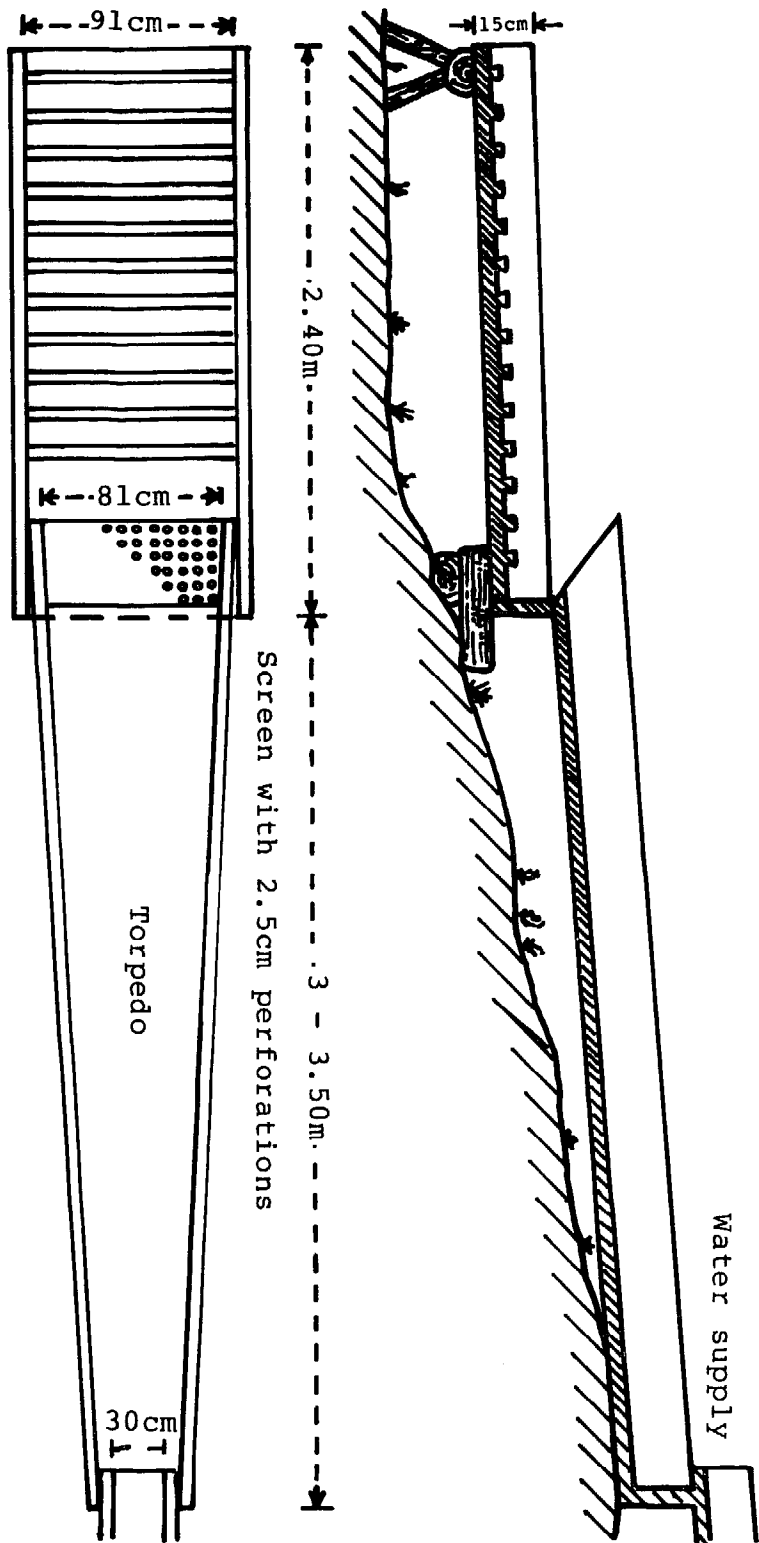

Fig. 11 Elevation and plan of the "Longtom"

The amount of water running in a stream can be estimated by throwing a piece of wood into it and measuring the distance moved in one minute. The average width and depth of the stream has to be measured and then the quantity of water flowing per minute equals $0.75 \times \text{depth} \times \text{width} \times \text{distance}$ travelled per minute.

Example:

Average width of stream	=	1.5m
Average depth	=	0.75m
Cross sectional area	=	1.125m ²

If the piece of wood travelled 10 metres in one minute then the quantity flowing is $0.75 \times 1.125 \times 10 = 8.44 \text{ m}^3/\text{min}$ (8440 l/min).

The slope of the sluicebox is very important and is usually about 4%, or 4cm/meter length. If the material contains a lot of clay, and the clay has to be broken up then the slope can be 6-8.5%.

It is very important to check that the clay has not formed small balls because gold can be caught up in these and will be washed out of the last sluice box.

If the riffles are filled with sand then the slope is too small, but if the gold is washed away then it is too big. The ideal slope will be found experimentally, and it is better to start with a slope which is too steep rather than with one which is not steep enough.

The heavy minerals containing the gold will have to be removed from the longtom at regular intervals. During prospecting and exploration this will have to take place after the treatment of each pit, but during exploitation the frequency depends on the heavy minerals content of the deposit. In the beginning it is important to clean up every two days, but later one should clean up as infrequently as possible, because it takes time and reduces productivity. When cleaning up, the tops of the riffles are first washed clean of gravel and sand, after which the flow of water is stopped. Then the riffles in the upper boxes have to be cleaned carefully with a hand duster to remove all the gold adhering to them. After that a stick of 2.5cm by 5cm is fitted across the outflow of the box and the water turned on just sufficiently to transport

the gold and heavy minerals. This is assisted by a flat wooden spoon with a V-shaped edge which is moved up and down at an angle of 45° with the bottom of the box (which has to be very smooth) so that the gold and heavier minerals are concentrated at the top end of the box and the other heavy minerals are washed away. Any remaining light minerals are removed by hand. The gold and heavy minerals are put into buckets for further concentration in a rocker or batea or sent to a central plant in heavy lockable drums for mechanical concentration. Concentrates from the lower boxes are treated in the same way as those from the top box. If mats are used, they are washed in suitable containers, and the contents are further concentrated.

4.1.3 The Undercurrent Box

The working principle of the undercurrent box is that the material, after removal of the coarser fractions, is spread out over a wider shallower stream, the slope of which is steeper, but the water addition reduced so that the fine gold is retained on coir mats, animal pelts, or corduroy materials. Alternatively, riffles are placed at right angles to the direction of the flow. The undercurrent box is placed at right angles to the sluice boxes as shown in Fig. 12. Between the sluiceboxes and the undercurrent box is a grizzly, 1.2m long and as wide as the box. The bars of the grizzly are 2.5cm wide and the gaps 0.5 to 1.25cm. The fine material passes through the grizzly into a distributing box and from there into the two parallel undercurrent boxes having a total width of 2.5 to 3m. The slope of the undercurrent boxes is relatively steep - 8 to 12.5% - whilst the distributing box is even steeper.

4.1.4 Ground Sluicing (Fig. 13)

This method is particularly suitable for the treatment of deposits which are 2 - 2.5m thick from which barren overburden has to be removed.

One condition is that the bedrock must have a slope of at least 4 degrees and that there is enough space for the tailings which remain after the treatment.

1000 to 2500 litres/minute of water is made to run in a stream through the deposit so that the overburden and the gravel are washed away, leaving behind the gold and heavy minerals in the irregularities of the bedrock.

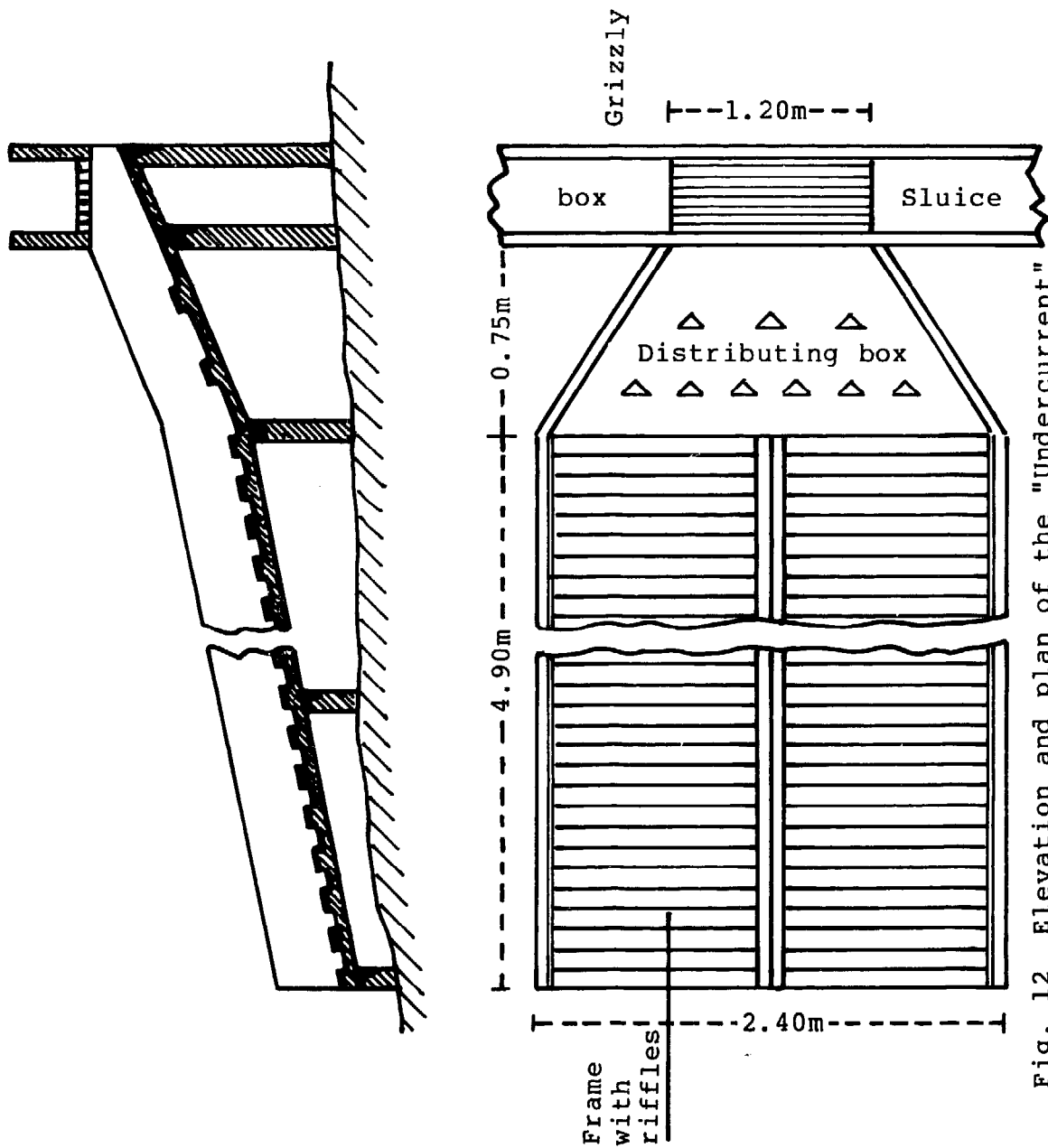

Fig. 12 Elevation and plan of the "Undercurrent"

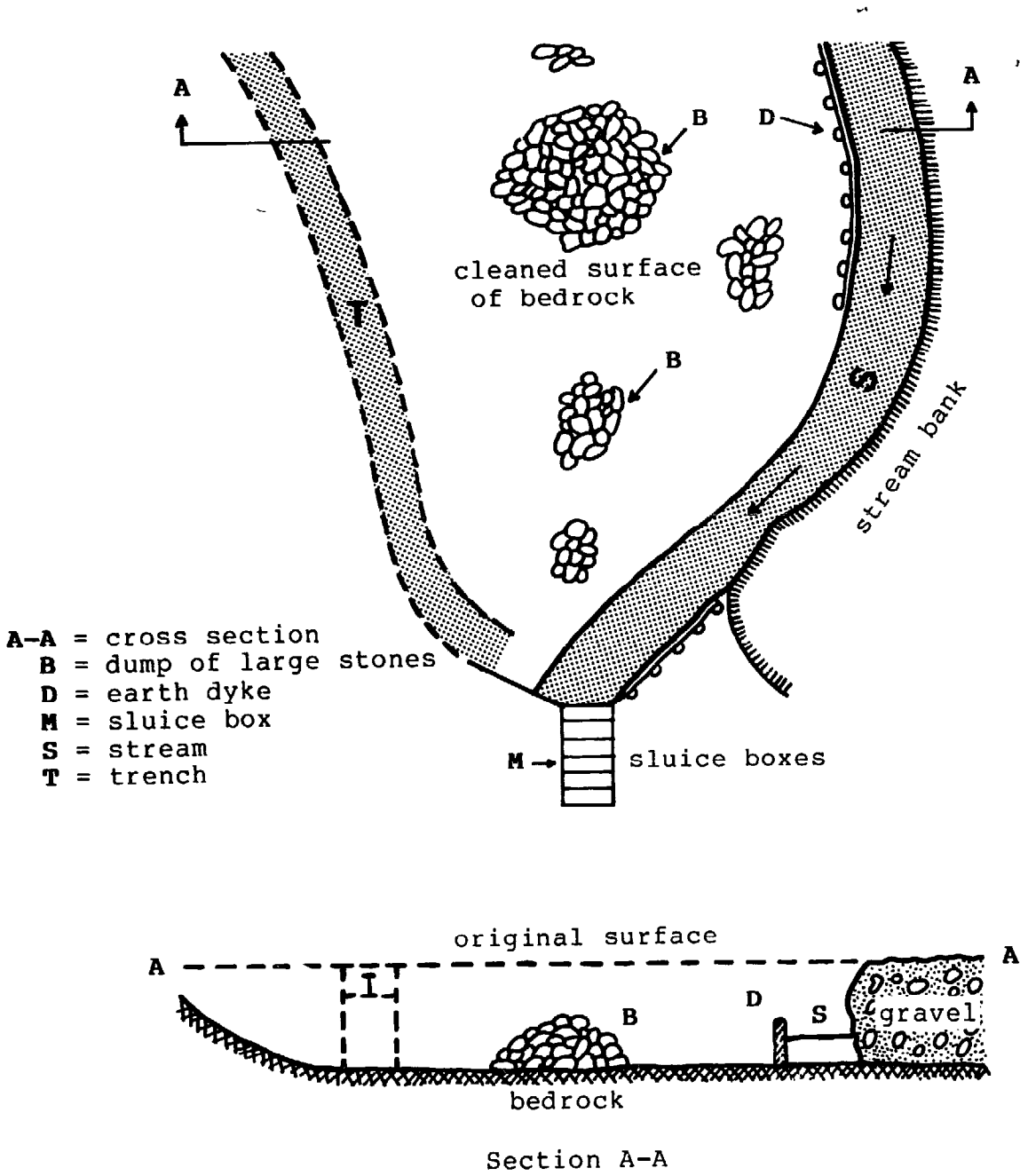

Fig. 13 Groundsluicing

4.1.5 The Rocker (Fig. 14)

This consists of a box in the form of a trough with riffles. The box is mounted on curved rocker bars. Above the box is a hopper with a screen on the underside to guide the material into the rocker. Under the rocker is a piece of cloth in which the fine gold is caught. The average size of a rocker is 1.37 to 1.52m wide by 0.61m long and 0.46m high. The wood of which it is made must be (as in the case of the sluicebox) a single piece free of knots and other irregularities, and must be completely flat. The difference in height between the front and back is 7.5cm. By swinging the rocker vigorously under a steady stream of water the gold is retained and the sand washed out. A rocker is best operated by two men who can handle 2 cubic meters in a 10 hour day. About 600 to 1100 litres of water are required, which can be recycled via a 200 litre container.

4.1.6 Suction Dredge (Fig. 15)

This is a modern dredging method whereby the gravel and gold are sucked up from the stream or river bottom, rather like a vacuum cleaner.

The transport medium is water. The installation consists of a raft, sluicebox, engine, pump and suction pipe with inlet. The diameter of the suction hose varies from 35 to 200mm diameter, throughput from 3 to 22.5 cubic metres/hour, the maximum dredging depth from 2 - 10m, the weight of the installation, 15 - 340 kg and the fuel consumption 0.83 to 0.34 litres per cubic meter. If the depth of water exceeds 1m the suction inlet is operated by a diver who can stay under water for several hours. In such cases, a compressor must also be provided. The heavy minerals containing the gold are retained by the riffles, periodically removed from the sluicebox and further concentrated in a batea, superpanner or jig. Because of the relatively high velocity with which the material passes through the sluicebox, care has to be taken when working deposits with a high content of fine gold not to lose some of the gold back into the river. It is possible to consider undercurrent installations and gold traps combined with heapleaching methods.

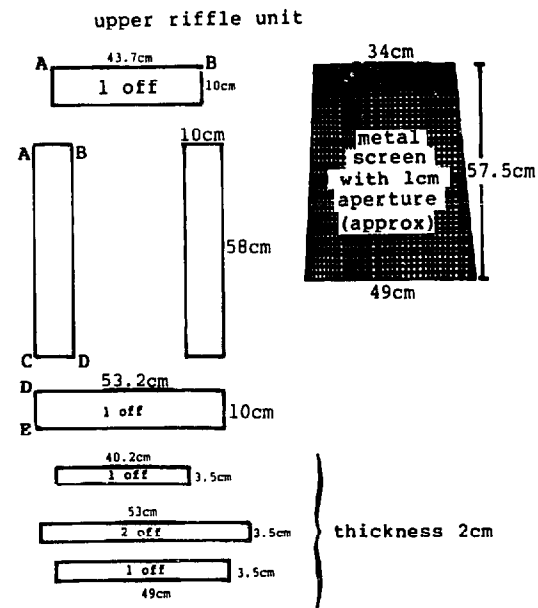
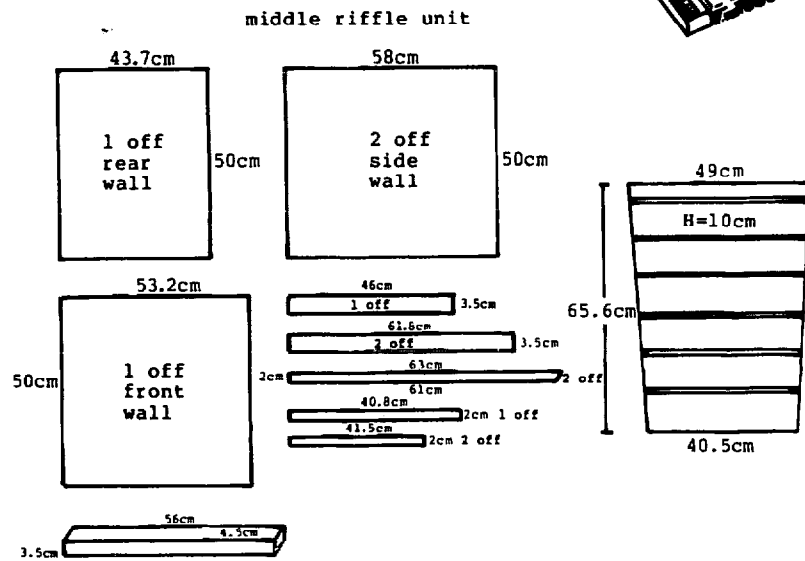
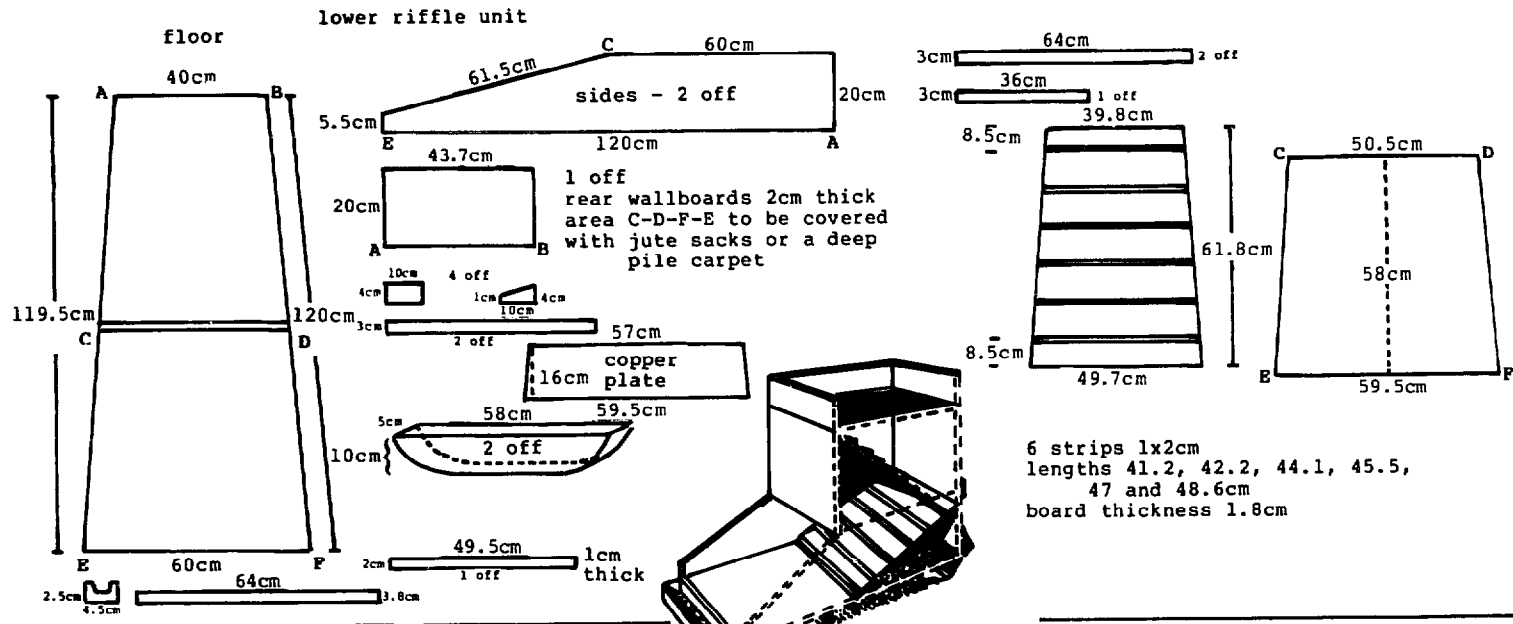

Fig. 14 Construction drawing of ROCKER in use by GMD

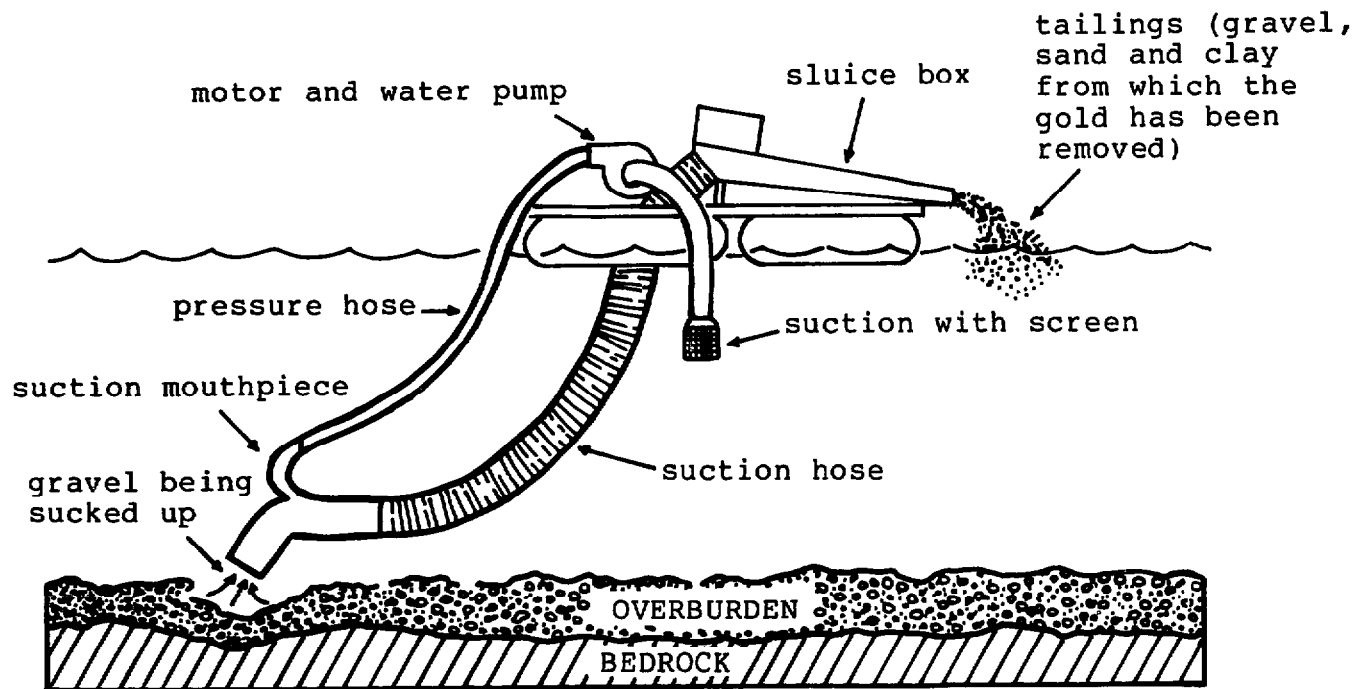

Fig. 15 Suction dredge
 (According to Thornton, 1977)

It can be seen that a suction dredge can treat relatively large quantities, so that it is able to work a deposit which would be marginal when using a longtom. The smallest type of suction dredge can treat $30\text{m}^3/\text{day}$ compared with 2 - $3\text{m}^3/\text{day}$ when two men are feeding a longtom by shovel.

In all cases, be it sluicebox, ground sluicing, rocker or suction dredge, it is necessary to separate the gold from the heavy minerals which have been retained by the riffles. In small scale mining the simplest method of final concentration is by a batea worked in a 50 litre oil drum cut in half and filled with water, so that the light minerals, if required, can be re-concentrated several times until they no longer contain any gold.

Another method is to store all the heavy mineral concentrate and to send it periodically to a central plant which is run on a co-operative basis and where the gold is separated by mechanical methods such as a superpanner or jig.

It pays to take periodic samples of the heavy mineral concentrate from which the gold has been removed and send them to the GMD laboratory, because there is a real possibility that they may contain valuable minerals such as tin, platinum, diamonds and other precious stones.

If the gold is very fine and is lost in the concentration process in the batea, longtom or rocker then the heavy minerals can be treated with mercury. Gold and mercury combine in a ratio of 1:1 to form an amalgam. Mercury is separated from the gold by evaporation as explained in Chapter 6.

4.1.7 Leaching

(a) Heapleaching (Fig. 16)

This is fundamentally different from the previously described gravitational methods. In heapleaching, the gold bearing material, which has to have good permeability, is placed in large heaps on an impermeable base. It is sprayed with a sodium cyanide solution which is recycled for several weeks or months until all the gold is

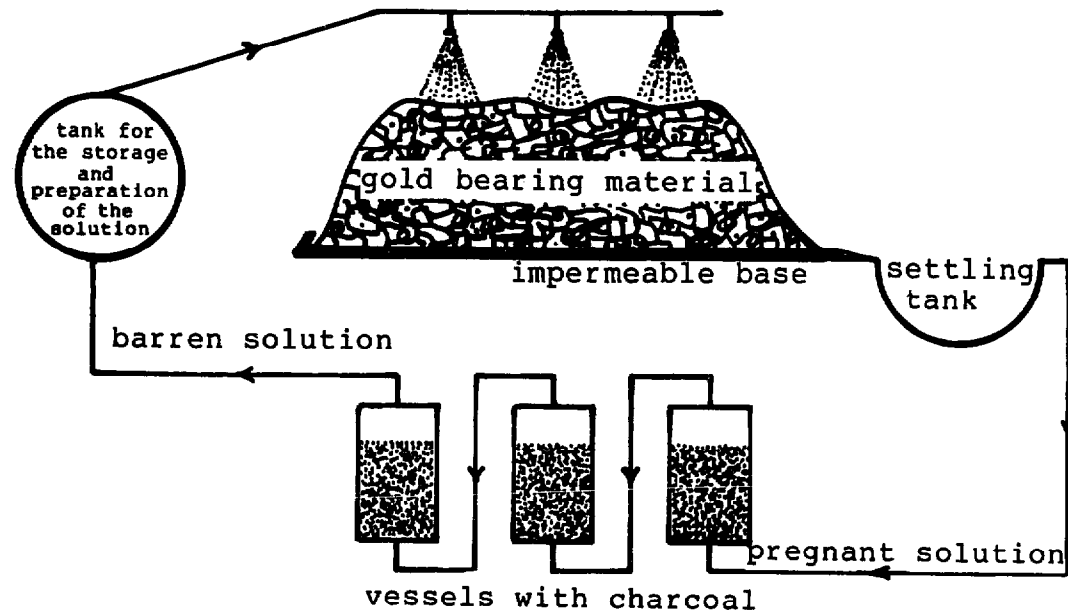

Fig. 16 Heapleaching arrangement

dissolved. Progress is checked by testing the gold content in the circulating cyanide solution. When the gold content no longer rises then it can be assumed that all the gold has gone into solution. The so-called 'pregnant solution' is passed through retorts containing charcoal or activated carbon which absorbs the gold. The charcoal is then burnt and the gold melted out. This method uses very poisonous solutions and is to be introduced into Suriname in the near future by experts who will operate it during the early periods. It will be obvious that this method is only suitable for larger operations, perhaps managed by co-operatives.

(b) Agitation Leaching

The method will recover even the finest gold. Gold-bearing clay can also be treated provided it is slurried and kept in suspension in large tanks.

(c) Vat Leaching

The vat leaching method, on the other hand, is more suitable for recovering gold from sands which have not been ground fine enough to be recovered by the use of agitators. Vat leaching uses a tank with duck boards in the bottom covered with hessian cloth. This in turn is covered with a layer of finely woven coir matting. When ready the vat is filled with ore and cyanide solution is then fed into the tank until all the ore is covered with solution. Samples are taken, and when the gold content shows acceptable levels of dissolution the discharge valves are opened and the pregnant solution is sent to the precipitation unit. Samples are taken at regular intervals until the gold content in the solution shows that an acceptable recovery has been achieved. The vat is then emptied and the cycle re-commenced.

4.2 Prospecting

If it is suspected that gold occurs in an area then this can be verified relatively quickly by prospecting. At this stage of the investigation, there is no need to determine the actual amount of gold in the ground, but it is necessary to differentiate between meaningful indications and those which need further investigation. We shall return to this subject after discussing different methods of prospecting. There are two such methods - geochemical and gravity.

4.2.1 Geochemical Prospecting

In geochemical prospecting samples are collected systematically on a grid basis and sent to the GMD laboratories for gold determination. The samples are taken at fixed intervals along grid lines at a depth of 30 cm below the top soil, as shown in Fig. 17. A grid of 400m x 20m is recommended.

The samples of about 250g are packed in plastic bags, 40 by 20cm and tagged with a label which must contain the following information:-

- name and registration number of concession holder.
- name of the concession.
- line and picket number of sample location.

The samples must be accompanied by a sample list and a map of the locations.

If 10 or 20% of a series of samples contain gold of more than 0.2 ppm or 0.2g/tonne then the area has an economic potential. If the percentage is less but the area appears to extend beyond the boundaries of the prospected area, as shown in Fig. 17, then it is worth extending the area under investigation in the indicated direction(s).

4.2.2 Prospecting using Gravity Concentration Methods

In this method of prospecting, gravel and sand samples are collected every 250 metres, as shown in Fig. 17, and are concentrated in a batea.

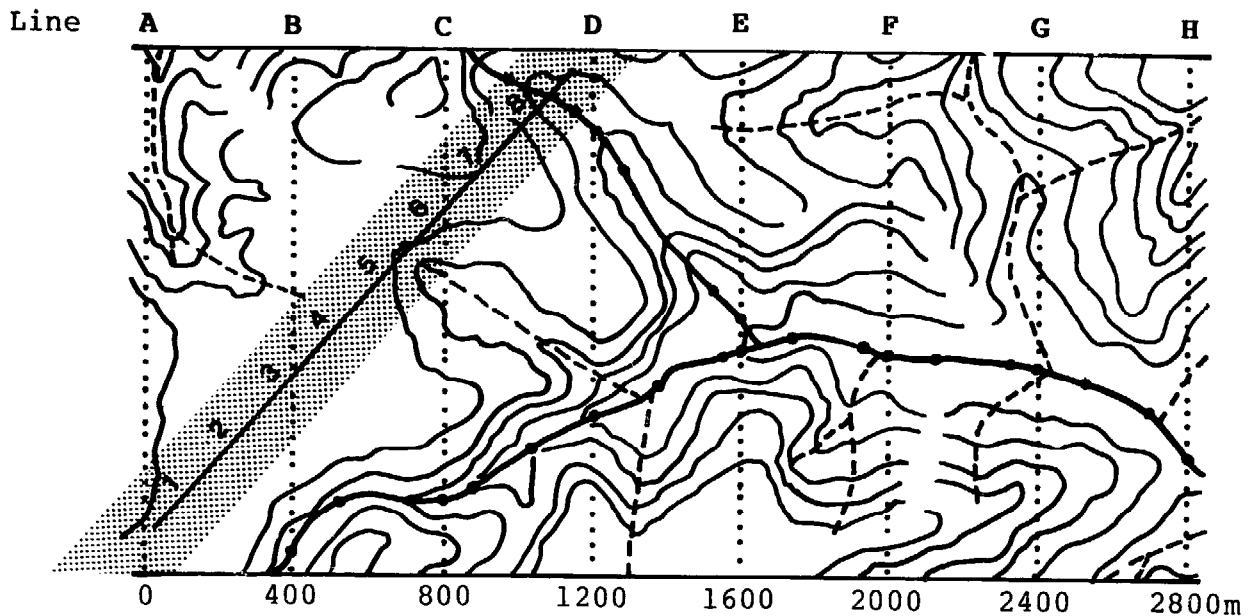

0 200 400 600 800m scale 1:20,000

- ▲ location of gold bearing quartz dyke
- ▨ zone with soil samples containing more than 0.2 ppm of gold
- location of batea samples
- ↗ location of rock chip samples

Fig. 17

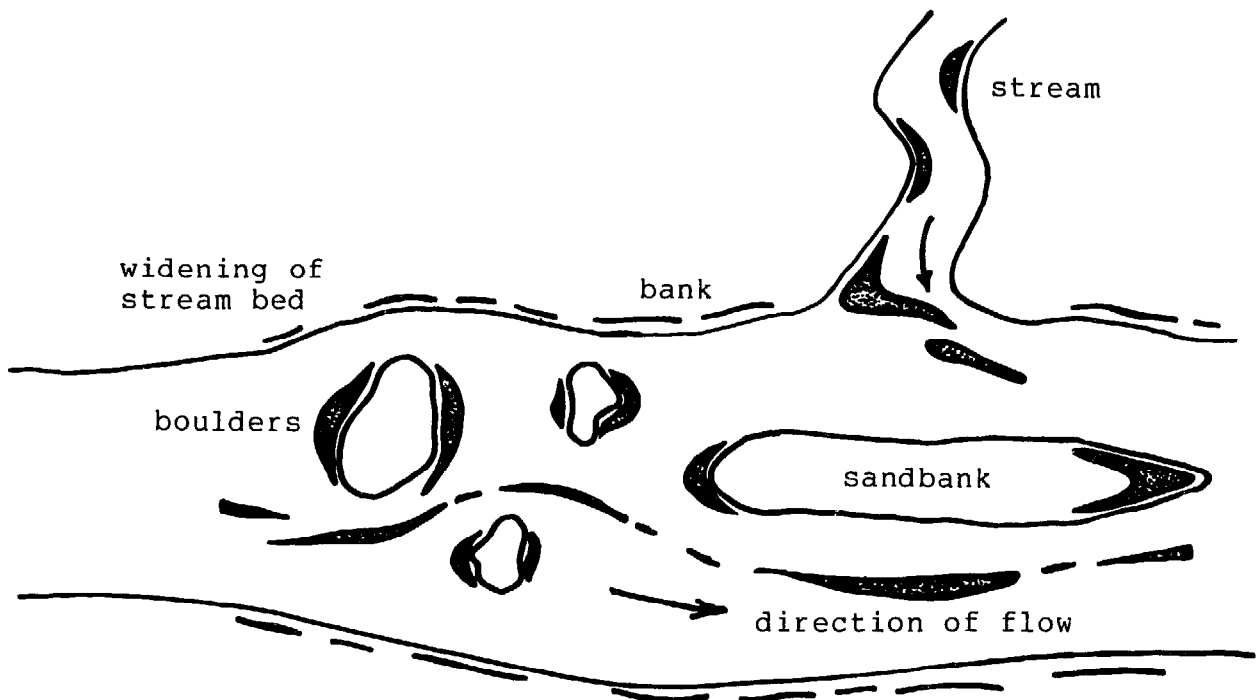

Fig. 18 Locations where concentrations of gold and heavy minerals can be expected. Concentration is greatest underneath boulders and other obstacles of the widening stream bed. (According to Zeschke, 1964)

Before starting with this labour intensive way of collecting information, it is worth taking a few samples at the most likely locations, as shown in Fig.18. If no gold shows in the batea it is then necessary to dig pits down to bedrock at the places shown in Fig. 18 and to treat samples of the sand and gravel immediately above bedrock and from the top layer of the bedrock itself.

In order to obtain an indication of the gold content one can use reference pictures supplied by GMD which consist of plastic cards showing the particle sizes and average weights encountered. It is possible to overestimate the amount of gold by a factor of two or three because it frequently occurs in platelets.

If one starts from the fact that a batea of 45cm diameter contains 6 litres or 1/167th part of a cubic metre of gravel then it is possible to determine the gold content per cubic metre, as the example in the following table shows:

Class	Size mm	Average Weight mg.	Proportion	Weight of Fraction mg.
1	+2	80.8	0	0
2	2	8.61	0	0
3	0.85 - 0.425	1.84	2	3.68
4	0.425 - 0.25	0.42	3	1.26
5	- 0.25	0.09	17	1.53
Total				6.47 mg

The gold content of this material will therefore be $167 \times 6.47 = 1080 \text{ mg./m}^3$ or 1.08 g/m^3 . Records of results should be kept in a very clear manner, as illustrated in Fig. 19, and all the gold recovered in pits or streams must be handed over to the Head of the GMD.

If 10 - 20% of the pits or surface samples contain gold, as averaged in Fig. 19, then the area could be interesting and further exploration would be justified.

It is important in geochemical prospecting that a sample should be treated in a batea at each point where a stream or river crosses a sample line.

If the prospecting phase has been successful and an area has been designated as positive then it is necessary to determine the type of deposit -

Name of concession holder
 Area of concession
 Concession No.
 Name of batea operator

Pit No.

BATEA PROSPECTING

Sample No.	Depth in cm	Clay	Sand	Gravel	Occurrence of gold particles by class*					Tot. wt of gold mg	x 167 = mg/m ³	Vol. % gravel +7-10 cm	2*	3*	Remarks
					+2 mm	2 mm 0.85mm 6.00mg	0.85mm 1.56mg	0.425mm 0.31mg	0.25mm				-0.25mm 0.05mg	mg gold per m ³ after correction	
1	0-20	X			-	-	-	-	4	0.2	33.4	0	33.4	13.36	Groundwater at a depth of 85cm X = mainly
2	20-80	X	X		-	-	-	2	4	0.82	136.94	0	136.94	109.55	
3	80-130		X					5	10	2.05	342.35	0	342.35	342.35	
4	130-180		X	X	(10mg)	5	3	3	10	46.11	7700.37	15%	7700.37- 1155.06= 6545.31	6545.31	
5	180-200	X		-	-	-	-	-	-	-	-	-	0.0	0.0	

Total 7010.57mg

Sample No.

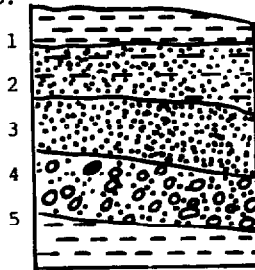

Pit profile

Average gold content in pit $7010.57 \div 5 = 1402.11 \text{ mg/m}^3$ or 1.4 g/m^3
 Thickness of overburden 1.30m
 Thickness of gold bearing layer 0.50m

* The average weight of gold particles varies from area to area depending on their shape

2* The volume of material in sample no. 4 in which 7,700.37mg of gold were found was 15% greater and therefore the weight of gold 15% larger. $0.15 \times 7,700.37 = 1,155.06 \text{ mg}$. The true content was $7,700.37 - 1,155.06 = 6,545.31 \text{ mg/m}^3$

3* The content was recalculated for the thickest layer, sample no. 3, of 50cm. If the gold in sample no. 1 of a thickness of 20cm is spread over a thickness of 50cm, then the grade is reduced in the proportion of $20/50=0.4$; the grade will be $33.4 \times 0.4 = 13.36 \text{ mg/m}^3$

Fig. 19

whether it is a primary (a quartz reef) or a secondary colluvial or a secondary stream deposit-as this will affect the work programme for the next phase.

All quartz pieces which are found along the sample lines or in their immediate vicinity should be carefully recorded on a map, together with a note of whether they were sharp or rounded. It is also necessary to occasionally break up large stones with a hammer, to grind them in a mortar, and to determine in a batea whether they contain gold. If gold-containing quartz samples can be found along several lines, as shown in Fig. 17, then the direction of the quartz reef can be determined.

By observing the profiles of the pits and whether the fragments of the gravel or conglomerates are of approximately the same size and rounded or with great size variations and sharp edges, the nature of the deposit can be determined, i.e. whether it is alluvial or colluvial.

4.3 Exploration

The objective of this phase is to obtain reliable information on:

- the surface area of the gold deposit and its depth
- the gold content of the material to be mined
- the ways in which the gold particles occur in the deposit i.e.
 - * their size distribution
 - * the point of maximum gold concentration
 - * the nature of the gangue in which the gold occurs, whether clay, sand, gravel, quartz or a mixture of them.

The information obtained during the prospecting phase will help us determine the exploration phase according to the way the gold is occurring, either as a primary or a secondary colluvial or alluvial deposit. The basic principle during the exploration phase is that the concentrating

method should be the same as during the subsequent exploitation phase, so that the amount of gold recovered is not less than expected.

4.3.1 Exploration of Secondary Deposits

4.3.1.1. Stream and Alluvial Deposits

Location of the Pits

The place where the maximum gold was found during prospecting should be taken as the starting point for exploration. From here a straight line should be drawn along the axis of the valley, and the occurrence and depth of gravel should be established with a steel test rod every 5 - 10 meters.

If it is shown that gravel occurs across the width of the valley as shown in Fig. 20, it is recommended that further pits be dug on a regular pattern, i.e. a line will be laid out either side of the original line at a standard distance of 50m, which will then be sampled and tested by the GMD to establish whether gravel occurs in those locations. The pits are dug on a grid of 50 or 25m. Scratch samples are taken vertically down the whole depth of the pit and treated in order to determine how the gold content varies with depth. Every 15cm a sample, 20cm x 20cm (which approximately equals the contents of a batea), is taken out of the side of the pit. The gold content per cubic meter of the collected scratch samples is estimated as shown in the section on prospecting.

When digging a pit, the layer with the highest gold content is shovelled on to a heap and treated in a longtom. The gold obtained is weighed and is expressed in terms of the volume of the whole pit, as shown in Fig. 22. The following information is immediately available from this table:-

- the thickness of the gold bearing layer
- the gold content of this layer in g/m³
- the thickness of the overburden

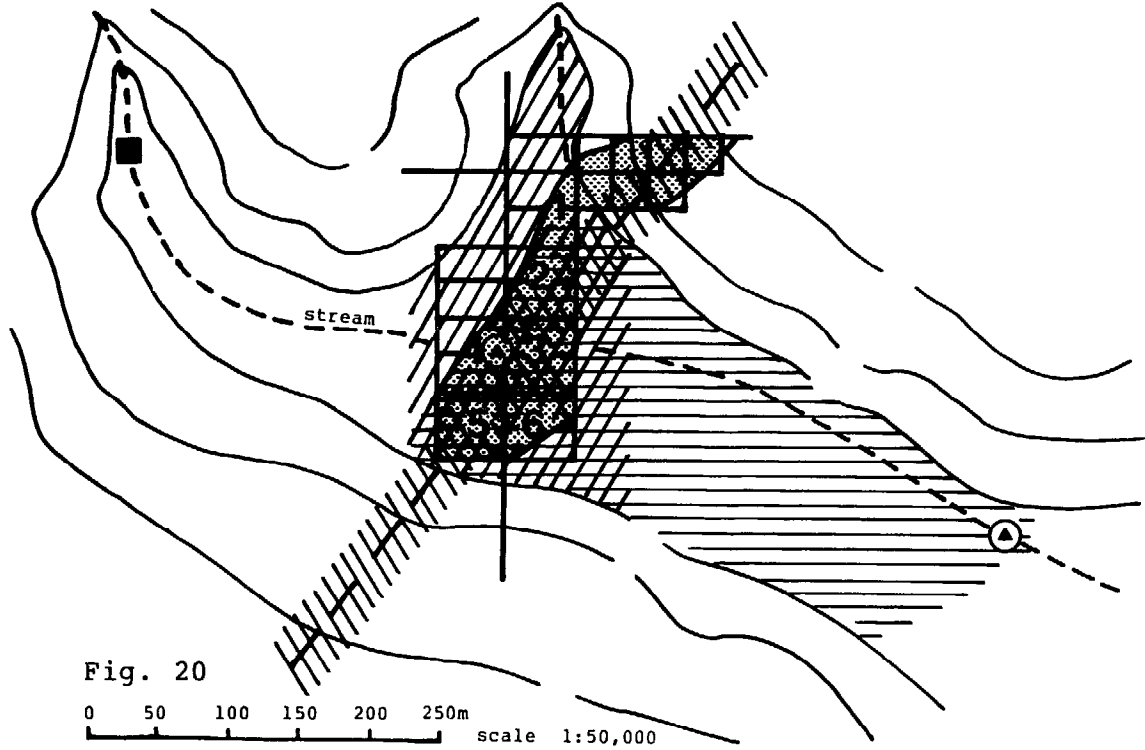

Fig. 20

0 50 100 150 200 250m scale 1:50,000

- Location of prosp. pit
- ⊙ Location of gold bearing prosp. pit
- ▨ Area where a steel probe indicated gravel
- ▧ Area where exploration of colluvial deposit should be considered
- ▩ Area where exploration of stream deposit should be considered
- ▤ Area of possible exploitation

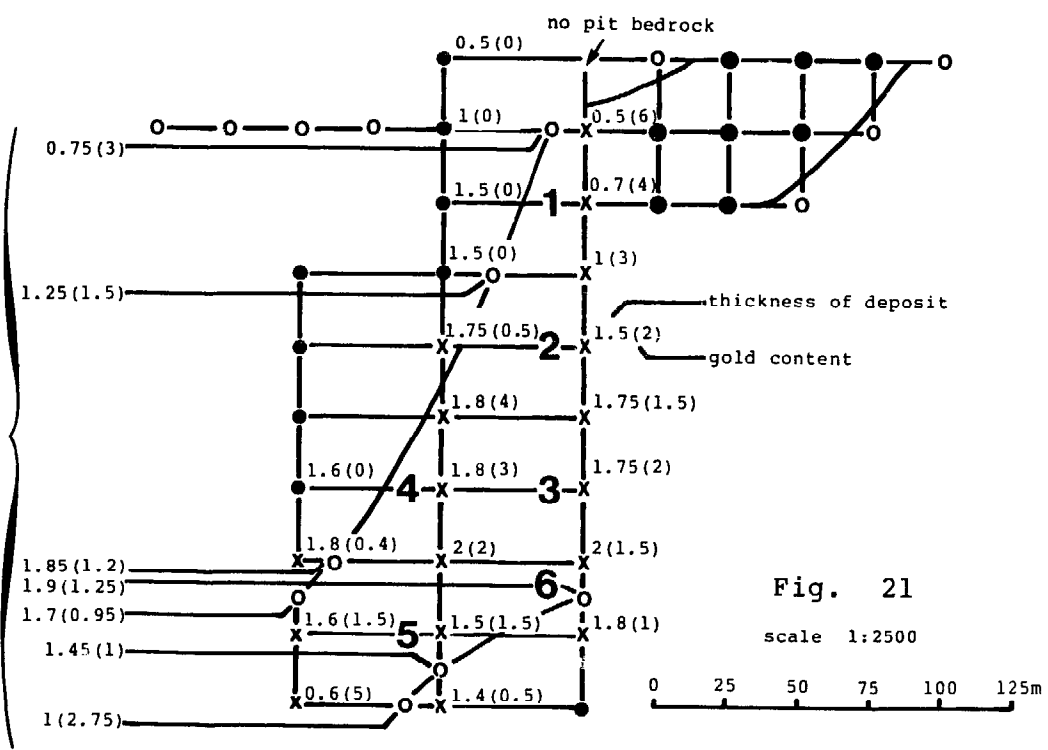

Fig. 21

scale 1:2500

0 25 50 75 100 125m

- X Location of exploration pits containing gold
- Barren pits
- Pits in colluvial deposits
- Ditto, containing gold
- ▨ Primary quartz reef deposit containing gold

Name of concession holder LONGTOM EXPLORATION
 Concession area
 Concession No.

PIT No.
 Measurements 2x1x2m = 4m
 Content 4000 litres

Sample No.	Content litres	Depth in cm	Clay	Sand	Gravel	Tot. wt of gold mg	Remarks
1	400	0-20	X				
2	1200	20-80	<u>X</u>	X			<u>X</u> = mainly
3	1050	80-130		X			
4	1000	130-180		X	<u>X</u>	8837.78	This means 8.84g/m ³
5	400	180-200	X				

Total 4000 litres

Total 8837.78

Average gold content in the pit $\frac{8837.78}{4000} = 2209.45\text{mg/m}^3 = 2.21\text{g/m}^3$

Thickness of overburden 1.30m
 Thickness of gold bearing layer 0.50m
 Gold content of gold bearing layer 8.84g/m³

Sample No.

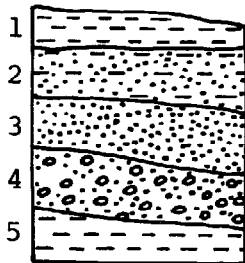

Pit profile

Fig. 22

- the average gold content in g/m^3 of the gold bearing layer plus the overburden, i.e. of the whole pit.

If the gold content of the pits along the middle line exceeds about 2g/m^3 then exploration should be continued by digging pits along the two adjacent lines, and determining the gold content. The location of the pits is recorded on a map giving the distance between them as accurately as possible. The thickness of the deposit and its gold content is indicated at each location as shown on Fig. 21.

Estimation of the Value of the Deposit

First, the limits of the deposit should be shown by drawing a border inside which all pits have a gold content of more than say 1.5g/m^3 . The border should consist as far as possible, of long straight lines. To prevent an overestimation of the value of the deposit it is recommended that additional pits be dug in areas of high gold content. This is also shown in Fig. 21. As shown, the surface area is divided into blocks of 50m by 25m i.e. an area of 1250m^2 each. These are combined into double blocks. The area of incomplete border blocks is simplified into triangles and rectangles for estimation. The surface area (a), the average thickness (d), the volume (v), the average grade (g), and the value (w) of each block are calculated and listed as in Fig. 23. The total volume (V), the average grade (G), and the total value (W) are shown at the bottom of the table, Fig. 23.

The advantage of this method of calculation is that, independently of the financial situation of the project, it is possible to make a mining programme giving the equipment to be used, the rate of mining and a schedule of the sequence in which the blocks are to be mined.

The minimum viable gold contents for treatment by batea or longtom are 5.25 and 3.15g/m^3 respectively. A suction dredge can only be considered if enough water can be made available, say by damming a stream.

The deposit shown (of $17,191 \text{m}^3$) can be mined with a 2.5 inch suction dredge of $30\text{m}^3/\text{day}$ capacity in 573 working days. Assuming that there are 300 working days in a year then this deposit will last for 1 year 11 months.

CALCULATION OF THE VALUE OF A DEPOSIT
(see also Figs. 21 and 22)

Block No.	O (= surface) (= number of squares x 1,250m ²)	d (= average depth)	v (= volume)	g (= average content)	w (= v x g x p); p = f 12.50/g
1	1 x 1,250 = 1,250m ²	0.50 m 1.00 m 1.25 m 0.75 m <u>3.50 m</u> :4=0.88 m	1,250 m ² x 0.88 m = 1,094 m ³	0.5x6.00 = 3.00 1 x3.00 = 3.00 1.25x1.50 = 1.88 0.75x3.00 = 2.25 <u>3.50</u> 10.13:3.5= 2.89 g/m ³	v x g x p = 1,094 x 2.89 x f 12.50 = f 39,520.75
2	1.75 x 1,250m ² = 2,188 m ²	1.00 m 1.75 m 1.80 m 1.25 m <u>5.80 m</u> :4=1.45 m	2,188 m ² x 1.45 m = 3,173 m ³	1 x 3.0 = 3.00 1.75x1.5 = 2.63 1.8 x 4 = 7.20 1.25x1.5 = 1.88 <u>5.8</u> 14.71:5.8= 2.54 g/m ³	v x g x p = 3,173 x 2.54 x f 12.50 = f 100,742.75
3	2 x 1,250m ² = 2,500 m ²	1.75 m 2.00 m 2.00 m 1.80 m <u>7.55 m</u> :4=1.89 m	2,500 m ² x 1.89 m = 4,719 m ³	1.75x1.5 = 2.63 2 x 1.5 = 3.00 2 x 2 = 4.00 1.8 x 4 = 7.20 <u>7.55</u> 16.83:7.55= 2.23 g/m ³	v x g x p = 4,719 x 2.23 x f 12.50 = f 131,542.12
4	1 x 1,250m ² = 1,250 m ²	1.80 m 2.00 m 1.80 m <u>5.60 m</u> :3=1.87 m	1,250 m ² x 1.87 m = 2,333 m ³	1.80x4 = 7.20 2 x 2 = 4.00 1.8x0.4 = 0.72 <u>5.6</u> 11.92:2.56= 2.13 g/m ³	v x g x p = 2,333 x 2.13 x f 12.50 = f 62,116.13
5	2 x 1,250m ² = 2,500 m ²	2.00 m 1.45 m 1.00 m 0.60 m 1.70 m 1.85 m <u>8.60 m</u> :6=1.43 m	2,500 m ² x 1.43 m = 3,575 m ³	2 x 2 = 4.00 1.45x1 = 1.45 1 x 2.75 = 2.75 0.6 x 5 = 3.00 1.7 x 0.95 = 1.62 1.85x1.2 = 2.22 <u>8.60</u> 15.04:8.6 = 1.75 g/m ³	v x g x p = 3,575 x 1.75 x f 12.50 = f 78,203.13
6	1 x 1,250m ² = 1,250 m ²	2.00 m 1.90 m 1.45 m 2.00 m <u>7.35 m</u> :4=1.84 m	1,250 m ² x 1.84 m = 2,297 m ³	2 x 1.5 = 3.00 1.9 x 1.25 = 2.38 1.45x 1 = 1.45 2 x 2 = 4.00 <u>7.35</u> 10.83:7.35= 1.49 g/m ³	v x g x p = 2,297 x 1.47 x f 12.50 = f 42,207.38

Total volume V = 17,191 m³ Average content G = $\frac{W}{V \times 12.5}$

Total value W = f 454,332.26

Note: The calculated value of the deposit has to be corrected for the purity of the gold. This correction factor (C) is about 0.9 in Suriname.

Before considering the mining of this deposit with a suction dredge it will be necessary to establish experimentally how many grams of gold per cubic meter can be recovered with it. The exploitable value of the deposit will then be:

$$W' = V \times G' \times C \times P$$

Where G' is the grade as mined by the dredge and C a correction factor for the purity of the gold - which can be determined in the laboratory of the GMD.

4.3.1.2. River Deposits

If it is found during prospecting that the sand and gravel of the stream bed contains gold then the chances are that the adjoining terraces will also carry gold. This assumption must be verified at the places shown in Figs. 18 and 24 when the water level is low, by digging pits into the sand and gravel banks and testing the materials as in paragraph 4.3.1.1. The roots of the plants along the banks and islands should also be washed and the earth and gravel concentrated. The contents of potholes should also be treated. If the surface of the bedrock is exposed and dry, then several centimeters of its depth should be removed, and all the sand and gravel, whether it be cemented with iron oxide or not, should be tested for gold. Fig. 25 shows how cracks and holes can collect the gold.

If these tests are positive then the river bed can be explored with a suction dredge (the type used will depend on the depth of water and thickness of the sand and gravel bed) by dredging every 100m at right angles to the direction of the flow.

The volume of sand and gravel sucked up per hour must be determined (this will present some practical difficulties) as well as the weight of the gold recovered. The grade can then be calculated by dividing the weight of gold by the volume of sand.

When dredging it is very important that any potholes, cracks and depressions in the bottom of the river are emptied completely, cracks should be broken open with a chisel, cleaned out and gone over again with the dredge. Cracks and splits in the banks which contain gold and continue into the river need special attention.

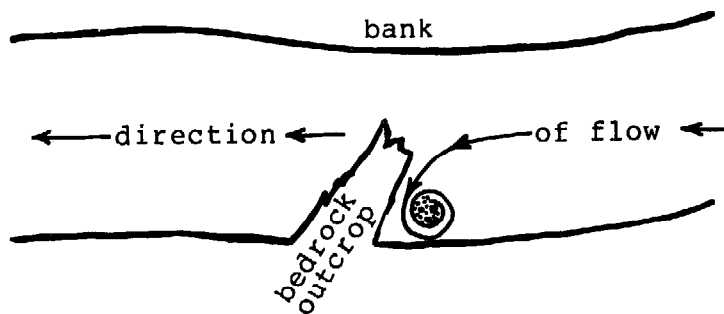
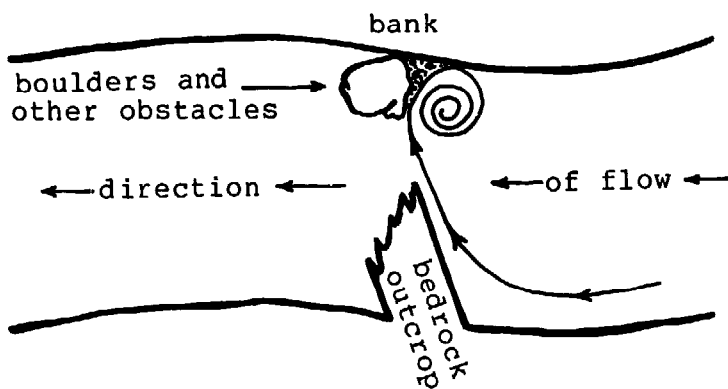
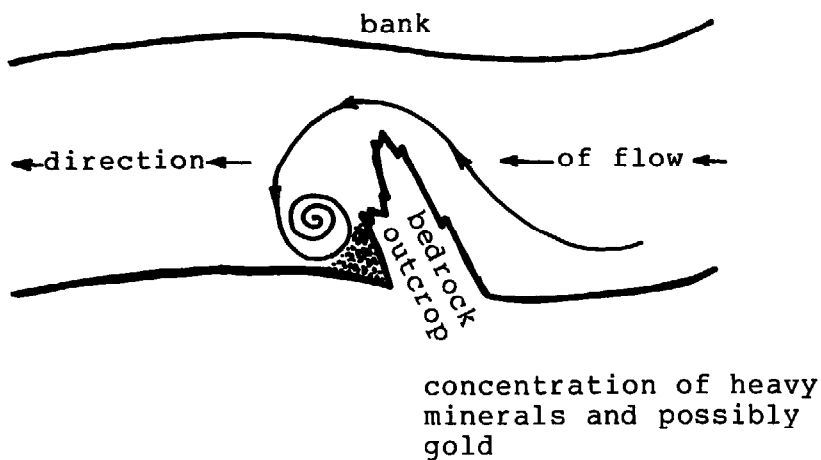

Fig. 24 Location of heavy mineral concentrations upstream of bedrock outcrops (According to Thornton, 1977)

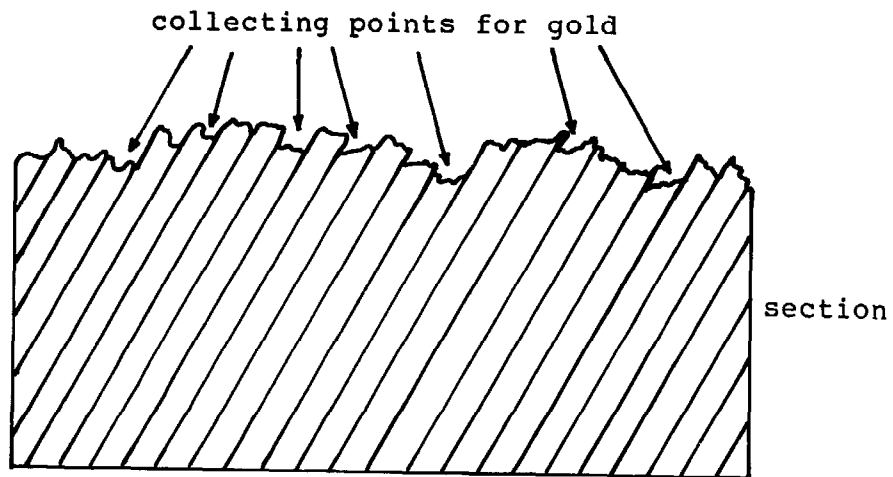
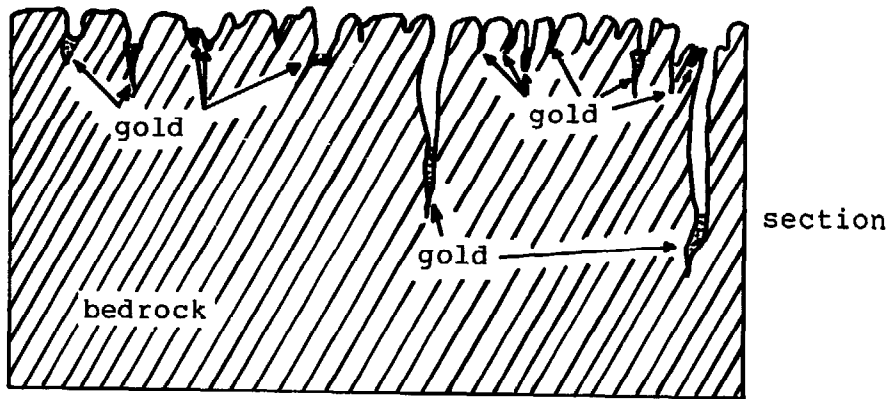

Fig. 25 Structure of the bedrock of the river bottom suitable for gold concentration. (According to Thornton, 1977)

If the gold content is very high one might have to consider damming the river upstream of the find and diverting it. The volume of sand and gravel (V) is determined by the product of the length (L) of the river which contains gold, the thickness of the sand and gravel (D) and the width of the river (B), so that:

$$V = L \times D \times B$$

The value of the deposit (W) is

$$W = V \times G \times C \times P$$

One should be aware that generally in the upper reaches of a river the overburden is thinner and the gold particles coarser, whereas in the lower reaches the overburden becomes thicker and the gold finer.

4.3.1.3. Secondary Colluvial Deposits

These are found at the foot of hills and in river valleys, below the region of primary gold bearing bedrock.

Pit Location

During exploration a series of pits should be dug a few centimeters into the weathered bedrock, starting with a line uphill from the location of the first find, as shown in Fig. 20. The first indication may have been found during prospecting, when the secondary colluvial character was recognised, or it could be a point in a river upstream of which there is a steadily increasing gold content. It is obvious that the gold was brought to this point either from the primary bedrock in the bottom of the river, or from secondary colluvial deposits on the river banks, see Fig. 5 and 26. Exploration proceeds uphill by digging pits every 25m until there is no longer any gold. This indicates that one has passed the gold bearing bedrock. The gold content of the pits and the nature of the deposit are recorded in the same way as for stream or land deposits. It will often be found difficult to distinguish between the layers of sand, gravel and clay as they may occur in confused inter-beddings. If there are indications that there are several quartz reefs within a short distance

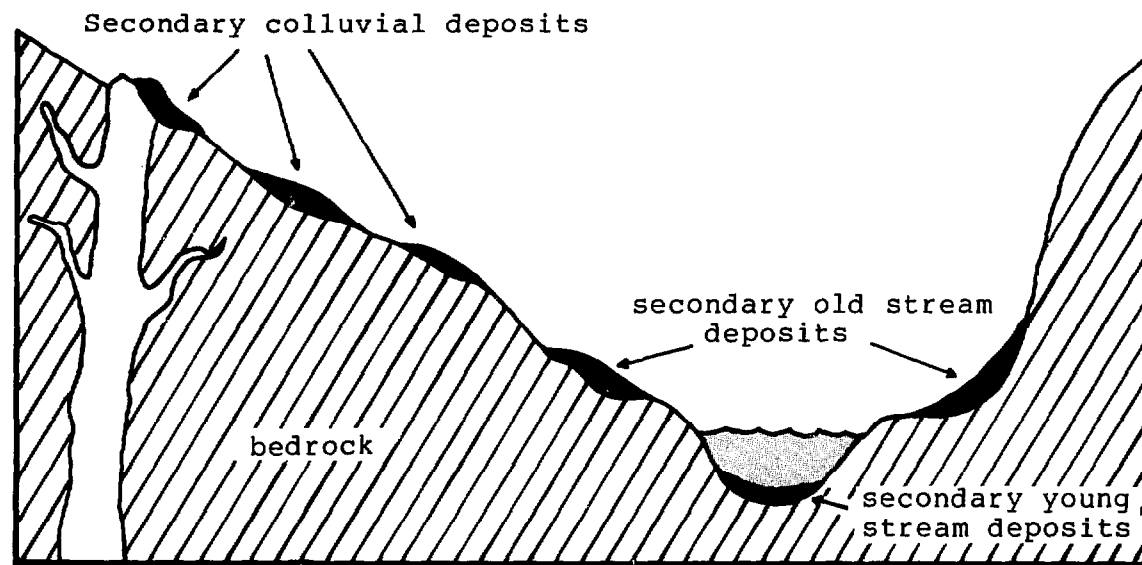

quartz reef (primary deposit)

Fig. 26 Relationship between primary and secondary
gold deposits
(According to Thornton, 1977)

of each other, it may be advisable first to dig a trench at the foot of the hill in the direction of the valley to determine the width and direction of the zones. The value of the ground is determined as for river deposits.

One problem which may arise is the availability of water necessary for the operation of the batea, rocker, ground sluice, or longtom. The large quantities required for longtom or ground sluicing can be supplied by a 1.25 or 1.50 inch pump over distances of 50 to 75m (as shown in Fig. 20) if there is enough water in a side stream, or for 150m if one has to use the main stream.

If the shape of the valley and the direction of the gold bearing bedrock allow it, one should consider whether the overburden and the gold-containing deposit should be removed by monitors (high pressure water jets). The suction dredge can be used for this purpose, by removing the suction hose from the vacuum chamber and fitting a smaller pipe. A full description of this method is beyond the scope of this manual.

Although colluvial deposits are generally smaller than alluvial or river deposits, they can still be attractive because of the relatively thin overburden and the occurrence of nuggets. In practice one starts with stream deposits and works upstream, checking the sides for colluvial deposits and possibly gold bearing bedrock.

4.3.2. Exploration of Primary Deposits

If during the prospecting phase of colluvial exploration, sharp edged pieces of quartz containing gold are found, it is recommended that these are sampled in a systematic way to establish the direction of the gold mineralisation. Information can be gathered from geochemical and prospecting if values of more than 0.2 ppm gold are found along several lines, which can be connected as shown in Fig. 17.

Information about the direction of mineralization can also be established by digging pits as shown in Fig. 21, enabling the direction to be studied in three dimensions by observing the sides of the pit. Once the direction of the reef or of the series of reefs is known then this can be followed by taking rock chip samples every 25 to

100m, depending on the nature of the terrain. This is done by chipping pieces, 2-3cm in size, off the quartz vein until a composite sample of about 2kg is obtained. Half the weight of each sample (1kg) should be put into a linen bag bearing a label, with this information:

- name of the concession holder
- registration number of the concession
- name of the concession and the distance of the sample from the first point of the line.

In the example shown in Fig. 17 the following samples were collected:-

No. 1	Line A	picket 5	0-100m
No. 2	Line A	picket 5	100-200m
No. 3	Line A	picket 5	200-300m

These samples were sent to the laboratory of the GMD for the determination of gold content and used as a check on the samples assayed in the field.

The other half of the samples (1kg) remains in the field, is broken up with a hammer and ground in a mortar until it has the appearance of sand. It is then treated in a batea and the gold weighed so that the content, which can be separated mechanically, is determined and expressed in grams per ton. In this type of field investigation, one has to bear in mind that the gold, being soft, is beaten into thin platelets by the hard quartz, so that gravitational methods can indicate a lower gold content than is actually present.

If the gold content is of the order of 20g/t then it is recommended that a trench be dug at the point of highest gold content at right angles to the direction of the reef in order to expose the hard rocks beneath the surface. In this way the sampling of the reef is improved and information regarding the width and nature of the occurrence can be derived. Generally, this operation requires the removal of comparatively large amounts of ground, and it might be advantageous to use a bull-dozer or dragline. If high gold contents are found over a distance of more than 500m over a width of more than 1m then one should investigate, by means of drilling, how the reef

and its mineralization continues in depth. It will be clear that this requires considerable investment in geological and engineering aspects, taking a highly professional approach which is beyond the scope of this manual. In this case one should certainly consider a more modest exploitation of the surrounding colluvial deposits.

5. PURITY OF GOLD

Gold which has been separated by gravity methods will not be completely pure, as silver, copper and other impurities are mixed with it. The purity of gold (bullion) is expressed in parts per 1000. The average purity of placer gold (i.e. secondary and colluvial) in Suriname is 900. The samples are tested by the Assay Office of the Weights and Measures Department of the Ministry of Economics.

6. AMALGAMATION OF GOLD FROM MINERAL CONCENTRATES WITH MERCURY

- a. Extract the heavy concentrate from the original sample by means of a batea, longtom, rocker or other suitable method.
- b. Put the concentrate in a pan and count the gold particles of the various sizes and remove by hand any which are larger than 2mm.
- c. Add one drop of gold free mercury about the size of a bean and reduce the amount of heavy minerals to a smaller volume.
- d. Remove the mercury and put it into a 250ml heat resistant beaker, add 40 to 50ml dilute nitric acid and dissolve it until the size of the mercury drop is reduced to the size of a match head. Pour everything into a porcelain cup, add more acid and heat for a while until the mercury has been dissolved. The fine gold will remain as a spongy mass as the solution is separated. Boiling of the solution must be avoided.

- e. Pour off the acid solution and wash the gold three or four times with warm water. Add one or two drops of alcohol and dry the gold residue by applying a little heat.
- f. Heat the flameproof porcelain beaker until it starts to glow and all the remaining mercury is evaporated.
- g. Put the gold aggregate together with the plus 2mm particles, which were previously separated, on to scales and record the weight.

The following, simpler, method was developed but more mercury may be retained in the sample. The fine gold, mixed with small gangue particles is heated with mercury in a can which has been cut in half and is covered with a leaf. The mercury evaporates and precipitates on the leaf while the gold remains behind as a spongy lump, which may still contain stone particles and mercury. The mercury can be recovered by pulverizing the leaf in a small tin can, and can then be re-used.

7. TREATMENT OF POISONING

7.1 Irritants including Mercury

Besides mercury there are other poisons from which small scale miners may be at risk: solutions containing copper, lead, phosphorus and even normal day-to-day things such as petrol, paraffin and iodine. All are irritant poisons.

Symptoms

All these poisons irritate and inflame the stomach and intestines, causing retching, purging, colicky pains, and ultimately suffocation and collapse. In iodine poisoning there is also great thirst.

Treatment

If able to swallow, give an emetic. Dilute the poison by giving water, tea or milk in abundance. Keep the patient warm and give him beaten-up eggs or salad oil, except in the case of phosphorus poisoning. In iodine poisoning give starch and water.

NB. - Phosphorus dissolves in oil, and in this form is more readily absorbed into the system. Therefore never give oil in a case of phosphorus poisoning.

7.2 Corrosives

This group comprises all the strong acids and alkalis, many of which are in regular use in all types and size of mines. These include sulphuric acid, hydrochloric acid, nitric acid, oxalic acid, carbolic acid, creosote and alkalis such as lime, caustic soda, potash and ammonia. These poisons stain, burn and eat into the tissue of the mouth, throat, gullet and stomach, causing intense pain, suffocation and collapse.

Treatment

In general no emetic can be given, as the spasm of vomiting might rupture the wall of the stomach with very serious results if it is already corroded. For oxalic acid an emetic may be given followed by a weak alkaline solution.

In all cases dilute at once by giving water, after which for carbolic acid, creosote and lysol give 2 to 3 tablespoonfuls of Epsom Salts or Glauber Salts if available. Otherwise, and for all other corrosive acid poisons, neutralize by giving weak alkaline solutions as shown in the following rules, paragraph 4(b).

7.3 General Rules for the Treatment of Poisoning

1. Send for a doctor, stating what has occurred and the suspected poison.
2. If breathing is not perceptible, start artificial respiration immediately.
3. Preserve any traces of the poison which may exist. Carefully retain any glass, cup, bottle, packet or food which may have contained some of the poison; also the patients vomit, if any, and stained clothing. This is of legal as well as medical importance.
4. (a) If the patient is conscious, can swallow, and has no burns or blisters about the lips or mouth, promote vomiting in order to rid the system of as much poison as possible. This can be done as follows:-

By tickling the back of the throat with a finger, a feather or a paper spill.

By emetics, such as two teaspoonfuls of mustard or one tablespoonful of salt in half a tumbler of warm water, or two teaspoonfuls of ipecacuanha wine. Repeat the dose every five minutes until vomiting begins.

- (b) If the lips or mouth are burned, give no emetic. The poison was either a strong acid or alkali. Discover which and neutralize by administering the other. For acid poisoning give repeated doses of a weak alkali such as chalk, magnesia, whitening, or ceiling plaster. For alkaline poisoning, give, by the tumblerful, a weak

acid such as vinegar, lime or lemon juice in an equal quantity of water. If it is not known what the poison was give copious draughts of cold water.

5. Administer the proper antidote. This will counteract the poison and render it harmless. For acids and alkalis see paragraph 4 above.

If there is no clue as to the nature of the poison, give milk, raw eggs beaten up in either milk or water, beaten-up cream and flour, strong tea or even just water alone.

6. Treat any special symptoms.
 - (a) For shock and collapse promote warmth and give stimulants.
 - (b) For drowsiness, keep the patient on the move.
 - (c) If the throat is badly swollen, apply hot fomentations to reduce the risk of the air passages becoming blocked and give frequent sips of cold water.

8. REFERENCES

- Anderson, R. B., 'The Exploration, Valuation and Development of Small Mines', Proceedings of a symposium arranged by the Institution of Mining and Metallurgy, Rhodesia Section, 1965, 104pp.
- Armstrong, A. T., Handbook on Small Mines. (Eastwood) South Australian Dept. of Mines and Energy, 1980, 206pp
- Bernewitz, M. W. Von, A.B.C. of Practical Placer Mining, Great Western Publishing Co., 62pp.
- Bernetwitz, M. W. von, 'Saving Gold By Means of Corduroy', 1939, U.S. Bureau Mines Inf. Circ 7085, 17pp.
- Boericke, W. F., Prospecting and Operating Small Gold Placers, New York: Wiley, 1936, 144pp,
- Clifton, Hunter, Swanson and Phillips, 'Sample Size and Meaningful Gold Analysis', 1969, U.S. Geol. Survey Prof. Paper 625-C.
- Fisher, R.P., and Fischer, F.S., 'Interpreting Pan Concentrate Analysis of Stream Sediments in Geochemical Exploration for Gold', 1970, U.S. Geol. Survey Circ. 592, 9pp.
- Francis, T.G., 'So you want to do some mining (Alluvial Mining of Gold and Tin: Hints on Equipment used)', 1977, Brisbane: Queensland Govt. Min. Journal 78/914, p.601-604.
- Gold Extraction for the Small Operator, 2nd Ed. 103pp (London- Imperial Chemical Industries Ltd., 1943.)
- Griffiths, S.V., Alluvial Prospecting and Mining, 1960, New York: Pergamon Press Inc., 245pp.
- Haffty, Riley and Goss, A Manual of Fire Assaying and Determination of Noble Metals in Geological Materials, 1977, U.S. Geol. Survey Bull. 1445, 58pp.
- Harrison, H.L.H., Valuation of Alluvial Deposits, London: Mining Publications Ltd., 1954, 308pp.

- Harrison, H.L.H., Alluvial Mining for Tin and Gold, London: Mining Publications Ltd., 1962, 313pp.
- Hawkes, H.E., 'Principles of Geochemical Prospecting', 1957, U.S. Geol. Survey Bull. 1000-F.
- Idriess, I.L., Prospecting for Gold, New York: McGraw-Hill Co., 359pp.
- Lock, C.G.W., Practical Gold-Mining, (London: E & F N Spon, 1889) 788pp, figs., photos., refs.
- McGowan, A., Plans for Building a Portable Gold Rocker. United Prospectors, 166 West High Street, Benicia, CA 94510,
- McGowan, A., The New Method of Gold Mining, Gold Rush, P. O. Box 1882, Newport Reach, CA 94510,
- McGowan, A., The Extraction of Free Gold, 1973, Carson Enterprises, 801 Juniper Avenue, Boulder, CO 80302.
- McLellan, Berkenkotter, Wilmont and Stahl, Drilling and Sampling Tertiary Gold Placer in Nevada County, California, U.S. Bureau Mines Rept. Inv. 7935, 50pp.
- Moen W.S., and Hunting, M.T., Handbook for Gold Prospectors in Washing, 1975, Washington Dept. Nat. Resources, Div. Geol. and Earth Resources Inform. Circ. 57.
- Mineral Information Service of California, Elementary Placer Mining Methods, San Francisco, 10, Aug. 1 1957, 1-7.
- Mineral Information Service of California, Prospecting, Exploring and Developing the Small Mine, San Francisco, 11, Dec. 1958, 1-6.
- Mines Geol., Special Publications Division, Basic Placer Mining, No. 41 16pp.
- Montana School of Mines, 'Placer Mining Workshop', Butte, June 29-30, 1974.

- Taylor, Prisbrey, Green and Hoskins, The Design, Economics, Mining and Metallurgy of Small Scale Gold and Silver Recovery Operations, 1980, Dept. of Mining and Metallurgy, College of Mines, Univ. Idaho, Moscow, Idaho.
- Powers, T. W., Economic Processes for the Recovery of Gold and Silver, 1980, Dept. of Mining and Metallurgy, College of Mines, Univ. Idaho, Moscow, Idaho.
- Powers, T.W., Tabling Gold Ores. T. Powers, P. O. Box 585, Hilmar, CA 95324,
- Raeburn, C., and Milner, H.B., Alluvial Prospecting: The Technical Investigation of Economic Alluvial Minerals. London: Thos. Murby & Co., and New York: D. van Nostrand Co., 1927, 478pp.
- Wells, J.H., Placer Examination, Principles and Practice, 1973, Bur. Land Management Tech. Bull. 4, 209pp.
- West, J., How to Mine and Prospect for Placer Gold, 1971, U.S. Bureau Mines Inf. Circ. 8517.
- Wolff, E., Handbook for the Alaskan Prospector, 1969, Mineral Ind. Research Lab., Univ. Alaska.