

➔ **Chipping - Course: Technique for manual working of materials. Trainees' handbook of lessons (Institut für Berufliche Entwicklung, 15 p.)**

(introduction...)

- 1. Purpose of chipping**
- 2. Tools and auxiliary tools for chipping**
- 3. Protective means**
- 4. Operation and techniques of chipping**
- 5. Labour safety recommendations**



[Home](#) > [ar.cn.de.en.es.fr.id.it.ph.po.ru.sw](#)

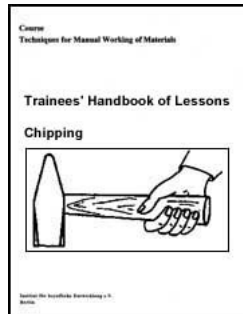

➔ **Chipping - Course: Technique for manual working of materials. Trainees' handbook of lessons (Institut für Berufliche Entwicklung, 15 p.)**

(introduction...)

- 1. Purpose of chipping**
- 2. Tools and auxiliary tools for chipping**
- 3. Protective means**
- 4. Operation and techniques of chipping**
- 5. Labour safety recommendations**

Institut für berufliche Entwicklung e.V.

Berlin

**Original title:
Arbeitsmaterial fr den Lernenden
"MeiIn"**

Author: Frank Wenghfer

First edition © IBE

**Institut fr berufliche Entwicklung e.V.
Parkstrae 23
13187 Berlin**

Order No.: 90-35-3110/2





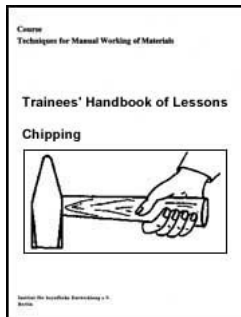

[Home](#) > [ar](#).[cn](#).[de](#).[en](#).[es](#).[fr](#).[id](#).[it](#).[ph](#).[po](#).[ru](#).[sw](#)



 **Chipping - Course: Technique for manual working of materials. Trainees' handbook of lessons (Institut fr Berufliche Entwicklung, 15 p.)**

 **(introduction...)**

-   **1. Purpose of chipping**
-  **2. Tools and auxiliary tools for chipping**
-  **3. Protective means**
-  **4. Operation and techniques of chipping**

 **5. Labour safety recommendations****1. Purpose of chipping**

Chipping is working on materials by a wedge-shaped tool (the chisel) in order to separate or chip material. The cutting effect of the chisel is achieved by hammering on the head end of the chisel, which is an energy and time consuming operation.

Chipping therefore, is useful only if other mechanical working techniques cannot be applied or are not worthwhile.

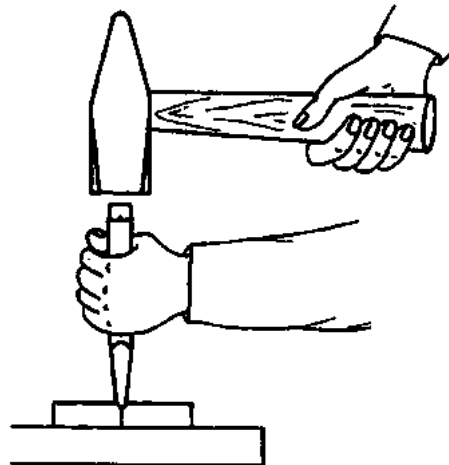
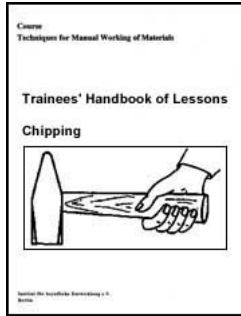

Figure 1 - Chiselling





 **Chipping - Course: Technique for manual working of materials. Trainees' handbook of lessons (Institut fr Berufliche Entwicklung, 15 p.)**

 **(introduction...)**

 **1. Purpose of chipping**

 **➔ 2. Tools and auxiliary tools for chipping**

 **3. Protective means**

 **4. Operation and techniques of chipping**

 **5. Labour safety recommendations**

2. Tools and auxiliary tools for chipping

Main tools are chisels of various kinds. They are made of unalloyed tool steel carbon content (0.9 %). The cutting part is hammered, hardened, ground and tempered (HRC 48). The head of the chisel is unhardened, chamfered towards the upper end and rounded.

Chisels are chosen according to the respective task as well as hardness of material of the workpiece:

- Flat chisel

Most common chisel for separating and chipping with straight, broad cutting edge.

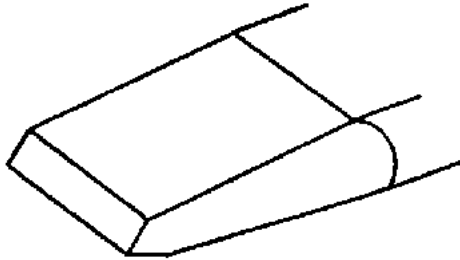

Figure 2 - Flat chisel

- Round chisel

Special chisel for chiselling out big holes or separating curved forms. This chisel has an arched cutting edge.

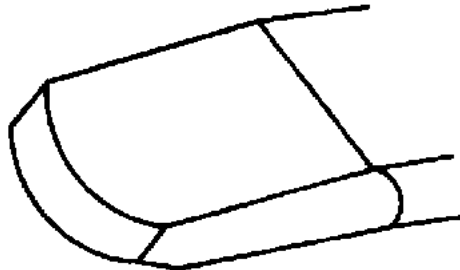

Figure 3 - Round chisel

- Cross-cut chisel

Chisel for chiselling out horizontal grooves or for separating webs in boring lines. The cutting edge is across the width of the chisel, the side surfaces are hollow-

ground.



Figure 4 - Cross-cut chisel

- Shear tool

Chisel for shearing sheet metal. It has a straight, broad cutting edge which is at level with one flank and the shank of the chisel.

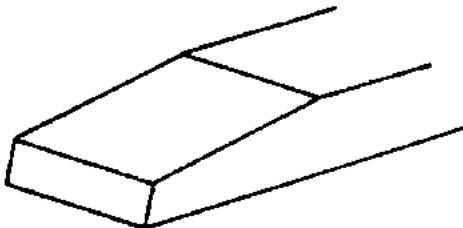

Figure 5 - Shear tool

- Grooving chisel

Chisel for chiselling out grooves in special workpieces (bearing shells). The cutting edge of the chisel is across the shank, the arched back corresponds to the arched forms.

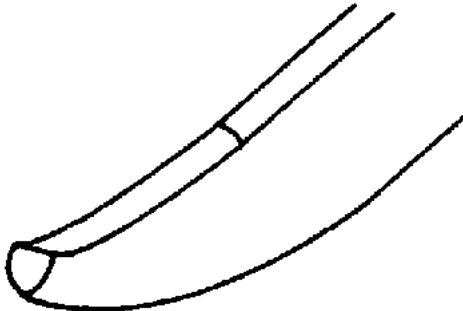

Figure 6 - Grooving chisel

- Cut-out tool

Chisel for cutting out webs with boring lines and drilled deep-holes.

The two cutting edges are hollow-ground; the flanks are relief-ground in order to avoid jamming.

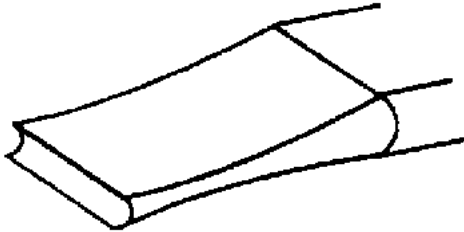

Figure 7 - Cut-out tool

- Hollow punch

Chisel with circular cutting edge for chiselling out holes in thin or soft materials

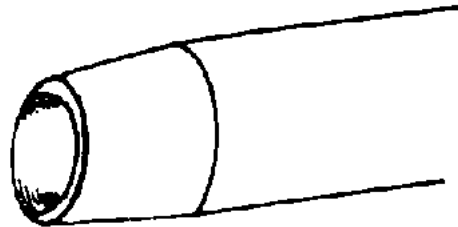

Figure 8 - Hollow punch

The following recommended values apply to the selection of chisels according to the hardness of material:

Constitution of the material	Cutting-wedge angle
Soft (aluminium)	30° - 50°
medium hard (steel)	60°
hard (tool steel)	60° - 70°

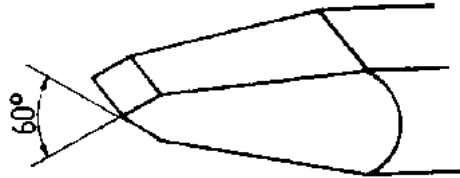

Figure 9 - Cutting-wedge angle at the chisel

When is the technique of chipping applied?

What material are chisels made of?

What aspects have to be considered in choosing chisels?

When do you use a flat chisel?

When do you use a cross-cut chisel?

What cutting-wedge angle shall the cutting edges have for working medium hard steel?

- Hammer

Mostly, hand hammers are used (weight: 400 g); as a general rule:

The hammer should be twice as heavy as the chisel.

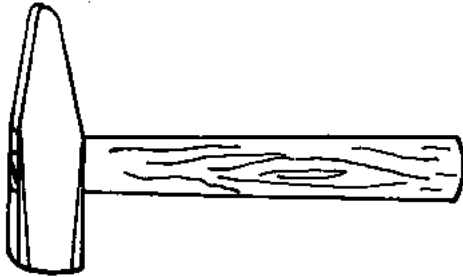

Figure 10 - Hand hammer

- Supports

For absorbing the beating effect, these should be unhardened: steel plates, steel blocks.

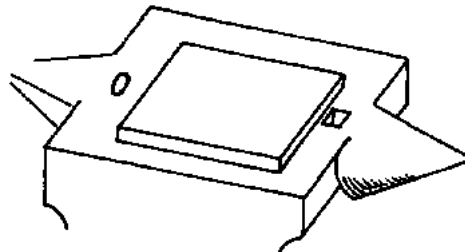

Figure 11 - Anvil with steel support

If the anvil is used, an unhardened intermediate plate is required; when working with the hollow punch, use a wooden support.

Marking-out tables and surface plates must not be used - the chisel edge causes damage

that destroys the even surfaces of the plates.

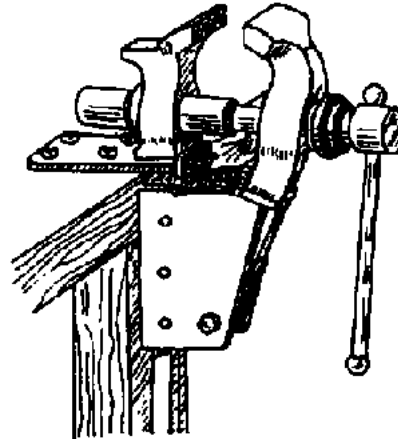

Figure 12 - Collet vice

- Vice

If possible, use a collet vice for clamping smaller parts and work against a rigid counter-support.

Always beat against the fixed jaw of the vice in order to go easy on the screw.



[Home](#) > [ar](#).[cn](#).[de](#).[en](#).[es](#).[fr](#).[id](#).[it](#).[ph](#).[po](#).[ru](#).[sw](#)

 **Chipping - Course: Technique for manual working of materials.**

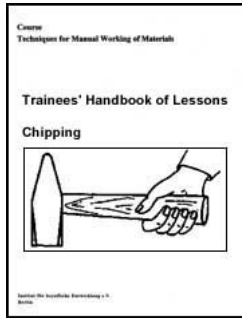

Trainees' handbook of lessons (Institut für Berufliche Entwicklung, 15 p.)

(introduction...)

- 1. Purpose of chipping
- 2. Tools and auxiliary tools for chipping
- ➔ 3. Protective means
- 4. Operation and techniques of chipping
- 5. Labour safety recommendations

3. Protective means

- Protective lattices and guards:

These are placed in beating direction in order to protect fellow workers standing next to the chiselling place against splashing chips.



Figure 13 - Chiselling in front of the safety lattice

- Safety goggles and beating protection:

The eyes are protected by wearing safety glasses.

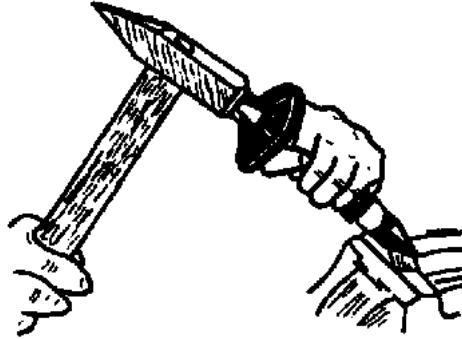

Figure 14 - Chiselling with protective device

A protective device of soft plastic material can be put over the head of the chisel in order to protect the back of the hand against strokes of the hammer that perhaps miss the head of the chisel.

What additional tools and auxiliary means are required for chipping?

What general rule applies to the selection of the hammer?

What qualities must the supports have?

When must marking-out tables and surface plates not be used as supports?

What is the task of protective guards and safety goggles?



[Home](#) > [ar](#) [cn](#) [de](#) [en](#) [es](#) [fr](#) [id](#) [it](#) [ph](#) [po](#) [ru](#) [sw](#)

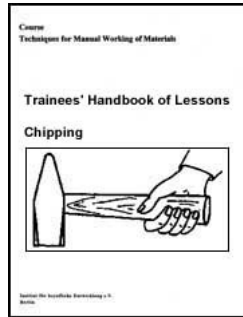

 **Chipping - Course: Technique for manual working of materials. Trainees' handbook of lessons (Institut fr Berufliche Entwicklung, 15 p.)**

 **(introduction...)**

 **1. Purpose of chipping**

 **2. Tools and auxiliary tools for chipping**

 **3. Protective means**

 **➔ 4. Operation and techniques of chipping**

 **5. Labour safety recommendations**

4. Operation and techniques of chipping

As a result of the impact of the hammer hitting the head of the chisel, the impact energy of the hammer is transmitted to the cutting edge thus enabling it to do the cutting work.

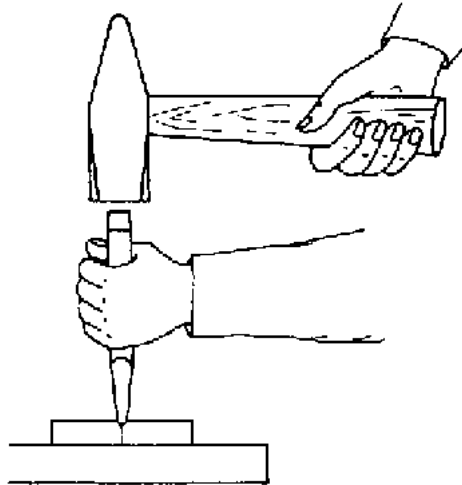

Figure 15 - Chiselling

The strokes of the hammer are directed mainly by the wrist-joint, because this leads to a good accuracy of aim. Harder strokes must be struck out of the shoulder-joint - do not strike the blows out of the upper arm (little accuracy of aim, rapid tiring).

Look at the cutting edge of the chisel in order to watch its effect.

There is a basic difference in holding the chisel with chipping and parting chiselling.

4.1. Chipping chiselling

The chisel has to be applied in a position inclined towards the surface of the workpiece.

The cutting edge penetrates the material and squeezes it.

As a result, a chip is rolled up from the cutting face and sheared off.

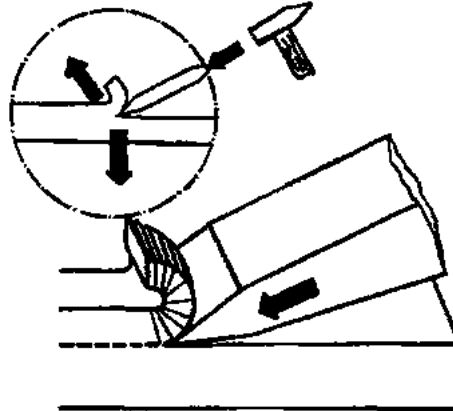

Figure 16 - Position of the chisel when chipping

The angle of inclination is approximately half of the cutting-wedge angle (approx, 30°).

If chips of different thicknesses have to be cut off in order to achieve an even surface, the following has to be observed:

For chips of little thickness hold the chisel steeper (angle of clearance approx. 8°), for thicker chips hold the chisel in a rather flat position (angle of clearance approx. 0°).

Working recommendations

- Thin layers of material at narrow surfaces as well as strips of sheet metal are chiselled off by clamping the workpiece into the vice and holding the chisel in an

inclined position (angle of incidence approx. 45°).

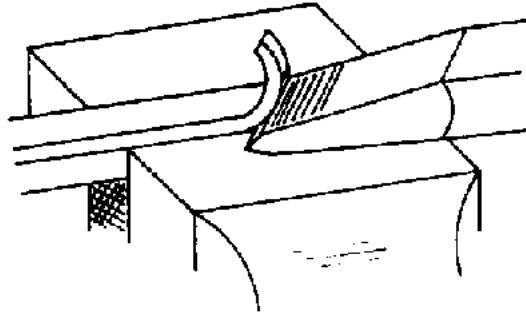

Figure 17 - Chipping of thin layers by a chisel

- Thicker layers have to be removed by several plies, so that the chips roll off more easily.
- Larger surfaces are treated with the cross-cut chisel first which cuts grooves in them. After this, the webs remaining between these grooves are removed with the help of the flat chisel.

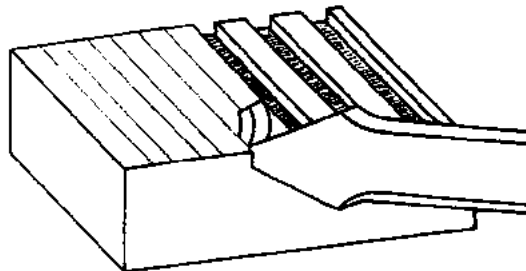

Figure 18 - Chipping of surfaces by a cross-cut chisel

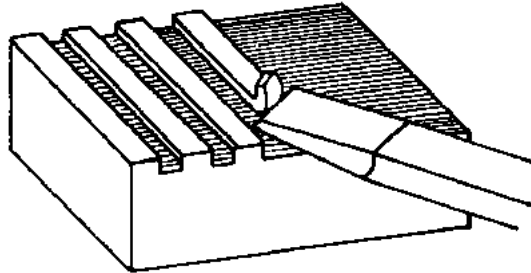

Figure 19 - Chipping of the webs by a flat chisel

How is the chisel applied for the chipping operation?

4.2. Parting chiselling (cutting-off)

The chisel is put vertically on the surface of the workpiece.

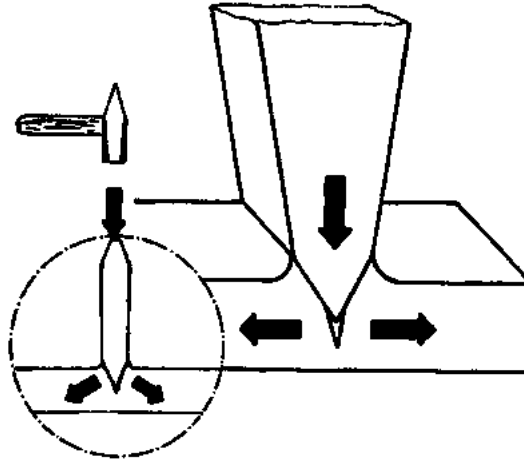

Figure 20 - Position of the chisel when cutting off (parting) material

The cutting edge indents the material, squeezes it to both sides and presses it asunder. By this, the material tears in front of the cutting edge the cutting edge is clear. With further penetration, the workpiece tears asunder.

Working recommendations

- **Thin, flat materials or sheet metal have to be cut off from one side and on a hardened support. The limiting points have to be drilled first.**
- **Thicker parts have to be indented on all sides and then broken.**

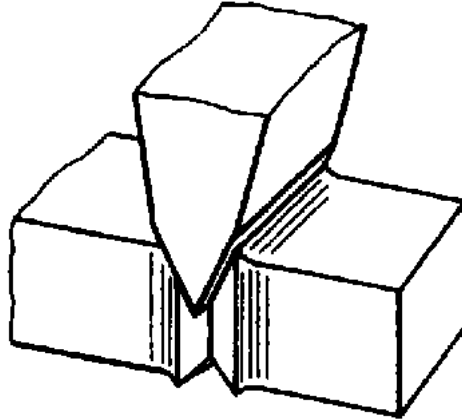

Figure 21 - Indenting of a square bar on all sides for parting it

- Long cutting lines have to be prepared by chiselling a guiding slot.
- Curved contours at thicker workpieces (from 4 mm on) have to be prepared by a bore line the scribing is made with the help of a double-point punch.

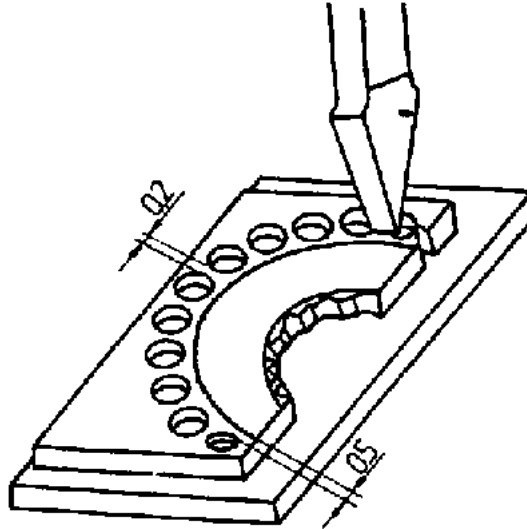

Figure 22 - Drilling and chiselling out of curved contours

The following conditions apply to this:

D = diameter of the drill

y = width of the double-point punch

x = distance of the bore line to the scribed line

$$\mathbf{D = y - 0.2 \text{ mm}}$$

$$x = \frac{D}{2} + 0.5 \text{ mm}$$

The webs between the bore holes are cut by a flat chisel or cross-cut chisel. With thicker workpieces (from 8 mm on), a cut-out tool is to be used.

How is the chisel applied for the parting operation?

How can curved contours be cut out of thicker workpieces?



[Home](#) > [ar](#).[cn](#).[de](#).[en](#).[es](#).[fr](#).[id](#).[it](#).[ph](#).[po](#).[ru](#).[sw](#)

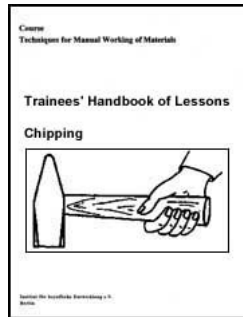

 **Chipping - Course: Technique for manual working of materials. Trainees' handbook of lessons (Institut fr Berufliche Entwicklung, 15 p.)**



(introduction...)



1. Purpose of chipping



2. Tools and auxiliary tools for chipping



3. Protective means



4. Operation and techniques of chipping



5. Labour safety recommendations

5. Labour safety recommendations

- **When chiselling, put up safety lattices or safety guards**
- **Wear safety goggles to protect the eyes.**
- **Do only use chisels that are free from burrs.**

21/10/2011



Chipping - Course: Technique for man...