

[Home](#) > [ar.cn.de.en.es.fr.id.it.ph.po.ru.sw](#)

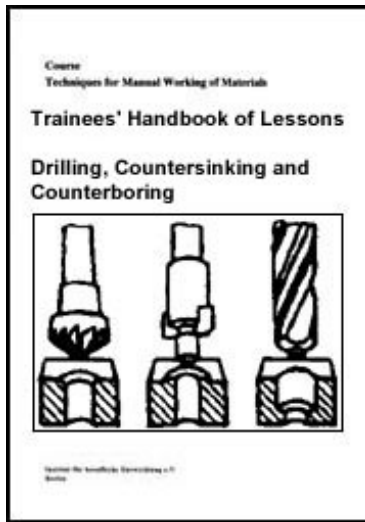

➔ **Driling, Countersinking and Counterboring - Course: Technique for manual working of materials. Trainees' handbook of lessons (Institut fr Berufliche Entwicklung, 18 p.)**

➔ **(introduction...)**

- ➔ **1. Purpose of drilling**
- ➔ **2. Machines for drilling**
- ➔ **3. Tools for metal drilling**
- ➔ **4. The operation of drilling**
- ➔ **5. Setting of the tools**
- ➔ **6. Clamping of the tools**
- ➔ **7. Clamping of the workpieces**
- ➔ **8. Technological process of drilling**
- ➔ **9. Purpose and application of counterboring/countersinking**
- ➔ **10. Labour safety recommendations**











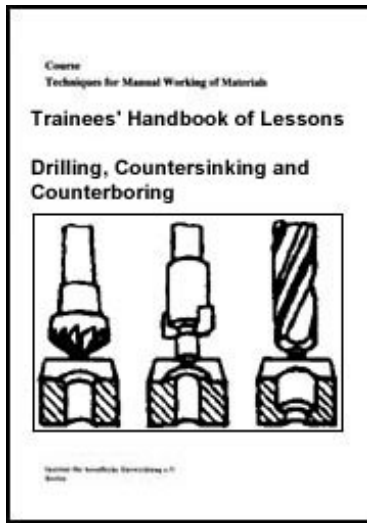

[Home](#) > [ar.cn.de.en.es.fr.id.it.ph.po.ru.sw](#)

➔ **Driling, Countersinking and Counterboring - Course: Technique for manual working of materials. Trainees' handbook of lessons (Institut fr Berufliche Entwicklung, 18 p.)**

➔ **(introduction...)**

- ➔ **1. Purpose of drilling**



-  **2. Machines for drilling**
-  **3. Tools for metal drilling**
-  **4. The operation of drilling**
-  **5. Setting of the tools**
-  **6. Clamping of the tools**
-  **7. Clamping of the workpieces**
-  **8. Technological process of drilling**
-  **9. Purpose and application of counterboring/countersinking**
-  **10. Labour safety recommendations**

**Institut fr berufliche Entwicklung e.V.
Berlin**

**Original title:
Arbeitsmaterial fr den Lernenden
"Bohren und Senken"**

Author Frank Wenghfer

First edition © IBE

**Institut fr berufliche Entwicklung e.V.
Parkstrae 23
13187 Berlin**

Order No.: 90-35-3107/2



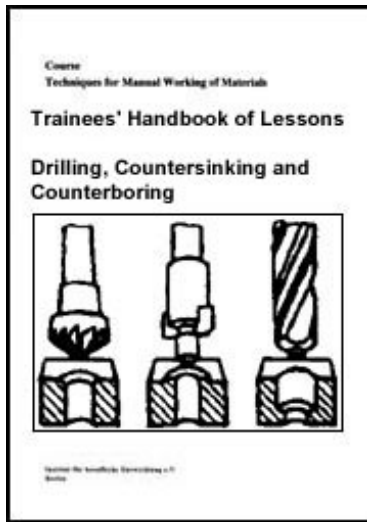

 **Driling, Countersinking and Counterboring - Course: Technique for manual working of materials. Trainees' handbook of lessons (Institut fr Berufliche Entwicklung, 18 p.)**

 **(introduction...)**

 **1. Purpose of drilling**

 **2. Machines for drilling**

 **3. Tools for metal drilling**

 **4. The operation of drilling**

 **5. Setting of the tools**

 **6. Clamping of the tools**

 **7. Clamping of the workpieces**

 **8. Technological process of drilling**

 **➔ 9. Purpose and application of counterboring/countersinking**

 **10. Labour safety recommendations**

9. Purpose and application of counterboring/countersinking

By counterboring/countersinking, bore holes are deburred, precast or predrilled holes are enlarged or their rims worked in such way a that screwed or riveted joints can be made.

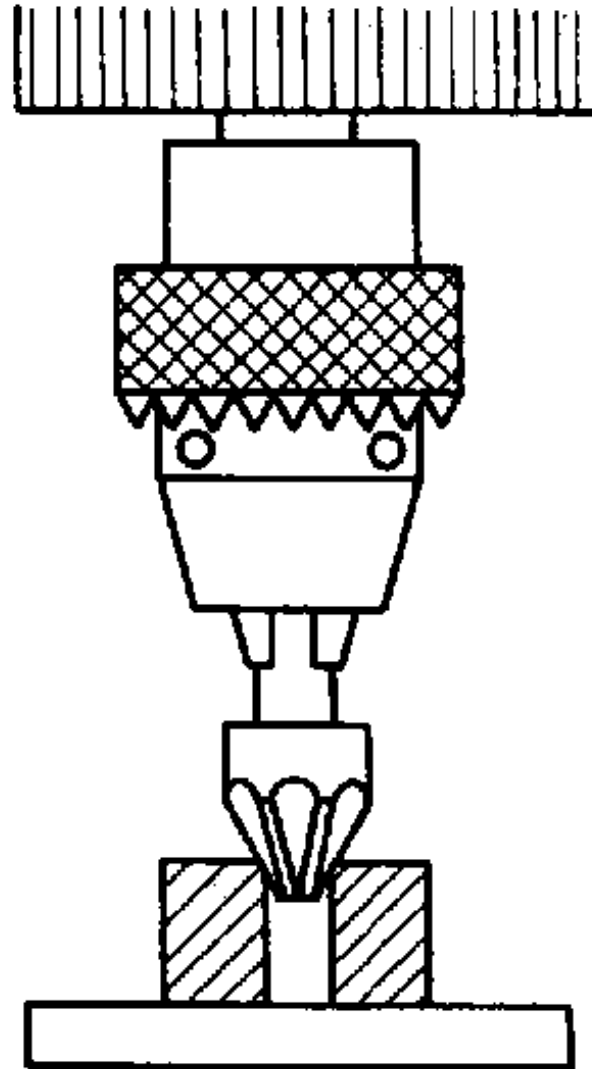

Figure 16 - Counterboring/counter sinking

For this purpose, attention has to be paid to the following:

- Before counterboring/counter sinking, the bore hole must be brought in line with the working spindle.**

- Work at a low rotational speed (approximately 350 r.p.m.), otherwise there will be uneven surfaces.

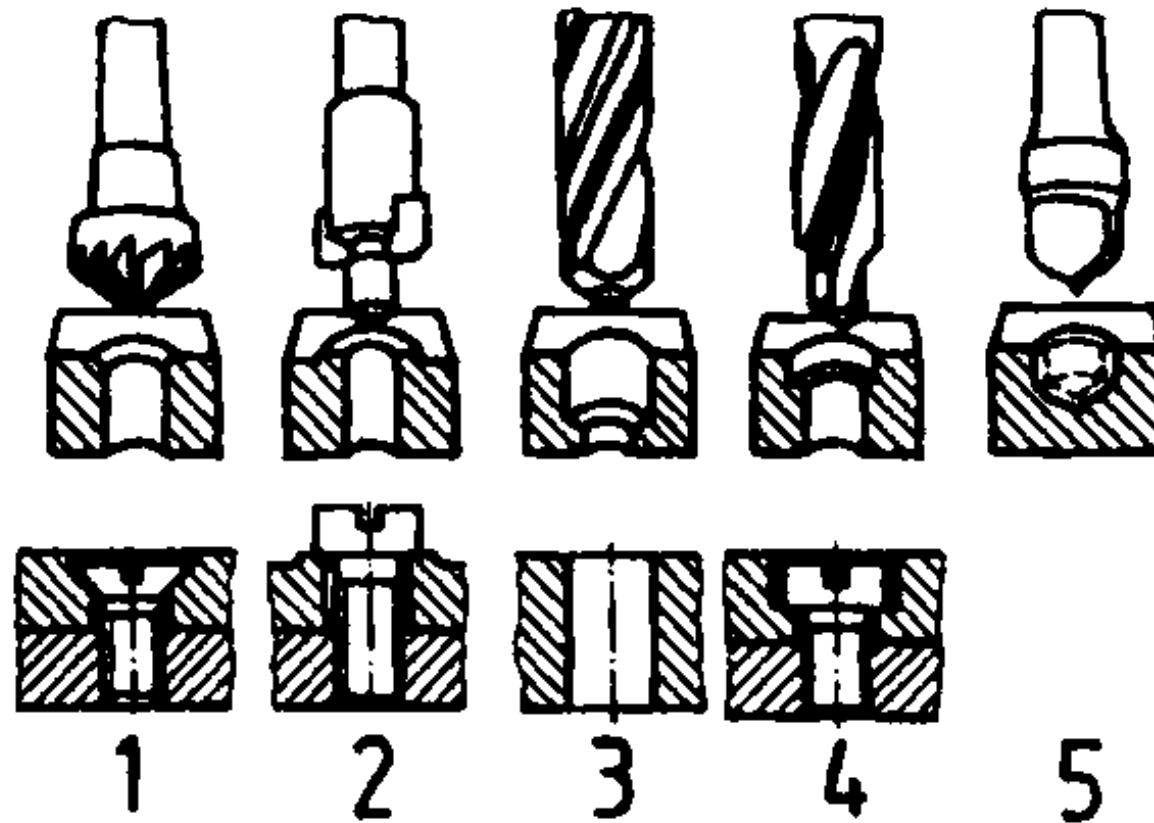

Figure 17 - Types of counterbores/countersinks

- 1 - Countersinking cutter (60°; 75°; 90°)**
- 2 - Flat countersink**
- 3 - Counterbore with spiral flutes**
- 4 - Counterboring tool with pilot or spot facer**
- 5 - Form counterbore (special forms)**

9.1. Use of the counterbores/countersinks

- **Countersinking cutter 60°:**

Spot-facing of bore holes in which threads shall be cut (Nominal measurement: $D_S = N$)

- **Countersinking cutter 75°:**

Spot-facing of bore holes for countersunk-head rivets

- **Countersinking cutter 90°:**

Spot-facing of bore holes that shall be reamed (Nominal measurement: $D_S = N + 0.2$ mm) as well as spot-facing of bore holes in which countersunk screws shall be fitted

- **Flat countersink**

Spot-facing of flat seating faces for screws on uneven surfaces

- **Counterbore with spiral flutes:**

Boring of predrilled holes by a small measure (Example: from 8 mm to 10 mm)

- **Counterboring tool with pilot or spot facer:**

Spot-facing of cylindrical screw head location. Pay attention to the guiding clearance of the pilot of 0.05 mm - 0.1 mm. (Also possible by a drill with flat drill point and centre point),

- Form counterbore:

Deburring and forming of irregular or curved pockets; for this purpose, also rotary files or small form cutters are used.

What has to be taken into consideration when counterboring/countersinking?

When do you use a 90° countersinking cutter?

What are the fields of application of form counterbores?



[Home](#) > [ar](#).[cn](#).[de](#).[en](#).[es](#).[fr](#).[id](#).[it](#).[ph](#).[po](#).[ru](#).[sw](#)

 **Driling, Countersinking and Counterboring - Course: Technique for manual working of materials. Trainees' handbook of lessons (Institut fr Berufliche Entwicklung, 18 p.)**

 **(introduction...)**

 **1. Purpose of drilling**

 **2. Machines for drilling**

 **3. Tools for metal drilling**

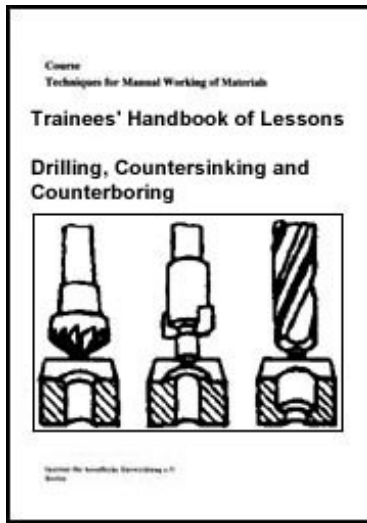

4. The operation of drilling
5. Setting of the tools
6. Clamping of the tools
7. Clamping of the workpieces
8. Technological process of drilling
9. Purpose and application of counterboring/countersinking
- ➔ 10. Labour safety recommendations

10. Labour safety recommendations

- Wear close-fitting clothes and head shield, if necessary, safety glasses, too.
- Only one person must work at a machine - otherwise there is the danger of being distracted.
- Always do the cleaning and setting work with the machine switched off.
- Secure the workpieces safely against twisting and being pulled up.
- Do not remove any chips with bare hands, but with the help of suitable auxiliary means (such as short hooks or metal rods).
- Leave the machine only when it is at rest.



[Home](#) > [ar](#).[cn](#).[de](#).[en](#).[es](#).[fr](#).[id](#).[it](#).[ph](#).[po](#).[ru](#).[sw](#)

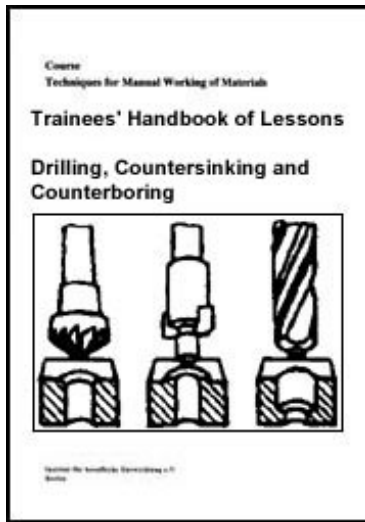

Driling, Countersinking and Counterboring - Course: Technique for manual working of materials. Trainees' handbook of lessons (Institut fr Berufliche Entwicklung, 18 p.)

 ***(introduction...)***

-   **1. Purpose of drilling**
-  **2. Machines for drilling**
-  **3. Tools for metal drilling**
-  **4. The operation of drilling**
-  **5. Setting of the tools**
-  **6. Clamping of the tools**
-  **7. Clamping of the workpieces**
-  **8. Technological process of drilling**
-  **9. Purpose and application of counterboring/countersinking**
-  **10. Labour safety recommendations**

1. Purpose of drilling

By drilling, cylindrical recesses or break-throughs are cut out of workpieces.

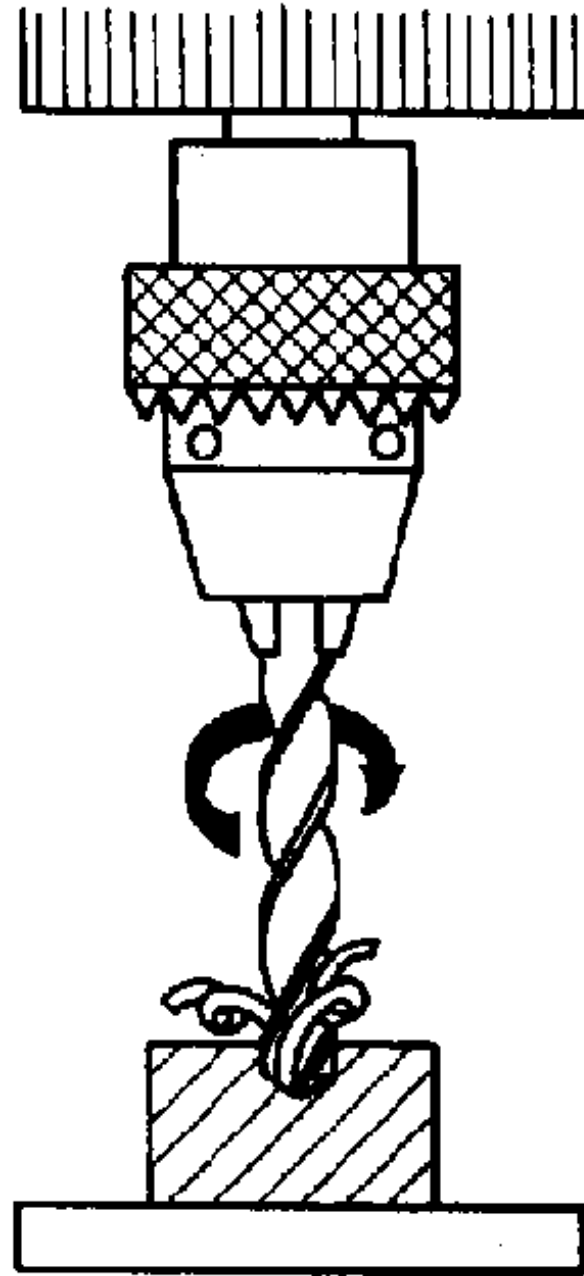

Figure 1 - Drilling

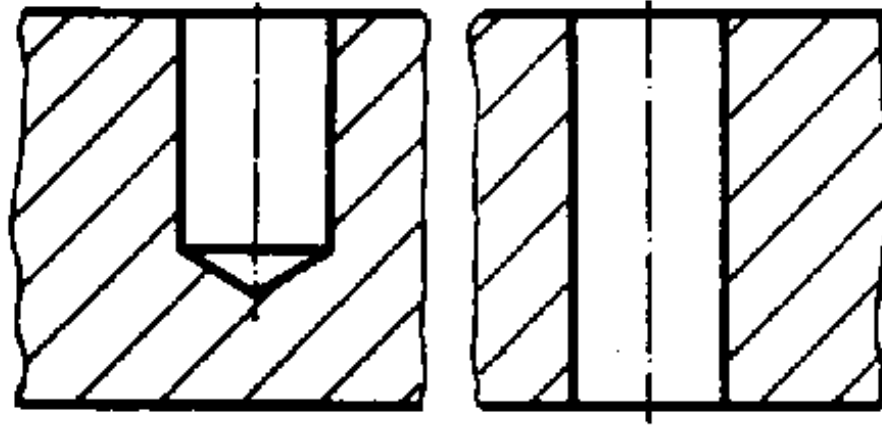

Figure 2 - Blind hole and through hole

It is necessary if

- **screw joints**
- **pin joints**
- **riveted joints**
- **passages for fluids and gas**

shall be made and if cylindrical machine parts shall be guided or carried.



[Home](#) > [ar](#).[cn](#).[de](#).[en](#).[es](#).[fr](#).[id](#).[it](#).[ph](#).[po](#).[ru](#).[sw](#)

 **Driling, Countersinking and Counterboring - Course: Technique for manual working of materials. Trainees' handbook of lessons (Institut fr Berufliche Entwicklung, 18 p.)**

 **(*introduction...*)**



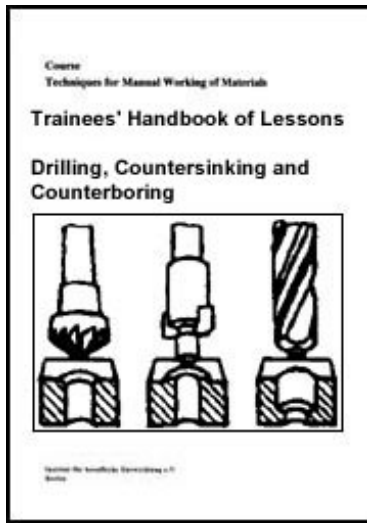

- ➔ **1. Purpose of drilling**
- 2. Machines for drilling**
- 3. Tools for metal drilling**
- 4. The operation of drilling**
- 5. Setting of the tools**
- 6. Clamping of the tools**
- 7. Clamping of the workpieces**
- 8. Technological process of drilling**
- 9. Purpose and application of counterboring/countersinking**
- 10. Labour safety recommendations**

2. Machines for drilling

In the field of maintenance and repair, simple bench-type drilling machines, upright drilling machines and portable electrodrills are used. In modern production plants, multi-spindle drilling machines, boring mills as well as numerically controlled machines are used, also turning machines and automatics.



[Home](#) > [ar](#).[cn](#).[de](#).[en](#).[es](#).[fr](#).[id](#).[it](#).[ph](#).[po](#).[ru](#).[sw](#)

 **Driling, Countersinking and Counterboring - Course: Technique for manual working of materials. Trainees' handbook of lessons (Institut fr Berufliche Entwicklung, 18 p.)**

 **(introduction...)**

 **1. Purpose of drilling**

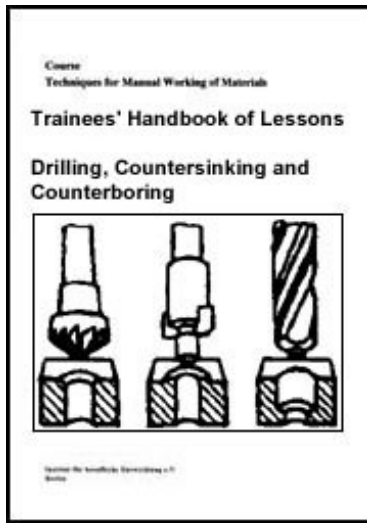

- ➔ 2. Machines for drilling
- 3. Tools for metal drilling
- 4. The operation of drilling
- 5. Setting of the tools
- 6. Clamping of the tools
- 7. Clamping of the workpieces
- 8. Technological process of drilling
- 9. Purpose and application of counterboring/countersinking
- 10. Labour safety recommendations

3. Tools for metal drilling

There are various kinds of drills:

Drills type "hard"

They are used for materials harder than steel, for instance chromium-nickel alloys, cast steel and alloyed steels of a tensile strength of more than 500 MPa

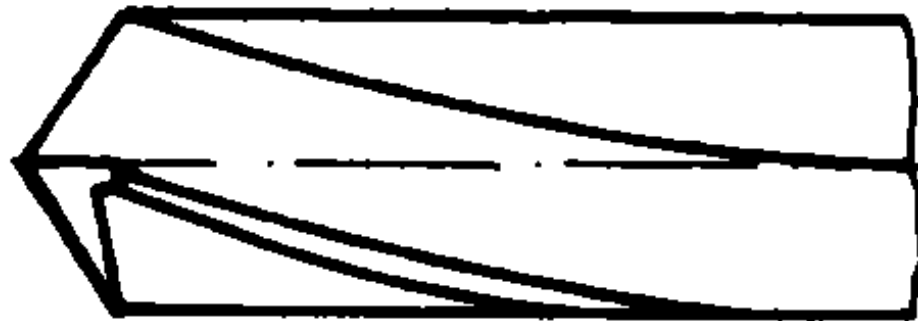

Figure 3 - Drill type "hard"

Drills type "normal"

Application with general-purpose constructional steel, low-alloy steels, cast iron

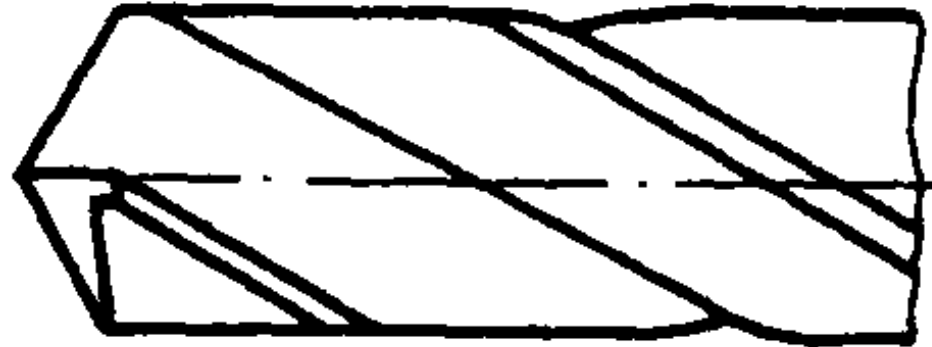

Figure 4 - Drill type "normal"

Drills type "soft"

Used for materials softer than steel such as long-chip aluminium alloys, copper, zinc, plastics, a number of compression moulding materials

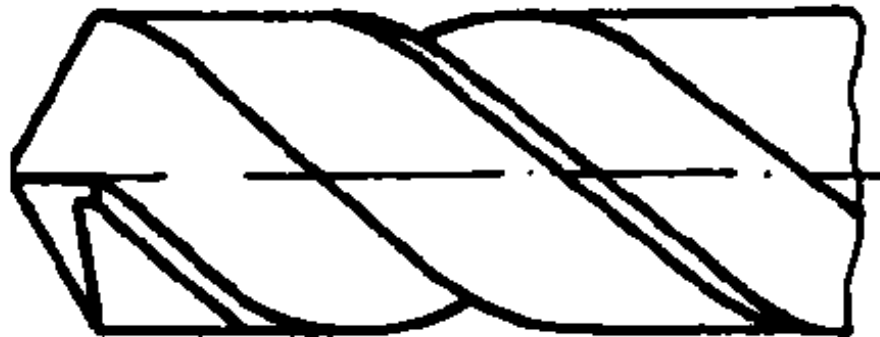

Figure 5 - Drill type "soft"

Drills with cemented carbide tips

Used with very hard and resistant materials as well as natural materials (such as stone, concrete, ceramics, glass)

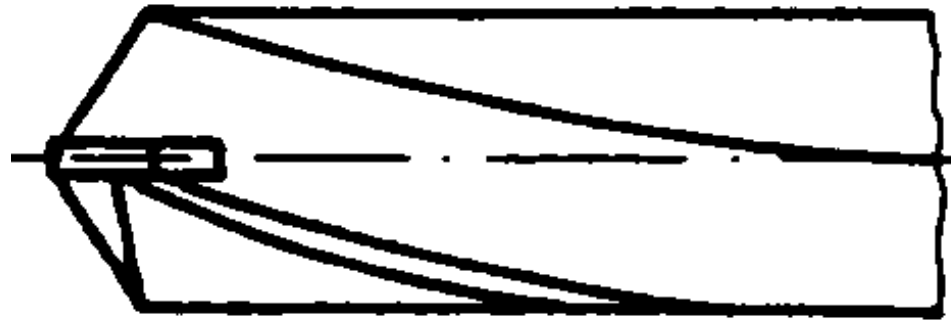

Figure 6 - Drill with cemented carbide tips

3.1. Construction and drill point of a drill type "normal"

This type of drill is the most common tool for drilling of steel:

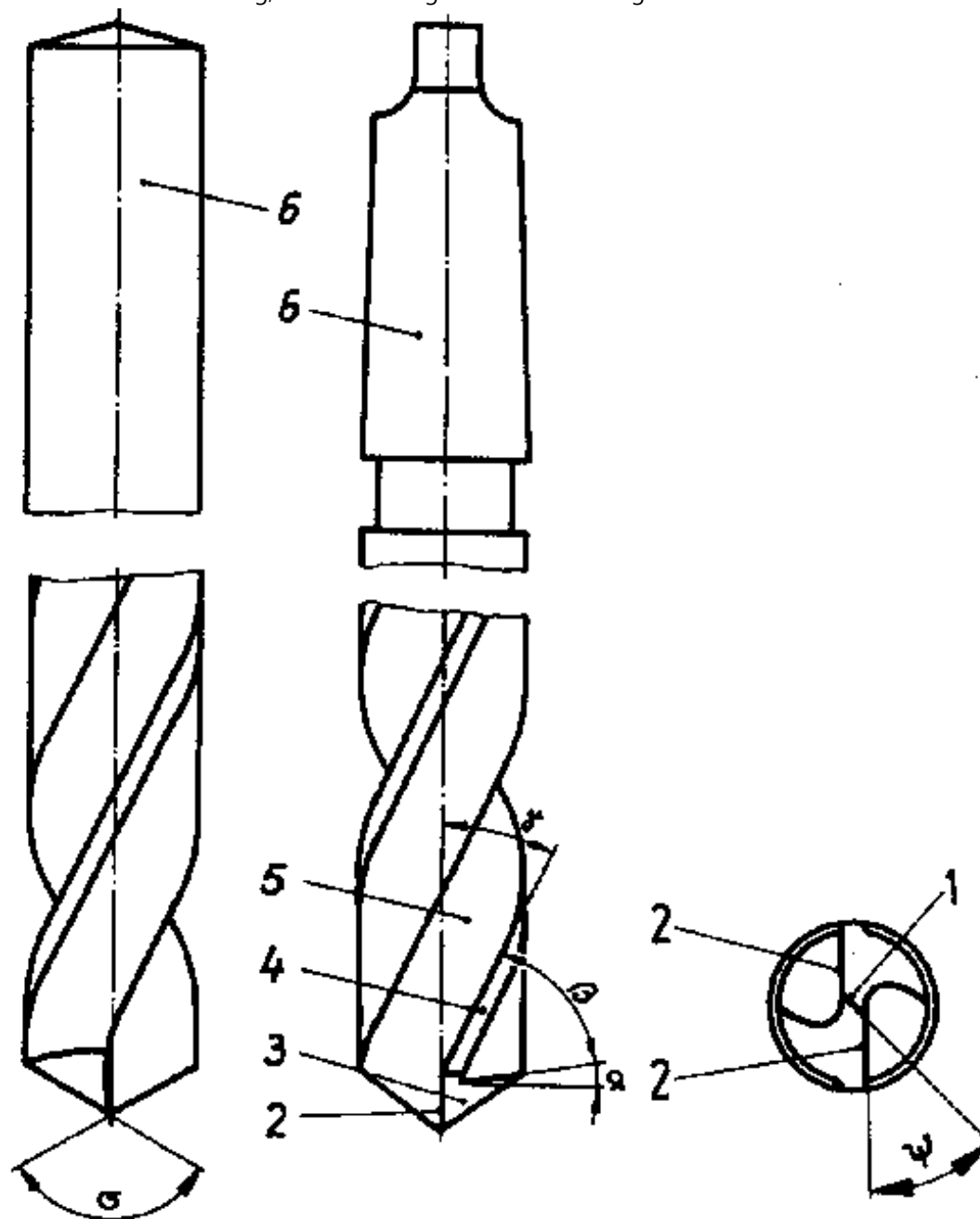

Figure 7 - Construction of the drill type "normal"

1 chisel edge

 α - lip relief angle ($4^\circ - 6^\circ$)2 principal cutting edges β - lip angle

3 flanks

 γ - rake angle (25°)

4 land

 δ - point angle ($116^\circ - 118^\circ$)

5 helical flute

 ψ - complementary angle of the chisel edge angle (55°)

6 shank

The chisel edge is an edge at the point of the drill. It presses and squeezes the material in the bore hole and, in doing so, consumes approximately one third of the thrust.

Therefore, larger bore holes are predrilled with smaller drills (according to the length of the chisel edge of the big drill) or the drill is equipped with a laterally sharpened chisel edge. The principal cutting edges do the actual chipping work; they must always be sharp and provided with a flank (behind the cutting edges), so that these cutting edges have the effect of a wedge.

The land is in contact with the bore hole wall; due to its narrowness, there is only a little friction during the boring process and a good guidance of the drill (no walking off centre) is achieved.

The helical flute transports the chips out of the bore hole and, at the same time, enables the lubricating and cooling agent to reach the point of the drill.

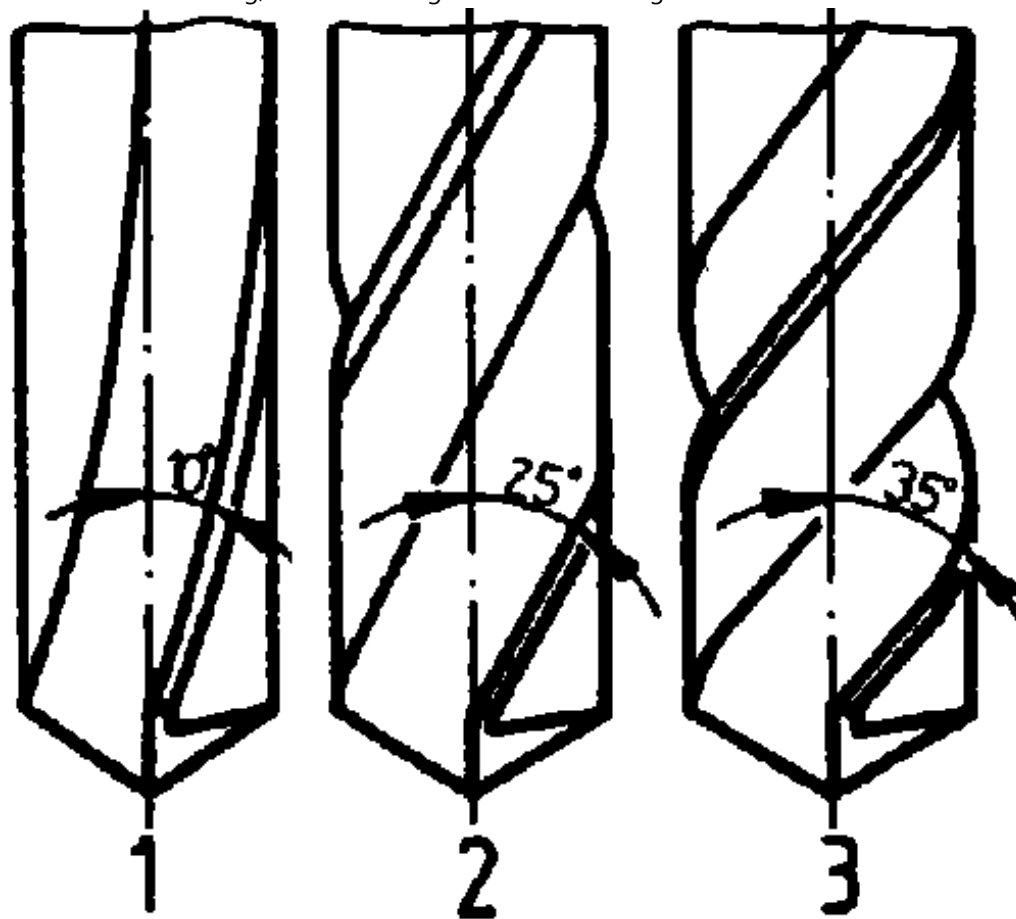

Figure 8 - Comparison of the rake angles

- 1 Drill type "hard",
- 2 Drill type "normal",
- 3 Drill type "soft"

The three types of drills are distinguished by the rake angle, which determines the slope of the helical flute (type "hard" - 15°; type "soft" - 35°).

The shank - with drills of diameters up to 10 mm - is normally cylindrical, with

diameters of more than 10 mm it is conical, because with these drills, the very strong power transmission is effected through the favourable reception of the taper sleeve in the machine.

3.2. Special drill point

In addition to the type of drill, the drill point can be different with hard or soft materials in order to achieve a good chip removal:

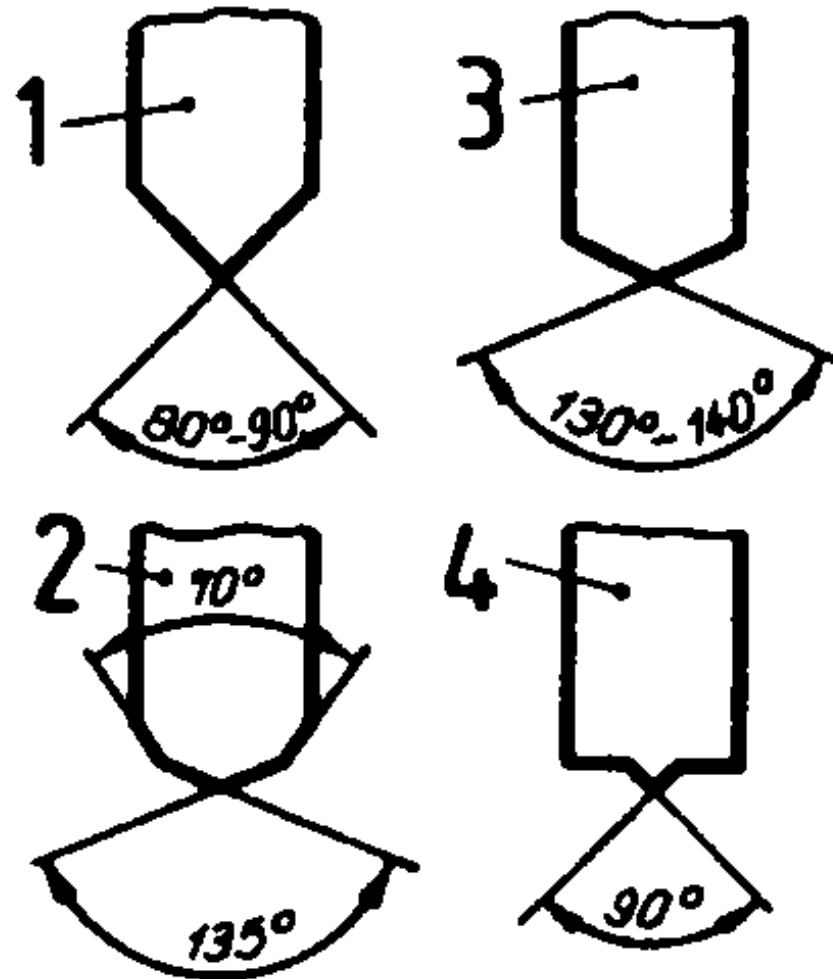

Figure 9 - Special drill points

With hard materials

- Point angle $80^\circ - 90^\circ$ (1) or double-cone drill point (2)

With soft materials

- Point angle 130° - 140° (3) or flat drill point with centre point (4)

For drilling of thin sheet metal, too, the drill with “flat drill point and centre point” is used in order to prevent the bore hole from tearing out. This drill may also be used for cylindrical counterboring instead of a counterboring tool with pilot.

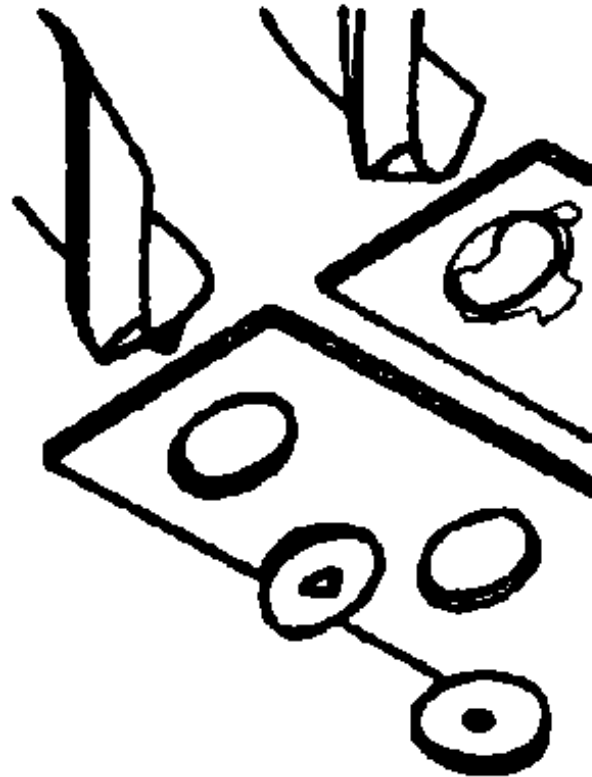

Figure 10 - Use of the drill with “flat drill point and centre point” for thin sheet metal

What kinds of drills are there?

When do you use the "normal" type of drill?

What main parts does the drill consist of?

What is the disadvantage of the chisel edge and how can it be compensated for?

Which kinds of drill points are recommendable for drilling hard materials?

Which kinds of drill points are recommendable for drilling soft materials?

What fields of application are there for the use of the drill with "flat drill point and centre point"?



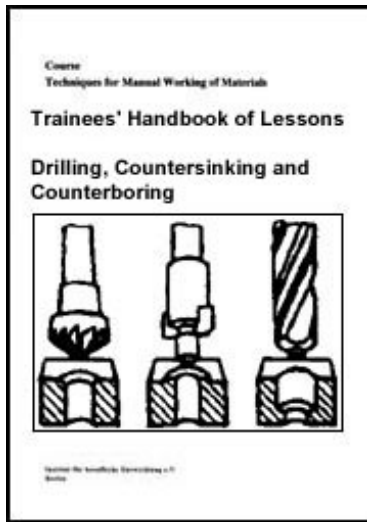

Drilling, Countersinking and Counterboring - Course: Technique for manual working of materials. Trainees' handbook of lessons (Institut fr Berufliche Entwicklung, 18 p.)

 **(introduction...)**

 **1. Purpose of drilling**

 **2. Machines for drilling**

 **3. Tools for metal drilling**

  **4. The operation of drilling**

 **5. Setting of the tools**

 **6. Clamping of the tools**

 **7. Clamping of the workpieces**

 **8. Technological process of drilling**

 **9. Purpose and application of counterboring/countersinking**

 **10. Labour safety recommendations**

4. The operation of drilling

The removal of chips is effected by the combination of the feed and the rotary motion. The rotary motion can be made by the tool or by the workpiece (the latter being the case when drilling by turning machines). The chips are removed by the principal cutting edges only. This is done at the bottom of the drilled hole. For this purpose, the material of the drill roust be harder than that of the workpiece to be drilled.

By the friction in the bore hole, tool and workpiece are heated up. Too strong heating

up leads to a loss of hardness Of the drill. Therefore, a suitable lubricating and cooling agent must be used. The best suitable agents are hydrated fluids with soap or oil constituents.

When the water evaporates, it absorbs great quantities of heat, the rest of the constituents enables a reduction of the friction and smooth bore hole walls.



Figure 11 - Operation of drilling

By drilling, only roughing quality of the wall of the bore hole and a dimensional

accuracy of 0.05 to 0.1 mm is achieved, more accurate bore holes must be reamed afterwards.

4.1. Materials of the drills

In general, drills consist of tool steel, high-speed steel and super high-speed steel. In addition, the cutting edges can be tipped with cemented carbide tips.

Development trends

Modern drills, as to their hardness, are influenced further by techniques such as nitrogen freezing hardening and various coating techniques (evaporation coating with titanium nitride).

Also, drills of a combination of metallic and ceramic materials are being developed.

All these changes result in a considerably wider field of application and longer service life of the drills under the special conditions of modern production.

Even after resharpening of the cutting edges (due to abrasion), these tools are still more efficient than traditional drills.



Home > [ar.cn.de.en.es.fr.id.it.ph.po.ru.sw](#)

 **Drilling, Countersinking and Counterboring - Course: Technique for manual working of materials. Trainees' handbook of lessons (Institut für Berufliche Entwicklung, 18 p.)**

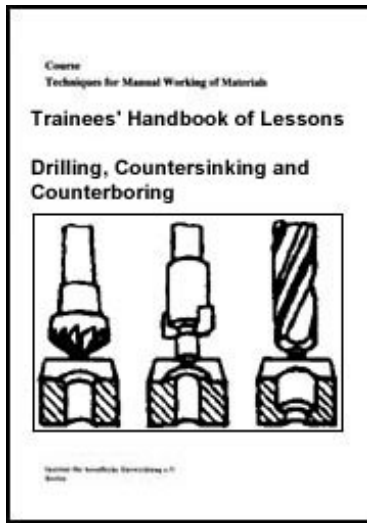

- (introduction...)**
1. Purpose of drilling
 2. Machines for drilling
 3. Tools for metal drilling
 4. The operation of drilling
 - ➔ 5. Setting of the tools
 6. Clamping of the tools
 7. Clamping of the workpieces
 8. Technological process of drilling
 9. Purpose and application of counterboring/countersinking
 10. Labour safety recommendations

5. Setting of the tools

At bench-type and upright drilling machines, the 'rotational speed' and - with modern types - the 'cutting speed' and 'feed' must be set.

The rates of 'rotational speed', 'cutting speed' and 'feed' depend on the material to be drilled and the diameter of the drill.

To automatic feeds the following rules apply:

Low feed rate - with high rotational speed and hard material

High feed rate - with low rotational speed and soft material

The automatic feed is not required for making smaller bore holes (up to 12 mm dia.)

The cutting speed for drilling without automatic feed can be fixed at 22 m/min. Thus,

the following rotational speeds apply:

Materials	Diameter of the drill in mm (Range)					
	1 - 3	3 - 5	5 - 8	8 - 10	10 - 12	12 - 16
Soft materials (aluminium, copper)	7100 to 4500	5600 to 3500	3500 to 2200	2800 to 1800	2200 to 1400	1800 to 1100
Medium hard steels cast steel	2800 to 1800	2200 to 1400	1400 to 900	1100 to 700	900 to 560	710 to 450
hard materials (chromium-nickel alloys)	350	350	350	350	280	220

The following rule applies to the setting of the rotational speed:

Low rotational speed - with hard materials and great drill diameters

High rotational speed - with soft materials and small drill diameters

The rotational speed can be calculated with the help of the following formula:

$$n = \frac{v \cdot 1000}{d \cdot \pi}$$

n = rotational speed (in r.p.m.)

v = cutting speed (in m/min)

d = diameter of the rotating piece (in mm)

π = 3.14

Calculating example

What rotational speed has to be set if a bore hole of 10 mm shall be drilled into a workplace of steel on a bench-type drilling machine with feed by hand?

$$n = \frac{22 \cdot 1000}{10 \cdot 3.14} = \frac{2200}{3.14} = 700 \text{ r.p.m.}$$

Exercise

What rotational speed has to be set if a bore hole of 5 mm dia. shall be drilled into a workpiece of steel by a bench-type drilling machine with hand feed?

Compare the result with the value of the table:

Calculated value	Value indicated in the table



Home > [ar.cn.de.en.es.fr.id.it.ph.po.ru.sw](#)

 **Driling, Countersinking and Counterboring - Course: Technique for manual working of materials. Trainees' handbook of lessons (Institut fr Berufliche Entwicklung, 18 p.)**

 **(introduction...)**

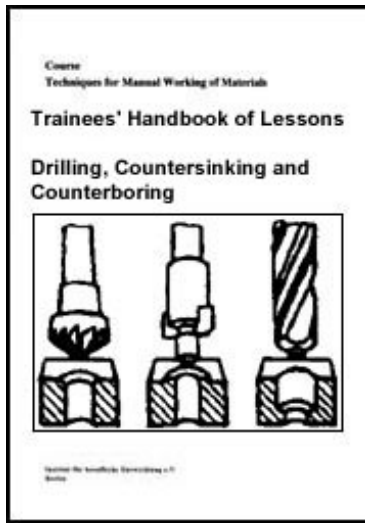

1. Purpose of drilling
2. Machines for drilling
3. Tools for metal drilling
4. The operation of drilling
5. Setting of the tools
- ➔ 6. Clamping of the tools
7. Clamping of the workpieces
8. Technological process of drilling
9. Purpose and application of counterboring/countersinking
10. Labour safety recommendations

6. Clamping of the tools

According to the size of the drills (type of the shank), the drills are clamped in a three-jaw chuck or in taper sleeve collets. In mass production, quick-change chucks are often used for the drilling machines, which enables the drill to be changed with the machine running.

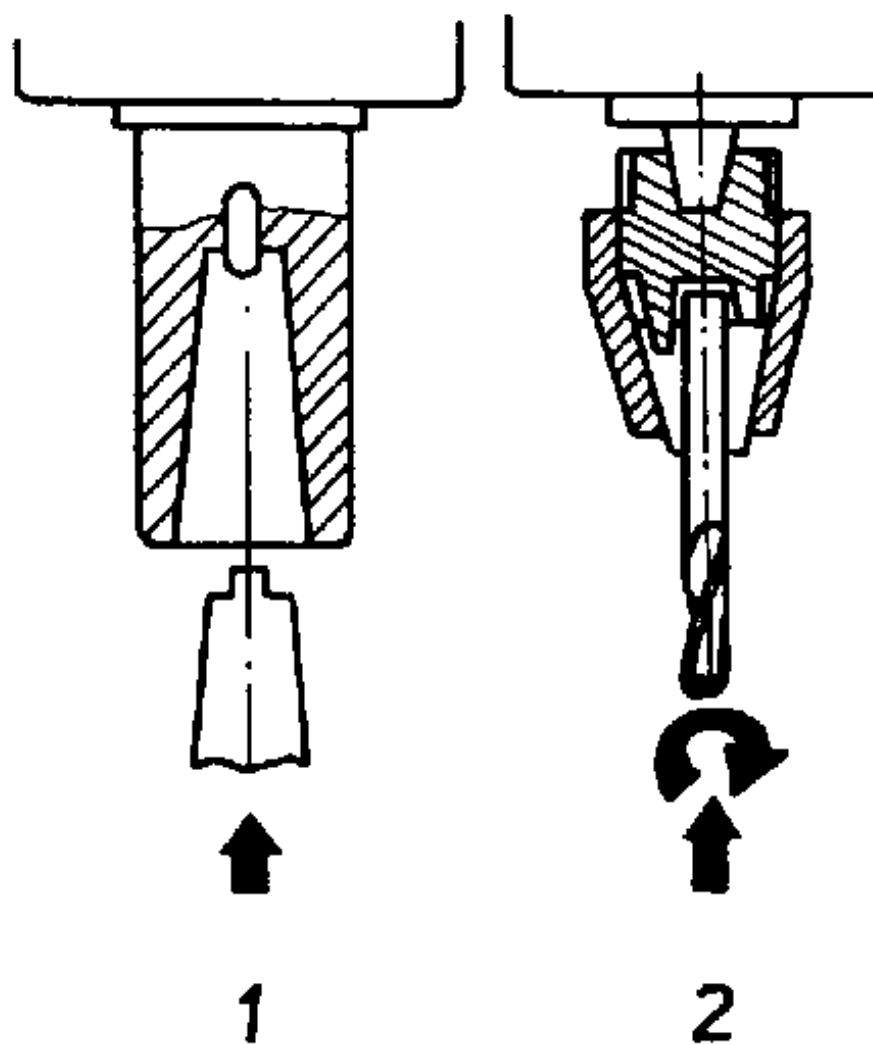

Figure 12 - Tool holding fixtures

1 - taper sleeve

2 - Three-jaw drill chuck

What clamping possibilities are there for:

1. Tools with cylindrical shank**2. Tools with taper shank?**

1. _____

2. _____



[Home](#) > [ar](#).[cn](#).[de](#).[en](#).[es](#).[fr](#).[id](#).[it](#).[ph](#).[po](#).[ru](#).[sw](#)

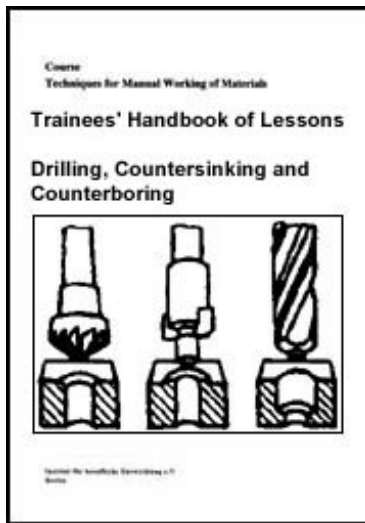

 **Drilling, Countersinking and Counterboring - Course: Technique for manual working of materials. Trainees' handbook of lessons (Institut fr Berufliche Entwicklung, 18 p.)**

 **(introduction...)**

 **1. Purpose of drilling**

 **2. Machines for drilling**

 **3. Tools for metal drilling**

 **4. The operation of drilling**

 **5. Setting of the tools**

 **6. Clamping of the tools**

 **➔ 7. Clamping of the workpieces**

 **8. Technological process of drilling**

 **9. Purpose and application of counterboring/ countersinking**

 **10. Labour safety recommendations**

7. Clamping of the workpieces

Workpieces roust be clamped in such a way that they cannot fling around or be drawn up.

Small workpieces can be held by clamp dogs or hand vices on a support if only a small rotary power is to be expected (small bore holes).

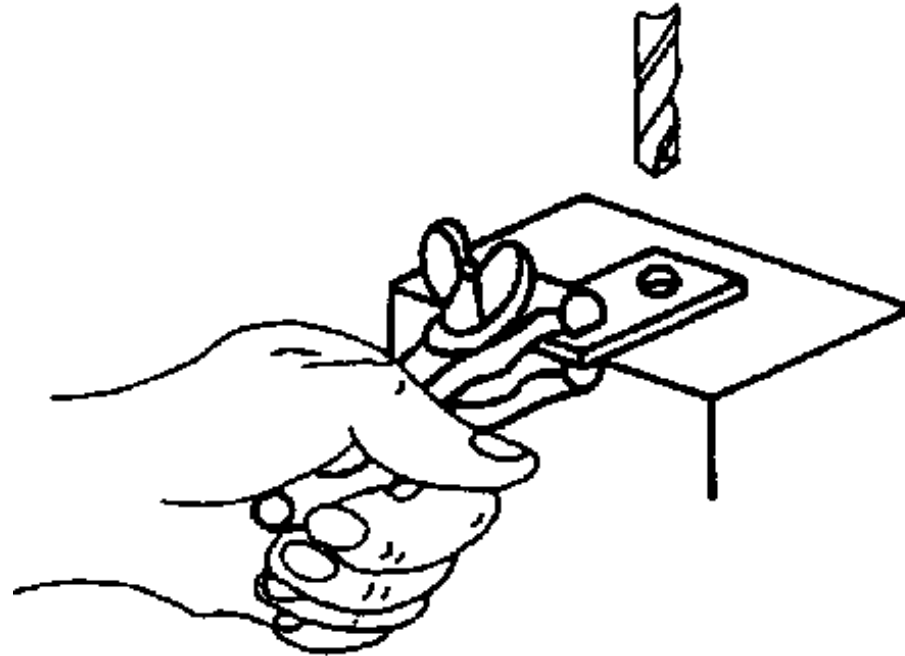

Figure 13 - Holding of flat, small workpieces in the hand vice

Larger workpieces are safely clamped in the machine vice that can be equipped with straight or prismatic jaws.

Cylindrical parts may also be clamped in the drilling v-block

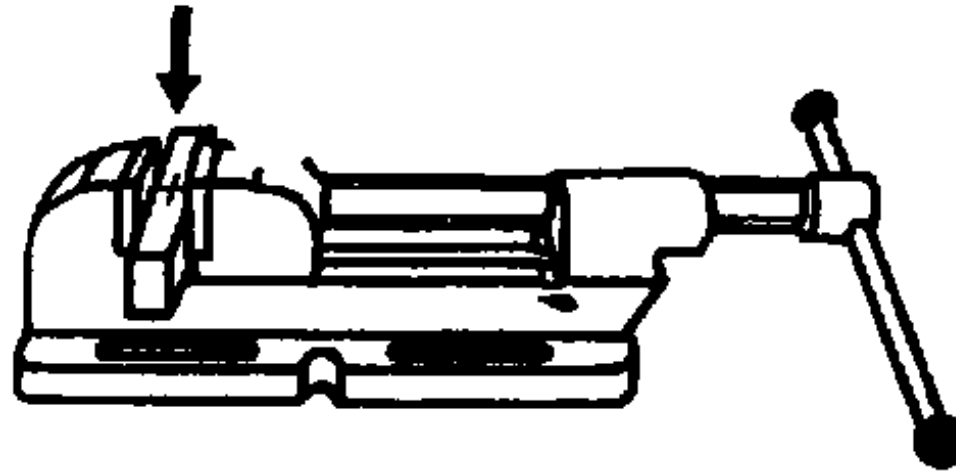

Figure 14 - Clamping of small workpieces in the machine vice

Very big parts must be clamped on the machine table directly.

For this purpose, clamps and locking screws as well as other auxiliary means are required.

For series and mass production, drill jigs are used.

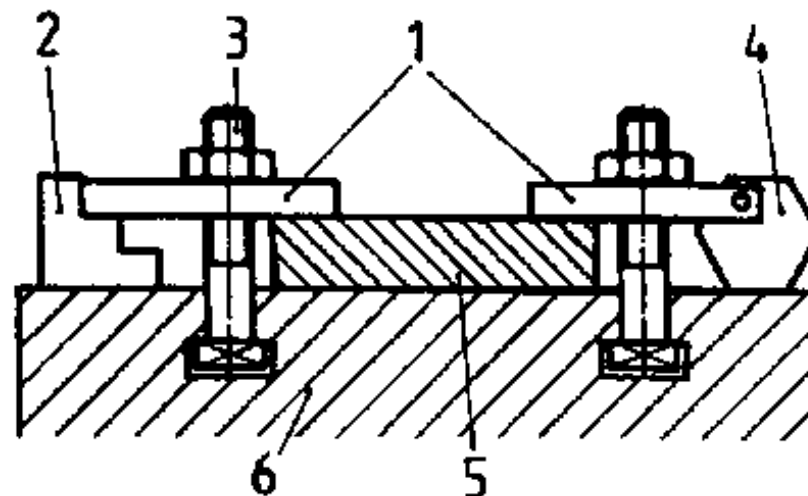
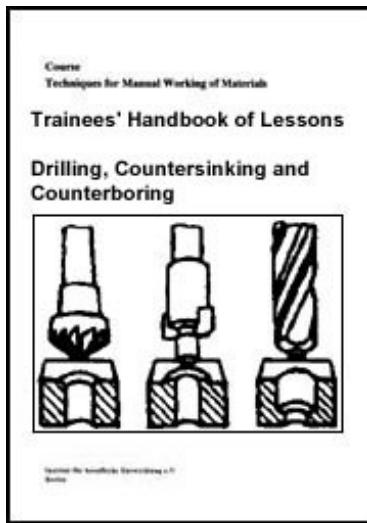

Figure 15 - Clamping of big workpieces on the machine table by clamps

- 1 - Clamps
- 2 - Step block
- 3 - Locking screw
- 4 - Supporting hexagon (fixed at the clamp)
- 5 - Workpiece
- 6 - Machine table



[Home](#) > [ar.cn.de.en.es.fr.id.it.ph.po.ru.sw](#)



 **Driling, Countersinking and Counterboring - Course: Technique for manual working of materials. Trainees' handbook of lessons (Institut fr Berufliche Entwicklung, 18 p.)**

 **(introduction...)**

 **1. Purpose of drilling**

 **2. Machines for drilling**

 **3. Tools for metal drilling**

 **4. The operation of drilling**

 **5. Setting of the tools**

 **6. Clamping of the tools**

 **7. Clamping of the workpieces**

  **8. Technological process of drilling**

 **9. Purpose and application of counterboring/countersinking**



10. Labour safety recommendations

8. Technological process of drilling

Drilling of a blind hole:

1. Scribing and prick-punching

2. Clamping of the drill

3. Clamping of the workpiece in the machine vice and placing the point of the drill right above the punch mark;

Clamping the machine vice on the machine table

4. Setting the rotational speed at the machine

5. Spot-drilling of the workpiece (the point of the drill completely penetrates into the workpiece)

6. Setting the drilling depth at the machine which is switched off during this operation

7. Drilling up to the dog of the feed handle and/or depth indicator (feeding of cooling agent and permanent control of the flow of chips)

8. Cleaning and deburring

9. Checking of the diameter and of the depth of the bore hole with the help of a vernier caliper and depth gauge

If the bore hole is not true to size, i.e. if it is too large, this can have the following reasons:

Cause of the fault	Correction of the fault
Wrong drill point	Regrinding of the drill
The drill runs out when the spindle is running	Cleaning of the cylindrical shank of the drill as well as of the sleeve and reclamping of the drill. If the shank is severely damaged by ridges it can no longer be used and has to be replaced
The workpiece is not fixed	Clamp the workpiece on the table more firmly or secure it against displacement at least.

