

[Home](#) > [ar.cn.de.en.es.fr.id.it.ph.po.ru.sw](#)



- ➔ **Filing - Course: Technique for manual working of materials. Trainees' handbook of lessons (Institut fr Berufliche Entwicklung, 21 p.)**
- ➔ **(introduction...)**
 - ➔ **1. Purpose of filing**
 - ➔ **2. Filing tools**
 - ➔ **3. Auxiliary means for filing**
 - ➔ **4. Operation of filing**
 - ➔ **5. Standing position and guiding of the file**
 - ➔ **6. Handling of the files**
 - ➔ **7. Labour safety recommendations**



[Home](#) > [ar.cn.de.en.es.fr.id.it.ph.po.ru.sw](#)

- ➔ **Filing - Course: Technique for manual working of materials. Trainees' handbook of lessons (Institut fr Berufliche Entwicklung, 21 p.)**
- ➔ **(introduction...)**
 - ➔ **1. Purpose of filing**
 - ➔ **2. Filing tools**
 - ➔ **3. Auxiliary means for filing**
 - ➔ **4. Operation of filing**
 - ➔ **5. Standing position and guiding of the file**

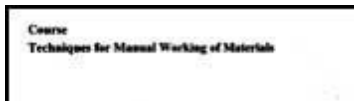



6. Handling of the files

7. Labour safety recommendations

**Institut für berufliche Entwicklung e.V.
Berlin**

**Original title:
Arbeitsmaterial für den Lernenden
"Feilen"**

Author: Frank Wenghfer

First edition © IBE

**Institut für berufliche Entwicklung e.V.
Parkstraße 23
13187 Berlin**

Order No.: 90-35-3105/2





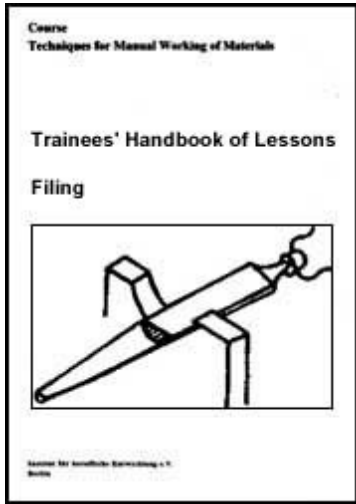





[Home](#) "" "" "" "" "" > [ar.cn.de.en.es.fr.id.it.ph.po.ru.sw](#)



 **Filing - Course: Technique for manual working of materials. Trainees' handbook of lessons (Institut fr Berufliche Entwicklung, 21 p.)**

 **(introduction...)**

-   **1. Purpose of filing**
-  **2. Filing tools**
-  **3. Auxiliary means for filing**
-  **4. Operation of filing**
-  **5. Standing position and guiding of the file**
-  **6. Handling of the files**
-  **7. Labour safety recommendations**

1. Purpose of filing

By filing chips are removed from straight or curved faces of pre-machined parts.

It serves to change the size, shape or surface finish of faces, to remove irregularities, to deburr, chamfer or round off edges, and to make parts fit.

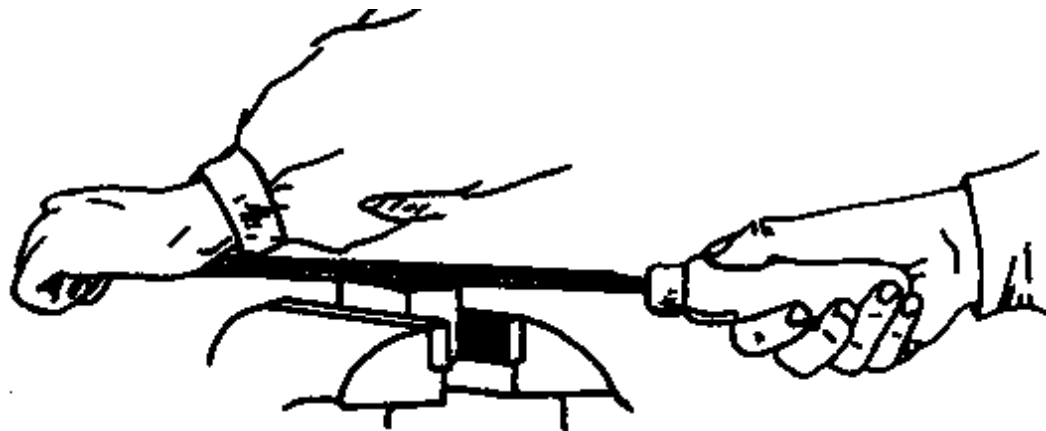



Figure 1 Files

Filing is hard and time-consuming manual work. It is useful only in single-piece production, repair work and partly in assembly work (fitting work and reworking).



[Home](#) > [ar](#).[cn](#).[de](#).[en](#).[es](#).[fr](#).[id](#).[it](#).[ph](#).[po](#).[ru](#).[sw](#)



 **Filing - Course: Technique for manual working of materials. Trainees' handbook of lessons (Institut fr Berufliche Entwicklung, 21 p.)**

 **(introduction...)**

 **1. Purpose of filing**

  **2. Filing tools**

 **3. Auxiliary means for filing**

 **4. Operation of filing**

 **5. Standing position and guiding of the file**

 **6. Handling of the files**

 **7. Labour safety recommendations**

2. Filing tools

Files are available in different shapes, sizes and types of cut. They consist of a blade of hardened tool steel and a wooden handle.

2.1. File shapes

Flat file:

For use on straight and curved external faces and on side edges to provide them with chamfers and to deburr edges.

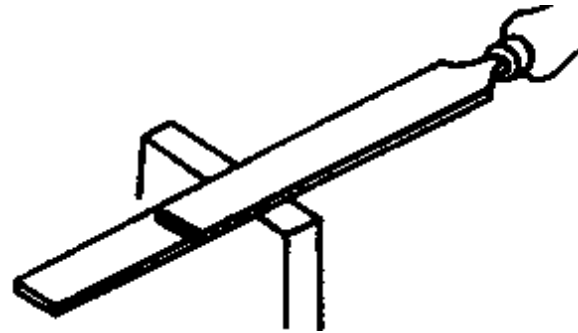

Figure 2 Flat file

Square file:

For use on square openings and narrow steps.

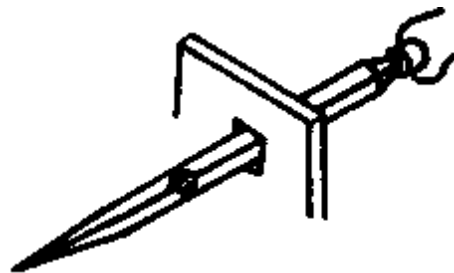

Figure 3 Square file

Triangular file:

For use on sharp-edged openings and steps as well as on small and short external faces.

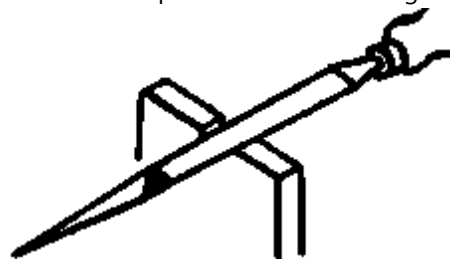

Figure 4 Triangular file

Round file:

For use on round openings and small inside radii.

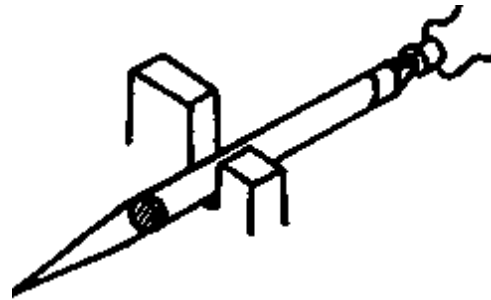

Figure 5 Round file

Halfround file:

For use on arched recesses and big inside radii.

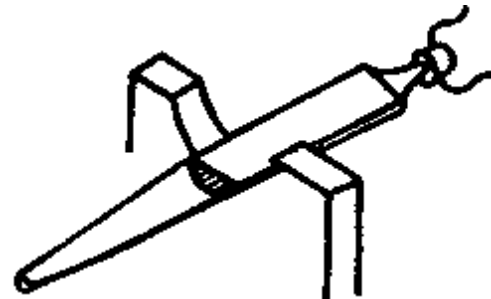

Figure 6 Halfround file

Crossing file:

For use on recesses and openings with very big radii.

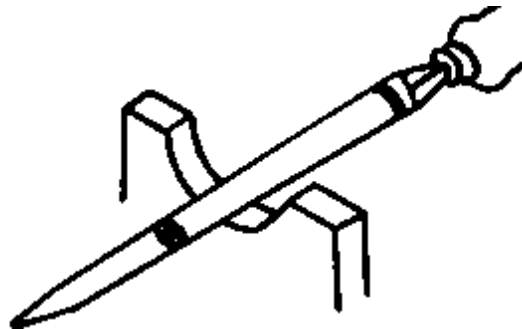

Figure 7 Crossing file

Barrette file:

For special use on dovetail guides.

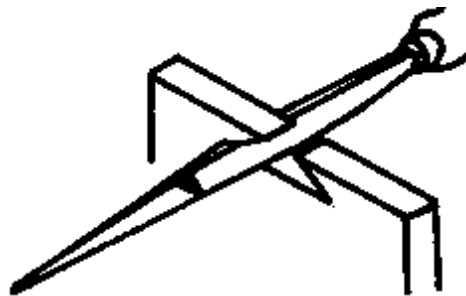

Figure 8 Barrette file

Knife file:

For use on narrow openings and for sharpening of saws.

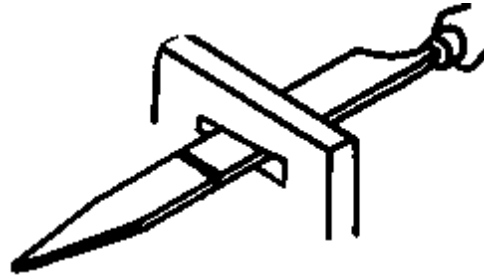

Figure 9 Knife file

2.2. File sizes

Big and heavy files (square rubber files and hand files) are used for large, straight, rough faces; medium-size files (ranging between 160 and 375 mm in length) may be used for any application.

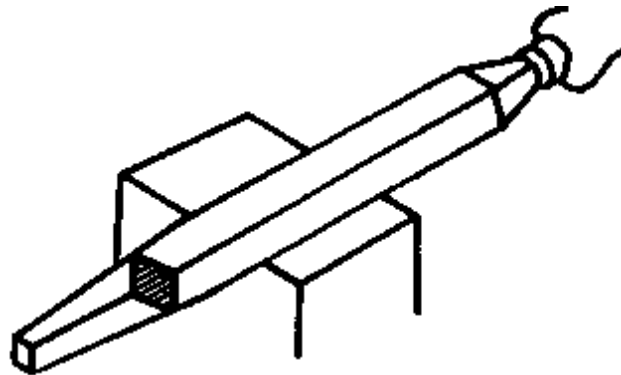

Figure 10 Filing of faces by a square rubber file

Small and smallest files (warding files and needle files of 100 mm length) are used for special purposes, mostly for very small cuts and openings.

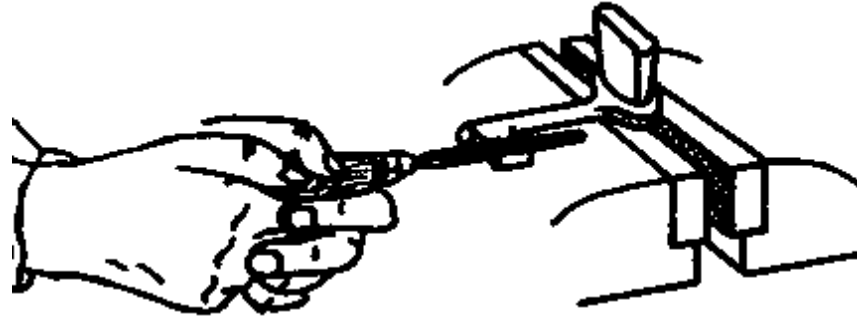

Figure 11 Filing of cuts by a warding file

Offset files (rifflers) are used for recesses and openings not easily accessible.

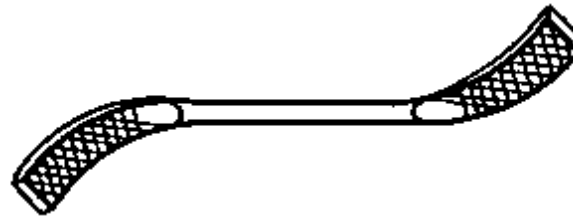

Figure 12 Riffler

2.3. Types of cut

Single-cut files (milled):

**File blade with long cutting edges which may be interrupted by chip breakers.
For use on soft metals, such as aluminium, lead, zinc.**

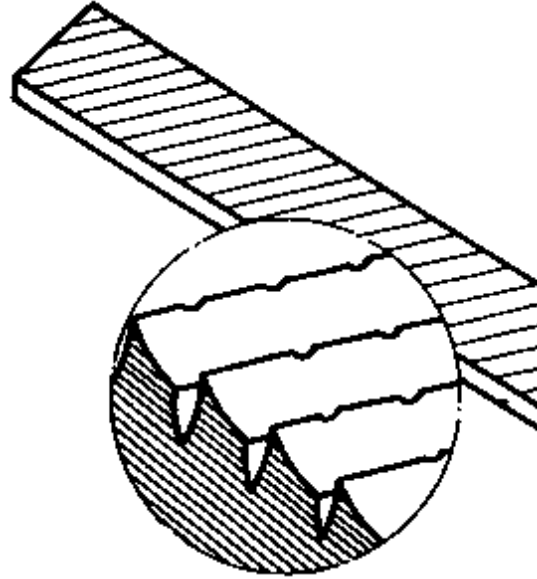

Figure 13 Single-cut file

Double-cut files (chiseled):

**Files with crossed cutting edges forming the teeth of the file.
For use on general steel and cast iron.**

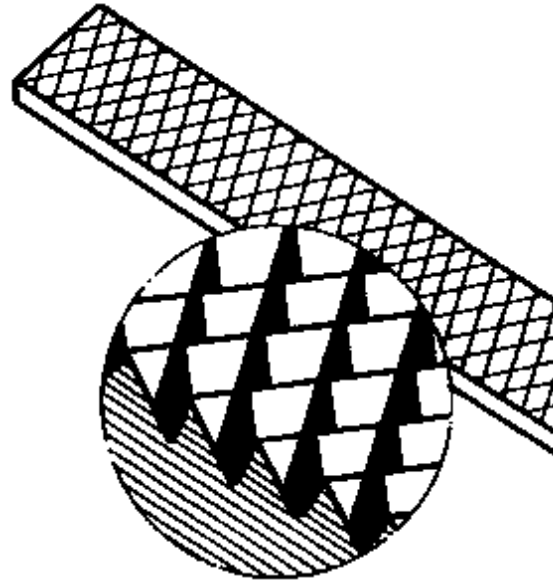

Figure 14 Double-cut file

Rasp-cut files:

**Files with special cutting edges with ripping effect.
For use on soft metal with big working allowance and on non-metallic soft materials (wood).**

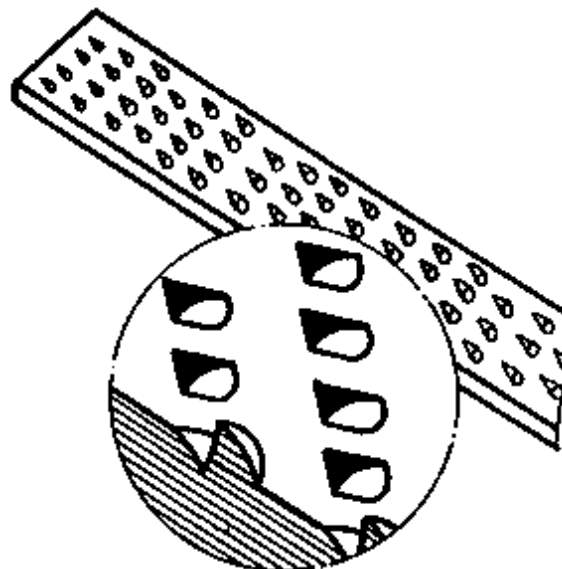
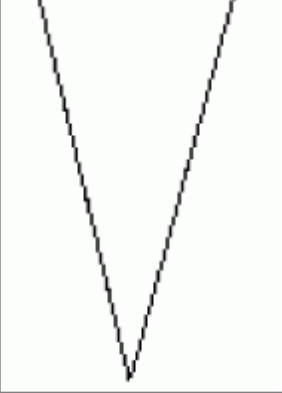

Figure 15 Rasp-cut file

Single-cut files and double-cut files are classified by the degree of coarseness of their teeth and can be marked by numbers of cut (grade of cut).

Designation	Cut no.	File surface	Use of file	Fineness of file
rough-cut file (roughing file)	0	rough (stroke of file tangible and visible)	for oversize of 0.5 mm and more	very coarse
bastard file (coarse file)	1			
second-cut file (coarse finishing file)	2	fine (file stroke no longer tangible but still visible)	for oversize of less than 0.1 mm	

				
smooth-cut (finishing file)	3			
dead-smooth file (fine finishing file)	4	very fine (file stroke neither tangible nor visible)	for fits and best surface finish	
super-smooth file (superfine finishing file)	5			very fine

Files are selected depending on:

- the shape of the face or edge to be filed,
- the hardness of the material to be filed,
- the size of the face to be filed,
- the amount of filing and the surface finish.

In which cases will filing be useful?

Which shape of file is mainly used?

Which type of cut is used for filing of general steels and cast iron?



[Home](#) > [ar](#).[cn](#).[de](#).[en](#).[es](#).[fr](#).[id](#).[it](#).[ph](#).[po](#).[ru](#).[sw](#)

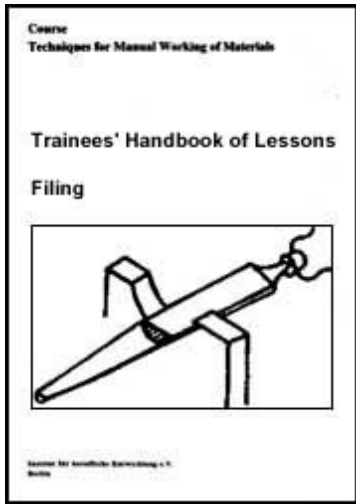

 **Filing - Course: Technique for manual working of materials. Trainees' handbook of lessons (Institut fr Berufliche Entwicklung, 21 p.)**

 **(introduction...)**

 **1. Purpose of filing**

 **2. Filing tools**

 **→ 3. Auxiliary means for filing**

 **4. Operation of filing**

 **5. Standing position and guiding of the file**

 **6. Handling of the files**

 **7. Labour safety recommendations**

3. Auxiliary means for filing

Auxiliary means for filing are clamping devices which are to be selected according to the purpose of clamping the relevant cross section of the workpiece.

Requirements:

The workpiece is to be clamped so that the file stroke is always horizontal.

The workpiece is to be clamped as firmly and securely as to eliminate any springiness and displacement of the workpiece during filing!

In addition to the clamping devices also used for the working technique “manual sawing”, such as:

- vice
- vee clamps
- angle clamps
- protective jaws,

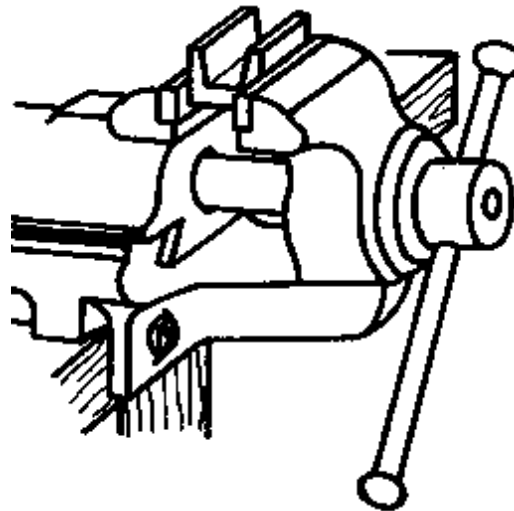

Figure 16 Vice

the following auxiliary means are in use:

Clamping jaws for round stock:

Specially formed vice attachments with halved holes permitting vertical clamping without squeezing of thin round stock.

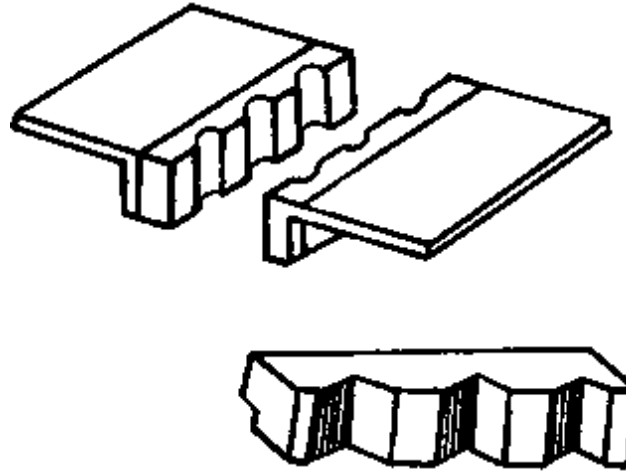

Figure 17 Clamping jaws for round stock

Clamping jaws for threaded bolts and thread clamps:

Specially formed vice attachments with halved holes permitting vertical clamping of threaded bolts. For small screws a thread clamp is used.

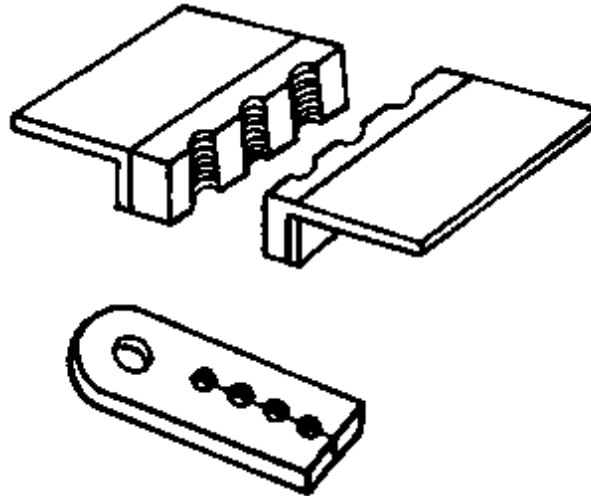

Figure 18 Clamping jaws for threaded bolts and thread clamps

Angle vice:

Clamping device for clamping of small, flat parts in a vice at an angle of 45 degrees. It is used for filing of bevels only.



Figure 19 Angle vice

Hand vice and pin vice:

Clamping device for clamping of small parts, mostly sheets, to be filed on any support.

Pin vices are also often used as universal clamping devices for other working techniques (drilling, counterboring, riveting).

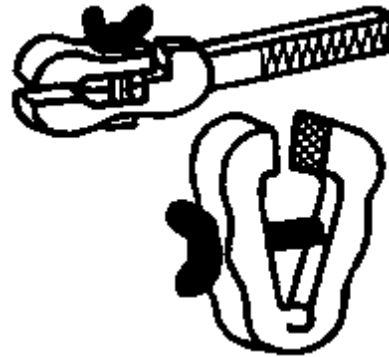

Figure 20 Hand vice and pin vice

Sheet metal clamp:

Angle attachment to extend the vice jaws serving for horizontal clamping of longer sheets.

At the protruding end it is mounted with a small clamp or hand vice.

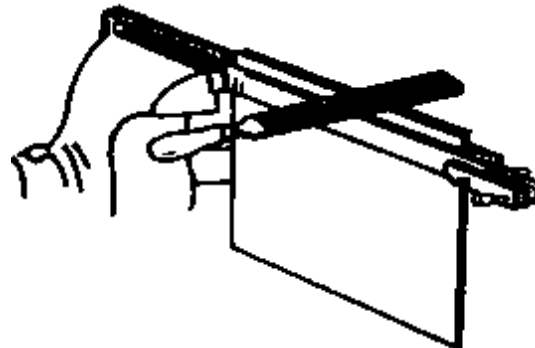

Figure 21 Sheet metal clamp

Note:

Profiles are to be clamped with suitable attachments which can be made from wood so as to suit the relevant form.

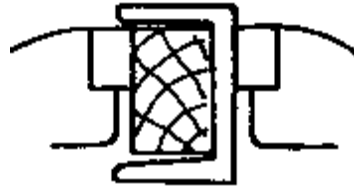



Figure 22 Wooden attachment for clamping of profiles

Which requirements must be met when clamping?

Which auxiliary means are suitable for clamping of workpieces?



[Home](#) > [ar](#).[cn](#).[de](#).[en](#).[es](#).[fr](#).[id](#).[it](#).[ph](#).[po](#).[ru](#).[sw](#)

 **Filing - Course: Technique for manual working of materials. Trainees' handbook of lessons (Institut fr Berufliche Entwicklung, 21 p.)**

 **(introduction...)**

 **1. Purpose of filing**

 **2. Filing tools**

 **3. Auxiliary means for filing**

 **➔ 4. Operation of filing**

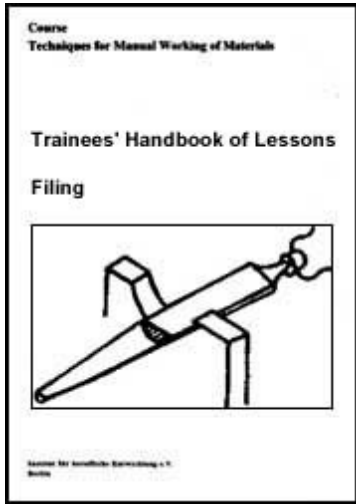

- 5. Standing position and guiding of the file
- 6. Handling of the files
- 7. Labour safety recommendations

4. Operation of filing

The file blade has many wedge-shaped teeth. It is pressed onto the workpiece and pushed forward at the same time so that the teeth are penetrating into the material removing chips.



Figure 23 Action of the milled file

Milled files have very sharp teeth with a small angle of wedge (47 degrees) and work with positive rake angle - the teeth have a forward inclination. This results in a cutting action which is suitable for soft material.

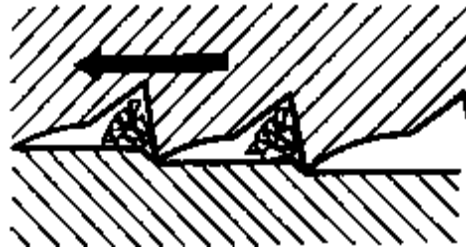

Figure 24 Action of the chiseled file

Chiseled files have teeth with big angle of wedge (70 degrees) and work with negative rake angle. This results in a shaving action which is suitable for hard material.

Note:

For fine finishing of faces the file may be slightly chalked. The chalk will deposit in the tooth gullet reducing the depth of penetration of the teeth.

Fine chips, which would otherwise destroy the smooth surface of the workpiece, settle in this chalk layer.

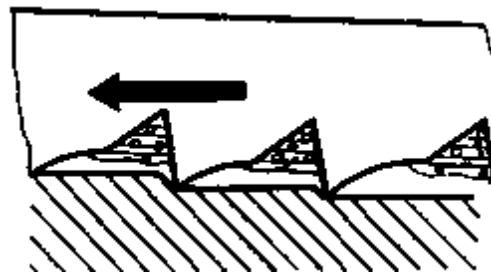



Figure 25 Chalked chiseled file



[Home](#) "" "" "" "" "" > [ar.cn.de.en.es.fr.id.it.ph.po.ru.sw](#)



 **Filing - Course: Technique for manual working of materials. Trainees' handbook of lessons (Institut für Berufliche Entwicklung, 21 p.)**

 **(introduction...)**

 **1. Purpose of filing**

 **2. Filing tools**

 **3. Auxiliary means for filing**

 **4. Operation of filing**

 **➔ 5. Standing position and guiding of the file**

 **6. Handling of the files**

 **7. Labour safety recommendations**

5. Standing position and guiding of the file

Before beginning to file make sure that the vice has the correct height and the workpiece is firmly clamped!



Figure 26 - Correct height of the vice

Procedure:

- **The weight of the body is resting on one leg; the other leg is always straightened; both feet have to be firmly on the ground**
- **The file is moved with the arms only, not with the upper part of the body - the upper part of the body must not swing!**
- **The file is pressed onto the workpiece when pushing the file forward only; It is pulled back without pressure!**
- **The file is to be guided so that the movement is always horizontal!**



Figure 27 Correct standing position

Note:

Support the movement of the arms by analogous movement of the body when working with big files only!

Why are milled files suitable for soft material?

Why are chiseled files suitable for hard materials?

Why must not the upper part of the body swing when filing but the file be moved by the arms only?



[Home](#) > [ar](#).[cn](#).[de](#).[en](#).[es](#).[fr](#).[id](#).[it](#).[ph](#).[po](#).[ru](#).[sw](#)



 **Filing - Course: Technique for manual working of materials. Trainees' handbook of lessons (Institut fr Berufliche Entwicklung, 21 p.)**

 **(introduction...)**

 **1. Purpose of filing**

 **2. Filing tools**

 **3. Auxiliary means for filing**

 **4. Operation of filing**

 **5. Standing position and guiding of the file**

 **➔ 6. Handling of the files**

 **7. Labour safety recommendations**

6. Handling of the files

Big files:

One hand grips the file handle while the palm of the other hand (guiding hand) lies on the end of the file blade and holds and guides the file in the horizontal plane.



Figure 28 Handling of big files

Middle-size files:

One hand grips the file handle while thumb and fingers of the other hand (guiding hand) grip the end of the file blade guiding the file.

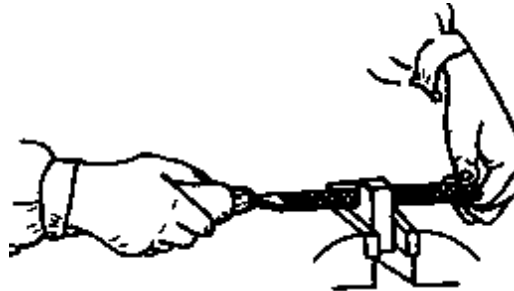

Figure 29 Handling of middle-size files

Small files:

**One hand grips the file handle while the fingers of the other hand press onto the file blade so as to avoid deflection of the file blade
(Filing without guiding hand is also possible)**



Figure 30 Handling of small files

6.1. Filing of straight faces

There are three types of filing strokes

Oblique stroke:

Suitable for removing big quantities of chips with rough surface

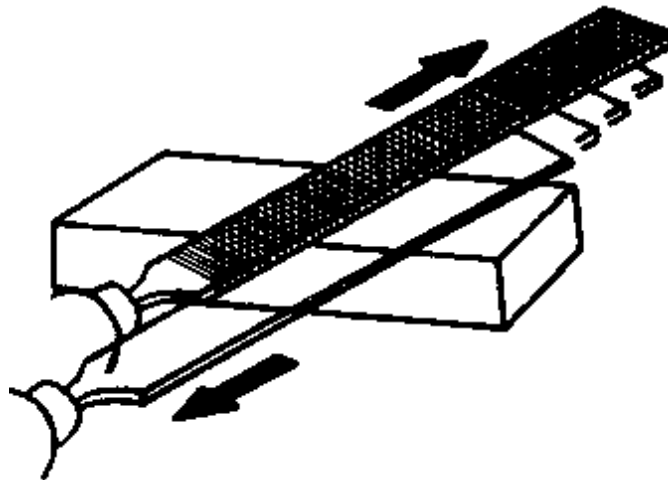

Figure 31 Oblique stroke filing

Crossing stroke:

The traces left by changing the working direction are noticeable on the surface as

peaks and valleys!

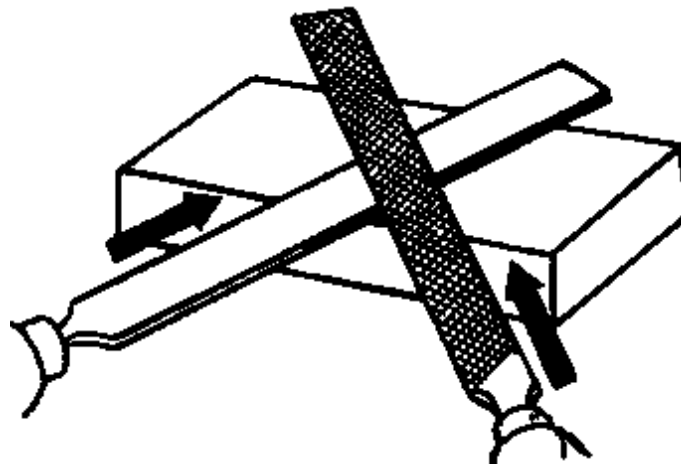

Figure 32 Cross-stroke filing

Longitudinal stroke:

Working traces in parallel with the longest edge of the work - light guidance of the file for smooth finish.



Figure 33 Longitudinal stroke filing

Testing of faces for flatness and angularity is preferably done by bevelled steel straightedge and bevelled edge square!

6.2. Filing of curved faces

Small outer radii are filed longitudinally in the direction of the radius.

The working movement is featured by a rocking feed movement opposite to the radius

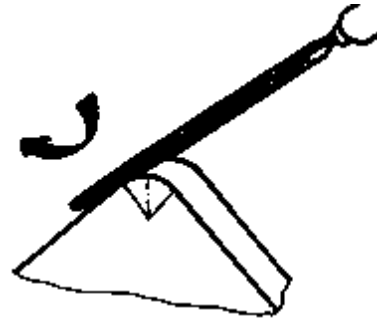

Figure 34 Filing of small outer radii

Filing on big outer radii is at right angles to the radius starting at one side and working to the other side with slightly oblique stroke.

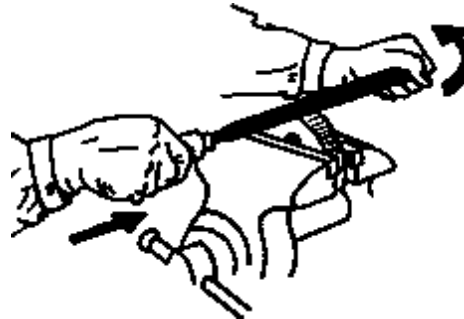

Figure 35 Filing of big outer radii

Filing on inside radii of any size is at right angles to the radius. The radius of the file (round file, half round file) must be smaller than the radius of the work.

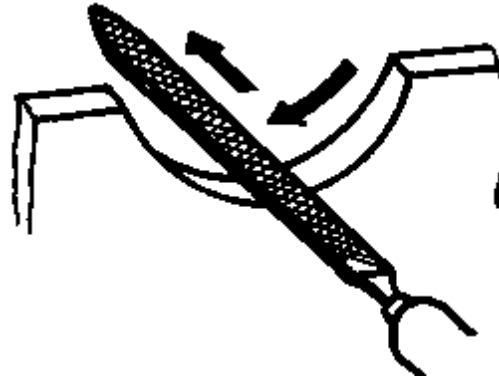

Figure 36 Filing of big inside radii

Testing of the radii for accuracy to shape is by radius gauges for outer and inner radii.

6.3. Filing of recesses and openings

**The file is carefully selected depending on the size and shape of the recesses or openings
It must be smaller than the recess or opening to be filed.**

Testing for accuracy to size is by measuring instruments, for accuracy to shape by adequate counterparts.

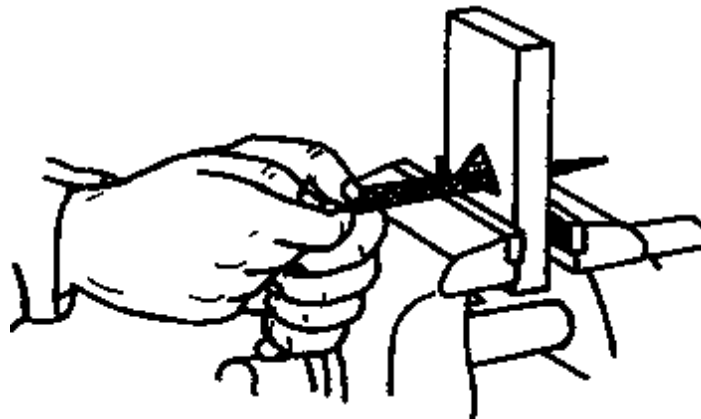

Figure 37 Filing of an opening

6.4. Filing of chamfers

On big workpieces filing of chamfers at an angle of 45 degrees is performed with vertically inclined file. Small workpieces may be clamped in an angle vice and are filed horizontally.

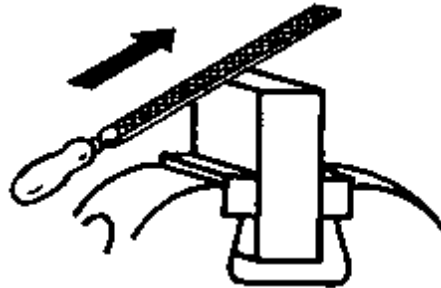

Figure 38 Filing of a chamfer on big workpieces

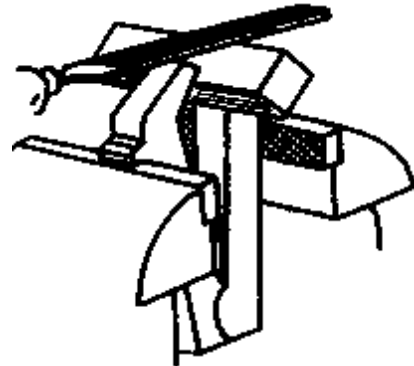

Figure 39 Filing of a chamfer on small workpieces by means of an angle vice

On round stock (bolts) filing of chamfers is performed with the file laterally inclined by 45 degrees, filing step by step around the round stock with the file whipped outwards

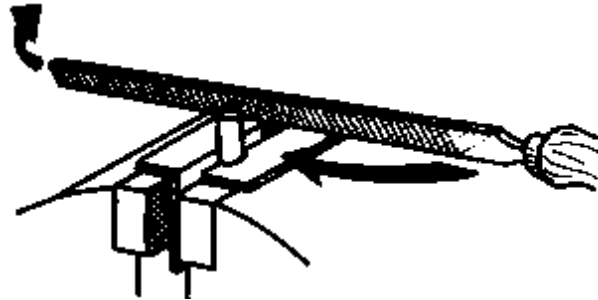

Figure 40 Filing of a chamfer on round stock

Testing of the chamfer is by Judgement by the eye, particularly with respect to evenness and surface finish.

Which kinds of stroke are to be subsequently used when filing straight faces?

Why can evenness with good surface finish be achieved only by crossing-stroke filing?

What is typical of the working movement when filing small outside radii?

Which requirements are to be met when filing inside radii?

What makes the difference between filing of big and small parts?

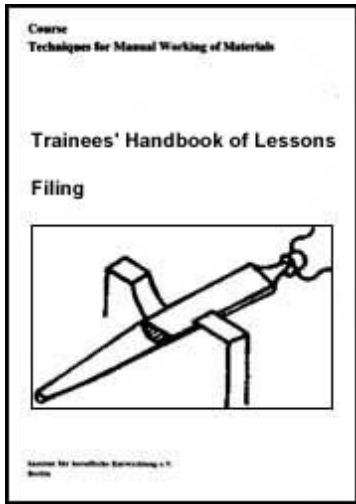

 **Filing - Course: Technique for manual working of materials. Trainees' handbook of lessons (Institut für Berufliche Entwicklung, 21 p.)**

 **(introduction...)**

 **1. Purpose of filing**

 **2. Filing tools**

 **3. Auxiliary means for filing**

 **4. Operation of filing**

 **5. Standing position and guiding of the file**

 **6. Handling of the files**

  **7. Labour safety recommendations**

7. Labour safety recommendations

- Don't wipe off chips with bare hands - danger of injury!
- Use files with crackless file handles only - otherwise danger of injury!
- Bore and enlarge new file handles according to the tang and then fix them by gentle hammer blows!
- Hardened parts roust not be filed!
- Don't stack files one above the other - protect them from falling down!
- Clean files regularly with file brush and latten brass!

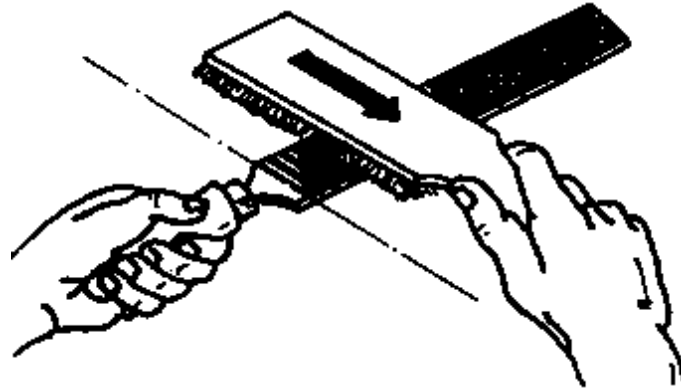

Figure 41 Cleaning of the file with the file brush

