

1. Maschinenelemente - Wälzlager  
Aufbau eines Wälzlagers

FR-MALF 1.1.

0

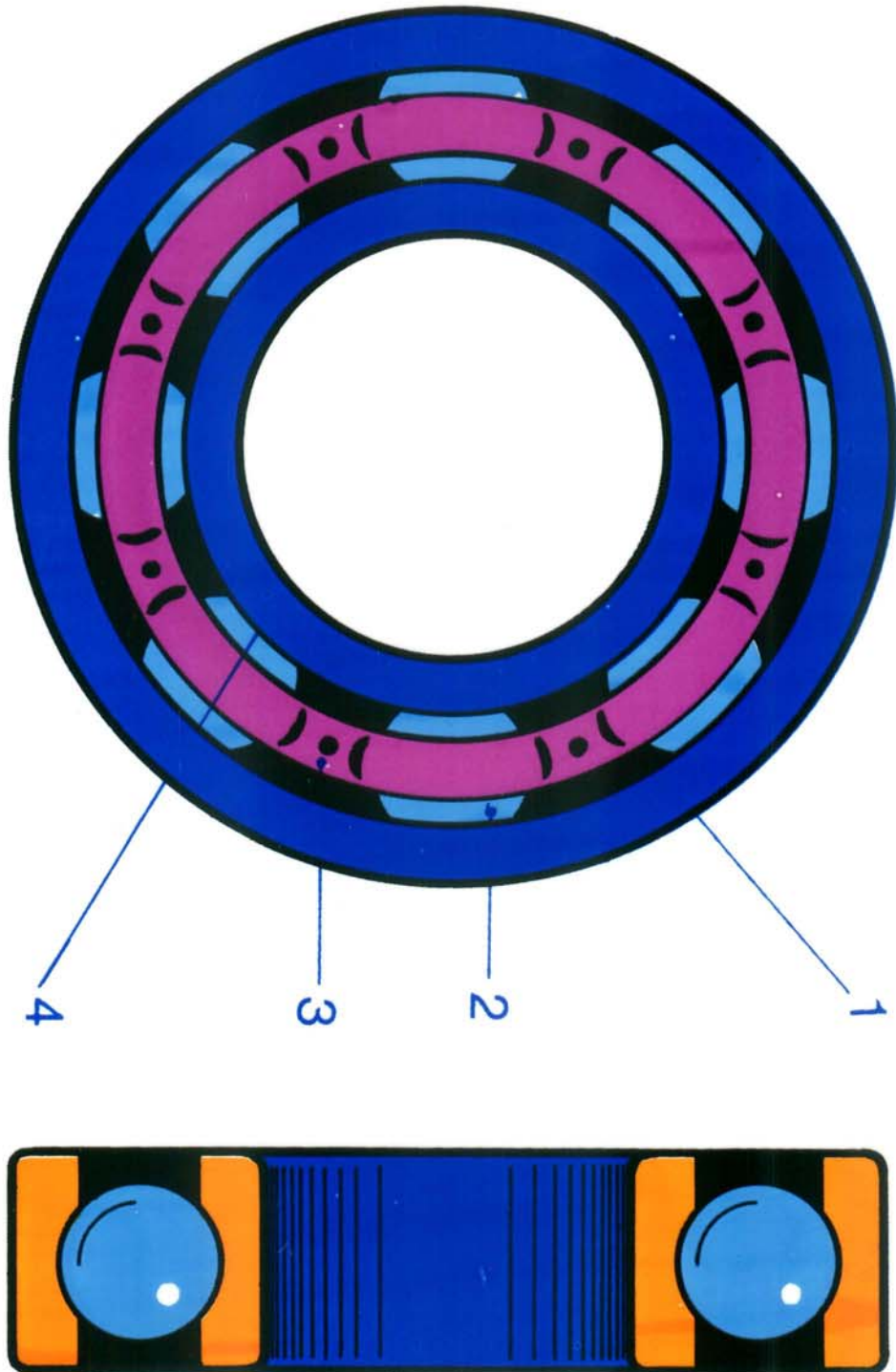

# 1. Maschinenelemente - Wälzlager

Arten von Wälzkörpern

FR-MALF 1.2.

0

1



2



3



4

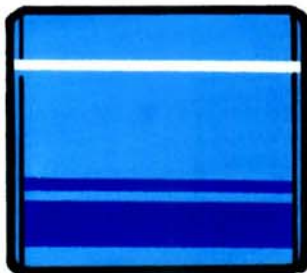

5

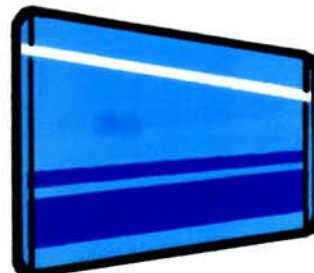

6

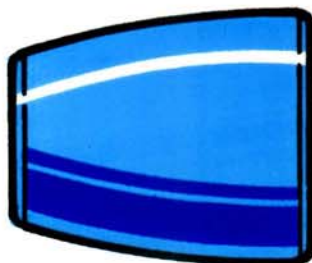

7



1. Maschinenelemente - Wälzlager  
 Bauformen - Einzelheiten der Gestaltung I

FR-MALF 1.3.

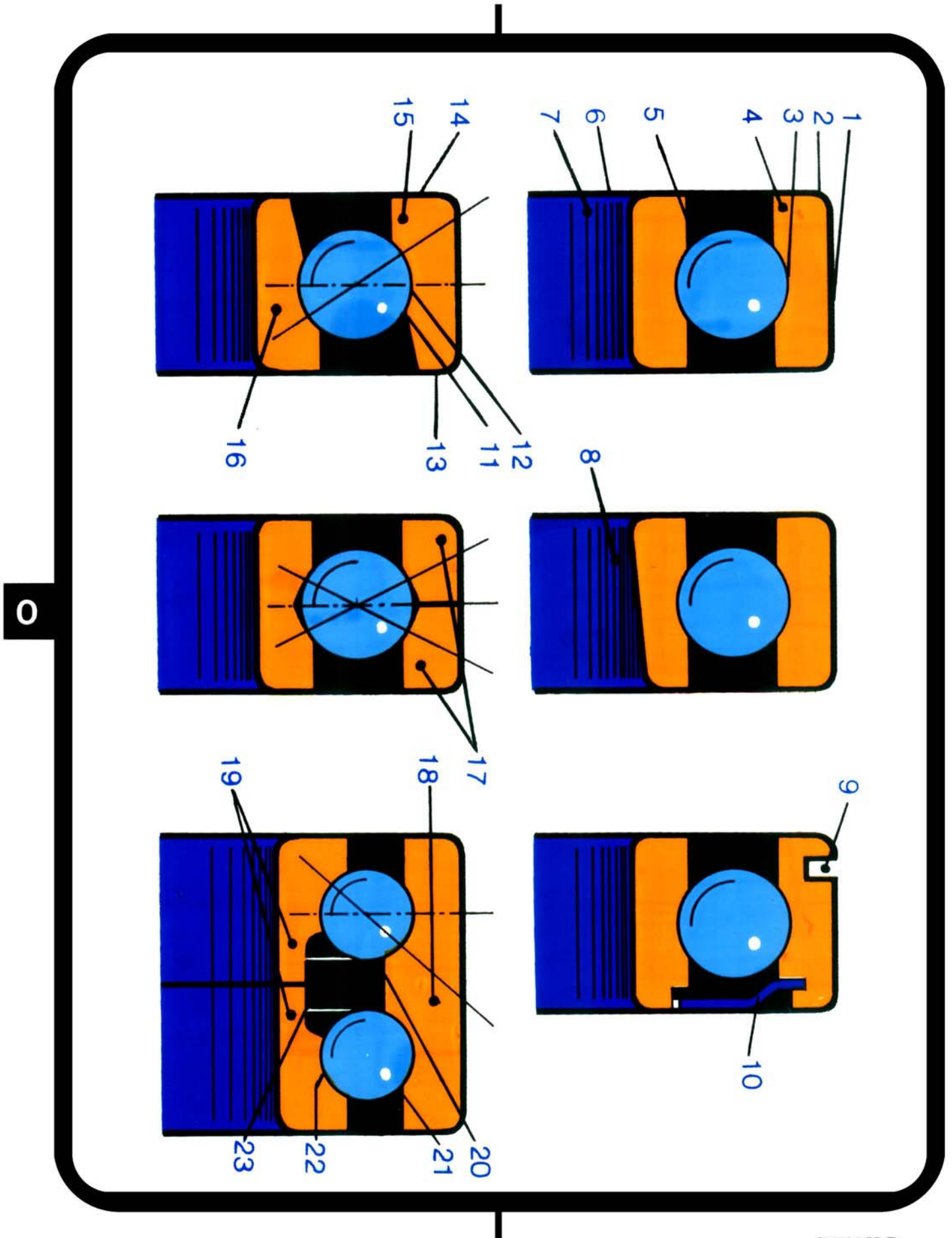

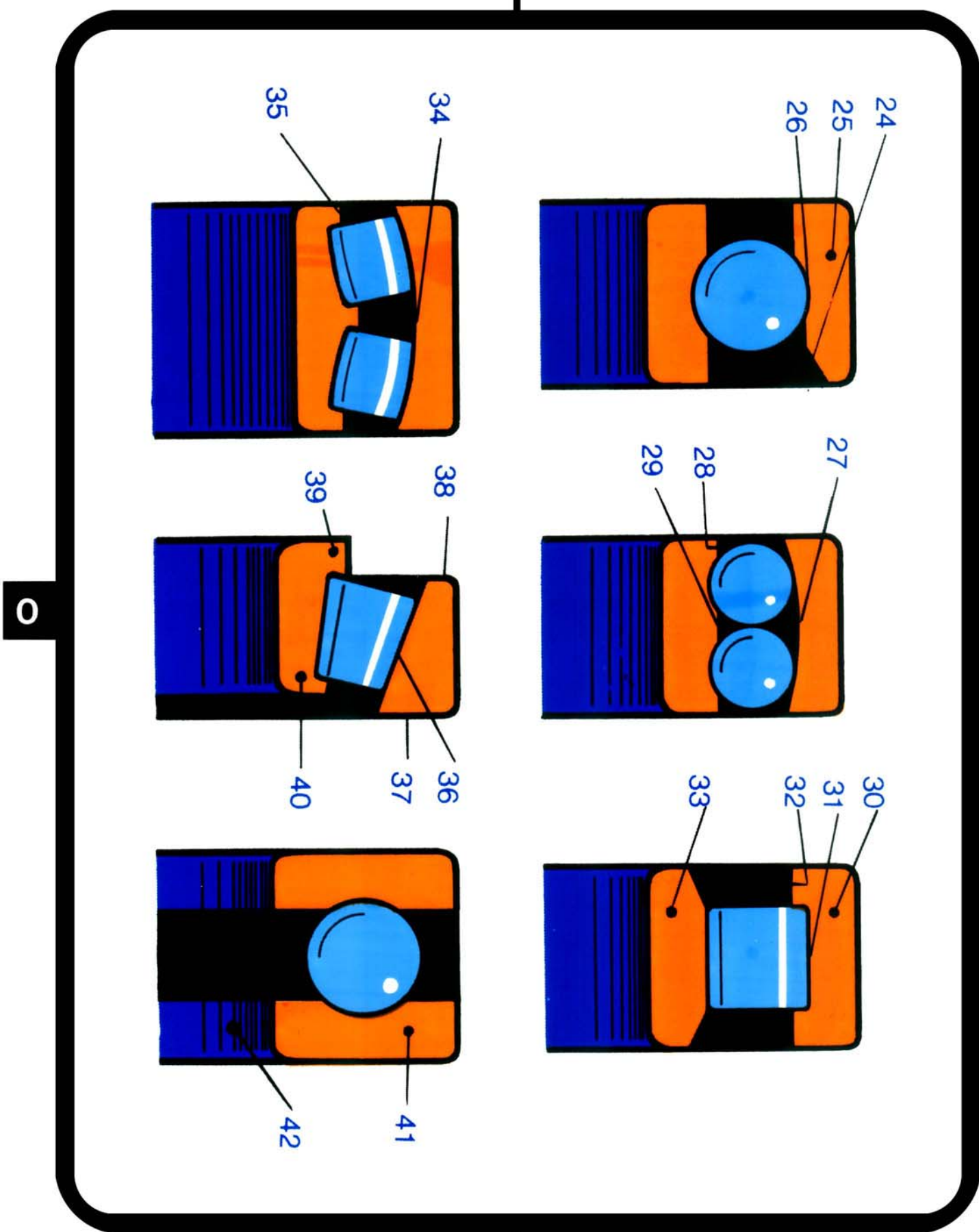

## Paliers à roulement

### Roulements à billes

Roulements rainurés à billes

Roulements à billes  
à contact oblique

Roulements à billes à rotule

Roulements à billes  
et à épaulement

### Butées à billes

Butées à billes  
à simple effet

Butées à billes  
à double effet

### Roulements à rouleaux

Roulements à rouleaux  
cylindriques

Roulements à aiguilles

Roulements à rouleaux  
coniques

Roulements à rouleaux à rotule

### Butées à rouleaux

Butées à rouleaux à rotule

حمل مقاوم للاحتكاك

حمل ذو كريات

حمل اسطوانات

حمل قطري

حمل قطري

حمل اخدودي ذو كريات

حمل اسطوانات اسطواناني

حمل مائل ذو كريات

حمل ابري

حمل تأرجحي ذو كريات

حمل اسطوانات مخروطي

حمل كتي ذو كريات

حمل اسطوانات تأرجحي

حمل محوري

حمل محوري

حمل اخدودي ذو كريات - محوري  
بفعل فردي الجوانب

حمل اسطوانات تأرجحي - محوري

حمل اخدودي ذو كريات - محوري  
ثنائي الفعل

1. Maschinenelemente - Wälzlager  
Konstruktive Gestaltung der Lagerstelle  
Festlager, Loslager, Stützlager

FR-MALF 1.6

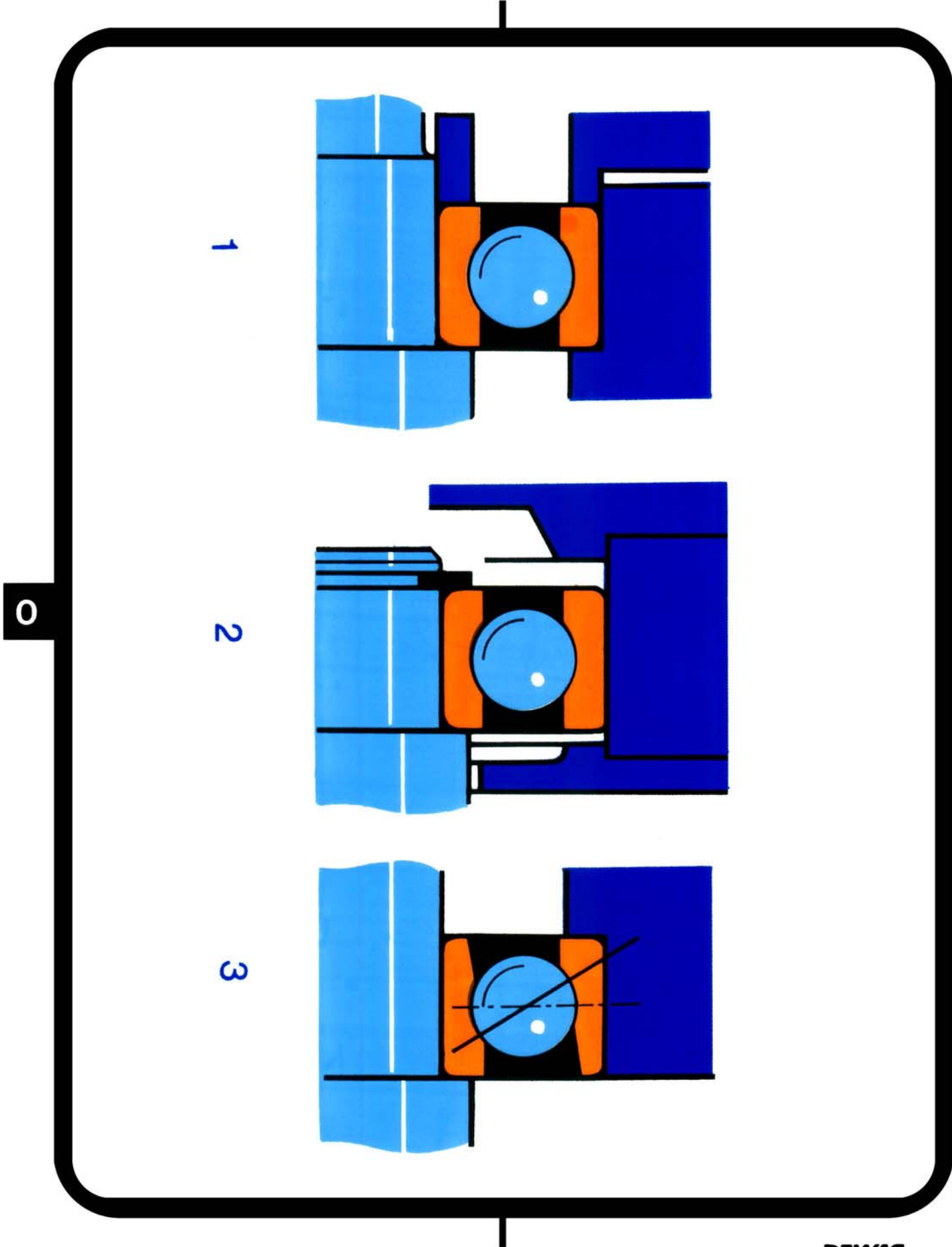

1. Maschinenelemente - Wälzlager  
Konstruktive Gestaltung der Lagerstelle  
Axiale Festlegungen I

FR-MALF 1.7.

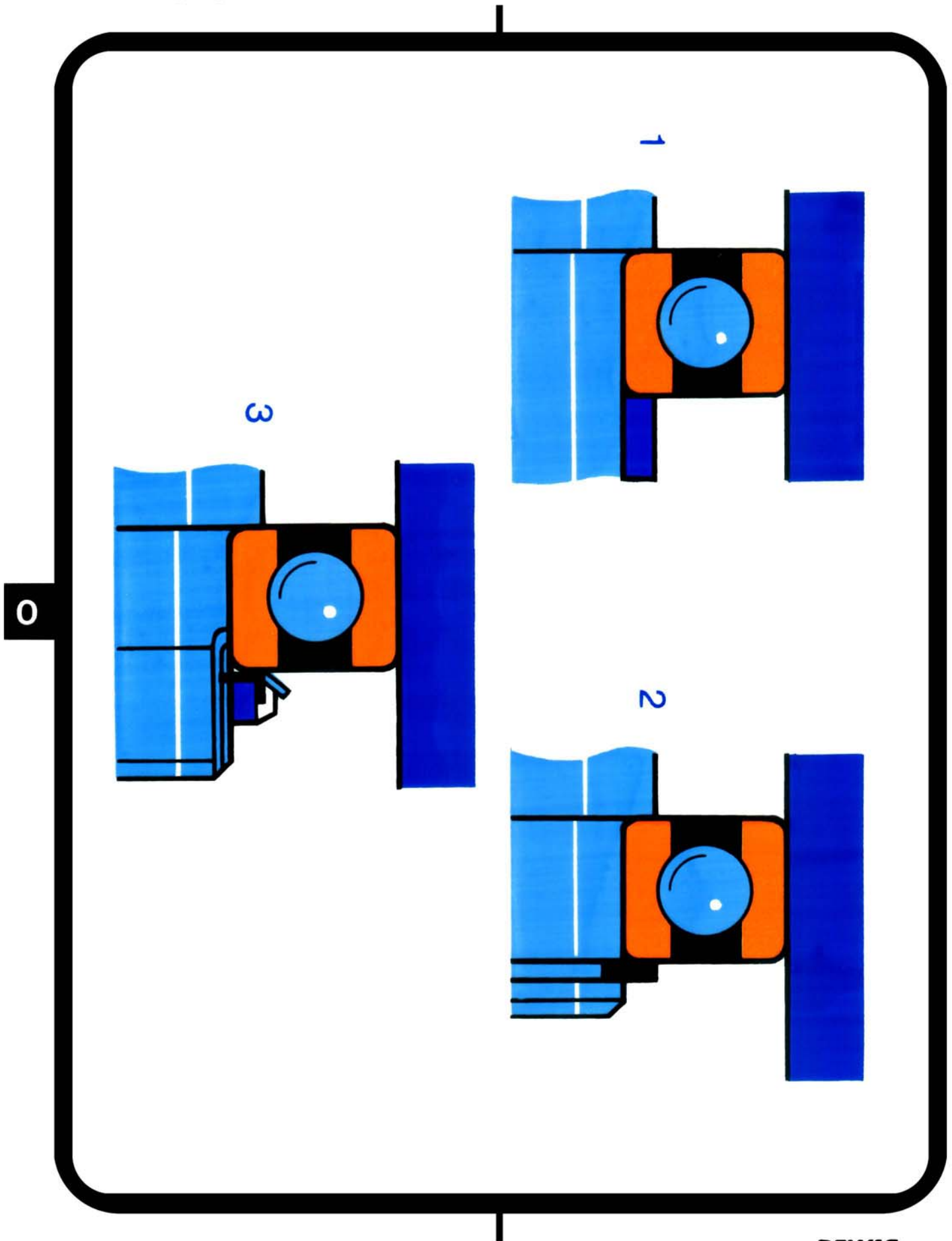



1. Maschinenelemente - Wälzlager  
Konstruktive Gestaltung der Lagerstelle  
Axiale Festlegungen II

FR-MALF 1.8.

0

1

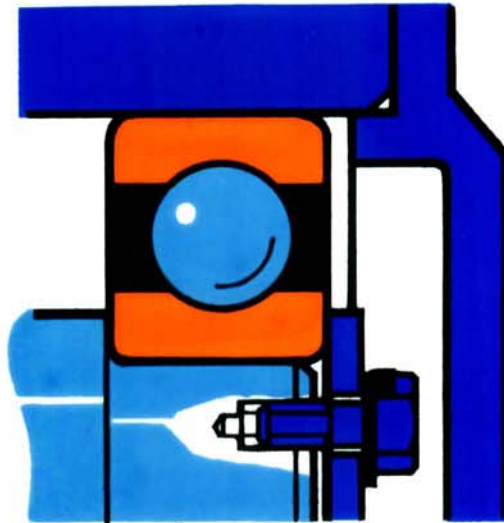

2

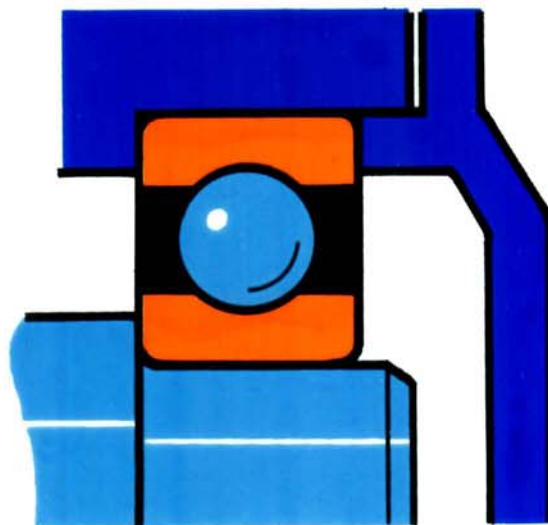

1. Maschinenelemente - Wälzlager  
Konstruktive Gestaltung der Lagerstelle  
Axiale Festlegungen III

FR-MALF 1.9.

1

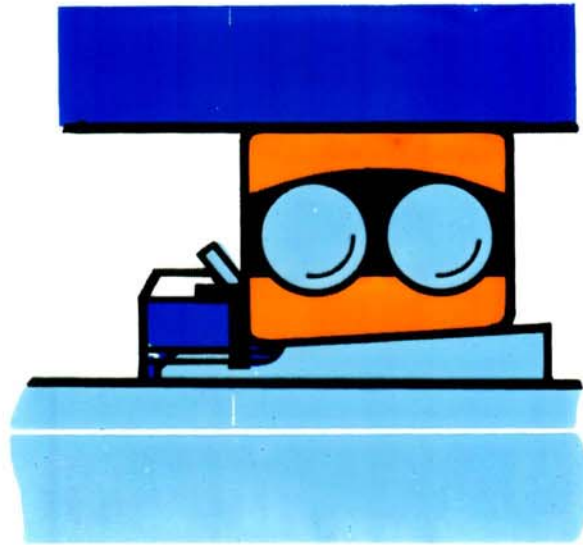

2

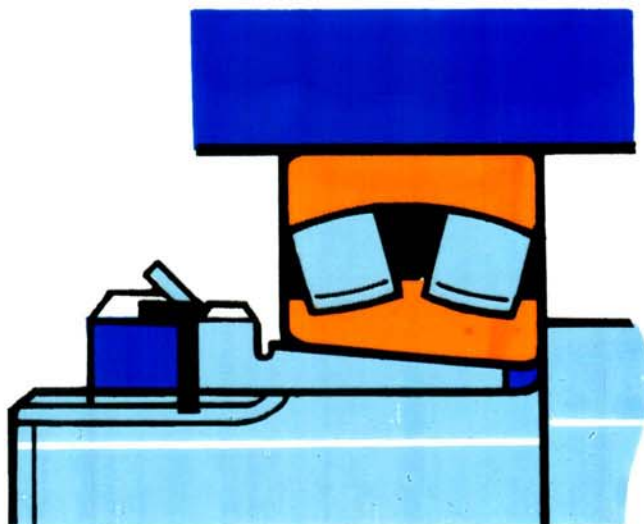

0

1. Maschinenelemente - Wälzlager  
Konstruktive Gestaltung der Lagerstelle  
Zwischentrieb

FR-MALF 1.10.

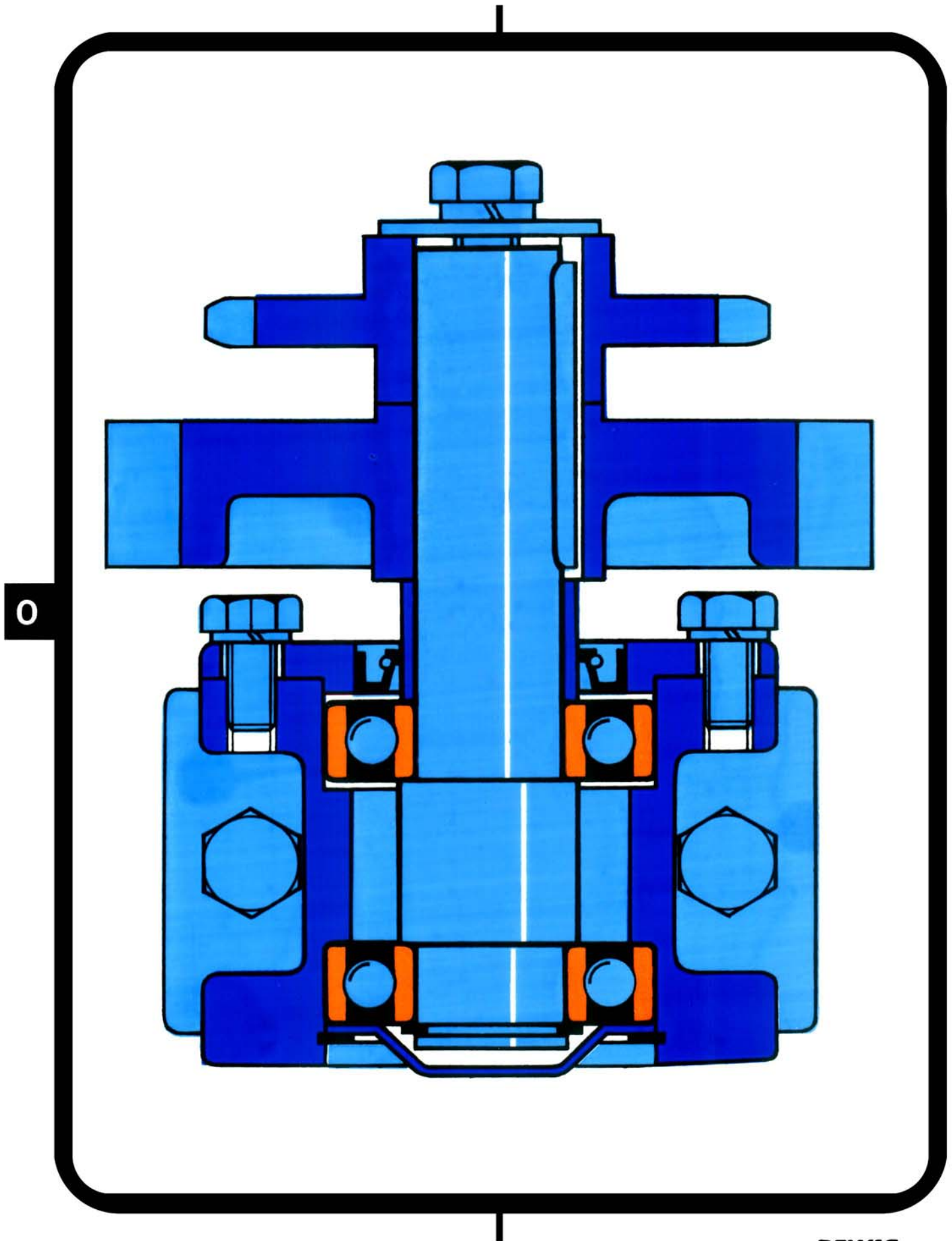

1. Maschinenelemente - Wälzlager  
Einbau - Gegenüberstellung richtig/falsch

FR-MALF 1.11.

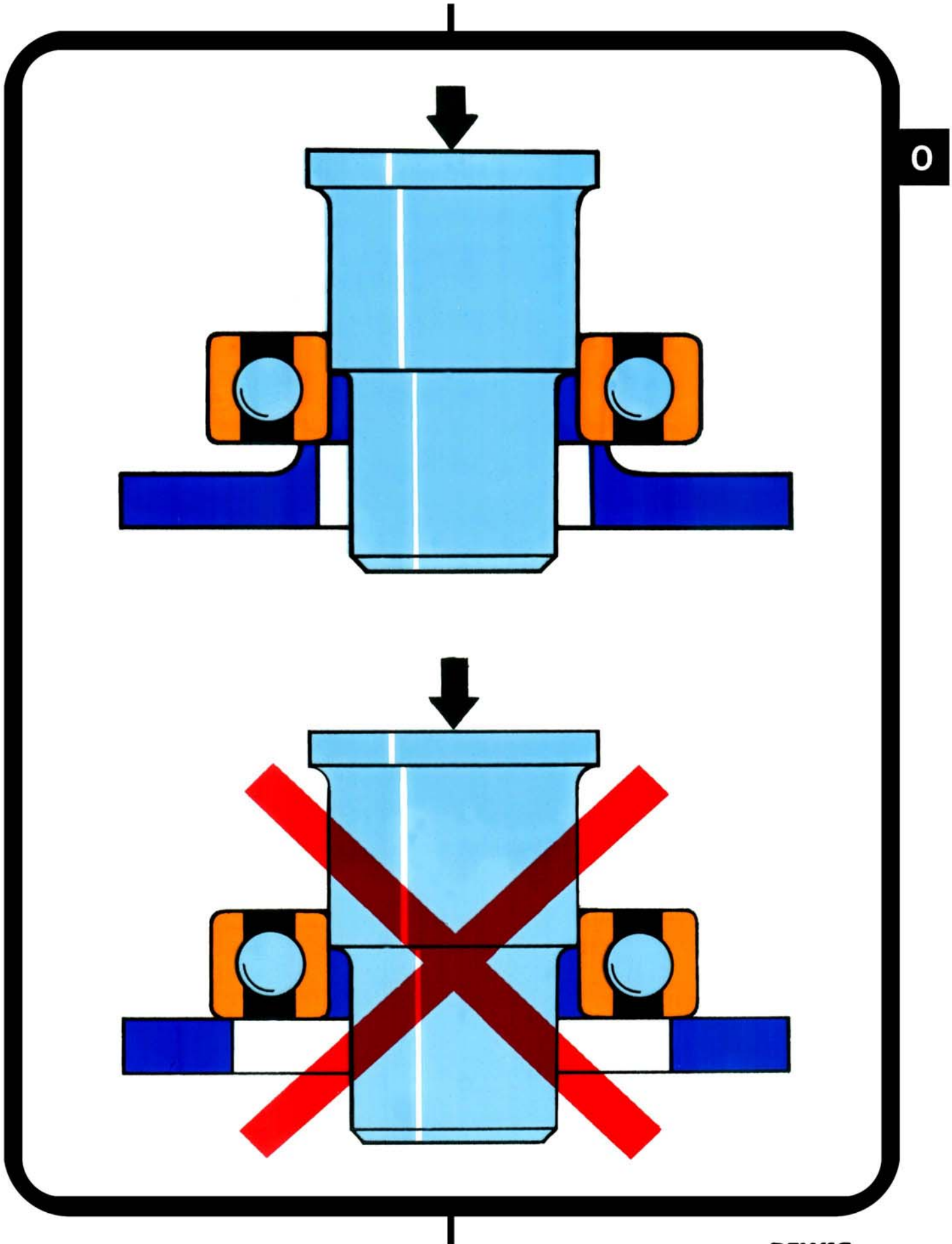

1. Maschinenelemente - Wälzlager  
Einbau - Montagebüchse, Montagescheibe

FR-MALF 1.12

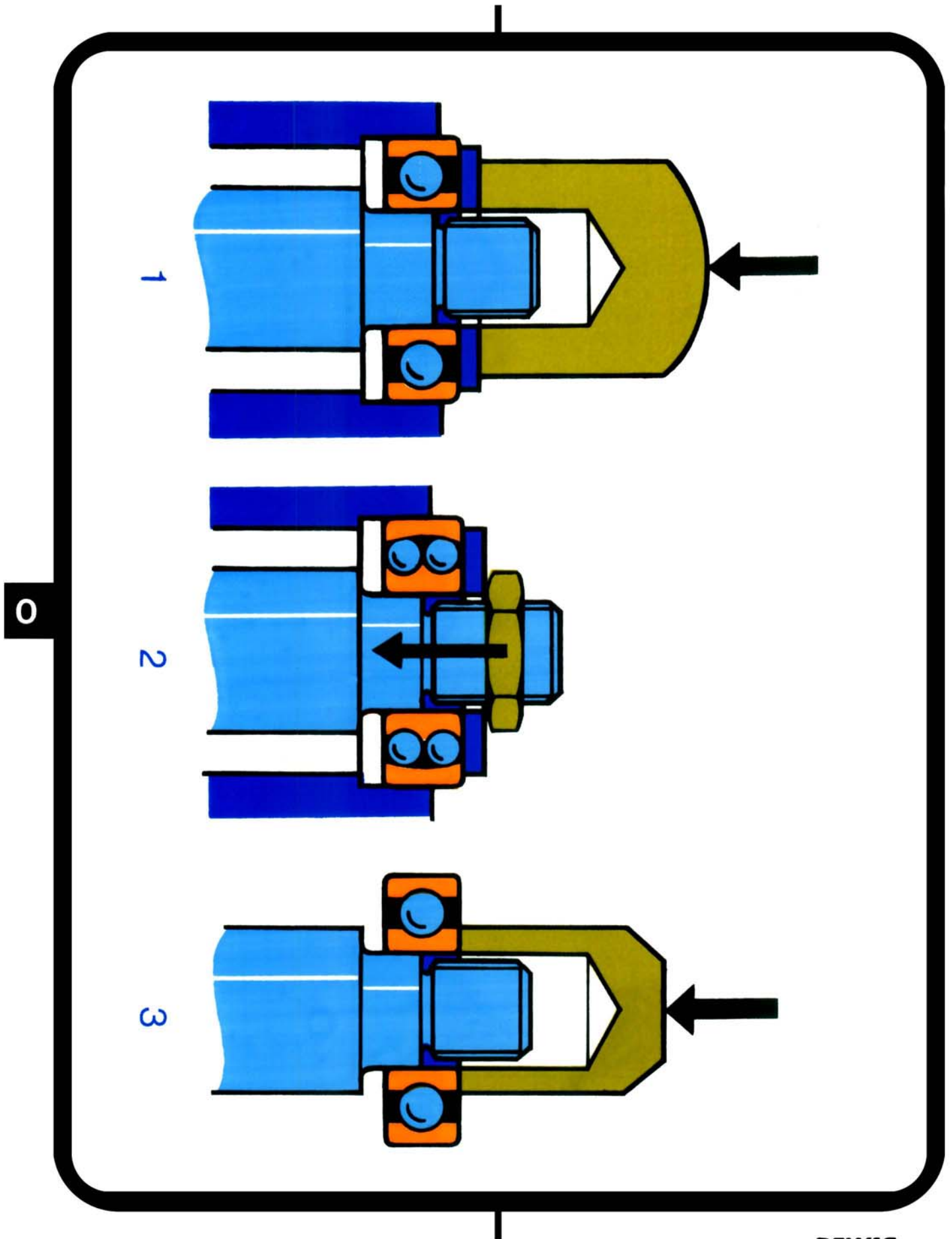

1. Maschinenelemente - Wälzlager  
Einbau - Hydraulikmontage

FR-MALF 1.13.

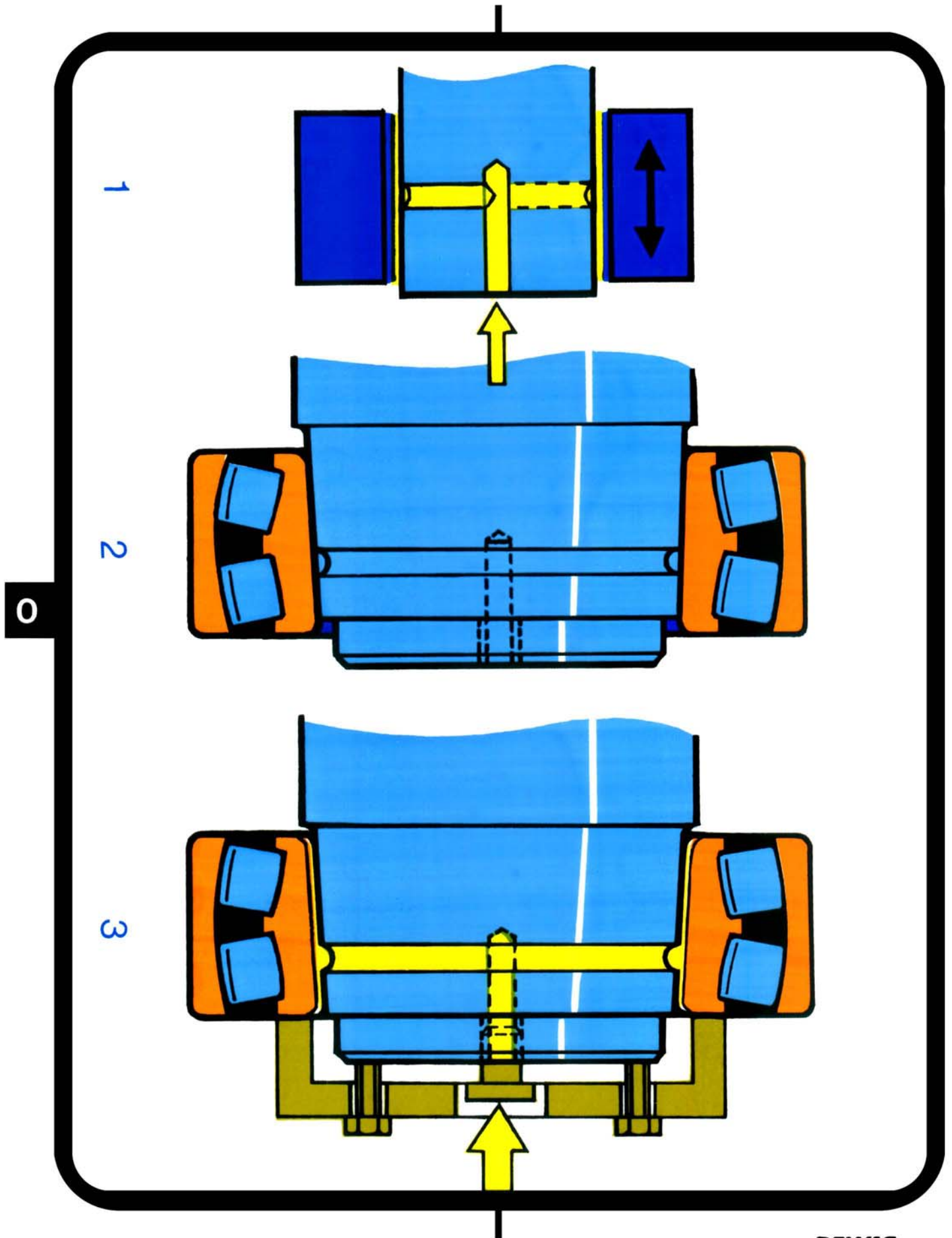

1. Maschinenelemente - Wälzlager  
Ausbau - Abziehvorrichtung. Auspreßvorrichtung

FR-MALF 1.14.

0

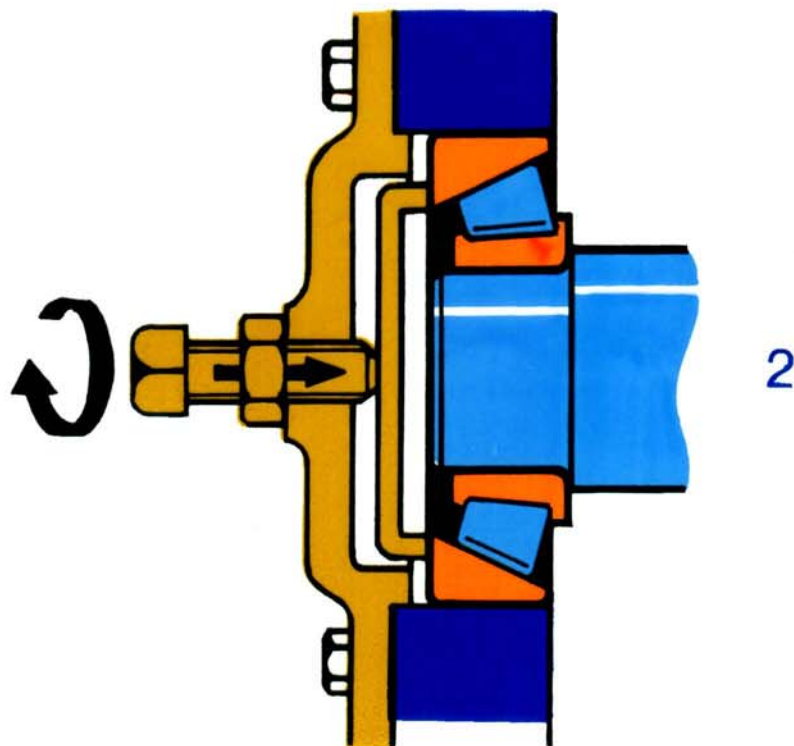
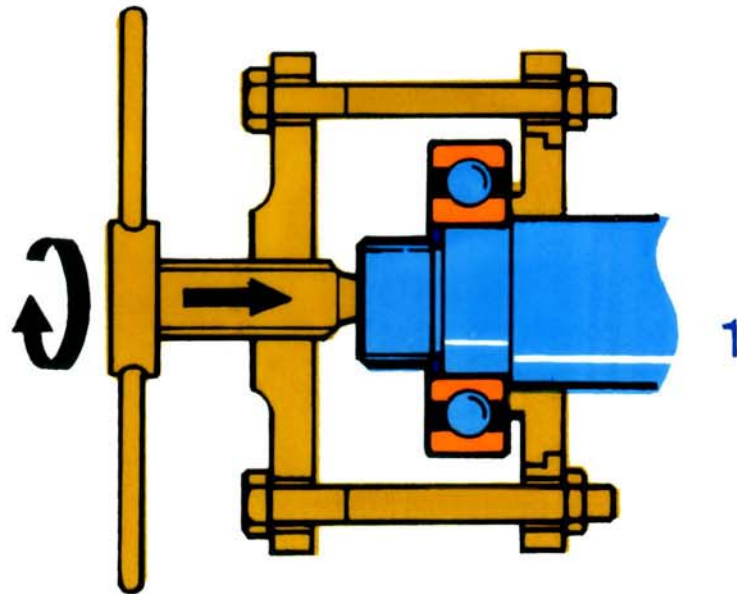

# 1. Maschinenelemente - Wälzlager

FR-MALF 1.15.

Ausbau durch Schlag, mittels Abziehhülse, hydraulisch

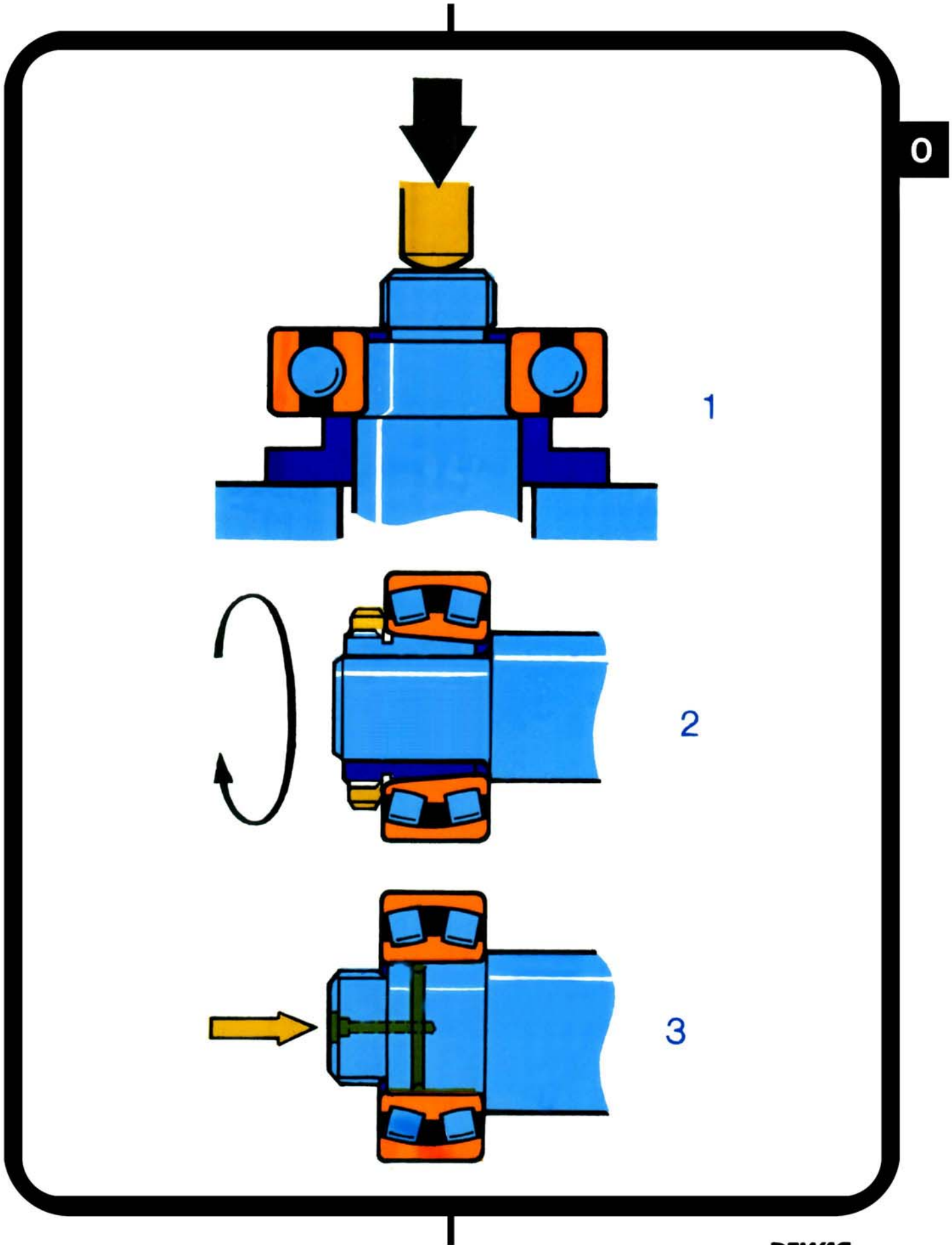

0