

[Home](#) > [ar.cn.de.en.es.fr.id.it.ph.po.ru.sw](#)

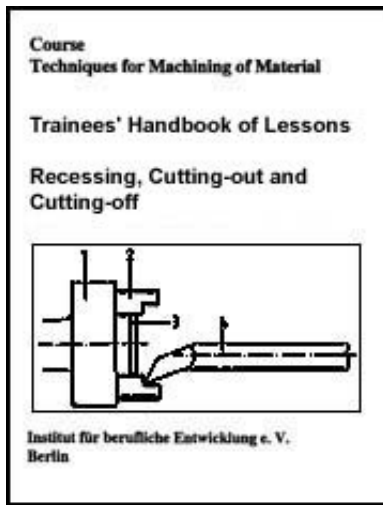

➔ **Recessing, Cutting-out and Cutting-off - Course: Techniques for machining of material. Trainees' handbook of lessons (Institut für Berufliche Entwicklung, 17 p.)**

📄 **(introduction...)**

- 📄 **1. Purpose and importance of recessing, cutting-out and cutting-off**
- 📄 **2. Design and types of turning tools to be used**
- 📄 **3. Preparation of recessing, cutting-out and cutting-off**
- 📄 **4. Recessing of external and internal grooves**
- 📄 **5. Cutting-out of disks and rings**
- 📄 **6. Cutting-off of solid stock and hollow parts**



[Home](#) > [ar.cn.de.en.es.fr.id.it.ph.po.ru.sw](#)

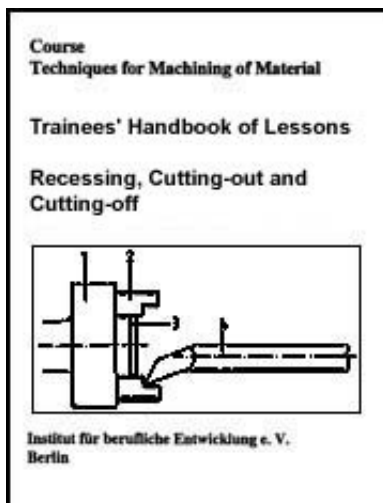

📖 **Recessing, Cutting-out and Cutting-off - Course: Techniques for machining of material. Trainees' handbook of lessons (Institut für Berufliche Entwicklung, 17 p.)**

➔ 📄 **(introduction...)**

- 📄 **1. Purpose and importance of recessing, cutting-out and cutting-off**
- 📄 **2. Design and types of turning tools to be used**
- 📄 **3. Preparation of recessing, cutting-out and cutting-off**



4. Recessing of external and internal grooves



5. Cutting-out of disks and rings



6. Cutting-off of solid stock and hollow parts

**Institut fr berufliche Entwicklung e. V.
Berlin**

**Original title:
Arbeitsmaterial fr den Lemenden
"Ein-, Aus- und Abstechen"**

Author: Horst Kth

First edition © IBE

**Institut fr berufliche Entwicklung e.V.
Parkstrae 23
13187 Berlin**

Order No.: 90-35-3204/2







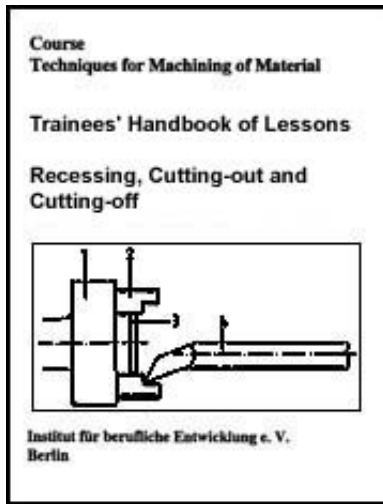

[Home](#) > [ar](#).[cn](#).[de](#).[en](#).[es](#).[fr](#).[id](#).[it](#).[ph](#).[po](#).[ru](#).[sw](#)



**Recessing, Cutting-out and Cutting-off - Course: Techniques
for machining of material. Trainees' handbook of lessons
(Institut fr Berufliche Entwicklung, 17 p.)**



-  **(introduction...)**
- 1. Purpose and importance of recessing, cutting-out and cutting-off**
 -  **2. Design and types of turning tools to be used**
 -  **3. Preparation of recessing, cutting-out and cutting-off**
 -  **4. Recessing of external and internal grooves**
 -  **5. Cutting-out of disks and rings**
 -  **6. Cutting-off of solid stock and hollow parts**

1. Purpose and importance of recessing, cutting-out and cutting-off

Recessing, cutting-out and cutting-off are turning techniques often used.

These techniques permit intricate shapes to be produced.

The recessing (necking, grooving) technique as metal-cutting operation serves to produce

- undercuts for the production of threads,**
- recesses in circumferential surfaces or hollow parts for grinding of simple and intricate workpieces,**
- grooves for intricate machine parts, such as grooves for V-belts, oil grooves, snap rings, annular grooves.**

Cutting-out can be used for cylindrical turning of sheet-metal parts and for economical production of rings from solid material with savings in material (cut-out material can be used for further processing). The cutting-out technique as metal-cutting operation serves

- to machine intricate sheet-metal parts which shall be turned cylindrically,
- to produce rings from solid material,
- to prevent deformations of thin-walled rings.

The **cutting-off (parting-off) technique as metal-cutting operation serves to**

- economically produce workpieces from bar stock with the shape, dimensions and surface finish required.



[Home](#) > [ar](#).[cn](#).[de](#).[en](#).[es](#).[fr](#).[id](#).[it](#).[ph](#).[po](#).[ru](#).[sw](#)

 **Recessing, Cutting-out and Cutting-off - Course: Techniques for machining of material. Trainees' handbook of lessons (Institut fr Berufliche Entwicklung, 17 p.)**



 **(introduction...)**

 **1. Purpose and importance of recessing, cutting-out and cutting-off**

 **2. Design and types of turning tools to be used**

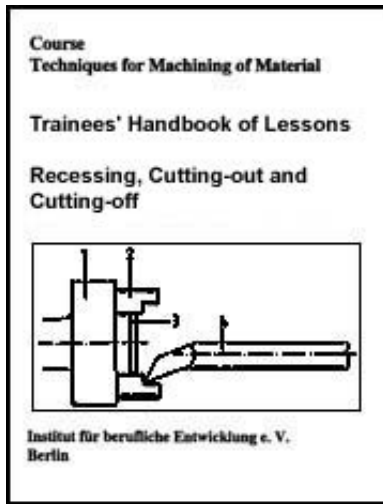



-  **3. Preparation of recessing, cutting-out and cutting-off**
-  **4. Recessing of external and internal grooves**
-  **5. Cutting-out of disks and rings**
-  **6. Cutting-off of solid stock and hollow parts**

2. Design and types of turning tools to be used

For recessing, cutting-out and cutting-off the end-cut turning tool and hook tool are mostly used.

The end-cut turning tool is used for machining on the circumferential surface. The hook tool serves to machine hollow parts.

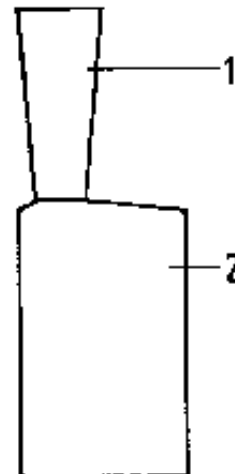

Figure 1 Right-hand end-cut turning tool

- 1 tool point (or tool nose)
- 2 shank

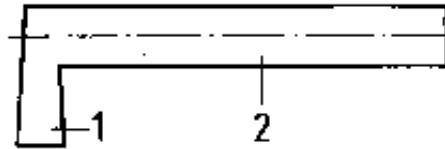

Figure 2 Hook tool

- 1 tool point (or tool nose)
- 2 shank

What are the main components of an end-cut turning tool?

1. _____
2. _____

For special shapes of grooves and recesses, the turning tools to be used are ground to suit the shape to be produced.

In order to maintain the shape of the cutting portion and to save cutting tool material, the end-cut turning tool is reground on the cutting face only.

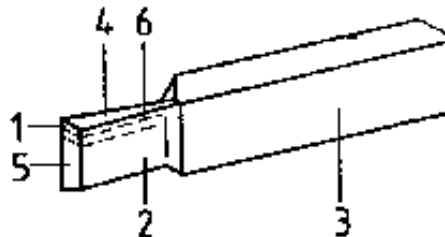

Figure 3 Right-hand end-cut turning tool

- 1 side-cutting edge (or primary cutting edge),**
- 2 end flank,**
- 3 shank,**
- 4 cutting face,**
- 5 flank,**
- 6 regrind**

When grinding the end-cut turning tool, special attention is to be paid to maintaining the angles.

The following rules are to be observed:

- Length of the cutting portion depends on the depth of the recess to be produced.**
- Clearance angle and rake angle depend on the material of the workpiece.**
- Tapering from front to rear and top to bottom to avoid jamming.**

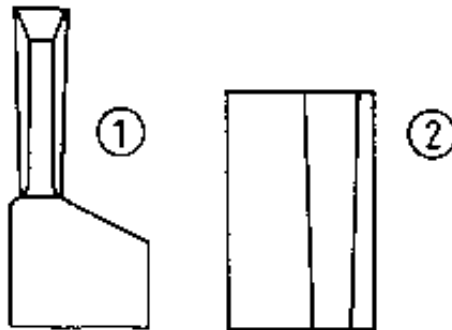

Figure 4 Tapering of cutting edges

(1) from front to rear

(2) from top to bottom

- For cutting-out and cutting-off the primary cutting edge is ground obliquely so that the corner of the edge facing the workpiece is slightly leading. This avoids hooking or breaking off when parting, and no parting-off flash is left on the workpiece.

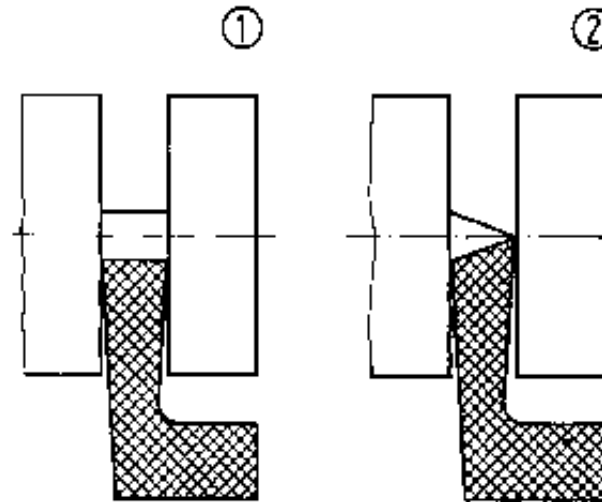

Figure 5

(1) unfavourable shape of cutting edge

(2) correct shape of cutting edge

In order to guarantee economical machining of large quantities of workpieces, a special grinding angle (roof type) is used for the cutting-off tool which permits the tool life to be increased and high cutting speeds to be used.

- For cutting-out, a special grinding angle is applied to the secondary cutting edge to avoid "dragging".

Re-grinding at the side weakens the end-cut turning tool. It results in high wear and the danger of breaking off.

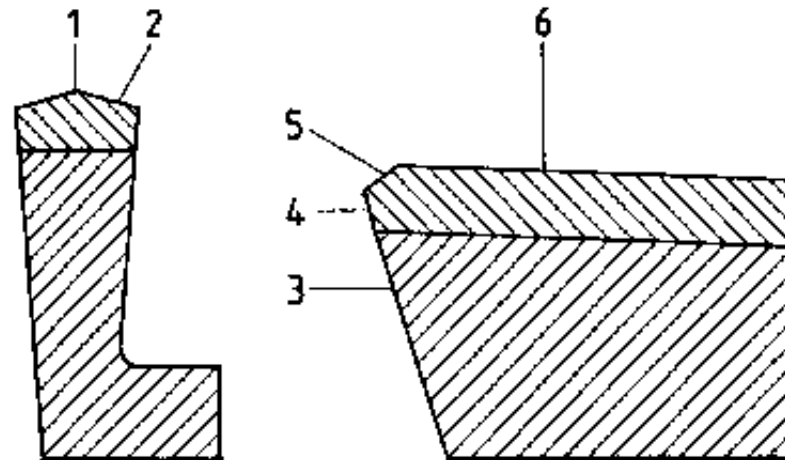

Figure 6 End-cut turning tool with roof-type grind

- 1 cutting relief 0.1 - 0.2,**
- 2 trailing edges 100,**
- 3 flank 12°,**
- 4 tool point 6-8°,**
- 5 tool point 30° x 0.1,**
- 6 cutting face**

The special grind is lapped.

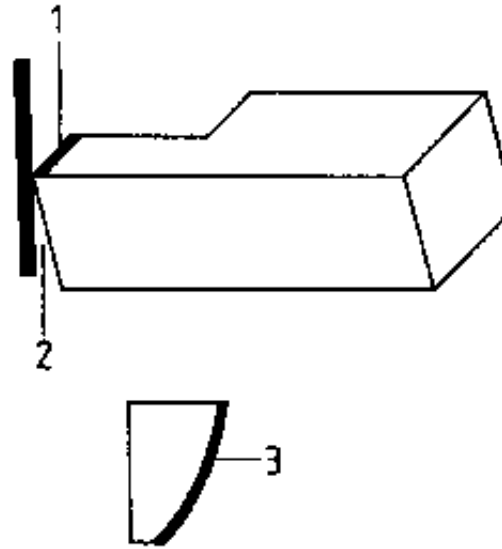

Figure 7 Right-hand end-cut turning tool with special grinding for cutting out

- 1 primary cutting edge**
- 2 flank**
- 3 special grind**

What is to be considered when grinding an end-cut turning tool?

Because of the intricacy of the recesses and of the constantly changing cutting speed in cutting-off, cutting tools of high-speed steel are normally used since carbide-tipped end-cut turning tools often chip.

Why does the cutting speed constantly change when the cutting edge of the end-cut turning tool is approaching the centre?



[Home](#) > [ar](#).[cn](#).[de](#).[en](#).[es](#).[fr](#).[id](#).[it](#).[ph](#).[po](#).[ru](#).[sw](#)

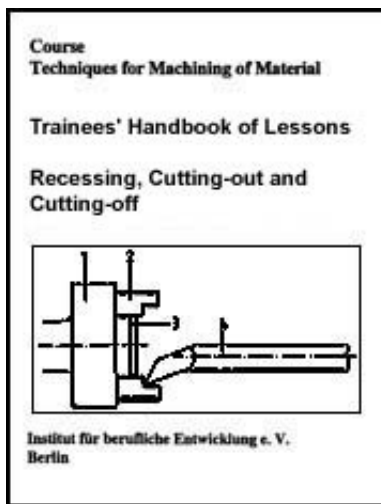

 **Recessing, Cutting-out and Cutting-off - Course: Techniques for machining of material. Trainees' handbook of lessons (Institut für Berufliche Entwicklung, 17 p.)**

 **(introduction...)**

 **1. Purpose and importance of recessing, cutting-out and cutting-off**

 **2. Design and types of turning tools to be used**

 **3. Preparation of recessing, cutting-out and cutting-off**

 **4. Recessing of external and internal grooves**

 **5. Cutting-out of disks and rings**

 **6. Cutting-off of solid stock and hollow parts**

3. Preparation of recessing, cutting-out and cutting-off

The preparation of the relevant operations includes to properly and duly make available all tools, materials and auxiliary means needed.

In doing so, the following rules are to be observed:

- **Check the tools for serviceability. Use serviceable tools only.**
- **Tools to be used must not be placed one above another.**
- **Store tools in clean condition.**
- **Store measuring and testing tools on adequate supports only.**
- **Select the necessary auxiliary means according to the work order and place them at disposal on adequate supports (sup-ported plates for turning tools, boring rings, live centre, stop, block gauge, chuck key, stationary steady rest).**

Never leave the chuck key in the chuck because of danger of accidents when switching on the machine.

What is to be considered when checking the tools for service-ability?

Setting-up of the machine mainly involves the following steps:

- **Clamping/chucking of the workpiece for recessing**
 - **Internal turning (turning out) of soft chuck jaws since the parts to**

be turned are already pre-machined.

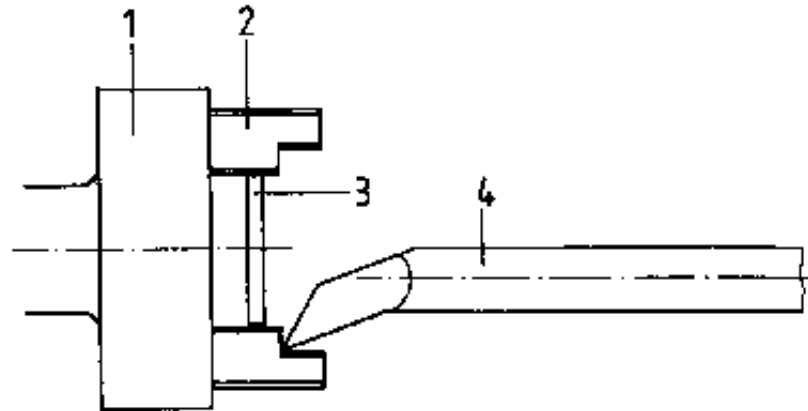

Figure 8 Internal turning of soft chuck jaws

- 1 three-jaw chuck**
- 2 soft chuck jaws**
- 3 boring ring**
- 4 internal side-cutting tool (or boring tool).**

Internal turning of the chuck jaws guarantees true running of the parts and prevents the surface of the parts to be damaged.

- Clamping/chucking of the workpiece for cutting-out .

- Internal turning of soft chuck jaws.**
- Use of thrust pads when machining sheet metal and thin-walled parts.**

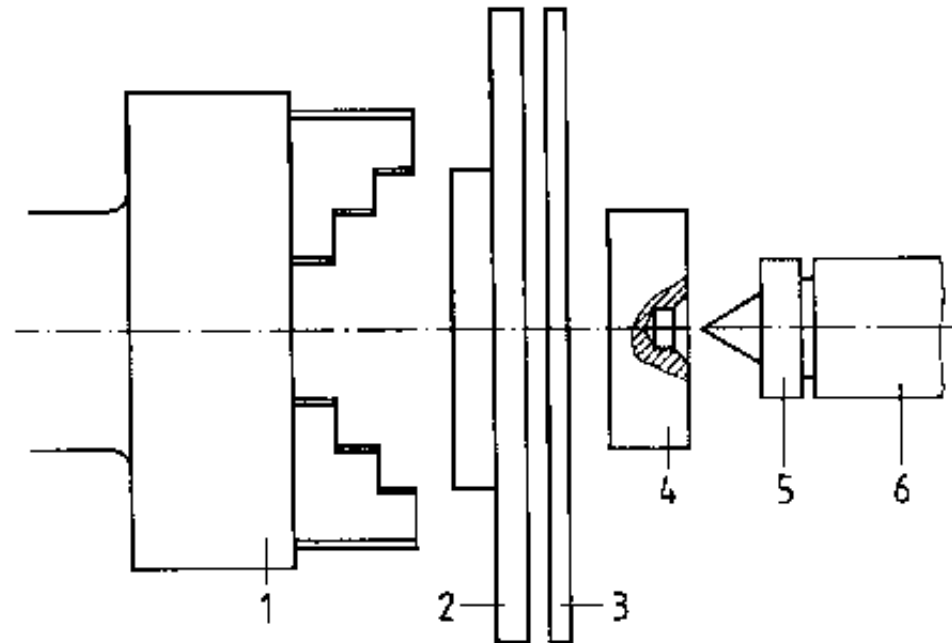

Figure 9 Use of thrust pads

- 1 three-jaw chuck,**
- 2 thrust pad - chucked in three-jaw chuck,**
- 3 workpiece,**
- 4 thrust pad as counter-support,**
- 5 live centre,**
- 6 tailstock sleeve**

- Clamping/chucking of the workpiece for cutting-off

- **Three-jaw chuck and hard chuck jaws (for bar stock).**
- **Internal turning of soft jaws (for pre-machined parts and hollow parts).**

- Clamping of the tools

- **Always ensure short and firm clamping of the end-cut turning tool/hook tool exactly in central position to avoid springing, hooking and breaking off of the tool.**
- **For long, thin workpieces use steady rest, if necessary.**
- **Choose supporting plates of adequate thickness (to avoid clamping with several supporting plates). In case of bad spindle bearing, hooking of the end-cut turning tool can be avoided by clamping the tool upside down and rotating the chuck in anti-clockwise direction.**

When cutting-off with the tool clamped upside down, the chuck is to be secured against getting loose unintentionally.

- Setting of the cutting values

What rotational speed will be necessary for a recess on a 30 mm diameter of a part of St 60 steel using an end-cut turning tool made of high-speed steel?

Formula: _____

given: _____

required: _____

Calculation:

What rotational speed is to be selected for cutting-off disks from St 60 solid stock

of 140 mm diameter? (Turning tool used is made of high-speed steel)

Formula: _____

given: _____

required: _____

Calculation:

Give the reasons for the selection of the speed:



[Home](#) > [ar](#).[cn](#).[de](#).[en](#).[es](#).[fr](#).[id](#).[it](#).[ph](#).[po](#).[ru](#).[sw](#)

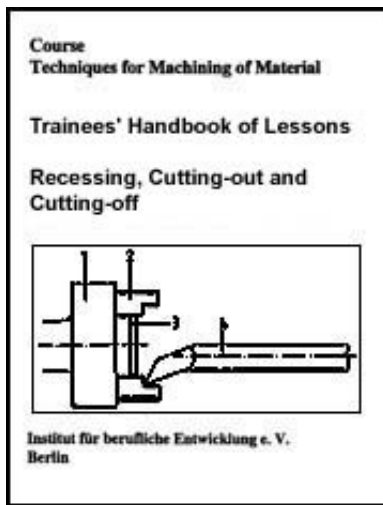

Recessing, Cutting-out and Cutting-off - Course: Techniques for machining of material. Trainees' handbook of lessons (Institut für Berufliche Entwicklung, 17 p.)

(introduction...)

1. Purpose and importance of recessing, cutting-out and cutting-off

2. Design and types of turning tools to be used

3. Preparation of recessing, cutting-out and cutting-off

➔ 4. Recessing of external and internal grooves

5. Cutting-out of disks and rings



6. Cutting-off of solid stock and hollow parts

4. Recessing of external and internal grooves

With the recessing technique the workpieces are machined on the circumferential surface towards the axis of rotation and, in the case of hollow parts, away from the axis of rotation.

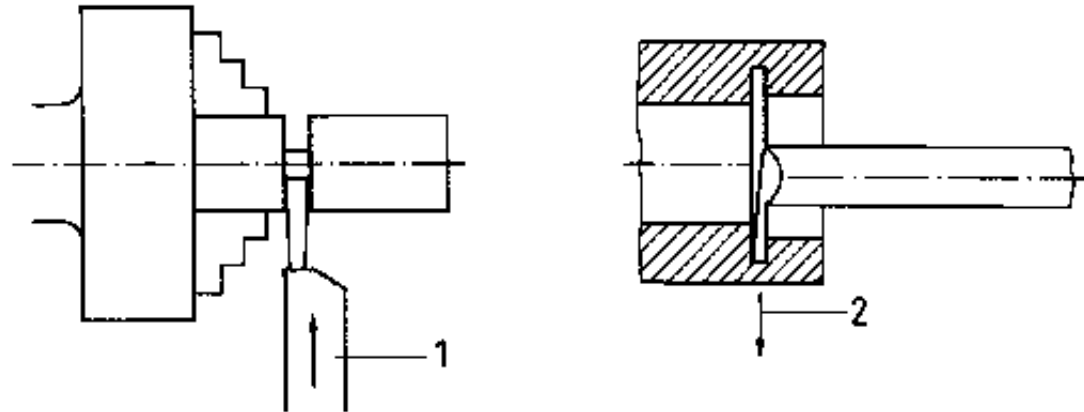

Figure 10 Direction of machining when recessing

1 circumferential surface - towards axis of rotation

2 hollow part - away from axis of rotation

- The part is held in a chuck and for external grooves a live centre is used as counter-support.

- The recess in the circumferential surface is turned by a straight right-hand end-cut turning tool or hook tool.

- The workpiece is to be clamped in internally turned chuck jaws to

guarantee true running of the workpiece and prevent damage to the surface at the points of contact.

- The width of the recess is produced in one operation provided that the end-cut turning tool or hook tool has the exact width.

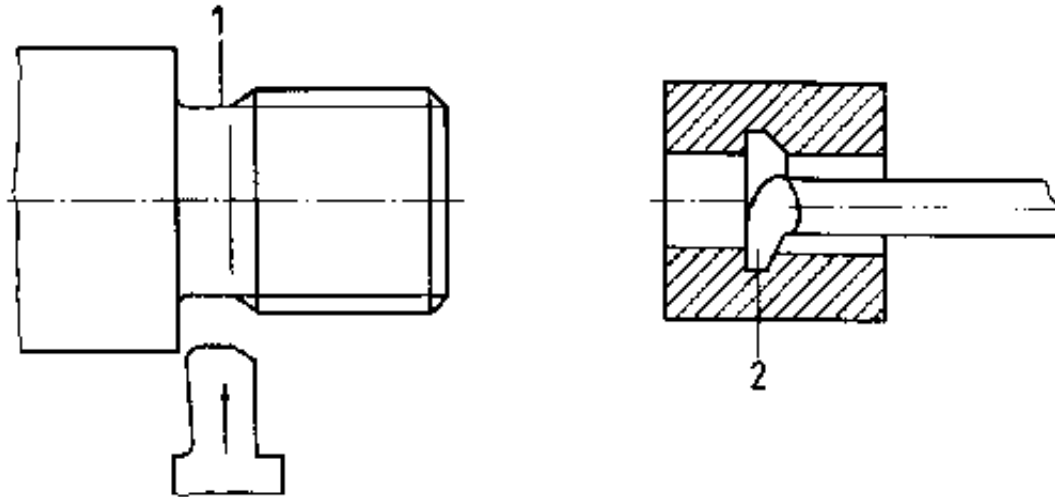

Figure 11 Width of recess in one operation

1 recessing in the circumferential surface

2 recessing in hollow parts

- When recessing thread grooves, grinding of the 60° taper for the thread runout can be done at the same time.

- The exact width of the end-cut turning tool necessitates exact sharpening but guarantees dimensional consistency for many parts and is economical.

- To avoid vibrations, the workpiece and end-cut turning tool or hook tool

should be clamped as short as possible.

- To ensure proper quality, stop and block gauge should be used.

Due to the rotation of the workpiece to be machined, the diameter of the workpiece is doubled by the amount of feed setting.

Do not do any measuring or testing unless the machine is at rest!

What is to be considered when grinding the round corner for the chips to roll off?

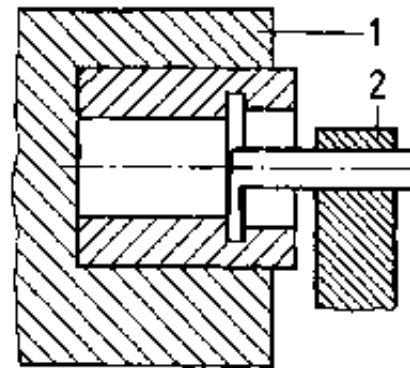

Figure 12 Safe clamping of workpiece and tool

1 clamping of workpiece

2 clamping of turning tool

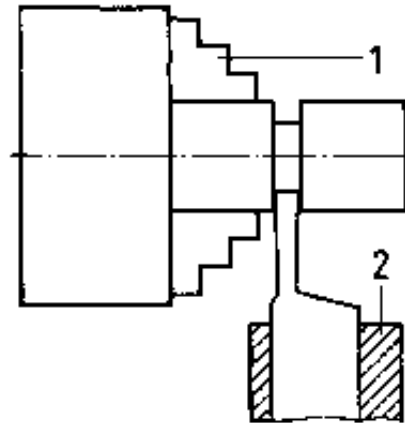

Figure 13 Safe clamping of workpiece and tool

- 1 clamping of workpiece**
- 2 clamping of turning tool**

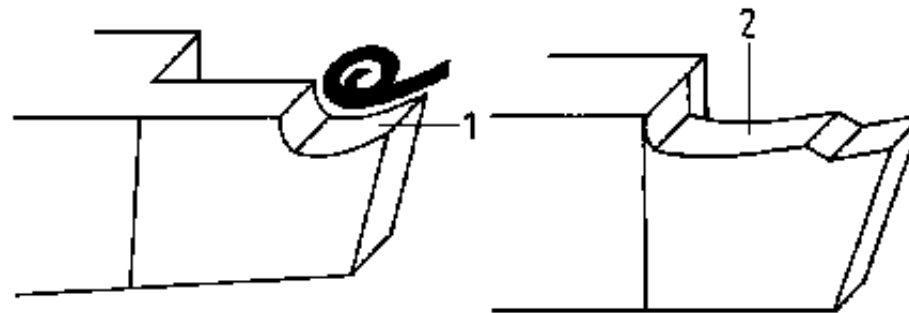

Figure 14 Round (concave) corner for the chips to roll off at the end-cut turning tool

- 1 unfavourable grind,**
- 2 correct grind**

For dimensional checks retract the hook tool sufficiently and cover it by a rag to prevent accidents.



[Home](#) > [ar](#).[cn](#).[de](#).[en](#).[es](#).[fr](#).[id](#).[it](#).[ph](#).[po](#).[ru](#).[sw](#)

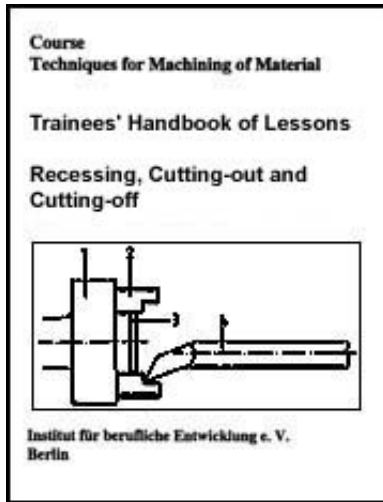

 **Recessing, Cutting-out and Cutting-off - Course: Techniques for machining of material. Trainees' handbook of lessons (Institut für Berufliche Entwicklung, 17 p.)**

 **(introduction...)**

 **1. Purpose and importance of recessing, cutting-out and cutting-off**

 **2. Design and types of turning tools to be used**

 **3. Preparation of recessing, cutting-out and cutting-off**

 **4. Recessing of external and internal grooves**

 **→ 5. Cutting-out of disks and rings**

 **6. Cutting-off of solid stock and hollow parts**

5. Cutting-out of disks and rings

The cutting-out technique involves machining of the workpieces on their end faces and is used for specific jobs. The turning tool is moved in axial direction. The right-hand end-cut turning tool, specially ground, is mostly used (see Fig. 4 - relief-grinding of the secondary cutting edge to avoid "dragging" of the tool).

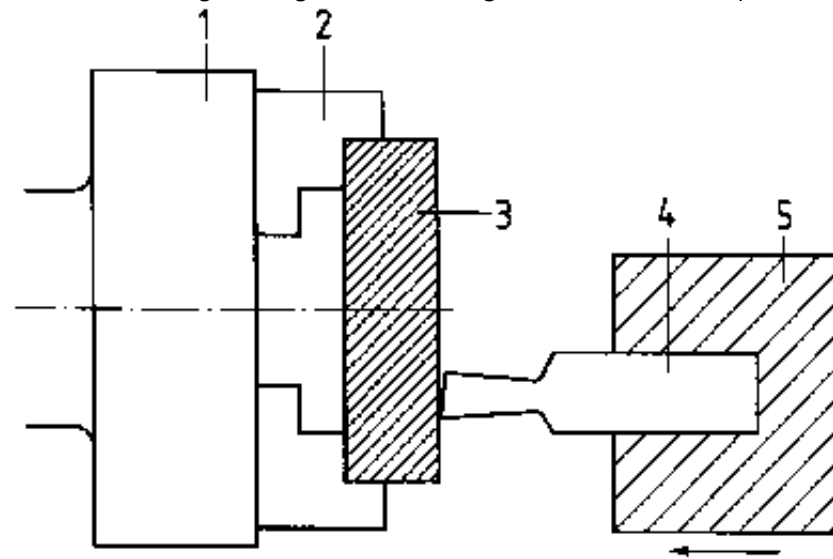

Figure 15 Working direction when cutting-out

- 1 three-jaw chuck,**
- 2 soft chuck jaws,**
- 3 workpiece,**
- 4 end-cut turning tool,**
- 5 turning tool holder**

- The workpiece is chucked in a chuck.**
- The workpiece is held in internally turned chuck jaws.**
- Stop and block gauge are used to avoid cutting-through and, consequently, tool breakage.**
- Cutting-out is completed 0.1 - 0.2 mm before breaking-through and after unloading the cut-out part is knocked out by hammer blows to avoid tool**

breakage and prevent accidents.

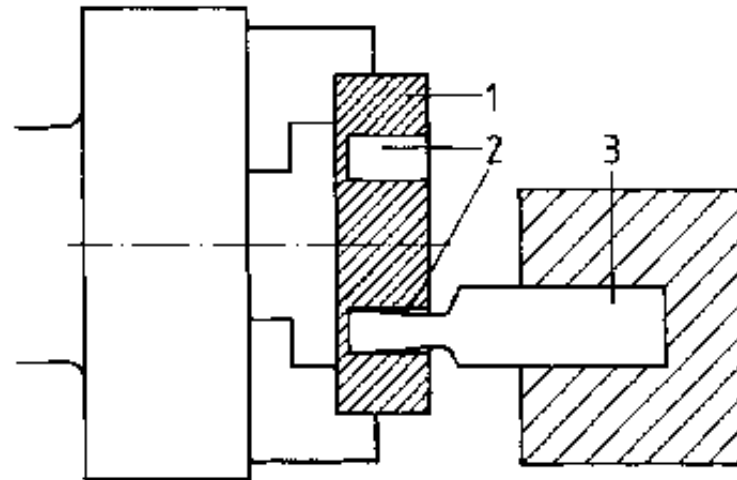

Figure 16 Completion of cutting-out before breaking-through

- 1 workpiece,**
- 2 cutting-out depth 0.1 - 0.2 mm before breaking through,**
- 3 end-cut turning tool**

- Cutting-out of very long workplaces can be done from two ends to add up to the stability of the turning tool.

Which measuring and testing tools are used for cutting-out?



[Home](#) > [ar](#).[cn](#).[de](#).[en](#).[es](#).[fr](#).[id](#).[it](#).[ph](#).[po](#).[ru](#).[sw](#)

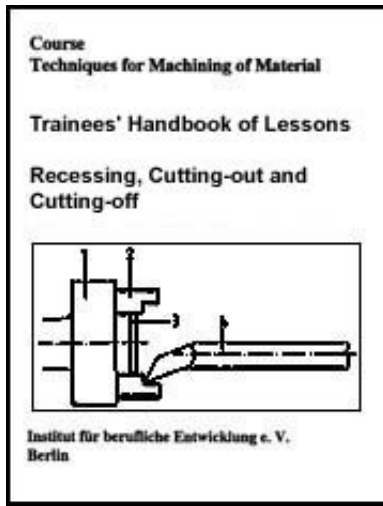

Recessing, Cutting-out and Cutting-off - Course: Techniques for machining of material. Trainees' handbook of lessons (Institut für Berufliche Entwicklung, 17 p.)

 **(introduction...)**

 **1. Purpose and importance of recessing, cutting-out and cutting-off**

 **2. Design and types of turning tools to be used**

 **3. Preparation of recessing, cutting-out and cutting-off**

 **4. Recessing of external and internal grooves**

 **5. Cutting-out of disks and rings**

 **➔ 6. Cutting-off of solid stock and hollow parts**

6. Cutting-off of solid stock and hollow parts

The cutting-off technique involves machining of the workpieces on the circumferential surface towards the axis of rotation until the workpiece is parted.

The right-hand end-cut turning tool is mostly used.

The cutting-off technique as metal-cutting operation is a highly economical way of parting workpieces.

- The parts to be machined are held in a chuck in hard chuck jaws.**

- When cutting-off into solid stock, the turning tool works under similar conditions as with facing of a disk, i.e. the diameter is reduced and, with**

constant rotational speed, the cutting speed is reduced, too.

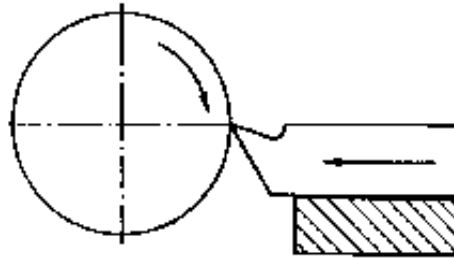

Figure 17 Facing of a disk

With constant rotational speed - reduction in diameter - cutting speed approaching 0.

- **With the turning tool approaching the centre, the cutting speed is approaching the value zero.**
- **The spindle bearing of the lathe must be free from play to avoid hooking and breakage of the turning tool.**
- **The primary cutting edge of the end-cut turning tool is to be ground slightly obliquely so that no parting-off flash will be left on the cut-off part. (Fig. 5 in section 2).**

