

Maintenance & Repair Module 2

Table of Contents

Maintenance & Repair Module 2	1
1. Introduction in Maintenance & Repair Module II.....	2
1.1 Importance of Maintenance in General.....	2
1.2 Examples of Typical Machinery and the Common Repair Tasks.....	2
2. Joining.....	3
2.1 Screw Joints.....	3
2.2 Pin Connections.....	11
2.3 Snap Rings.....	12
2.4 Feather Keys.....	13
3. Rolling Bearings.....	14
3.1 Introduction.....	14
3.2 Components of Bearings.....	15
3.3 Types of Bearing.....	16
3.4 Bearing Properties.....	19
3.5 Bearing Designation System.....	21
3.6 Internal Bearing Clearance.....	25
3.7 Tolerance of Housing and Shaft.....	26
3.8 Bearing Arrangement.....	27
3.9 Axial Location of Bearings.....	30
3.10 Mounting Rolling Bearings.....	31
3.11 Dismounting.....	37
3.12 Storage.....	42
4. Seals.....	42
4.1 Static Seals.....	43
4.2 Dynamic Seals.....	44
4.3 Radial Shaft Seal ("radial lip shaft seal", "lip ring", "oil seal").....	51
5. Repair Job.....	54
5.1 Exercises in Technical Drawing Interpreting.....	54
5.2 General Instructions for a Repair Job within the Workshop.....	58
5.3 Shortcuts on Sketching Machine Parts during Disassembling.....	59
5. Repair Job – Teachers Copy.....	61
5.1 Exercises in Technical Drawing Interpreting.....	61
5.2 General Instructions for a Repair Job within the Workshop.....	65
5.3 Shortcuts on Sketching Machine Parts during Disassembling.....	67
6. Safety.....	69
Final Knowledge Test.....	70
List of Needed Resources.....	75
Additional Information to Maintenance – Regular Threads – Tables.....	76
Additional Overhead Foils.....	80
Assessment of Participants.....	92

Maintenance & Repair Module 2

(32 Hours Course)

With technical assistance from:
GERMAN DEVELOPMENT SERVICE



August 2000

Dear Reader,

I would like to comment this handout, because otherwise you might get a little confused while studying it.

The most important thing to know is, that this handout is developed for a **non-formal** Training Center. The participating government officials and the involved companies were not interested in long-term courses. So, I had to respect the wish of my project partners for a course with this length and was limited on the most important subjects.

One or two of the modules are still under construction. Sorry for this.

DED – Development Worker

General Survey – "Maintenance & Repair"– Module 2 Course

TARGET PARTICIPANTS

min 18 years old, at least High School graduates, experienced workers, supervisors or leadsman

LENGTH OF COURSE

32 hours / 4 days

OBJECTIVES

At the end of the course, the participants should be able to:

- know the importance of maintenance for an industrial plant in general.
- know the common types of bolts, nuts, stud bolts, parallel- and taper pins, keys, snap ring and make use of them.
- know different types of bearings, the tolerances for shaft and housing, the arrangement of bearings, different methods on how to locate them, different mounting and dismounting methods and the tools needed during these operations.
- know the most important types of seals, e.g. face seal, O-ring, Radial shaft ring, V-ring, Labyrinth ring, Packings
- know typical operation materials e.g. lubrications, gaskets, sealing materials, cleaner, cleaning cloth and how to use them efficiently.
- know the importance of safety check and environment conscious before starting a repair job. Use the proper safety procedures and the safety equipment
- Study a typical method on how to repair a machine: Verify, dismount, clean, repair and mount one type of enclosed gear drive. Lubricate the unit and make a test run.

COURSE OUTLINE

THEORY (50 %)	HANDS-ON TRAINING (50 %)	METHOD
<ul style="list-style-type: none"> • Joint Connections • Rolling Bearings • Seals • Repair job procedure • Safety during repair activities 	<ul style="list-style-type: none"> • Dismount a speed reducing gear completely, incl. ball bearings and gaskets • Mount the gear and choose the right lubrications • Assemble the gear together with an electric motor on a mounting plate and align their coupling and make a test run 	<ul style="list-style-type: none"> • Lectures / Discussions • Worksheets • Practical Sessions • Case studies/Group discussions • Videos

1. Introduction in Maintenance & Repair Module II

1.1 Importance of Maintenance in General

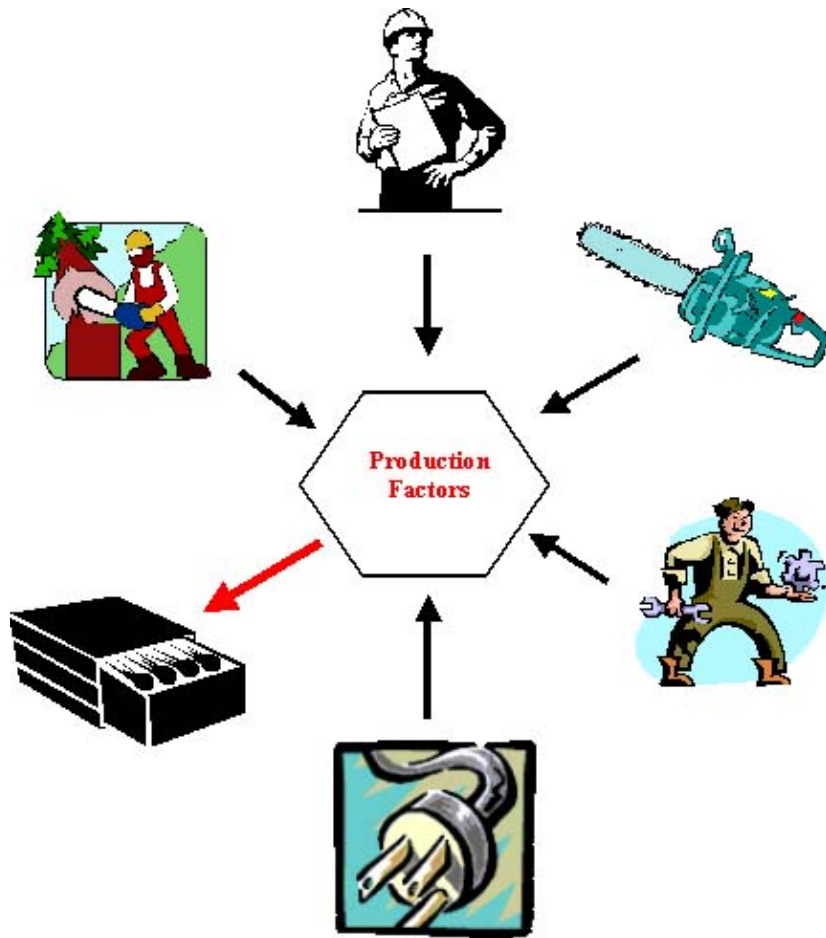

1.2 Examples of Typical Machinery and the Common Repair Tasks

Machine	A	B	F	S	M	L	EM	DB	H	P	RW
Elelectric Motor	X	X	x	X	X	X	X	X			
Gear Drive	X	X	X	X	X	X	X				
Pump	X	X	X	X	X	X	X	X			x
Exhaust Fan	X	X	X	X	X	X	X	X			X

Drier	X	X	X	X	X	X	X		X		X
Disintegrator		X	X	X	X	X	X				X
Centrifuge	X	X	X	X	X	X	X	X	X	X	X
Compressor	X	X	X	X	X	X	X			X	
Injection Moulding	X	X	X	X	X	X			X	X	X
Rollers	X	X	X	X	X	X	X				
Conveyor Belt System	X	X	X	X	X	X					
Stirring Aparatus	X	X	X	X	X	X	X				X

Legend:

- A = Alignment
- B = Ball Bearing
- DB = Dynamic Balancing
- EM = Exact Measurement
- H = Hydraulic
- M = Machine Shop
- S = Sealing
- L = Lubrication
- F = Fastening
- P = Pneumatic
- RW = Repair Welding

2. Joining

The joints we will explain in this chapter can be applied universally as ready-to-mount machine elements. This is especially due to the fact that the dimensions of the popular joints are standardized according ISO (International Standardization Organization).

2.1 Screw Joints

2.1.2 Types of Screws and Bolts

Practically we distinguish screws through the form and size of head, through dimensioning of shaft and thread and through the material from which they are produced.

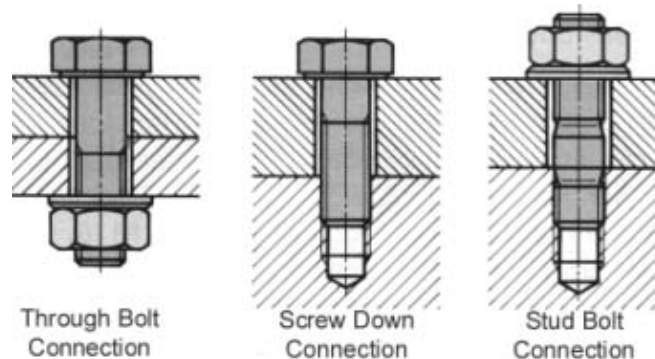

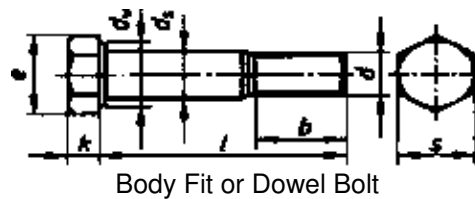
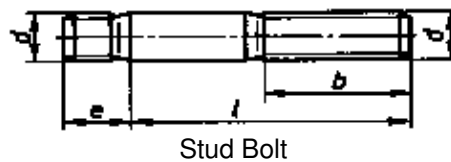
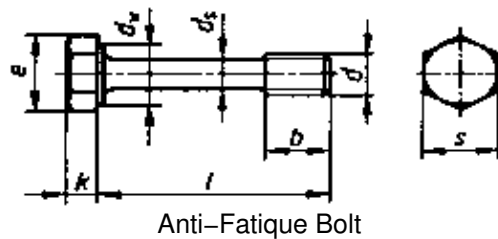
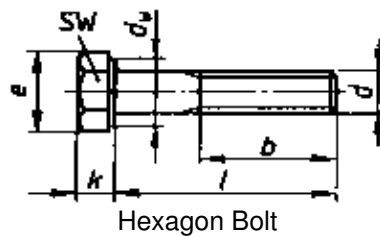
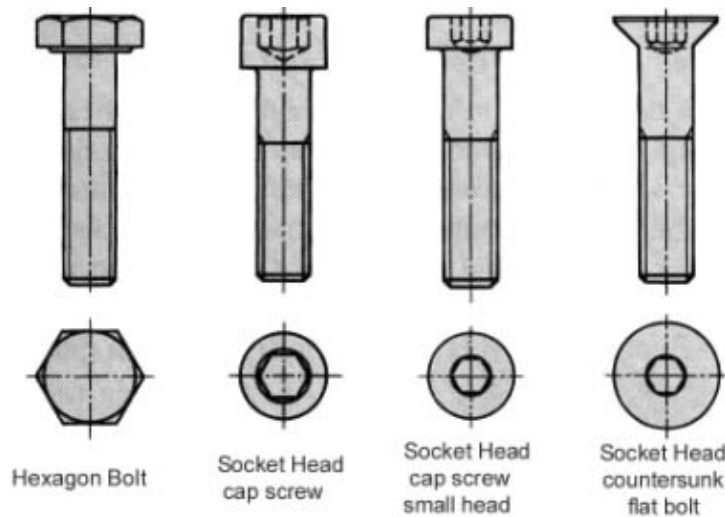

Hexagonal Head Screws and bolts are used with nuts in through holes and without nuts in threaded holes, in which an internal thread is cut in the actual work piece.

Stud Bolts are used if the joint is to be separated frequently. The shorter threaded end of the stud is screwed into the workpiece.

Hexagon Socket Head Screws save space because of their cylindrical heads, which can also be countersunk.

Body-Fit Bolts are used if movement between the workpieces must be prevented, and shear forces are high. Their shank diameter is slightly higher than the thread diameter.

Anti-Fatigue Bolts are used in screwed joints subject to continuous alternating loads. The anti-fatigue bolts are tightened with wrench to a specific value specified by the manufacturer. Anti-fatigue bolts have a longer life under the condition of alternating loads than normal bolts.

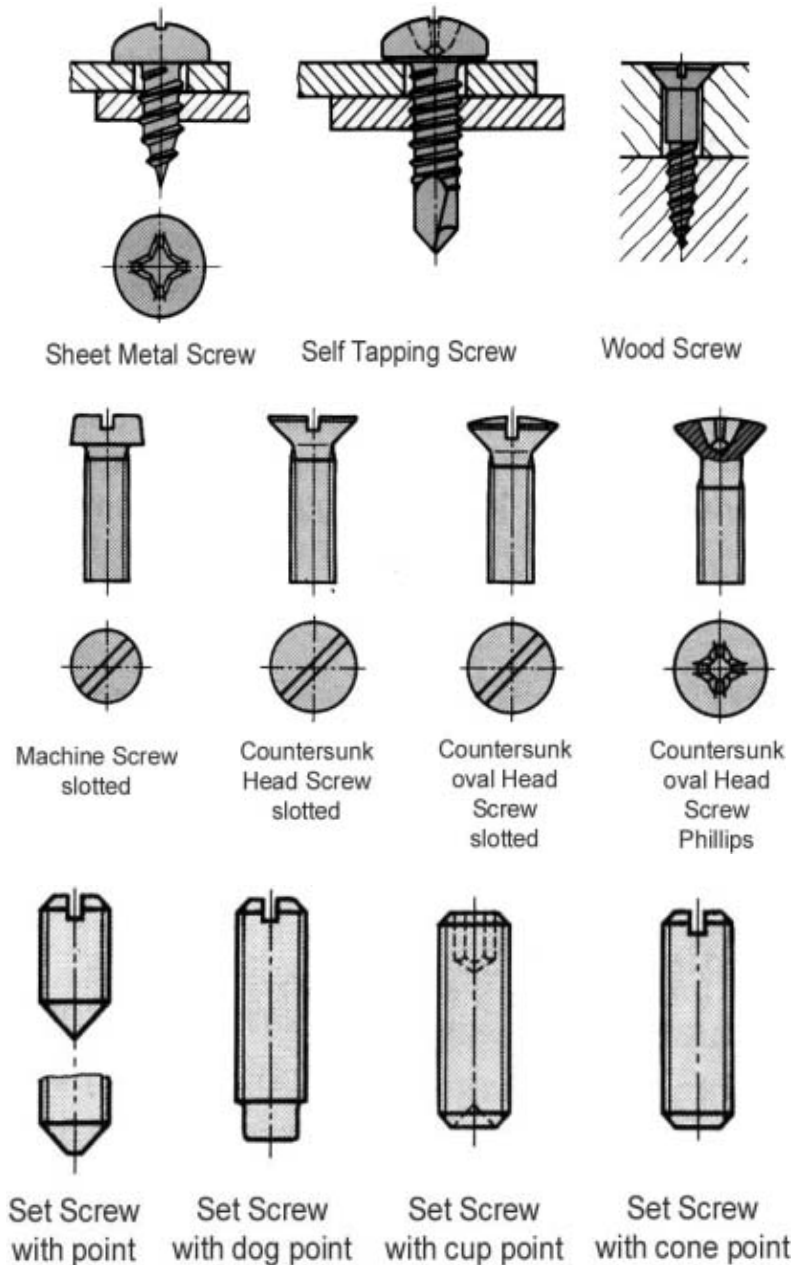

Slotted Head Screws and cross-recessed (Phillips head) screws can have various head patterns: half round (domed head), cheesehead, countersunk, raised cheesehead or raised countersunk

Set Screws are screws without a head, threaded for their entire length. Depending on the application they can have various ends: coned point, full dog point, cupped point. Grub screws (setscrews) are used for the clamping or locking of hubs, bushes or bearings.

Wood Screws are available with slotted, square or hexagonal heads. They are used for joints between wooden parts.

Sheet Metal Screws (self-tapping screws) are used to make joints with sheet metal. Their threads are similar to wood screws. As they are tightened, they cut their own thread in the sheet metal. The hole in the sheet should have the same diameter as the core of the screw. Clamp nuts (sheet-metal nuts) are also frequently used. The joints are vibration-resistant and can be separated any number of times. Sheet metal screws are available with slotted, cross-recessed or hexagonal heads.

Thread Bushes are used if the thread is to be cut in a soft material and/or if the screwed joint has to be detached often.

Thread Inserts (Heli-Coil) are used if the thread already cut in the workpiece has been damaged. Thread inserts consist of a rhomboid-form chrome nickel steel wire formed into a coil to produce an inner and an outer thread. Procedure to repair a damaged thread:

- Drill out the damaged threads using the drill size specified in the manufacturers catalog

- Tap the hole using the special Coil Tap specified in the manufacturers catalog
- Install the replacement Coil. Wind the Coil into the hole. To brake the tang using the recommended special tool.

2.1.2 Designation of Screws, Bolts and Nuts

The designation of all screws, bolts and nuts are world wide standardized in the **ISO Norm**:
For further information ask your supervisor or your supplier.

Example for Hexagon Bolt:

Hexagon Bolt ISO 4017 M12 x 80 – 8.8

ISO 4017 = Specific ISO Norm

M12 = Metric thread 12 mm outside diameter

80 = Length of Shaft is 80 mm

8.8 = Tensile Grade 800 N/mm², Offset Yield Stress 640 N/mm²

Property Classes for Bolts:

Steel screws are marked with the manufacturer's symbol and the strength rating. This consists of two numerals separated by a point, for example 8.8. The first number is one-hundredth of the minimum tensile strength in N/mm², in our example the strength of 800 N/mm². The second number is ten times the apparent yield point ratio. Just multiply the first number with the second number (8 x 8 = 64) and multiply it by ten (10 x 64 = 640 N/mm²).

Property Class	3.6	4.6	4.8	5.6	5.8	6.8	8.8	10.9	12.9
Tensile Grade in N/mm ²	300	400	400	500	500	600	800	1000	1200
Offset Yield Stress in N/mm ²	180	240	320	300	400	480	640	900	1080

2.1.3 Materials for Bolts and Nuts

- Black (standard bolt)
- Chrome-plated
- Nickel-plated
- Black finishing (Gunmetal look)
- Zinc coated (galvanized)



2.1.4 Minimum Screw-In length for bolts

To give a bolt connection its full strength, the minimum screw-in length should be at least 1 times the outside diameter of the thread.

Minimum screw-in length = 1 x D of thread

2.1.5 Nuts

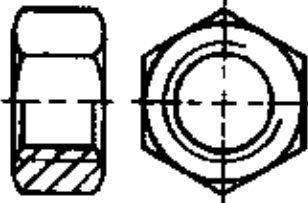
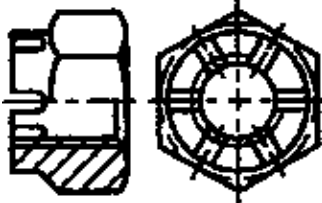
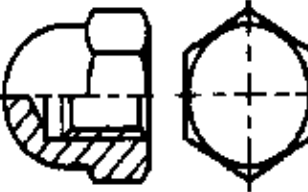
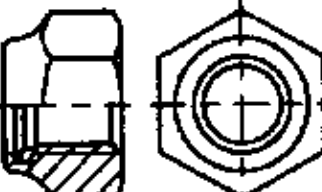
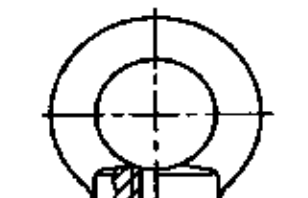
Type	Use	Type	Use
-------------	------------	-------------	------------

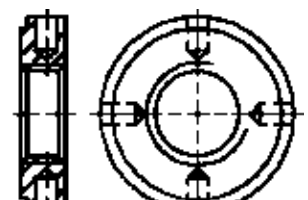
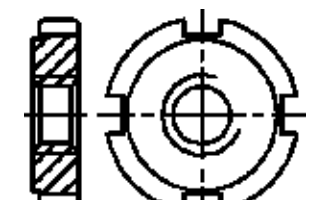
	<p>Hexagon Nut For general use in combination with all kind of bolts. Thickness of about $0.8 \times d$</p>		<p>Castle Nut To secure the bolt connection with split-pin</p>
	<p>Cap Nut · Protection for the end of the thread · Protection against injury</p>		<p>Self-locking Nut with plastic Ring This type will protect the bolt connection against loosening</p>
	<p>Ring Nut or Lifting Eye Ring for transportation of equipment</p>		<p>Wing Nut For often to loose/ fasten bolt connections. Can be tightened by hand.</p>
	<p>Capstan Nut (Cross Hole Nut) For adjustment of axial play and for fixing bearings on shafts</p>		<p>Groove Nut For adjustment of axial play and for fixing bearings on shafts</p>

2.1.6 Bolt Connection Locking

Screw joints are subject to vibration. They can loosen by themselves. Screw lockings are necessary and specified when human lives or expensive/sensitive equipment depend upon stability of such joints, e.g. in motor vehicles, elevators.

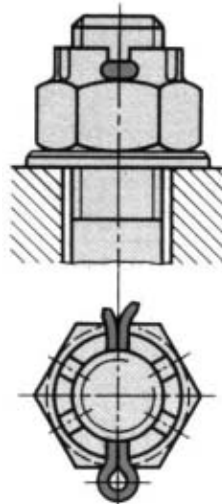

Castel Nut with split-pin

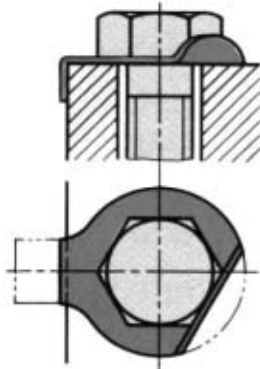

Locking Plate tongued outside

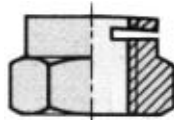

Self-locking Nut with slit

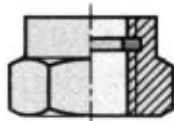

Self-locking Nut with plastic ring

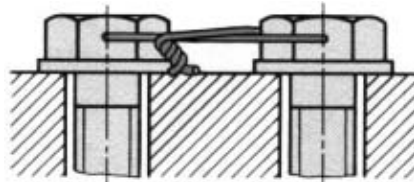

Screw locking with wire

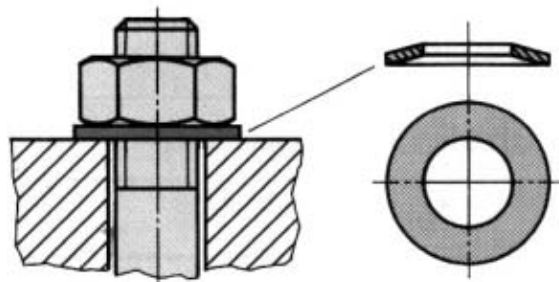

Conical Spring Washer



Counter-Nuts

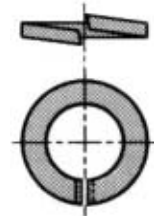

Lock Washer



Tooth Lock Washer



Fan Type Lock Washer

Spring **washers** and toothed or **serrated lock washers** apply a load to the nut and also bite into its surface and that of the workpiece. Convex or corrugated spring washers are also used. In the case of double nuts (locknuts, counter-nuts or check nuts), the top nut elongates the end of the screw or bolt within the elastic range as it is tightened down against the lower nut. This presses the two nuts together and prevents them from coming loose.

Lock **washers** are made from thin steel sheet. If a **wire keeper** is specified, a soft steel wire is inserted through holes in the screw head and twisted to tighten it. The wire must be attached in such a way that it is stressed in tension if a screw tends to work loose.

Castle nuts can be locked very reliably by means of split pins. However, the range of adjustment is limited by the number of slots on the nut.

Elastic stop nuts (self-locking nuts) have a firmly located polyamide ring at the end of the thread, which is pressed into the bolt threads when the nut is screwed on, and prevents the screwed joint from working loose. The friction exerted by the polyamide ring means that greater tightening torque is required. These nuts must be used only once.

One common method of locking bolt connections is the use of glue (**LOCTITE**). The bolt thread and the female part of the thread must be free of oil, grease or any other contamination.

2.1.7 Screw Tightening Tools

Screwdrivers with a plain blade are used for slotted-head screws. To prevent damage to the screw head, the screwdriver blade must be of the correct width and thickness. It must be flat and not ground to a wedge shape. For the various types of cross-recesses screws there are special patterns of screwdriver.

The force exerted by a spanner or wrench should be sufficient to obtain an adequately firm screwed joint after tightening, with no risk of overstressing or stripping the thread. This can occur if the spanner is extended by attaching a length of tube to its handle, in which case the thread may well be damaged beyond repair. Spanners should always be an exact fit on the bolt head or nut.

If the spanner is too large, the bolt head or nut will be damaged and will tend to become round, so that even the correct size of spanner no longer fits; furthermore, a slipping spanner could cause an accident.

Torque wrenches indicate the amount of torque being exerted on a suitably calibrated scale. If the values

specified by the automobile manufacturer, for instance, are adhered to, all threaded connections on the vehicle will be tightened correctly.

Screws and nuts should not be tightened with too much force or they may be damaged; if they are too loose, on the other hand, they could fail to grip and work loose.

Most torque wrenches can be set to a definite value. If this is exceeded, the wrench slips and therefore cannot overtighten the joint. There are many plug-in heads and inserts for torque wrenches, particularly for tightening various sizes of hex bolts and nuts.

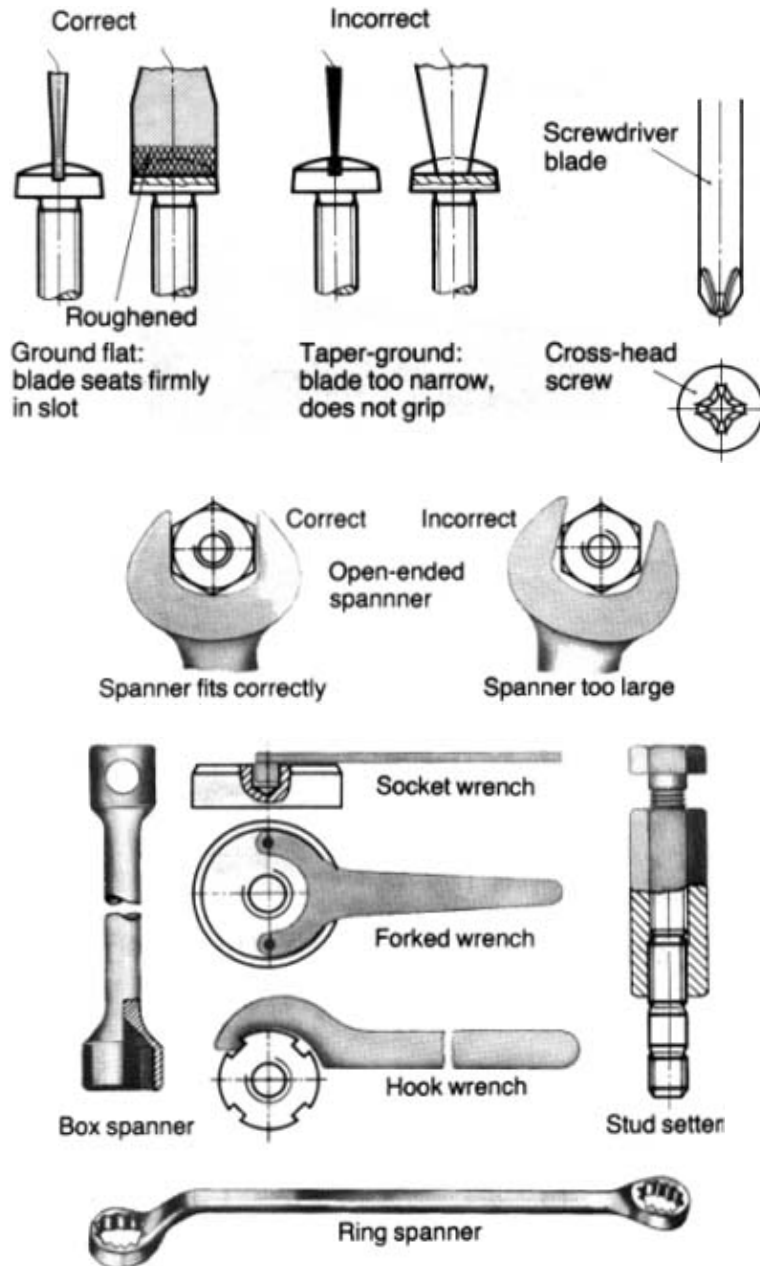

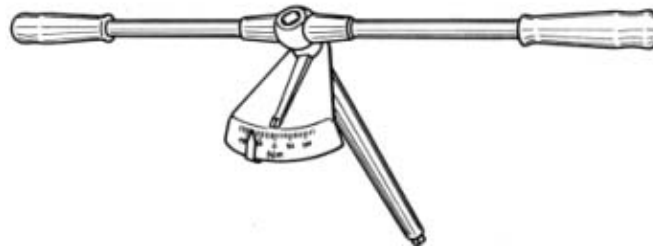

Torque Wrench

2.2 Pin Connections

Pin connections fulfill two functions:

- a) Connection of components such as hand wheels, small gears, cranks, etc., to shafts
- b) Fixing components such as housing covers, stops, parts of cutting tools, etc., against shifting and to ensure that they occupy their original position, even after detaching and reassembling. Pins are subject to shearing stress.



Hardened Dowel Pin

$\nabla 1.50$

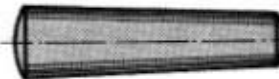

Taper Pin



Dowel Pin

$\nabla 1.50$



Taper Pin with locking thread



Connection Pin

$\nabla 1.50$

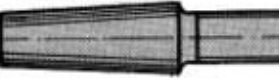

Taper Pin with drawing thread

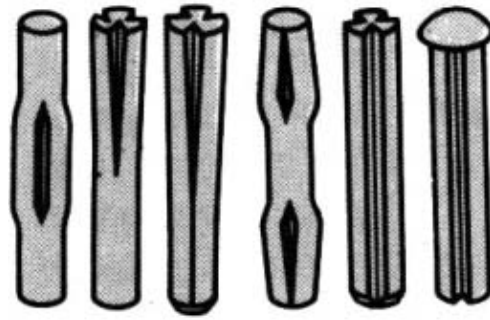

Grooved Pins

2.3 Snap Rings

Snap Rings (Seeger Rings) can absorb great axial forces. The grooves for the ring must be sharp-edged and machined precisely according to measurement tables. Those tables are following the world wide accepted ISO standard. For further information ask your supervisor or check with the supplier manual.

To measure and order a snap ring just measure for shafts, the shaft diameter. For holes, just measure the hole diameter. In addition measure the thickness of the ring.

Space for Installation

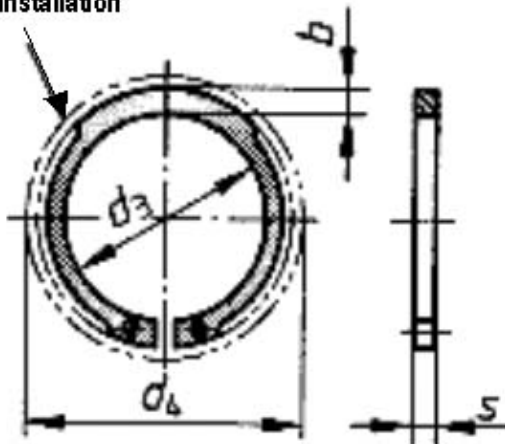

Groove

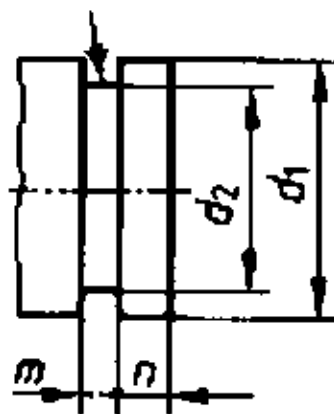

Space for Installation

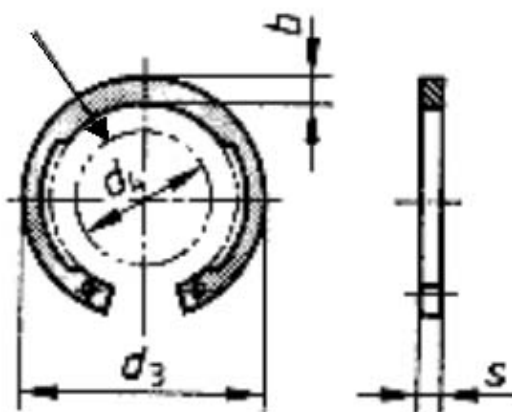

Groove

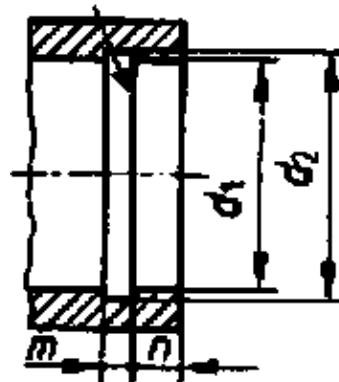

Example for Shaft:

Shaft 40 x 1.75 is a ring for a 40 mm shaft with a thickness of 1.75 mm.

2.4 Feather Keys

The feather key connection is transmitting torque by positive locking. Depending on the type of connection the fit between the feather key and the keyway needs a different layout. For example: For sliding gears there should be a loose clearance fit between the hub keyway and the feather key. Between the shaft keyway and the feather key there should be a transition fit.

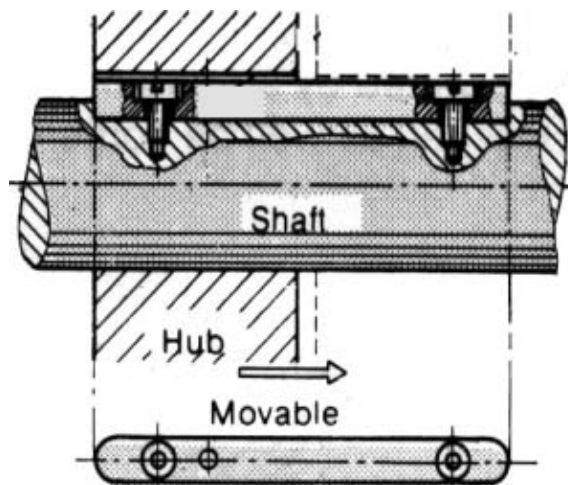
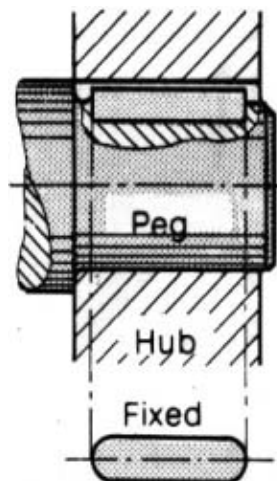
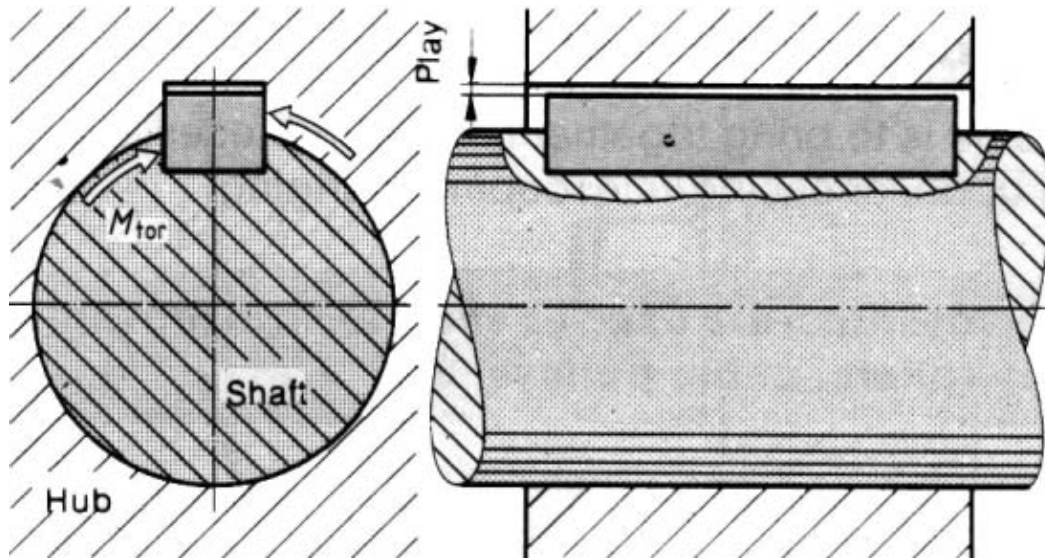

The size of feather key depends on the diameter of the shaft. The table below shows the standardized sizes according ISO.

Diameter									

	6 to 8 mm	8 to 10 mm	10 to 12 mm	12 to 17 mm	17 to 22 mm	22 to 30 mm	30 to 38 mm	38 to 44 mm	44 to 50 mm
Width	2 mm	3 mm	4 mm	5 mm	6 mm	8 mm	10 mm	12 mm	14 mm
Height	2 mm	3 mm	4 mm	5 mm	6 mm	7 mm	8 mm	8 mm	9 mm

3. Rolling Bearings

Bearings, especially large heavy-duty bearings are a major capital expense for many industries, with each one costing several hundred to thousands of dollars. Even more significant is the replacement cost for such bearings, since lost production and labor cost must be included in total cost involved when a bearing fails. Premature failure can happen through:

- Poor Fitting (fits to tight or to loose, wrong mounting tools) = 16 % of all bearings
- Poor Lubrication = 36 % of all bearings
- Contamination = 14 % of all bearings
- Fatigue (overloaded, or incorrectly serviced) = 34 % of all bearings

3.1 Introduction

All bearings that transfer loads via rolling elements are named rolling bearings. They use balls or other rolling elements, located between bearing rings, to minimize friction. The rolling elements are separated and held in position by "cages".

The fundamental purpose of a bearing is to transmit a load between a stationary part of a machine (**most likely a housing**) and a rotating part of a machine (**most likely a shaft**) with a minimum of resistance.

A rolling bearing has to transmit loads between the inner and outer rings of the bearing via the rolling elements. Depending on the type of rolling element that are used, the rolling bearing are classified into two groups:

- Ball Bearing – Load is carried over a very small surface – **Point Contact**
- Roller Bearing – Load is carried over a bigger surface – **Line Contact**

In general we can say, that ball bearings will generate under the same load more friction than roller bearings.

Bearings are further classified by the specific shape of their rolling elements:

- Ball, Cylindrical, Spherical, or Tapered.

Bearings are also classified by function depending on the direction of the applied load.

- Radial, Thrust or Combined

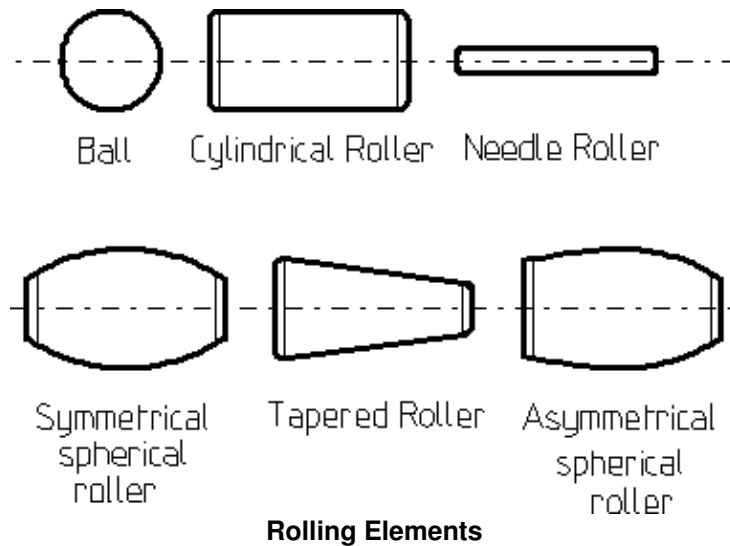

3.2 Components of Bearings

- Outer Ring** The outer ring is mounted in the housing of the machine and in most cases it does not rotate. The raceway against which the rolling elements run have different forms – sphered, cylindrical, tapered – depending on the type of rolling elements.

- Cage** The cage separates the rolling elements preventing contact between them during operation, which would cause poor lubrication conditions. With many bearings types the cage holds the bearing together during handling.

- Inner Ring** The inner ring is mounted on the shaft of the machine and is in most cases the rotating part. The bore can be cylindrical or tapered. The raceways against which the rolling elements run have different forms – sphered, cylindrical, tapered – depending on the type of rolling elements.

- Rolling Elements** The rolling elements can be balls, cylindrical rollers, spherical rollers, tapered rollers or needle rollers. They rotate against the inner and outer ring raceways and transmit the load acting on the bearing via small surface contacts separated by a thin lubrication film.

- Seal** Seals are essential for a long and reliable life of the bearing. They protect the bearing from contamination and bearings with integral seals are becoming increasingly popular.

- Guide Ring** Guide rings are used in spherical roller bearings. The function of the guide rings is to guide the rollers in the bearings so that they rotate parallel to the shaft and to distribute the load evenly. The quality demands for guide rings are extremely high and even the slightest ovality is totally unacceptable.

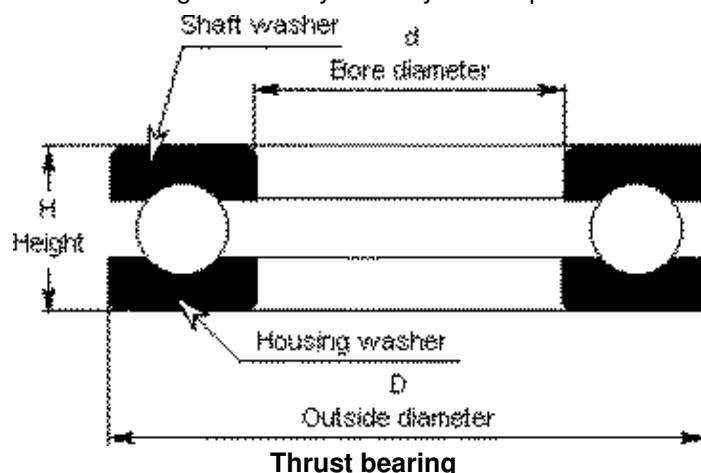

A bearing is defined as a thrust bearing when the contact angle is greater than 45°

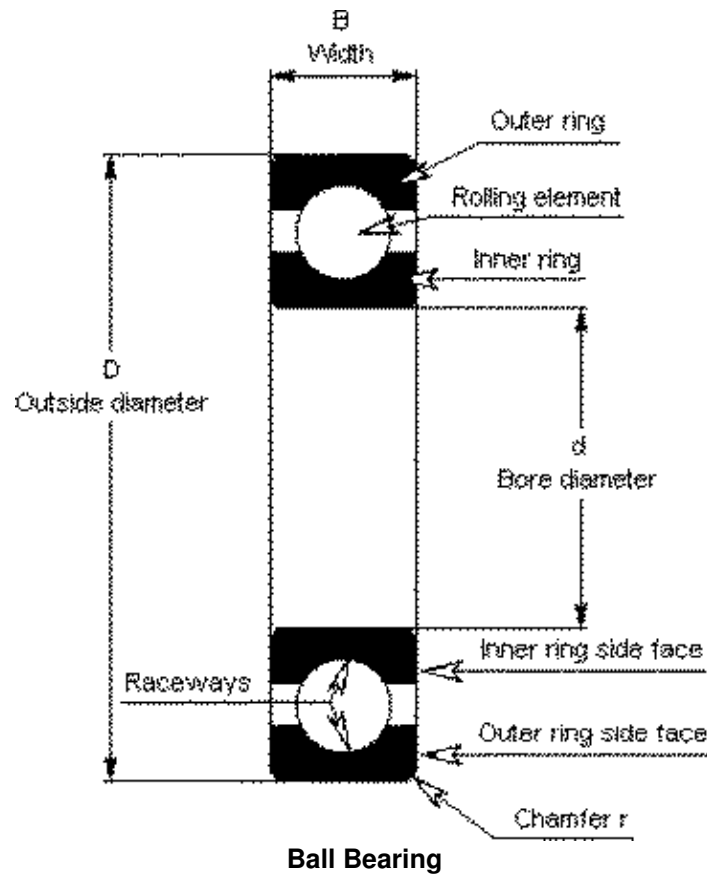

Ball Bearing

Materials used in bearings production:

- Through hardening steel, very clean for outer and inner ring
- Hardening steel, very clean for rolling elements
- Cages are made out of steel, brass or light alloy and plastic
- Side shields are made out of rubber, metal sheet or polyurethane or synthetic

3.3 Types of Bearing

There are more than 20,000 different bearings available on the market. The weight for example can be only a few grams up to more than 70 tons. Below you can find the most common types:

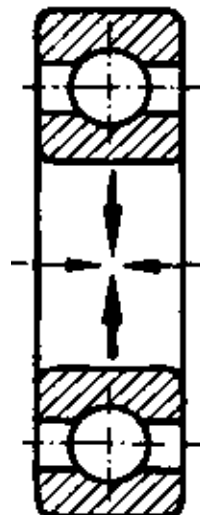

Deep Groove Ball Bearing

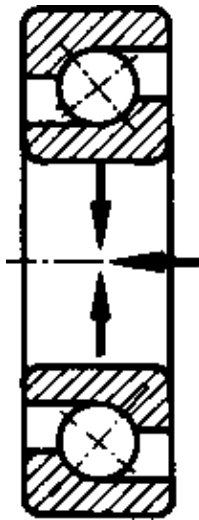

Angular Contact Ball Bearing

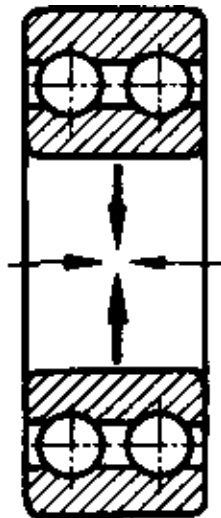

Double Row Deep Groove Ball Bearing

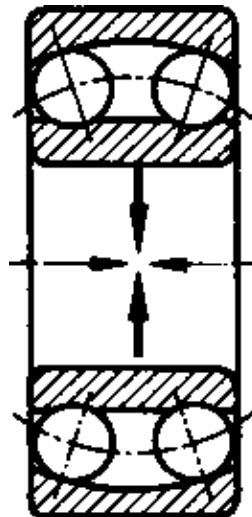

Self-Aligning Ball Bearing

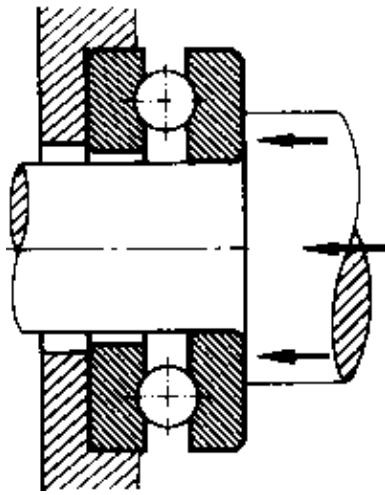

Thrust Ball Bearing

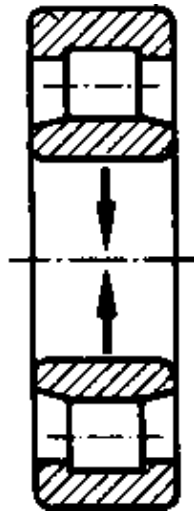

Cylindrical Roller Bearing

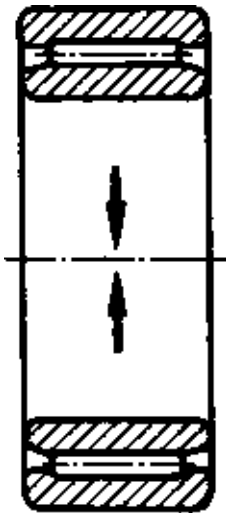

Needle Roller Bearing

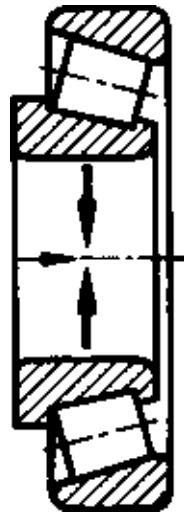

Taper Roller Bearing



Spherical Roller Bearing

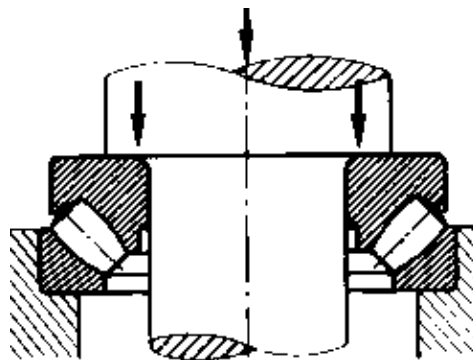

Spherical Roller Thrust Bearing

Note: The arrows show the possible load (radial, axial or combined)

3.4 Bearing Properties

Bearing Type	Loads	Comments
Deep Groove Ball Bearing	<ul style="list-style-type: none"> • High radial loads at very high speed • Combined loads 	Most popular and cheap bearing. Used in a wide variety of applications. Simple in design, non-separable. High to very high speeds. Low friction and quiet running. Double row available.
	<ul style="list-style-type: none"> • Combined loads 	

Angular Contact Ball Bearing		Raceways in the inner and outer ring. Used in general engineering. Double row available as well as four point contact ball bearings. Suitable for combined loads
Self Aligning Ball Bearing	• Combined loads	Two rows of balls with a common spherical raceway in the outer ring. Particular suitable to correct misalignment.
Thrust Ball & Cylindrical Thrust Bearing	• Purely axial loads only	Are composed of washer-like bearing rings with raceway grooves for the balls. The ring attached to the shaft is called the inner ring or tight washer and the ring attached to the housing is called the outer ring or loose washer. Suitable for axial loads in one direction. But there are also double direction bearings available.
Cylindrical Roller Bearing	• Purely radial loads at high speed if there are no flanges • Moderate combined loads if flanges	Rollers are guided between integral flanges on one of the bearing rings. Suitable for high speeds and high radial load. Double row available. Inner and outer ring separable. Available in N (separable outer), NU (separable inner), NJ (separable inner, one direction), and NUP (non-separable).
Needle Roller Bearing	• Purely radial load	Roller bearing with cylindrical rollers, which are thin and long to their diameter. Best suitable for high radial loads with limited radial space.
Taper Roller Bearing	• Combines loads	Taper roller bearings have tapered inner and outer ring and tapered rollers. Separable designed. Double row bearings available.
Spherical Roller Bearing	• Combines loads	Two rows of rollers. Common raceway in the outer ring. Particular suitable to correct misalignment. Bearings available with cylindrical bore and tapered bore.
Spherical Roller Thrust Bearing	• Combined loads	Have a spherical raceway in the outer ring with the rollers diagonally arranged in a single row. These bearings have a very high axial load capacity and are capable of taking moderate radial loads. Capable of handling misalignment and are suited for moderate speed operation.

When selecting a rolling bearing the following points should be always considered:

Property	Comments
Loads	What kinds of loads are to expect with this type of machine? Is this bearing suitable for this application?
Misalignment	It is always important to align auxiliary drives exactly. But if misalignment is a permanent problem, then self-aligning bearings should be chosen.
Temperature	Is the chosen bearing suitable for the temperature condition? Especially plastic cages and plastic bearing seals are sensitive against higher temperatures.
Speed	Deep groove bearings are most suitable for very high speeds. But more speed means also more friction this could generate a temperature problem. There are special high speed/high precision bearings available.
Mounting & Dismounting	Mounting & Dismounting is a cost factor. Consider this if you design or redesign a machine. Bearings with cylindrical bore and separable parts are most suitable if dismounting is often required.
Available space	If there is a space problem deep groove bearings are useful when shaft is small. Needle roller bearings for radial loads only should also be considered.
Quit running	Especially deep groove ball bearings are designed for quit running. If noise is a factor, than consider choosing a bearing type with special design for quit run.
Stiffness	Roller bearings have a higher stiffness than ball bearings.

Axial displacement	If axial displacement (shaft is moving) is a problem, then bearings with the ability to stand combined loads should be selected. Or cylindrical/needle bearings with one flange.
Precision	Some machines, especially with high rotation need high precision bearings.

3.5 Bearing Designation System

3.5.1 Basics

Rolling bearings can be applied universally as ready-to-mount machine elements. This is especially due to the fact that the main dimensions of the popular bearings are standardized according ISO (International Standardization Organization).

In this chapter we like to enable you to understand the bearing designation system. For further information study the manufacturer catalogue.

The basic designation system consists of three, four or five figures of a combination of letters and figures.

The first letter (not the Prefix) represents the bearing type

- 0 Angular contact ball bearings, double row
- 1 Self-aligning ball bearings
- 2 Spherical roller bearings and spherical roller thrust bearings
- 3 Taper roller bearings
- 4 Deep groove ball bearings, double row
- 5 Thrust ball bearings
- 6 Deep groove ball bearings, single row
- 7 Angular contact bearings, single row
- 8 Cylindrical roller thrust bearings
- N Cylindrical roller bearings (N = outer ring no groove; NU = inner ring no groove; NJ = only one shoulder on inner groove; NUP = only one shoulder on inner groove plus one loose inner flange)

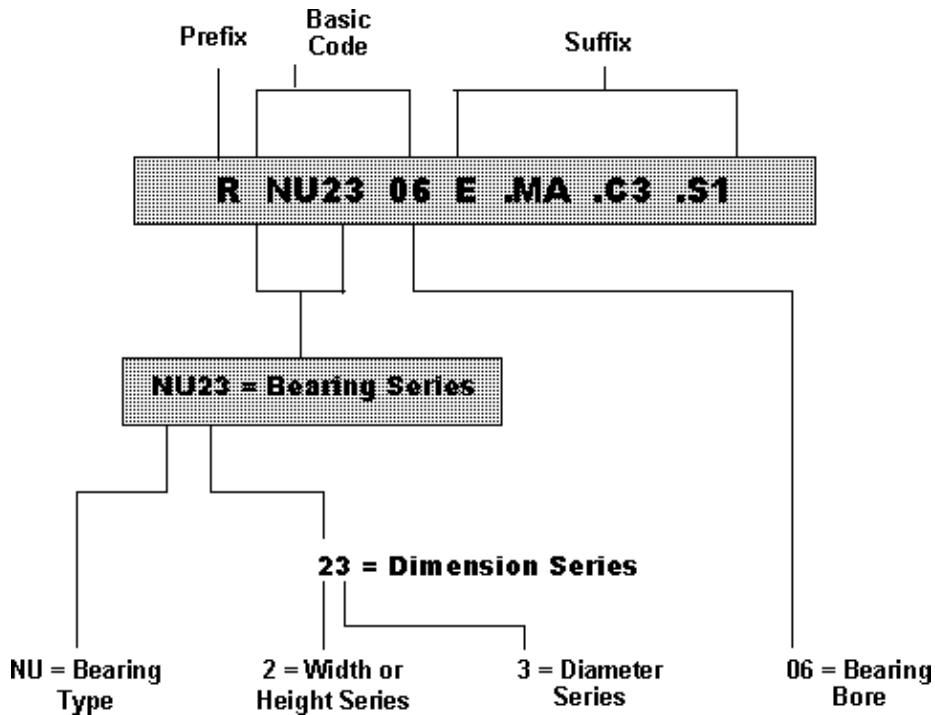

• The first figure of the two-digit number for the dimension series indicates the width series (the height series for thrust bearings) and the second figure the diameter series.

Popular diameter series are 8, 9, 0, 1, 2, 3, 4 (increasing outside diameters in this order). There are several width series in each diameter series e.g. 0, 1, 2, 3, 4 (the higher the figure the greater the width).

• The last (or the last two numbers) indicate the bore diameter. Just multiply the number by 5 and you will get the bore diameter in mm.

For bearings which have a bore diameter smaller than 10 mm and equal to or greater than 500 mm, the bore diameter is generally given in millimeters direct, the size identification being separated from the rest of the bearing designation by an oblique stroke, e.g. 618/8 (d = 8 mm) or 511/530 (d = 530 mm). This is also true of standard bearings to ISO 15, which have bore diameters of 22, 28 and 32 mm, e.g. 322/28 (d = 28 mm). Bearings with bore diameters of 10, 12, 15 and 17 mm have the following size identifications:

- 00 = 10 mm
- 01 = 12 mm
- 02 = 15 mm
- 03 = 17 mm

For some deep groove, self-aligning and angular contact ball bearings having a bore diameter smaller than 10 mm, the bore diameter is also given in millimeters (un-coded) but is not separated from the basic designation by an oblique stroke, e.g. 629 or 129 (d = 9 mm).

3.6.2 Additional Designation Codes

Code for Bearing Bore Normally: Number x 5 = bore & empty;	
Bore Reference number	Bore & empty;
3 to 9	3 to 9 mm
00	10
01	12
02	15
03	17

04	20
96	480
/500	500
/530	530

Codes for special design characteristic	
A	New modified model
B	Internal design
DA	Spli inner ring
E	Reinforced design
K	Tapered Bore 1:12
K30	Tapered Bore 1:30
N	Groove for snap ring –outer ring
RSR	With one seal
2RSR	With two seals
S	Lubrication groove and holes – outer ring
ZR	With one dust shield
2ZR	With two dust shield

Suffix for cage design The cage suffixes P, H, A, B are often added to the material code	
F	Machines steel cage
L	Machined light metal cage
M	Machined brass cage
T	Machined cage of laminated textile
TV	Cage of polyamide
J	Pressed steel cage
Y	Pressed brass cage
P	Window type cage
H	Snap type cage
A	Outer lip riding
B	Inner lip riding

Code for accuracy and bearing clearance Precision and Clearance are often combined e.g. P52 = Precision P5 & Clearance C2	
Without suffix	Normal tolerance PN (PO) Normal bearing clearance
P6	Tolerance < PN (PO)

P5	Tolerance < P6
P4	Tolerance < P5
P4S	Reduced P4 tolerance
P2	Special precision
SP	Ultra Precision
C1	Bearing clearance < C2
C2	Bearing clearance < CN (CO)
C3	Bearing clearance > CN (CO)
C4	Bearing clearance > C3
C5	Bearing clearance > C4

Special codes e.g. for heat treatment

S1 to S4	Special heat treatment, dimensionally stable above 150 degrees C.
----------	---

3.6.3 Examples to Bearing designation

1 st number	Deep groove ball bearing, single row
2 nd number	Width series – 2
3 rd number	Diameter series – 0
4 th number	Bore hole: 6 x 5 = 30 mm

6206

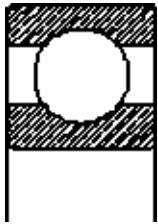

1 st number	Angular contact bearing, single row
2 nd number	Width series – 3
3 rd number	Diameter series – 0
4 th number	Bore hole: 5 x 5 = 25 mm

7305

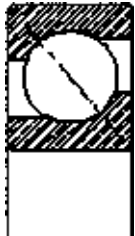

1 st number	Taper roller bearing
2 nd number	Width series – 0
3 rd number	Diameter series – 2
4 th number	

	Bore hole: $9 \times 5 = 45$ mm
--	---------------------------------

30209

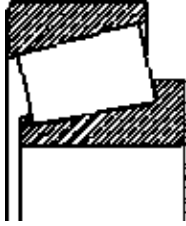

1 st number	Cylindrical roller bearing
2 nd number	/
3 rd number	/
4 th number	Bore hole: $17 \times 5 = 85$ mm
NU	No flange on inner ring. Flange on outer ring.

NU 417

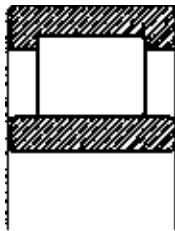

3.6 Internal Bearing Clearance

Bearings are designed with a specific internal clearance that measures the total clearance between the rings and the rolling elements. Internal clearance provides:

- Free rotation of rolling elements
- Compensation for thermal expansion
- Optimum load distribution

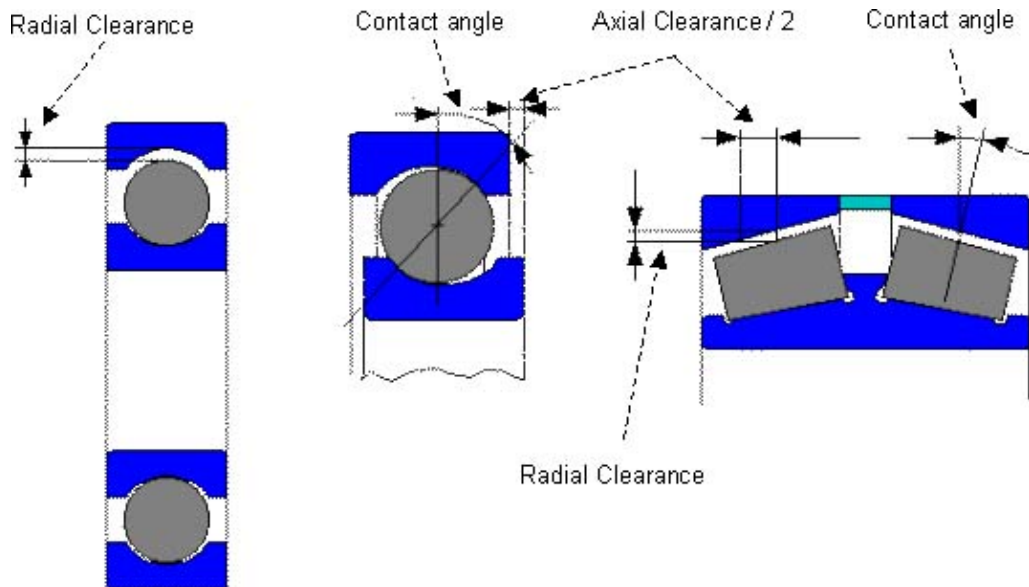

Choosing the correct internal clearance is important because bearings hold shafts, armatures, gears and other rotating devices in proper alignment. The amount of internal clearance influences noise, vibration, heat build-up and fatigue life. Impact loads, severe vibration, and ring fit also affect internal clearance. To obtain the optimal internal clearance for specific application, those parameters must be balanced.

Internal clearance can be separated into two categories: **radial and axial**. The total internal clearance is the amount that one ring can be displaced relative to the other ring, either radial or axial.

Radial clearance of Deep Groove Ball Bearing
Dimensions in mm

Nominal bore diameter	over	2.5	6	10	18	24	30	40	50
	to	6	10	18	24	30	40	50	65
Bearing clearance in microns (0.001 mm)									
Clearance group C2	min	0	0	0	0	1	1	1	1
	max	7	7	9	10	11	11	11	15
Clearance group CN (normal)	min	2	2	3	5	5	6	6	8
	max	13	13	18	20	20	20	23	28
Clearance group C3	min	8	8	11	13	13	15	18	23
	max	23	23	25	28	28	33	36	43
Clearance group C4	min		14	18	20	23	28	30	38
	max		29	33	36	41	46	51	61

3.7 Tolerance of Housing and Shaft

Even a properly selected bearing will fail prematurely if the shaft and housing fits are incorrect. Too much or too little interference between the mating parts can cause early failure. This becomes even more critical when bearings are replaced. A failed bearing can damage the shaft and housing, causing them to be out of tolerance.

A loose fit between the shaft and bearing inner ring (or the housing and the outer ring) can lead to relative movement, or "creep" between these parts. Creep wears out the mating surfaces, increasing the clearance between them. Eventually, the process can generate abnormal heat and vibration and possible contamination from wear particles.

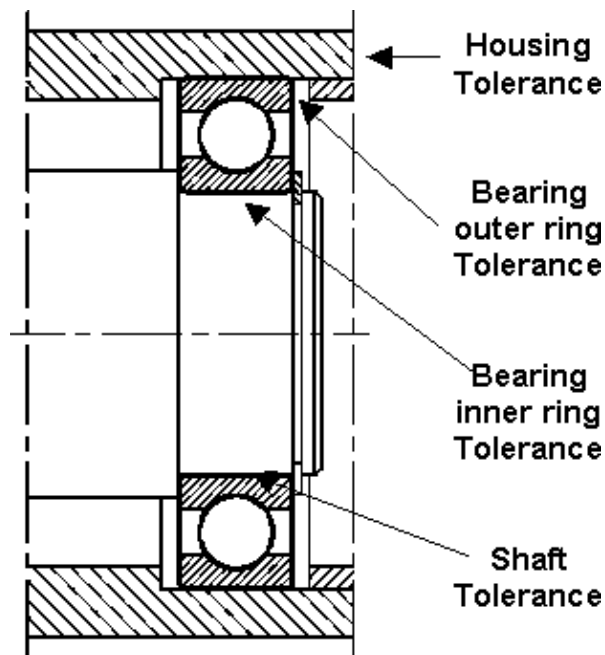

At the other end of the spectrum, excessive interference causes other problems that can decrease service life. Two key concerns are fracturing the inner ring and reducing the bearing's internal clearance. Too much interference builds high stress, which can sometimes fracture inner rings.

Also, an interference fit can decrease the internal clearance of a bearing due to growth of the inner ring or shrinkage in the outer ring. When the interference is too great, internal clearance becomes negative, resulting in excessive heat buildup and premature bearing failure.

Proper fit selection has a narrow margin for error. As a rule of thumb, the rotating part should have the interference fit. To specify the correct fit, the main factors that influence fit recommendations should be understood:

Which ring rotates, the inner or outer one? Is the load stationary? These factors determine which ring should have the interference fit. There are three possible combinations:

- Tight (or interference) fit on the inner ring – a common approach
- Tight fit on the outer ring – also common
- Tight fit on both rings – rarely seen

Normal fits for engineering are:

	Shaft	Housing
Ball bearings	j5...k5	H6...J7
Roller bearings	k5...m5	H7...M7

Examples to show how narrow the tolerances are:

Ball Bearing	Bearing Dimension	Shaft Tolerance j5	Housing Tolerance H6
61804	d = 20 mm	+ 0.005 mm	+ 0.016
	D = 32 mm	- 0.004 mm	- 0 mm
6320	d = 100 mm	+ 0.006 mm	+ 0.029
	D = 215 mm	- 0.009 mm	- 0 mm

3.8 Bearing Arrangement

Locating and Floating Arrangement

In order to guide and support a rotating shaft, at least two bearings are required, which are arranged at a certain distance from each other. A bearing arrangement with locating and floating bearings can be selected, depending on the case. The floating bearing has the function to compensate the moving of the shaft because of the thermal expansion during operation.

Cylindrical roller bearings of N and NU designs are ideal floating bearings. These bearings allow the roller and cage assembly to shift on the raceway of the lipless bearing ring.

All other bearing types, e.g. deep groove ball bearings and spherical roller bearings only function as floating bearings when one bearing ring is provided with a loose fit. The ring under point load is therefore given a loose fit; this is generally the outer ring.

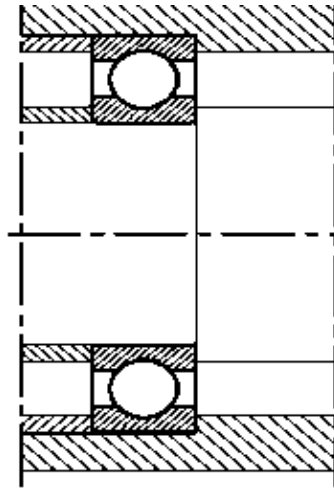

Locating Bearing Deep Groove Ball Bearing

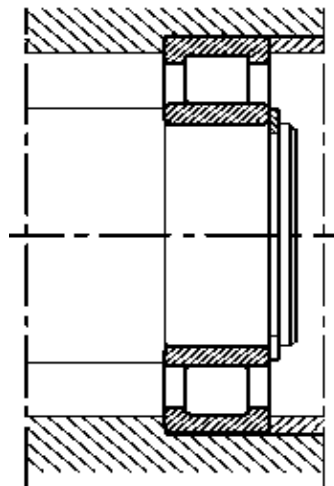

Floating Bearing Cylindrical Roller Bearing NU

Adjusting Bearing Arrangement

As a rule, an adjusted bearing arrangement consists of two symmetrically arranged angular contact ball bearings or tapered roller bearings. This arrangement is particularly suitable for those cases in which a close guidance is required.

Adjusted bearing arrangements are also possible by preloading with springs. This elastic type of adjustment compensates for heat expansion. They are also used when bearings are in danger of vibrations when stationary.

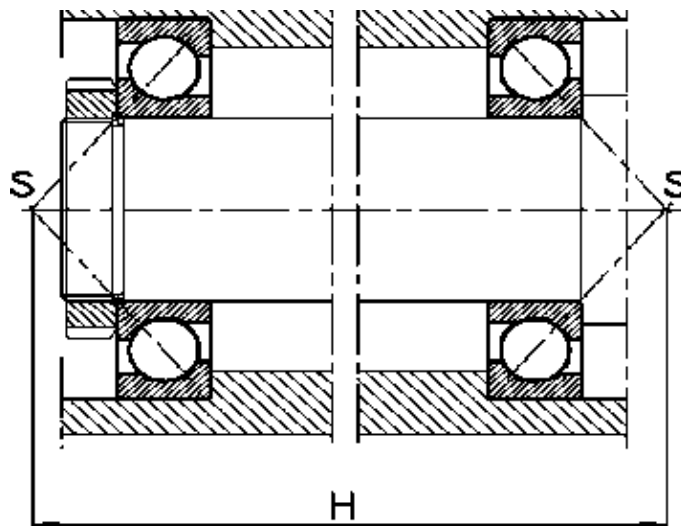

Adjusted Angular Ball Bearings in "O" Arrangement

Floating Bearing Arrangement

The floating bearing arrangement is an economical solution where a close axial guidance of the shaft is not required. Its design is similar to that of the adjusted bearing arrangement. In a floating bearing arrangement, the shaft, however, can shift by the axial clearances relative to the housing. Deep groove ball bearings, self-aligning ball bearings and spherical roller bearings, for example, are bearing types, which are suitable for the floating bearing arrangement. One ring of both bearings – generally the outer ring – is fitted to allow displacement.

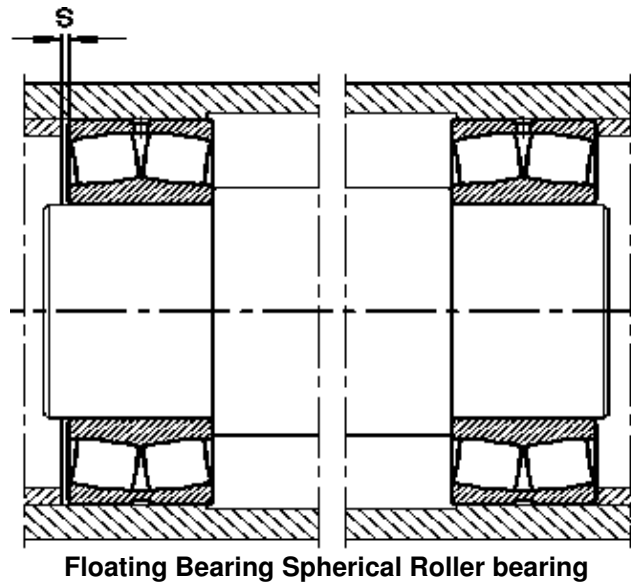

Arrangement of Angular Contact Bearings

Single row angular contact ball bearings of universal design are intended for mounting in pairs, either in X arrangement (face to face), O arrangement (back to back) or T arrangement (tandem) or for group mounting.

O–Arrangement: Two angular contact bearings are mounted with the pressure center of the left-hand bearing pointing to the left and the pressure center of the right-hand bearing pointing to the right. With the O–arrangement the bearing clearance is obtained by adjusting the inner ring.

X–Arrangement: Two angular contact bearings are mounted with the pressure center of the left-hand bearing pointing to the right and the pressure center of the right-hand bearing pointing to the left. With the X–arrangement the bearing clearance is obtained by adjusting the outer ring.

Tandem–Arrangement: Two angular contact bearings are mounted with the contact lines parallel. The thrust load is evenly distributed between the bearings.

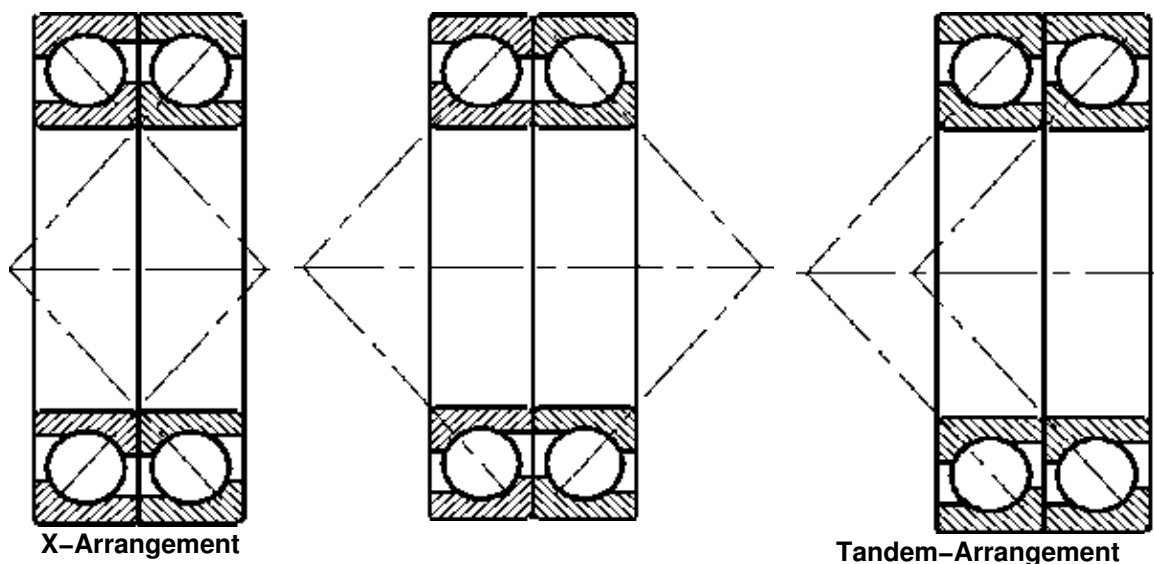

O-Arrangement

3.9 Axial Location of Bearings

Locating bearings and floating bearings

Locating bearings have to accommodate axial forces, which the holding element has to stand. Examples of holding elements are: shoulders on shafts and housings, snap rings, housing covers, shaft end caps, nuts, spacers, etc.

Floating bearings

They have to transmit only small axial forces resulting from thermal expansions so that the axial location has to prevent lateral displacement of the ring. A tight fit frequently does the job. With non-separable bearings, only one ring has to be firmly fitted; the other ring is held by the rolling elements.

Adjusted and floating bearing arrangements

Since adjusted and floating bearing arrangements transmit axial forces only in one direction, the bearing rings need to be supported only on one side. Another bearing, which is symmetrically arranged, accommodates the opposite force. Locknuts, ring nuts, covers or spacers are used as adjusting elements. In floating bearing arrangements, the movement of the rings to the side is restricted by shaft or housing shoulders, covers, snap rings etc.

3.9.1 Bearing with cylindrical bore

Axial adjustment:

- using a shoulder of a shaft: a, b, c, d, e, f
- using a shaft nut or an end plate or a thread ring: a, b, d, f,
- using a house end cover: c
- using spacer sleeves or collars: c, f
- using a snap ring: e, f

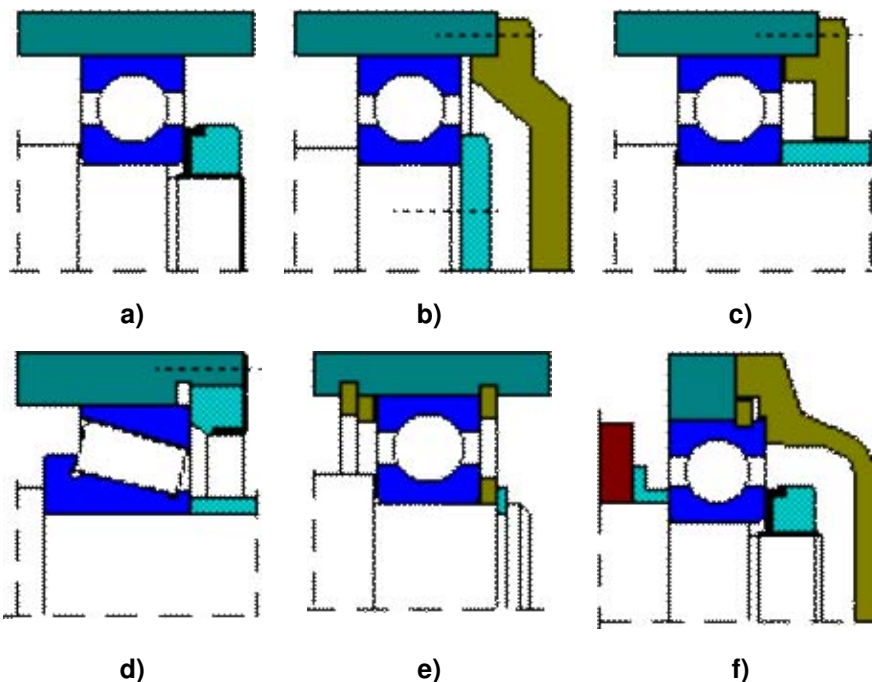

3.9.2 Bearing with tapered bore

Axial adjustment:

- using a shoulder of a shaft and a shaft nut: **a)**
- using a spacer ring and a mounting sleeve with shaft nut: **b)**
- using a mounting sleeve and a shaft nut: **c)**
- using an end plate and a withdrawal sleeve and a shaft nut: **d)**

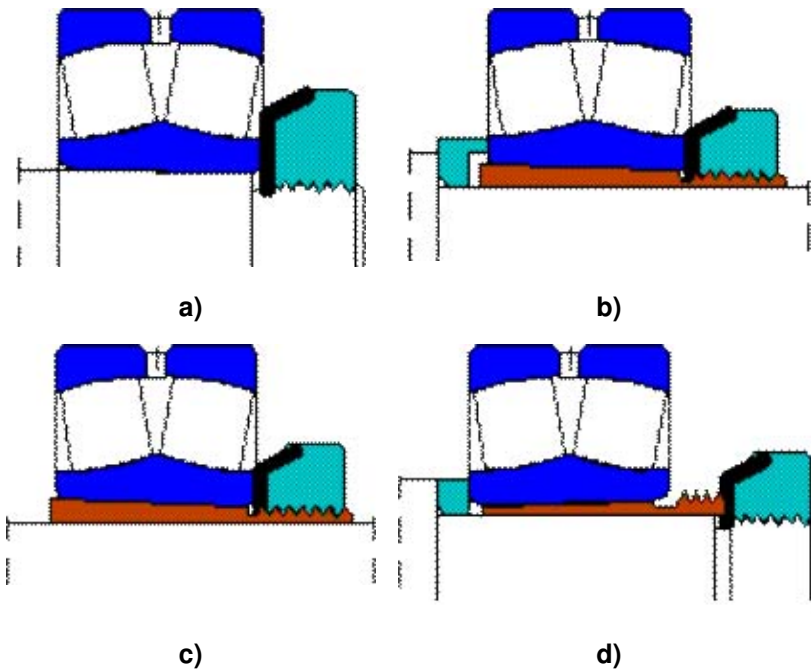

3.10 Mounting Rolling Bearings

Just to make you aware on how accurate bearings are manufactured and therefore to be treated with care, study the table below.

Tolerance of Bearing Fabrication – Example with Ball Bearing 6202 (d=15 mm, D=35 mm)

Tolerance Classes	Inner Ring	Outer Ring
PN	0 -0.008 mm	0 -0.011 mm
P6	0 -0.007 mm	0 -0.009 mm
P5	0 -0.005 mm	0 -0.007 mm
P4	0 -0.004 mm	0 -0.006 mm

3.10.1 Before Mounting

- All the necessary parts, tools and equipment should be at hand
- Drawings or instructions should be studied to determine the correct order in which to assemble the various components.
- Housings, shafts and other components of the bearing arrangement should be checked to see that they are clean, particularly any threaded holes, leads or grooves where chips of previous machining operations might have collected. Burrs should be removed.
- The dimensions of all components, which will be in contact with the bearing, should be checked. The diameter of cylindrical shaft and housing seats is usually checked using a micrometer gauge either outside or inside type. Tapered bearing seats are checked using ring gauges or special taper gauges, which, can be

supplied by the manufacturer.

- In many cases it is advisable to keep a record of the measurements. When measuring it is important that the components being measured and the measuring instruments have approximately the same temperature. This means that it is necessary to leave the components and measuring equipment together in the same place to reach the same temperature.
- The bearings should be left in their original packages until immediately before mounting so that they do not become dirty. Normally, the preservative with which new bearings are coated before leaving the factory need not be removed; it is only necessary to wipe it off the outside cylindrical surface and from the bore. If, however, the bearing is to be grease lubricated and used at very high or very low temperatures, or if the grease is not compatible with the preservative, it is necessary to wash and carefully dry the bearing.
- If there is a risk that the bearings have become contaminated because of improper handling (damaged packaging etc.), they should be washed before mounting. Any bearing which, when taken from its original packaging, is covered by a relatively thick, greasy layer of preservative (this may be the case for some large-size bearings with $D \geq 420$ mm) should also be washed and dried.
- Bearings, which are supplied ready greased and which have integral seals or shields at both sides should never be washed before mounting.

3.10.2 Mounting

Skill and cleanliness when mounting ball and roller bearings are necessary to ensure correct bearing performance and prevent premature failure.

- Anything that may come into contact with bearings should be kept clean, including workers' hands, benches, tools, solvents, and cloths. Perspiration, condensation – any type of moisture should also be kept away from bearings. Handle bearings with clean cloths.
- When bearings have to be mounted in unprotected places, which is often the case with large bearings, steps should be taken to protect the bearing and mounting position from contamination by dust, dirt and moisture until installation has been completed. This can be done by covering bearings, machine components etc. with waxed paper or foil.
- Avoid nicks – and damage from compressed air. Use extreme caution when using compressed air around bearings. Compressed air is a source of moisture, which can cause corrosion in bearings.
- Depending on bearing type and size, **mechanical, hydraulic or thermal methods** are used for mounting. Make every effort to avoid nicking bearings, which can be caused by striking them with hardened steel tools or sharp objects. Even though bearings are heat-treated, surfaces are brittle and fractures can easily occur. Nicks on the exposed surfaces can cause bearings to be improperly mounted, which will reduce bearing life.
- Never apply major loads through the ball complement when mounting bearings.
- Prevent loose particles from falling into bearings while being mounted. This danger might occur on a hydraulic press or while using the drift tube technique.
- In heating bearings for easier mounting heating temperatures should, in general, **not exceed 100 degrees Celsius**. There are several heaters available (e.g. Induction heaters, Heating oven or aluminum heating rings). Because of economical reasons, use the best fitting heating-device to heat the bearings.

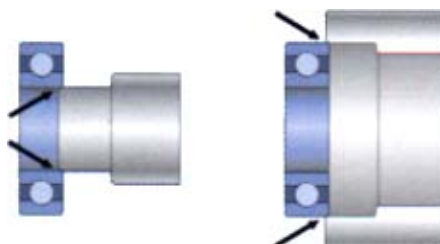

Figure Shaft and Housing Interference Fit

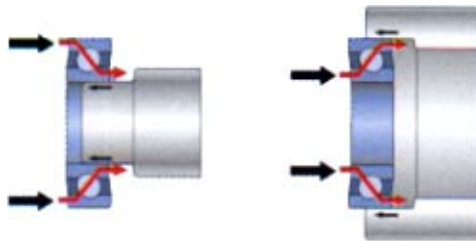

Figure **Wrong! Uneven distributing of forces can result in raceway damage**

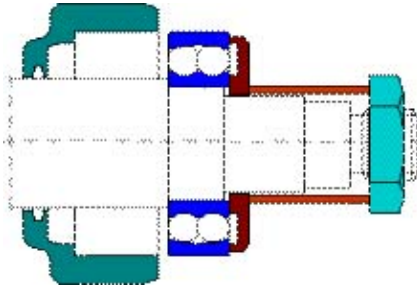

Figure **Screw down method**

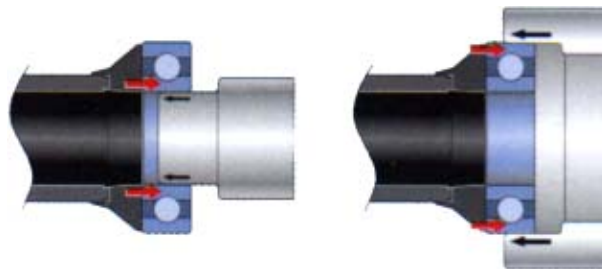
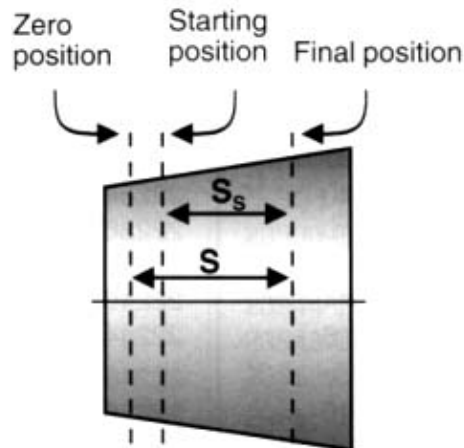
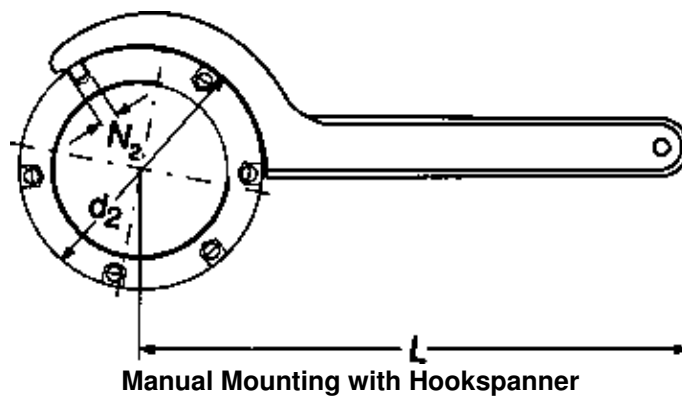

Figure **Use the correct tools to prevent raceway damage**

Mounting Tapered Bearings



The bearing or the sleeve has to move from the zero-position to the final position



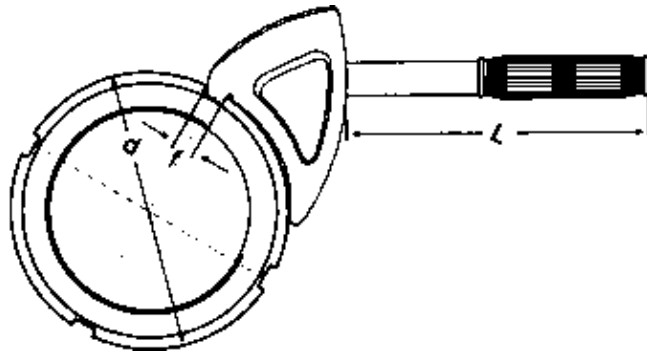

Manual Mounting with Impact spanner

Mounting with Hydraulic Equipment



a) Set up – ready to mount

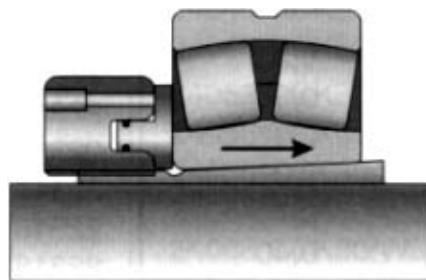

b) Mount on a sleeve

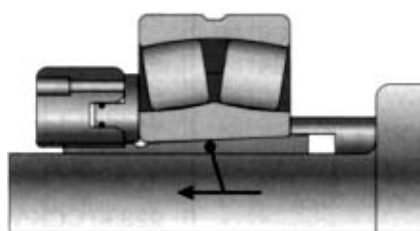

c) Two sliding surfaces

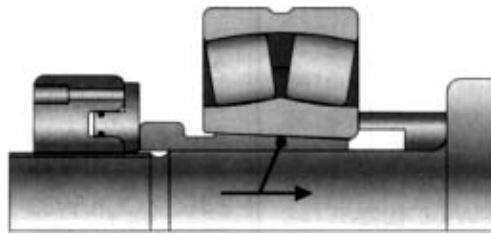

d) Two sliding surfaces

By driving up the inner ring on the shaft or sleeve, the tight fit required is obtained and is measured by checking the radial clearance reduction due to the expansion of the inner ring or by measuring the axial drive-up distance. Feeler gauges are suitable accessories for measuring the radial clearance.

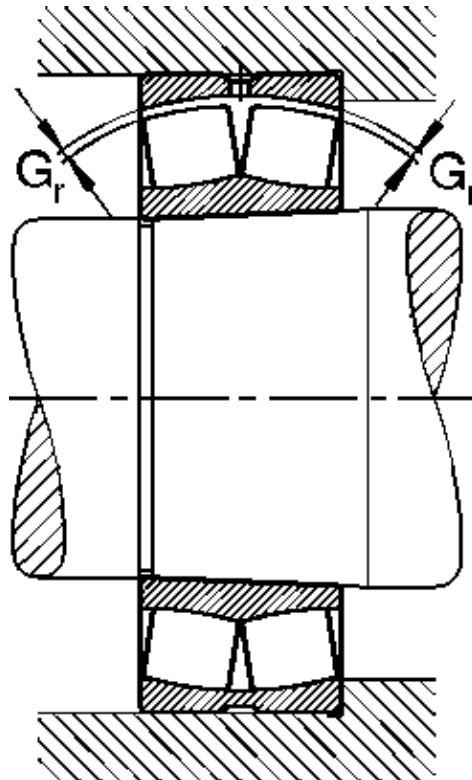

With spherical roller bearings the radial clearance must be measured across both roller rows

Radial clearance reduction in spherical roller taper 1:30

Nominal bearing bore		Reduction of the bearing clearance		Axial displacement on taper 1:30				Check values for the smallest radial clearance after mounting		
d				Shaft		Sleeve		CN	C3	C4
over mm	to	min mm	max	min mm	max	min	max	min mm	min	min
80	100	0.045	0.06	1.7	2.2	1.8	2.4	0.035	0.05	0.08
100	120	0.05	0.07	1.9	2.7	2	2.8	0.05	0.065	0.1
120	140	0.065	0.09	2.7	3.5	2.8	3.6	0.055	0.08	0.11
140	160	0.075	0.1	3	4	3.1	4.2	0.055	0.08	0.13
160	180	0.08	0.11	3.2	4.2	3.3	4.6	0.06	0.1	0.15
180	200	0.09	0.13	3.5	4.5	3.6	5	0.07	0.1	0.16
200	225	0.1	0.14	4	5.5	4.2	5.7	0.08	0.12	0.18

225	250	0.11	0.15	4.2	6	4.6	6.2	0.09	0.13	0.2
250	280	0.12	0.17	4.7	6.7	4.8	6.9	0.1	0.14	0.22
280	315	0.13	0.19	5	7.5	5.2	7.7	0.11	0.15	0.24
315	355	0.15	0.21	6	8.2	6.2	8.4	0.12	0.17	0.26
355	400	0.17	0.23	6.5	9	6.8	9.2	0.13	0.19	0.29
400	450	0.2	0.26	7.7	10	8	10.4	0.13	0.2	0.31
450	500	0.21	0.28	8.2	11	8.4	11.2	0.16	0.23	0.35
500	560	0.24	0.32	9.2	12.5	9.6	12.8	0.17	0.25	0.36
560	630	0.26	0.35	10	13.5	10.4	14	0.2	0.29	0.41
630	710	0.3	0.4	11.5	15.5	12	16	0.21	0.31	0.45
710	800	0.34	0.45	13.3	17.5	13.6	18	0.23	0.35	0.51
800	900	0.37	0.5	14.3	19.5	14.8	20	0.27	0.39	0.57
900	1000	0.41	0.55	15.8	21	16.4	22	0.3	0.43	0.64
1000	1120	0.45	0.6	17	23	18	24	0.32	0.48	0.7
1120	1250	0.49	0.65	18.5	25	19.6	26	0.34	0.54	0.77

Radial clearance reduction in spherical roller taper 1:12

Nominal tearing bore		Reduction of the tearing clearance		Axial displacement on taper 1:12				Check values for the smallest radial clearance after mounting		
d				Shaft		Sleeve		CN	C3	C4
over mm	to	min mm	max	min mm	max	min	max	min mm	min	min
30	40	0.02	0.025	0.35	0.4	0.35	0.45	0.015	0.025	0.04
40	60	0.025	0.03	0.4	0.45	0.45	0.5	0.02	0.03	0.05
50	65	0.03	0.04	0.45	0.6	0.5	0.7	0.025	0.035	0.055
65	80	0.04	0.05	0.6	0.75	0.7	0.85	0.025	0.04	0.07
80	100	0.045	0.06	0.7	0.9	0.75	1	0.035	0.05	0.08
100	120	0.05	0.07	0.7	1.1	0.8	1.2	0.05	0.065	0.1
120	140	0.065	0.09	1.1	1.4	1.2	1.5	0.055	0.08	0.11
140	160	0.075	0.1	1.2	1.6	1.3	1.7	0.055	0.09	0.13
160	180	0.03	0.11	1.3	1.7	1.4	1.9	0.06	0.1	0.15
180	200	0.09	0.13	1.4	2	1.5	2.2	0.07	0.1	0.16
200	226	0.1	0.14	1.6	2.2	1.7	2.4	0.08	0.12	0.18
225	250	0.11	0.15	1.7	2.4	1.8	2.6	0.03	0.13	0.2
250	280	0.12	0.17	1.9	2.6	2	2.9	0.1	0.14	0.22
280	315	0.13	0.19	2	3	2.2	3.2	0.11	0.15	0.24
315	356	0.15	0.21	2.4	3.4	2.6	3.6	0.12	0.17	0.26

355	400	0.17	0.23	2.6	3.6	2.9	3.9	0.13	0.19	0.29
400	450	0.2	0.26	3.1	4.1	3.4	4.4	0.13	0.2	0.31
450	500	0.21	0.28	3.3	4.4	3.6	4.8	0.16	0.23	0.35
600	560	0.24	0.32	3.7	5	4.1	5.4	0.17	0.25	0.36
660	630	0.26	0.35	4	5.4	4.4	5.9	0.2	0.29	0.41
630	710	0.3	0.4	4.6	6.2	5.1	6.8	0.21	0.31	0.45
710	800	0.34	0.45	5.3	7	5.8	7.6	0.23	0.35	0.51
800	900	0.37	0.5	5.7	7.8	6.3	8.5	0.27	0.39	0.57
900	1000	0.41	0.55	6.3	8.5	7	9.4	0.3	0.43	0.64
1000	1120	0.45	0.6	6.8	9	7.6	10.2	0.32	0.48	0.7
1120	1260	0.49	0.65	7.4	9.8	8.3	11	0.34	0.54	0.77

3.11 Dismounting

In general we can say, that if bearings are to be used again after removal, the force used to dismount them must on no account be applied through the rolling elements.

3.11.1 Dismount bearings with cylindrical bore

If the bearings are to be used again, the extraction tool should be applied to the tightly fitted bearing ring. With non-separable bearings, the following procedure is recommended:

- If the outer ring is tightly fitted, the bearing and the housing are removed from the shaft and then the bearing is extracted from the housing by pressing off the outer ring.
- If the inner ring is tightly fitted, the shaft with the bearing is removed from the housing and then the inner ring pressed off.

Common dismounting tools:

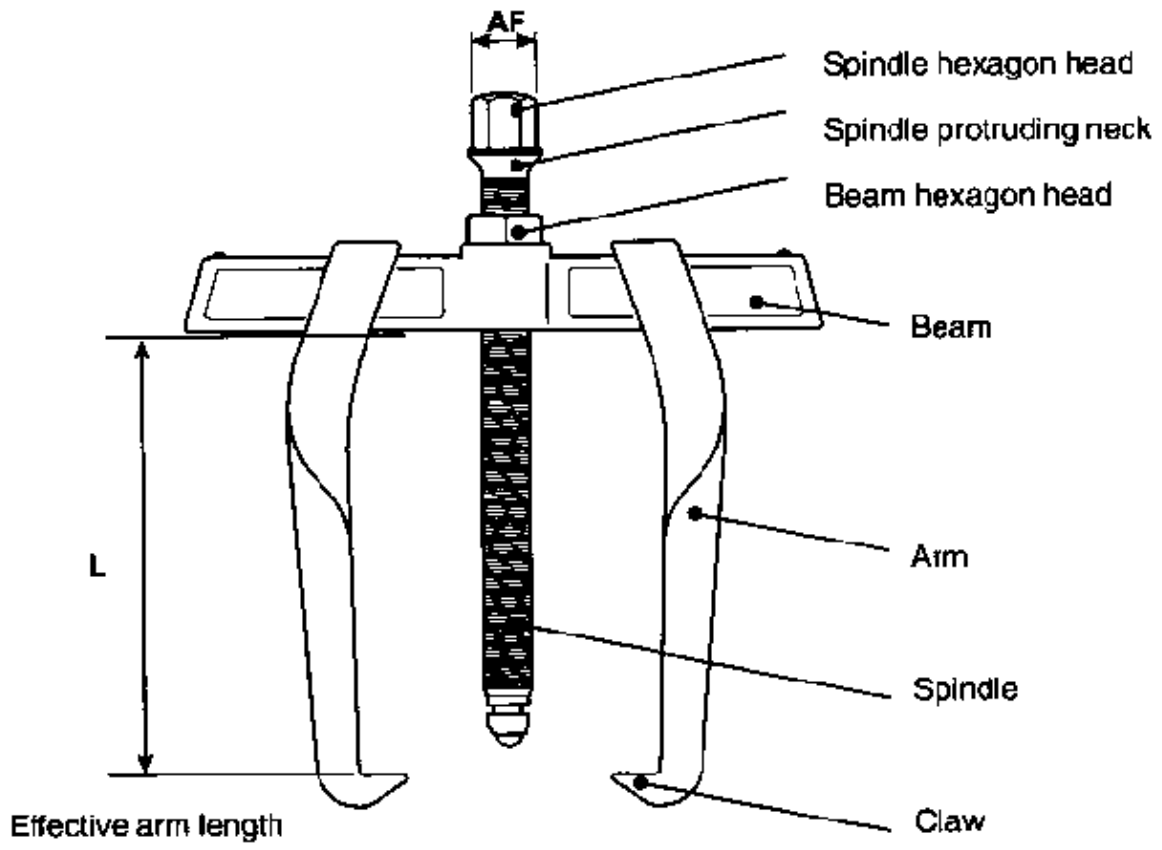

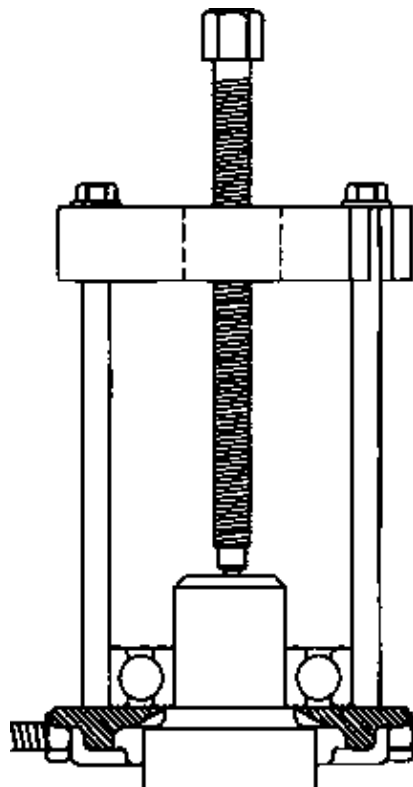
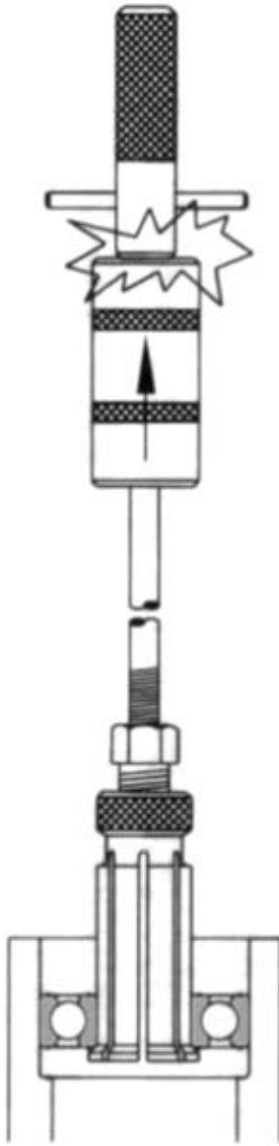

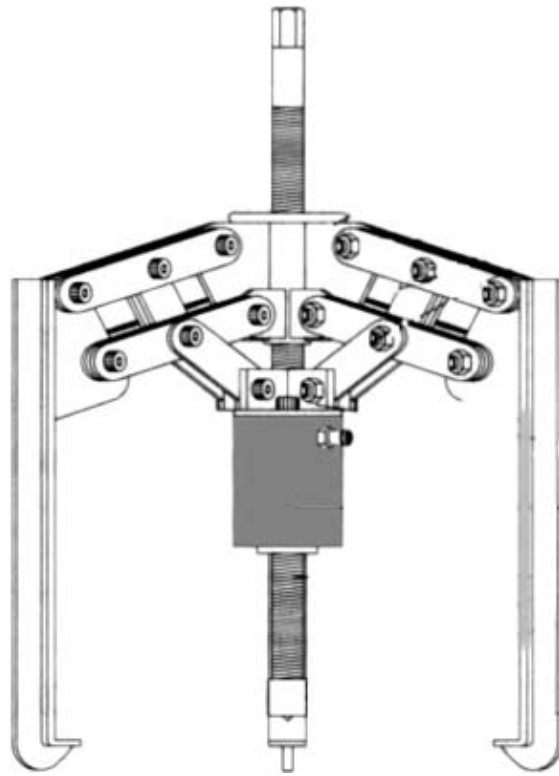

With separable bearings, the ring with the rolling element and cage assembly can be removed independently of the other ring. The inner ring can be removed using a "Heating Ring". If the method with the heating ring will not work, than it is possible to grind carefully the inner ring on the shaft. Through the tension, given from the interference fit, the inner ring will split. But take care of the shaft!

3.11.2 Dismounting Bearings with tapered adapter sleeves – 5 Methods

- a) The inner ring is driven off the sleeve using a metal drift or a piece of tubing.
- b) Dismounting a withdrawal sleeve with an extraction nut.
- c) Dismounting with nut and thrust bolts applied to the inner ring via a washer.
- d) Dismounting a withdrawal sleeve with a hydraulic nut.
- e) Dismounting a spherical roller bearing from the withdrawal sleeve with the hydraulic method. Oil is pressed between the surfaces of the bearing and sleeve. The withdrawal sleeve is released abruptly. (Not shown in the picture)

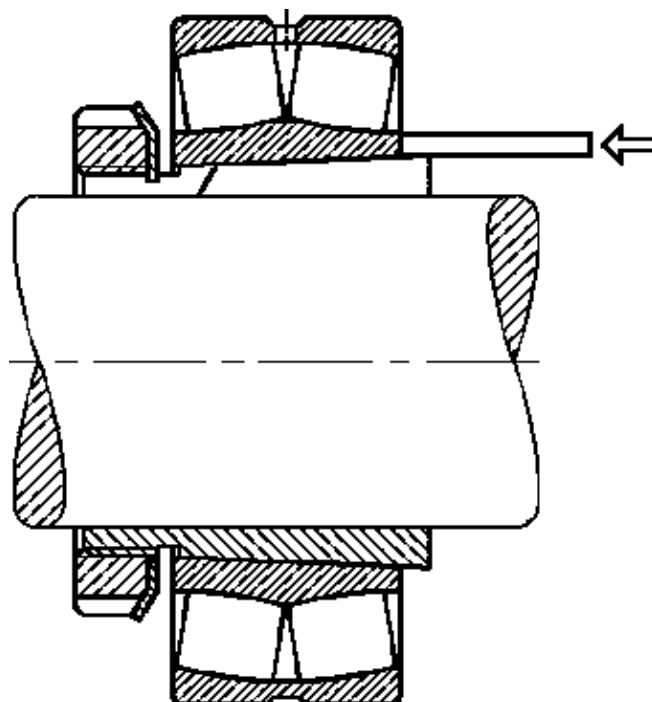

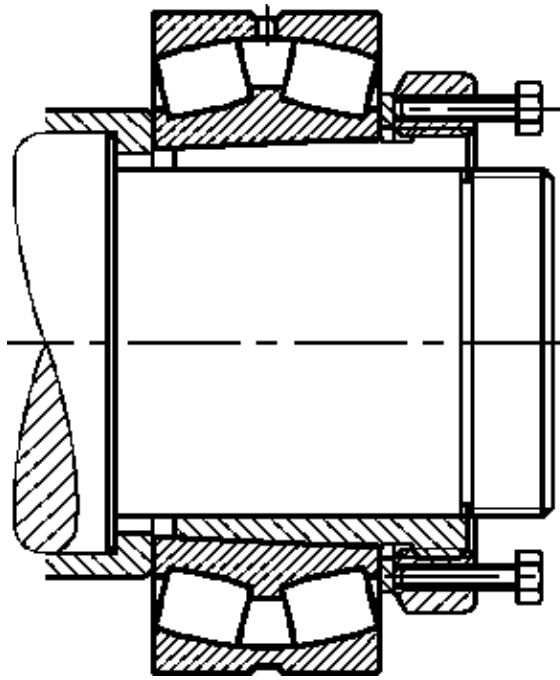
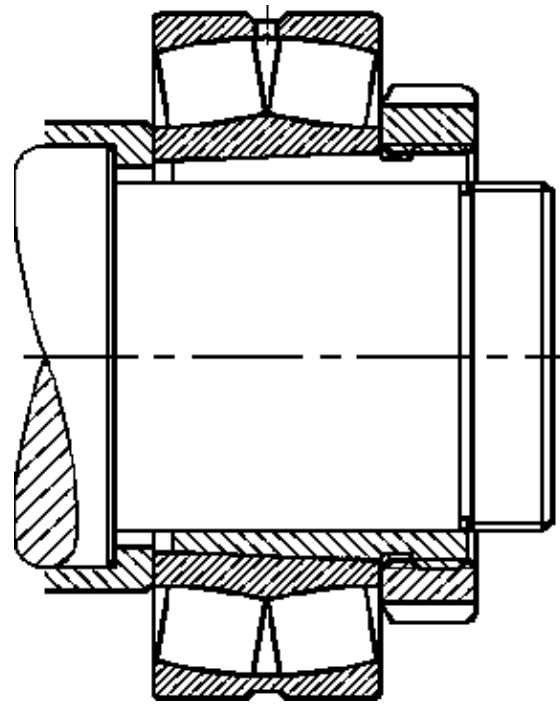

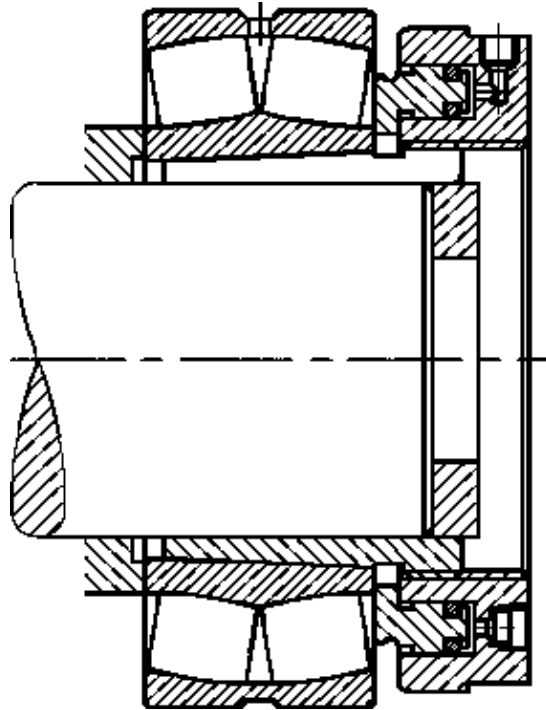

3.12 Storage

Before the manufacturer will pack the bearings, they are normally treated with a rust preventive compound. To preserve your bearing properly, do not unwrap it until you are ready to mount it. A tag on the outside of the packaging carries the exact part number and normally a serial number as well. Record this information when you receive the bearing, along with its arrival date. In this way they can be stored in a cool and dry place for several years. But there are some critical points to consider:

- The humidity should not exceed 60 %. Moisture can cause problems.
- The storage rack should be free of permanent vibration. Otherwise the balls or rollers will rock against the outer ring with each vibration. This can lead to so called "flat spots" and damage the bearing.
- Bearings with side shields and lifetime lubrication are also problematic to store for a long time. The grease properties can change during the years.

Bearings, which are not stored in their original packages, should be well protected against corrosion and contamination. Large rolling bearings should only be stored lying down, and preferably with support for the whole extent of the side faces of the rings. If kept in a standing position, the weight of the rings and rolling elements can give rise to permanent deformation because the rings are relatively thin-walled.

4. Seals

The purposes of seals are:

- To prevent dirt, dust and moisture from penetrating inside the protected housing.
- To ensure that gases, liquids and other materials capable of flow cannot escape.
- To keep different materials stored in different sections of the housing separated (for example water and oil in water pumps)

Classification of Seals:

Classification	Sub-Group	Type of Seal
Static Seals		<ul style="list-style-type: none"> • Face seals (Gasket, Sealing Compound) • O-Ring
Dynamic Seals	Non Rubbing Seals	<ul style="list-style-type: none"> • Gap type seals • Labyrinth seals • Baffle plates • Lamellar rings • Bearing with shields ZR • Gaiters
	Rubbing Seals	<ul style="list-style-type: none"> • Mechanical seals • Felt rings or felt strips • Radial shaft seals • V-rings • Spring seals • Bearing with seals RS • Packings

Seals are used in billions of machines, appliances and vehicles. They get in contact with thousands of different products and fluids. The environmental factors are as well to consider when choosing a material of a seal. The following questions should be frequently asked before choosing seals material. Remember, choosing all the times the "best" material will raise your maintenance cost.

Duty:

- Medium?
- Concentration of medium?
- Max. Pressure?
- Min. Pressure (Vacuum)?
- Max. Temperature?
- Min. Temperature?
- Liquid or Gas?
- Vibration?
- Abrasion?

4.1 Static Seals

Face seals (Gaskets)

They are able to compensate slight surface irregularities and able of making a tight seal if the surface is slightly distorted. In some cases they are required to transmit and uniformly distribute pressing forces produced by the clamping devices (for example screws).

Where loads are light the seals can be a **gasket** made of paper, oiled paper or pressed board. Gasket compounds can mostly replace paper seals. On surfaces containing severe machining grooves or score-marks, the paper gasket makes a better seal if it is coated with a suitable **sealing compound** as well. Permanently elastic sealing compounds and those, which harden after application are available.

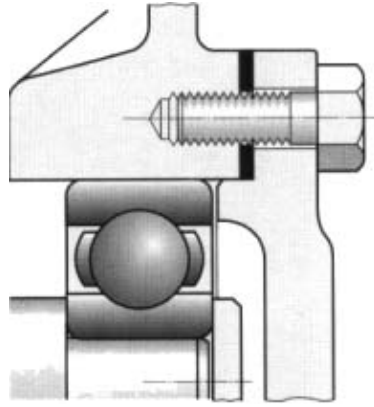

Asbestos–metal woven fabric is suitable as a sealing material for high temperatures and pressures. The surface can be covered additionally with metal foil, for example copper as used on cylinder head gaskets. Cork–chloroprene rubber (Neoprene") and cork–silicone rubber seals remain highly flexible under heavy pressure loads, and are resilient when the load is removed. The rubber encloses the individual cells of the cork completely, and forms a bond between them. These materials are used as seals for hydraulic equipment and transmissions

O–Ring

Round–section seals (O–rings) are ring–shaped seals of circular cross–section. They are manufactured from soft, permanently elastic plastics, for example nitrile butadiene rubber, and used for sealing both stationary and moving parts. They should be treated with care and not be accidentally twisted on assembly. The sealing action is produced by deformation of the round sealing ring.

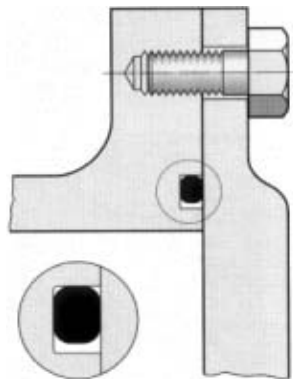

4.2 Dynamic Seals

4.2.1 Non–Rubbing Seals:

The only friction arising with non–rubbing seals is the lubricant friction in the lubricating gap. The seals do not show any wear and can function for a long time. Since non–rubbing seals do not generate any heat, they are suitable for very high speeds.

Labyrinth Ring

Labyrinths (b), whose gaps are filled with grease, have a far greater sealing effect. If the environment is dirty, grease is pressed from the inside into the sealing gaps in short time intervals.

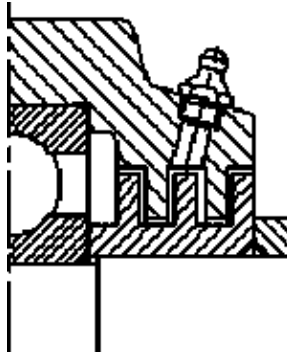
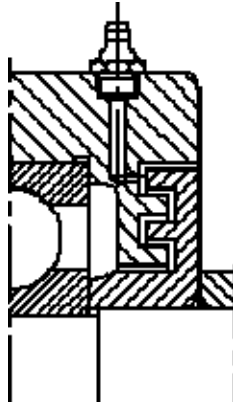

Lamellar Rings

Lamellar rings of steel (f) with spring disks to the outside or to the inside need a small mounting space. They seal against grease loss and dust penetration and are also used as a seal against splashing water.

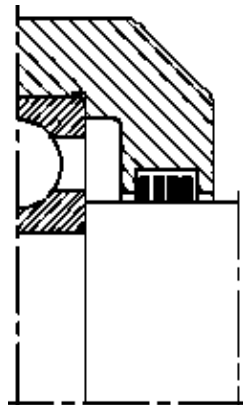
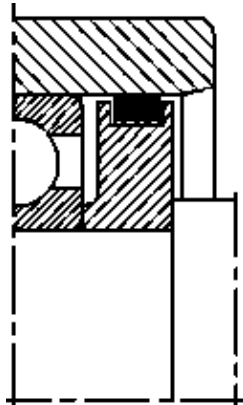

Flexible Gaiters

Flexible gaiters or bellows of synthetic material protect bearing points against penetration by dust and dirt. They often contain the grease for lubrication of a pivot. They are used at the steered wheels of vehicles and

on rear axle shafts (Figure

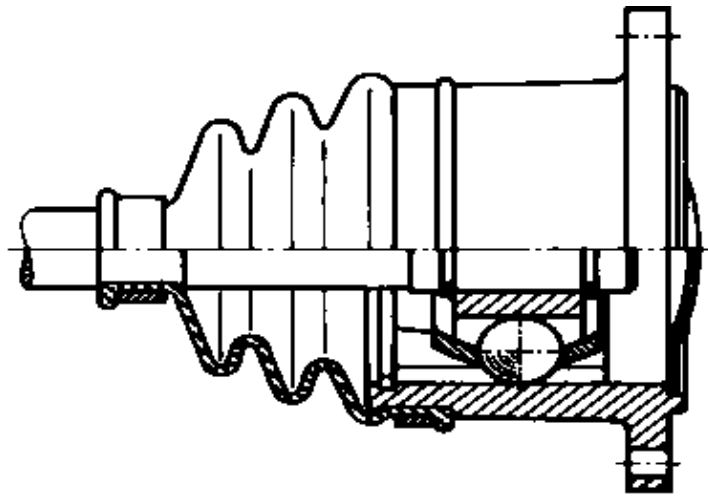

Sealing Gap

A simple method of protection which is frequently adequate, is a narrow sealing gap between shaft and housing

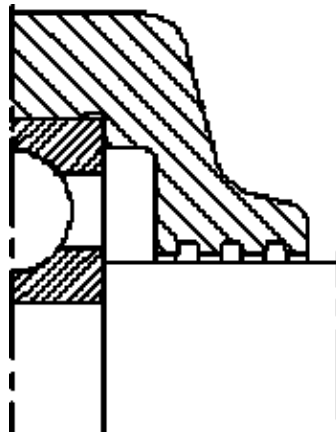
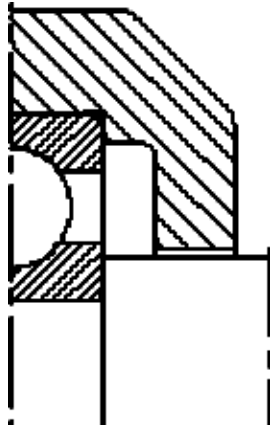

Baffle Plates

Prevent grease from escaping from the bearing. The grease collar, which forms at the sealing gap, protects the bearing from contaminants.

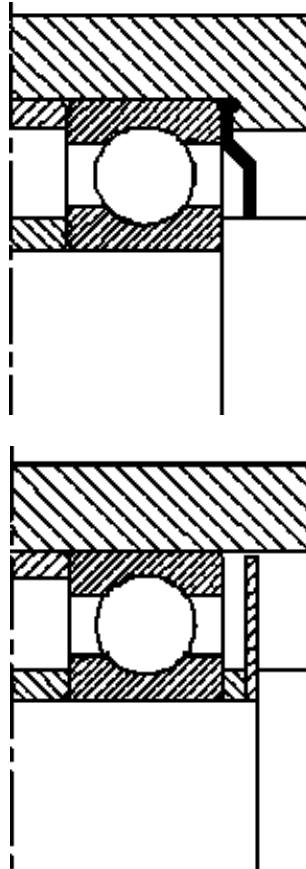

4.2.2 Rubbing Seals:

Rubbing seals contact their metallic running surfaces under a certain force (usually radial). This force should be kept to a minimum to prevent excessive increases in the frictional moment and the temperature. The lubrication condition at the contact surface, the roughness of the contact surface, and the sliding velocity also influence the frictional moment and the temperature as well as the seal wear.

Mechanical Seals

A mechanical seal is a containment device. It prevents leakage. It keeps contents from leaking out and contaminants from leaking in. It operates under dynamic, not static conditions. Instead of directly sealing the rotating shaft as packing does, a mechanical seal's sealing surfaces are between a pair of faces, one rotating, the other stationary. The mechanical seal remains the most cost effective method for sealing a rotating shaft. They can be found on equipment with rotating shafts, such as pumps, agitators, mixers, automotive engines, and compressors. Common examples of where mechanical seals are used include:

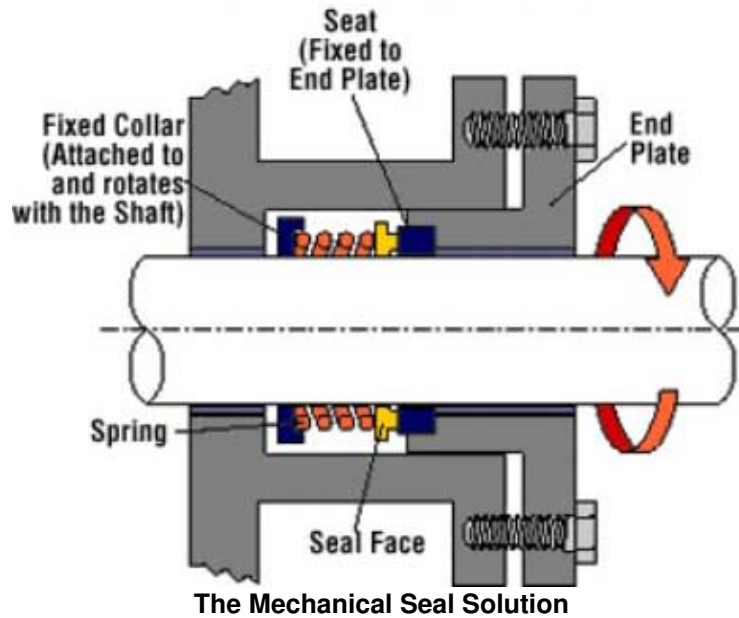

Water pump in appliances or automobiles; Air conditioning compressors; Oil pipeline pumps; Pharmaceutical mixers; Wastewater treatment pumping stations

Packings

Packings (gland or stuffing–box seals) are used on shafts and spindles to keep chambers or cylinders at different pressures or containing different materials separate from one another. Packings can be made from fibrous materials, metal fibers, soft metals or elastic sealants. The original solution for sealing a rotating shaft was to use packing. This was the standard method of sealing pumps before the 1950's. As operating conditions became more demanding and pumps were used on a greater variety of fluids, mechanical seals were designed to handle these conditions.

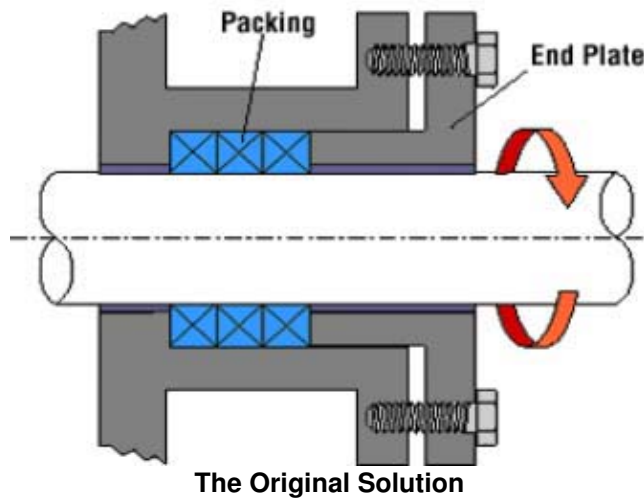

Felt Rings

Felt rings (a) are simple sealing elements which prove particularly successful with grease lubrication. They are soaked in oil before mounting, and are an especially good means of sealing against dust. If environmental conditions are adverse, two felt rings can be arranged side by side.

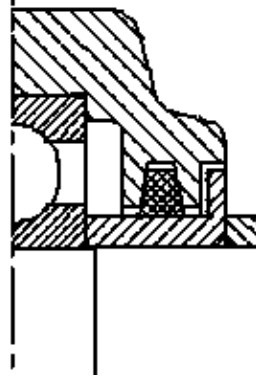

Spring Seals

Spring seals are highly efficient for grease lubrication. They consist of thin sheet metal and are clamped to the face of the inner or the outer ring while the sealing edge contacts the other ring under slight tension.

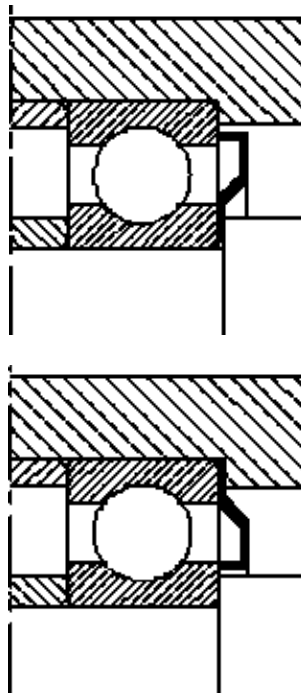

Sealing Washer

Simple designs are possible with bearings with one or two sealing washers. The washers are suitable to seal against dust, dirt, a moist atmosphere, and slight pressure differences. They are maintenance-free bearings with two sealing washers and a grease filling. The most commonly used sealing washer design is 2RSR made of acrylo-nitrile-butadiene rubber (NBR) for deep groove ball bearings is lightly pressed on the ground inner ring. Design 2RS for very small deep groove ball bearings contacts a chamfer at the inner ring faces.

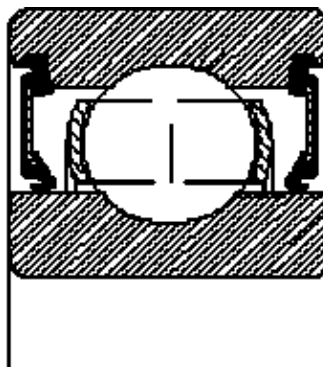

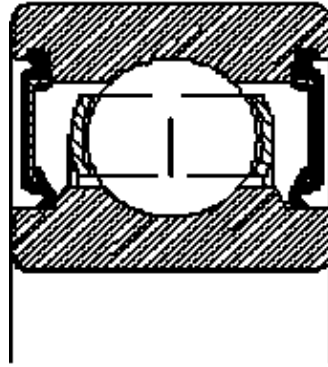

V-Ring

The V-ring is a lip seal with axial effect. During mounting, this one-piece rubber ring is pushed onto the shaft under tension until its lip contacts the housing wall. Axial lip seals are insensitive to radial misalignment and slight shaft inclinations. With grease lubrication, rotating V-rings are suitable for circumferential velocities of up to 12 m/s, stationary ones up to 20 m/s. V-rings are frequently used as preseals in order to keep dirt away from a radial shaft seal.

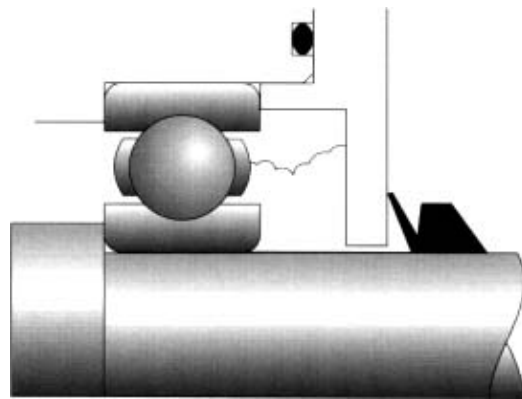

Radial Shaft Seal

Other names are "radial lip shaft seal" or "lip ring" or "oil seal". Radial shaft seals are, above all, used at oil lubrication. The sealing ring, equipped with a lip, is forced against the sliding surface of the shaft by a spring. If the chief aim is to prevent the escape of lubricant, the lip is on the inside. A sealing ring with an additional protection lip also prevents the dirt penetration. They are designed to withstand high sliding-contact speeds and in special cases high oil pressures as well. They have a powerful sealing action and a long operating life. In addition, they are standardized, cheap and easy to assemble. The cup section is made from a resilient plastic which is resistant to oil and ageing, for example "Perbunan" or silicone rubber. The sealing lips of the cup section are pressed lightly and uniformly against the shaft by a tubular spring. Dustproof seals have a dust lip in addition to the sealing lip.

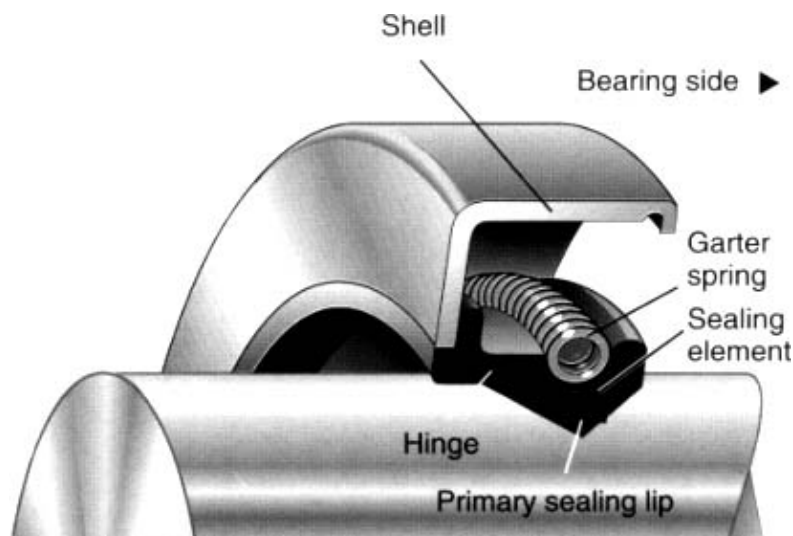

Because of the importance of radial shaft seals for the efficient sealing of bearing arrangements, we will focus in this handout more on radial shaft seals and their application as well as on their designs and executions.

4.3 Radial Shaft Seal ("radial lip shaft seal", "lip ring", "oil seal")

4.3.1 Types of Radial Shaft Seal

All-rubber shaft seal

- a) with open Spring groove
- b) with Spring-Lock
- c) with Spring Kover



a b c

Radial shaft seals to ISO 6194

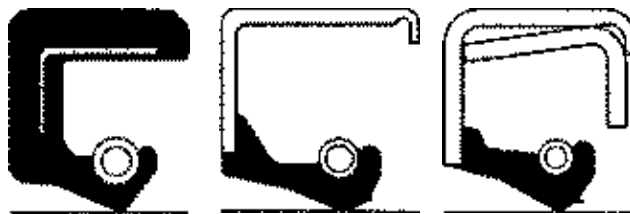

Type 1 Type 2 Type 3

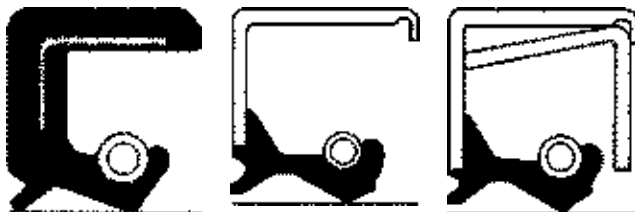

Type 4 Type 5 Type 6

4.3.2 Materials of Radial Shaft Seal

The performance and reliability of a radial shaft seal are largely dependent on the material from which the seating lip is made. If seals fail regularly after a short period of operation, it may be advisable to replace them with seals of another material, e.g. one which is more wear-resistant or medium resistant. But consider that for example using all the time the "best" ring available will raise also your maintenance cost. For example the "best" radial shaft seal on the market has a temperature range from -75 degree Celsius up to 260 degree Celsius and is very resistant against abrasion.

The following questions should be considered:

Is the Radial Shaft Seal resistant against?

- The mediums they are contacted with? (Water, oil, grease, salts, alcohols, acids, alkalis, fuels etc.)

- The operating temperature they are contacted with? (Some can stand temperature from –70 to 260 degree C)
- The wear they are affected with? (Abrasive material such as sand, grit etc.)
- The pressure they are affected with?
- The speed they are affected with?
- The eccentricity they are affected with?

For normal applications with contact with mineral oils and greases a **Nitrile** seal will do a good job. The recommended continuous operation temperature is from –54 to 107 degree C.

Polyacrylate elastomer seals are recommended continuous operation temperature is from –40 to 150 degree Celsius. They are well suited for extreme pressure lubricants. They should not be used together with water.

Fluorelastomer seals operate over the widest range of temperature and chemicals. They handle temperatures from –40 to 204 degree Celsius. They resist most of the lubricants, which will destroy nitrile, polyacrylates or silicones.

PTFE are suitable for high temperatures from –73 to 340 degree C.

4.3.3 Shaft and Housing Tolerances

Shaft Tolerances:

Shaft ∅ in mm	Max ∅ in mm	Min ∅ in mm	Shaft ∅ in mm	Max ∅ in mm	Min ∅ in mm
over 6 to 10	+0.000	–0.090	over 120 to 180	+0.000	–0.250
over 10 to 18	+0.000	–0.110	over 180 to 250	+0.000	–0.290
over 18 to 30	+0.000	–0.130	over 250 to 315	+0.000	–0.320
over 30 to 50	+0.000	–0.160	over 315 to 400	+0.000	–0.360
over 50 to 80	+0.000	–0.190	over 400 to 500	+0.000	–0.400
over 80 to 120	+0.000	–0.220			

The surface finish should be smooth enough to maintain contact with the seal lip, and yet rough enough to have lubricant –holding pockets. The surface should have no machine lead.

House Tolerances:

The seal is usually press–fitted into the bore. Therefore the outside diameter must be larger than the bore diameter. It is normally machined with **ISO H8 Tolerance**.

House ∅ in mm	Max ∅ in mm	Min ∅ in mm	House ∅ in mm	Max ∅ in mm	Min ∅ in mm
over 6 to 10	+0.022	–0.000	over 120 to 180	+0.063	–0.000
over 10 to 18	+0.027	–0.000	over 180 to 250	+0.072	–0.000
over 18 to 30	+0.033	–0.000	over 250 to 315	+0.081	–0.000
over 30 to 50	+0.039	–0.000	over 315 to 400	+0.089	–0.000
over 50 to 80	+0.046	–0.000	over 400 to 500	+0.097	–0.000

over 80 to 120	+0.054	-0.000			
----------------	--------	--------	--	--	--

4.3.4 Installation of Radial Shaft Seal

Guidelines for proper installation:

- Check the dimensions of the selected seal. They should match those of shaft and bore.
- Check the new seal for any damage (dents, scores or cuts). **Never** use damaged seals. Carefully clean the seal if it has become dirty.
- Chamfer the housing bore corner to prevent damage to the outside surface of the seal.
- Check to see that the counterface on the shaft is undamaged (no bruises, scratches, cracks, rust or raised areas).
- All shaft edges over which the seal has to be passed must be chamfered or rounded.
- Lightly grease or oil the seal before installation.
- After installation, check to see that other machine components or shaft shoulders do not rub against the seal.
- Use proper mounting tools. If no suitable tools are available, a wooden block and hammer can be used. To avoid shearing of the seal, the blows should be applied centrally.

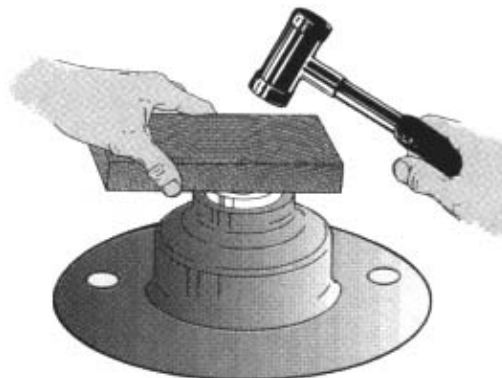
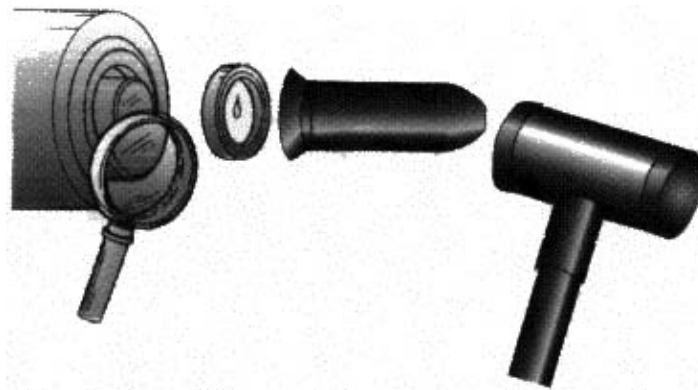

Repair of worn out seat of radial shaft seal using an adapter sleeve. For further information ask your supervisor or the bearing distributor. (Speedy-Sleeve)

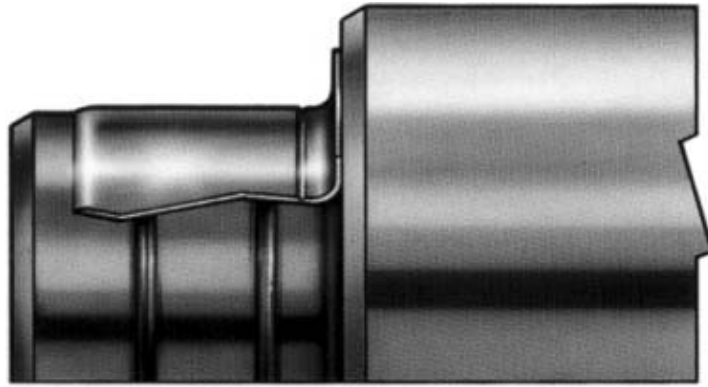

5. Repair Job

5.1 Exercises in Technical Drawing Interpreting

- Interpreting technical drawings
- Determining different rolling bearings
- Locating sealings
- Analysing the positioning of rolling bearings (floating, locating and adjusted arrangements)
- Determining the type of lubrication of assembly
- Describing the sequence of assembling

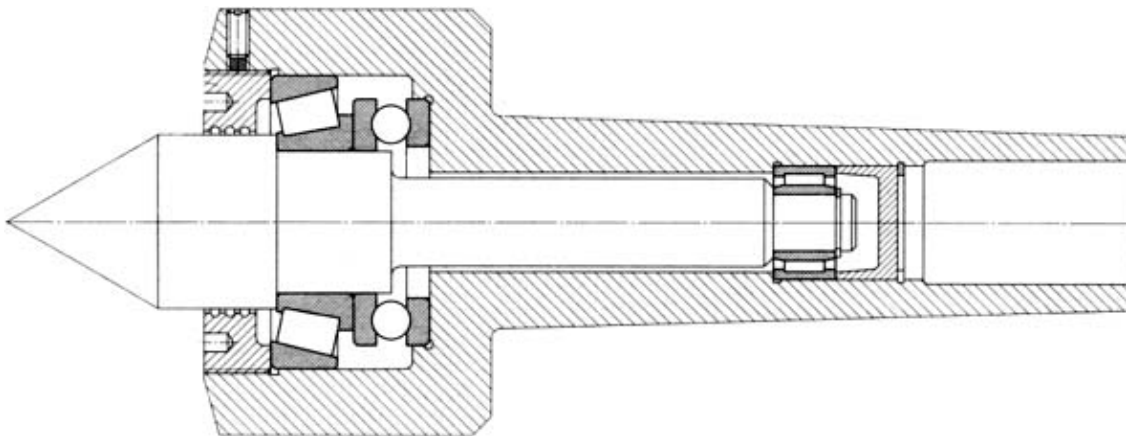

Working Sheet No. 1 – Live Center

1. Write down the different types of bearings.	
2. What seals are used to keep the dirt out of the bearing housing?	
3. Which is the floating side and which is the adjusted side?	
4. Discuss with the other trainees how the bearings are fixed.	Left side: Right side:

5. Discuss with the other trainees how to assemble the live center.

Exercise No. 2 – Water Pump

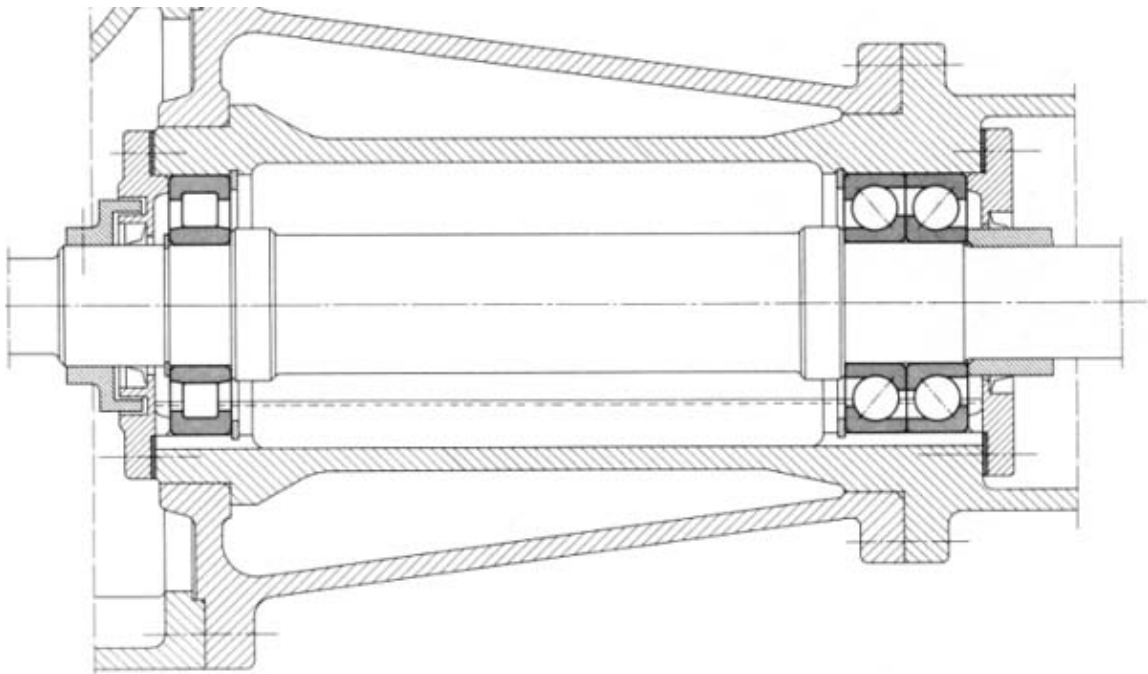

Working Sheet No. 2 – Water Pump

1. Write down the different types of bearings and the type of arrangement of the left side assembly.	
2. What seals are used to keep the dirt out of the bearing housing?	
3. How are the bearings lubricated?	
4. Which is the floating side and which is the adjusted side?	
5. Discuss with the other trainees how the bearings are fixed.	Left side: Right side:

6. Discuss with the other trainees how to assemble the water pump.

--

Exercise No. 3 – Converter

1. Write down the different types of bearings and the type of arrangement of the lower side assembly.	
2. What seals are used to keep the dirt out of the bearing housing?	
3. How are the bearings lubricated?	
4. Which is the floating side and which is the adjusted side?	
5. Discuss with the other trainees how the bearings are fixed.	

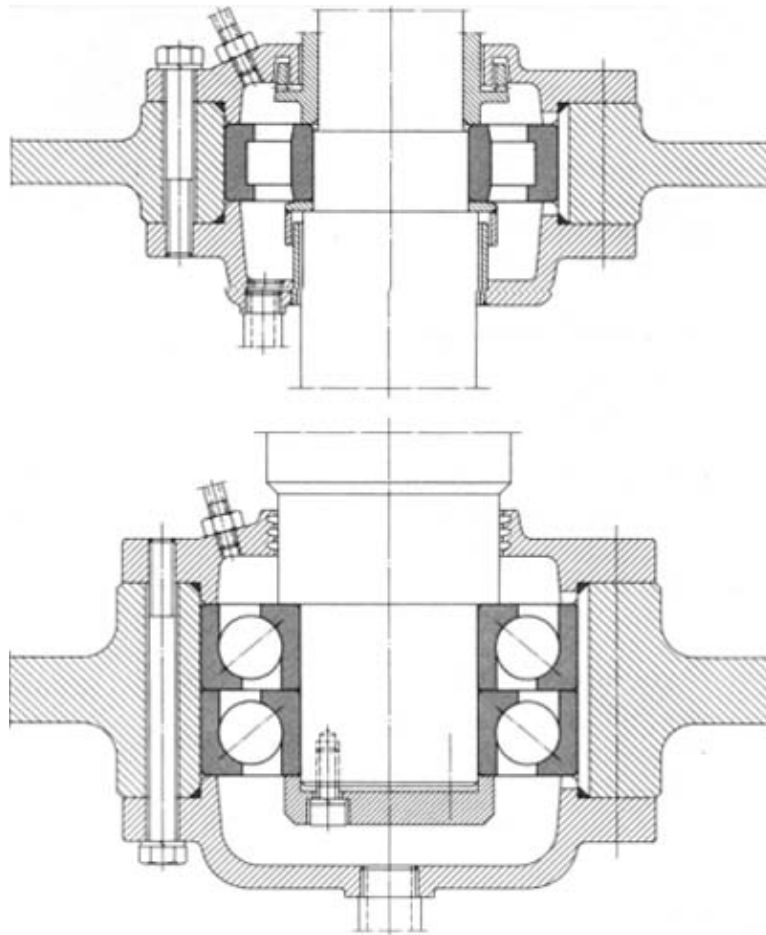

Interpreting Technical Drawing – Self Study

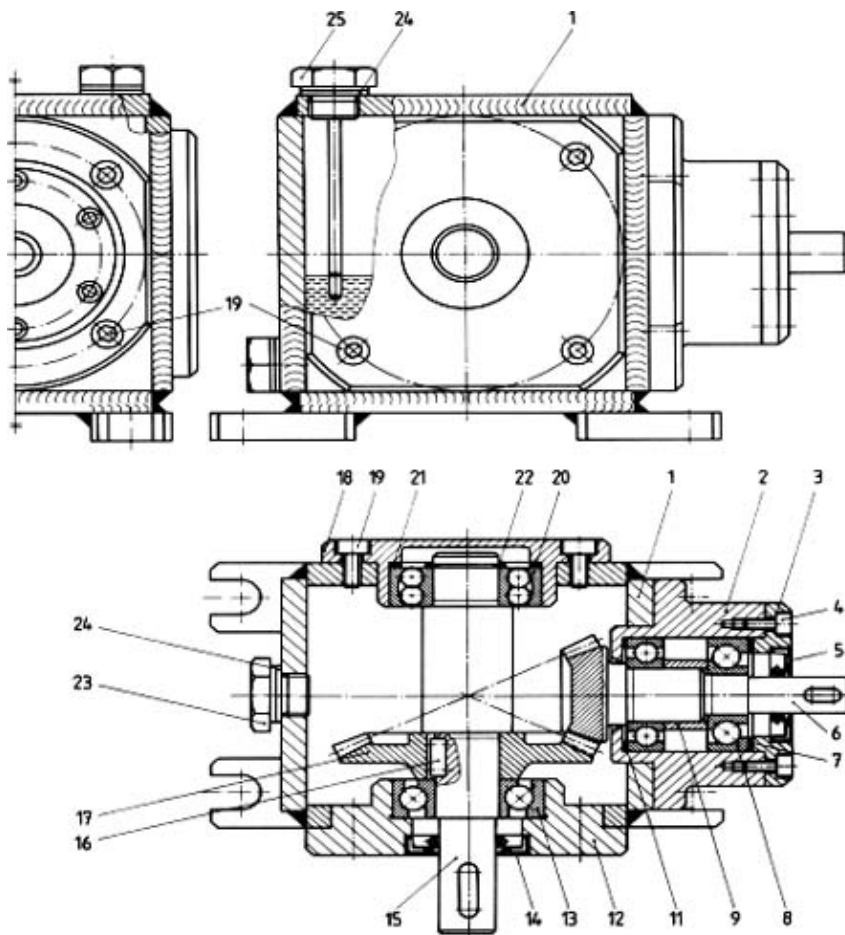





List of parts: Bevel Gear Drive								
Pos	Pcs	Designation	Pos	Pcs	Designation	Pcs	Pce	Designation
1	1	Gearbox case	10	1	Deep groove ball bearing	19	12	Socket head screw
2	1	Bearing housing	11	1	Shim ring	20	1	Self-aligning ball bearing
3	1	Bearing crown	12	1	Bearing housing	21	1	Elastic distance ring
4	6	Socket head screw	13	1	Contact ball bearing	22	1	Snap ring
5	1	Lip seal	14	1	Lip seal	23	1	Closing cap
6	1	Mitre pinion wheel	15	1	Gear shaft	24	2	Copper ring
7	1	Shim ring	16	1	Feather key	25	1	Screw plug with oil dip stick
8	1	Angular ball bearing	17	1	Mitre wheel			
9	1	Spacer ring	18	1	Bearing housing			





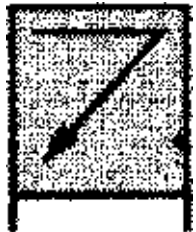

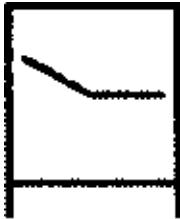

5.2 General Instructions for a Repair Job within the Workshop

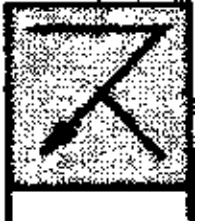
Working Steps	Comments
1. Prepare Workplace for disassembling	<ul style="list-style-type: none"> Remove parts, tools and jigs from previous jobs from the working area Clean up the working area Provide container for used oil Provide new cleaning rags to clean up spilled oil and grease
2. Safety Check	<p>Ask yourself the following questions:</p> <ul style="list-style-type: none"> Do I have the permission to do the job? Am I skilled/trained to do the job? Are there any hazards for me, for my colleagues or for the environment? E.g. Machine under pressure, machine under vacuum, machine filled with a hazardous medium, hazard because of electric shock
3. Sketch the outside Machine Contours	<ul style="list-style-type: none"> To make sure that the machine can be re-assembled properly even after a longer period (e.g. Break because of lack of spare parts) Consider that a colleague of you might re-assemble the machine. Store the draft together with the machine parts
4. Remove Oil	<ul style="list-style-type: none"> Before opening any part of the machine, remove oil Catch the oil in an adequate container and store it for disposal Do not spill oil
5. Mark all Parts before starting to disassemble	<ul style="list-style-type: none"> To make sure that the machine can be re-assembled properly even after a longer period (e.g. Break because of lack of spare parts). Consider that a colleague of you might re-assemble the machine. Use letter or number punch to mark parts It is also possible to mark parts using a center punch, a small chisel or water and kerosene resistant paint
6. Draft a plan in your mind on how to disassemble the machine	<ul style="list-style-type: none"> Use all available resources like manuals, drawings Think first before starting to screw!
7. Disassemble the Machine	<ul style="list-style-type: none"> Use the proper tools Don't use any force and take care not to damage any part

	<ul style="list-style-type: none"> • Remove first couplings, pulleys, sprockets from the shafts • Open the housing • Remove shafts, bearings, sealing • Store all parts properly in a box with a soft surface. For sensitive parts put some cleaning rag around
8. Sketch the inner Assembly	<ul style="list-style-type: none"> • If necessary sketch the inner assembly. Consider that a colleague of you might re-assemble the machine. • Especially take note of spacer rings. Sketch the position of them.
9. Clean all Parts	<ul style="list-style-type: none"> • Clean all parts using kerosene; Use scraper to remove old seal • During cleaning look already for damages
10. Determine the Damages	<ul style="list-style-type: none"> • Try to find the causes for the overhauling • Transfer all your findings to the maintenance history log
11. Distribute Work and Actual Repair	<ul style="list-style-type: none"> • Measure seats from all bearings and seals • Order spare parts and give parts to the machine shop • Weld broken parts, remove all dents from sealing surfaces, gears and other important parts • Dynamic balancing of parts
12. Break	<ul style="list-style-type: none"> • Break because of lack of spare parts and machine shop work • Store all parts properly (for longer storage, put some grease on critical parts and cover the whole machine with plastic foil)
13. Prepare Workplace for re-assembling	<ul style="list-style-type: none"> • Remove parts, tools and jigs from previous jobs from the working area • Clean up the working area
14. Re-assembling	<ul style="list-style-type: none"> • Before re-assembling make a plan in your mind on how to mount all parts. • Polish all seats of bearings and sealing • Do not use any unnecessary force! • Use the proper tools and methods for the installation of bearings and sealing • Do not over-grease bearings; Apply also grease to lip-rings and O-rings • To adjust bearing clearance, backlash and axial play of shafts use the proper measuring method and exactly fitting spacer rings • Use new flat seals or sealant • Use new bolts and nuts for re-assembling
15. Oil Filling	<ul style="list-style-type: none"> • Check the Machine-File or in the Owner-Manual to determine the proper type of oil • Do not overfill the reservoir; Do not spill oil; Check the sealing surfaces against oil leaking
16. Test Run	<ul style="list-style-type: none"> • Before installation the machine a test run should show the proper repair of the machine. In case of a problem it is easier to solve it with in the workshop.

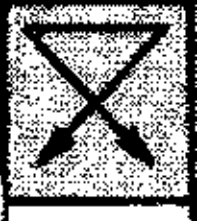
5.3 Shortcuts on Sketching Machine Parts during Disassembling

Part	Shortcut	Detailed	Part	Shortcut	Detailed
Radial Shaft Seal with on lip (lip on the left side)			V-Ring (lip on left side)		

<p>Radial Shaft Seal with one lip and one dust lip (lip on the left side, dust lip on the right side)</p>			<p>Labyrinth-ring</p>		
<p>Radial Shaft Seal with two lips</p>			<p>Packing</p>		

Examples

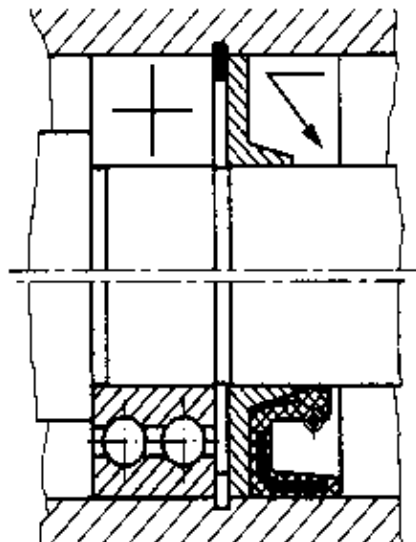
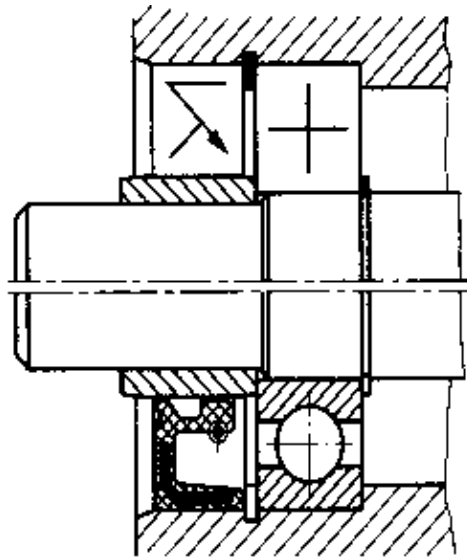

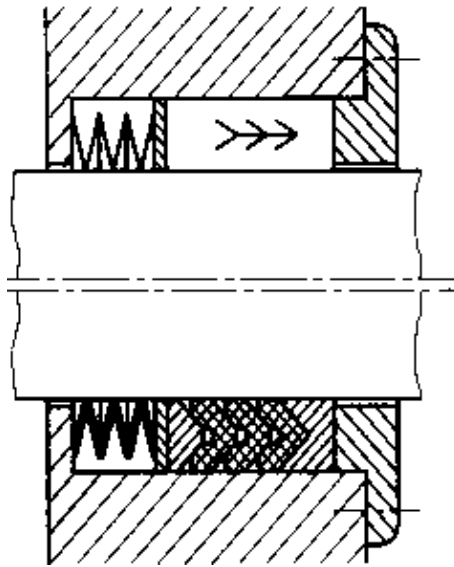

HANDS-ON EXERCISE FOR DISASSEMBLING A WORM GEAR DRIVE
Sketching Machine Parts and Contours

Disassembling – Sketch of Machine Contour

Disassembling – Sketch of Worm shaft including seals, bearing and spacer ring

Disassembling – Sketch of Gear shaft including seals, bearing and spacer ring

5. Repair Job – Teachers Copy

5.1 Exercises in Technical Drawing Interpreting

- Interpreting technical drawings
- Determining different rolling bearings
- Locating sealings
- Analysing the positioning of rolling bearings (floating, locating and adjusted arrangements)
- Determining the type of lubrication of assembly

- Describing the sequence of assembling

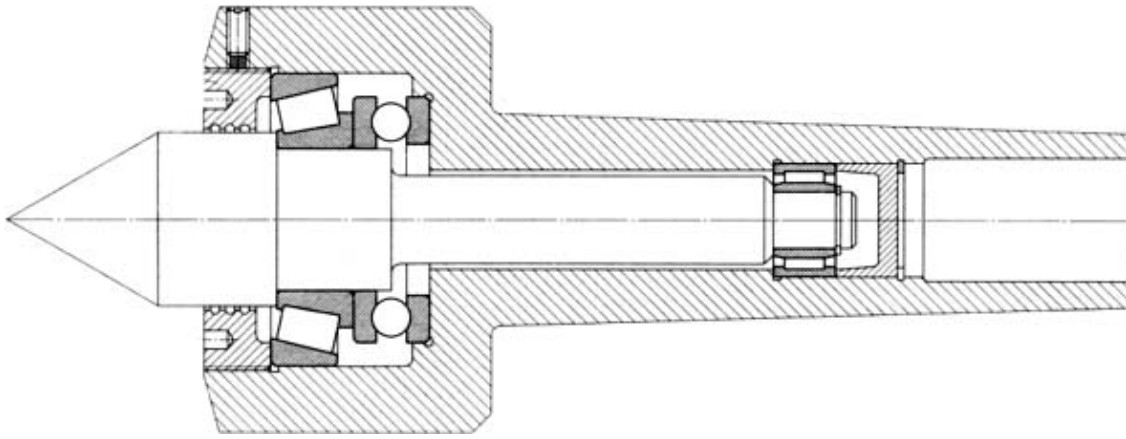

Working Sheet No. 1 – Live Center

1. Write down the different types of bearings.	Left side: Taper roller bearing, Axial Thrust Ball Bearing Right side: Needle roller bearing
2. What seals are used to keep the dirt out of the bearing housing?	Left side: Gap sealing with grooves Right side: End cover
3. Which is the floating side and which is the adjusted side?	Left side: Adjusted Right side: Floating
4. Discuss with the other trainees how the bearings are fixed.	Left side: The bearings are adjusted with an outside threaded ring nut. Right side: Inner and outer ring are fixed with snap rings.

5. Discuss with the other trainees how to assemble the live center.

1. Clean all parts.
2. Check measurements of bearing seats.
3. Prepare tools and equipment.
4. Install inner ring of cylindrical bearing on shaft and fix it with a snap ring.
5. Install outer ring of cylindrical bearing to housing.
6. Install collar cap and the snap ring on the cylindrical bearing side.
7. Install inner ring of tapered bearing on shaft.
8. Install washer of trust ball bearing next to tapered bearing.
9. Position housing vertically.
10. Install the other washer of trust ball bearing incl. rolling elements to housing.
11. Lubricate all bearings.
12. Install the shaft to housing carefully.
13. Install the outer ring of tapered roller bearing.
14. Thread in the locknut and adjust clearance of bearing.
15. Secure the locknut with set screw.

Exercise No. 2 – Water Pump

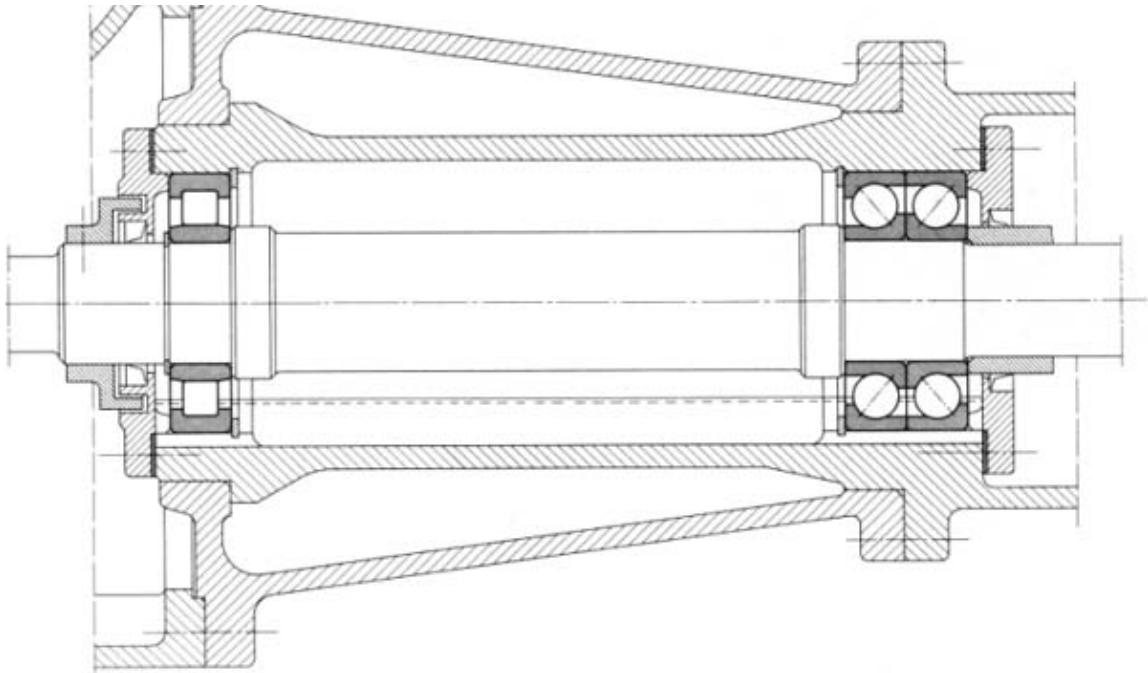

Working Sheet No. 2 – Water Pump

1. Write down the different types of bearings and the type of arrangement of the left side assembly.	Left side: Cylindrical roller bearing Right side: Angular contact bearing in X-arrangement (face to face)
2. What seals are used to keep the dirt out of the bearing housing?	Right side: Gasket between housing and cover • Radial shaft lip ring Left side: Gasket between housing and cover • Labyrinth ring • Radial shaft lip ring
3. How are the bearings lubricated?	Oil lubrication
4. Which is the floating side and which is the adjusted side?	Left side: Floating Right side: Located
5. Discuss with the other trainees how the bearings are fixed.	Left side: inner ring – shoulder of shaft and snap ring outer ring – snap ring and shoulder of housing end cover Right side: inner ring located with bushing, outer ring located with housing end cover.

6. Discuss with the other trainees how to assemble the water pump.

1. Clean all parts.
2. Take measurement of shaft and housing tolerance.
3. Prepare tools and equipment.
4. Install angular ball bearing face to face on shaft and fix it with bushing.
5. Install inner ring of cylindrical bearing on shaft and fix it with a snap ring.
6. Install two snap rings in housing (both side).
7. Position housing vertically – left side down

8. Insert shaft assembly carefully.
9. Install bearing cover including gasket and lip ring on angular bearing side. Fasten the bolt.
10. Position housing vertically – reverse position.
11. Install outer ring (incl. rolling elements) of cylindrical roller bearing in housing.
12. Install bearing cover including gasket and lip ring on housing and fasten the bolt.
13. Install labyrinth ring and fasten setscrew.
14. Position pumps horizontal and fill oil.

Exercise No. 3 – Converter

1. Write down the different types of bearings and the type of arrangement of the lower side assembly.	Upper side: Cylindrical Roller bearing Lower side: Angular Contact Bearings – Tandem Arrangement
2. What seals are used to keep the dirt out of the bearing housing?	Upper side: Labyrinth ring and gap type sealing Lower side: O-Ring and gap type with grooves
3. How are the bearings lubricated?	Grease lubrication
4. Which is the floating side and which is the located side?	Upper side: Floating Lower side: Located
5. Discuss with the other trainees how the bearings are fixed.	Upper side: Inner ring with bushing and housing cover Lower side: Shaft end plate and housing cover

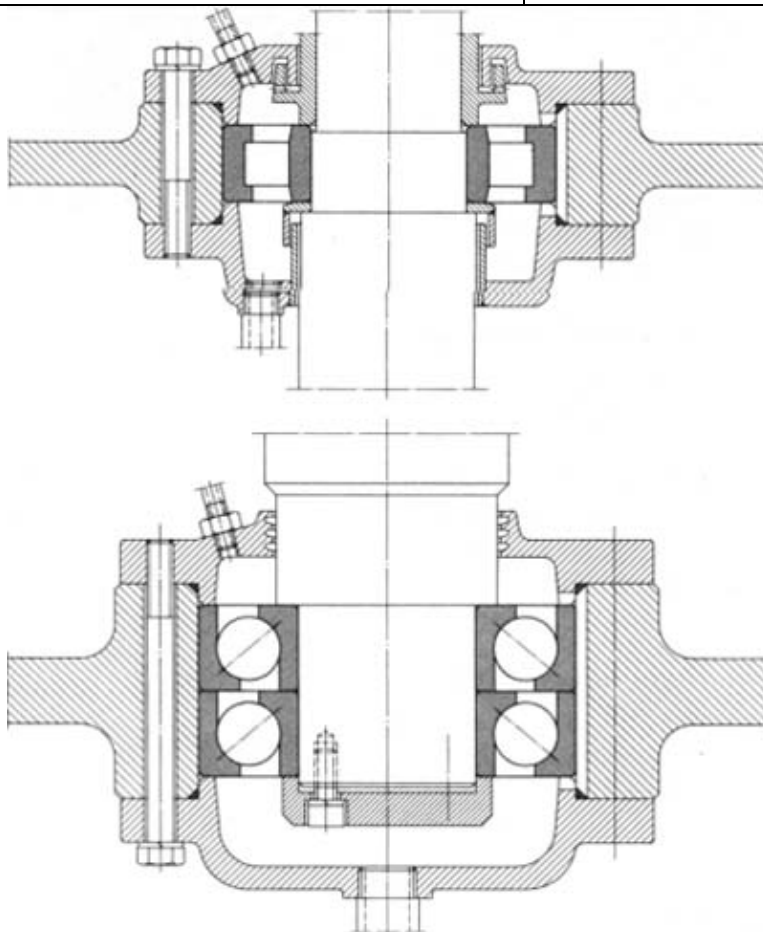

Interpreting Technical Drawing – Self Study

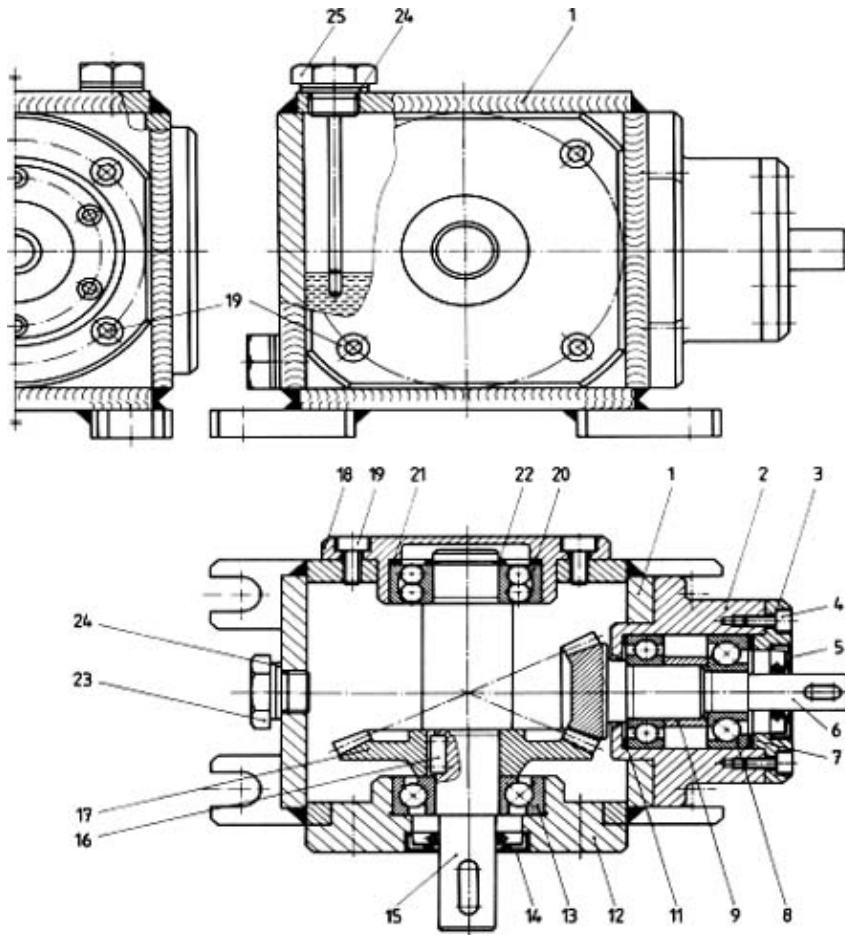

List of parts: Bevel Gear Drive

Pos	Pcs	Designation	Pos	Pcs	Designation	Pcs	Pce	Designation
1	1	Gearbox case	10	1	Deep groove ball bearing	19	12	Socket head screw
2	1	Bearing housing	11	1	Shim ring	20	1	Self-aligning ball bearing
3	1	Bearing crown	12	1	Bearing housing	21	1	Elastic distance ring
4	6	Socket head screw	13	1	Contact ball bearing	22	1	Snap ring
5	1	Lip seal	14	1	Lip seal	23	1	Closing cap
6	1	Mitre pinion wheel	15	1	Gear shaft	24	2	Copper ring
7	1	Shim ring	16	1	Feather key	25	1	Screw plug with oil dip stick
8	1	Angular ball bearing	17	1	Mitre wheel			
9	1	Spacer ring	18	1	Bearing housing			

5.2 General Instructions for a Repair Job within the Workshop

Working Steps	Comments
---------------	----------

1. Prepare Workplace for disassembling	<ul style="list-style-type: none"> • Remove parts, tools and jigs from previous jobs from the working area • Clean up the working area • Provide container for used oil • Provide new cleaning rags to clean up spilled oil and grease
2. Safety Check	<p>Ask yourself the following questions:</p> <ul style="list-style-type: none"> • Do I have the permission to do the job? • Am I skilled/trained to do the job? • Are there any hazards for me, for my colleagues or for the environment? E.g. Machine under pressure, machine under vacuum, machine filled with a hazardous medium, hazard because of electric shock
3. Sketch the outside Machine Contours	<ul style="list-style-type: none"> • To make sure that the machine can be re-assembled properly even after a longer period (e.g. Break because of lack of spare parts) • Consider that a colleague of you might re-assemble the machine. • Store the draft together with the machine parts
4. Remove Oil	<ul style="list-style-type: none"> • Before opening any part of the machine, remove oil • Catch the oil in an adequate container and store it for disposal • Do not spill oil
5. Mark all Parts before starting to disassemble	<ul style="list-style-type: none"> • To make sure that the machine can be re-assembled properly even after a longer period (e.g. Break because of lack of spare parts). Consider that a colleague of you might re-assemble the machine. • Use letter or number punch to mark parts • It is also possible to mark parts using a center punch, a small chisel or water and kerosene resistant paint
6. Draft a plan in your mind on how to disassemble the machine	<ul style="list-style-type: none"> • Use all available resources like manuals, drawings • Think first before starting to screw!
7. Disassemble the Machine	<ul style="list-style-type: none"> • Use the proper tools • Don't use any force and take care not to damage any part • Remove first couplings, pulleys, sprockets from the shafts • Open the housing • Remove shafts, bearings, sealing • Store all parts properly in a box with a soft surface. For sensitive parts put some cleaning rag around
8. Sketch the inner Assembly	<ul style="list-style-type: none"> • If necessary sketch the inner assembly. Consider that a colleague of you might re-assemble the machine. • Especially take note of spacer rings. Sketch the position of them.
9. Clean all Parts	<ul style="list-style-type: none"> • Clean all parts using kerosene; Use scraper to remove old seal • During cleaning look already for damages
10. Determine the Damages	<ul style="list-style-type: none"> • Try to find the causes for the overhauling • Transfer all your findings to the maintenance history log
11. Distribute Work and Actual Repair	<ul style="list-style-type: none"> • Measure seats from all bearings and seals • Order spare parts and give parts to the machine shop • Weld broken parts, remove all dents from sealing surfaces, gears and other important parts • Dynamic balancing of parts
12. Break	<ul style="list-style-type: none"> • Break because of lack of spare parts and machine shop work • Store all parts properly (for longer storage, put some grease on critical parts and cover the whole machine with plastic foil)
13. Prepare Workplace for re-assembling	<ul style="list-style-type: none"> • Remove parts, tools and jigs from previous jobs from the working area • Clean up the working area
14. Re-assembling	<ul style="list-style-type: none"> • Before re-assembling make a plan in your mind on how to mount all parts. • Polish all seats of bearings and sealing

	<ul style="list-style-type: none"> • Do not use any unnecessary force! • Use the proper tools and methods for the installation of bearings and sealing • Do not over-grease bearings; Apply also grease to lip-rings and O-rings • To adjust bearing clearance, backlash and axial play of shafts use the proper measuring method and exactly fitting spacer rings • Use new flat seals or sealant • Use new bolts and nuts for re-assembling
15. Oil Filling	<ul style="list-style-type: none"> • Check the Machine-File or in the Owner-Manual to determine the proper type of oil • Do not overfill the reservoir; Do not spill oil; Check the sealing surfaces against oil leaking
16. Test Run	<ul style="list-style-type: none"> • Before installation the machine a test run should show the proper repair of the machine. In case of a problem it is easier to solve it with in the workshop.

5.3 Shortcuts on Sketching Machine Parts during Disassembling

Part	Shortcut	Detailed	Part	Shortcut	Detailed
Radial Shaft Seal with one lip (lip on the left side)			V-Ring (lip on left side)		
Radial Shaft Seal with one lip and one dust lip (lip on the left side, dust lip on the right side)			Labyrinth-ring		
Radial Shaft Seal with two lips			Packing		

Examples

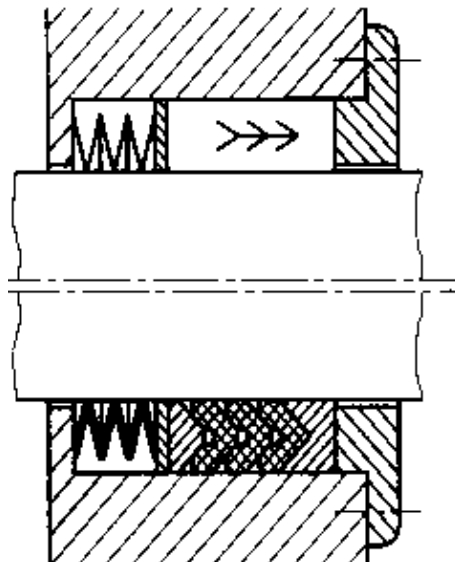
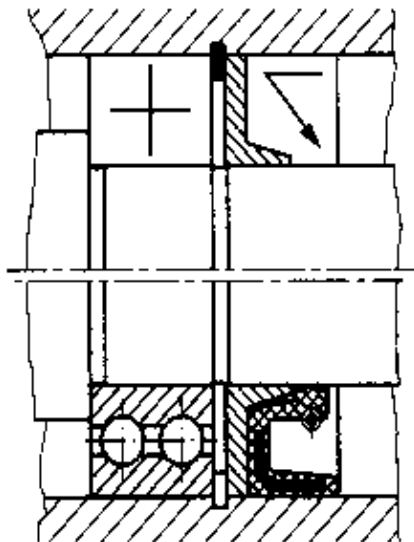
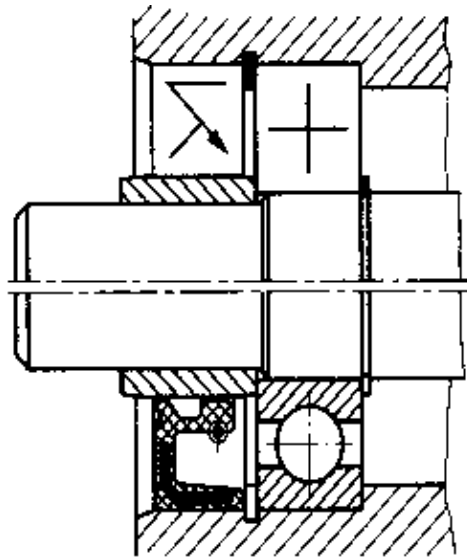

HANDS-ON EXERCISE FOR DISASSEMBLING A WORM GEAR DRIVE
Sketching Machine Parts and Contours

Disassembling – Sketch of Machine Contour

Disassembling – Sketch of Worm shaft including seals, bearing and spacer ring

Disassembling – Sketch of Gear shaft including seals, bearing and spacer ring

6. Safety

Safety equipment during repair activities

- Safety glasses
- Steel toed shoes
- Hard hat when using a overhead crane or other lifting devices
- Leather gloves when doing rough work
- Rubber gloves when cleaning machine parts or handling parts which are contaminated with product
- Plastic apron and gumboots when using steam cleaner
- Face shield when doing grinding work or cleaning machine parts with steam cleaner
- Heat protecting gloves when carrying hot parts

Safety rules during repair activities

- When you enter a production area log in. When you leave the place log out.
- Inform other colleagues when you start with activities they should know.
- Make sure that a machine you start to work on is electrically disabled.
- Be careful when opening any machine, which works under pressure or vacuum, like pumps, fans, compressor, hydraulic equipment or others. They can be still under working pressure and harm you.
- Be careful when opening any machine/parts, which can possibly contain products, like pipes, tanks, boilers, pumps and others. These products can harm your eyes, your body or

even your breathing.

- When handling heavy parts/tools use always a lifting device or ask your colleagues for help. You can seriously damage your back.
- When handling oil or grease, try to avoid spill or if spilled then remove it immediately.
- When working with oxy–acetylene burner, take care of fumes from old oil, grease or parts of products. Keep your head out of the fume or wear a suitable mask.
- Do not light a fire near petroleum or other inflammables.
- When opening bolts use the correct size of tools. Besides damaging the bolts you might slip off and damage your hands.
- When storing shafts or other round shaped parts prevent them from rolling of the working table using for example wood.

Final Knowledge Test

1. Name 3 different types of bolts (3 points)

2. What is the advantage of a stud bolt? (1 point)

- a. They are cheaper because they do not have a head.
- b. They are stronger than hexagon bolts.
- c. They will protect the housing thread if the joint is opened frequently.
- d. They will not rust so easy.

3. When do we use Body–Fit bolts? (1 point)

- a. When space is limited.
- b. If there is no hexagon bolt, we can use them instead.
- c. To prevent movement between the workpieces.
- d. No need for Body–Fit bolts at all.

4. Describe the procedure on how to repair a thread using "Heli–Coil". (1 point)

5. What is the minimum screw–in length for bolts? (1 point)

- a. 1 times the diameter of bolt
- b. 0.8 times the diameter of bolt
- c. 1.2 times the diameter of bolt
- d. 1.5 times the diameter of bolt

6. Name 4 different types of nuts. (4 point)

7. Name 4 different methods to prevent bolt and nut connections from loosening. (4 points)

8. Name the four main parts of rolling bearings. (4 points)

9. Name the 8 bearings below. (8 points)

- 1. _____
- 2. _____
- 3. _____
- 4. _____

- 5. _____
- 6. _____
- 7. _____
- 8. _____

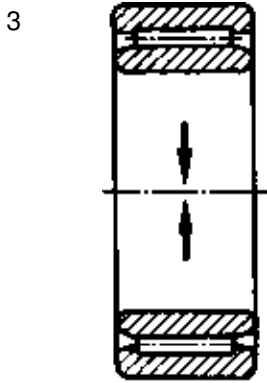
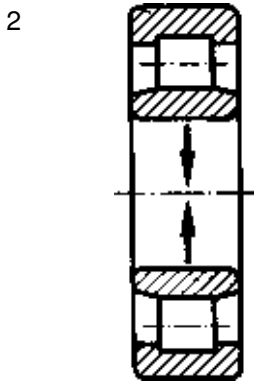
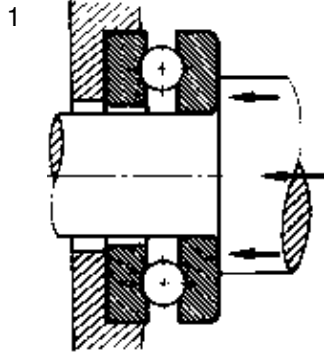

4

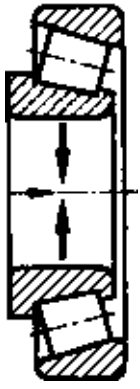

5



6



7



8

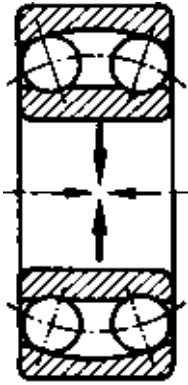

10. What are the 3 common types of loads for rolling bearings? (3 points)

11. Which of the following statements about storing bearings is true? (1 point)

- a. No need to store bearings. The supplier will deliver them in time.
- b. Bearings should be stored in a warm place in vertical position.
- c. Bearings should be stored beside the machine.
- d. Bearings should be stored in a dry place in horizontal position.

12. Name the 3 possible bearing arrangements. (3 point)

13. Which of the following statements about mounting tapered bearings is true? (1 point)

- a. The radial clearance can be measured with a feeler gauge.
- b. The radial clearance can be measured with a steel rule.
- c. The radial clearance can be measured with a micrometer gauge.
- d. The radial clearance can be measured with a micrometer height gauge.

14. Name 2 bearings suitable for radial loads and 2 bearings good for axial loads. (4 points)

Radial Loads

Axial Loads

15. Name the 3 bearings arrangements below. (3 point)

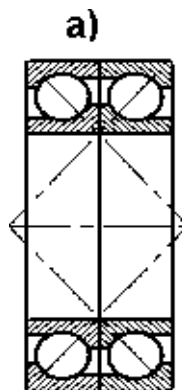

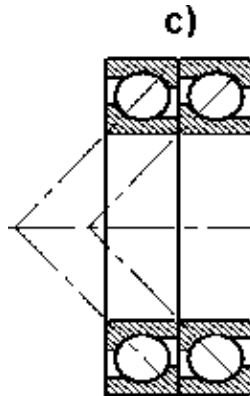
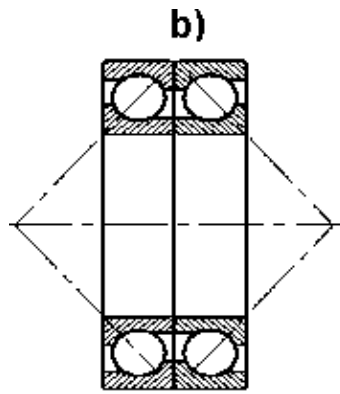

- a).....
- b).....
- c).....

16. Name the 3 bearing mounting methods. (3 point)

17. Which statement is true? (1 point)

- a. Radial shaft seals are static seals.
- b. Felt rings are non-rubbing seals.
- c. O-rings are non-rubbing seals.
- d. Face seals and sealing compounds are static seals.

18. What is not important for the radial shaft seal selection? (1 point)

- a. The size of the bearing.
- b. The medium that will come in contact with the seal.
- c. The max. temperature that will occur during operation.
- d. The max. working pressure

19. Which of the following statements about V-rings is true? (1 point)

- a. V-rings will hold the grease inside the housing
- b. V-rings will keep oil inside the housing
- c. V-rings work with a spring ring
- d. V-rings will keep dirt outside the housing

Maximum No of points: 48 = 100 %

Reached Points: =%

List of Needed Resources

Resource	Checked	Unit	Qty for 1 Trainee	Qty for 4 Trainees	Need to Order/Replace/Organize			
					Unit	Qty	Unit Price	Amount
Teaching Aids								
Handouts								
Overhead foil								
Video tapes (Gearing & Bearing)								
Overhead projectir								
White board & marker								
TV-VHS								
Forms								
Bio-data								
Participant reaction form								
Participant evaluation sheet								
Course evaluation								
Certificates								
Billing statement								
Consumables and Parts for Exercises								
Cotton rag								
Oil seal 8mmx30mmx45mm								
Roller bearing # 30204J								
Wheel bearing grease								
Extra 20W/30 multi grade (Oil)								
Fiber flex gasket								
Sand paper # 220 water proof								
Brass shim gauge .010								
Brass shim gauge .005								

Black silicon gasket # 80046								
					Need to Order/Replace/Organize			
Resource	Checked	Unit	Qty for 1 Trainee	Qty for 4 Trainees	Unit	Qty	Unit Price	Amount

Additional Information to Maintenance – Regular Threads – Tables

Metric	Pitch mm	Drill Ø mm	Wrench Size
M 3	0.50	2.5	5.5

M 4	0.70	3.3	7
M 5	0.80	4.2	8
M 6	1.00	5.0	10
M 8	1.25	6.8	13
M 10	1.50	8.5	16 (17)
M 12	1.75	10.2	18 (19)
M 16	2.00	14.0	24
M 20	2.50	17.5	30
M 24	3.00	21.0	36
M 30	3.50	26.5	46
M 36	4.00	32.0	55
M 42	4.50	37.5	65
M 48	5.00	43.0	75
M 56	5.50	50.5	85
M 64	6.00	58.0	95

UNC	TPI	Drill Ø mm
1/4 "	20	5.1
5/16"	18	6.6
3/8"	16	8.0
7/16"	14	9.4
1/2"	13	10.8
9/16"	12	12.2
5/8"	11	13.5
3/4"	10	16.5
7/8"	9	19.5
1"	8	22.25
UNF	TPI	Drill Ø mm
1/4 "	28	5.5
5/16"	24	6.9
3/8"	24	8.5
7/16"	20	9.9
1/2"	20	11.5
9/16"	18	12.9
5/8"	18	14.5
3/4"	16	17.5
7/8"	14	20.4

Torque Wrench



Mechanical Properties of Metric Compared to SAE Fasteners

	Class										
ISO Grade	4.6	4.8	5.6	5.8	6.6	6.8	6.9	8.8	10.9	12.9	14.9
SAE Grade	1	2	2	2	3	3	3	5	8	n/a	n/a
Brinell (HRB)	110-170		140-215		170-245			225-300	280-365	330-425	390 min.
Rockwell (HRC)	n/a		n/a		n/a			18-31	27-38	34-44	40-49

Yield (psi)		45,000	56,000	76,000	76,000	91,000	128,000	153,000	180,000
Tensile (kpsi)		56-78	70-100	85-113	85-99	113-128	142-170	170-200	200-230
		Prop Class 4.6		Prop Class 5.8		Prop Class 8.8			
Diam	Pitch	Bolt Tension kN	torque Nm	Bolt Tension kN	Torque Nm	Bolt Tension kN	Torque Nm	Torque Nm	
M1.6	0.35	0.19	0.06	0.31	0.10	0.48	0.15		
M2	0.40	0.31	0.12	0.51	0.20	0.78	0.31		
M2.5	0.40	0.31	0.12	0.51	0.20	0.78	0.31		
M3	0.50	0.73	0.44	1.24	0.74	1.90	1.10		
M4	0.70	1.29	1.00	2.17	1.70	3.32	2.70		
M5	0.80	2.08	2.10	3.51	3.50	5.35	5.00		
M6	1.00	2.94	3.50	4.97	5.90	7.54	9.00		
M8	1.25	5.36	8.50	9.04	14.0	13.8	22.0		
M10	1.50	8.45	17.0	14.3	29.0	21.9	44.0		
M12	1.75	12.4	30.0	20.8	49.0	31.8	77.0		
M14	2.00	16.8	47.0	28.4	79.0	43.4	122.0		
M16	2.00	22.9	73.0	38.8	124.0	59.2	190.0		
M18	2.50	28.1	101.0	47.5	171.0	74.8	269.0		
M20	2.50	35.8	143.0	60.5	242.0	95.6	372.0		
M22	2.50	44.3	195.0	74.8	329.0	118.0	519.0		
M24	3.00	51.6	248.0	87.1	418.0	138.0	640.0		
M27	3.00	66.9	361.0	113.0	610.0	179.0	967.0		
M30	3.50	81.9	491.0	138.0	828.0	219.0	1314.0		
		Prop Class 10.9		Prop Class 12.9					
Diam	Pitch	Bolt Tension kN	torque Nm	Bolt Tension kN	Torque Nm				
M1.6	0.35	0.68	0.22						
M2	0.40	1.12	0.45						
M2.5	0.45	1.83	0.92						
M3	0.50	2.72	1.60	3.17	1.90				
M4	0.70	4.74	3.80	5.54	4.40				
M5	0.80	7.67	8.00	8.97	8.90				
M6	1.00	10.9	13.0	12.7	15.0				
M8	1.25	19.8	32.0	23.1	37.0				
M10	1.50	31.3	63.0	36.6	73.0				
M12	1.75	45.5	109.0	53.2	128.0				
M14	2.00	62.1	174.0	72.8	203.0				

M16	2.00	84.5	270.0	98.8	316.0
M18	2.50	103.0	371.0	121.0	436.0
M20	2.50	132.0	528.0	155.0	620.0
M22	2.50	164.0	722.0	191.0	840.0
M24	3.00	190.0	914.0	222.0	1066.0
M27	3.00	248.0	1339.0	289.0	1561.0
M30	3.50	303.0	1817.0	354.0	2124.0

Conversions			
Kg.cm	0.0981 Nm		
Kg.m	9.81 Nm		
lb.in	0.083 lb.ft	0.113 Nm	
lb.ft	12.0 lb.in	1.356 Nm	
Nm	8.851 lb.in	0.738 lb.ft	
kpm	7.23 lb.ft	86.8 lb.in	9.807 Nm

Additional Overhead Foils

Disassembling a Machine – Make use of all available Information

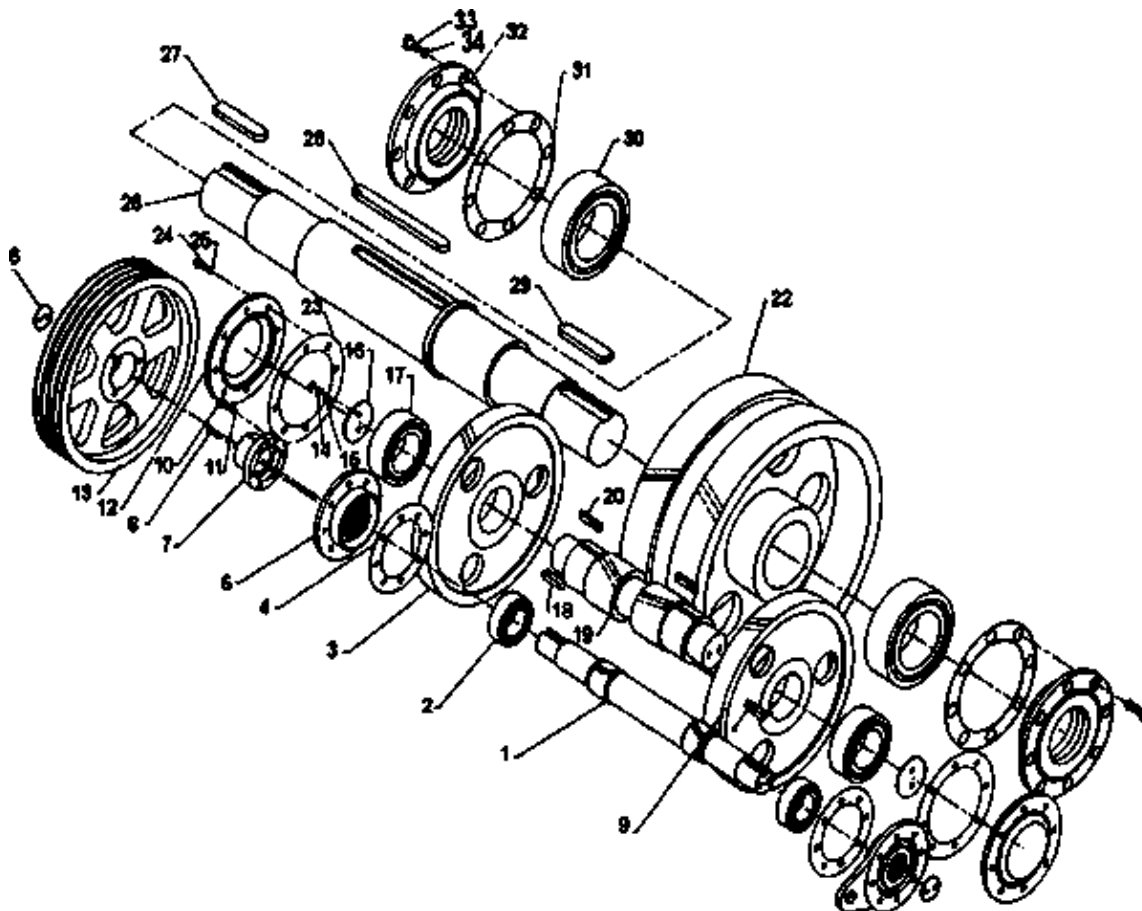

International Gear Reducer Assembly

No.	Description
1.	High speed pinion
2.	High speed bearing
3.	High speed gear, left
4.	High speed pinion cover plate gasket
5.	High speed bearing cover
6.	High speed pinion end cap
7.	Drive sheave hub
8.	Bolt, HS end cap
9.	High speed gear, right
10.	Bots, hub to drive sheave
11.	Lock washer, hub to sheave
12.	Intermediate bearing cover
13.	Drive sheave
14.	Bolt, Int end cap
15.	Wire
16.	Intermediate end cap
17.	Intermediate bearing
18.	Key, high speed pinion
19.	Low speed pinion
20.	Key, low speed pinion
21.	Key, high speed pinion
22.	Low speed gear
23.	Low speed pinion cover plate gasket
24.	Bolt, Intermediate cover plate
25.	Lock washer, Intermediate cover plate
26.	Crank shaft
27.	Key, crank shaft to crank arm
28.	Key, crank shaft to slow speed
29.	Key, crank shaft to crank arm
30.	Low speed bearing
31.	Crank shaft cover plate gasket
32.	Crank shaft cover plate
33.	Bolt, crank shaft cover plate
34.	Washer, crank shaft cover plate

Types of Radial Shaft Rings and their Duty

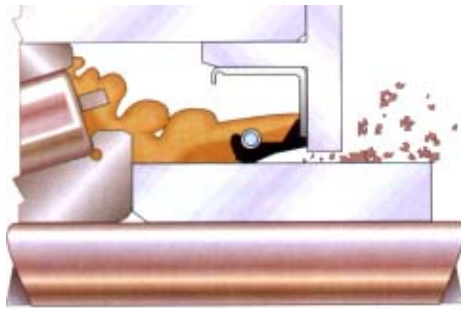

Grease Retention



Oil Retention



Exclusion

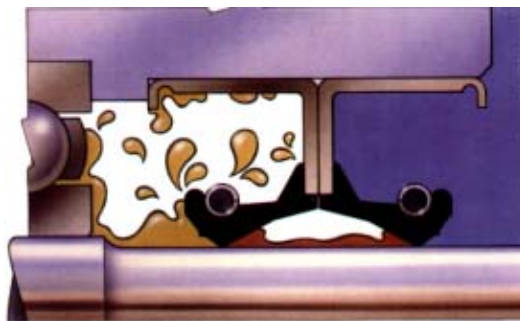

Separation of two Liquids

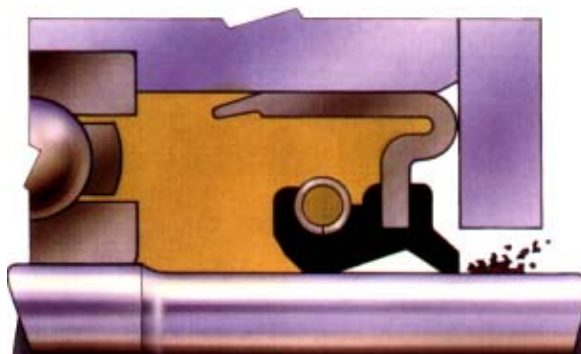

Containing High Pressure

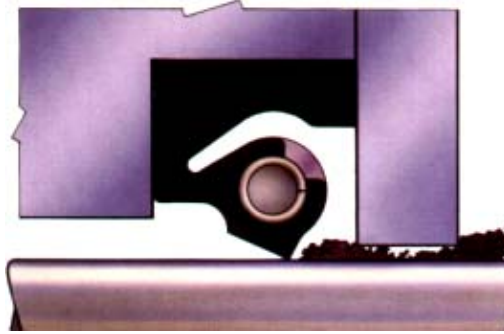

Installation Restrictions

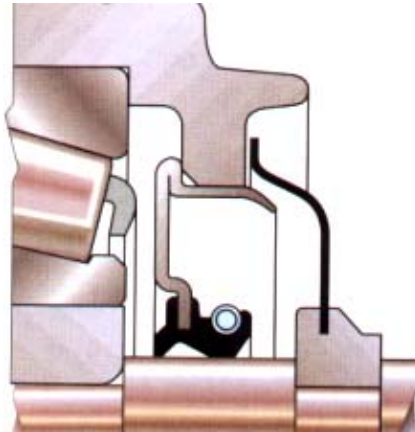





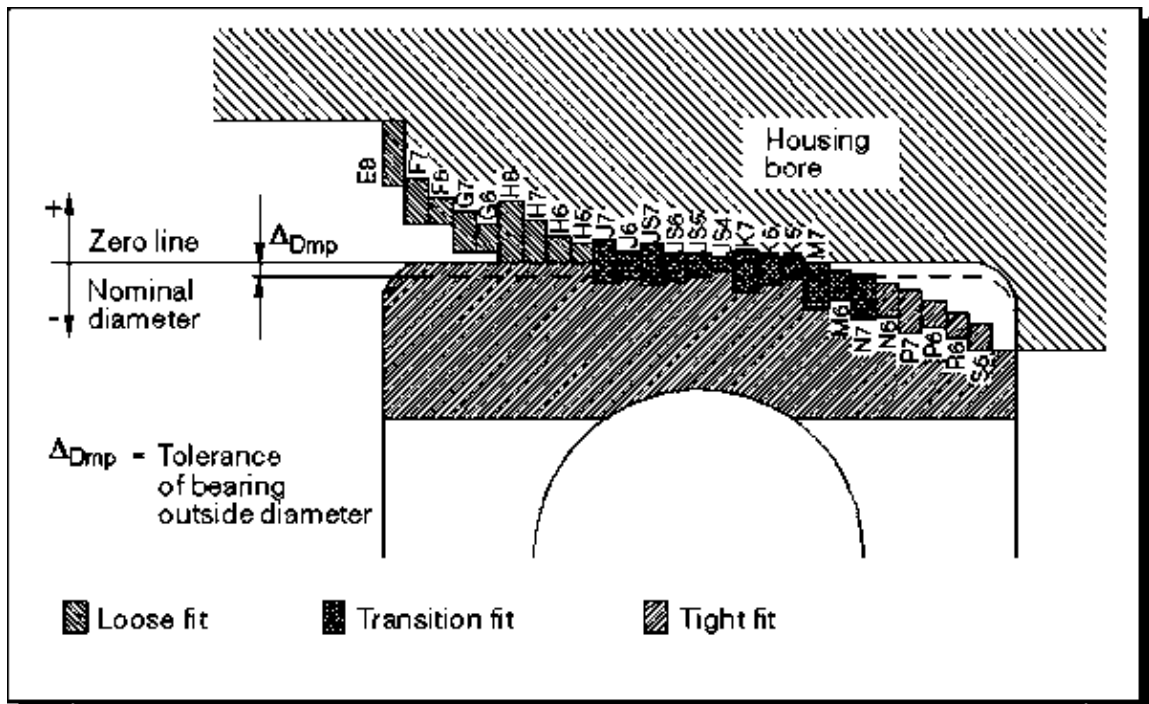

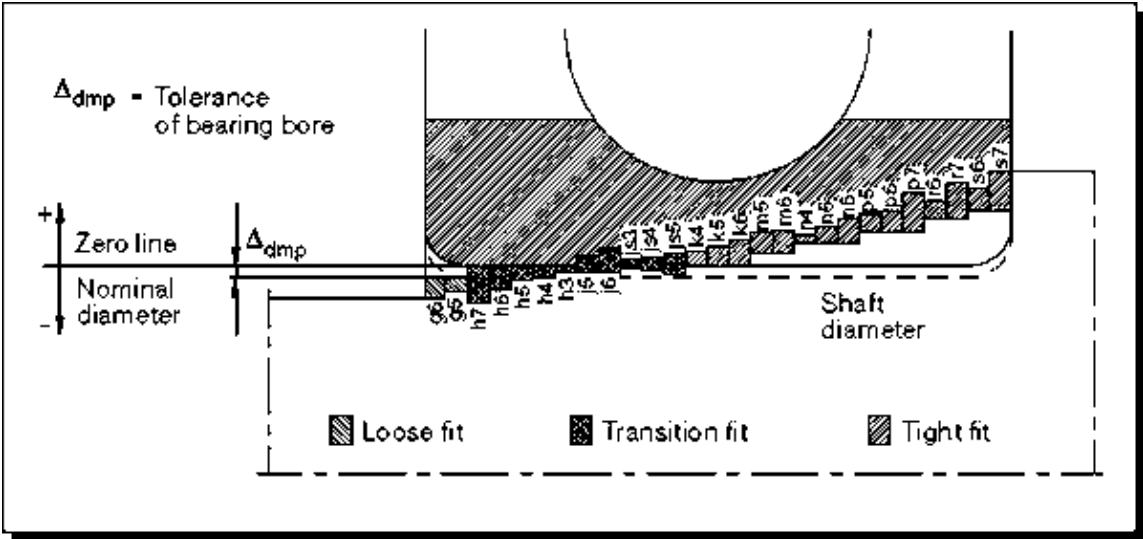









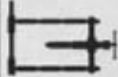
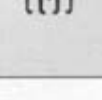





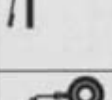





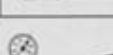

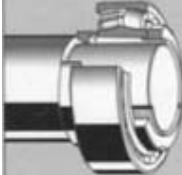





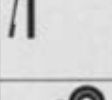







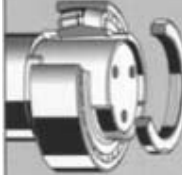

Restricted Space

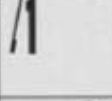
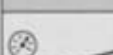



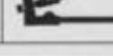

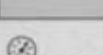

ISO TOLERANCE SYSTEM – SHAFT AND HOUSING

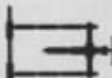

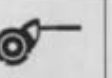

Bearing arrangements		Mounting tools				Dismounting tools			
		Mechanical	Hydraulic	Oil Injection	Heaters	Mechanical	Hydraulic	Oil injection	Heaters
Cylindrical seating  Small bearings Medium bearings Large bearings Cylindrical roller bearing types NU, NJ, NUP, all sizes	Small bearings								
	Medium bearings								
	Large bearings								
	Cylindrical roller bearing types NU, NJ, NUP, all sizes								
Tapered seating  Small bearings Medium bearings Large bearings	Small bearings								
	Medium bearings								
	Large bearings								
Adapter sleeve  Small bearings Medium bearings Large bearings	Small bearings								
	Medium bearings								
	Large bearings								
Withdrawal sleeve  Small bearings Medium bearings Large bearings	Small bearings								
	Medium bearings								
	Large bearings								

Small bearings: Bore diameter < 80 mm • Medium bearings: Bore diameter 80 - 200 mm • Large bearings: Bore diameter > 200 mm
 * Only for self-aligning ball bearings.

Key									
									
Jaw puller	Bearing separator	Hydraulic puller	Fitting tool	Hook spanner	Impact spanner	Hydraulic nut and pump	Oil injection method	Hot plate induction heater	Aluminium ring EAZ heater

APPLICATION OF ROLLING BEARING

Deep Groove Ball Bearings	Angular Contact	Double Row
<ul style="list-style-type: none"> • Transmissions • Electric Motors • Generators • Electrical Appliances • Pumps & Compressors • Blowers & Fans • Speed Changers • Gear Boxes & Drives • Woodworking Machinery • Lawn & Garden Equipment • Turbines • Farm Machinery • Construction Machinery • Oil Field Machinery • Elevators • Conveying Equipment • Hoists & Cranes • Power Hand Tools • Industrial Valves • Rolling Mill Machinery • Textile Machinery • Paper Machinery • Printing Machinery • Food Products Machinery • Packaging Machinery • Medical & Dental Equipment (extra small) • Robotics Equipment (thin) • Industrial Clutches • Slip Joints • Skate Boards • Inline Skates 	<ul style="list-style-type: none"> • Metal Rolling Mills • Oil Field Equipment • Gear Boxes & Drives • Deep Well Pumps • Centrifugal Pumps • Electric Motors • Generators • Blowers and Fans • Gear Reducers 	<ul style="list-style-type: none"> • Petrochemical Equipment • Centrifugal Pumps • (Conrad) • Electric Motors (Conrad) • Transmissions • Worm Drives • Blowers & Fans • Film Processing Equipment (Self-Aligning) • Vertical Spinning Equipment (Self-Aligning) • Vertical Weaving Equipment (Self-Aligning) • Paper Making – • Industrial Countershafts

ROLLING BEARING – SAMPLE OF A DESIGNATION SYSTEM

Yield (psi)	45,000	56,000	76,000	76,000	91,000	128,000	153,000	180,000
Tensile (kpsi)	56–78	70–100	85–113	85–99	113–128	142–170	170–200	200–230

Below you can find a table for torque and tension for different Property Classes.

		Prop Class 4.6		Prop Class 5.8		Prop Class 8.8	
Diam	Pitch	Bolt Tension kN	torque Nm	Bolt Tension kN	Torque Nm	Bolt Tension kN	Torque Nm
M1.6	0.35	0.19	0.06	0.31	0.10	0.48	0.15
M2	0.40	0.31	0.12	0.51	0.20	0.78	0.31
M2.5	0.40	0.31	0.12	0.51	0.20	0.78	0.31
M3	0.50	0.73	0.44	1.24	0.74	1.90	1.10
M4	0.70	1.29	1.00	2.17	1.70	3.32	2.70
M5	0.80	2.08	2.10	3.51	3.50	5.35	5.00
M6	1.00	2.94	3.50	4.97	5.90	7.54	9.00
M8	1.25	5.36	8.50	9.04	14.0	13.8	22.0
M10	1.50	8.45	17.0	14.3	29.0	21.9	44.0
M12	1.75	12.4	30.0	20.8	49.0	31.8	77.0
M14	2.00	16.8	47.0	28.4	79.0	43.4	122.0
M16	2.00	22.9	73.0	38.8	124.0	59.2	190.0
M18	2.50	28.1	101.0	47.5	171.0	74.8	269.0
M20	2.50	35.8	143.0	60.5	242.0	95.6	372.0
M22	2.50	44.3	195.0	74.8	329.0	118.0	519.0
M24	3.00	51.6	248.0	87.1	418.0	138.0	640.0
M27	3.00	66.9	361.0	113.0	610.0	179.0	967.0
M30	3.50	81.9	491.0	138.0	828.0	219.0	1314.0
M33	3.50	101.0	667.0	172.0	1135.0	270.0	1782.0
		Prop Class 10.9		Prop Class 12.9			
Diam	Pitch	Bolt Tension kN	torque Nm	Bolt Tension kN	Torque Nm		
M1.6	0.35	0.68	0.22				
M2	0.40	1.12	0.45				
M2.5	0.45	1.83	0.92				
M3	0.50	2.72	1.60	3.17	1.90		
M4	0.70	4.74	3.80	5.54	4.40		
M5	0.80	7.67	8.00	8.97	8.90		
M6	1.00	10.9	13.0	12.7	15.0		
M8	1.25	19.8	32.0	23.1	37.0		
M10	1.50	31.3	63.0	36.6	73.0		

M12	1.75	45.5	109.0	53.2	128.0
M14	2.00	62.1	174.0	72.8	203.0
M16	2.00	84.5	270.0	98.8	316.0
M18	2.50	103.0	371.0	121.0	436.0
M20	2.50	132.0	528.0	155.0	620.0
M22	2.50	164.0	722.0	191.0	840.0
M24	3.00	190.0	914.0	222.0	1066.0
M27	3.00	248.0	1339.0	289.0	1561.0
M30	3.50	303.0	1817.0	354.0	2124.0
M33	3.50	371.0	2449.0	437.0	2884.0
M36	4.00	441.0	3173.0	515.0	3708.0

To measure the torque there are still different units common. Below you can find a conversion table.

Conversions			
Kg.cm	0.0981 Nm		
Kg.m	9.81 Nm		
lb.in	0.083 lb.ft	0.113 Nm	
lb.ft	12.0 lb.in	1.356 Nm	
Nm	8.851 lb.in	0.738 lb.ft	
kpm	7.23 lb.ft	86.8 lb.in	9.807 Nm

Below you can find a table for torque and tension for different Property Classes – SAE Type Bolts.

Cap Screw Diameter	Grade 2			Grade 5			Grade 8		
	Minimum Yield Strength (psi)	Torque (ft-lb)		Minimum Yield Strength (psi)	Torque (ft-lb)		Minimum Yield Strength (psi)	Torque (ft-lb)	
		UNRC	UNRF		UNRC	UNRF		UNRC	UNRF
1/4	57,000	6	7	92,000	10	11	130,000	14	15
5/16	57,000	12	14	92,000	20	22	130,000	28	31
3/8	57,000	22	25	92,000	36	40	130,000	50	60
7/16	57,000	35	39	92,000	57	64	130,000	80	90
1/2	57,000	54	61	92,000	90	100	130,000	125	140
9/16	57,000	77	87	92,000	125	140	130,000	180	200
5/8	57,000	107	122	92,000	175	200	130,000	240	280
3/4	57,000	190	212	92,000	310	340	130,000	430	480
7/8	57,000	193	216	92,000	500	550	130,000	700	770
1	36,000	290	320	92,000	740	810	130,000	1050	1150

1 1/8	36,000	410	470	81,000	930	1040		---	---
1 1/4	36,000	580	645	81,000	1300	1440	---	---	---
1 3/8	36,000	760	870	81,000	1700	1900	---	---	---
1 1/2	36,000	1010	1115	81,000	2270	2550	---	---	---

THREAD INSERTS FOR THREAD REPAIR

Thread Inserts (also called Heli-Coil) are used if the originally thread has been damaged. Coil inserts are made from high quality stainless steel wire, with a diamond shaped cross section, wound to the shape of a spring thread. The insert, which is larger in diameter than the tapped hole is compressed during installation then allowed go spring back, permanently anchoring the insert in the tapped hole.

Steps in repair:

- Drill out the damaged threads using the drill size specified in the manufacturers catalog
- Tap the hole using the special Coil Tap specified in the manufacturers catalog
- Install the replacement Coil. Wind the Coil into the hole. To brake the tang using the recommended special tool.

Advantages of Heli-Coil:

- They create stronger and more efficient threads.
- Simply and easy to use.
- Designed for use in material such as alloys, steel, magnesium, plastic etc.
- Simplifies changeover from inch to metric, and vice versa
- Meets Aviation Specifications
- Coils are interchangeable with other brands of helically wound inserts.
- Wide temperature range of up to 430°C
- Specials available in Inconel or Phosphor Bronze



The Coil Range:

The multiple size repair kit range from Unified, Metric, NPT, Spark Plug and British Standard thread forms.

- Inserts are available in five lengths, 1 x dia. to 3 x dia.
- Inserts are available as replacement packs, bulk or stripfeed.
- Inserts are available in free running or screw lock style for applications where the thread assembly is subject to vibration.

- Inserts can be supplied in Inconel X-750 for high temperature applications.
- Coatings such as cadmium, silver and dry film lubricant are available.
- High speed taps with either intermediate, taper or bottoming leads and spiral point or spiral flute for machine applications.
- Wide range of tools and accessories:

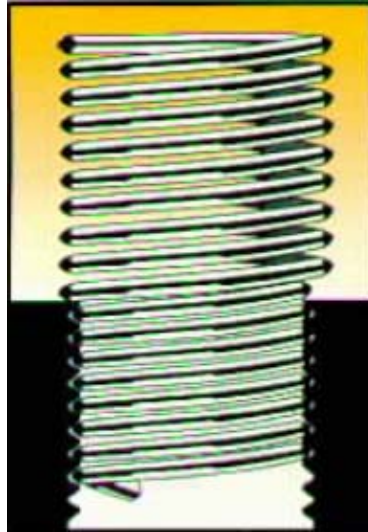

Sample of ISO – Tables

Table for Basic Shaft System – h6 (all limits in μm – 1 $\mu\text{m} = 0.001 \text{ mm}$)

Nominal Size mm	h6	Loose Fit			Transition Fit				Force Fit	
		F8	G7	H7	J7	K7	M7	N7	R7	S7
1 to 3	0	+ 20	+ 12	+ 10	+ 4	0	- 2	- 4	- 10	- 14
	-6	+ 6	+ 2	0	- 6	-10	- 12	- 14	- 20	- 24
3 to 6	0	+ 28	+ 16	+ 12	+ 6	+ 3	0	- 4	- 11	- 15
	-8	+ 10	+ 4	0	- 6	- 9	- 12	- 16	- 23	- 27
6 to 10	0	+ 35	+ 20	+ 15	+ 8	+ 5	0	- 4	- 13	- 17
	-9	+ 13	+ 5	0	- 7	- 10	- 15	- 19	- 28	- 32
10 to 18	0	+ 43	+ 24	+ 18	+ 10	+ 6	0	- 5	- 16	- 21
	-11	+ 16	+ 6	0	- 8	- 12	- 18	- 23	- 34	- 39
18 to 30	0	+ 53	+ 28	+ 21	+ 12	+ 6	0	- 7	- 20	- 27
	-13	+ 20	+ 7	0	- 9	- 15	- 21	- 28	- 41	- 48
30 to 50	0	+ 64	+ 34	+ 25	+ 14	+ 7	0	- 8	- 25	- 34
	-16	+ 25	+ 9	0	- 11	- 18	- 25	- 33	- 50	- 59
50 to 65	0	+ 76	+ 40	+ 30	+ 18	+ 9	0	- 9	- 30	- 42
	-19	+ 30	+ 10	0	- 12	- 21	- 30	- 39	- 60	- 72
65 to 80	0	+ 76	+ 40	+ 30	+ 18	+ 9	0	- 9	- 32	- 48
	-19	+ 30	+ 10	0	- 12	- 21	- 30	- 39	- 62	- 78

80 to 100	0	+ 90	+ 47	+ 35	+ 22	+ 10	0	- 10	- 38	- 58
	-22	+ 36	+ 12	0	- 13	- 25	- 35	- 45	- 73	- 93

Table for Basic Hole System – H7 (all limits in μm – 1 $\mu\text{m} = 0.001 \text{ mm}$)

		Loose Fit			Transition Fit				Force Fit	
Nominal Size mm	H7	f7	g6	h6	j6	k6	m6	n6	r6	s6
1 to 3	+ 10	- 6	- 2	0	+ 4	+ 6	+ 8	+ 10	+ 16	+ 20
	0	- 16	- 8	- 6	- 2	0	+ 2	+ 4	+ 10	+ 14
3 to 6	+ 12	- 10	- 4	0	+ 6	+ 9	+ 12	+ 16	+ 23	+ 27
	0	- 22	- 12	- 8	- 2	+ 1	+ 4	+ 8	+ 15	+ 19
6 to 10	+ 15	- 13	- 5	0	+ 7	+ 10	+ 15	+ 19	+ 28	+ 32
	0	- 28	- 14	- 9	- 2	+ 1	+ 6	+ 10	+ 19	+ 23
10 to 18	+ 18	- 16	- 6	0	+ 8	+ 12	+ 18	+ 23	+ 34	+ 39
	0	- 34	- 17	- 11	- 3	+ 1	+ 7	+ 12	+ 23	+ 28
18 to 30	+ 21	- 20	- 7	0	+ 9	+ 15	+ 21	+ 28	+ 41	+ 48
	0	- 41	- 20	- 13	- 4	+ 2	+ 8	+ 15	+ 28	+ 35
30 to 50	+ 25	- 25	- 9	0	+ 11	+ 18	+ 25	+ 33	+ 50	+ 59
	0	- 50	- 25	- 16	- 5	+ 2	+ 9	+ 17	+ 34	+ 43
50 to 65	+ 30	- 30	- 10	0	+ 12	+ 21	+ 30	+ 39	+ 60	+ 72
	0	- 60	- 29	- 19	- 7	+ 2	+ 11	+ 20	+ 41	+ 53
65 to 80	+ 30	- 30	- 10	0	+ 12	+ 21	+ 30	+ 39	+ 62	+ 78
	0	- 60	- 29	- 19	- 7	+ 2	+ 11	+ 20	+ 43	+ 59
80 to 100	+ 35	- 36	- 12	0	+ 13	+ 25	+ 35	+ 45	+ 73	+ 93
	0	- 71	- 34	- 22	- 9	+ 3	+ 13	+ 23	+ 51	+ 71

Assessment of Participants

Previous Knowledge about Bearing

1. Do you have any experience with bearings? Yes No

2. What kind of experience?

3. Name some machines/devices, which contains bearings.

-	-	-
-	-	-
-	-	-

-	-	-
---	---	---

4. Name different kind of bearings.

-	-
-	-
-	-
-	-

5. Name the parts, which a bearing consists of?

-	-
-	-
-	-

6. What stands the Appendix "C3" in bearing designation for?

7. What stands the Prefix "NU" in bearing designation for?

8. Name some tools you need to mount and dismount bearings.

-	-
-	-
-	-

1. Do you know what a floating and a locating bearings is? Yes No

