





➔  **Shaping of Surfaces Standing at an Angle to each other and Stepped Surfaces - Course: Techniques for machining of material. Trainees' handbook of lessons (Institut fr Berufliche Entwicklung, 21 p.)**

 **(introduction...)**

-  **1. Purpose of shaping surfaces standing at an angle to each other and stepped surfaces**
-  **2. Kinds and construction of shaping tools to be used**
-  **3. Preparation for shaping of surfaces standing at an angle to each other and stepped surfaces**
-  **4. Shaping of surfaces standing at an angle to each other and stepped surfaces**



[Home](#) > [ar.cn.de.en.es.fr.id.it.ph.po.ru.sw](#)

 **Shaping of Surfaces Standing at an Angle to each other and Stepped Surfaces - Course: Techniques for machining of material. Trainees' handbook of lessons (Institut fr Berufliche Entwicklung, 21 p.)**

➔  **(introduction...)**

-  **1. Purpose of shaping surfaces standing at an angle to each other and stepped surfaces**



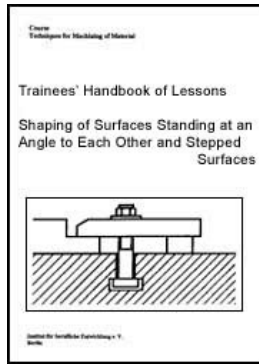

- 2. Kinds and construction of shaping tools to be used
- 3. Preparation for shaping of surfaces standing at an angle to each other and stepped surfaces
- 4. Shaping of surfaces standing at an angle to each other and stepped surfaces

**Institut fr berufliche Entwicklung e.V.
Berlin**

**Original title:
Arbeitsmaterial fr den Lernenden
"Stoen von im Winkel stehenden und abgesetzten Fichen"**

Author: Detlev Krechlok

First edition © IBE

**Institut fr berufliche Entwicklung e.V.
Parkstrae 23
13187 Berlin**

Order No.: 90-35-3403/2





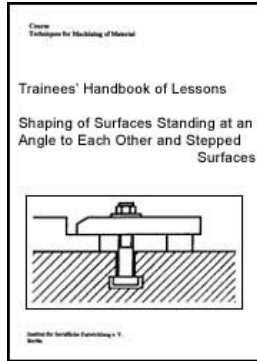

[Home](#) > [ar](#).[cn](#).[de](#).[en](#).[es](#).[fr](#).[id](#).[it](#).[ph](#).[po](#).[ru](#).[sw](#)



 **Shaping of Surfaces Standing at an Angle to each other and Stepped Surfaces - Course: Techniques for machining of material. Trainees' handbook of lessons (Institut für Berufliche Entwicklung, 21 p.)**

 **(introduction...)**

-   **1. Purpose of shaping surfaces standing at an angle to each other and stepped surfaces**
-  **2. Kinds and construction of shaping tools to be used**
-  **3. Preparation for shaping of surfaces standing at an angle to each other and stepped surfaces**
-  **4. Shaping of surfaces standing at an angle to each other and stepped surfaces**

1. Purpose of shaping surfaces standing at an angle to each other and stepped surfaces

When shaping surfaces standing at an angle to each other, surfaces are machined which meet at one edge at right angles or inclined to each other.

The size and position of the angle may vary.

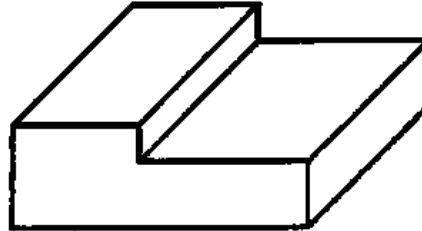

Figure 1. Surfaces standing at right angles to each other

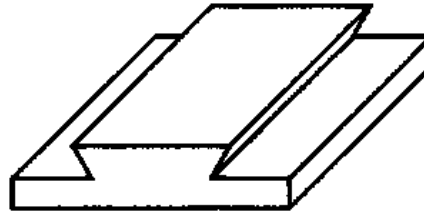

Figure 2. Surfaces standing inclined to each other

When shaping stepped surfaces, surfaces are machined which in several steps stand vertically or at an angle to the plane surface.

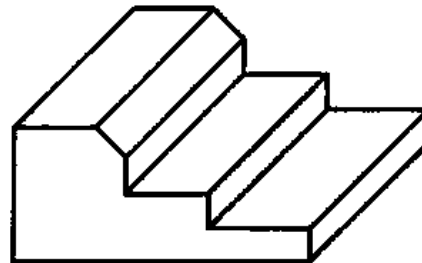

Figure 3. Stepped surfaces

A combination of both techniques is possible.

During shaping normally big amounts of material are removed by straight-lined cutting and feed movements. Prismatic workpieces are mainly machined.

Angular and stepped surfaces are used as bearing or guiding surfaces.

As with shaping a surface finish of $R_z = 20 \mu\text{m}$ can be reached at best, subsequent techniques such as grinding and scraping are often applied.

What is to be understood by shaping of stepped surfaces?

Where are angular and stepped surfaces used?



[Home](#) > [ar](#).[cn](#).[de](#).[en](#).[es](#).[fr](#).[id](#).[it](#).[ph](#).[po](#).[ru](#).[sw](#)

 **Shaping of Surfaces Standing at an Angle to each other and Stepped Surfaces - Course: Techniques for machining of material. Trainees' handbook of lessons (Institut fr Berufliche Entwicklung, 21 p.)**

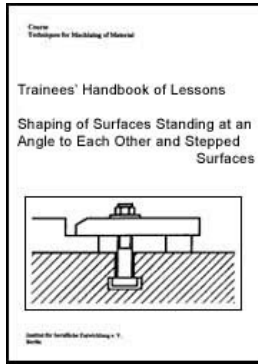

(introduction...)



- 1. Purpose of shaping surfaces standing at an angle to each other and stepped surfaces**
- 2. Kinds and construction of shaping tools to be used**
- 3. Preparation for shaping of surfaces standing at an angle to each other and stepped surfaces**
- 4. Shaping of surfaces standing at an angle to each other and stepped surfaces**

2. Kinds and construction of shaping tools to be used

Shaping tools show a great variety as far as their shapes and dimensions are concerned. All tools can be used which are also applied for the technique of turning, machining of external contours.

For shaping surfaces standing at an angle to each other and stepped surfaces the following shaping tools are applied:

- Straight tool

It is most frequently used for roughing of stepped surfaces. It can take up great cutting forces, but it has the property to bounce and, thus, to hook into the work.



Figure 4. Straight tool

- Offset tool

It is used, as a rule, for side machining.



Figure 5. Offset tool

- Swan-necked tool

It is used when the tool holder does not allow another tool to be used. Backward swan-necked or offset tools are especially suitable, as they bounce out of the workpiece and, thus, do not hook into it.



Figure 6. Swan-necked tool



Figure 7. Backward-offset tool

- Shoulder tool

It is used for machining shoulders. Because of its cutting-edge shape, however, the risk of getting broken is greater on this tool.



Figure 8. Shoulder tool

- Broad-nose tool

It is suited for machining end faces.



Figure 9. Broad-nose tool

According to the shape of the workpiece or surface finish the following forming tools are used:

- Pointed shoulder tool

It is used for finishing angular surfaces.



Figure 10. Shoulder slotting tool

- Radius tool

It is used for shaping radii.



Figure 11. Radius tool

- Grooving tool

It is used for shaping longitudinal grooves.

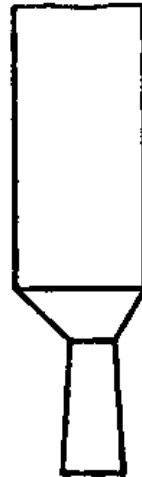

Figure 12. Grooving tool

- Keyway tool

It is used for shaping angular keyways.

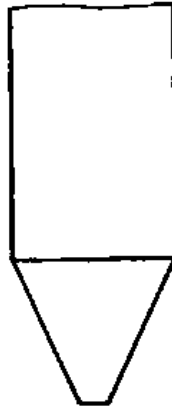

Figure 13. Keyway tool

All shaper tools can be constructed as solid or compound tools.

Compound tools are more frequent. Apart from a varying shape, the basic construction does not differ considerably.

In the case of solid tools, tool tip and tool body consist of one material. Tool steel, high-speed steel and super high-speed steel are used as materials.

Compound tools are characterized by having tool body and tip body made of

different materials. The connection between tool body and tool tip body can be firm (welded-on, soldered-on), but also loose (mechanically held).

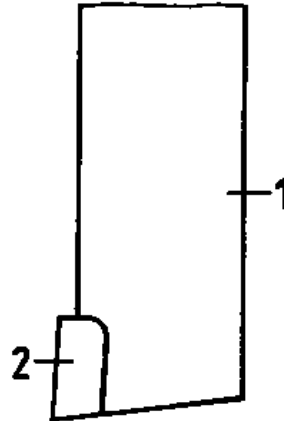

Figure 14. Compound tool (1 tool body, 2 tip body)

As far as forming tools are concerned, solid tools shall be given preference due to the longer tool life.

What forming tools do you know?

How is a compound tool composed?

Are forming tools used as solid or compound tools?





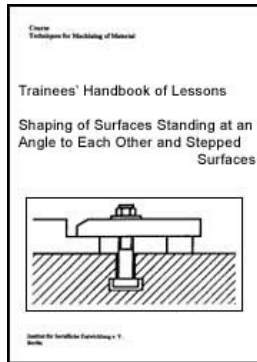

[Home](#) > [ar](#).[cn](#).[de](#).[en](#).[es](#).[fr](#).[id](#).[it](#).[ph](#).[po](#).[ru](#).[sw](#)



 **Shaping of Surfaces Standing at an Angle to each other and Stepped Surfaces - Course: Techniques for machining of material. Trainees' handbook of lessons (Institut fr Berufliche Entwicklung, 21 p.)**

 **(introduction...)**

-  **1. Purpose of shaping surfaces standing at an angle to each other and stepped surfaces**
-  **2. Kinds and construction of shaping tools to be used**
-  **3. Preparation for shaping of surfaces standing at an angle to each other and stepped surfaces**
-  **4. Shaping of surfaces standing at an angle to each other and stepped surfaces**

3. Preparation for shaping of surfaces standing at an angle to each other and stepped surfaces

Prophylactic health and fire protection and labour safety are an essential requirement for carrying out machining of material.

Therefore, the following requirements are to be met:

- **Keep your workplace always clean and in order. So, among other things, you will not lose any time in looking for things you need for work.**
- **Use only such working tools which are in an unobjectionable condition.**
- **According to the job use appropriate protection for your body (safety goggles in case of flying chips, protective gloves against sharp-edged workpieces).**
- **For cleaning, checking and clamping place the machine out of operation. Do not make safety devices ineffective.**
- **Use appropriate aids for chip removal (brush, broom etc.).**
- **In case of defects which affect the operational reliability of the machine do not start the machine and eliminate the defects.**
- **During shaping great lateral compressive forces (shaping) or support pressures (slotting) often occur. Make use of the work-holding equipment in such a way that the workpiece will not be permanently deformed.**

When is it necessary to wear safety goggles?

Prepare the sequence of operations in such a manner that all necessary working tools and objects of work can immediately be used without losing any time.

This includes above all:

- **Receive the work order and the workpieces to be machined. Check the workpieces for completeness and accuracy to size, i.e. check the premachining quality.**
- **Read the technical drawing (working drawing) and the work accompanying sheets.**
- **Lay out and check the necessary working means (tools, measuring and testing means, clamping and auxiliary equipment) according to the work order.**
- **Determine the cutting values.**
- **Fix the sequence of operations.**

Clamping the workpieces

When machining is made on shaping machines, work-holding equipment has the following functions:

- 1. Positioning - fixing of the workpiece position to the tool**
- 2. Clamping - counteraction to the cutting forces occurring during the machining process**

The clamping elements to be used must bring the workpiece into the necessary position to the tool and neutralize the cutting forces.

Therefore, each workpiece clamping must

- **be firm, safe and definite in position and**
- **ensure the clamping reliability without resulting in permanent deformations of the workpiece.**

For this reason greatest importance shall be attached to a job-related, firm workpiece clamping according to labour safety.

The choice of the respective clamping equipment depends on

- **the shape, size and number of workpieces to be machined,**
- **the cutting values to be applied,**
- **the workpiece position, its direction and quality.**

Proper use of the clamping means requires to know exactly what cutting forces occur.

The following main clamping means are used:

- **machine vices**

for chucking small workpieces with parallel bearing surfaces (most frequently used kind of clamping workpieces) Positioning of the machine vice is made by means of tongues.

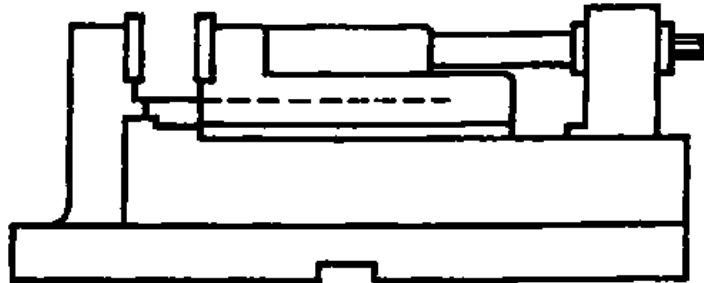

Figure 15. Machine vice

- clamps

for clamping large workpieces on the machine table or thin-walled workpieces which would bend in the machine vice

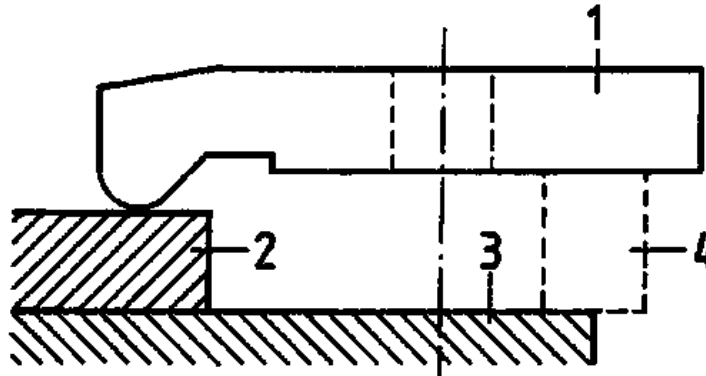

Figure 16. Clamp (1 clamp, 2 workpiece, 3 worktable, 4 base)

- clamping bolts

for mounting further clamping means or workpieces with bore holes

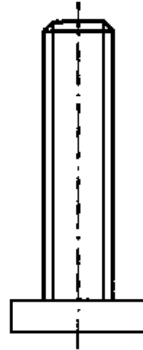

Figure 17. Clamping bolt

- clamping dies

for clamping workpieces which cannot be clamped by means of clamps by making use of the wedge effect

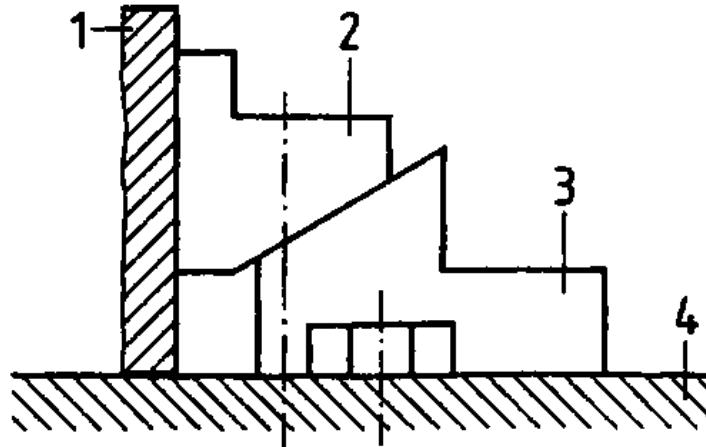

Figure 18. Clamping dies in use (1 workpiece, 2 fixed clamping die, 3 movable clamping die, 4 workpiece clamping area)

- angle-plates

as rotatable or tiltable clamping possibility with the help of T-slot bolts

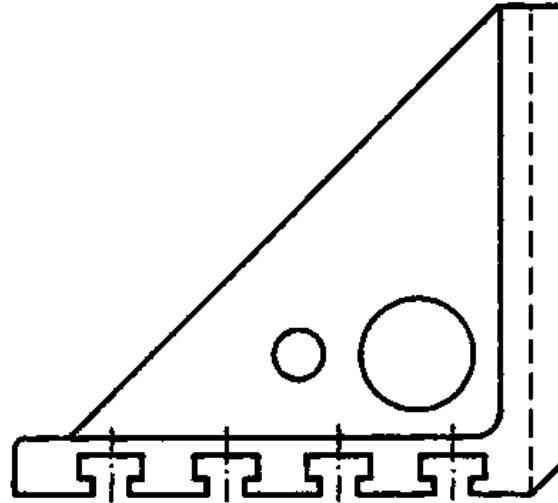

Figure 19. Angle-plate

**- electromagnetic chucks
for chucking workpieces which are machined with small cutting forces (finish
machining and fine finishing)**

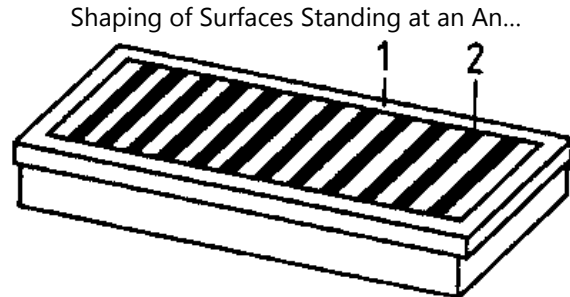

Figure 20. Electromagnetic chuck (1 plate, 2 pole strips)

**- clamping supports
for height adjustment when clamps are used**

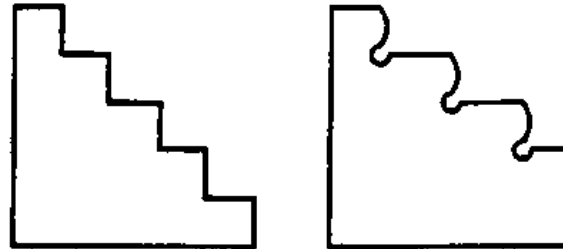

Figure 21. Clamping support

- fixtures

They are used for clamping workpieces which due to their geometrical shape cannot or only with considerable effort be clamped with usual clamping means such as vice, stops and clamps. This is the safest kind of clamping ensuring high quality. It is, however, dependent on the specific workpiece

and construction of the fixture.

- clamping the workpiece on the machine table under compression.
Here the workpiece is clamped from both sides by means of clamps.

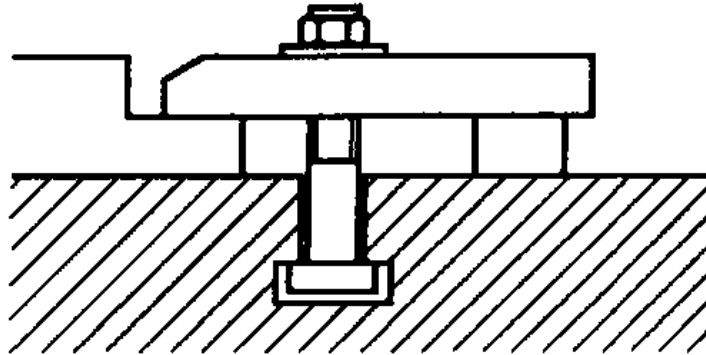

Figure 22. Clamping the workpiece on the machine table under compression

- clamping the workpiece on the machine table
Clamping is reached by lateral clamping forces.

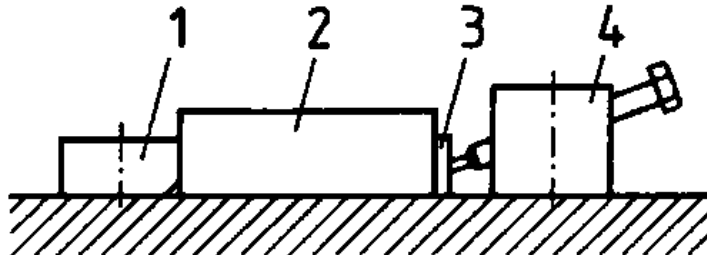

Figure 23. Clamping the workpiece on the machine table (1 stop, 2 workpiece, 3 work supporting block, 4 clamping piece with clamping nut)

On principle, when clamping workpieces, take care to ensure that

- an exact positioning of the workpieces to the primary motion is reached (adjust clamping means or workpieces)**
- parallel-ground bases are used**
- clamps are resting horizontally**
- those points on the workpiece which are sensitive to distortion are protected (bases, wedges etc.)**
- the clamping elements are located as close to the workpiece as possible and are arranged in such a manner that the cutting forces act against the fixed stops**
- impurities between locating and supporting surfaces are removed**
- the clamping forces act against fixed back rests (stops, supports).**

Clamping of tools

As tool clamping device the tool holder is used which in the case of shaping is also called tool post. The tool is fixed by means of clamping bolts. The tool holder is arranged to swivel around its axis. This makes machining of acute-angled surfaces possible.

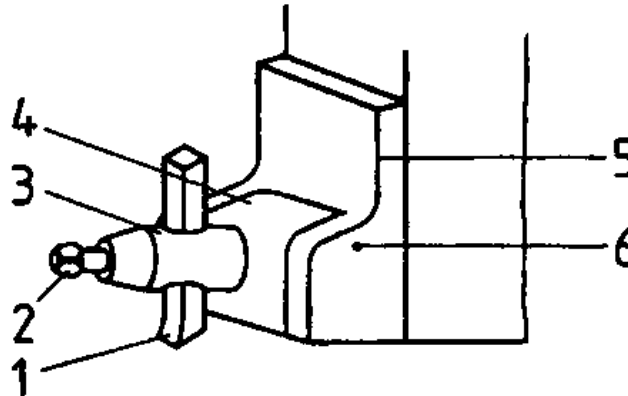

Figure 24. Tool holder (1 tool, 2 clamping bolt, 3 tool post, 4 clapper, 5 clapper box, 6 fulcrum pin)

When clamping the tools, make sure that

- the tool inserted is stable enough to neutralize the cutting forces occurring
- the tool is clamped as short as possible to prevent bouncing or twisting phenomena
- the clamping surfaces are free from burrs and impurities
- point-like clamping forces in hard tool material (super high-speed steel and high-speed steel) are distributed to larger surfaces by means of supports.

What is the fundamental function of work-holding equipment?

Mention three important clamping means for carrying out the technique of shaping.

What are the advantages and disadvantages of using fixtures?

Choice of cutting values

When determining the cutting values, pay attention to the following hints:

- **As a rule, the shaping and slotting tools consist of high-speed steel (HSS) or super high-speed steel (SHSS) or they are compound tools with carbide tipping. This is necessary because the impact load during starting of the cut does not allow the use of other superhard cutting materials.**
- **High-speed steel cutting materials are more break-proof than those made of hard metal, however, they do not allow high cutting speeds.**
- **Liquid coolants are relatively seldom used for shaping, as the tool is not constantly engaged. If, nevertheless, coolant is used, the tool life (mainly when high-speed steel is used or the cuts are long) and the surface finish of the workpiece are increased and improved.**
- **When steel is machined with carbide-tipped shaper tools, the necessary**

high cutting speeds are often not reached for reasons resulting from the machine. Thus, built-up cutting edges and a considerably higher load of the tool cutting edge occur. Lower cutting speeds with the use of high-speed steel prove to be more favourable in this case.

- The grind of the tool is of decisive influence on the quality of machining and the life of the tool. The angle of inclination of the cutting edge, which due to the favourable chip disposal is chosen to be mostly negative, is of special influence.

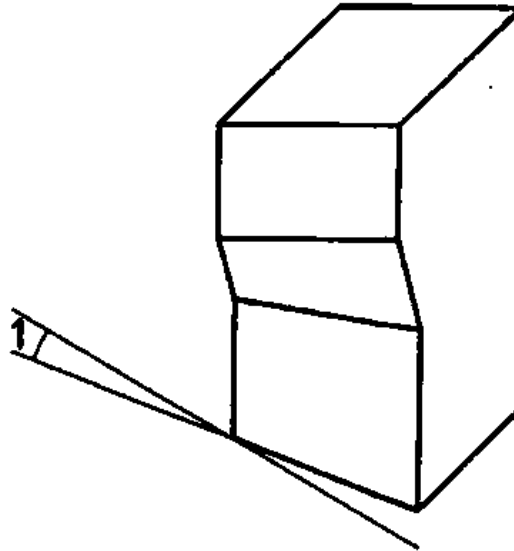

Figure 25. Shaper tool (1 angle of inclination at shaper tool)

In the following machining recommendations for v (cutting speed) are given:

HSS - high-speed steel 20 - 26 m/min.

SHSS - super high-speed steel 26 - 35 m/min.

HS - hard metal 36 - 40 m/min.

For determining the mean cutting speed (v_m) $\frac{v}{2}$ is recommended for simplicity.

The stroke length is calculated according to $L = l + l_a + l_o$ (mm).

The number of double stroke is determined according to $n = \frac{v_m \cdot 1000}{2 \cdot L}$ (permm.).

When the technique of shaping end faces is used, v_m is to be halved once more due to the unfavourable cutting conditions.

What mean cutting speed (v_m) is chosen for shaping an end face with a tool made of high-speed steel?

A workpiece made of St 38 with a length of 80 mm shall be machined by face-shaping. Determine the number of double strokes.

When determining the return stroke, choose the return speed to be as high as possible (time-saving). If the return speed is fixed by the construction, no choice is possible.

Take into consideration the accelerating and braking forces of the table or ram in case of small strokes.

Choice and application of measuring and testing means as well as coolants and lubricants

The following measuring and testing means are applied:

- flexible steel rule
- vernier caliper
- external micrometer
- dial gauge
- slip gauges
- spirit level
- protractor.

The use of necessary coolants and lubricants as well as other auxiliary equipment and utilities (brushes, compressed air etc.) shall also be taken into account.

As coolant and lubricant the following are suited:

- drilling emulsion (emulsion of water and oil)**
- cutting oil (for specially high surface quality)**

In most cases the use of coolants and lubricants is not necessary, as the interrupted cut with sufficient chip removal prevents generation of much heat.





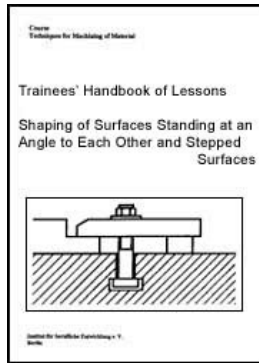

[Home](#) > [ar](#).[cn](#).[de](#).[en](#).[es](#).[fr](#).[id](#).[it](#).[ph](#).[po](#).[ru](#).[sw](#)



 **Shaping of Surfaces Standing at an Angle to each other and Stepped Surfaces - Course: Techniques for machining of material. Trainees' handbook of lessons (Institut fr Berufliche Entwicklung, 21 p.)**

 **(introduction...)**

-  **1. Purpose of shaping surfaces standing at an angle to each other and stepped surfaces**
-  **2. Kinds and construction of shaping tools to be used**
-  **3. Preparation for shaping of surfaces standing at an angle to each other and stepped surfaces**
-  **4. Shaping of surfaces standing at an angle to each other and stepped surfaces**



4. Shaping of surfaces standing at an angle to each other and stepped surfaces

For machining of surfaces standing at an angle to each other the same manufacturing techniques as for shaping of plane surfaces and end faces, inclined and parallel surfaces can be applied. The workpieces shall be clamped in such a manner that the surfaces to be machined are accessible from the operating side of

the machine, if possible. As a rule, the surfaces inclined to each other are shaped separately. If surfaces meeting under an acute angle are approximately 15 to 20 mm wide, the angle section can be cut out also from the solid material. The surfaces are at first roughed, then finished.

The choice of corresponding shaper tools depends on the angle under which the surfaces to be machined meet. Surfaces standing at an angle to each other should be machined in one clamping if possible, in order to avoid steps that may arise due to changes of the position during relocating.

The tool shall be adjusted according to the angle required. Surfaces standing at an angle to each other are roughed at first in the direction of the inclined surface from the top downwards, then horizontally from the outside inwards.

Finishing is made, as a rule, with pointed side-cutting planer tools which according to the angle of inclination of the surfaces to be machined are ground on both sides.

The angle and its position shall be checked after roughing so that a correction is possible during finishing. The angle shall be checked at both ends and in the middle of the workpiece. When workpieces sensitive to distortion are machined, they should be unloaded (released and tightened again) before finishing to avoid distortions.

Shaping of stepped surfaces can also be understood as shaping of profiles or shaping with formed tool. This concerns workpieces which are composed of various surfaces and shapes. Being horizontal, vertical, parallel, inclined and angular surfaces, they form different geometrical shapes.



Figure 26. Contour

Such surfaces are often shaped, as they can be manufactured with relatively simple tools at lower costs than with milling tools.

Simple stepped surfaces (see Fig. 3) can be produced, as a rule, with the usual shaping tools.

A distinction should be made between shaping of plane surfaces and end faces.

In doing so, the position of the tool depends on the required surface contour of the workpiece. At any rate it must be possible for the tool to cut freely and to be returned.

The exact position of the workpiece in the case of shaping plane surfaces (horizontal surface) is reached by:

- **putting and clamping that side on the machine table which has been machined first (make sure that the bearing surfaces are clean and even);**
- **underlaying of strips ground parallel in the machine vice.**

The exact position of the workpiece in the case of shaping end faces (vertical

surfaces) is reached by:

- **putting and clamping the side machined first against stops and tongues;**
- **alignment of a vertical reference surface already machined by checking with the dial gauge in longitudinal direction.**

In doing so, make sure that the dial gauge tip follows the ram path (use a special holder, if necessary).

- **alignment of the machine vice in longitudinal or transverse direction**

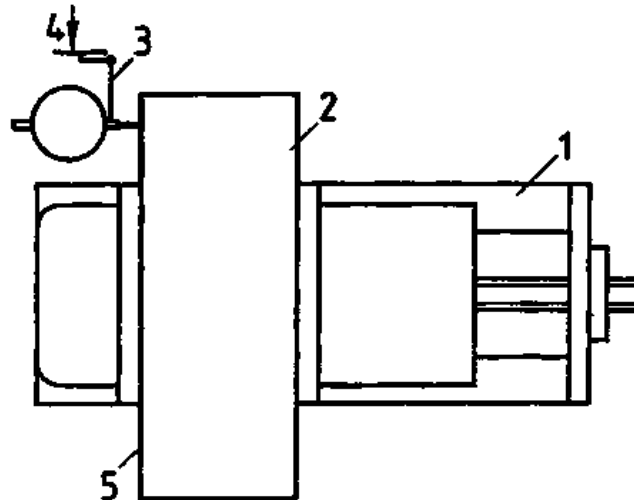

Figure 27. Checking of the workpiece position at a reference surface (1 vice, 2

workpiece, 3 tool slide with clamped dial gauge, 4 direction of movement, 5 reference surface)

Simple stepped surfaces should always be finish-shaped from the maximum size to the minimum size.

Shaping of stepped surfaces possessing a physical shape or profile is characterized by having the shape or the profile of the required workpiece surface machined in the tool (forming tool) or by adjusting the tool at an angle to the workpiece. Stepped shapes or profiles are made mostly in the last working step. The surfaces and edges already machined serve as reference surfaces.

At which points of the workpiece are angles to be checked?

How is an exact position of the workpiece reached when vertical surfaces are slotted?

What are the main working steps of machining by shaping?

1.

2.

3.

4.

5.

6.

7.

