

➔ **Manual Thread Cutting - Course: Technique for manual working of materials. Trainees' handbook of lessons (Institut fr Berufliche Entwicklung, 22 p.)**

**(introduction...)**

1. Purpose of thread cutting
2. Kinds of threads
3. Tools for internal threading (tapping)
4. Tools for external threading
5. Operation of thread cutting
6. Special hints on the designation of threads by the example of the metric threads
7. Technological process of cutting internal threads (tapping)
8. Technological process of cutting external threads

[Home](#) > [ar](#).[cn](#).[de](#).[en](#).[es](#).[fr](#).[id](#).[it](#).[ph](#).[po](#).[ru](#).[sw](#)

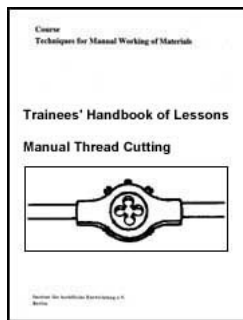

➔ **Manual Thread Cutting - Course: Technique for manual working of materials. Trainees' handbook of lessons (Institut fr Berufliche Entwicklung, 22 p.)**

➔ **(introduction...)**

1. Purpose of thread cutting
2. Kinds of threads
3. Tools for internal threading (tapping)
4. Tools for external threading
5. Operation of thread cutting
6. Special hints on the designation of threads by the example of the metric threads
7. Technological process of cutting internal threads (tapping)
8. Technological process of cutting external threads

**Institut fr berufliche Entwicklung e.V.  
Berlin**

**Original title:  
Arbeitsmaterial fr den Lernenden  
"Gewindeschneiden von Hand"**

**Author: Frank Wenghfer**

**First edition © IBE**

**Institut fr berufliche Entwicklung e.V.**

**Parkstrae 23  
13187 Berlin**

**Order No.: 90-35-3109/2**





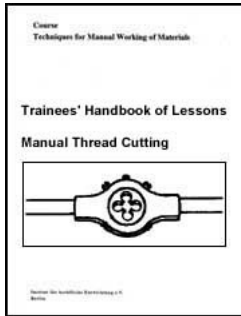





[Home](#) > [ar.cn.de.en.es.fr.id.it.ph.po.ru.sw](#)



 **Manual Thread Cutting - Course: Technique for manual working of materials. Trainees' handbook of lessons (Institut fr Berufliche Entwicklung, 22 p.)**

 **(introduction...)**

-   **1. Purpose of thread cutting**
-  **2. Kinds of threads**
-  **3. Tools for internal threading (tapping)**
-  **4. Tools for external threading**
-  **5. Operation of thread cutting**
-  **6. Special hints on the designation of threads by the example of the metric threads**
-  **7. Technological process of cutting internal threads (tapping)**
-  **8. Technological process of cutting external threads**

## 1. Purpose of thread cutting

**Thread cutting is cutting of helical turns of threads out of the tapping-size hole or bolt in order to create screwed connections.**

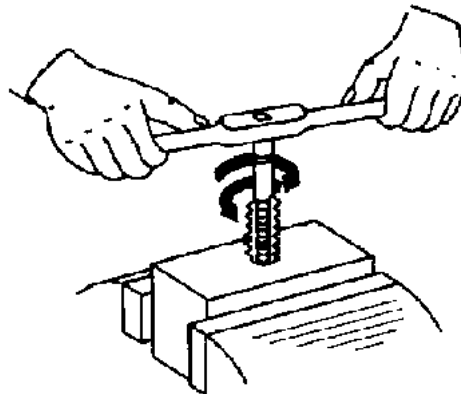
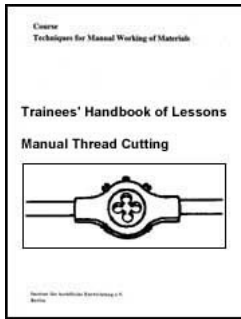

**Figure 1 - Thread cutting**

**A complete screwed connection requires an internal thread and a matching external thread as a counterpart. With single-piece manufacture or with repair work, manual thread cutting is a necessary working technique, because - due to technical and economical reasons - machines cannot be used in every case.**



[Home](#) > [ar.cn.de.en.es.fr.id.it.ph.po.ru.sw](#)



**Manual Thread Cutting - Course: Technique for manual working of materials. Trainees' handbook of lessons (Institut fr Berufliche Entwicklung, 22 p.)**

**(introduction...)**

1. Purpose of thread cutting
- ➔ 2. Kinds of threads
3. Tools for internal threading (tapping)
4. Tools for external threading
5. Operation of thread cutting
6. Special hints on the designation of threads by the example of the metric threads
7. Technological process of cutting internal threads (tapping)
8. Technological process of cutting external threads

## 2. Kinds of threads

Fastening screw threads: metric threads (V-shaped threads)  
Whitworth threads (V-shaped threads)

Power-transmission screw threads: knuckle threads, acme threads, saw-tooth threads

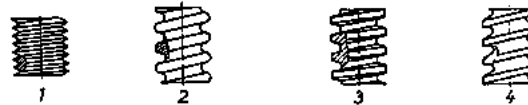

**Figure 2 - Kinds of threads**

- 1 - Vee thread
- 2 - Knuckle thread
- 3 - Acme thread
- 4 - Saw-tooth thread

Sealing threads: tapered threads (metric and Whitworth)

Pipe threads: Whitworth pipe threads

**By manual thread cutting, only fastening screw threads and partially pipe threads are made. These kinds of threads are made as left-hand or right-hand threads as well as coarse screw threads and fine screw threads..**

[Home](#) > [ar.cn.de.en.es.fr.id.it.ph.po.ru.sw](#)

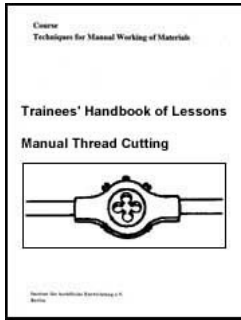

## Manual Thread Cutting - Course: Technique for manual working of materials. Trainees' handbook of lessons (Institut für Berufliche Entwicklung, 22 p.)

(introduction...)

1. Purpose of thread cutting
2. Kinds of threads
- ➔ 3. Tools for internal threading (tapping)
4. Tools for external threading
5. Operation of thread cutting
6. Special hints on the designation of threads by the example of the metric threads
7. Technological process of cutting internal threads (tapping)
8. Technological process of cutting external threads

### 3. Tools for internal threading (tapping)

Internal threads are cut by serial taps or by nut taps.

Serial taps:

They consist of two or three tools the distinguishing feature being the design of the cutting part.

The entering tap (1st pass) has a long chamfer and trapeziform cutting edges; it does approximately 60 % of the cutting work.

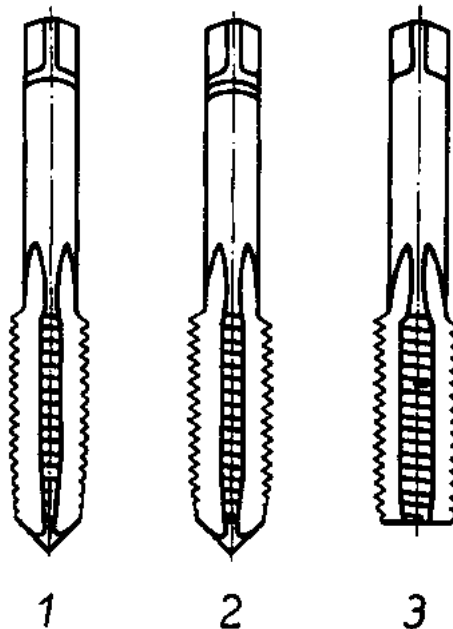

Figure 3 - Serial taps

- 1 - Entering tap**
- 2 - Plug tap**
- 3 - Third tap**

The plug tap (2nd pass) has a short chamfer and trapeziform cutting edges which are deeper; it does approximately 30 % of the cutting work.

The (finishing) third tap (3rd pass) has a short chamfer and cutting edges which create the final sharp form of the thread groove; it cuts the thread to nominal size and finishes the thread flanks.

The individual tools are additionally distinguished by marks in the form of engraved rings at the shank below the square. Modern versions of serial taps consist of entering tap and finishing tap only.

#### **Nut taps:**

The nut tap (also called single-pass hand tap) in its cutting part unites the cutting parts of the three serial taps. Consequently, it has a long chamfer representing about 70 % of the total length of the cutting part; the cutting edges are initially trapeziform and become sharp only towards the end. The cutting part is not essentially longer than that of the serial tap.

Yet this cutting part has to do all the cutting operation. The shank with the square is relatively long.



**Figure 4 - Nut tap**

### **3.1. Application of the tools**

- Serial taps divide the cutting operation into several passes and thus enable easy but time-consuming threading; the third tap - due to its short chamfer - is able to almost completely cut out blind holes.

**Conclusion:**

Serial taps are mainly used for tapping blind holes.

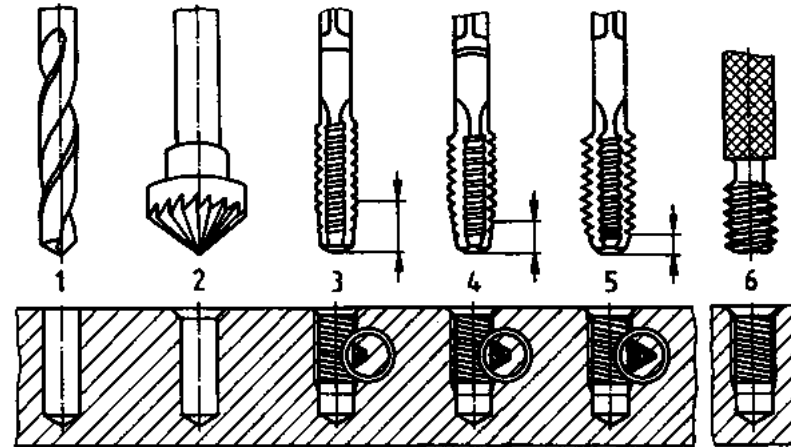

Figure 5 - Technology of internal thread cutting (tapping)

- 1 - Drilling
- 2 - Countersinking
- 3 - Rough-cutting by entering tap
- 4 - Finish-cutting by plug tap
- 5 - Finish-cutting by third tap
- 6 - Checking

- Nut taps enable quick threading which, however, involves a great cutting power (tearing of the thread may occur). Due to its long chamfer, this tool cannot be used for blind holes.

**Conclusion:**

Nut taps are used for tapping short through holes.

What are the distinguishing features for the use of serial taps and nut taps?

[Home](#) > [ar](#) [cn](#) [de](#) [en](#) [es](#) [fr](#) [id](#) [it](#) [ph](#) [po](#) [ru](#) [sw](#)

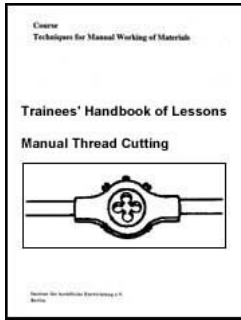

(Institut für Berufliche Entwicklung, 22 p.)

**(introduction...)**

1. Purpose of thread cutting
2. Kinds of threads
3. Tools for internal threading (tapping)
- ➔ 4. Tools for external threading
5. Operation of thread cutting
6. Special hints on the designation of threads by the example of the metric threads
7. Technological process of cutting internal threads (tapping)
8. Technological process of cutting external threads

#### 4. Tools for external threading

External threads are made with the help of a threading die or die-stock.

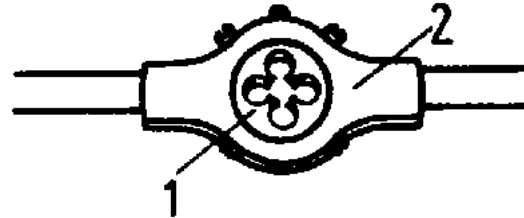

Figure 6 - Threading die

1 - Threading die

2 - Die holder

#### Threading die:

It consists of a cutting body (similar to a nut with milled-in chip grooves) with a chamfer on either side so that it can be applied both-way.

The threading die is put into a die holder which is equipped with two handles.

Figure 7 - Die-stock

- 1 - Fixed die**
- 2 - Movable die**
- 3 - Pressure piece**
- 4 - Locking screw**

#### **Die-stock:**

**It consists of a handle-equipped holder in which two threading dies are placed. One of them is fixed, the other one can be moved by means of a pressure piece via a locking screw. Three to five pairs of exchangeable threading dies for various sizes of threads belong to a die-stock.**

#### **4.1. Application of the tools**

- Threading dies cut the thread in one operation; they are used with bolt diameters up to 12 mm. Bolt diameters between 12 mm and 30 mm can be cut by threading die or die-stock as well.**
- Die-stocks are mainly used with bolt diameters over 30 mm; they are drawn over the bolt in several operations. Readjustment before every new operation is necessary. In the course of the last operation, the thread is accurately cut to size by a threading die,**

#### **Hints for starting the cutting operation**

- The threading die is set in exactly horizontal position on the bevel of the bolt and turned clockwise slowly and with slight pressure from above (with right-hand thread). Only when the starting end of the thread is cut and the threading die guides itself, the breaking of chips can begin.**
- The die-stock is opened as much as is necessary to shove it over the bolt - a small piece of the bolt must project above. The die-stock is adjusted to horizontal position and the movable threading die is tightened. Then, the die-stock is turned up to the bevel so that it is still guided. The movable threading die is further tightened. Then, the thread can be cut by turning the die-stock up and down adjusting the threading die simultaneously.**



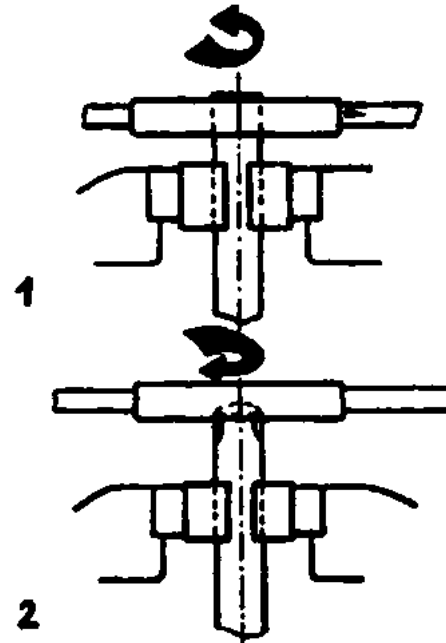

Figure 8 - Application of the die-stock

- 1 - Putting-on and turning-up
- 2 - Turning-down

What are the distinguishing features in the use of threading dies and die-stocks?



[Home](#) > [ar](#) [cn](#) [de](#) [en](#) [es](#) [fr](#) [id](#) [it](#) [ph](#) [po](#) [ru](#) [sw](#)

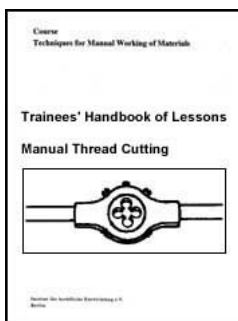

**Manual Thread Cutting - Course: Technique for manual working of materials. Trainees' handbook of lessons (Institut für Berufliche Entwicklung, 22 p.)**

*(introduction...)*

1. Purpose of thread cutting
2. Kinds of threads
3. Tools for internal threading (tapping)
4. Tools for external threading
5. Operation of thread cutting
6. Special hints on the designation of threads by the example of the metric threads
7. Technological process of cutting internal threads (tapping)

## 8. Technological process of cutting external threads

### 5. Operation of thread cutting

Thread taps take off material from the periphery of the bore hole. This is done by permanently turning them forwards and backwards alternately with the help of a tap wrench.

In doing so, lubricating and cooling agents must be fed in.

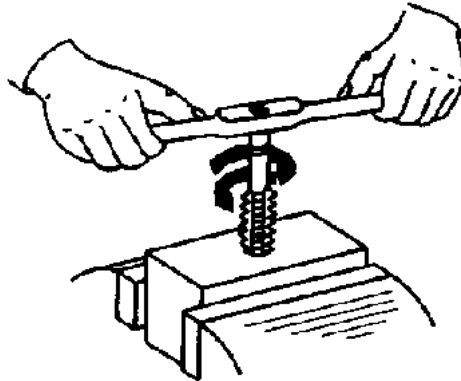

Figure 9 - Thread cutting

The forward turn should amount to half a rotation approximately, the backward turn to a quarter-turn. The material is squeezed and removed within the thread groove the total quantity of chips sticking in the thread grooves.

The backward rotation causes the crushing of the chips, so that they can fall out of the chip grooves of the thread tap.

#### Note:

The backward turn up to the crushing of the chips, with medium hard and hard materials, is marked by a clearly noticeable jerk. Only then one can be sure that the chip is really broken.

If one fails to crush the chips continuously, the thread grooves and chip grooves become stuffed up. The thread tap becomes jammed and breaks. It can no more be screwed out of the bore hole. The same applies to the cutting of external threads.

Describe the movements with the cutting of threads.

---

Why is it necessary to move the thread tap or threading die or die-stock, respectively, backwards at regular intervals?

---

Why must lubricating and cooling agents be used?

---

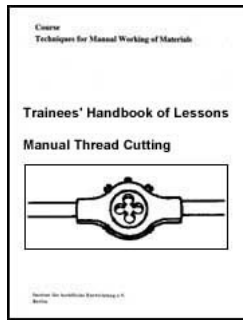

**Manual Thread Cutting - Course: Technique for manual working of materials. Trainees' handbook of lessons (Institut für Berufliche Entwicklung, 22 p.)**

**(introduction...)**

1. Purpose of thread cutting
2. Kinds of threads
3. Tools for internal threading (tapping)
4. Tools for external threading
5. Operation of thread cutting
- ➔ 6. Special hints on the designation of threads by the example of the metric threads
7. Technological process of cutting internal threads (tapping)
8. Technological process of cutting external threads

**6. Special hints on the designation of threads by the example of the metric threads**

Fastening screw threads are internationally standardized in a different way. A large group of these kinds of threads is the group of the metric ISO threads marked by a uniform designation.

Metric ISO threads

**Example of the designation of a coarse screw thread:**

M 8

**M = metric thread**

**8 = nominal diameter 8 mm**

**Example of the designation of a fine screw thread:**

M 10 x 1.25

**(The fine screw thread is additionally marked by the indication of the thread pitch)**

**M = metric thread**

**10 = nominal diameter 10 mm**

**1.25 = thread pitch 1.25 mm**

The designation is to be found on the shank of the thread tap or on the surface of the threading die or the die-stock dies, respectively. In addition, symbols for left-hand threads may appear after the designation.

**Note:**

**The designation of the threads is identical on cutting tools and testing tools - with a certain cutting tool the matching testing tool must be used.**

**What is the designation of a thread limit plug gauge by which a bore shall be checked cut by a M 8 nut tap?**

---

**What is the meaning of the designation M 6 x 0.5?**

---



[Home](#) > [ar](#) [cn](#) [de](#) [en](#) [es](#) [fr](#) [id](#) [it](#) [ph](#) [po](#) [ru](#) [sw](#)

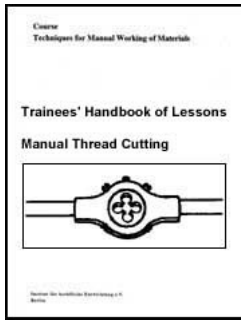

**Manual Thread Cutting - Course: Technique for manual working of materials. Trainees' handbook of lessons (Institut fr Berufliche Entwicklung, 22 p.)**

**(introduction...)**

- 1. Purpose of thread cutting**
- 2. Kinds of threads**
- 3. Tools for internal threading (tapping)**
- 4. Tools for external threading**
- 5. Operation of thread cutting**
- 6. Special hints on the designation of threads by the example of the metric threads**
- ➔ 7. Technological process of cutting internal threads (tapping)**
- 8. Technological process of cutting external threads**

## **7. Technological process of cutting internal threads (tapping)**

**On principle, the following steps are necessary for cutting threads into blind holes as well as through holes:**

### **7.1. Holding/clamping**

**Workpieces that shall be bolted to one another have to be clamped together and to be drilled and counterbored jointly, so that the alignment of the bore is maintained.**

### **7.2. Scribing/prick-punching**

**These operations are carried out as described under "drilling and counterboring/countersinking"; it may also be done before clamping.**

### **7.3. Drilling**

**Since the thread tap takes material out of the bore hole, this bore hole must be made smaller to a certain degree depending on the nominal diameter of the thread. This bore hole diameter is called "minor diameter" and is calculated with the help of the following**

**formula:**

$$D = N - S$$

**D** = minor diameter of the internal thread  $\hat{=}$  diameter of the drill

**N** = nominal diameter

**S** = thread pitch

Thus, the bore hole must be made smaller than the nominal diameter of the thread by the value of the thread pitch. With coarse screw threads, the "thread pitch" depends on the nominal diameter; with fine screw threads, different thread pitches are possible with the same nominal diameter; therefore, the indication of the thread pitch must be included in the designation of these threads.

The thread pitch is the value (in mm) of the longitudinal movement of a thread tap resulting from one complete revolution of the thread tap.

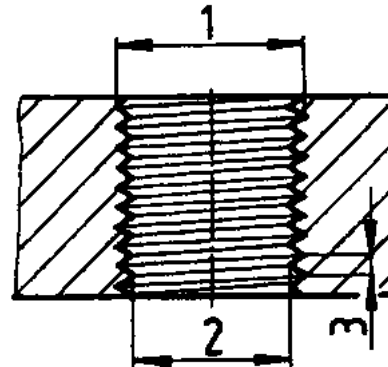

Figure 10 - Dimensions at the internal thread

1 - Nominal diameter (N)

2 - Minor diameter (D)

3 - Pitch (S)

For making the bore holes, the calculation of the rotational speed of the drill ( $n$ ) is to be taken from the lesson "drilling and counts boring/countersinking".

**Selected metric coarse and fine screw threads:**

Coarse screw threads		Fine screw threads	
Nominal diameter (N)	Thread pitch (S)	Nominal diameter x Thread pitch	
2.5	0.45	2.5 x 0.35	24 X 2
3	0.5	4 x 0.5	42 X 1
4	0.8	6 x 0.75	42 X 1.5

6	1	10 x 0.5	42 X 3
8	1.25	10 x 0.75	42 X 4
10	1.5	10 x 1	
12	1.75	10 x 1.25	
16	2	16 x 0.75	
20	2.5	16 x 1	
24	3	16 x 1.5	
30	3.5	24 x 0.75	
36	4	24 x 1	
42	4.5	24 x 1.5	

**Generally applicable formula:**

$$n = \frac{V \cdot 1000}{D \cdot \pi}$$

**V = cutting speed (22 m/min)**

**$\pi = 3.14$**

**With blind holes, the chamfer of the thread tap (third tap) is to be taken into consideration as follows:**

**The blind hole must be made deeper than required by the depth of the thread by the size of the chamfer (runout depth).**

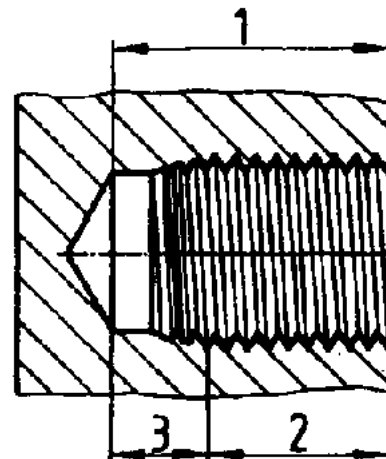

**Figure 11 - Indication of the depths at the internal thread**

**1 - Depth of hole (T<sub>B</sub>)**

**2 - Depth of thread (T<sub>G</sub>)**

### 3 - Runout depth ( $T_A$ )

This is expressed by the following formula:

$$T_B = T_G + T_A$$

$T_B$  = depth of hole

$T_G$  = depth of thread

$T_A$  = runout depth

The following formula is considered as a "rule of thumb" for the calculation of the runout depth of small threads:

$$T_A = 0.7 \times D$$

The exact value of the runout depth for metric coarse and fine screw threads can be taken from the following table:

N		$T_A$
M	3	2.8
M	4	3.4
M	5	3.6
M	6	4.5
M	8	5
M	10	5.5
M	12	6
M	16	6.5
M	20	7.5
M	24	8.5
M	30	10
M	36	11
M	42	12
M	48	13

#### Example:

A bore hole shall be made for a metric coarse screw thread with a nominal diameter of 6 mm; the depth of the thread shall be 12 mm.

How must the bore hole be made?

**1. Diameter of the drill:**

$$D = N - S$$

$$D = 6 \text{ mm} - 1 \text{ mm}$$

$$\underline{D = 5 \text{ mm}}$$

**2. Depth of hole:**

$$T_B = T_G + T_A$$

$$T_B = 12 \text{ mm} + 4.5 \text{ mm}$$

$$\underline{T_B = 16.5 \text{ mm}}$$

The bore hole of 16.5 mm in depth is made by the drill  $D = 5 \text{ mm}$ .

**7.4. Countersinking**

Through holes have to be countersunk from either side by a  $60^\circ$  countersinking cutter (also  $90^\circ$  countersinking cutter).

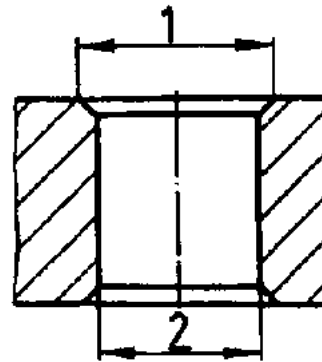

Figure 12 - Countersinking of internal threads

1 - Countersinking diameter ( $D_s$ )

2 - Minor diameter

In doing so, the countersinking diameter ( $D_s$ ) shall be equivalent to the nominal diameter of the thread:

$$D_s = N$$

The rotational speed for countersinking of bore holes up to a diameter of 10 mm can be 350 r.p.m., for larger bore holes it must be lower.

$$n \approx 350 \text{ r.p.m.}$$

**7.5. Thread cutting**



**With short through holes nut taps have to be used; with blind holes only serial taps must be applied. Auxiliary means are tap wrenches. Lubricating and cooling agents are to be seen in the below table:**

Steel	Cutting oil
Aluminium alloys:	Spirit
Chromium-nickel alloys:	Colza oil, petroleum

**Note:**

**If several parts shall be connected by screw connection, and if these parts were provided with a bore hole in one clamping, this clamping has to be released before the thread is cut. Only in the last part - starting from the screw head - the thread is allowed to be cut. All parts situated in between are bored; that is to say, they get a through hole which must be larger than the nominal diameter of the thread.**

**7.6. Cleaning of the bore hole**

**After the thread is cut, chips and remaining oil must be removed from the bore hole by means of compressed air or brush.**

**7.7. Checking**

**Thread depths and minor diameters of internal threads are checked by vernier caliper, the accuracy of fit of the thread is checked by the thread limit plug gauge according to the nominal diameter.**

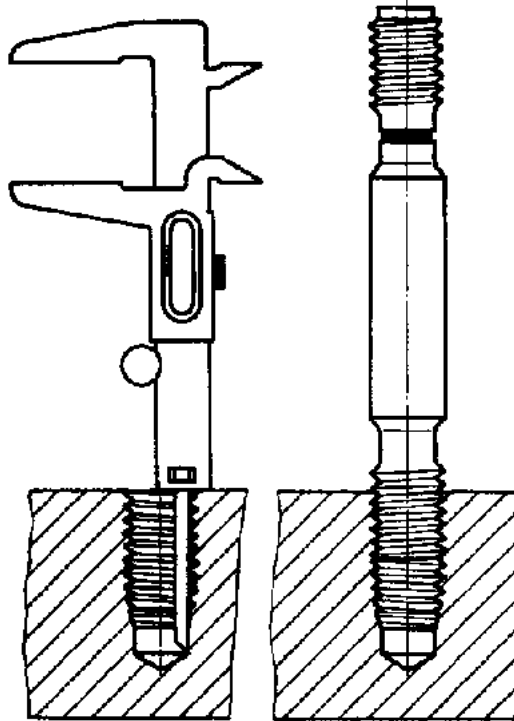

Figure 13 - Checking of the thread

How is the minor diameter of a tapped hole calculated?

---

How must the chamfer of the thread tap be taken into consideration in calculating the depth of the bore?

---

How are tapping-size holes to be countersunk?

---

**Task:**

The following tool and machine values have to be determined for making an M 10 internal thread of 15 mm in depth into a steel part of general mild steel:

Diameter of the drill (D): \_\_\_\_\_

Rotational speed (n) : \_\_\_\_\_

Depth of hole ( $T_B$ ): \_\_\_\_\_

Countersinking diameter (Ds): \_\_\_\_\_

Rotational speed (n) : \_\_\_\_\_

**The individual steps of operation together with the calculated values for the bore hole have to be entered in the following table, blank spaces have to be completed:**

No.	Operation	Cutting tools, testing tools and auxiliary means	Tool and machine values
1.	Clamping		-
2.	Scribing/prick-punching		
3.	Drilling	Drill	D =
		Vernier caliper	T <sub>B</sub> =
		Lubricating and cooling agents	n =
4.	Countersinking	Countersinking cutter	D <sub>s</sub> =
		Vernier caliper	n =
5.	Thread cutting		
6.	Cleaning		-
7.	Checking	Thread limit plug gauge	

**This table may be used as a preparation for practical exercises in thread cutting.**



[Home](#) > [ar.cn.de.en.es.fr.id.it.ph.po.ru.sw](#)

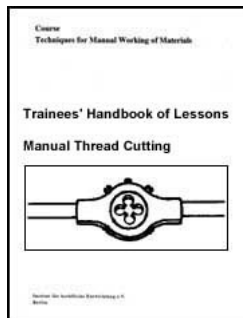

**Manual Thread Cutting - Course: Technique for manual working of materials. Trainees' handbook of lessons (Institut fr Berufliche Entwicklung, 22 p.)**

**(introduction...)**

**1. Purpose of thread cutting**

**2. Kinds of threads**

**3. Tools for internal threading (tapping)**

**4. Tools for external threading**

**5. Operation of thread cutting**

**6. Special hints on the designation of threads by the example of the metric threads**

**7. Technological process of cutting internal threads (tapping)**

**8. Technological process of cutting external threads**

## **8. Technological process of cutting external threads**

**On principle, the following operations are necessary for the manual cutting of external threads:**

### **8.1. Clamping**

**The bolt (round stock) is vertically clamped into the vice between - jaws, attachments or clamping jaws for round stock; with this, only the part of the material which is to be worked shall project over the clamping device in order to reduce the springing of the bolt.**

### **8.2. Chamfering**

**In order to be able to put the tool in an angular position on the bolt, a chamfer must be made at the head of the bolt. This can be done with the help of a file or by a grinding machine.**

**The chamfer shall have an inclination of approximately 45° and a width of at least 0.5 mm.**

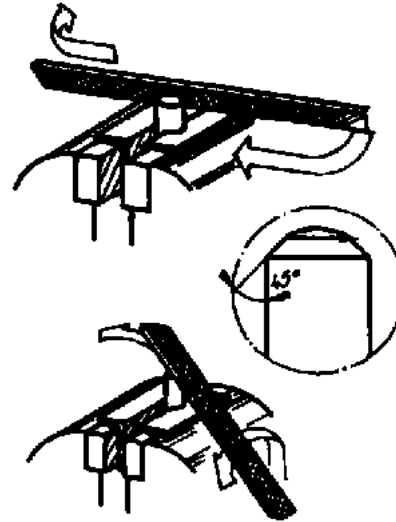

**Figure 14 - Chamfering of the bolt**

### **8.3. Thread cutting**

**According to the nominal diameter of the thread, a threading die or die-stock is used.**

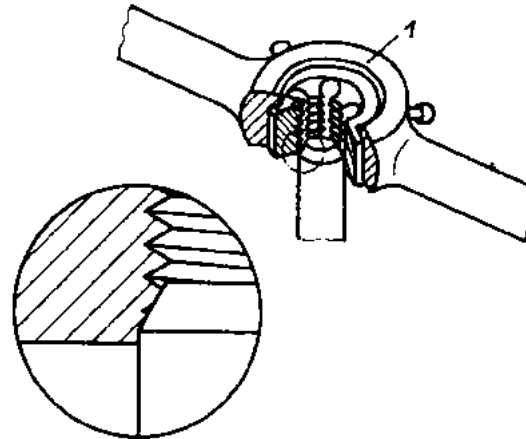

**Figure 15 - Application of the threading die**

**1 - Top surface of the die holder**

**Note:**

- The threading die is applied that way that the top of the die holder points upwards.

(If worn out, the threading die can be turned in the die holder).

- By the die-stock, the external thread (bolt thread) is cut from bottom to top, otherwise an accurate bevel cannot be achieved.

Lubricating and cooling agents are chosen according to the kind of material.

**8.4. Cleaning**

After thread cutting, the chips and rests of oil are removed from the thread flanks by compressed air or brush.

**8.5. Checking**

The length of the thread is checked by vernier caliper, the accuracy of fit of the thread by the thread ring gauge according to the nominal diameter. The surface of the thread flanks can be assessed by the eye.

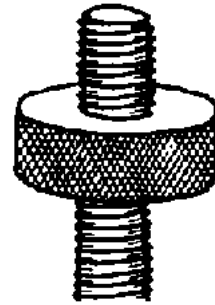

**Figure 16 - Checking of the thread**

**How must bolts be clamped in the vice?**

---

**Why must the bolt be provided with a chamfer?**

---

### **Faults**

**Irrespective of nonobservation of the sequence of operations, faults in the cutting process may occur which are visible with the naked eye:**

<b>Fault</b>	<b>Reason</b>
Thread is not straight	<ul style="list-style-type: none"> <li>- Tool was not put on vertically</li> <li>- Tool was turned unevenly (jerkily)</li> <li>- With external thread - cut without starting bevel</li> </ul>
Thread turns are rough and partially torn	<ul style="list-style-type: none"> <li>- Tool was turned unevenly and too quickly</li> <li>- No lubricating and cooling agent was used</li> <li>- Minor diameter and/or diameter of the bolt were not calculated accurately</li> </ul>

