

➔ **Grinding of Simple Tools - Course: Technique for manual working of materials. Trainees' handbook of lessons (Institut fr Berufliche Entwicklung, 19 p.)**

📄 *(introduction...)*

- 📄 **1. Purpose of grinding**
- 📄 **2. Machines for grinding**
- 📄 **3. Tools for grinding**
- 📄 **4. Operation of grinding**
- 📄 **5. Operation of whetting**
- 📄 **6. Examples for off-hand sharpening with straight wheels**
- 📄 **7. Hints for mounting and dressing of grinding wheels**
- 📄 **8. Labour safety recommendations**





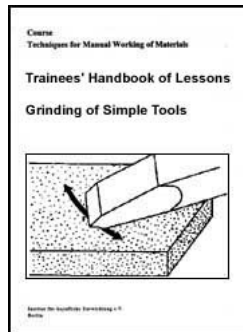

[Home](#) > [ar.cn.de.en.es.fr.id.it.ph.po.ru.sw](#)



➔ **Grinding of Simple Tools - Course: Technique for manual working of materials. Trainees' handbook of lessons (Institut fr Berufliche Entwicklung, 19 p.)**

➔ 📄 *(introduction...)*

- 📄 **1. Purpose of grinding**
- 📄 **2. Machines for grinding**
- 📄 **3. Tools for grinding**
- 📄 **4. Operation of grinding**

-  **5. Operation of whetting**
-  **6. Examples for off-hand sharpening with straight wheels**
-  **7. Hints for mounting and dressing of grinding wheels**
-  **8. Labour safety recommendations**

**Institut fr berufliche Entwicklung e.V.  
Berlin**

**Original title:  
Arbeitsmaterial fr den Lernenden  
"Schrifen einfacher Werkzeuge"**

**Author: Frank Wenghfer**

**First edition © IBE**

**Institut fr berufliche Entwicklung e.V.  
Parkstrae 23  
13187 Berlin**

**Order No.: 90-35-3112/2**



[Home](#) > [ar](#).[cn](#).[de](#).[en](#).[es](#).[fr](#).[id](#).[it](#).[ph](#).[po](#).[ru](#).[sw](#)

---

 **Grinding of Simple Tools - Course: Technique for manual working of materials. Trainees' handbook of lessons (Institut fr Berufliche Entwicklung, 19 p.)**  
 *(introduction...)*

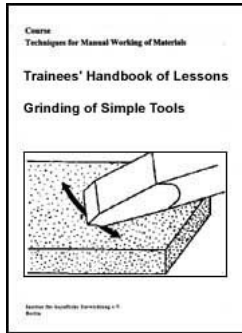

- ➔
1. Purpose of grinding
  2. Machines for grinding
  3. Tools for grinding
  4. Operation of grinding
  5. Operation of whetting
  6. Examples for off-hand sharpening with straight wheels
  7. Hints for mounting and dressing of grinding wheels
  8. Labour safety recommendations

## 1. Purpose of grinding

Sharpening is grinding and whetting of tools after their manufacture in order to prepare the cutting edges for use, i.e. mainly in metal cutting processes.

Furthermore, dull, worn out tools are made serviceable again by this technique. There are two different techniques:

**Off-hand sharpening and sharpening by means of fixtures or special grinding machines.**

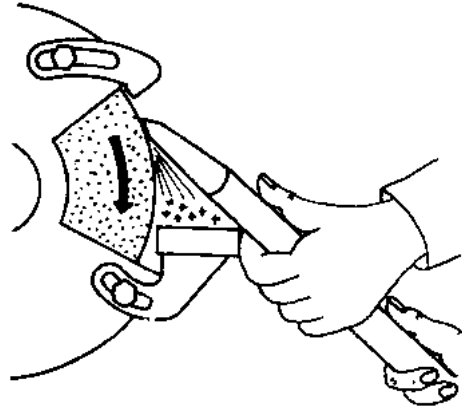

**Figure 1 - Off-hand sharpening**

**Off-hand sharpening** can be done any time and without much preparations on any grinding machine as soon as a tool that was used has become dull. Therefore, this technique should be perfectly mastered. Permanent exercise and practise is required so that the technique is not unlearned. By off-hand sharpening, the following tools can be sharpened:

**Steel scribes and scribes of beam trammels and scribing blocks; punches, chisels and drills of all kinds; screw drivers and scrapers.**

**What is the advantage of off-hand sharpening?**



---

**[Home](#)**"" """"> **[ar.cn.de.en.es.fr.id.it.ph.po.ru.sw](#)**

---

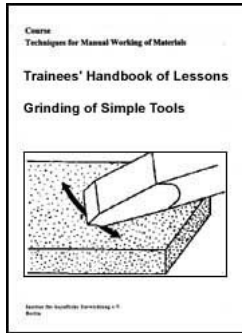

 **Grinding of Simple Tools - Course: Technique for manual working of materials. Trainees' handbook of lessons (Institut für Berufliche Entwicklung, 19 p.)**

 **(introduction...)**

 **1. Purpose of grinding**

 **➔ 2. Machines for grinding**

 **3. Tools for grinding**

 **4. Operation of grinding**

 **5. Operation of whetting**

 **6. Examples for off-hand sharpening with straight wheels**

 **7. Hints for mounting and dressing of grinding wheels**

 **8. Labour safety recommendations**

## 2. Machines for grinding

**In the fields of production and maintenance, bench and pedestal type grinding machines are used which are equipped with two grinding wheels, mostly of a different grain size.**

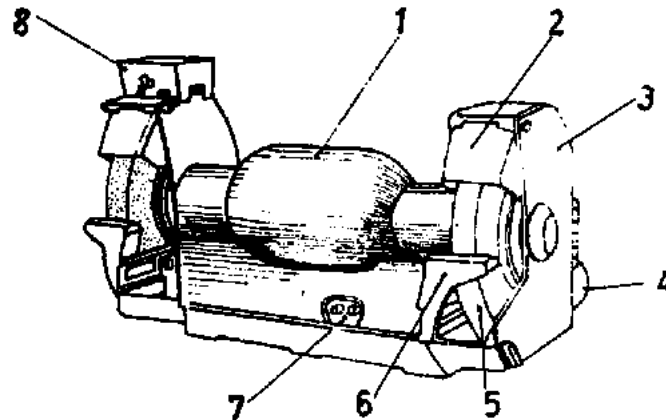

**Figure 2 - Bench-type grinding machine**

- 1 - Motor in motor casing**
- 2 - Spark killer**
- 3 - Covering hood of the grinding wheel**
- 4 - Pipe connection for exhauster**
- 5 - Grinding wheel**
- 6 - Grinding support**
- 7 - Switch**
- 8 - Water tank for wet grinding**



[Home](#) > [ar](#).[cn](#).[de](#).[en](#).[es](#).[fr](#).[id](#).[it](#).[ph](#).[po](#).[ru](#).[sw](#)

 **Grinding of Simple Tools - Course: Technique for manual working of**

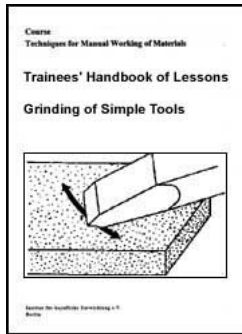

## materials. Trainees' handbook of lessons (Institut fr Berufliche Entwicklung, 19 p.)

*(introduction...)*

1. Purpose of grinding
2. Machines for grinding
- ➔ 3. Tools for grinding
4. Operation of grinding
5. Operation of whetting
6. Examples for off-hand sharpening with straight wheels
7. Hints for mounting and dressing of grinding wheels
8. Labour safety recommendations

### 3. Tools for grinding

These are grinding wheels. They are manufactured in different forms and structural compositions.

#### 3.1. Forms

##### Straight grinding wheels:

Most used grinding wheel for all kinds of tools; it is used in various widths. Since the grinding operation takes place only at the circumference of the wheel, the result is always hollow grinding.

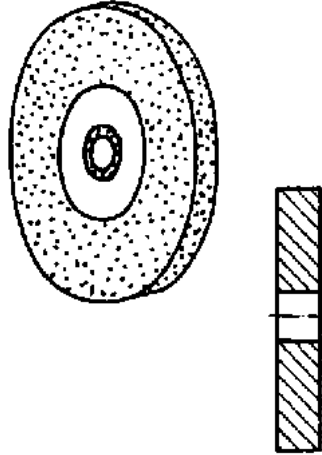

**Figure 3 - Straight grinding wheel**

**Dish wheels:**

**Special grinding wheel for the pointing of drills.**



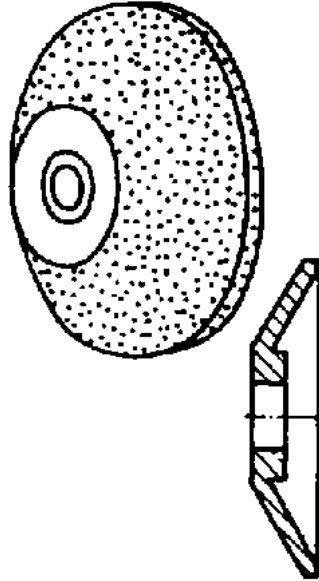

Figure 4 - Dish wheel

### Cup wheels:

**Grinding wheels with flaring or straight (cylindrical) outer face, which - due to their flat end faces - are especially suited for grinding surfaces that must not be hollow-ground, such as lathe tools and planing tools.**

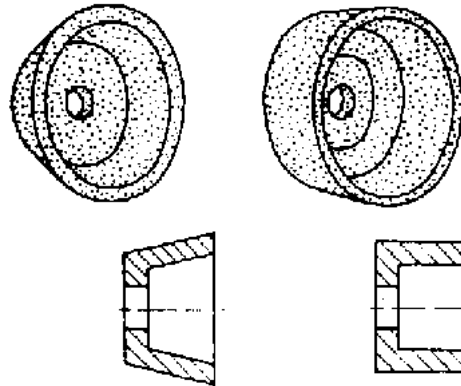

Figure 5 - Cup wheels

### 3.2. Structural compositions

Grinding wheels consist of abrasives (natural or synthetic) and binding agents.

**Abrasives** are produced in grain sizes ranging from very coarse to dust-fine and showing different void spaces between the grains - from very wide to very narrow - in the structure of the grinding wheel.

**Binding agents** may consist of elastic or inelastic materials, which - by the stability of their coherence with the grains of the abrasive - determine the hardness of the grinding wheel.

#### **Note**

- If the abrasive grain shall remain for a long time, because a soft material is to be ground and. therefore, the edges of the abrasive grains are worn out only little, a hard binding agent is used, i.e. a hard wheel.

**- Shall a hard material be ground, a soft binding agent is to be used, so that the rapidly dulling abrasive grains can tear loose quickly to make room for the following sharp grains: soft grinding wheel.**

**Since with off-hand grinding the pressure exerted on the wheel differs greatly and the abrasive grains tear loose more quickly, mostly hard grinding wheels are used.**

### **3.3. Selection of the grinding wheels for off-hand sharpening**

**Corundum wheels:**

**Soft to medium hard with medium grain size for tool steel and high-speed steel.**

**Silicon carbide wheels:**

**Hard with medium to fine grain size for tools with carbide cutting edges.**

**What kind of wheels are mainly used for off-hand sharpening?**

---

**In which cases cup wheels are used?**

---

**Which kind of wheel is used for sharpening tools made of tool steel?**

---



**[Home](#) > [ar.cn.de.en.es.fr.id.it.ph.po.ru.sw](#)**

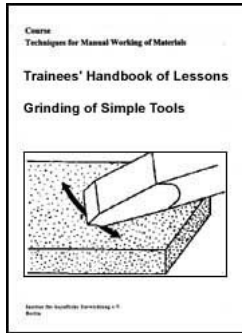

**Grinding of Simple Tools - Course: Technique for manual working of materials. Trainees' handbook of lessons (Institut für Berufliche Entwicklung, 19 p.)**

**(introduction...)**

**1. Purpose of grinding**

**2. Machines for grinding**

**3. Tools for grinding**

**→ 4. Operation of grinding**

**5. Operation of whetting**

**6. Examples for off-hand sharpening with straight wheels**

**7. Hints for mounting and dressing of grinding wheels**

**8. Labour safety recommendations**

#### **4. Operation of grinding**

**When the workpiece is pressed against the grinding wheel which is rotating at a high speed (approximately 2800 rotations per minute), the abrasive grains by their irregular and sharp cutting edges scrape smallest chips from the workpiece.**

**After the abrasive grains have become dull they tear loose from the structure of the wheel making room for the next following sharp abrasive grains that continue the cutting operation.**

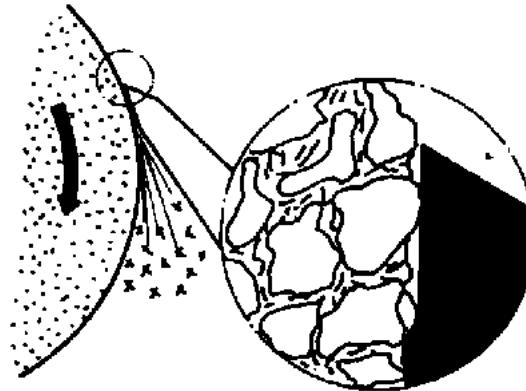

Figure 6 - Effect of the abrasive grains

**Thus the grinding wheel sharpens itself.**

**After sharpening a cutting edge of a tool, a burr is to be noted at the edge. This must be removed by whetting before the tool is used.**



[Home](#) > [ar](#) [cn](#) [de](#) [en](#) [es](#) [fr](#) [id](#) [it](#) [ph](#) [po](#) [ru](#) [sw](#)

 **Grinding of Simple Tools - Course: Technique for manual working of materials. Trainees' handbook of lessons (Institut fr Berufliche Entwicklung, 19 p.)**

 **(introduction...)**

 **1. Purpose of grinding**



-  **2. Machines for grinding**
-  **3. Tools for grinding**
-  **4. Operation of grinding**
-   **5. Operation of whetting**
-  **6. Examples for off-hand sharpening with straight wheels**
-  **7. Hints for mounting and dressing of grinding wheels**
-  **8. Labour safety recommendations**

## 5. Operation of whetting

The flanks of the cutting edges of the tool are rubbed on a fine-grained whetstone moistened with water or oil. The flanks must be treated with the on both sides.

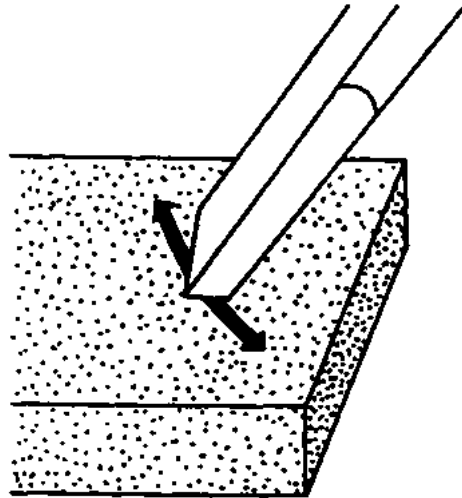

**Figure 7 - Whetting of a shear tool**

**By repeated changing of the side, the burr is bent several times because it always evades to the side opposite to the flank which is being ground.**

**The movement is made in an oblique direction towards the edge till the burr is removed.**

**If the burr is not removed, it breaks off when the tool is used tearing gaps in the cutting edge and making the tool dull and useless soon.'**

**Whetting increases the service life of the cutting edge.**

**What characterizes the grinding operation?**

## What is understood by "self-sharpening" of the grinding wheel?

---

## What is the purpose of whetting?

---



[Home](#) > [ar](#).[cn](#).[de](#).[en](#).[es](#).[fr](#).[id](#).[it](#).[ph](#).[po](#).[ru](#).[sw](#)

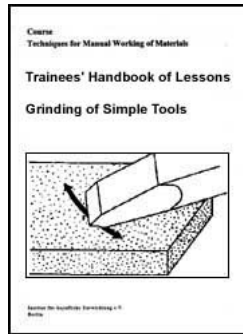

 **Grinding of Simple Tools - Course: Technique for manual working of materials. Trainees' handbook of lessons (Institut für Berufliche Entwicklung, 19 p.)**

 **(introduction...)**

 **1. Purpose of grinding**

 **2. Machines for grinding**

 **3. Tools for grinding**

 **4. Operation of grinding**

 **5. Operation of whetting**

  **6. Examples for off-hand sharpening with straight wheels**

 **7. Hints for mounting and dressing of grinding wheels**

 **8. Labour safety recommendations**

## 6. Examples for off-hand sharpening with straight wheels

### 6.1. Punch and scriber

**The operations are similar with sharpening of punches and scribes.**



**The left hand guides the tool at the grinding wheel, the right hand moves the tool.**

**Operation:**

**Grinding of the taper:**

**The left forefinger lies between grinding support and tool, the thumb is on the tool.**

**The right hand presses the tool against the wheel in horizontal position at the same time revolving it quickly around its own axis.**

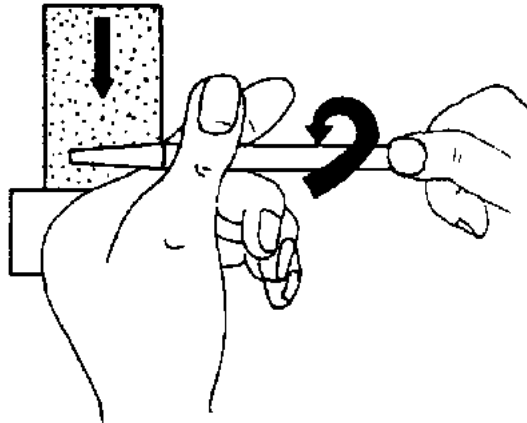

**Figure 8 - Position of the hands when grinding the taper of a scribe**

**Cool at short intervals!**

**With punches, a forward and backward movement is carried out simultaneously.**

**Grinding of the point:**

**The left forefinger lies between grinding support and tool, the thumb is on the tool.**

**The right hand vertically presses it against the wheel in a steeply upward direction revolving it quickly around its own axis.**

**Grind and cool at short intervals in order to prevent annealing.**

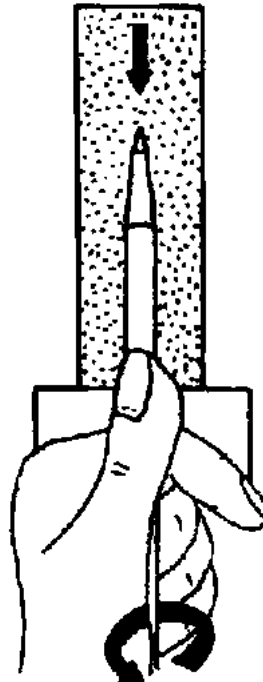

**Figure 9 - Position of the hands when grinding the tip (point) of a scriber****Checking**

The dimensions are checked by a vernier caliper, the angle by a gauge.

The surface must show a fine finish, the point must be situated right in the centre - on the axis of the tool.

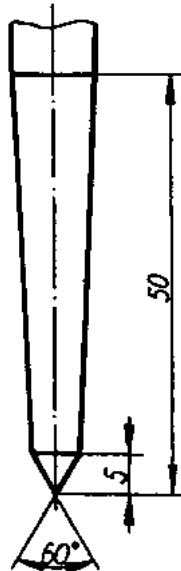
**Figure 10 - Dimensions of the centre punch**

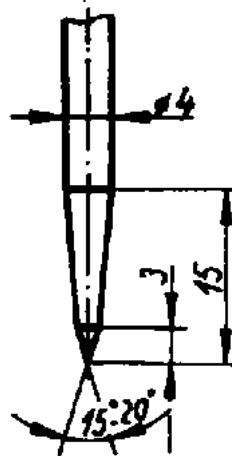

Figure 11 - Dimensions of the scriber

## 6.2. Flat chisel

### Grinding the cutting edge:

The left hand holds the chisel so that the forefinger lies close to the grinding support and under the chisel. The right hand vertically presses the chisel against the wheel in a position directed slightly upwards steadily moving it to and fro.

Then, the chisel is sharpened from the other side. Cool at short intervals.

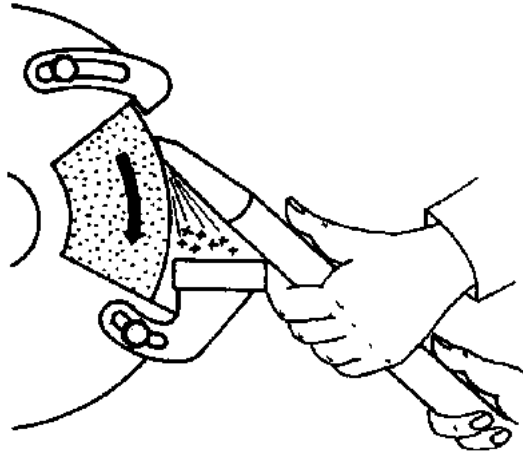

**Figure 12 - Sharpening of a flat chisel**

**Checking:**

**The angle of the cutting edge is checked by the grinding gauge (60°), the surface and parallelism of the cutting edge is judged by the eye. The cutting edge must be situated in the middle on the axis and be parallel to the outside edges.**

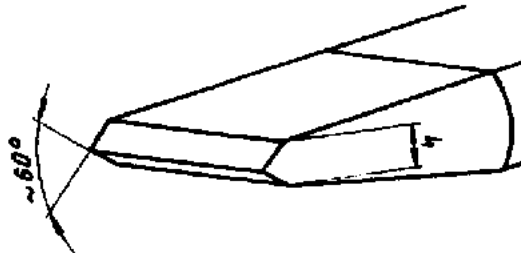

**Figure 13 - Dimensions of the flat chisel****Whetting:**

The cutting edge is rubbed over the whetstone diagonally and in an inclined way till the burr is removed.

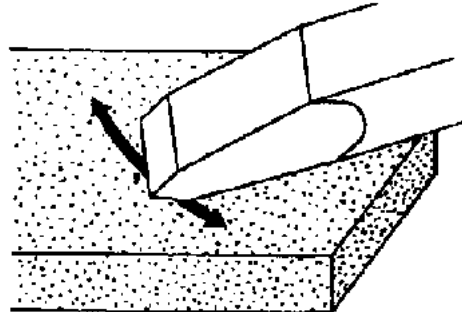
**Figure 14 - Whetting of a flat chisel**

Sharpening of other types of chisels as well as of scrapers is done in a similar way.

**6.3. Drills with standard drill point****Grinding of the principal cutting edges:**

The drill is held between the left forefinger and thumb and guided in such a way that the left principal cutting edge comes in a horizontal position in front of the grinding wheel, the drill itself lies horizontally at an angle of incidence of approximately  $58^\circ$  from the left.

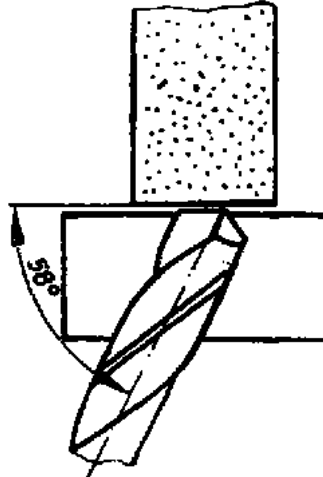

**Figure 15 - Position of the drill**

**With slight pressure the drill is led by the right hand upwards from the wheel and, at the same time, slightly pushed to the right - it is lifted above.**

**This operation is repeated with the other principal cutting edge**

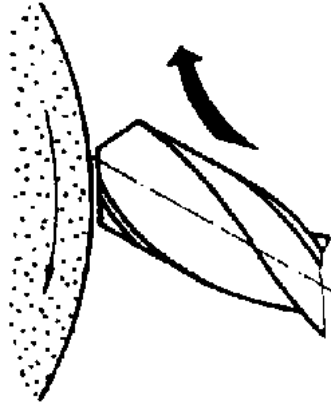

**Figure 16 - Upward movement of the drill**

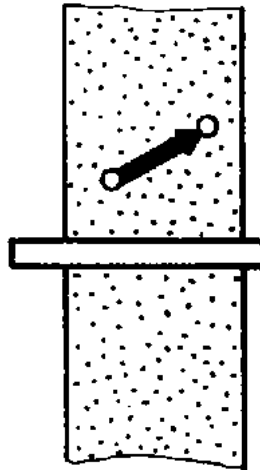



**Figure 17 - Movement of the drill to the right****Checking:**

After every grinding operation the angle has to be checked by the grinding gauge, the evenness and cleanliness of the surface ground is judged by the eye.

**Recommended values:**

- Point angle between the principal edges by gauge ( $118^\circ$  standard drill point)
- Chisel edge must be exactly in the middle and have an angle of  $55^\circ$
- Flanks shall taper off at  $4 - 6^\circ$  behind the principal cutting edges

**Grinding faults:**

- Point angle, angle of clearance, complementary angle of the chisel edge angle too large or too small
- Principal cutting edges (1) different in length (drill out of centre - bore hole too big)

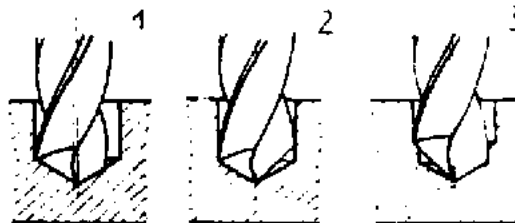

**Figure 18 - Consequences of grinding faults (explanations 1,2,3 in the text)**

- Principal cutting edges at unequal (2) angles (shoulder in the bore hole)

- **Principal cutting edges different in length and unequal angles of the principal cutting edges (3)**
- **Incompletely ground principal cutting edges (drill does not cut)**

### **Pointing of the chisel edge:**

**With drills of a diameter of more than 10 mm the chisel edge is vertically ground at the right edge of the grinding wheel or at the dish wheel in order to reduce the squeezing negative effect of the chisel edge.**

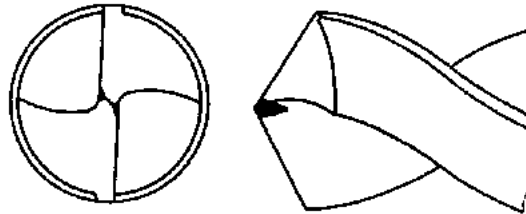

**Figure 19 - Pointed drill**

**What characterizes the technique of punch and scribe sharpening?**

---

**What characterizes the technique of chisel sharpening?**

---

**How is the operation (movement) with the sharpening of drills to be carried out?**

---

**What is understood by 'pointing of the drill'?**

---



[Home](#) > [ar](#).[cn](#).[de](#).[en](#).[es](#).[fr](#).[id](#).[it](#).[ph](#).[po](#).[ru](#).[sw](#)

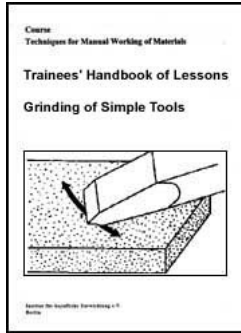

 **Grinding of Simple Tools - Course: Technique for manual working of materials. Trainees' handbook of lessons (Institut für Berufliche Entwicklung, 19 p.)**

 **(introduction...)**

 **1. Purpose of grinding**

 **2. Machines for grinding**

 **3. Tools for grinding**

 **4. Operation of grinding**

 **5. Operation of whetting**

 **6. Examples for off-hand sharpening with straight wheels**

 **➔ 7. Hints for mounting and dressing of grinding wheels**

 **8. Labour safety recommendations**

## 7. Hints for mounting and dressing of grinding wheels

**With mounting the grinding wheel, observe the following order:**

- **Sound out the grinding wheel if it has a ceramic bond (clear, slowly dying away sound - faultless wheel);**

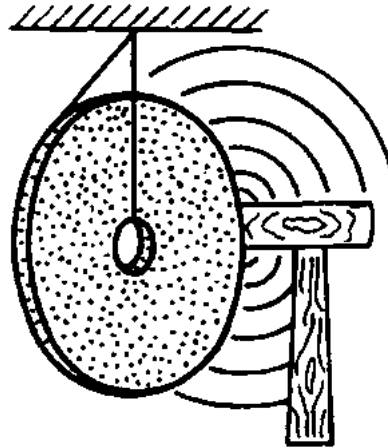

**Figure 20 - Sounding out the grinding wheel**

- **If the bore hole is too big, put a lead bushing (2) into the wheel (1);**
- **Clamp the wheel (1) between two flanges of the same size (3);**

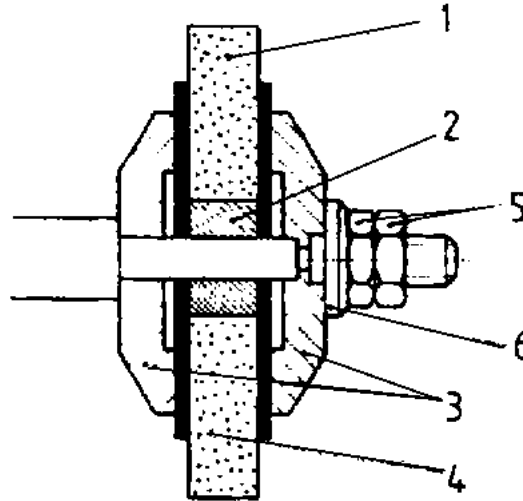

**Figure 21 - Clamping device of the grinding wheel**

- Put soft, elastic washers of rubber or cardboard (4) between the wheel and the flanges;
- Fasten the wheel by a bolt washer (6) and a lock nut (5) on the shaft.

**Pay attention that the right end of the shaft has a right-hand thread, the left end of the shaft a left-hand thread. Then, the spark killer has to be adjusted so that the maximum distance between the spark killer and the grinding wheel is approximately 5 mm. The grinding support must not be more than 1 - 2 mm away from the grinding wheel, because otherwise there is the risk of thin tools being drawn in.**

**Since the size of the grinding wheel is reduced by abrasion during the grinding process, the distances must be permanently put right.**

**After the grinding wheel is mounted it must be dressed in order to guarantee that it runs true. Dressing becomes also necessary when the grinding wheel is uneven or sticky. Only cutting or grinding dressers are used:**

- **Manual dresser**
- **Dressing stick**

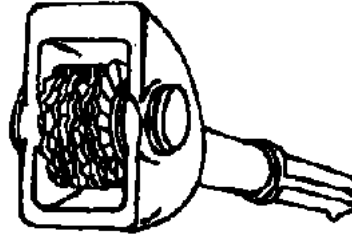

**Figure 22 - Manual dresser**

**Dressing diamonds are applied with the help of dressing devices, if very great demands are made on the grinding wheel as to the precision of dimensions and form as well as surface quality.**

**Operation:**

**With running grinding wheel the manual dresser or dressing stick is pressed firmly against the grinding wheel and slowly moved to and fro.**

**Attention:**

**Put on safety goggles and respirator - very strong formation of dust - very detrimental to health I**



[Home](#) > [ar.cn.de.en.es.fr.id.it.ph.po.ru.sw](#)

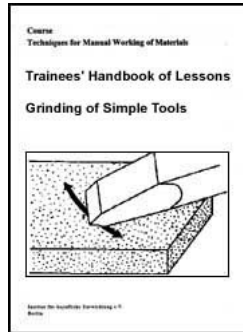

 **Grinding of Simple Tools - Course: Technique for manual working of materials. Trainees' handbook of lessons (Institut für Berufliche Entwicklung, 19 p.)**

 **(introduction...)**

 **1. Purpose of grinding**

 **2. Machines for grinding**

 **3. Tools for grinding**

 **4. Operation of grinding**

 **5. Operation of whetting**

 **6. Examples for off-hand sharpening with straight wheels**

 **7. Hints for mounting and dressing of grinding wheels**

 **➔ 8. Labour safety recommendations**

## 8. Labour safety recommendations

- Only one person is working at the grinding machine - safety. distance laterally and backwards 1 metre.

- When working at grinding machines which are not equipped with a protective device for the eyes, put on safety goggles.

- Distance of the grinding support (1-2 mm) and distance of the spark killer (5 mm) have to be checked constantly.

**- Do never grind any tool without guiding it by the left hand.**

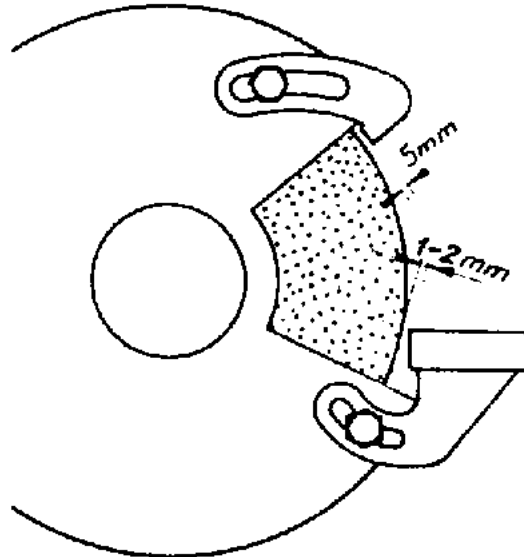

**Figure 23 - Distances of grinding support and spark killer according to the requirements of labour safety**

- Use grinding wheel only frontally - not laterally.**
- Do never grip any tool with a piece of cloth or when you are wearing gloves.**

