

➔  **Formulae and Tables - Wood / textbooks for vocational training (GTZ, 122 p.)**

 **(introduction...)**

 **Preface**

 **1. Wood**

 **(introduction...)**

 **1.1. Structure of Wood**

 **1.2. Chemical Composition of Wood**

 **(introduction...)**

 **1.2.1. Cell Wall Components of Wood**

 **1.2.2. Wood Constituents**

 **1.3. Physical Properties of Wood**

 **(introduction...)**

 **1.3.1 Wood Density**

 **1.3.2. Moisture Content of Wood**

 **1.3.3. Swelling and Shrinking of Wood**

 **1.3.4. Thermal Properties of Wood**



















 **1.3.5. Acoustic and Electric Properties of Wood**

















 **1.3.6. Friction Properties of Wood**

 **1.3.7. Strength of Wood**

 **1.4. Important Wood Species**

-  **1.5. Wood Defects Caused by Growth Influences**
- **2. Materials Made of Wood**
 - **2.1. Solid Wood**
 -  *(introduction...)*
 -  **2.1.1. Not Improved Solid Wood**
 -  **2.1.2. Improved Solid Wood**
 -  **2.2. Laminated Wood**
 -  **2.3. Sandwich Boards**
 -  **2.4. Fibreboards**
 -  **2.5. Particle Boards**
- **3. Plastic materials**
 -  *(introduction...)*
 -  **3.1. Classification of Plastic Materials**
 -  **3.2. Properties of Important Plastic Materials**
 -  **3.3. Applications of Important Plastic Materials**
- **4. Glass Materials**
 -  *(introduction...)*
 -  **4.1. Classification of Glass Materials**
 -  **4.2. Properties of Glass Materials**
 -  **4.3. Applications of Glass Materials**
- **5. Steel**
 -  *(introduction...)*
 -  **5.1. Classification of Steels**

-  **5.2. Properties of Important Steels**
-  **5.3. Applications of Important Steels**
-  **5.4. Screws and Nails**
- 6. Basic Terms of Cutting**
 -  **(introduction...)**
 -  **6.1. Faces and Angles on the Tool**
 -  **6.2. Directions of Cutting**
 -  **6.3. Cutting Speeds**
 -  **6.4. Cutting-Edge Dulling and Cutting-Edge Wear**
- 7. Hand Tools**
 -  **(introduction...)**
 -  **7.1. Measuring and Marking Tools**
 -  **7.2. Sawing Tools**
 -  **7.3. Planing Tools**
 -  **7.4. Mortising and Ripping Tools**
 -  **7.5. Drilling and Boring Tools**
 -  **7.6. Rasps and Files**
 -  **7.7. Other Tools**
- 8. Wood Working Machines**
 - 8.1. Sawing Machines**
 -  **(introduction...)**
 -  **8.1.1. Circular Saw Benches**

-  **8.1.2. Parallel Rocking Circular Sawing Machine**
-  **8.1.3. Table Band Sawing Machine**
- 8.2. Milling Machines**
 -  *(introduction...)*
 -  **8.2.1. Smooth Miller**
 -  **8.2.2. Thicknessing Miller**
 -  **8.2.3. Shaping Machine**
 -  **8.2.4. Slot Milling Machine**
-  **8.3. Lathe**
- 8.4. Drilling Machines**
 -  *(introduction...)*
 -  **8.4.1. Box-Column Drilling Machine**
 -  **8.4.2. Hand Drilling Machine**
- 8.5. Sanding Machines**
 -  *(introduction...)*
 -  **8.5.1. Horizontal Belt Sanding Machine**
 -  **8.5.2. Column-Type Disk Sanding Machine**
-  **8.6. Presses**
- 8.7. Sharpening Machines**
 -  **8.7.1. Ripping Chisel and Plate Iron Sharpening Machine**
 -  **8.7.2 Sharpening Machine for Circular and Band Saw Blades**

 **8.7.3 Milling Cutter Sharpening Machine**
8.7.4. Blade Sharpening Machine **9. Tools** ***(introduction...)*** **9.1. Tools for Circular Sawing Machines** **9.2. Tools for Table Band Sawing Machines** **9.3. Tools for Smooth and Thicknessing Millers** **9.4. Tools for Shaping Machines** **9.5. Tools for Slot Milling Machines** **9.6. Tools for Drilling Machines** **9.7. Tools for Sanding Machines** **9.8. Tools for Sharpening Machines** **10. Setting-up of Tools** **10.1. Setting-up of Hand Tools** **10.2. Setting-up of Machine Tools** **11. Gluing of Wood** ***(introduction...)*** **11.1. Important Terms of the Gluing Techniques** **11.2. Kinds, Properties and Processing of Important Glues** **11.3. Gluing Mistakes and Their Causes** **12. Surface Treatment of Wood** ***(introduction...)***

-  **12.1. Substances for Surface Treatment**
-  **12.2. Use of the Coating Compositions**
-  **12.3. Examples of Wood Coating Systems**
-  **List of Symbols Used**



[Home](#) > [ar](#).[cn](#).[de](#).[en](#).[es](#).[fr](#).[id](#).[it](#).[ph](#).[po](#).[ru](#).[sw](#)

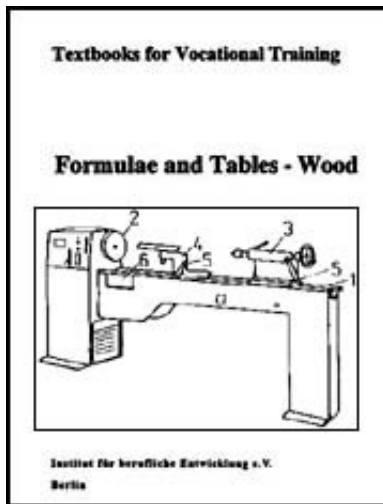

 **Formulae and Tables - Wood / textbooks for vocational training (GTZ, 122 p.)**

  **(introduction...)**

 **Preface**

- 1. Wood**
- 2. Materials Made of Wood**
- 3. Plastic materials**
- 4. Glass Materials**
- 5. Steel**
- 6. Basic Terms of Cutting**
- 7. Hand Tools**
- 8. Wood Working Machines**
- 9. Tools**
- 10. Setting-up of Tools**
- 11. Gluing of Wood**
- 12. Surface Treatment of Wood**
-  **List of Symbols Used**

Institut für berufliche Entwicklung e.V. Berlin

Original title:
"Formeln und Tabellen - Holz"

Author: Dieter Zemmrich

First edition © IBE

**Institut für berufliche Entwicklung e.V.
Parkstraße 23
13187 Berlin**

Order-No.: 93-34-0301/2



[Home](#) > [ar](#).[cn](#).[de](#).[en](#).[es](#).[fr](#).[id](#).[it](#).[ph](#).[po](#).[ru](#).[sw](#)

 **Formulae and Tables - Wood / textbooks for vocational training (GTZ, 122 p.)**









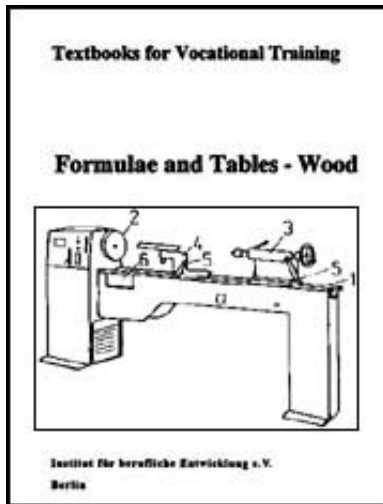







➔  **8. Wood Working Machines**

 **8.1. Sawing Machines**

 **(introduction...)**

 **8.1.1. Circular Saw Benches**



-  **8.1.2. Parallel Rocking Circular Sawing Machine**
-  **8.1.3. Table Band Sawing Machine**
- 8.2. Milling Machines**
 -  *(introduction...)*
 -  **8.2.1. Smooth Miller**
 -  **8.2.2. Thicknessing Miller**
 -  **8.2.3. Shaping Machine**
 -  **8.2.4. Slot Milling Machine**
-  **8.3. Lathe**
- 8.4. Drilling Machines**
 -  *(introduction...)*
 -  **8.4.1. Box-Column Drilling Machine**
 -  **8.4.2. Hand Drilling Machine**
- 8.5. Sanding Machines**
 -  *(introduction...)*
 -  **8.5.1. Horizontal Belt Sanding Machine**
 -  **8.5.2. Column-Type Disk Sanding Machine**
-  **8.6. Presses**
- 8.7. Sharpening Machines**
 -  **8.7.1. Ripping Chisel and Plate Iron Sharpening Machine**
 -  **8.7.2 Sharpening Machine for Circular and Band Saw Blades**



8.7.3 Milling Cutter Sharpening Machine

8.7.4. Blade Sharpening Machine

Formulae and Tables - Wood / textbooks for vocational training (GTZ, 122 p.)

8. Wood Working Machines

8.1. Sawing Machines

Sawing machines are used mainly for parting materials made of wood.

8.1.1. Circular Saw Benches

The machine serves for making straight longitudinal, cross, angular and mitre cuts.

Construction

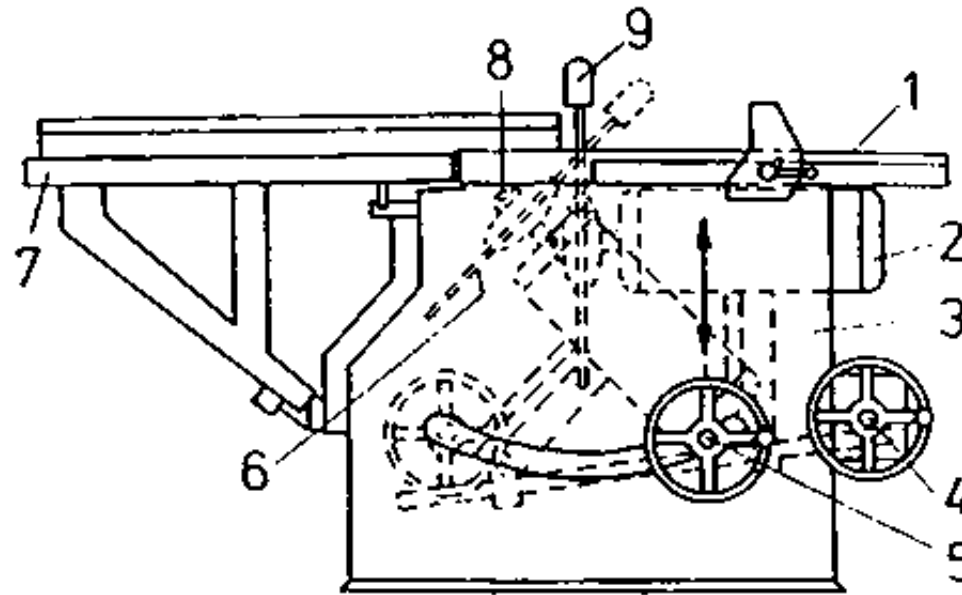

1 work supporting table, 2 tool motor, 3 machine frame, 4 hand wheel for tilting the tool motor, 5 hand wheel for vertical adjustment of the tool motor, 6 saw blade, 7 sliding table, 8 motor shaft = saw shaft, 9 protective hood

Figure 12 Circular saw bench

Information on labour safety

The splitting wedge has a clearance of 10 mm; blade thickness < splitting wedge thickness < setting width; the splitting wedge is secured against removal. The protective hood is fixed to the splitting wedge and must cover unused parts of the saw blade above the workpiece. It must project 20 mm beyond the entrance of the cutting circle in the machine table. In case of hand feed the stop rail should

project 1/4 of the saw blade diameter beyond the centre of the blade in cutting direction. In principle, gauges or work guides are to be used when sawing. Sliding and rolling tables must firmly be connected with the machine and secured against lifting. The table edges adjacent to the saw blade consist of cuttable material and are replaceable. The spacing between saw blade and table is ≤ 3 mm.

Recommendations for maintenance

Remove chips, wood residues and dust before using the machine. Regularly lubricate bearings and other movable parts according to the lubrication instructions. Protect bare parts against corrosion.

Specification

tool diameter	250...600 mm
tool speed	1500...4500 min ⁻¹
dimensions of the main table	1000 mm × 1200 mm
dimensions of the sliding table	750 mm × 350 mm
input power	2.5...5.6 kW

8.1.2. Parallel Rocking Circular Sawing Machine

The machine is used for rough cross cuts in solid wood.

Construction

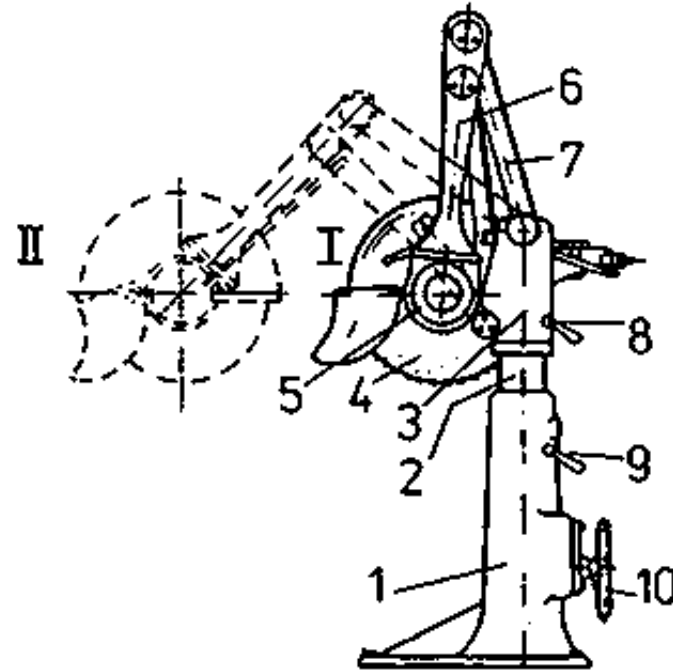

I in position of rest

II during the cutting movement

1 machine support, 2 guide tube, 3 upper part of machine, 4 saw blade, 5 drive motor, 6 swivel arm, 7 hinged lever, 8 arresting lever for rotary movement of the upper part of the machine, 9 arresting lever for vertical adjustment, 10 hand wheel for vertical adjustment

Figure 13 Parallel rocking circular sawing machine

A round column supports the revolving and vertically adjustable upper part of the machine. A swivel arm carries the saw motor the feeding movement of which is effected in a straight line and in parallel to the surface of the supporting table by means of a parallel linkage. The tool is mounted on the motor shaft.

Information on labour safety

After the cut the saw blade must automatically return to the position of rest and be held in place. In doing so, the saw blade must run into a safety guard. The locking device must be disengageable by the handle. The spacing between work stop and lower edge of the protective hood must be < 8 mm in position of rest. The work supporting table must have rolls or rollers. Slots are not permitted on both sides of the saw blade at a distance of 400 mm. See also circular saw benches.

Recommendations for maintenance

Regularly check the function of the feeding rolls or rollers. Lubricate all moving parts according to plan. See also recommendations for circular saw benches.

Specification

tool diameter	300...600 mm
tool speed	$\approx 3000 \text{ min}^{-1}$
swiveling angle of the saw blade	$\leq 45^\circ$
width of the cut	≤ 600 mm
height of the cut	≤ 150 mm
input power	2.0...5.5. kW

8.1.3. Table Band Sawing Machine

The machine is used for straight longitudinal, cross and angular cuts as well as for chamfering and rounding.

Construction

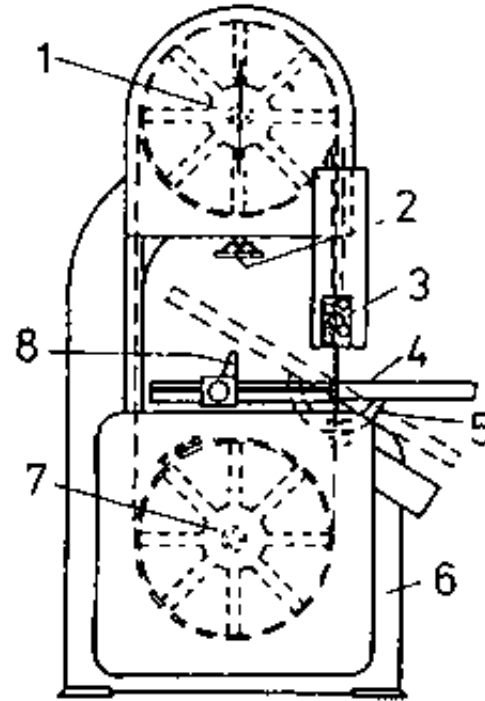

1 upper band saw guide roller, 2 hand wheel for height adjustment, 3 vertically adjustable upper saw blade guide, 4 work supporting table, 5 guide for tilting the table, 6 machine column, 7 lower band saw guide roller, 8 side stop

Figure 14 Table band sawing machine

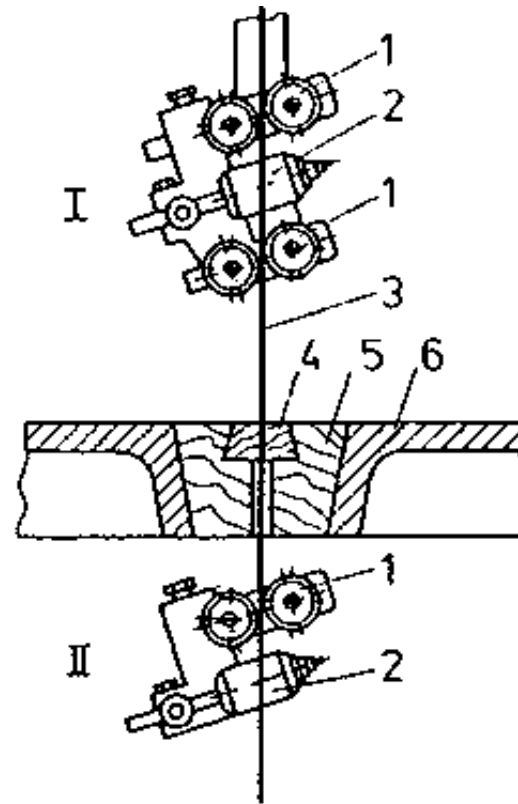

I upper guide

II lower guide

1 side guide rollers, 2 back guide rollers,

3 band saw blade, 4 fitting piece, 5 table

insert, 6 machine table

Figure 15 Roller guide of the band saw blade

The machine consists of frame of the machine, upper and lower band saw guide rollers and machine table. The upper band saw guide roller serves as stretcher for the saw blade the deflection of which under stress is prevented by saw blade guides. The upper band saw guide roller is tillable for adjustment of the blade run (saw tilt).

Information on labour safety

Adjustment of the upper saw blade guide must be possible without any danger while the machine is running. Cover those parts of the saw blade which are not required for sawing as well as the saw blade after the sawing process up to the table surface. When cross-cutting round wood or similar, work with holding means. The saw blade passage in the machine table must not be broader than 3 mm. An emergency circuit breaker for quickly braking the motor must be available.

Recommendation for maintenance

Regularly check the guide rollers for proper setting. Regularly check the rubber coating of the band rollers for cleanliness, wear and damage. Untension the saw blade of machines which will not be in operation for a long time.

Specification

saw-blade length	3000...5500 mm
saw-blade width	5...60 mm
speed of the band saw guide rollers	650...950 mm ⁻¹
roller diameter	300...850 mm
depth of throat (cutting width)	350...900 mm
workpiece thickness	≤ 500 mm
input power	1.0...5.5 kW

8.2. Milling Machines

Milling machines are used for dressing, levelling and shaping of materials made of wood.

8.2.1. Smooth Miller

The machine serves for making plane surfaces.

Construction

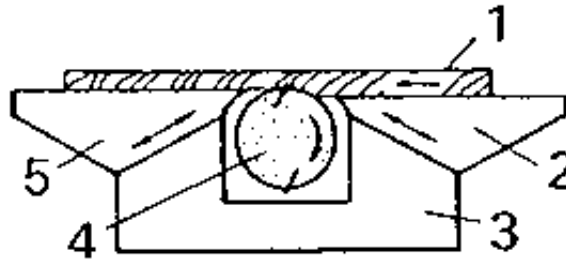

*1 stop rail, 2 adjustable feed table, 3 machine frame,
4 blade shaft, 5 adjustable unloading table*

Figure 16 Smooth miller

The box-like cast column supports the two vertically adjustable machine tables and the housings of the antifriction bearings for the blade shaft. The electric motor in the column drives the blade shaft via a belt drive. An adjustable stop rail serves for guiding the workpiece. The feeding table is set to be lower than the unloading table by the amount of the cutting depth. That part of the blade shaft which is not required is covered by a safety guard which is firmly connected to the machine.

Information on labour safety

The spacing between the table lips and the cutting circle is a 3 mm. The table lips must not be damaged, when feeding by hand they must not be recessed. Adjust the table only when the blade shaft is at rest. Workpiece with a length of less than 400 mm and a thickness of less than 25 mm and workpieces with a length of 400...800 mm and a thickness of less than 10 mm must not be machined. Machine such work-pieces only with the help of a feeding device.

Recommendations for maintenance

Clean the table surface and stop rail from resin residues and other impurities after use. Regularly check the table lips for damage. Regularly check the stop rail for ease of motion. Lubricate it according to the lubrication chart.

Specification

diameter of the blade shaft	100... 125 mm
speed of the blade shaft	4500...6000 min ⁻¹
number of blades	2; 4
length of the feeding table	1100...1600 mm
length of the unloading table	1100...1500 mm
working width	400...600 mm
input power	3.0...6.0 kW

8.2.2. Thicknessing Miller

With this machine parallel broad surfaces and - in case of strip-like thicker

workpieces - also narrow surfaces are produced.

Construction

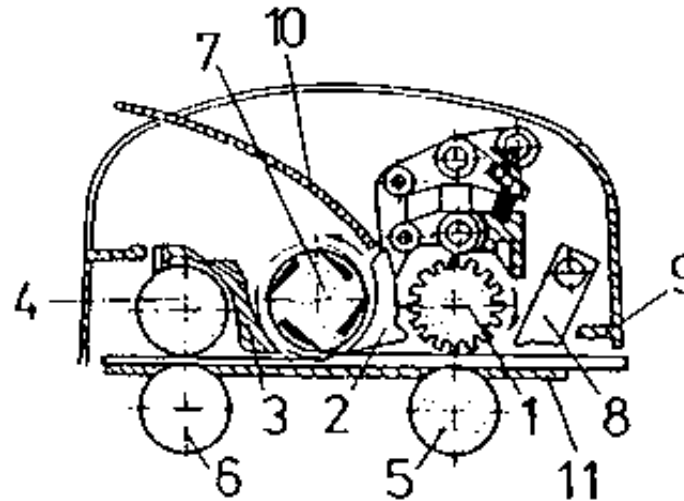

1 front feed roll, 2 front pressure bar, 3 rear pressure bar, 4 rear feed roll, 5 table roll, 6 table roll, 7 blade shaft, 8 rebound protection, 9 control of action, 10 chip chute, 11 machine table

Figure 17 Thicknessing miller

The box-like frame of the machine (cast or welded construction) supports the vertically adjustable machine table and the functional elements of the machine. A heavy driving motor (mostly outside the machine) drives the higher blade shaft via a belt drive. Feeding is effected by higher feed rollers and lower table rollers which are driven by the blade shaft. A motor provides for the table height adjustment (rapid adjustment).

Information on labour safety

Rebound protections must be available. The feeding devices must be constructed in such a way that the workpiece is safely supported and cannot be thrown out. Workpieces having a thickness of less than 5 mm must be machined with a base. Open protective hoods of blade shafts only when the machine is at rest. Workpieces which are thinner than 25 mm require elements of rebound protection which are half as wide as the workpiece. It must be possible to stop the feeding device independently of the tool.

Recommendations for maintenance

Regularly check the vee belt belt between motor and blade shaft for proper tension. Make sure that the chips are properly removed. Lubricate according to the lubrication chart.

Specification

diameter of the blade shaft	100...125 mm
speed of the blade shaft	4500...5500 min ⁻¹
number of blades	2; 4
feeding speed	4...30 m/min
workpiece length \geq 200 mm	
workpiece width	5...800 mm
workpiece thickness	3...300 mm
input power	4...7.5 kW

8.2.3. Shaping Machine

With this machine profiles, groove and tongue joints, overlap joints, mortise and tenon joints etc. can be produced.

Construction

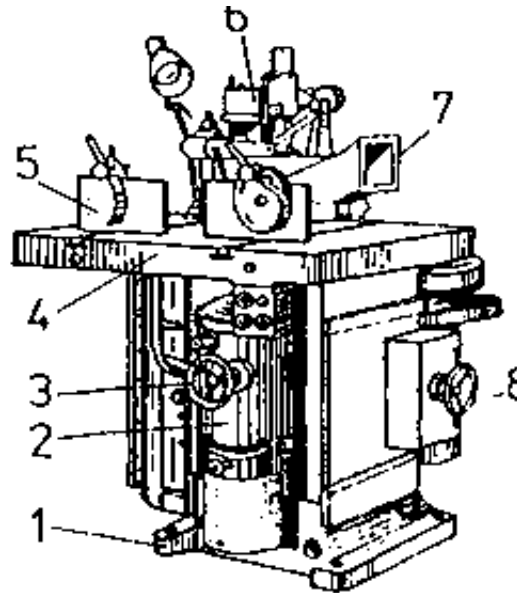

1 machine frame, 2 tool carrier, 3 hand wheel for vertical adjustment of the cutter spindle, 4 machine table, 5 work guide, 6 upper bearing for cutter arbor, 7 chip removal suction connection, 8 hand wheel for adjusting the belt drive tension

Figure 18 Shaping machine



1 cutter spindle neck with external thread, 2 cutter arbor, 3 differential nut, 4 threaded cutter arbor, 5 milling machine arbor collars, 6 cutter arbor nut, 7 safety nut

Figure 19 Tool carrier of the shaping machine

The frame of the machine supports the work-rest table which has a round opening for the tool carrier. An electric motor drives over a belt drive the cutter spindle on the extension of which, i.e. the cutter arbor, the tool is mounted. During operations where the cutter arbor is heavily loaded the latter can be guided in an upper bearing. For vertical adjustment either the spindle or the rest table is adjusted.

Information on labour safety

The following fixtures must be available: stop rail with stop block; fence ring and fence strip of extended template; clamp carriage and feeding slide; steel band hand guard and guard bow; upper cover for chip suction; guard bow and protective ring with ball bearings; protective box or protective bell; pressure

racks, rebound gripper; rebound-proof guide box with stop block. The distance from the cutting circle to the halves of the stop rails may be ≤ 3 mm.

Cutter arbors with upper bearing journal are to be used with upper bearing also for test work. For clockwise and anti-clockwise rotation the holding nut must be secured by a lock nut. The time lag of the tool after switching-off of the machine is ≤ 10 seconds.

Recommendations for maintenance

Clean seatings and bearing surfaces as well as guide slots daily. Regularly clean the air intake side of the motor and facilities of vertical and stop adjustment from chips and dust. Regularly check the spacers and fence rings for cleanliness and intactness. Regularly check the seat of the Morse taper.

Specification

length of the machine table	800... 1200 mm
width of the machine table	500...1000 mm
height of the machine table	850...900 mm
cutter arbor diameter	30; 40 mm
spindle speed	1200...12,000 min ⁻¹
input power	1.0...12.0 kW

8.2.4. Slot Milling Machine

With this machine round holes and longitudinal slots can be produced.

Construction

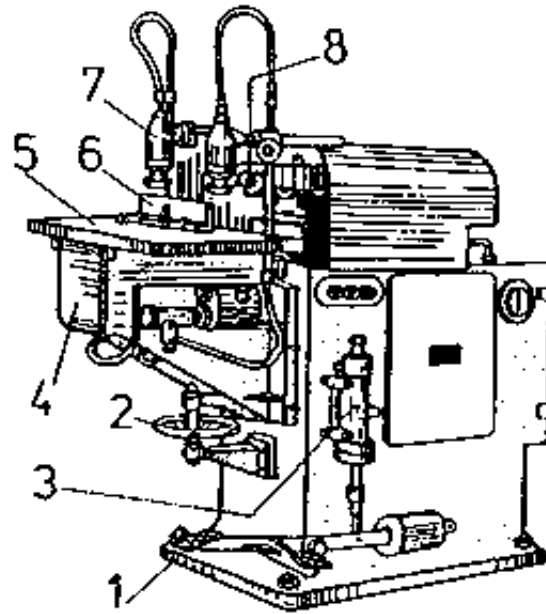

1 machine frame, 2 hand wheel for table height adjustment, 3 pneumatic valve, 4 carrier for the supporting table, 5 work supporting table, 6 stop rail, 7 pneumatic cylinder for arresting the workpiece, 8 tool mounting

Figure 20 Slot milling machine

A cast frame carries the tool box, the motor and, on the front side, the machine table with the mechanisms for movement. The axial feed (drilling) is carried out by the tool box or the machine table with mounted workpiece. The cross feed (milling) is performed either by the machine table or by a floating movement of the tool with the table being motionless. For angular recesses the table can be

adjusted (tilted), the work can be set up with eccentric gripping lever, screws or pneumatic clamping elements. The drive is effected by a belt drive.

Information on labour safety

A bonnet is necessary. Check the tool clamping devices regularly for their operational reliability.

Recommendations for maintenance

Keep clamping shanks and chuck clean. Always keep the surface of the machine table and work stop clean. Lubricate according to the lubrication chart.

Specification

tool diameter	4...25 mm
spindle speed	1400...10,000 min ⁻¹
drilling depth	≤ 100 mm
length of the longitudinal slot	≤ 200 mm
input power	1.5...5 kW

8.3. Lathe

This machine serves for turning between centres and face turning and is suited for chucking work. Construction

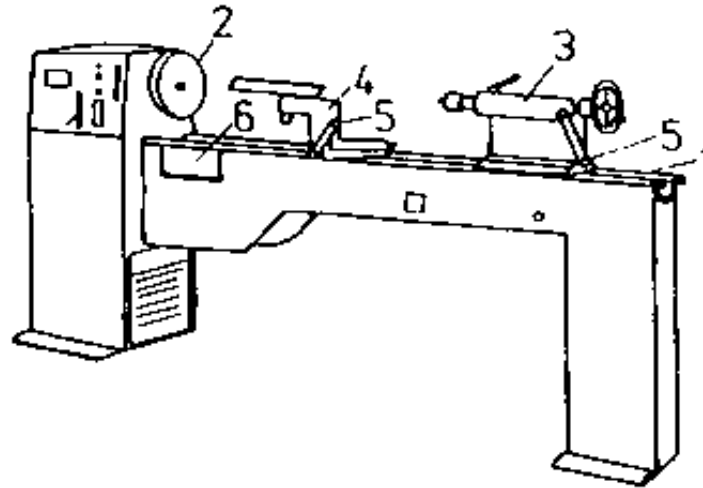

*1 machine bed, 2 spindle, 3 tailstock, 4 rest,
5 eccentric, 6 gap*

Figure 21 Lathe

The machine bed made of cast iron carries the headstock, tailstock, hand rest and spindle drive. The electric motor for the spindle drive is located in the left base. Tailstock and rest are adjusted along the bed by hand and arrested by an eccentric. The gap makes machining of short workpieces with large diameter possible.

Information on labour safety

Chucks with protecting chuck jaws, clamp or locking screws are to be provided with a smooth all-round cover. Never leave the key in the chuck. Do not check the workpieces while they are rotating. Do not remove the chips while the machine is running. Do not slow down workpieces by hand during the run-out. The hand rest should be as close to the workpiece as possible. Do not lay down tools on the machine bed. Wear tightly fitting clothing.

Recommendations for maintenance

Slightly grease all bare parts regularly with acid-free grease. Regularly check the function of the cam-lock. Keep the machine bed clean. Make sure that the tailstock is in perfect condition. Clean the faceplate, chuck and tailstock centre regularly from adhering dirt, resin and similar.

Specification

centre distance	1000...2000 mm
centre height	200...400 mm
work diameter above gap	≤ 750 mm
length of the workpiece to be turned in the gap spindle speed	≤ 225 mm 250...2500 min ⁻¹
speed increments of the spindle	≈ 9
input power	1.5...2.5 kW

8.4. Drilling Machines

Drilling machines are used for making rotationally symmetrical bore holes.

8.4.1. Box-Column Drilling Machine

The machine serves for drilling round holes.

Construction

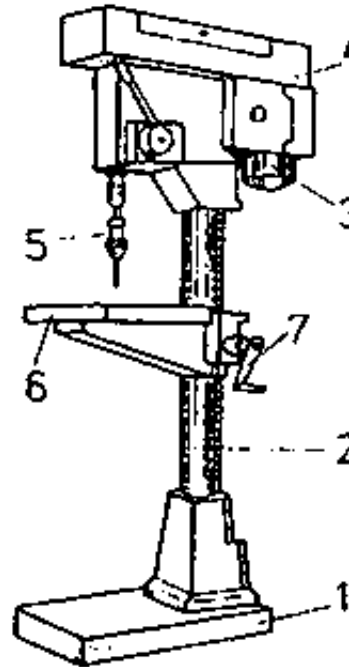

1 base plate, 2 column, 3 driving motor, 4 spindle drive, 5 drilling spindle with drill, 6 work supporting table, 7 hand crank for table height adjustment

Figure 22 Box-column drilling machine

The base plate carries the column with the vertically adjustable work supporting table and the drill head with motor, belt drive and tool spindle. The drilling feed is produced by a hand or foot lever or automatically (transferred from the spindle drive).

Information on labour safety

Locking screws on toolholders must be covered or countersunk. Clamping fixtures have to provide for proper seating of the tool and workpiece. All safety guards must be adjustable to the various height and depth settings of the drills.

Recommendation for maintenance

Keep drill chucks and tool shanks clean. Clean the work support and the work stops regularly. Lubricate according to the lubrication chart.

Specification

tool diameter	≤ 40 mm
speed of the tool spindle	150...4500 min ⁻¹
travel of the tool spindle	≤ 150 mm
length of the support table	250...450 mm
width of the support table	200...350 mm
input power	0.7...2.5 kW

8.4.2. Hand Drilling Machine

The hand drilling machine serves for drilling round holes and is mainly used on building sites and for erection work.

Construction

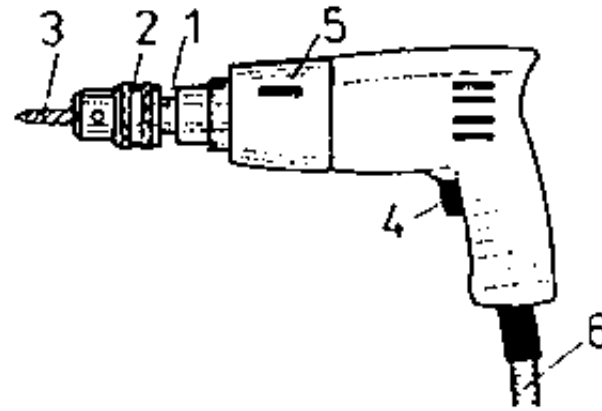

1 drilling spindle, 2 drill chuck, 3 drilling tool, 4 control handle, 5 speed switch, 6 electric cable

Figure 23 Hand drilling machine

In most cases the driving element is a universal motor which can be used for direct and alternating currents. The prolonged motor shaft is simultaneously the carrier and is provided with a chuck. The motor is enclosed by a light-metal casing with handle.

Information on labour safety

Plug the machine only into a socket with earthing contact. Never use damaged cables.

Recommendations for maintenance

Regularly check the condition of the lead-in cable. Always keep the chuck and tool shanks clean.

Specification

tool diameter ≤ 40 mm

tool speed 350...2000 min⁻¹

input power 0.2...0.8 kW

weight 1.4...6.0 kg

8.5. Sanding Machines

Sanding machines are used for making smooth and flat surfaces on wood-based materials.

8.5.1. Horizontal Belt Sanding Machine

This machine is required mainly for smoothing of broad surfaces, but it can also be used for lacquer sanding.

Construction

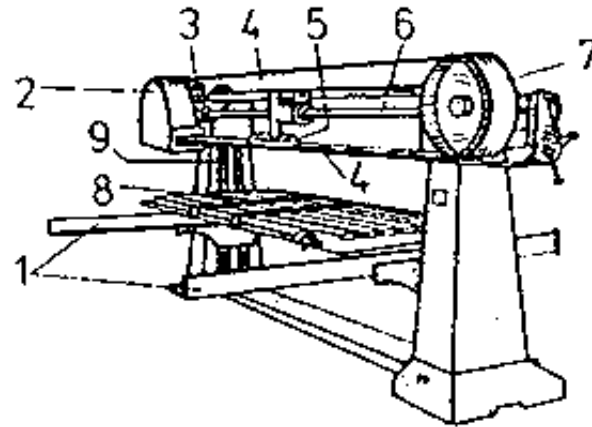

1 guide rails for the work supporting table, 2 protective hood for the driven belt roller, 3 driving motor, 4 sanding belt, 5 sanding shoe, 6 leverage with counterweight for sanding shoe, 7 belt roller which is not driven, 8 work supporting table, 9 machine frame

Figure 24 Horizontal belt sanding machine

Between the columns of a cast upright standard the vertically adjustable work supporting table is running on round bars or guide rails. The drive is capable of being switched over (clockwise or anticlockwise rotation), the driven belt roller is designed in most cases as face sanding disk. For sanding on the sliding table which is provided with an adjustable stop a pressure shoe is used on which felt is glued on. For lacquer sanding the pressure shoe must be provided with hard bristles instead of the felt. This helps to reduce the frictional heat. (Reduce sanding belt speed to 12...14 m/s).

Information on labour safety

The sanding belt at the belt rollers and the upper part of the rotating belt at the

front edge must be completely covered. The pressure shoe must automatically lift itself when not being used. The hand guiding the table must not get within reach of the sanding belt. Collecting grids are to be attached to the exhaust openings. Strictly observe the regulations on exhausting the sanding dust and storing it. Lacquer and wood sanding dust must be exhausted and kept seperatly. When sanding lacquer, connect all conductive parts to earth to prevent electrostatic charges and increase the relative air humidity to 70 %. Use antistatic polishing agents.

Recommendations for maintenance

Protect bare parts against corrosion. The pressure shoe must be movable to slightly reciprocate and to adapt itself to the work surface. The pressure shoe must be in an impeccable condition.

Specification

sanding belt width	150...500 mm
sanding belt speed	15...30 m/s
belt roller diameter	≈ 300 mm
distance between belt roller centres	≈ 3000 mm
belt roller speed	≈ 1500 min ⁻¹
length of the supporting table	1000...2500 mm
width of the supporting table	300... 1000 mm
input power	3...10 kW

8.5.2. Column-Type Disk Sanding Machine

This machine serves for smoothing small and thin as well as curved parts.

Construction

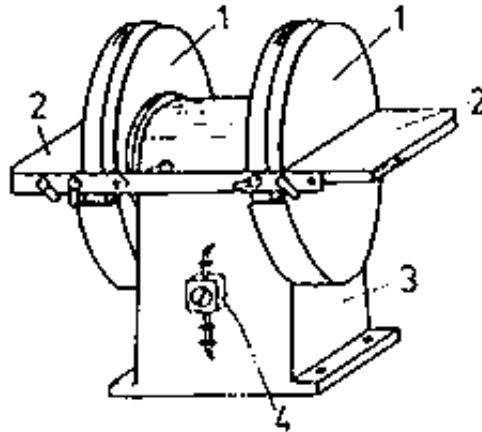

1 sanding disk, 2 work supporting table, 3 machine frame, simultaneously casing for the driving motor, 4 switch

Figure 25 Column-type disk sanding machine

A box-like cast column accommodates the driving motor. Over a vee-belt the motor drives the machine parts on which the sanding disks are mounted. The work supporting table is inclinable in most cases.

Information on labour safety

Distance between disk and table $s \leq 3$ mm; the sanding tool must be fixed by means of a locking ring (at least 6 fastening screws). With the exception of the working surface the disk must be covered on all sides. When working on the upwards running portion of the disk, secure the workpiece against being torn upwards.

Regularly check disks made of grey cast iron for cracks.

Recommendations for maintenance

Lubricate the machine according to the lubrication chart. Protect all bare parts against corrosion. Regularly check the vee-belt for serviceability.

Specification

sanding disk diameter 600...1300 mm

speed of the sanding disk 750... 1500 min⁻¹

input power 3.0...7.5 kW

8.6. Presses

Presses are used for compressing flat workpieces during solidification of the glue.

Hand Screw Press

This press serves for coating flat workpieces and for similar operations.

Construction

The frame made of sectional steel is bolted. Cross members on the bottom beams carry the press table (sometimes the press table is retractile).

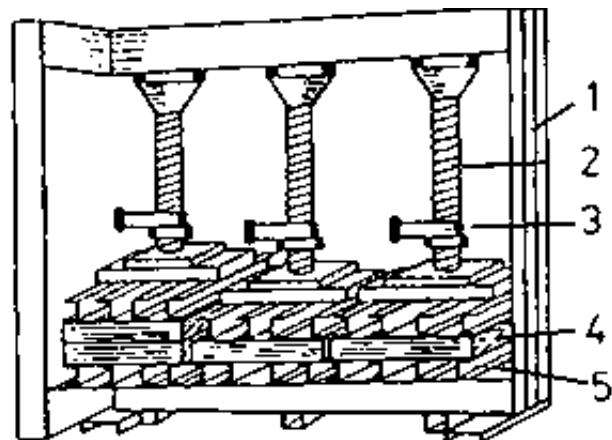

1 press frame, 2 flat-thread screw, 3 lever guidance, 4 package to be pressed (work-piece), 5 press table

Figure 26 Hand screw press

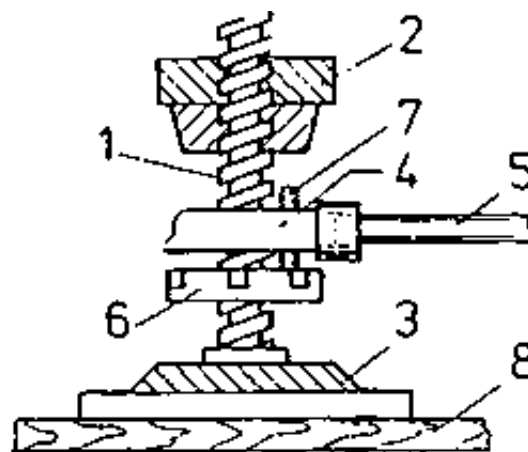

1 flat-thread screw, 2 screw nut, 3 thrust bearing, 4 lever guidance, 5 insertible lever, 6 locking disk, 7 pawl, 8 package to be pressed

Figure 27 Mode of action of the hand screw

Between the upper beams there are flanged cross bars with threads for transmitting motions for the screws. At the lower end of the screw the pressure shoe is supported. By means of the press plate forming the lower end of the pressure shoe a uniform force transmission is obtained.

Information on labour safety

The pressure elements require a safety guard, they are to be secured against unintended lowering.

Recommendations for maintenance

Make sure that the points of support are regularly lubricated. Immediately remove impurities, especially those of the press plates. Regularly apply parting compounds on the press plate to prevent sticking of glue residues.

Specification

press length 2500...3000 mm

press width 1000...1100 mm

8.7. Sharpening Machines

8.7.1. Ripping Chisel and Plate Iron Sharpening Machine

This machine serves for sharpening mortising, cutting and plane irons and certain

drilling tools.

Construction

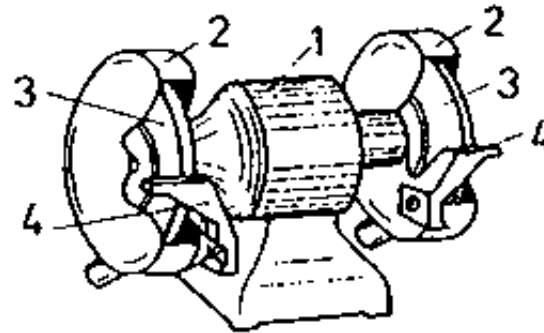

1 driving motor, 2 protective hoods, 3 sharpening wheels, 4 tool rest

Figure 28 Ripping chisel and plane iron sharpening machine

A pedestal of steel or cast steel carries the motor the shaft of which directly drives the sharpening tools. If the machines are designed for wet grinding, the sharpening wheels run through a tray filled with cooling liquid. In most cases the adjustable tool support is provided with a clamping fixture.

Information on labour safety

Take care to ensure that the proper grinding tool is selected. Observe the specified speed of the sharpening tool. Do a test run of the sharpening wheel. Use the safety guards specified.

Recommendations for maintenance

The tool carriers must be clean. Make sure that there is sufficient cooling liquid

available. Check the safety guards for functioning. Regularly clean the machine.

Specification

diameter of the sharpening wheel	≤ 200 mm
speed of the sharpening wheel	≈ 3400 min ⁻¹
grinding speed	≈ 35 m/s
motor power	0.5 kW

8.7.2 Sharpening Machine for Circular and Band Saw Blades

This machine serves for sharpening circular and band saw blades by dry grinding.

Construction

The machine consists of the machine frame and the grinding wheel head which is mounted on the front side of the machine frame and arranged to swivel. Lifting and lowering of the grinding wheel head is effected by means of a cam which corresponds to the tooth shape of the saw blade. Swivelling of the grinding wheel head during angular grinding takes place from a special cam via toothed segment, toothed gear, slider-crank mechanism and lever system. The saw blade is fed by a pushing pawl.

Information on labour safety

Select the appropriate grinding tool and make sure that it is in good condition. Do a test run of the grinding tool. Check whether the safety guards are intact. Wear

protective glasses. When grinding dry, exhaust the grinding dust.

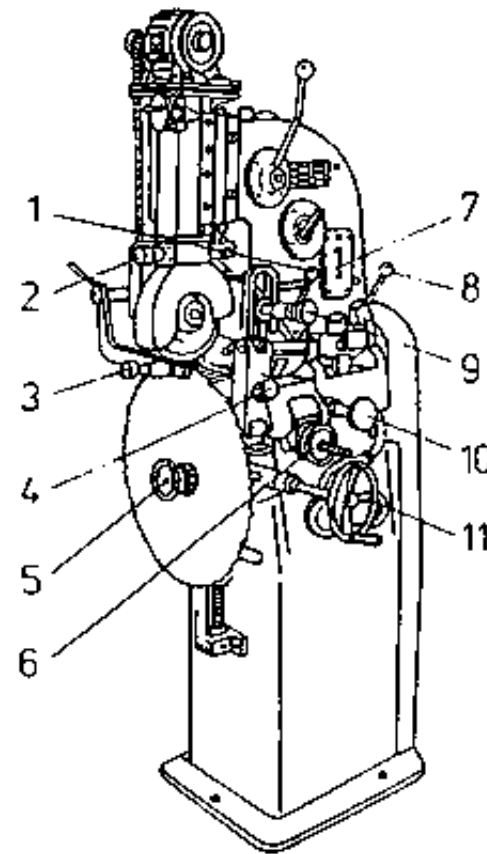

1 cam-operated switch for saw-tooth form, 2 setting for angle of inclination, 3 back pressure facility for the saw blade, 4 feed control, 5 saw-blade clamping, 6 control for the feed rate, 7 oil level indicator, 8 switch for feed rate, 9 stroke height control, 10 adjustment of inclination of grinding wheel head, 11 saw-blade size setting

Figure 29 Sharpening machine for circular and band saw blades

Recommendations for maintenance

Clean the tool carriers regularly. Check the oil level regularly. Lubricate and clean the machine regularly.

Specification

diameter of the circular saw blade	160...1200 mm
width of the band saw blade	≥ 10 mm
saw pitch	5...60 mm
tooth height	3...30 mm
tool orthogonal rake γ	15...30°
tool cutting edge inclination α	8...15°
diameter of the grinding wheel	≤ 200 mm
speed of the grinding wheel	2800 mm ⁻¹

8.7.3 Milling Cutter Sharpening Machine

This machine serves for sharpening all kinds of milling cutters by wet grinding.

Construction

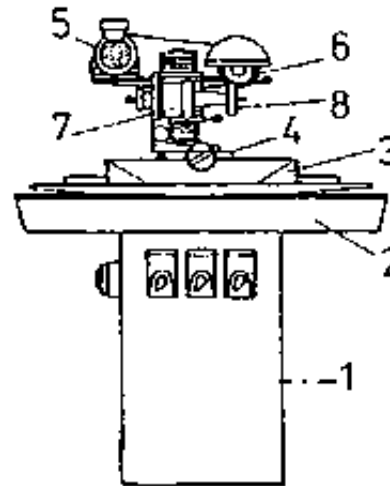

1 machine column, 2 grinding tray, 3 longitudinal slide rest, 4 cross slide rest, 5 sharpening wheel motor, 6 sharpening wheel, 7 tool clamping fixture, 8 tool

Figure 30 Milling cutter sharpening machine

The machine consists of the machine frame which carries the grinding tray with the guideways for the longitudinal slide rest. The longitudinal slide rest is running on rollers. The sharpening wheels are inserted into a chuck and will be replaced with this chuck. So they will always have the same seating in the spindle. The tool clamping fixture can be replaced with another one according to the tool to be sharpened. The machine is equipped with a cooling system and a water splash guard for the operator.

Information on labour safety

Make sure that the proper abrasive tool is selected. Test the abrasive tool in a test run. Exhaust the grinding dust in case of dry grinding. Use a sight screen. The sight screen should be coupled with the switching-off mechanism. Make sure that

safety guards are intact.

Recommendations for maintenance

Like sharpening machine for circular and band saw blades; check the coolant cleaning system regularly for reliability in operation.

Specification

cutter diameter	≤ 200 mm
grinding length	≤ 150 mm
speed of the sharpening wheel	1400; 2800; 3500 min^{-1}
input power for sharpening wheel motor	0.6 kW
input power for feeding motor	0.25 kW
input power for coolant pump	0.13 kW

8.7.4. Blade Sharpening Machine

This machine serves for sharpening machine blades by wet grinding.

Construction

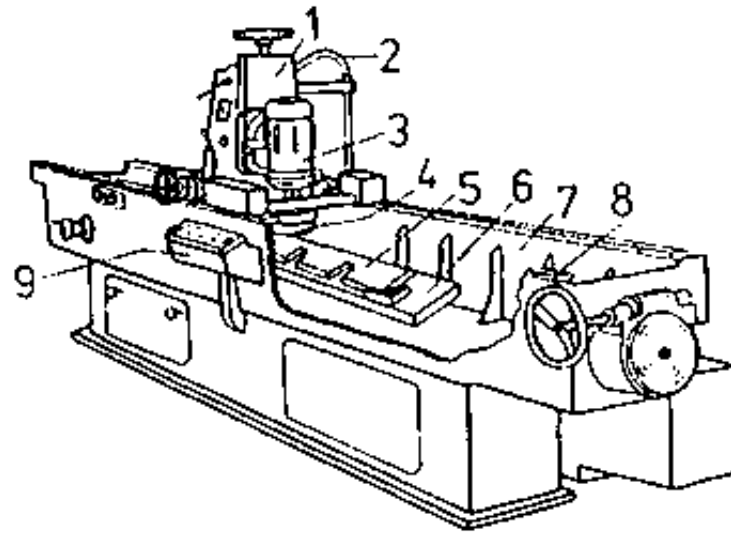

1 mobile grinding unit, 2 coolant line, 3 sharpening wheel motor, 4 sharpening wheel, 5 machine blade, 6 clamping plate for the blades to be sharpened, 7 grinding and cooling tray, 8 guide rails for the grinding unit, 9 control desk

Figure 31 Blade sharpening machine

A heavy column of cast steel carries the guide rails for the mobile grinding unit and encloses the cooling tray with the grinding bed. The blades to be sharpened are fixed on the clamping tray with the grinding bed. The cooling liquid is supplied through the hollow shaft of the grinding motor. The sharpening wheel is fed automatically and steplessly.

Information on labour safety

Select the appropriate grinding tool carefully. Do a test run of the grinding tool. Observe the operating instructions strictly.

Recommendations for maintenance

Clean the clamping plate each time before a blade is to be mounted. Make sure that the guide rails for the sharpening unit are absolutely clean. Check the coolant cleaning system for operational reliability. Regularly lubricate and clean the machine.

Specification

grinding length	800...4500 mm
blade width	≤ 250 mm
feeding speed of the grinding unit	8...16 m/min
grinding speed	≈ 30m/s
diameter of the sharpening wheel	175...200 mm
grinding infeed	0.002...0.3 mm
input power for the sharpening wheel motor	3.0...5.0 kW
input power for the travelling drive	≈ 0.75 kW
input power for the coolant pump	≈ 0.1 kW









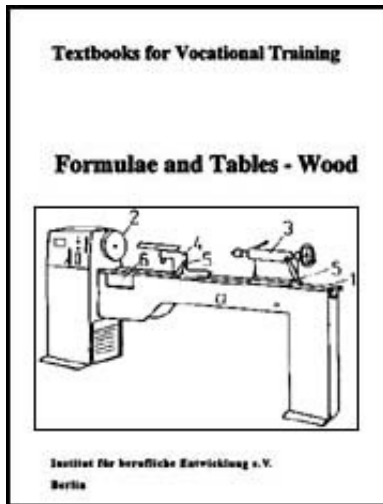

[Home](#) > [ar](#) [cn](#) [de](#) [en](#) [es](#) [fr](#) [id](#) [it](#) [ph](#) [po](#) [ru](#) [sw](#)

 **Formulae and Tables - Wood / textbooks for vocational training (GTZ, 122 p.)**

  **9. Tools**



-  **(introduction...)**
-  **9.1. Tools for Circular Sawing Machines**
-  **9.2. Tools for Table Band Sawing Machines**
-  **9.3. Tools for Smooth and Thicknessing Millers**
-  **9.4. Tools for Shaping Machines**
-  **9.5. Tools for Slot Milling Machines**
-  **9.6. Tools for Drilling Machines**
-  **9.7. Tools for Sanding Machines**
-  **9.8. Tools for Sharpening Machines**

Formulae and Tables - Wood / textbooks for vocational training (GTZ, 122 p.)

9. Tools

Machine tools are working tools which are held or fixed on spindles and shafts or in chucks and holders.

9.1. Tools for Circular Sawing Machines



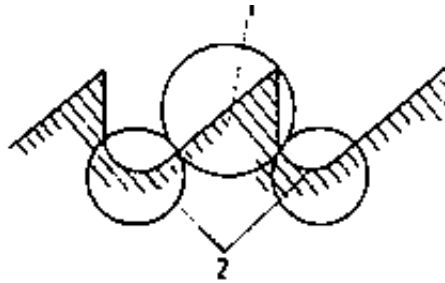











Circular saw blades are toothed steel disks with a diameter of 80 to 800 mm, a hole having a diameter of 10...40 mm in the middle of the disk and a disk thickness of 0.8...3.4 mm.



1 tooth (sur) face, 2 tooth gullet

Figure 32 Tooth form

Construction of the tooth faces and tooth gullets

Number of cutting edges per tooth	1	1	1	1	1	1
Representation						
Symbol Name	N acute-angled tooth	K gullet tooth	p raven beak tooth	A triangular tooth	Y roof-shaped tooth	S -
Number of cutting edges per tooth	2	2	2	2	3	
Representation						
Symbol	X	M	Z	B	W	
Tooth gullets						
Representation						

Symbol	C	V		U		
--------	---	---	--	---	--	--

Tooth forms are designated by two letters, the first of which designates the form of the tooth face, the second one the form of the tooth gullet.



Figure 33 Designation of the tooth form NV

Number of saw teeth and saw pitch

The saw pitch is the spacing between two successive primary cutting edges, the saw pitch can always be divided by two.

Number of teeth (z) and saw pitch (t) of circular saw blades

Diameter in mm	KV teeth		NV teeth $\gamma > 0^\circ$		NV teeth $\gamma = 0^\circ$		AV teeth	
	z	t	z	t	z	t	z	t
	in mm		in mm		in mm		in mm	
80			64	4.2				
100			64	5.2				
125			80	4.9				
160			80	6.3				

200			80	7.8	80	7.8		
250			80	10	80	10		
300	56	17	80	12	80	12	72	13
350	56	20	64	17	64	17	72	15
400	56	22	64	20	64	20	72	18
450	56	25	64	22	64	22	72	20
500	56	28	64	25	64	25	72	22
550	56	31	64	27	64	27	72	24
600	56	34	64	30	64	30	72	26
650	56	36	64	32	64	32	72	28
700	56	39	64	35	64	35	72	31
750	56	42	64	37	64	37	72	33
800	56	45	64	40	64	40	72	35
Application	for longitudinal cuts at normal load with manual feed	for longitudinal cuts at normal load in hard and soft wood with manual feed			for cross cuts at normal load in hard and soft wood with manual feed		for cross cuts at normal load and with manual feed	

Recommended values for cutting edge angles

Cutting direction	Application	Tooth form	Tool orthogonal rake γ in $^{\circ}$	Wedge angle β in $^{\circ}$	Plan angle χ in $^{\circ}$	Setting width a in mm
-------------------	-------------	------------	---	-----------------------------------	---------------------------------	-----------------------

longitudinal cutting	hard wood	KV, PV	22	46	87	0.35
		NV	18	40	87	0.35
	softwood	NV, KV	28	40	87	0.45
	dry	PV				
	softwood	NV, KV	28	40	87	0.45...0.40
	damp	PV				
cross cutting	hard	NV	19...2	35...48	65...70	0.45
	and softwood	AV	-10...-38	40...58	65...70	0.25

Information on labour safety

Use only unobjectionable saw blades. Do not exceed the speed indicated on the tools. Replace dull, resinified tools. Check sharpened tools in a test run for running accuracy. Do not change the tool geometry. Use suitable tool containers for transporting circular saw blades.

Recommendations for maintenance

Clean the tools before using them. Protect the saw blades against rust by means of an acid-free grease. Store circular saw blades by hanging them up in the bore. In doing so, protect the cutting edges by layers of cardboard or similar.

9.2. Tools for Table Band Sawing Machines

Band saw blades for table band sawing machines are 10 to 40 mm wide endless steel strips which are toothed on one side. They have a thickness of 0.4 to 0.8 mm and a setting width of 1.0 to 1.3 mm.

Recommended values for band saw blades

Saw pitch t in mm	Tooth height h in mm	Setting width a in mm	Tool orthogonal clearance α in $^{\circ}$	Wedge angle β in $^{\circ}$	Tooth form	Application
12	4...5	0.4...0.5	20	45	NV	for sawing soft wood
10	3...4	0.3...0.4	30	55	NV	for sawing hard wood
8	3	0.3	30	55	NV	for sawing laminated wood, sandwich, particle and fibre boards

Information on labour safety

Replace dull and resinified saw blades or clean and sharpen them. Never use cracked or badly soldered saw blades. Do a 5 minute test run of freshly soldered or welded saw blades before using them for the first time. Soldering and welding points must not be thicker than the saw blade.

Recommendations for maintenance

Clean dirty saw blades with solvents and slightly grease them against rust with

acid-free grease. Keep saw blades in hanging position (teeth towards the wall). When soldering cracked saw blades, cut the free ends rectangularly, bevel them over 10 to 15 mm, file smoothly on both sides after soldering and grind to the normal blade cross-section.

9.3. Tools for Smooth and Thicknessing Millers

Smooth and thicknessing millers are equipped with blade shafts. Blade shafts consist of a cylindrical body with locating spigot, they are 250...1600 mm long and their cutting circle diameter is 60...224 mm. The stripe irons for tipping the blade shaft have cross-sections of 30 mm x 1.8 mm to 43 mm x 2.2 mm and lengths of 200 mm to 810 mm.

Recommended values for cutting-edge angles on stripe irons:

tool orthogonal rake γ in $^{\circ}$ 30...40

tool orthogonal clearance α in $^{\circ}$ 4...18

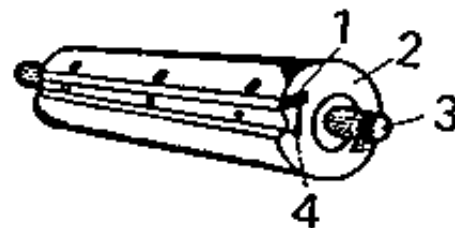

*1 stripe iron, 2 blade shaft body,
3 locating spigot, 4 taper gib strip*

Figure 34 Blade shaft

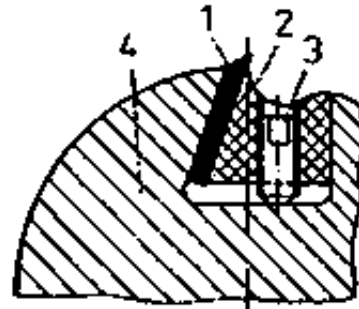

1 stripe iron, 2 taper gib strip, 3 locking screw, 4 blade shaft

Figure 35 Mounting of the strip irons on the blade shaft

Information on labour safety

For smooth milling machines only cylindrical blade shafts with taper gib strips are permitted. The blades of smooth milling machines project beyond the body of the blade shaft by 1.1 mm at the most. In case of smooth milling machines make sure that the permissible weight difference of opposite blades is kept. The cutting speed of 40 m/s must not be exceeded. Retighten the fastening screws for the blades after a test run of 2 minutes. Tighten the locking screws of the blade shafts alternately little by little starting from the middle. The lips of the blade shafts must be close on the blades. The blades must not be backed-up.

Recommendations for maintenance

Seatings and clamping surfaces for blades and clamping elements must be absolutely clean when the blades are inserted. When replacing cutting elements, make sure that the tool bore holes are clean. The tool geometry of the blades must not be changed. Clean the tools from sticking dirt after using them, protect bare parts against rust

9.4. Tools for Shaping Machines

Tools for shaping machines may be solid or sectional. They have diverse shapes and are provided with a bore hole for the cutter arbor.

Solid milling tools

As far as solid milling tools are concerned, body and cutting edge are made of one and the same material and are integral. If the cutting edge consists of a different material, it is permanently connected with material closure with the body.



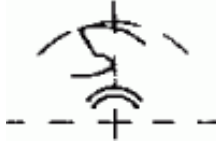
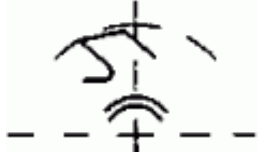

Arbor cutters





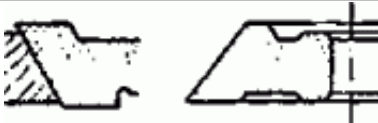

Form of the flank

Crown cutter	Relief-turned cutter	Relief-milled cutter or relief-ground cutter
		
<p>the flank is hollow-ground, so that symmetrical pairs of cutting edges are produced</p>	<p>the flank is curved (relief-turned) so that there will be no friction between tool (flank) and workpiece</p>	<p>the flank is straight (by relief milling or relief</p>

		grinding)
for operations requiring a change of the direction of rotation of the tool; it is disadvantageous that the unused cutting edge is rubbing against the workpiece and gets dull as a result of this	mainly for rebating and form milling tools; to maintain the profile regrinding is made only at the tool face	mainly for grooving cutters

Kinds

Kind of cutter		Dimensions in mm	
jointing cutter		diameter	63...80
		working width	28...63
rebating cutter		diameter	63...180
		working width	16...40
bevelling cutter		diameter	70...180
		working width	12...45
half astragal cutter		diameter	63...160

		working width	11 ...90
quarter astragal cutter		diameter	63...180
		working width	8...51
moulding cutter		diameter	63...140
		working width	2.5...25
half moulding cutter		diameter	63...180
		working width	8 ...51
cornice cutter		diameter	100...180
		working width	22...65
grooving cutter		diameter	80...125
		working width	4...14
cornice cutter with plate		diameter	80...200
		working width	12...42

Recommended values for cutting-edge angles on relief-turned and relief-ground cutters

Application	Tool orthogonal clearance α in $^{\circ}$	Tool orthogonal wedge angle β in $^{\circ}$	Tool orthogonal rake γ in $^{\circ}$
Softwood			
cutting direction A	6...10	40...50	30...45
cutting direction B	8...15	45...55	20...35
cutting direction C	4...8	45...55	25...40
Hardwood			
cutting direction A	8...12	45...55	25...35
cutting direction B	8...12	55...65	15...25
cutting direction C	6...10	55...60	20...30
chip board, uncompressed laminated wood	5...10	55...60	20...25
hard fibre board, compressed laminated wood	5...10	60...65	15...20

Sectional milling tools

Sectional milling tools consist of a body and cutting and clamping elements. Only in combination they form a specific tool.

Tool	Dimensions in mm	Application
------	------------------	-------------

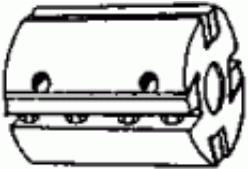
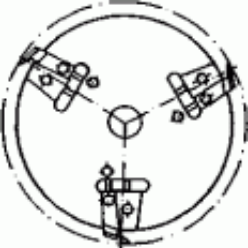
Tool	Dimensions in mm		Application
cutter head	diameter	80...100	mainly for machining narrow surfaces,
	cutting-edge length	80...125	depending on the construction of the cutter and the body also for grooving, rebating and shaping
cutter disk (slotted disk)	diameter	200...450	mostly equipped with two cutters for making
	cutting-edge length	6... 20	of grooves, but especially for slotting (mortise and tenon joints)

Compound milling tools

Compound milling tools consist either of different single cutters or of a set of single cutters of one the same kind. They are provided for a specific work task. Any change of the form or dimension of the profile to be made requires a change of the tool.

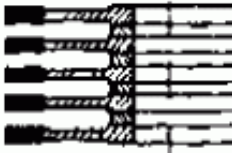
Tool	Components	Application
dovetail cutting set 	grooving cutter and spacing collars	for dovetailing diameter 100...200 mm
cutter combination for	one rebate cutter	for milling of casement wood; today mostly

the manufacture of windows

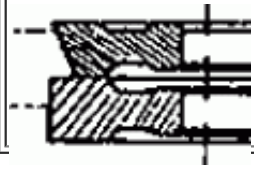

and one bevel cutter

cutter heads with profile cutters are used for this purpose

Recommended values for cutting-edge angles

Kind of tool	Tool orthogonal rake γ in $^{\circ}$	Tool orthogonal clearance α in $^{\circ}$
cutter heads	30...40	4...18
cutter disks	37...45	15

Information on labour safety

Note maximum permissible tool speeds. Use collets only if they have a collar and are inserted into the tool from both sides. Use upper bearings depending on the tool size.

Figure 36 shows the use of upper bearings. Work without upper bearing only within the hatched fields. Work with upper bearing only below the curves I to IV. Never work above the curves. When the upper cutting edge of the tool lies more than 100 mm above the table surface, work also with upper bearing.

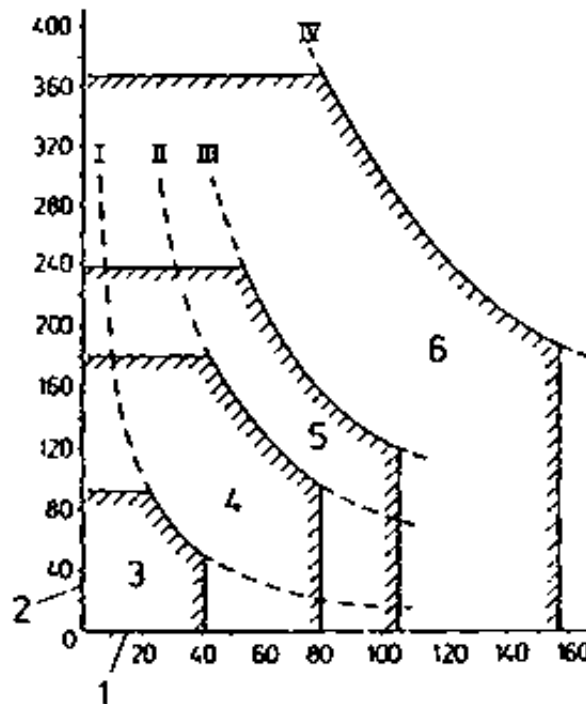

1 width of cut in mm, 2 tool diameter in mm, 3 cutter arbor diameter 16 mm, 4 cutter arbor diameter 25 mm, 5 cutter arbor diameter 30 mm, 6 cutter arbor diameter 40 mm

Figure 36 Use of upper bearings

Tools with visible wear and damage are not permitted for use. The damp nut must be held with all threads by the thread of the tool holder. It must be designed as concentric nut with double-ended flattening for the wrench jaw in case of cutter arbors. Note permissible tool dimensions. Locking screws must be covered or recessed. Do not change the tool geometry.

See also hints on tools for smooth and thicknessing millers.



Recommendations for maintenance

Carefully clean the tool after use. Protect bare parts against rust. Protect tool bore holes and tool shanks against any impurities. Keep the tools in suitable cases ensuring protection of the cutting edges. See also hints on tools for smooth and thicknessing millers.

9.5. Tools for Slot Milling Machines

Tools for slot milling machines are shank cutters with one or two cutting edges.

Shank cutters for slot milling machines

Tool	Dimensions in mm		Remarks
slotting mill with one flute 	diameter	4...16	single-edged with trough round shank
	cutting edge length	10...18	
slotting mill with two flutes 	diameter	3...50	with through and with stepped round shank
	cutting edge length	42...230	

Recommended values for cutting-edge angles of slotting mills

Tool	Tool orthogonal wedge angle β in $^\circ$	Tool orthogonal rake γ in $^\circ$
Slotting mill	70...79	11...20

Information on labour safety

Do not use any tools showing visible wear or damage. Mount the tool safely. Locking screws must be covered or recessed. Do not change the tool geometry. Work with guard bonnet over the drill chuck. Observe the specified shank diameter of the tool.

Recommendations for maintenance





Keep the jaw chuck and tool shanks clean. Check the work clamping device regularly for proper functioning. Lubricate according to the lubrication chart. Regularly clean and grease the guide rails and lever mechanism.

9.6. Tools for Drilling Machines

Tools for drilling machines are rod-shaped cutting tools with front cutting edges and with shank for mounting in the drill chuck.

Kinds of drilling tools

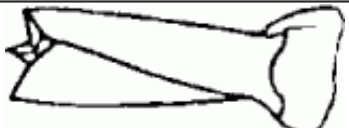
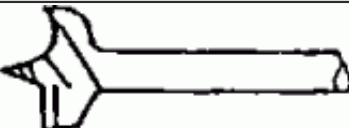
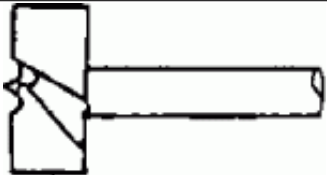
Tool	Dimensions	in mm	Application
auger bit	diameter	6...40	especially for hand drilling units and deep

			holes, mostly with 1 or 2 taper tap(s)
	thread length	78...1000	
twist drill with roof-shaped point	diameter	3...8.3	for bore holes into hard wood and end-grained wood, mostly as dowel hole drill
	thread length	42...70	
twist drill with centre point	diameter	4...50	for clean and accurate bore holes vertically to the wood fibre
	thread length	45...230	
centre bit	diameter	8...50	with centre point and taper tap; for bore holes vertically to the fibre direction
	length	80...140	
Forstner bit	diameter	8...40	for sinking dimensionally stable blind holes with even bore bottom, e.g. knot bore holes
	length	80...125	
countersink	diameter	3...10	countersinks serve for making screw head counter sinks
	length	90	



Recommended values for cutting edge angles on drilling tools

Kind of drill	tool orthogonal clearance α in $^{\circ}$	Wedge angle β in $^{\circ}$	Drill point angle ϵ_B in $^{\circ}$
auger drill	15	25	180
twist drill with centre point	12	45	90
twist drill with roof-shaped point	15	45	100...125 or 180
centre drill	20	25	180
Forstner bit	20	30	180

Information on labour safety

When using drilling tools which are operated with a peripheral speed > 6 m/s for the first time, do a test run of at least 1 minute. In doing so, cover the area of danger. All locking bolts at the drill chuck must be covered or recessed. The drill chuck must be firmly seated and well balanced. The safety guards must be adjustable to different height and depth settings of the drills.

Recommendations for maintenance

Take care to keep the tool shanks and drill chucks clean. After use clean the tools

carefully. Do not use any metal objects for cleaning the tools. Store and transport the tools in such a manner that the cutting edges cannot be damaged.

9.7. Tools for Sanding Machines

Tools for sanding machines are flexible sanding tools. They are used for wood and lacquer sanding. They are compound tools with geometrically indeterminate cutting edges which consist of a flexible base body, a bonding material and the abrasive material.

Construction of flexible sanding tools

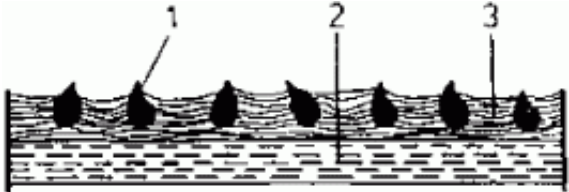
Component	Function
base body	The base body carries the abrasive material, has a high strength and high flexibility.
	 <p><i>1 abrasive material, 2 base body, 3 bonding material</i></p>
abrasive material	Abrasive materials are the cutting edge bearing abrasives, they perform the actual cutting operation.
bonding material	Bonding materials serve for attaching the abrasive materials to the base body.

Kinds of base bodies

Kind	Stress level
light papers made of soda pulp	low
compressed, sized papers made of soda pulp	higher
combination of paper and fabric	high
linen fabric	very high
combination of fabric and fibre	very high
fibre	highest

Abrasive material

Kind	Symbol	Application
regular corundum	NK	for soft wood and rough plastic sanding
semi-precious corundum	HK	for soft wood and rough lacquer sanding
precious corundum	EK	for hard wood, lacquers, plastics
silicon carbide	SC	for face veneer and polyester lacquers

Grain sizes of flexible sanding tools

Grain group	Designation	Grain size of the main fraction in μm	Grain group	Designation	Grain size of the main fraction in μm
fine as dust	F 3	3.0 ± 0.5	fine	10	100...125
	F 5	4.5 ± 0.8		12	125 160

		7.5 ± 0.5		12	125...100
	F 7	6.5 ± 1.0		16	160...200
	F 9	9.5 ± 1.0		20	200...250
	F 13	13.0 ± 1.8	medium fine	25	250...315
	F 17	17.5 ± 2.0		32	315...400
	F 23	23.0 ± 2.5		40	400...500
	F 29	29.5 ± 3.0		50	500...630
	F 37	36.5 ± 1.5	coarse	63	630...800
	F 45	44.5 ± 2.0		80	800...1000
	F 53	53.0 ± 3.0		100	1000...1250
very fine	4	40...50		125	1250...1600
	5	50...63	very coarse	160	1600...2000
	6	63...80		200	2000...2500
fine	8	80...100		250	2500...3150

Spreading densities of flexible sanding tools

Designation	Symbol	Explanation	Application
closed spreading density	cl	There lies grain next to grain partly also one above the other	for very hard materials and small amounts to be removed.

half-open spreading density	ho	small spacing between the grains, the spacing is smaller than the grain diameter	for hand sanding; when sanding is made by machine for hard wood, plastics and lacquers
open spreading density	op	The grain spacing is greater than the grain diameter	especially for sanding soft and resin-containing wood

Information on labour safety

Do not use any worn abrasive belts. Abrasive belts must not be tarnished because of the danger of rupture. Keep the running direction printed on.

Recommendations for maintenance

Carefully suck abrasive belts in the interest of prolonged between-grind life. Store flexible sanding tools at a temperature of 16...22 °C and a relative air humidity of 50...55 %.

9.8. Tools for Sharpening Machines

Tools for sharpening machines are solid abrasive tools. They are multi-cut chip-forming tools with geometrically indeterminate cutting edges, consist of the abrasive body, the bonding material and have a porous structure.

Name	Symbol	Application
normal corundum	NK	sharpening of tools made of tool steel
semi-precious	HK	same as normal corundum

corundum		
precious corundum	EK	sharpening of tools made of tool steel and high-speed steel
ruby corundum	RK	sharpening of tools made of tool steel, high-speed steel and high-alloyed steel
diamond	D	for dressing solid abrasive tools

Bonding materials for solid abrasive tools

Kind of bonding		Properties and application
vitriified bond	ceramic	unlimited storage stability, sensitive to breakage, shock and impact, sharp, most frequently used kind of bonding
	magnesite silicate	limited storage stability, low strength, good self-sharpening, for sharpening instruments
organic bond	rubber synthetic resin natural resin	very elastic, hardly any danger of breakage, good cutting capacity, high peripheral speed possible, well suitable for thin-walled abrasive tools (abrasive cutting tools)

Grain sizes of solid abrasive tools*)

*) See also under 9.7. Grain sizes of flexible sanding tools

Grain group	Grain size 1/100 mm	Application
coarse to medium	80...50	grinding of shank materials

medium	40...32	rough grinding of tool cutting edges
medium to fine	25...16	finish grinding of tool cutting edges
fine	12...8	superfine grinding
very fine	4...3	for whetting and honing

Hardness of solid abrasive tools (selection)

Designation	Symbol	Application
very soft	H	blades for cutter heads, stripe irons
soft	i	blades for cutter heads and cutter block spindles, milling cutters
	Jot	like under i, and drills
	K	like under Jot
medium	L	milling and drilling tools
	M	milling and drilling tools, saw blades
	N	like under M
hard	S	dressing bodies for solid abrasive tools

Selection of typical solid abrasive tools and their application

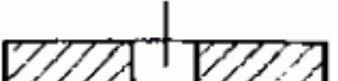
Kind of tool	Abrasive material	Grain size	Hardness	Application
	NK	20...32	M	hand grinding; plane iron and ripping chisel sharpening machine

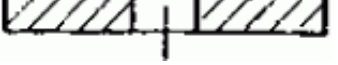
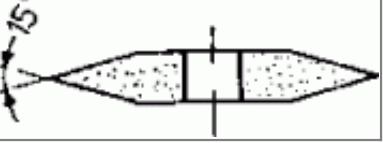
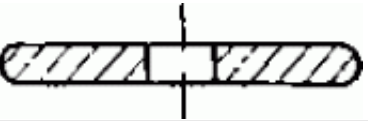
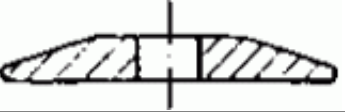
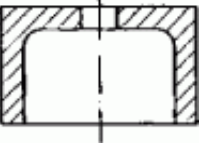
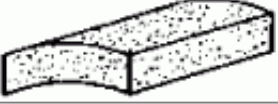
				
chamfered on both sides 	NK	20...40	M	saw sharpening machine
round on both sides 	NK	20...40	M	saw sharpening machine
chamfered on one side 	NK	20...40	M	saw sharpening machine
cylindrical cup wheel 	EK	63	H	blade sharpening machine
segmental tool 	RK/EK	40...50	H	blade sharpening machine
tapered cup wheel	EK	25...32	Jot...N	cutter sharpening machine

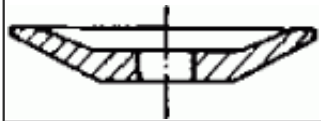
				
	EK	25...32	Jot...N	cutter sharpening machine

Information on labour safety

Carefully select the proper sharpening wheel. Do an obligatory test run with every abrasive tool. Observe strictly the specified maximum speeds. Use only well balanced abrasive tools.

Recommendations for maintenance

Keep solid abrasive tools in a hanging position. Mounting of the abrasive tools must be done with greatest care. Use only abrasive tools provided with all necessary specifications. Redress solid abrasive tools in time (to ensure true running).



[Home](#) > [ar.cn.de.en.es.fr.id.it.ph.po.ru.sw](#)

 **Formulae and Tables - Wood / textbooks for vocational training (GTZ, 122 p.)**

  **10. Setting-up of Tools**

 **10.1. Setting-up of Hand Tools**

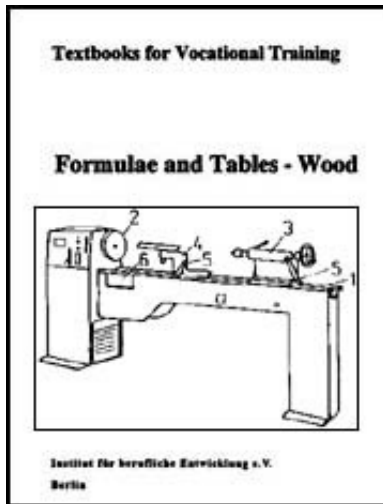

10.2. Setting-up of Machine Tools

Formulae and Tables - Wood / textbooks for vocational training (GTZ, 122 p.)

10. Setting-up of Tools

10.1. Setting-up of Hand Tools

Setting-up of hand saws

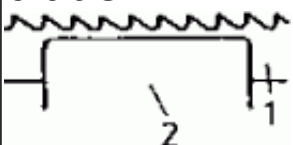
Operation Representation	Aids/tools	Remarks
cleaning of the saw blade	petroleum thinner	Remove glue residues, resin residues and similar
clamping of the saw blade 	hand vice	Clamp the saw blade horizontally, closely below the tooth gullet line.

1 saw blade, 2 hand vice

checking of the top line

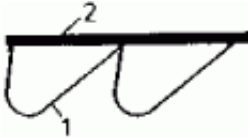

1 saw blade, 2 glass plate

small glass plate or similar

Differently long teeth lead to running-off centre of the saw; the saw blade is jolting during sawing.

dressing of the saw blade

clamped flat file

File a uniform tooth line.

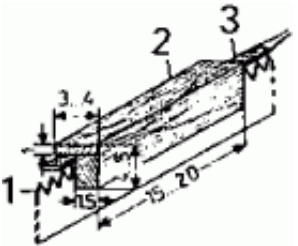

1 saw blade, 2 gauge made of wood (dimensions in cm), 3 flat file

checking of the tooth form

sheet-metal template for tooth - forms

Find out which teeth are to be corrected.

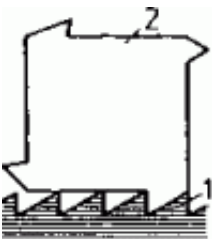

1 saw blade, 2 plate template

corrective filing of such teeth which deviate in form and size

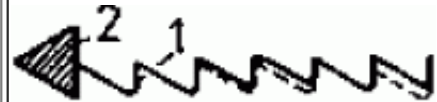

1 saw blade, 2 saw file

saw file

Hold the file horizontally and at right angles to the saw blade.

reclamping of the saw blade for saw setting with the saw set

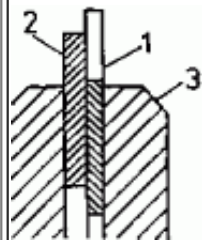

1 saw blade, 2 stop bar, 3 hand vice

hand vice and stop bar

The teeth uniformly project 1/3 of their height beyond the stop bar.

saw setting with the saw set

saw set

At first set every other tooth to one side and then - after resetting the bar and the saw blade - the rest of the teeth uniformly to the other side.

The clearance of the saw blade in the saw set slot is ≥ 0.1 mm; amount of deflection: 1/2 saw blade thickness

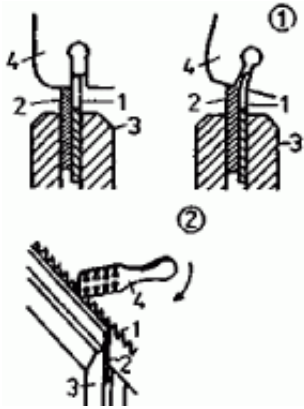

(1) schematic representation
 (2) representation showing the principle of operation
1 saw blade, 2 stop bar, 3 hand vice, 4 saw set

to each side.

saw setting with saw set pliers

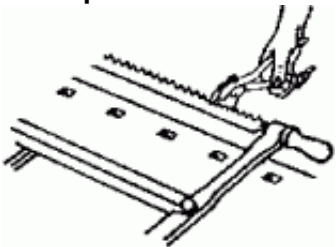

saw set pliers

Set the setting height and amount of deflection (setting width) on the saw set pliers. Mount without rule.

checking of the setting width

saw setting gauge

Move the saw-setting gauge with the recessed edge past the teeth in the blade plane.

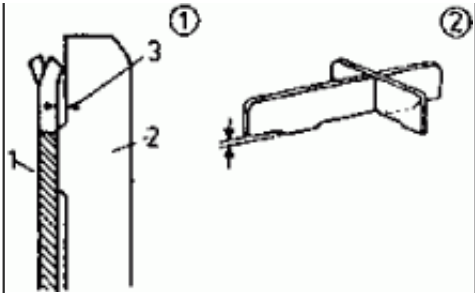

(1) Schematic representation
 (2) Representation showing the principle of operation
1 saw blade, 2 saw setting gauge, 3

setting width
 correction of incorrectly set teeth

saw set or saw set pliers

Reset or further deflect the teeth concerned by the amount necessary.

equalizing

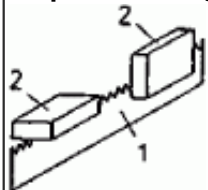

1 saw blade, 2 saw setting gauge, 3 setting width

flat file or hone

Slightly "equalize" on the tooth line and at the tooth profile before sharpening to compensate the different resetting ability of the saw teeth.

sharpening (filing) of the saw blade

sharpening file

Clamp the saw blade into the hand vice; tooth gullet line at the most 5 mm above the jaws. Hold the file exactly horizontally and at right angles to the saw blade; the

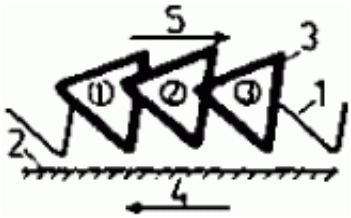

1 saw blade, 2 hand vice, 3 sharpening file, 4 direction of pushing, 5 direction of filing

same number of file strokes in every tooth space. File against the direction of the cut, move the file with uniform pressure. The tooth is sharp, when the tooth crest is not bright any more, but appears dull. File cutting face and flank uniformly.

Mistakes made when setting-up hand saws

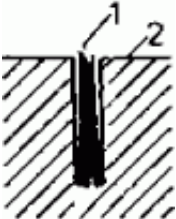
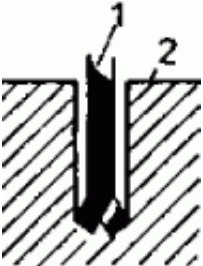
Kinds of mistake Representation	Effects of the mistake
missing or too small tooth set  <p>1 saw blade, 2 workpiece</p>	the saw is jamming or drifting
too large tooth set  <p>1 saw blade, 2 workpiece</p>	unclean cut and bad guidance of the saw

one-sided tooth set

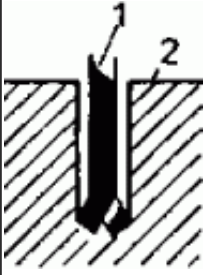

1 saw blade, 2 workpiece

the saw deviates from the true course

tooth set too deep (whole tooth height deflected)

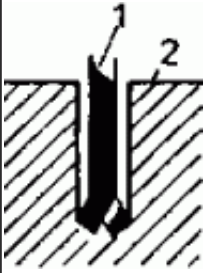

1 saw blade, 2 workpiece

danger of cracking at the tooth gullet; insufficient stability of the saw blade

filing into the direction of the cut

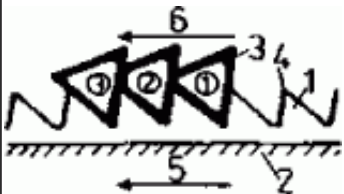

1 saw blade, 2 hand vice, 3

the burr forming at the primary cutting edge acts in the direction of the flank and reduces the cutting effect

*sharpening file, 4 filing burr, 5
direction of pushing, 6
direction of filing*

canting on the sharpening file



1 saw blade, 2 sharpening file

chip removal at the flank or cutting face too great;
differences in the tooth height and wedge angle occur;
cutting capacity is reduced, as only a part of the teeth is
working; the saw is hacking

deviation of the file position
from the horizontal

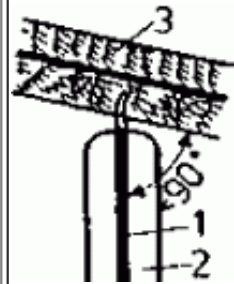

*1 saw blade, 2 hand vice, 3
sharpening file*

chamfering of the flank, change of the tooth height,
reduction of the cutting effect

file position not at right
angles to the saw blade

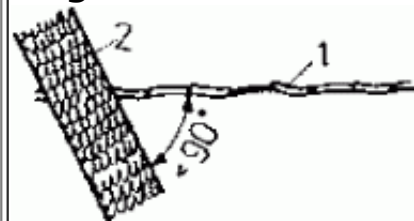

chamfering of the flank, change of the tooth height,
reduction of the cutting effect

1 saw blade, 2 sharpening file

Setting-up of plane irons and chisels

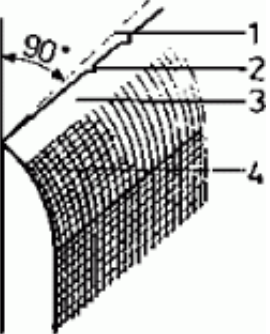
Operation representation	Tools/aids	Remarks
cleaning of the plane iron and the flap or chisel	petroleum or similar	Remove resin and glue residues.
Checking of observance of safety regulations		Use safety goggles or safety glass. Spacing between tool support and abrasive tool must be correct. Mounting flange diameter must be correct. Observe maximum permissible peripheral speed of the abrasive tool. Do test run of the abrasive tool.
Checking of the cutting edge  <p><i>1 cutting edge not at right angles, 2 jagged</i></p>		Sharpen only when it is not possible any more to get a good cutting edge by dressing.

cutting edge, 3 dull cutting edge (bright edge), 4 cambered (round) land

clamping of the plane iron

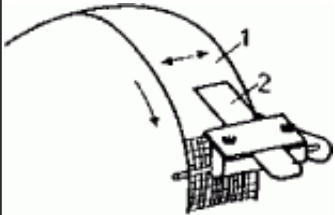

1 sharpening wheel, 2 plane iron

plane iron and ripping chisel sharpening machine

Firmly clamp the plane iron into the carriage, grind against the direction of rotation of the wheel.

setting of the angle of support of the tool support

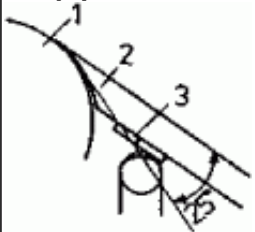

1 sharpening wheel, 2

plane iron and ripping chisel sharpening machine

plane iron rest is sufficient; setting e is to be made in such a way that the correct wedge angle (27°) is reached.

Cool the plane iron.

plane iron, 3 support

for plane iron

reduction of the land
width

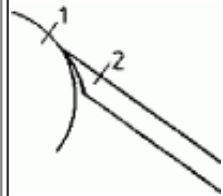

*1 sharpening wheel, 2
plane iron*

plane iron
and ripping
chisel
sharpening
machine

This is necessary, if the wedge angle is too small.
Cool the plane iron.

increase in the land
with

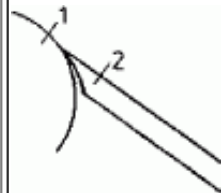

*1 sharpening wheel, 2
plane iron*

plane iron
and ripping
chisel
sharpening
machine

This is necessary, if the wedge angle is too great.
Cool the plane iron.

sharpening of the
ripping chisel (straight
flank)

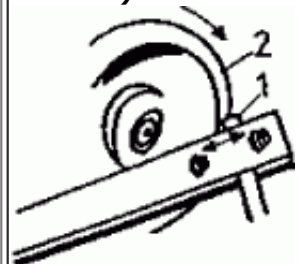

1 ripping chisel, 2 cup

sharpening
machine
and cup
wheel

Clamping fixture is necessary. The straight flank
produces a completely wedge-shaped cutting edge. It
penetrates better into the wood.

wheel

sharpening of turning tools (like ripping chisel with straight edge)

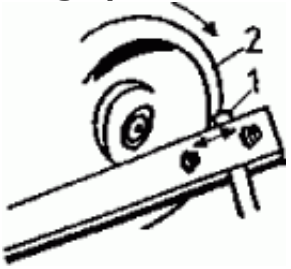

sharpening machine and cup wheel

Clamping fixture is not absolutely necessary; tool support is sufficient, because due to the greater wedge angle of the tool cutting edge (see 7.4.) the angle of inclination of the tool to the sharpening wheel is considerably flatter than for the ripping chisel.

honing of plane irons and ripping chisels

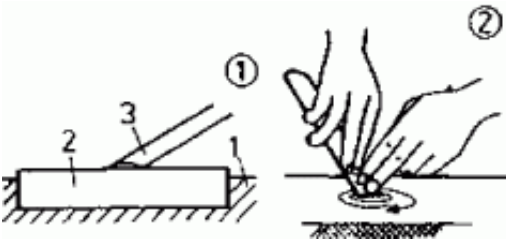

(1) Schematic representation
 (2) Representation of principle operation
1 wooden strip, 2 inserted hone, 3 plane iron

hone

Clamp the hone in position, firmly put on the land of the tool, hone with circular movements over the whole surface of the hone. Hone alternately the land and the minor surface of the tool, until the sharpening burr falls off by itself.

Honing of turning tools

hone

Turning tools are honed by means of round, half-round or shaped stones.

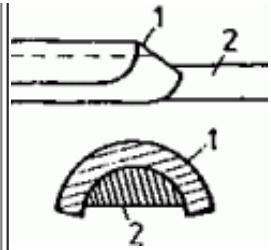

1 turning tool, 2
Setting-up of the plane
shaped stone
iron flap

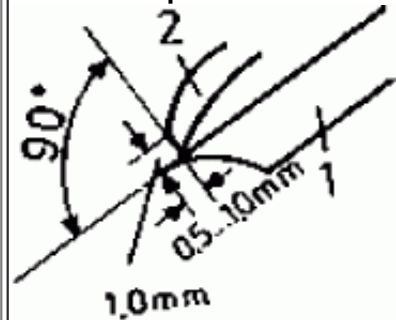

1 plane iron, 2 flap

Move the stone on the tool.

sharpening
file, hone

File the front edge of the flap until it is at right angles to the central axis of the flap, has a width of 1 mm over the whole of its length, firmly rests on the minor surface of the tool after tightening the screw, has a uniform spacing to the cutting edge of 0.5... 1.0 mm; polish the bun edge brightly with a very fine hone.

Setting-up of the scraper

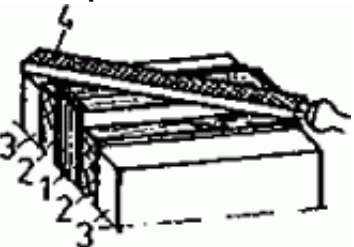
Operation representation	Tools/aids	Remarks
filing of the scraper  <p>1 pack of scrapers,</p>	vice, 2 hard wood blocks, flat finishing file	Clamp packs of several pieces between 2 hard wood blocks in the vice, align the edges in one plane, file the edges to be rectangularly even, longitudinal direction must be exactly straight, slightly round the comers.

2 work supporting block, 3 hand vice, 4 flat file

Honing of scrapers

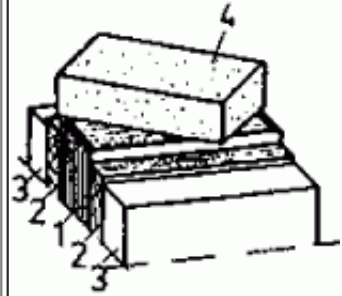

1 pack of the scrapers, 2 work supporting block, 3 hand vice, 4 hone

coarse hone

Regrind the pack of filed scrapers by circular movement until the surface is completely smooth.

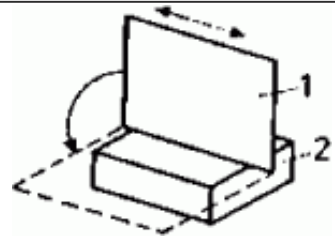

1 scraper, 2 hone

fine-grain hone

Hone the narrow and broad sides until the burr is completely removed and the edges are sharp-edged.

scraping off of the scraper

scraper steel

Place the scraper steel evenly on the scraper. Scrape off the surfaces under pressure from the centre outwards.

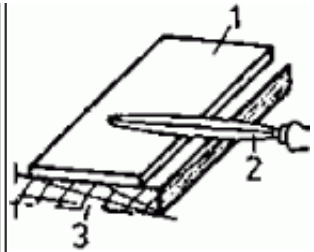

1 scraper, 2
scraper steel, 3
cutting burr

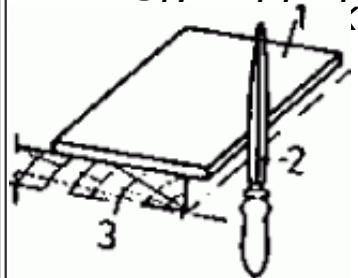

1 scraper, 2
scraper steel, 3
supporting block

resharpening of
the scraper

scraper
steel

Scrape the edge of the scraper with the scraper steel under moderate pressure. This produces a cutting burr. The burr can be enlarged by scraping several times.

scraper
steel

A dull burr can be scraped off with the scraper steel and renewed several times, before filing becomes necessary again (round edges).

Setting-up of drilling tools

Operation representation	Tools/aids	Remarks
cleaning of drills	petroleum or similar	Remove impurities (resin residues etc.).
sharpening of the	sharpening	File and hone the centre point uniformly from all sides until

centre point

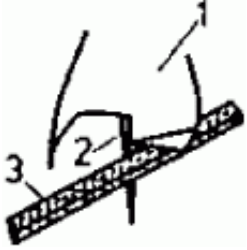

1 drilling tool, 2
centre point, 3
sharpening file

file, hone

all file traces are removed.

no filing of the
infeed thread

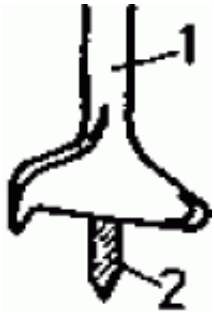

1 drilling tool, 2
infeed thread

sharpening of
entering taps

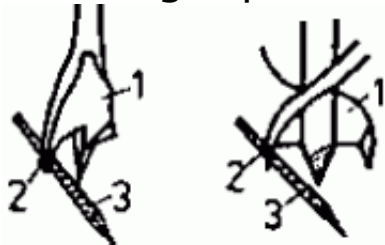

1 drilling tool, 2

sharpening
file, hone

File the entering taps only from inside, then hone until all
file traces are removed.

*entering tap, 3
sharpening file*

sharpening of lips

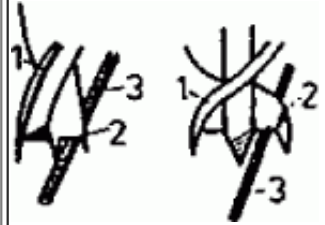

*1 drilling tool, 2
lip, 3 sharpening
file*

sharpening
file, hone

File lips from below, do not interrupt the connection between the lips and the infeed thread, hone carefully.

sharpening of
twist drills with
roof-shaped point

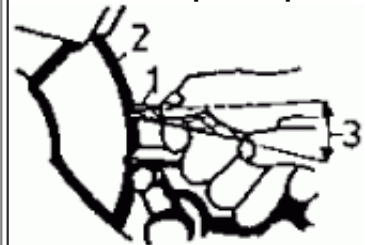

*1 twist drill with
roof-shaped
point, 2
sharpening
wheel, 3 swivel
range*

plane iron
and ripping
chisel
sharpening
machine,
grinding
gauge

Take the body of the drill with thumb and forefinger of the right hand. The left hand holds the drill at the shank and carries out an upward and downward movement of the drill between the horizontal and an imaginary line 15° below the horizontal. In doing so, continuously check by means of the grinding gauge the point angle, the shape of the cutting edges under the same angle, the concentricity of the point, the position of the chisel edge and the wedge angle.

checking of
sharpening

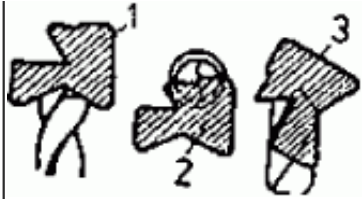

1 checking of the drill point angle,
2 checking of the position of the chisel edge, 3 checking of the wedge angle

10.2. Setting-up of Machine Tools

Setting-up of circular saw blades and band saw blades

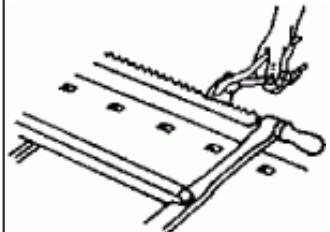
Operation Representation	Tools/aids	Remarks
cleaning of the saw blade	petroleum, thinner	
setting of the saw blades 	setting pliers, set gauge, setting dial gauge	Use setting pliers. Because of its greater accuracy the setting dial gauge is more suitable than the set gauge for checking the setting width.

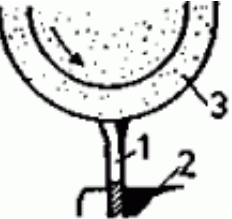
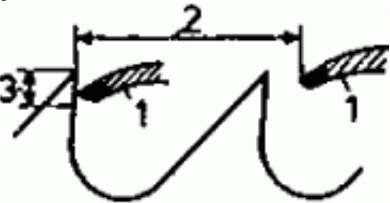
clamping of the circular saw blade into the sharpening machine	sharpening machine	Saw blade bore hole must fit exactly on the centring taper; put grinding wheel head into highest position, set tooth height greater than necessary.
setting of the saw blade thickness  <i>1 saw blade, 2 adjustable stop, 3 sharpening wheel</i>	sharpening machine	Middle of the saw blade exactly under the middle of the axis of the abrasive tool.
setting of the rake angle	sharpening machine	In case of band saw blades set according to the scale of rake angles of the sharpening machine - choose it a little greater at first.
setting of the saw pitch  <i>1 feed finger, 2 path of the feed finger, 3 upper</i>	sharpening machine, measuring tape	Measure the pitch at the saw blade and set it on the saw pitch scale of the machine.

*third of the saw
tooth*

fine setting of the
tooth feed



*1 sharpening
wheel, 2 feed
finger*

sharpening
machine

Switch on the machine, set the tooth feed so that the abrasive tool coming down slightly attacks the cutting face.

setting of the
moment of shear

sharpening
machine

The feed must start to act at the moment when the abrasive tool reaches the tooth gullet.

sharpening

sharpening
machine, hone

At least 4 sharpening passes are necessary; material removed per pass 0.05...0.1 mm; in the last pass only minimum metal removal (0.01... 0.03 mm); carefully remove the sharpening burr with a fine hone.

setting of the
tooth height

sharpening
machine

Fine setting:
Abrasive tool must run parallel to the flank.

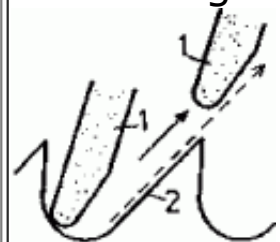

*1 sharpening
wheel, 2 flank of
the saw tooth*

checking of the top line	glass plate or tooth crest dial gauge	Check band saw blades like hand saws (see par. 10.1.), check circular saw blades with tooth crest dial gauge.
checking of cutting edge angles  <i>1 rake angle gauge, 2 wedge angle gauge</i>	bevel steel square, plate template, wedge angle gauge or similar	Check either with plate template as is done in the case of hand saws or with wedge or rake angle gauge or with bevel steel square.

Mistakes made when sharpening the saw blades

Sharpening mistake	Cause of mistake	Effect of mistake	Elimination of mistake
uneven flank	feed is acting too early (flank becomes hollow) or too late (flank will get lugs)	chip disposal rendered more difficult, warming-up and drifting of the saw blades	Set the moment of shear correctly.
tooth gullet	saw pitch set to small	low stability of the	Increase the travel of

radius too great		saw teeth, drifting of the saw blade	the feed pawl.
tooth gullet radius too small	profile of the sharpening wheel rounded too little, wheel too thin	drifting of the saw blade at higher feed	Choose proper sharpening wheel, reduce the travel of the feed pawl.
tooth height too great or too small	machine wrongly set	changed tool geometry, shorter cutting life of the cutting edge, drifting of the saw blade	Correct the fine setting of the tooth height.
tooth height not uniform	axis of the sharpening wheel not exactly above the middle of the saw blade	load on the saw teeth not uniform, quicker dulling, worse cutting quality	Check the guidance of the saw blade and correct it.
discolouration of teeth crests	too much material removed by grinding or peripheral speed of the sharpening wheel too high or sharpening wheel too hard	loss of strength of the teeth crests, quicker dulling, drifting of the saw blade	Correct the sharpening wheel's action and the tooth feed, choose another sharpening wheel.
saw pitch not uniform	tooth feed wrongly set, the sharpening wheel coming down too late attacks the cutting face too heavily	load on the saw teeth not uniform, drifting of the saw blade, worse cutting quality	Reset the sharpening wheel action on the cutting face.
wedge angle	tooth height setting too great	altered tool	Correct the fine

wedge angle altered	tooth height setting too great (wedge angle becomes smaller) or too small (wedge angle becomes greater)	altered tool geometry, worse cutting conditions, higher load on the saw teeth	correct the time setting of the tooth height setting.
remaining of a sharpening burr	great abrasion, dull or excessively coarse-grained sharpening wheel	quicker dulling of the cutting edges	Make last sharpening pass with only little abrasion.

Setting-up of stripe irons

Operation Representation	Tools/aids	Remarks
cleaning of the stripe iron and the clamping surface	solution	Cleaning also serves for preventing grinding inaccuracies.
clamping of stripe irons for sharpening  <i>1 stripe iron, 2 clamping plate, 3 detent of stripe iron</i>	sharpening machine Clamp the stripe irons on the grinding beam so that the cutting edges project about 2 mm beyond the grinding beam and the sharpening wheel can run a few centimetres beyond the end of the stripe iron. When clamping is made in a vice, clamp from the middle of the stripe iron outwards.	
infeed grinding	sharpening	Infeed the sharpening wheel according to the

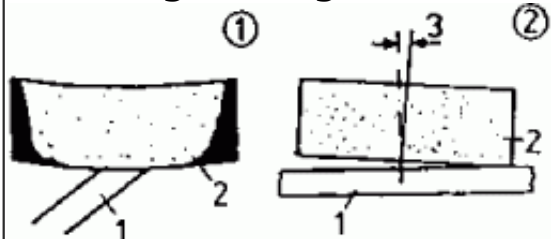
abrasive machining	sharpening machine	desired degree of keenness by 0.01 - 0.03 mm each. Grind in one pass; feed according to the degree of dulling 0.1...0.4 mm.
flat grinding	sharpening machine	Cup wheel is without tilt angle.
finish grinding	sharpening machine	Grind with moderate pressure. In the last pass the sharpening wheel must come clear. Always grind against the land.
<p data-bbox="120 496 456 552">hollow grinding</p>  <p data-bbox="120 799 640 951">(1) view in the running direction of the cup wheel (2) view at right angles to the running direction of the cup wheel <i>1 stripe iron, 2 cup wheel, 3 tilt angle</i></p>	sharpening machine	Tilt the cup wheel by 2...3° in the running direction of the grinding wheel head; multiple honing is possible.
honing	sharpening machine	Remove the grinding burr and fine traces of grinding. Hone only at the cutting face and always in longitudinal direction of the cutting edge. Hone must firmly be placed in position.



Setting-up of milling cutters

1 machine iron, 2 hone

with rough and fine sides

Operation Representation	Tools/aids	Remarks
mounting of the cutter on the grinding arbor; centring	sharpening machine	Centring is made by means of centring rings.
aligning of the cutting edges for sharpening	sharpening machine	Align always according to the shortest cutting edge which is determined by means of the dial gauge.
grinding of the tool face  <i>1 milling cutter, 2 sharpening wheel</i>	sharpening machine	Grind relief-turned cutters only at the tool face. Re grind cutters with straight flank (straight relief grind) at the tool face only slightly (infeed axially).
radial infeeding	sharpening machine	Relief-turned cutters must be fed to the sharpening wheel radially, i.e. they must be turned around the axis during feeding.

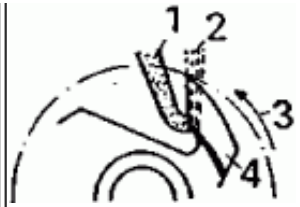

1 sharpening wheel, 2 material removed in grinding, 3 infeed,

4 milling cutter
checking of the cutting rake

sharpening machine, protractor

In order to ensure always the same cutting rake, the chip removal over the whole tool face is not uniform (chip removal increasing towards the periphery).

grinding of the flank

sharpening machine

Sharpen cutters with straight flank (see par. 9.4.) at the tool face and flank (with the exception of grooving and tonguing cutters which are sharpened only at the tool face).

axial infeeding

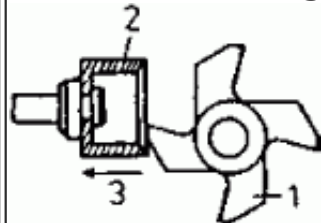

1 milling cutter, 2 sharpening wheel, 3 infeed

sharpening machine

Sharpen cutters with straight flank mainly at the flank, in-feed axially.

sharpening

sharpening machine

Grind all cutting edges uniformly.

dressing of the sharpening wheel	sharpening machine, silicon carbide stone	In case of considerable dulling of the cutting edges dress the sharpening wheel once more before finish grinding. To do this, hold the silicon carbide stone by freehand at an angle of 10...15° against the rotating sharpening wheel.
finish grinding	sharpening machine	In the final pass feed the sharpening wheel only slightly so that the sharpening burr can easily be removed.
removing of the sharpening burr	sharpening machine, hone	Carefully hone the cutting edges to remove the sharpening burr.
checking for true running	sharpening machine dial gauge	All cutting edges must lie on the same cutting circle (run-out ≤ 0.02 mm).
regrinding	sharpening machine	Regrind projecting cutting edges individually to lie on the cutting circle.



[Home](#) > [ar](#).[cn](#).[de](#).[en](#).[es](#).[fr](#).[id](#).[it](#).[ph](#).[po](#).[ru](#).[sw](#)

Formulae and Tables - Wood / textbooks for vocational training (GTZ, 122 p.)

11. Gluing of Wood

(introduction...)

11.1. Important Terms of the Gluing Techniques

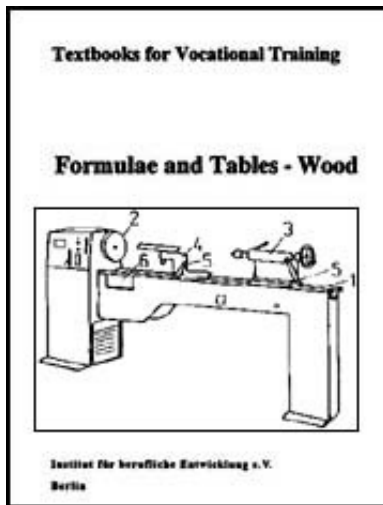

11.2. Kinds, Properties and Processing of Important Glues

11.3. Gluing Mistakes and Their Causes

Formulae and Tables - Wood / textbooks for vocational training (GTZ, 122 p.)

11. Gluing of Wood

Gluing of wood implies permanently joining several workpieces to improve technical or optical properties.

11.1. Important Terms of the Gluing Techniques

Term	Definition
period of maturing (swelling)	1 period from mixing or stirring solid glues with the gluing liquid (also period from mixing the components of a multi-component glue) to reaching a workable condition
solid content	non-volatile portion of glues which remains after the volatilization of the solvents or which is forming during hardening by chemical conversion
extenders	substances which are added to glues to improve the joint stability or to lower

	the glue costs; they have a bonding power of their own
fillers	substances added to the glues to reduce the glue costs (no inherent bonding power)
pot life	period from preparing the glue mix or from taking the glue out of the packing to the time the glue remains workable
waiting period	period for keeping the parts to be joined at room temperature between glue spreading and applying pressure on the glued joints
open waiting period	time between glue spreading and putting the parts together
closed waiting period	time between putting the parts together and loading the pressing facility
gluing temperature	according to the processing temperature we distinguish between:
	cold gluing at 10...30 °C
	warm gluing at 30... <100 °C
	hot gluing at a 100 °C

11.2. Kinds, Properties and Processing of Important Glues

Property/Operation	Glutin glue	Casein glue	PVA glue	Urea-formaldehyde glue
swelling period	10...90 min	30...60 min		

		(period of maturing)		
melting temperature	>30...40 °C			
solid content	20...50 %	30...40 %	≈ 50%	60...70 %
pH value	5.5...9.0	10.0...14.0	4.0...5.0	7.0...8.0
moisture content of wood	4...10 %	4...10 %	8...12%	8...12 %
pot life at 20 °C		4...12h		according to the kind of glue and hardening from 30 min to several hours
open waiting period at 20 °C		5...10 min	5...30 min	according to the kind of glue and hardening from 5 min to several hours
spread	150...170g/m ²	180...250g/m ²	150...220 g/m ²	80...150 g/m ²
pressure	0.6...1.2 MPa	0.5...1.0 MPa	0.1...1.2 MPa	0.6...2.0 MPa
pressing temperature	10...50 °C	10...100°C	20...50 °C	20...90°C
pressing time	2...4 h	cold 2...4 h	10...60 min	0.5...4h at 20°C
storage ability	dry rooms at 65 ±	4...6 months	several	liquid: 3 months,

	5 % relative air humidity for	when kept airtight	months in tightly closed	powder: 12 months at 20 °C each
application	prolonged storage Construction of chests and frame furniture, assembly gluing, for veneering with warmed-up press plates	making of joinery structural elements, repair work, for veneering	containers in furniture construction, window, door and interior work, gluing wood and plastic material together, for veneering	construction of furniture and frame furniture, interior work, construction of windows and doors, for veneering, for all kinds of repairs

Hints for use

glue selection	water-soluble warm gluing	water-soluble cold or warm gluing	water resistant cold or warm gluing	like PVA glue
glue preparation	initial swelling, melting at = 70 °C; addition of water influences spread-ability	dissolve powdered glue in glass or porcelain vessels	ready for use as delivered	Either mix glue and hardener solution in the ratio specified or make both available in glass or porcelain vessels.

preparation of the workpiece	warm up the surfaces to be glued; warm up and wax the press plates when veneering on Oat workpieces	for warm gluing like glutin glue; for cold gluing just lay out the workpieces	like casein glue	like casein glue; make sure to label the vessels for glue and hardener (danger or mixing up)
glue spreading	by means of a brush or roll spread the glue rapidly, uniformly and thin on the two surfaces to be joined	like glutin glue	like glutin glue	When applying the mixing technique, spread as described for glutin glue; otherwise coat one of the surfaces to be joined with glue, the other one with hardener.
pressing of the glued joint	join the parts coated with glue by means of a screw clamp; put flat parts together with the heated press plates into the hand screw press	for warm gluing like for cold gluing press use cold press plates,	glutin glue; plates are not if need be	absolutely necessary,

11.3. Gluing Mistakes and Their Causes

Kind of mistake	Description of mistake	Causes of mistake	Elimination of mistake
glue bleed-through	bleeding of the glue through the pores of the face veneer	glue unsuitable or too thin, insufficient addition of filler or extender, thin or coarse-pored veneers, excessive pressure, excessive pressing temperature, moisture content of the wood too high	If glutin glue is used, wash out with bronze wire brush and warm water (add oxalic acid, if required). Wash out PVA glue immediately after veneering, otherwise not possible any more.
discolouration	colour changes caused by chemical processes between wood components and substances added to the wood during working	wood with high content of tanning agents, hardener vapours, excessive pressing temperature	Wash out iron discolourations (blue) with oxalic acid, eliminate discolourations to the red caused by high pressing temperatures by cooling the workpieces for several minutes after pressing.
visible and invisible bubbles and similar	Poor gluing as bubble is visible immediately after pressing, invisible bubble is visible	insufficient or uneven glue spreading, insufficient pressure, exceeding of the open or closed waiting period, wood too dry,	Cut open and glue again the - defective spots, if number and size of the poorly glued spots allow this.

	only after contact with moisture.	pressing times too short	
uneven spots and similar	thickness differences on the veneered workpiece	uneven glue spreading, improperly made cores, joints in cross-band veneer, cross-band veneers or face veneers lying one above the other	hardly possible
warping, distortion	deformation of panel-shaped workpieces in the plane	one-sided veneering of base material, different moisture of the coating material used	hardly possible
marking of veneer joints		use of inaccurately joined veneers, poorly glued veneer joints, excessive veneer moisture	hardly possible
loosening of the glued joint	gluing destroyed or not achieved at all	preheating temperature of the parts to be glued too high; misfitting of the parts glued; moisture differences of glued parts	not possible
insufficient stability of the glued joint		gluing of uneven surfaces; gluing of dirty surfaces; use of dowels made of unsuitable wood, uneven	not possible

		glue spreading insufficient preheating of the surfaces	
marks	base material shows through the covering material	to be glued high pressures when gluing thin sheets on frame elements, use of highly viscous glues for gluing thin hygroscopic sheet materials on frame elements	not possible
waviness of the surface	deformation in the plane of sheet materials	processing of improperly made sandwich panels with solid wood core, excessive pressure during processing of sandwich panels with hollow core	not possible



[Home](#) > [ar](#).[cn](#).[de](#).[en](#).[es](#).[fr](#).[id](#).[it](#).[ph](#).[po](#).[ru](#).[sw](#)

 **Formulae and Tables - Wood / textbooks for vocational training (GTZ, 122 p.)**

  **12. Surface Treatment of Wood**

 **(introduction...)**

 **12.1. Substances for Surface Treatment**

 **12.2. Use of the Coating Compositions**

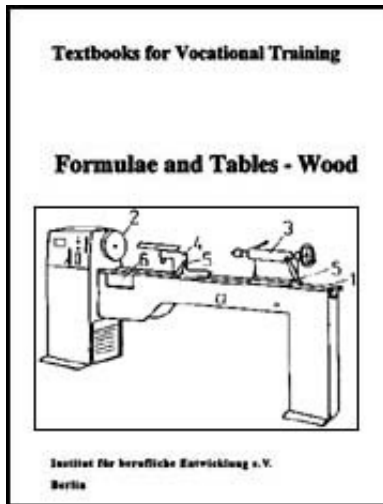

12.3. Examples of Wood Coating Systems

Formulae and Tables - Wood / textbooks for vocational training (GTZ, 122 p.)

12. Surface Treatment of Wood

The surface treatment of wood includes all techniques by which the wood surface is changed in its properties and is coated with liquid substances.

12.1. Substances for Surface Treatment

Substances for deresinification

Name	Composition	Mode of application
solvents	physically acting organic compounds (e.g. acetone)	Apply by means of a sponge or similar, then rub with a clean roll of cloth, wash with warm water.
saponification	chemically acting	Apply several times with a sponge, let it rest for 10 -

agent	alkaline compounds	15 minutes, treat with a brush, neutralize with 10 % (e.g. ammonia water) acetic acid, then wash with warm water.
-------	--------------------	--

Bleaching agents

Name	Mode of application	Use
bleach liquor	Apply solution of 40 g of soda, 50 g of chloride of lime and 30 g of potash in 1 l water by means of a brush; after treatment with 5 % warm sodium thiosulphate solution	for bleaching basic consumer goods and especially fir wood; good ventilation of the working rooms necessary.
acetic acid	Apply 5...10 % solution in warm state and wash and brush out thoroughly.	for especially sensitive wood species
potash lye and hydrogen peroxide	Precoat with aqueous potash solution, then apply hydrogen peroxide, finally apply acid neutralizing agent.	suitable for all wood species, removes blue stains, mould stains
sodium hydrogen sulphite	Apply warm 3...5 % solution and then wash thoroughly.	especially suitable for walnut wood
oxalic acid and salt of sorrel	Apply warm 2.5...5 % solution, let it harden and then wash thoroughly.	especially for tanniferous wood; also removal of rust and ink stains - bleaching agent is toxic,
hydrogen peroxide	Apply 30...35 % solution in sufficient quantity.	mainly for low-tanniferous wood species and for coniferous wood species

hydrogen peroxide and ammonia water	Apply hydrogen peroxide solution with 10 % ammonia water by means of a brush.	for quick bleaching of small surfaces
citric acid	Apply 3...5 % solution in a hot state, then wash and brush out well.	for brightening tanniferous wood and for removing stains caused by iron-tanning agent reactions and blue stains

Technique	Properties	Use
plain staining	solutions of heavy metal salts with dyestuffs	only for tanniferous wood species
double staining	Preliminary stains contain tan-like compounds, stains for the second coating contain various metal salts	for low-tanniferous wood; apply the second coating of stain only after the preliminary stain has dried; stains are water-insoluble and resistant to light
wax staining	solutions of metal salts, dyestuffs and wax additives ready for use	for all wood species, not in furniture construction, mat finish effect due to wax portion

Dyestuffs

Name	Properties	Use
water-	made of acid coal-tar dyestuffs and supplementary	for all wood species

soluble dyestuffs	agents, dissolve in soft water, good penetrability, high light resistance, no or only low water resistance	
spirit-soluble dyestuffs	solution of dyestuffs in spirit or in low-binder varnish; good penetrability, low light resistance, low water resistance	for colouring small workpieces, for example in the production of wooden articles or toys

Smoothing agents

Name	Properties	Use
pore filler	pulpy mixture consisting of 40...50 % binder (of drying oils or SH, UP or PUR lacquers) and 50...60 % pore filler powder (heavy spar powder, gypsum, kaolin, quartz powder and others) as well as dyestuffs	for coarse-pored timbers with subsequent lacquer coating; rubbing in of the pore filler by hand with rolls of cloth, after drying removal of the excess filler with a soft, spirit-impregnated cloth
putty	binder as described for pore filler plus fillers and dyestuffs, if required	for smoothing surfaces (e.g. raw chipboards), which afterwards are to be coated with coloured varnishes; only seldom applied by hand with putty knife, mostly with special machines; filled surfaces are to be ground after drying

Coating compositions

Name	Components	Properties
oil varnishes	drying oils and resins; an oil-to-resin ratio of 1:1 to 1:3 yields short-oil varnishes, a ratio of 3:1 to 5:1 yields long-oil varnishes	good adherence of the varnish coating, resistant to climatic influences and moisture as well as chemicals, low hardness of the varnish coating, but high elasticity, slow drying; dyestuffs can be added
cellulose nitrate lacquers (NC lacquers)	collodion cotton, solvents such as toluene, ethyl acetate, butyl acetate and other organic compounds as well as fillers and softeners	combinable with other coating compositions, quick-drying, various levels of gloss possible, lacquer coating is elastic; not moisture-resistant, temperature-sensitive, not resistant to solvents, to oils, acids, lyes and alcohols
alkyd varnishes	alkyd resins, oils and solvents	approximately like oil varnishes, extraordinarily elastic films, high resistance to mechanical influences and climatic influences, water-proof
acid-hardening varnishes (SH-varnishes)	synthetic resins, (urea resin, phenolic resin); solvent, filler and softener, acids as hardener	high adherence, elastic and hard varnish coating, resistant to water, alcohol, spirit and a great number of solvents, temperature-resistant and non-ageing, resistant to mechanical load
polyurethane	polyacrylate or	incompatible with oil and alkyd varnishes, good

lacquers (PUR lacquers)	polyester resins as well as solvents, pigments and fillers, in addition to this isocyanate as	adherence, hard and abrasion-resistant coatings, resistant to water, alcohol, solvents, variations of temperature
polyester lacquers (UP lacquers)	secondary component unsaturated polyester resin (hence UP lacquers), styrene and as hardener of organic peroxides in solvents	mainly for industrial processing, wood components may cause poor adherence (e.g. with the wood species Jacaranda, Iroko, Bt), combination with other kinds of lacquer possible; resistant to water, alcohol and many other substances, resistant to mechanical load and variations of temperature, brittle, cracking under impact load
polyvinyl acetate coating (PVA coating)	polymerized vinyl acetate, softener, fillers, pigments	water-dilutable, therefore not inflammable, not dangerous to health; good opacity, air-permeable, "breathing" of the undersurface possible

Solvents (selection)

Name	Properties
ethyl alcohol	colourless, boiling point 78 °C, inflammable, miscible with water and all usual organic solvents, highly toxic
ethyl acetate	colourless, inflammable, boiling point 77.1 °C, non-miscible with water
acetone	colourless, inflammable, boiling point 56.3 °C, highly volatile, miscible with

	water and most of the organic solvents
benzene	colourless, very inflammable, boiling point 80.1 °C, non-miscible with water, but miscible with organic solvents, vapours highly toxic
butyl acetate	colourless, inflammable, boiling point 118 °C, non-miscible with water, but miscible with organic solvents
methanol	colourless, inflammable, boiling point 64.7 °C, miscible with water, highly toxic
methylene chloride	colourless, non-miscible with water, boiling point 41.6 °C
toluene	colourless, inflammable, boiling point 110.8 °C, non-miscible with water
xylene	colourless, inflammable, boiling point 139...140 °C, little soluble in water, easily soluble in some organic solvents

12.2. Use of the Coating Compositions

Name	Mode of application	Range of application
oil varnishes	multilayer application by brushing, spraying, rolling or dipping, spread per application: linseed oil-priming oil 80...120 g/m ² priming paint 120...300 g/m ² coating varnish 100...250 g/m ²	fats, slowly drying varnishes for exterior coatings (e.g. windows), short-oil, quicker drying varnishes for interior coatings (e.g. floors)
NC lacquers	multilayer application by brushing, spraying, rolling, casting or dipping	for furniture and interior varnishing, for toys, arts and crafts, musical

	<p>1st spread: lacquer-to-thinner ratio 3:1 intermediate sanding 2nd spread: ratio 1:1 3rd spread: heavily thinned, rub with polishing cloth</p>	instruments
alkyd varnishes	<p>spread = 400 g/m² like oil varnishes</p>	coatings with high stability like floors as interior coating and windows and doors as exterior coating; but also as boat varnish (water and weather resistance)
acid-hardening varnishes (SH varnishes)	<p>mixing of the components in the specified ratio in non-metallic vessels; 1 to 3 spreads by brushing, spraying, casting, rolling; spread \leq 140 g/m²</p>	for interior coatings which are under stress, but also for exterior coatings; for furniture, sports equipment, windows, doors, parquet and in vehicle construction
polyurethane lacquers (PUR lacquers)	<p>mixing of the two components in the specified ratio; spreading in 1...2 applications by brushing, spraying, casting or rolling; spread \leq 250 g/m²</p>	for interior furnishings, for sports equipment, staircases, parquet, in vehicle construction, as boat varnish and for plastic coatings
polyester lacquers (UP lacquers)	<p>used mainly industrially; several applications according to the kind of spreading; putty, primer and lacquer are applied separately by spraying,</p>	especially for living room furniture, but also for other purposes like ship interior work and as boat varnish

	casting or rolling; lacquer spread 80...200 g/m ²	
polyvinyl acetate coatings (PVA coatings)	thinning with water as much as necessary, several applications according to the desired effect, spreading mainly by brushing; as PVA coatings are not glossy, a finish coat with oil or alkyd varnish is applied on the PVA priming coat, if required; spread (both priming coat and finish coat) 110...150g/m ²	for all kinds of interior coatings, but also for exterior coatings

12.3. Examples of Wood Coating Systems

Coating systems	Number of coats	Examples of application
exterior coating		
linseed oil-priming oil	1	for doors, windows, bungalows, sheathing,
oil priming paint for outside	1...2	fences, window boxes
oil varnish for outside		
linseed oil-priming oil	1	shutters, bungalows, espaliers, windows and doors
alkyd priming coat	1...2	

alkyd varnish outside	1	
PVA latex priming coat	1	huts, fences
PVA latex finish coat	2	goods wagons
PUR impregnating primer	1	windows and
PVA latex paint	1	other structural
PUR varnish for outside	1	elements
PUR adhesive filler	1	coating of plastic parts
SH mat varnish	1	and foamed plastic parts
interior coatings		
linseed oil-priming oil	1	coloured varnishing of doors,
oil priming paint for indoors	1...2	banisters, small and kitchen
oil varnished for indoors	1	furniture (inside)
PVA latex priming coat	1...2	sheathings, floors,
PVA latex finish coat	1	kitchen furniture (inside)
linseed-oil-priming-oil	1	glossy outside coating
PVA latex priming coat	1...2	of kitchen furniture
alkyd priming coat	1	
alkyd varnish	1	
NC dipping varnished, colourless or NC quick sanding primer	1...2	frame furniture
SH finishing varnish, colourless	1...2	

PUR impregnating primer	1	doors, banisters
PUR adhesive filler	1	and similar
PUR varnish for indoors	1	



[Home](#) > [ar.cn.de.en.es.fr.id.it.ph.po.ru.sw](#)

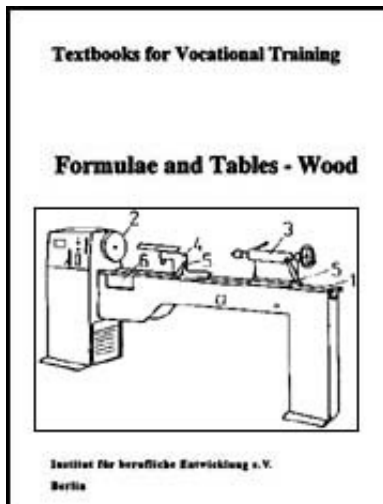

Formulae and Tables - Wood / textbooks for vocational training (GTZ, 122 p.)

 ***(introduction...)***

 **Preface**

1. Wood

2. Materials Made of Wood

3. Plastic materials

4. Glass Materials

5. Steel

6. Basic Terms of Cutting

7. Hand Tools

8. Wood Working Machines

9. Tools

10. Setting-up of Tools

11. Gluing of Wood

12. Surface Treatment of Wood



List of Symbols Used
List of Symbols Used

Symbol	Designation	Unit
a	setting width	mm
B	wear-land width	mm
b	width	mm
C	sound velocity	$m \cdot s^{-1}$
D	ball diameter	mm
d	diameter	mm
F_N	normal force	kp
F_R	force of sliding friction	kp
F_{Rmax}	force of static friction	kp
f	coefficient of sliding friction	-
f_0	coefficient of static friction	-
H	hardness	MPa
H	calorific value	$KJ \cdot kg^{-1}$
HB	Brinell hardness	MPa
h	tooth height	mm
l	length	mm

M_{bmax}	bending moment	$N \cdot m$
M_t	torque	$N \cdot m$
m	weight	g or kg
m_0	weight at a moisture of 0 %	g or kg
m_u	weight at the moisture content u	g or kg
n	speed	rpm
S	sound absorption	%
S	tool path	m
s	thickness	mm
T	tool life	h
t	pitch	mm
t_F	flash point	$^{\circ}C$
u	moisture content of wood	%
u	feed rate	min^{-1}
V	volume	cm^3 or m^3
V_0	volume at a moisture of 0 %	cm^3 or m^3
V_u	volume at the moisture content u	cm^3 or m^3
v	cutting speed	$m \cdot s^{-1}$
W	moment of resistance	cm^3
W_t	cutting path	$m \cdot h^{-1}$

x	cutting edge reset	mm
α	coefficient of heat transfer	$\text{kJ} \cdot \text{m}^{-2} \cdot \text{h}^{-1} \cdot \text{K}^{-1}$
α	tool orthogonal clearance	o
α_1	longitudinal swelling	%
α_r	radial swelling	%
α_t	tangential swelling	%
β	sound absorption	phon or decibel
β	tool-orthogonal wedge angle	o
β_1	longitudinal shrinkage	%
β_r	radial shrinkage	%
β_t	tangential shrinkage	%
γ	tool orthogonal rake	o
δ	cutting angle	o
ε	angle of point	o
ε_B	drill point angle	o
η	thermal resistance	$\text{m}^2 \cdot \text{h} \cdot \text{k} \cdot \text{K}^{-1}$
χ	setting angle	o
λ	tool cutting edge inclination	o
ρ	density	$\text{kg} \cdot \text{m}^{-3}$

ρ	density	$\text{g} \cdot \text{cm}^{-3}$ or $\text{kg} \cdot \text{m}^{-3}$
ρ	specific electrical resistance	$\Omega \text{ cm}$
ρ_0	oven-dry density	$\text{g} \cdot \text{cm}^{-3}$ or $\text{kg} \cdot \text{m}^{-3}$
ρ_u	density at the moisture content u	$\text{g} \cdot \text{cm}^{-3}$ or $\text{kg} \cdot \text{m}^{-3}$
σ_{bB}	bending strength	MPa
σ_{dB}	compressive strength	MPa
S_{zB}	tensile strength	MPa
τ_{aB}	shear strength	MPa
τ_{tb}	torsional strength	MPa
()	resistance to tensile strengths parallel to the grain direction	
(\perp)	resistance to tensile strengths vertically to the grain direction	



[Home](#) > [ar](#).[cn](#).[de](#).[en](#).[es](#).[fr](#).[id](#).[it](#).[ph](#).[po](#).[ru](#).[sw](#)

 **Formulae and Tables - Wood / textbooks for vocational training (GTZ, 122 p.)**

 ***(introduction...)***

  **Preface**

 **1. Wood**



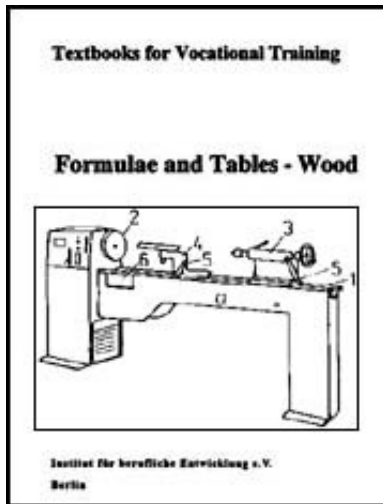

- 2. Materials Made of Wood**
- 3. Plastic materials**
- 4. Glass Materials**
- 5. Steel**
- 6. Basic Terms of Cutting**
- 7. Hand Tools**
- 8. Wood Working Machines**
- 9. Tools**
- 10. Setting-up of Tools**
- 11. Gluing of Wood**
- 12. Surface Treatment of Wood**
- List of Symbols Used**

Preface

This training booklet was drawn up on the basis of wide experience gained in the field of vocational training in Germany. It is intended for trainees in woodworking and can well be used in theoretical and practical training.

In dealing with this subject, the main emphasis was put on describing the facts, the influencing factors and the possible application.

The list of the symbols used which is added will make quick and comprehensive information possible.

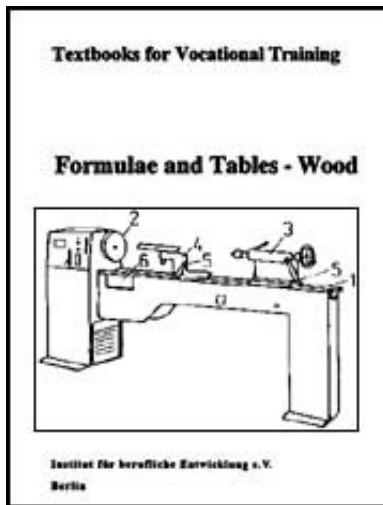

Formulae and Tables - Wood / textbooks for vocational training (GTZ, 122 p.)

1. Wood

 **(introduction...)**

 **1.1. Structure of Wood**

 **1.2. Chemical Composition of Wood**

 **(introduction...)**

 **1.2.1. Cell Wall Components of Wood**

 **1.2.2. Wood Constituents**

 **1.3. Physical Properties of Wood**

 **(introduction...)**

 **1.3.1 Wood Density**

 **1.3.2. Moisture Content of Wood**

 **1.3.3. Swelling and Shrinking of Wood**

 **1.3.4. Thermal Properties of Wood**

 **1.3.5. Acoustic and Electric Properties of Wood**

 **1.3.6. Friction Properties of Wood**

 **1.3.7. Strength of Wood**

 **1.4. Important Wood Species**

 **1.5. Wood Defects Caused by Growth Influences**

Formulae and Tables - Wood / textbooks for vocational training (GTZ, 122 p.)

1. Wood

Wood is a tissue which is formed under the bark of the trunk by the meristem, the cambium. It consists of different cells.

1.1. Structure of Wood

The structure of the wood can be seen with the naked eye on the cut surfaces (see Fig. 1).

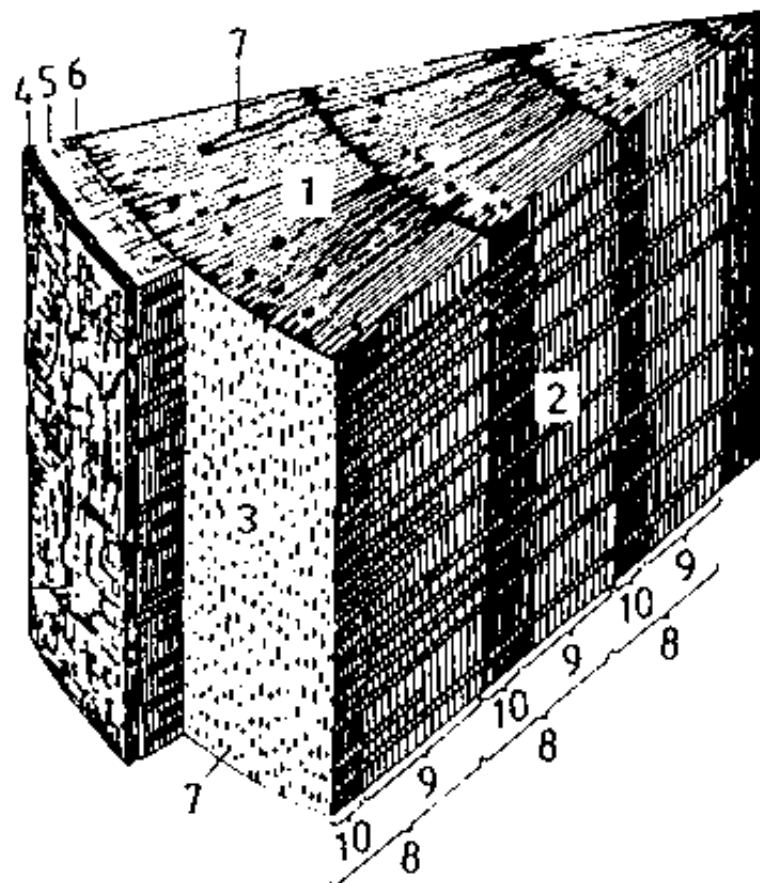

1 cross-sectional area, 2 area of radial section, 3 area of tangential section, 4 bark, 5 bast, 6 cambium, 7 medullary ray (wood ray), 8 annual ring, 9 early wood, 10 late wood

Figure 1 Sectional view

Fine Structure of Wood

The fine structure of wood is visible only under the microscope.

Tissue	Types of cells	Structure	Function	Occurrence
conducting tissue	tracheas	cells of different size and structure which are united into tubes; inside width: 0.02 - 0.5 mm length: a few cm to several m	water and nutrient conduction	deciduous wood
	tracheids	similar to the tracheas, but universally closed and dotted; inside width: 0.001 - 0.4 mm length: 0.3 -11 mm	water and nutrient conduction	all wood species
strengthening tissue and storage tissue	sclerenchymas	thick-walled, air-filled structures of small cross-section	strengthening of the wood	deciduous wood
storage tissue	parenchymas	mostly tape-shaped cells	metabolism and	all wood
	- axial parenchymas	strung together	storage of reserve substances	species
	- cross parenchymas	mostly square cells; containing many dots	nutrient storage and conduction in radial direction	all wood species
		longitudinal and cross parenchymae mostly form		

a multiple-branched network

1.2. Chemical Composition of Wood

Wood is composed of many chemical substances. The wood properties are considerably influenced by the composition.

Percentage in dry substance of wood

Carbon (C)	Oxygen (O)	Hydrogen (H)	Nitrogen (N)	Mineral substances
48...51	43...46	5...6	0.04...0.26	0.1...1.2

The percentages vary with the wood species.

1.2.1. Cell Wall Components of Wood

Percentage in dry substance of wood

Cellulose	Pentosanes	Lignin	Constituents
25...62	15.27	25...45	approx. 1.0
Composition of the cell components			
44.4 % C	45.4 % C	62...69 % C	see under 1.2.2.
49.4 % O	49.4 % O	26...33.5 % O	
6.2 % H	5.2 % H	6... 6.5 % H	

1.2.2. Wood Constituents

Constituent	Description of the substance	Percentage in dry substance of wood	Importance of the constituent
alkaloids	metabolic product		protection against animal pests of wood
inorganic acid and salts	products of deposition		makes woodworking possibly more difficult
bitter substances	metabolic products		
protein	ditto		
colouring substances	excretion products of the cells or constituent of the cell sap		
fats	reserve substances	up to 0.12...1.3 %	
tannin	product of deposition	up to 17 %	protection against pests of wood, tannin extract recovery
glucosides	reserve substance		
gum	protective substance		use for colouring and adhesive substances
resins	metabolic product		makes woodworking more difficult

RESINS	metabolic product		makes woodworking more difficult, serves for the manufacture of lacquers and adhesive substances
camphor	protective substance	up to 3 % and 1.5 % camphor oil	as distillation product for the recovery of essential oils
mineral substances	product of deposition		makes woodworking more difficult
oils	decomposition products	up to 1.6 %	protective agent
organic acids and salts	metabolic products		makes woodworking more difficult
odoriferous, toxic and curative substances	protective substance for the wood		may result in damage to the health during woodworking (see 1.4. under the various wood species)
starch	reserve substance	0.27...7.0 % sago palm up to 400 kg/tree	for food production and for gluten, thickeners and others
waxes	excretion products of the cell walls and the protoplasm	occurs seldom	makes surfaces treatment of the wood more difficult
sugar	conversion product of the starch	up to 3.5 % in the sap of	saccharification of wood

1.3. Physical Properties of Wood

The physical properties of wood depend on the chemical composition and the biological structure.

1.3.1 Wood Density

The wood density is the ratio of the wood mass to the wood volume at a certain moisture content.

Designation	Definition	Calculation
density ρ	ratio of mass to volume of a substance	$\rho = \frac{m}{V}$ m = mass in g V = volume in cm
oven-dry density ρ_0	density of absolutely dry wood	$\rho_0 = \frac{m_0}{V_0}$ m ₀ = mass in g at a moisture content of 0 % V ₀ = volume in cm ³ at a moisture content of 0 %
gross density ρ_U	density of wood at a specific	m

the following are usual:	moisture content	$\rho_u = \frac{m_u}{V_u}$ <p>m_u = mass in g at a specific moisture</p> <p>V_u = volume in cm³ at a specific moisture content</p>
<p>ρ 12...15 (12...15 % moisture content of wood)</p> <p>and</p> <p>ρ green (freshly felled timber)</p>		

Ratio of moisture content of wood to gross density (see Fig. 2).

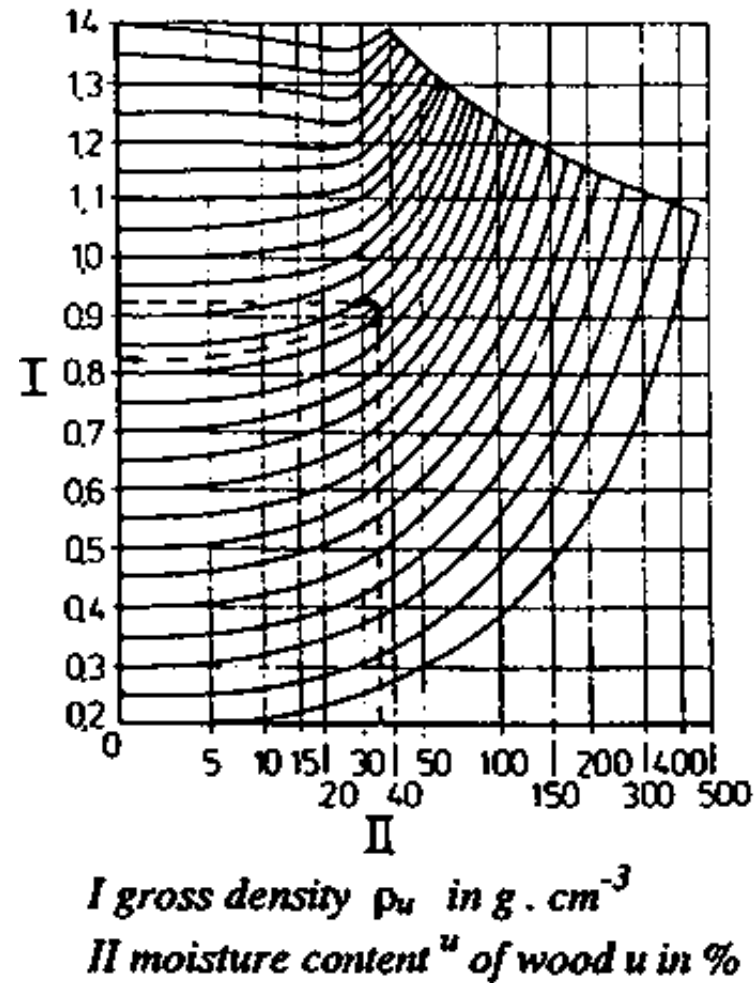

Figure 2 Plot of gross density and moisture content

1.3.2. Moisture Content of Wood

The moisture of wood is the liquid content of wood.

Designation	Definition	Calculation
moisture	water content of wood in % or in kg of water per kg	$m_{..} - m_{..}$

content of wood u	of wood	$u = \frac{m_u - m_o}{m_o} \cdot 100\%$
oven-dryness	wood in absolutely dry condition	$u = \frac{u_m - m_o}{m_o} \text{ in kg} \cdot \text{kg}^{-1}$
air-dryness	wood in air-dried condition (moisture content of wood 12 to 15 %)	<p>u = moisture content of wood in % or in $\text{kg} \cdot \text{kg}^{-1}$</p> <p>$m_u$ = mass of the damp wood sample in kg</p> <p>m_o = mass of the oven-dry wood sample in kg</p>
fibre saturation	cell walls completely saturated with water (moisture content of wood 22 ... 36 % depending on the wood species)	
water saturation	all voids filled with water (maximum moisture content)	

1.3.3. Swelling and Shrinking of Wood

Swelling and shrinking is the change of dimensions of wood as a result of moisture take-up by the incorporation of water into cell wall or by the extraction of water from the cell wall.

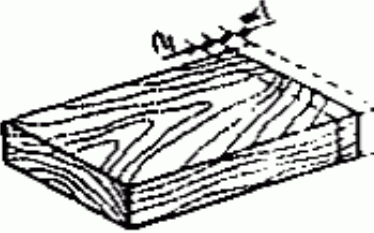
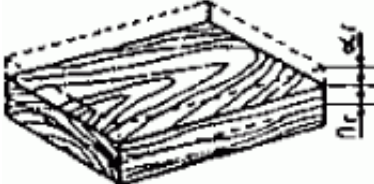
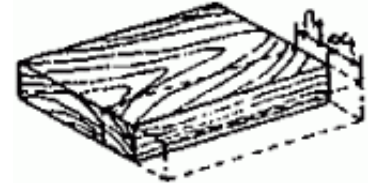
Behavior of the wood	Definition	Amount of the change in dimension	Schematic Representation
longitudinal swelling α_1 and longitudinal shrinkage β_1	change in dimension of the wood in grain direction as a result of take-up or liberation of water	0.05...0.07 %	
radial swelling α_r and radial shrinkage β_r	change in dimension of the wood vertically to the annual rings as a result of take-up or liberation of water	1.2...8.5 %	
tangential swelling α_t and tangential shrinkage β_t	change in dimension of the wood in the direction of a tangent to the annual rings as a result of take-up or liberation of water	3.0...16.0 %	

1.3.4. Thermal Properties of Wood

Wood has good heat-insulating properties, but is a bad heat conductor.

Quantity	Definition	Amount	Remarks
heat transfer coefficient α	amount of heat which within a certain period of time is transferred at an interface	for wood in calm air $\alpha = 20...32, \text{ in}$	

in kJ m^{-2} $\text{h}^{-1} \text{K}^{-1}$	from one material to another	a breeze of $1 \dots 5 \text{ m s}^{-1}$ $\alpha = 32 \dots 80$	
thermal resistance η in $\text{m}^2 \text{ h K}$ kJ^{-1}	resistance of a material to the heat transfer	$\eta = \frac{d}{\lambda}$ d = wood thickness in mm λ = coefficient of thermal conductivity in $\text{kJ m}^{-1} \text{ h}^{-1} \text{ K}^{-1}$	
flash point t_F in $^\circ\text{C}$	temperature at which the wood starts to bum upon ignition	t_F for wood $200 \dots 275 \text{ }^\circ\text{C}$	
calorific value H in kJ kg^{-1}	quantity of heat released during burning	calorific value for wood at u_0 $H \approx 19000 \text{ kJ}$ kg^{-1} at $u = 12 \%$ $H \approx 13500$ to 17000 kJ kg^{-1}	H is increasing with the content of carbon, hydrogen, combustible constituents, lignin and with rising density

1.3.5. Acoustic and Electric Properties of Wood

The acoustic properties of wood result from its ability to vibrate.

The electric properties are based on the fact that wood acts as an insulator when oven-dry.

Quantity	Definition	Amount	Remarks
sound velocity C in m s^{-1}	velocity at which sound waves propagate in a body	in grain direction 3000...5000 ms^{-1}	the ratio of the sound velocity in wood in grain direction to that across the grain is 1.3...1.5
sound damping β in phons or decibels; sound absorption S in %	assimilation of sound energy by the body exposed to sound waves; ratio of the sound energy absorbed by a body to the sound energy arrived at the body	$S = \frac{k_s}{k_a}$ $k_s =$ absorbed sound energy $k_a =$ sound energy arrived	
specific	electrical resistance of a cube with an		is getting smaller

electrical
resistance ρ in
 Ω cm

edge length of 1 m

with increasing
density and
moisture

Sound absorption **S** of some sound-absorbing materials in % at a frequency of 512 Hz

Material	Thickness in mm	Application	S in %
wood-wool boards	25	directly on the wall	35
wood particle boards	13	at a distance of 50 mm to the wall, surface untreated	19
felt	5	directly on the wall	18

1.3.6. Friction Properties of Wood



Friction is defined as the action of forces which at two contacting surfaces resist motion.



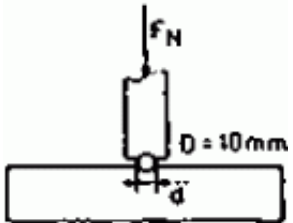

Quantity	Definition	Amount resp. Calculation
force of static friction F_{Rmax} in kp	force necessary to make two surfaces slide against each other	$F_{Rmax} = f_0 * F_N$ f_0 = coefficient of static friction F_N = normal force $f_0 \parallel \approx 0.6$

		$f_{\perp} \approx 0.55$
force of sliding friction F_R in kp	force to overcome the resistance to motion when one surface is moving on other surface	$F_R = f * F_N$ f = coefficient of sliding friction $f_{ } \approx 0.5$ $f_{\perp} \approx 0.35$
force of rolling friction F_{Rmin} in kp	force to overcome the resistance which counteracts the rolling off of a cylinder	$F_{Rmin} = \frac{F \cdot r}{F_N}$ F = force acting in the centre of the circle r = radius of the circle

1.3.7. Strength of Wood

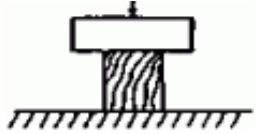
Strength is defined as the resistance of a body put up to the indentation by another object.

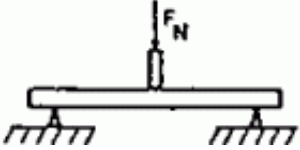
Quantity Schematic representation	Definition	Amount
 <p>hardness H in MPa</p>	resistance of a body to the action of external forces	
	resistance of a body to a	F

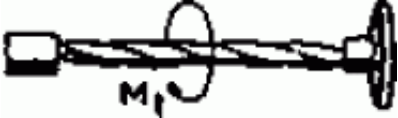
 <p>compressive strength δ dB in MPa</p>	<p>compressive force acting from outside</p>	$\delta \text{ dB} = \frac{F_{\text{max}}}{A_0}$ <p>F_{max} = compressive force A_0 = cross-section</p>
 <p>tensile strength δ zB in MPa</p>	<p>maximum resistance of a body to tensile stress</p>	$\delta \text{ zB} = \frac{F_{\text{max}}}{A_0}$ <p>F_{max} = tensile force A_0 = cross-section</p>
 <p>bending strength δ dB in MPa</p>	<p>maximum load occurring under a bending stress</p>	$\delta \text{ dB} = \frac{M_{\text{bmax}}}{W}$ <p>M_{bmax} = bending moment W = moment of resistance</p>
 <p>shear strength τ aB in MPa</p>	<p>resistance to destruction by shearing forces</p>	$\tau \text{ aB} = \frac{F_{\text{max}}}{A_0}$ <p>F_{max} = shearing force A_0 = shear surface</p>
 <p>torsional strength τ tB in MPa</p>	<p>highest tension occurring under torsional stress</p>	$\tau \text{ tB} = \frac{4.8 M_t}{a^3}$ <p>M_t = torque a = length of a side of the cross-section</p>

The torsional strength increases with density and with rising latewood and heartwood percentage and with decreasing moisture content.

Brinell hardness species in MPa of various wood			Mean shear strength of species in MPa various wood	
Wood species	HB	HB _⊥	Wood species	τ aB
Albura	48	28	Albura	7.6
Ail	37	17	Ail	7.0
Bt	85	33	Bt	8.0
Boss	58	25	Boss	10.6
Iroko	60	33	Iroko	11.0
Tali	85	55	Tali	9.0

Calculation:
$$HB = \frac{2F}{\pi D(D - \sqrt{D^2 - d^2})}$$

1.4. Important Wood Species

Trade name	Other names	Occurrence	Wood colour	
			Heartwood	Sapwood
Abura	Bahia, Elilom, Subaha, Vuku	West and East Africa	greyish brown, brown to grey	yellowish red
African	Khava, Ndola	West Africa	light red, quickly	light reddish

African Mahogany	Khaya, N'Gollom, Acajou d'Afrique	West Africa	light red, quickly darkening	light reddish grey
African Padouk	Barwood, Ndimbo, Epion, Takula, Ebeu	West Africa	coral-red, to reddish brown, darkening	whitish to cream-coloured
Aiel	Atu, Elimi, Abeui, M'bili, Bidinkala	West Central and East Africa	yellowish grey, yellowish brown	yellowish white to pale pink
Avodir	Apaya, Engan, Agb, Lusamba	tropic West Africa	pale yellow to cream-yellow, darkening	
Bt	Aprono, Ofun, Mansonia	West Africa	brownish to olive, often darkening	whitish
Bilinga	Aloma, Badi, Kusia, Opepe, Akondoc	West and East Africa	salmon-coloured, rose-pink, darkening	pale pink
Bintangor	Koila, Calophyllum	South-East Asia	reddish brown	yellowish grey
Boss	Divuiti, Ibotou, Ebang-bemva, Akuraten	West Africa	salmon-coloured, rose-pink, darkening	pale pink
Bubinga	Oveng, Okweni, Kevazingo, Essingang	West Africa	reddish brown to purple red veined	greyish white to pale yellow
Dabma	Agboin, Atui, Toum, Dahoma, Bokundu	West and East Africa	yellowish brown to greyish brown	whitish grey to light brown

Dark red meranti	Adamui, Tanguile Nemesu, Meranti merah	South-East Asia	reddish brown	yellowish grey
Dibtou	Apop, Bibolo, Bombolu, Alop	tropic West Africa	light to dark brown darkening	pale yellow to pale brown
Douka	Okola, Bavili, N'duka	West Africa	light red to reddish brown	reddish white
Doussi	Afzelia, Bolengu, Papao, Uvala, M'bango	West and East Africa	light brown, often dark-veined	whitish to light yellow
Ebiara	Abem, Berlinia, Melegba, Obolo, Ekpogoi	West Africa	light reddish brown to reddish brown	yellowish white to reddish grey
Framir	Lidia, Idigbo, Black afara	West Africa	greenish yellow, darkening	yellowish
Ilomba	Akomu, Lolako, Otie, Wall	tropic West, Central and East Africa	pink to yellowish brown	
Iroko	Abang, Odum, Kambala	West, Central and East Africa	greyish yellow to light brown, darkening	yellowish white to grey
Kosipo	Omu, Penkawa, Mpempe, Atomassi	West and Central Africa	reddish brown	grey
Krabak	Sanai, Ven ven, bac, Palosapis	South-East Asia	yellowish to yellowish brown, darkening	pale yellow
Limba	Afara, Akom, Erak	West and	pale yellow with a touch	

Littida	Aida, Akumi, Itak, Ofram	West and Central Africa	pale yellow with a touch of olive, also greenish grey	
Makor	Baku, Aganope, Butusu	West Africa	pink to reddish brown, darkening	cream-coloured to reddish darkening
Merawan	Thong, Koki, Thingan, Kien kien	South-East Asia	yellowish, quickly darkening	pale yellow
Moabi	Njabi, Adza, Dimpampi	West Africa	dark red to reddish brown, darkening	light pink to dark grey
Movingui	Eyen, Barr Ayan Bonsamdua	West Africa	lemon yellow to greenish yellow, darkening	yellowish grey
Mukulungu	Elang, Anzala, Fino, Autracon	West Africa	reddish brown, often dark-veined	yellowish grey to greyish brown
Naga	Okwen, Tebako, Meblo	West Africa	copper-coloured to reddish brown, light and dark stripes	light brown
Niangon	Ogou, Kekosi, Yawi, Wishmore	West Africa	light to dark reddish brown, orange tinted	whitish to reddish grey
Okoum	Caboon, Zonga, Angouma	West Africa	pale pink to reddish brown	light grey
East Indian jacaranda	East Indian rosewood, Sono keling, Eravadi	South Asia East India	yellowish brown to purple brown, darkening	yellowish

Ozigo	Assia	West Africa	grey yellowish to pale pink	pale grey, yellowish or reddish tinted
Sapelli	Lifaki, Sapele, Dilolo, Aboudikro	West, Central and East Africa	pale pink to light brown, darkening	cream-coloured, darkening
Sipo	Assi, Utile, Timbi, Ogipopo	West, Central and East Africa	reddish brown, darkening	reddish grey to light brown
Tali	Alui, Eloun, Erum, Kassa, Muave	West, Central and East Africa	yellowish to reddish brown, veined	greyish white to yellowish
Teak	Kyun, Giathi, Tek Sak	South and South-East Asia	golden to yellowish brown, partly veined	whitish to grey
Tiama	Edinam, Kalungi, Timbi, Gedu nohor	West and Central Africa	light red to reddish brown, darkening	whitish to reddish grey
Weng	Awong, Mbotto, Nson-so	West Africa	light brown, veined, darkening	whitish to greyish white
Yang	Dau, Gurjun, Keruing, Dzao long	South and South-East Asia	greyish pink to reddish brown	greyish red
Zingana	Amouk, Zebrano, Izingana	West Africa	light brown to greyish brown, veined	whitish to grey

Trade name	Gross density ρ 12...15 in $\text{g} \cdot \text{cm}^{-3}$	Compressive strength δ dB in MPa	Bending strength δ bB in MPa	Tensile strength δ zB in MPa

Abura	0.45 to 0.64	32...53	56...95	$\delta zB \perp 1.7...3.0$
African Mahonany	0.45 to 0.62	36...58	36...126	$\delta zB \parallel 33...101$ $\delta zB \perp 1.7...2.3$
African Padouk	0.65 to 0.85	65...81	110...149	$\delta zB \perp 1.9...5.7$
Ail	0.36 to 0.57	33...49	27...84	$\delta zB \parallel 21...72$ $\delta zB \perp 1.6...2.6$
Avodir	0.50 to 0.60	40...57	52...113	$\delta zB \parallel 84...113$ $\delta zB \perp 2.1...2.9$
Bt	0.58 to 0.68	48...97	62...187	$\delta zB \parallel 52...173$ $\delta zB \perp 4.5...7.4$
Bilinga	0.70 to 0.90	47...73	85...130	$\delta zB \perp \approx 2.2$
Bintangor	0.48 to 0.66	43...60	48...107	$\delta zB \parallel 34...140$
Boss	0.55 to 0.65	45...61	74...110	$\delta zB \parallel 42...99$ $\delta zB \perp 2.0...2.4$
Bubinga	0.80 to 0.95	65...76	125...160	$\delta zB \perp 3.6...4.8$
Dabema	0.65 to 0.80	47...75	75...125	$\delta zB \perp 1.9...3.7$
Dark red meranti	0.59 to 0.89	53...74	77...158	$\delta zB \parallel 66...222$ $\delta zB \perp \approx 2.7$
Dibtou	0.43 to 0.65	33...47	56...89	$\delta zB \parallel 15...99$ $\delta zB \perp 1.6...2.1$
Douka	0.65 to 0.75	40...71	41...146	$\delta zB \parallel 30...127$ $\delta zB \perp 1.9...2.3$

DOUSSI	0.70 to 0.90	65...79	90...120	$\delta zB \perp 1.8...2.3$
Ebiaia	0.60 to 0.80	42...60	83...110	$\delta zB \perp 2.7...4.0$
Framir	0.45 to 0.60	35...53	37...115	$\delta zB \perp 1.2...2.3$
Ilomba	0.35 to 0.53	31...45	41...74	$\delta zB \parallel 45...76$ $\delta zB \perp 1.7...2.9$
Iroko	0.55 to 0.85	52...81	70...158	$\delta zB \parallel 55...140$ $\delta zB \perp 2.1...3.0$
Kosipo	0.59 to 0.65	49...63	88...121	$\delta zB \parallel 32...155$ $\delta zB \perp 1.9...3.5$
Krabak	0.64 to 0.69	40...69	72...132	$\delta zB \parallel 72...83$ $\delta zB \perp 3.8...5.6$
Limba	0.48 to 0.78	35...48	58..94	$\delta zB \parallel 26...165$ $\delta zB \perp 1.5.-2.8$
Makor	0.53 to 0.72	40...71	41...146	$\delta zB \parallel 30...127$ $\delta zB \perp 1.9...2.3$
Merawan	0.63 to 0.86	46...65	120...130	$\delta zB \perp 2.4...3.0$
Moabi	0.73 to 0.90	57...86	130...180	$\delta zB \perp 3.2...4.4$
Movingui	0.65 to 0.90	54...71	66...155	$\delta zB \parallel 27...96$ $\delta zB \perp 2.5...2.9$
Mukulungu	0.78 to 1.04	73...107	100...178	$\delta zB \parallel 100...166$
Naga	0.53 to 0.73	43...64	100...150	
Niangon	0.58 to 0.72	56...68	87...140	$\delta zB \perp 1.09...2.7$
Okoum	0.37 to 0.56	33...66	27...107	$\delta zB \parallel 23...125$

				$\delta zB \perp 1.5...2.1$
East Indian jacaranda	0.70 to 0.95	57...65	119...132	$\delta zB \perp 3.4...6.5$
Ozigo	0.50 to 0.75	58...71	110...130	$\delta zB \perp 2.6...4.0$
Sapelli	0.51 to 0.75	37...78	60...164	$\delta zB \parallel 53...154$ $\delta zB \perp 2.2...2.9$
Sipo	0.55 to 0.75	43...73	47...155	$\delta zB \parallel 57...164$ $\delta zB \perp 2.0...2.6$
Tali	0.85 to 1.07	75...86	120...150	$\delta zB \perp 2.7...4.0$
Teak	0.52 to 0.70	42...59	58...109	$\delta zB \parallel 95...155$ $\delta zB \perp 2.3...5.4$
Tiama	0.51 to 0.63	38...59	61...92	$\delta zB \perp 1.6...2.6$
Weng	0.75 to 0.95	68...90	115...170	$\delta zB \perp 2.5...2.8$
Yang	0.70 to 0.90	64...79	98...127	$\delta zB \parallel 97...127$ $\delta zB \perp 3.8...5.6$
Zingana	0.70 to 0.85	35...66	84...120	$\delta zB \perp 2.8...4.3$

Trade name	General properties	Effects detrimental to health	Applications
Abura	moderately hard, well workable, well cleavable, can well be stained, dyed, varnished and impregnated;	causes occasionally dermatitis*)	for peeled veneers, doors, windows, interior work, for furniture and model making

	susceptible to wood pests, not weather-proof		
African mahogany	well workable, can well be glued, stained and varnished, relatively resistant to wood pests, not weather-proof	causes dermatitis	for sliced veneers and peeled veneers, for furniture construction, interior work, for parquet, doors and windows
African Padouk	easily workable, can well be glued and especially well be varnished, resistant to wood pests and weather influence	causes dermatitis, grinding dust must well be sucked off	especially for sliced veneers, for building doors and windows, for parquet and furniture construction and interior work
Aiel	well cuttable, can well be nailed, screwed, glued, but is difficult to cleave; can well be stained and varnished; susceptible to wood pests, not weather-proof		for sliced and peeled veneers, in model making, for panelling and for packing
Avodir	well cuttable and cleavable, can well be nailed, screwed and glued as well as stained and varnished, hard to impregnate, susceptible to wood pests, especially to blue stain, not weather-proof	causes occasionally irritations of the mucosa	preferably for making sliced veneer, but also for parquet, panelling and in furniture construction
Bt	well workable, tools quickly get dull, well cleavable, can be stained	causes dermatitis	especially for sliced veneer, for windows and doors,

	and varnished, susceptible to animal wood pests, resistant to plant wood pests, weather-proof	and irritations of the mucosa, nausea, vertigo	panelling, parquet, in furniture construction and interior work
Bilinga	well cuttable, tools quickly get dull, can well be glued, stained, but is difficult to varnish, resistant to wood pests and weather influences	wood dust causes dermatitis	for sliced veneers, for building windows and doors, furniture, panelling, parquet and for interior work
Bintangor	easily workable, tools quickly get dull, can well be nailed and screwed, hard to cleave, susceptible to wood pests, weather-proof	skin irritations and disturbances of the general state of health possible	for veneer and plywood production, for furniture construction, for panelling and parquet, in boat building
Boss	well cuttable, tools quickly get dull, can well be glued and stained, but is difficult to varnish, resistant to wood pests and weather influences	wood dust causes dermatitis	for veneer production, in furniture production, for panelling and parquet, for building doors and windows
Bubinga	workable with difficulty, tools quickly get dull, hard to cleave, can well be glued, stained and varnished, resistant to wood pests and weather influences		for veneer production, for furniture construction, for parquet and panelling, in waggon and vehicle construction
Dabma	workable with difficulty, tools	causes	for manufacture of veneers,

	quickly get dull, tends to splintering, predrilling is suitable for nailing and screwing, can well be stained and varnished, resistant to wood pests and weather influences	occasionally irritations of the mucosa	in furniture construction, for parquet and panelling, for interior work
Dark red meranti	easily workable, tools quickly get dull, can well be nailed and screwed, hard to cleave, susceptible to wood pests, weather-proof		for manufacture of veneers and plywood for furniture, parquet, windows and doors, for interior work and for boat building and vehicle construction
Dibtou	easily workable, predrilling required for nailing and screwing, can well be glued, stained and varnished, hard to impregnate, susceptible to wood pests, not weather-proof	causes occasionally dermatitis	for sliced veneer, for furniture construction, for panelling and parquet, for interior work, vehicle construction and boat building
Douka	well workable, predrilling required for nailing and screwing, can well be glued, stained and varnished, relatively resistant to wood pests and weather influences	causes dermatitis, irritations of the mucosa and conjunctiva	for manufacture of veneers, for windows and doors, interior work, for furniture, parquet, in ship building, waggon and vehicle construction
Doussi	well workable, tools quickly get	exposure to	for peeled veneer, windows,

	dull, cannot be stained, hard to varnish, resistant to wood pests and weather influences	dust may result in irritations of the mucosa	doors, floor coverings, furniture, in ship building and bridge construction, especially for laboratory furniture and containers for chemicals
Ebiara	well workable, danger of discolouring, can well be stained and varnished and easily impregnated, susceptible to wood pests, not weather-proof		for manufacture of sliced veneer, for internal work, in furniture construction and manufacture of parquet
Framir	well cuttable and cleavable, can well be nailed, screwed, glued, stained and varnished, relatively resistant to wood pests, not weather-proof		for veneer and plywood production, for furniture, panelling, parquet, for windows and doors, interior work
Ilomba	can well be planed, milled, drilled, cleft, nailed, screwed, glued, stained and varnished, susceptible to wood pests, not weather-proof		for crossband veneers, packing and interior work, not suitable as building timber
Iroko	well workable, tools quickly get dull, predrilling required for nailing and screwing, can be varnished after pretreatment, cannot be impregnated, resistant to wood	causes occasionally dermatitis and irritations of the mucosa	for veneer and plywood production, for furniture, panelling, parquet, for doors and windows, for ship building and waggon

	pests, weather-proof		construction and timber-work
Kosipo	well workable, tools quickly get dull, predrilling required for nailing and screwing, can well be glued, stained and varnished, susceptible to animal wood pests, not weather-proof		for sliced and peeled veneers, for plywood production, for furniture panelling and parquet and interior work
Krabak	well workable, tools quickly get dull, can well be nailed and screwed, glued, stained and varnished, susceptible to wood pests, not weather-proof		for veneer and plywood production, for furniture, parquet and interior work
Limba	well workable, can well be glued, stained and varnished, susceptible to wood pests, weather-proof	prolonged inflammations caused by splinter injuries are possible	for veneer and plywood production, interior work, for doors and windows, parquet, panelling, for furniture and timber-work
Makor	well workable, tools quickly get dull, predrilling required for nailing and screwing, can well be glued, stained and varnished, relatively resistant to wood pests and weather influences	causes dermatitis, mucositis and conjunctivitis	for veneers, in furniture construction, for panelling, parquet, windows and doors, interior work, in ship building and waggon construction
Merawan	workable with difficulty, tools		for sliced and peeled

	quickly get dull, can well be glued, stained and varnished, insect-proof, weather-proof, relatively acid-proof, durable under water		veneers, interior work, for floor coverings, panellings, in vehicle construction and ship building
Moabi	well cuttable, tools quickly get dull, can well be glued, stained and varnished, relatively resistant to wood pests, weather-proof	causes irritations of the mucosa	for veneer and plywood production, for furniture, parquet, windows and doors, interior work, vehicle construction, boat building and bridge construction
Movingui	workable with difficulty, tools quickly get dull, predrilling required for nailing and screwing, hard to cleave and glue, can well be stained and varnished, difficult to impregnate	causes occasionally dermatitis	for sliced veneers, furniture, interior work, parquet, waggon construction, ship building and wood gluing work, for laboratory furniture and containers for chemicals
Mukulungu	well workable, tools quickly get dull, predrilling required for nailing and screwing, splinters, gluing difficult, paint coats badly adhere, hard to impregnate, acid-proof, resistant to wood pests and weather influences	causes irritations of the mucosa	for veneers, furniture, parquet, windows and doors, for interior work, waggon, vehicle and bridge construction, as timber for hydraulic engineering
Naga	well workable, predrilling required		for veneer and plywood

	for nailing and screwing, can well be glued, stained and varnished, heartwood can be impregnated,		production, for furniture and interior work, for windows, doors and floor coverings
Niangon	relatively resistant to wood pests well workable, cleavable with difficulty, predrilling required for nailing and screwing, pretreatment necessary before gluing and surface treatment, resistant to wood pests, weather-proof		for veneer production, for interior work, for parquet, windows, doors, in vehicle construction, hydraulic and bridge engineering and construction of wooden houses
Okoum	well workable, tools quickly get dull, can well be glued, stained and varnished, relatively resistant to wood pests, not weather-proof, fairly durable under water		for peeled veneer and plywood production, for furniture construction and interior work, for packing, in car body and boat building
East Indian jacaranda	well workable, tools quickly get dull, cleavable with difficulty, predrilling required for nailing and screwing, can well be glued, stained and varnished, resistant to wood pests, weather-proof	causes dermatitis	for sliced veneer production, for furniture, panelling, parquet, in model making and boat building
Ozigo	well workable, tools quickly get dull, can well be glued, stained and varnished, relatively resistant to wood pests, not weather-proof		for peeled veneer production, furniture construction, interior work, for parquet and packings



Sapelli	well workable, can well be glued, stained and varnished, relatively resistant to wood pests, not weather-proof		for sliced veneers, in furniture construction, for windows, doors, parquet, in vehicle construction and boat building
Sipo	well workable, can well be glued, stained and varnished, relatively resistant to wood pests, weatherproof		for veneer and plywood production, in furniture construction and interior work, for parquet, windows and doors, in vehicle construction and boat building
Tali	workable with difficulty, hard to cleave, tools quickly get dull, predrilling required for nailing and screwing, difficult to glue, can well be stained and varnished, resistant to wood pests, weatherproof	causes irritations of the mucosa	for veneer production, for parquet, windows, doors, floor coverings, in vehicle construction, bridge construction and mining, for containers for chemicals
Teak	well workable, predrilling required for nailing and screwing, tools quickly get dull, gluing and varnishing difficult, resistant to wood pests, weather-proof, acid-proof, inflammable with difficulty	causes occasionally dermatitis	for sliced veneers, in furniture construction, for parquet, windows, doors, for interior work, in vehicle construction and boat building, in hydraulic engineering, for containers

			for chemicals
Tiama	well workable, resin content causes clogging of the tools, can well be glued, stained and varnished, resistant to vegetable wood pests, but susceptible to animal wood pests, not weather-proof		for veneer and plywood production, for furniture, interior work, for parquet, windows, doors, in vehicle construction and boat building
Weng	well workable, predrilling required for nailing and screwing, gluing and surface treatment difficult, resistant to wood pests, weather-proof		for sliced veneers, for furniture, panellings, parquet, windows and doors, as structural timber in the building industry
Yang	workable with difficulty, tools quickly get dull, resin content causes clogging of the tools, hard to glue, surface treatment difficult, relatively resistant to wood pests, moderately weather-proof	causes dermatitis, irritations of the mucosa furunculosis	for veneer and plywood production, for windows and doors, for interior work, vehicle construction and ship building
Zingana	moderately well workable, cleavable with difficulty, can well be glued, stained and varnished, resistant to wood pests and weather influences		for sliced veneers, in furniture construction, for interior furnishing, for windows and doors

***) dermatitis - inflammation of the skin caused by external influences**

1.5. Wood Defects Caused by Growth Influences

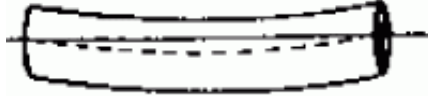
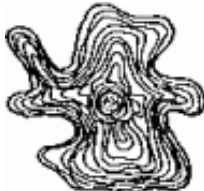
Defects of and damage to the wood are deviations from the normal quality.

Kind of defect	Description of defect	Consequences	Wood species concerned
taper	reduction of the trunk diameter by $1 \text{ cm} \cdot \text{m}^{-1}$	lower wood yield	Douka, Yang
curvature	 <p>curved deviation of the trunk from the straight line</p>	lower wood yield, warping, shakes	wood species mentioned under 1.4.
wavy rings	 <p>deviation from the normal trunk cross-section by pointed or round wave-shaped annual rings</p>	limited use, lower wood yield, strength variations, warping, shakes	African Padouk, Avodir, Tali
eccentric growth, heart displacement	 <p>deviations of the pith duct from the centre of the</p>	limited use, lower wood yield, strength variations, warping, shakes	African mahogany, Ail, Avodir, Bt, Dark red meranti, Dibetou, Douka, Ebiara, Framir, Ilomba, Kosipo, Limba, Krabak, Moabi, Mukulungu, Niangon, Okoum, Ozigo Tali, Teak

	cross-section visible in the cross-section		
spiral growth	helical wood fibre direction around the trunk axis	limited use, lower strength, shakes, warping	Abura
tension wood	wood zones on the upper side of crooked trunks and branches which appear to be of lighter colour than the surrounding wood	greater swelling and shrinkage, due to warping, shakes, working is more difficult	Doussi
ring shakes	circular shakes following the annual rings mainly in the lower part of the trunk	unusable as timber	African Padouk, Framier
knottiness	excessive existence of a great number of knots, in particular also dry, dead knots	lower wood yield, lower quality of the timber, reduced strength	Abura, Avodir, Bt, Dibetou, Framir, Limba, Krabak, Mukulungu, Niangon, East Indian jacaranda. Teak, Weng
shakes	separations of the fibre	limited use,	almost all wood species

	structure which may occur as radial and tangential shakes	lower wood yield, possibly not usable as timber	described under 1.4.
resin galls, resin pockets	narrow tangential clefts in the trunk which are of varying length and filled with resins or latex *)	working is made more difficult, limited use, lower wood yield, lower strength	Bitangor, Bubinga, Makor, Tiama, Yang, Zingana
false heartwood, coloured heart-wood	differently coloured inner zone or the trunk depending on the wood species (brown, yellowish, green and other colours)	lower wood yield, limited use, lower quality of the final product	Tiama
figured growth burls	great nodular accumulation of a large number of dormant buds concentrated in a very confined space	low strength, working is made more difficult	
blue stain and other discoloration caused by fungi	blue stain, but also fungus attack occurring as blue-green or brown discoloration of the wood, which may be accompanied by decay or insect damage	limited use, surface treatment made more difficult, reduced	Abura, African mahogany, Ail, Avodir, Boss, Douka, Ebiara, Framir, Ilomba, Krabak, Limba, Makor, Movingui, Naga, Okoum, Ozigo, Sapelli, Tiama

***) latex: rubber milk**

