

- ➔ **Making of Parquetry - Course: Timberwork techniques. Instruction examples for practical vocational training (Institut fr Berufliche Entwicklung, 24 p.)**
- 📄 **(introduction...)**
  - 📄 **Preliminary Remarks**
  - 📄 **Instruction Example 7.1.: Determining the Material Requirement of Single Parts of Parquetry for a Given Room**
  - 📄 **Instruction Example 7.2.: Laying of Mosaic Parquetry**
  - 📄 **Instruction Example 7.3.: Laying of Parquetry - Technique: pasted on solid ceiling, belt or ship's bottom pattern, parquetry-fillet with fixed tongue**
  - 📄 **Instruction Example 7.4.: Laying of Parquetry - Technique: nailed on planed boarded floor, belt or ship's bottom pattern, parquetry-fillets with movable tongues**
  - 📄 **Instruction Example 7.5.: Finishing and Sealing of Parquetry**

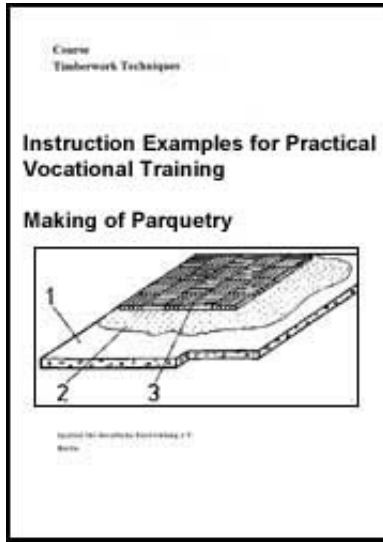

- 📖 **Making of Parquetry - Course: Timberwork techniques. Instruction examples for practical vocational training (Institut fr Berufliche Entwicklung, 24 p.)**



***(introduction...)***

**Preliminary Remarks**



**Instruction Example 7.1.: Determining the Material Requirement of Single Parts of Parquetry for a Given Room**



**Instruction Example 7.2.: Laying of Mosaic Parquetry**



**Instruction Example 7.3.: Laying of Parquetry - Technique: pasted on solid ceiling, belt or ship's bottom pattern, parquetry-fillet with fixed tongue**



**Instruction Example 7.4.: Laying of Parquetry - Technique: nailed on planed boarded floor, belt or ship's bottom pattern, parquetry-fillets with movable tongues**



**Instruction Example 7.5.: Finishing and Sealing of Parquetry**

**Institut fr berufliche Entwicklung e.V.  
Berlin**

**Original title:  
Lehrbeispiele fr die berufspraktische Ausbildung  
"Herstellen von Parketts"**

**Author: Peter Wehrmann**

**First Edition © IBE**

**Institut fr berufliche Entwicklung e.V.**  
**Parkstrae 21/23**  
**13187 Berlin**

**Order No.: 93-33-3607/2**



[Home](#) > [ar](#).[cn](#).[de](#).[en](#).[es](#).[fr](#).[id](#).[it](#).[ph](#).[po](#).[ru](#).[sw](#)

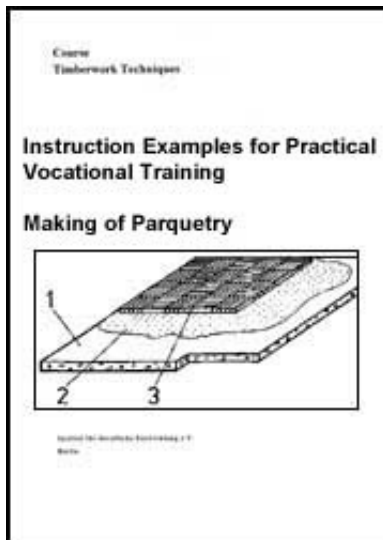

 **Making of Parquetry - Course: Timberwork techniques. Instruction examples for practical vocational training (Institut fr Berufliche Entwicklung, 24 p.)**

 **(introduction...)**

  **Preliminary Remarks**

 **Instruction Example 7.1.: Determining the Material Requirement of Single Parts of Parquetry for a Given Room**

 **Instruction Example 7.2.: Laying of Mosaic Parquetry**

 **Instruction Example 7.3.: Laying of Parquetry - Technique: pasted on solid ceiling, belt or ship's bottom pattern, parquetry-fillet with fixed tongue**

 **Instruction Example 7.4.: Laying of Parquetry - Technique: nailed on planed boarded floor, belt or ship's bottom pattern, parquetry-fillets with movable tongues**



## **Instruction Example 7.5.: Finishing and Sealing of Parquetry**

### **Preliminary Remarks**

**The present material includes 5 selected instruction examples on the basis of which the laying of parquetry can be practised.**

**The instruction examples are organized in such way that by solving the tasks of the first example the material in the form of parquetry-fillets required for the second, third and fourth examples is determined.**

**In the course of the instruction examples 2-4, the various operations of laying of parquetry are carried out.**

**Instruction Example 7.5. deals with the finishing of parquetry.**

**In order to facilitate the preparation and carrying out of the respective operations, the materials, tools, measuring and testing means as well as auxiliary accessories required for each instruction example are indicated.**

**Furthermore, the basic knowledge is mentioned which is required besides mastering the technique "Making of Parquetry". It is recommended to repeat this basic knowledge before starting the exercises.**

**Observing the given sequence of operations will result in a good quality of work.**







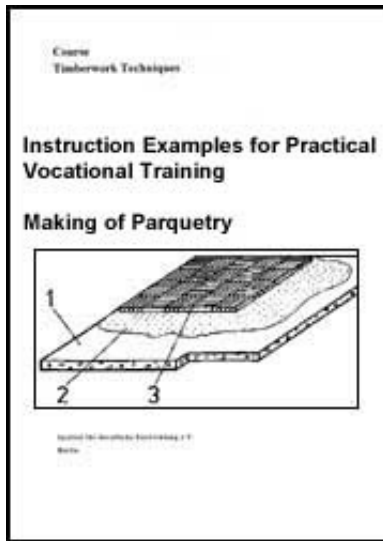

**A working drawing is attached to each instruction example, that will facilitate the technological approach.**

**The fixing of the skirting board is not explained in the present instruction examples. Information on this can be taken from the material on "Making of Floors".**



[Home](#) > [ar](#).[cn](#).[de](#).[en](#).[es](#).[fr](#).[id](#).[it](#).[ph](#).[po](#).[ru](#).[sw](#)



-  **Making of Parquetry - Course: Timberwork techniques. Instruction examples for practical vocational training (Institut fr Berufliche Entwicklung, 24 p.)**
-  **(introduction...)**
-  **Preliminary Remarks**
-  **Instruction Example 7.1.: Determining the Material Requirement of Single Parts of Parquetry for a Given Room**
-  **Instruction Example 7.2.: Laying of Mosaic Parquetry**
-  **Instruction Example 7.3.: Laying of Parquetry - Technique: pasted on solid ceiling, belt or ship's bottom pattern, parquetry-fillet with fixed tongue**
-  **Instruction Example 7.4.: Laying of Parquetry - Technique: nailed on planed boarded floor, belt or ship's bottom pattern, parquetry-fillets with movable tongues**
-  **Instruction Example 7.5.: Finishing and Sealing of Parquetry**

## **Instruction Example 7.1.: Determining the Material Requirement of Single Parts of Parquetry for a Given Room**

**Practising material calculations for determining the required number of single parts of parquetry.**

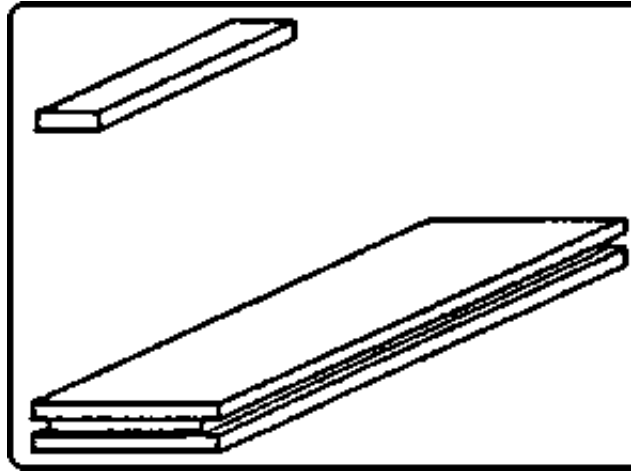

**Figure**

**Measuring and testing means**

**Folding rule, steel tape measure**

**Auxiliary accessories**

**Pocket calculator, paper, pencil**

**Required basic knowledge**

## Using length measuring instruments, mastering fundamental operations such as multiplying and dividing

### Explanations to the working drawing

#### 1 Mosaic parquetry-fillet

#### 2 Parquetry-fillet

#### 3 Surface of the room to be calculated

Sequence of operations	Comments
1. Preparing writing paper, pencil and measuring equipment.	Taking this equipment to the room that shall be measured.
2. Measuring the dimensions of the room and writing them down on a hand drawing.	Making the free-hand sketch in the room itself ("on the spot").
3. Calculating the surface of the room	The calculations should be made at a working table with seats. Using a pocket calculator is recommended.
<u>given:</u> - dimensions of the room - dimensions of the surfaces of the parquetry-fillets	
<u>to be determined:</u> - required number of mosaic parquetry-fillets - required number of parquetry-fillets	
$F_1 = a \cdot b$	$F_1 =$ surface without recess (total)

$$F_1 = 5030 \text{ mm} \cdot 5500 \text{ mm}$$

$$F_1 = 27\,665\,000 \text{ mm}^2$$

$$F_2 = 2100 \text{ mm} \cdot 2600 \text{ mm}$$

$$F_2 = 5\,460\,000 \text{ mm}^2$$

$$F_R = F_1 - F_2$$

$$F_R = 27\,665\,000 \text{ mm}^2 - 5\,460\,000 \text{ mm}^2$$

$$F_R = 22\,205\,000 \text{ mm}^2$$

$F_2$  = surface of the recess

$F_R$  = surface of the room (real)

4. Calculation of the surface of the given mosaic parquetry-fillet

$$F_{MP} = b \cdot l$$

$$F_{MP} = 20 \text{ mm} \cdot 120 \text{ mm}$$

$$F_{MP} = 2\,400 \text{ mm}^2$$

$F_{MP}$  = surface of the mosaic parquetry-fillet

5. Calculation of the surface of the given parquetry-fillet

$$F_{SP} = b \cdot l$$

$$F_{SP} = 60 \text{ mm} \cdot 400 \text{ mm}$$

$$F_{SP} = 24\,000 \text{ mm}^2$$

$F_{SP}$  = surface of the parquetry-fillet

6. Calculation of the required number of mosaic parquetry-fillets

$$MP = F_R : F_{MP}$$

MP = mosaic parquetry-fillet



$$MP = (22\,205\,000 \text{ mm}^2) / (2\,400 \text{ mm}^2)$$

$$MP = \underline{9252.08}$$

9300 mosaic parquetry-fillets are required.

Rounding the number up is necessary because waste material must be considered.

7. Calculation of the required number of parquetry-fillets

$$SP = F_R : F_{SP}$$

$$SP = (22\,205\,000 \text{ mm}^2) / (24\,000 \text{ mm}^2)$$

$$SP \underline{925.21}$$

SP = parquetry-fillet

950 parquetry-fillets are required.

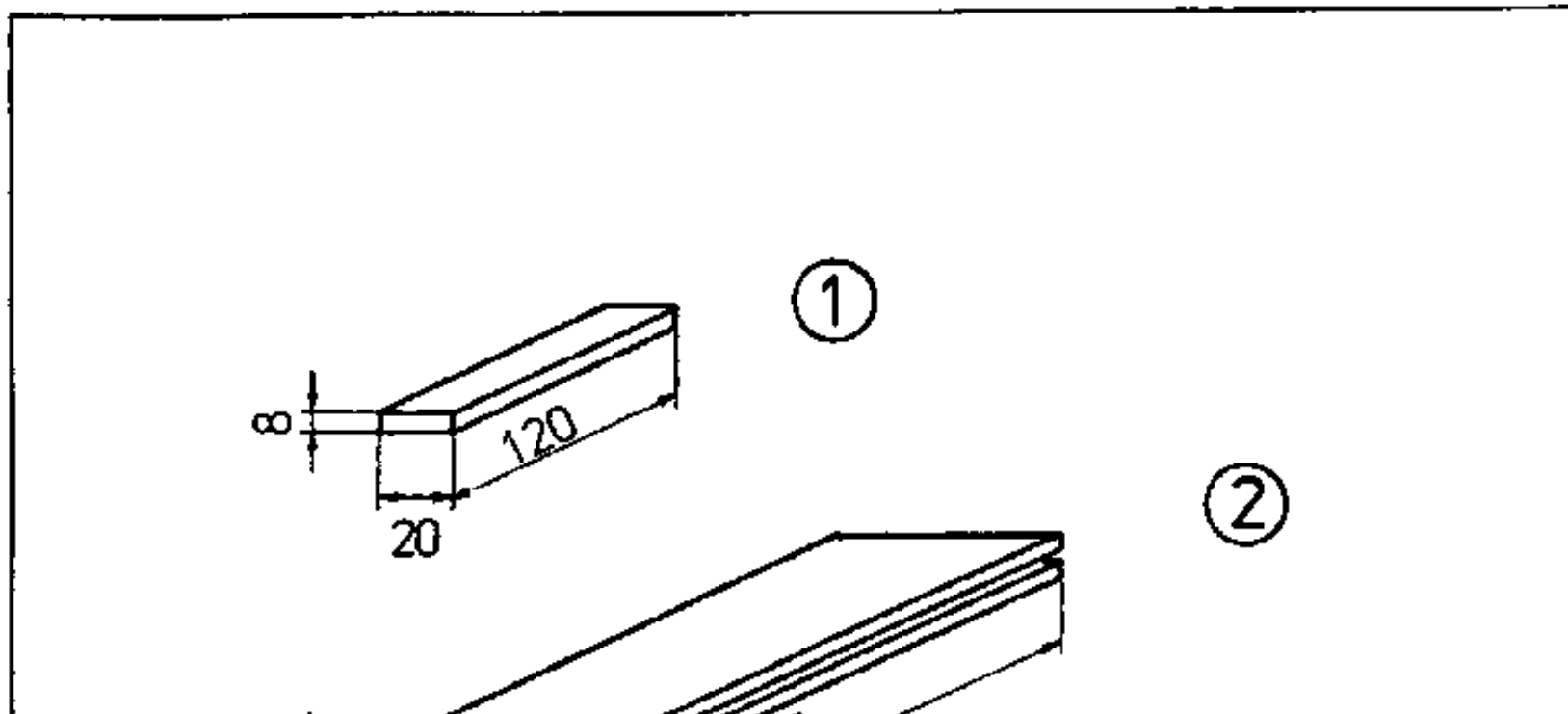

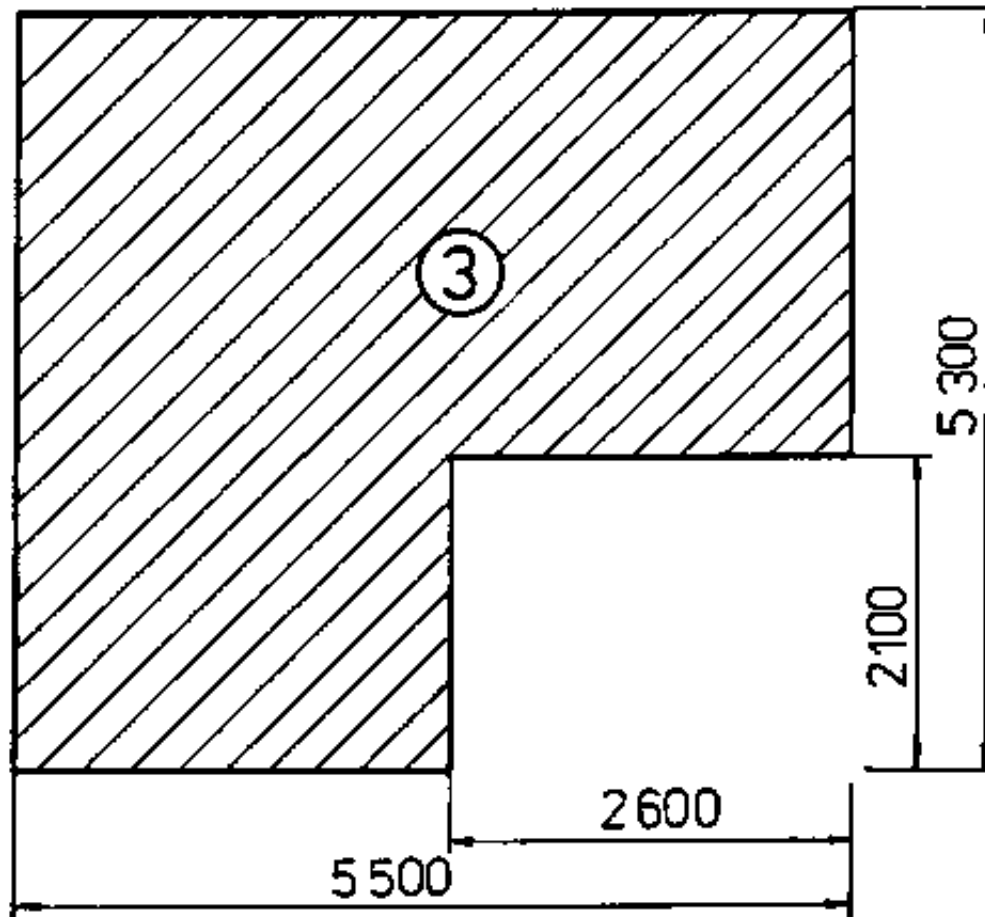
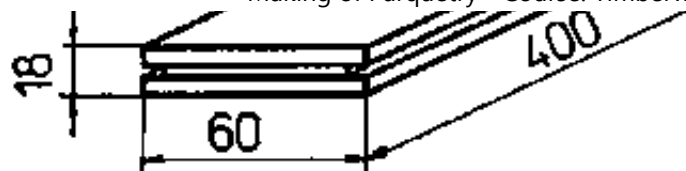







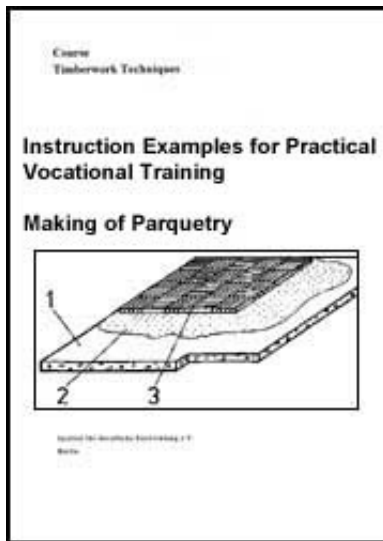

				7.1.
<b>IBE</b>	<b>Single parts of parquetry</b>			<b>3607</b>

## Single parts of parquetry



[Home](#) > [ar](#).[cn](#).[de](#).[en](#).[es](#).[fr](#).[id](#).[it](#).[ph](#).[po](#).[ru](#).[sw](#)



-  **Making of Parquetry - Course: Timberwork techniques. Instruction examples for practical vocational training (Institut fr Berufliche Entwicklung, 24 p.)**
-  **(introduction...)**
-  **Preliminary Remarks**
-  **Instruction Example 7.1.: Determining the Material Requirement of Single Parts of Parquetry for a Given Room**
-   **Instruction Example 7.2.: Laying of Mosaic Parquetry**
-  **Instruction Example 7.3.: Laying of Parquetry - Technique: pasted on solid ceiling, belt or ship's bottom pattern, parquetry-fillet with fixed tongue**
-  **Instruction Example 7.4.: Laying of Parquetry - Technique: nailed on planed boarded floor, belt or ship's bottom pattern, parquetry-fillets with movable tongues**

## **Instruction Example 7.5.: Finishing and Sealing of Parquetry**

### **Instruction Example 7.2.: Laying of Mosaic Parquetry**

**Technique: pasted on solid ceiling**

**Practising of mosaic parquetry laying**

**Material**

**Mosaic parquetry-fillets, parquetry adhesive, adhesive thinner**

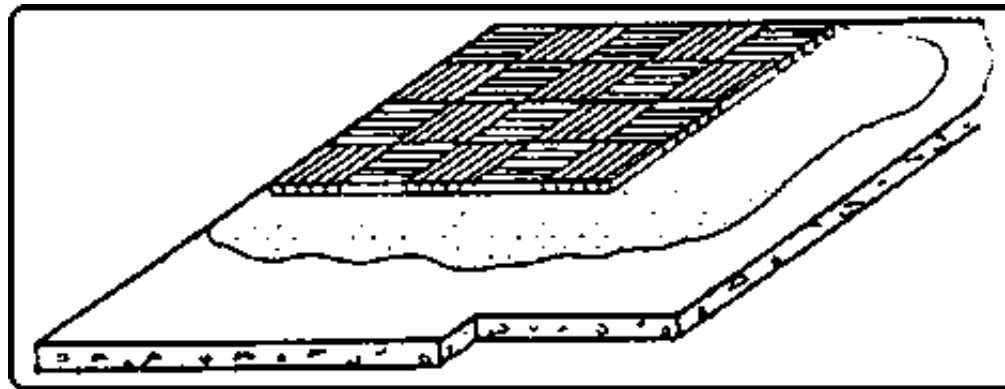

**Figure**

**Tools**

**Hand saw, hammer, plane, broom, pushing and drawing scrapers**

**Measuring and testing means**

## **Try square, flat square, folding rule, pencil, water-level, pipe-level**

### **Auxiliary accessories**

**Bucket, string, steel bolts, knee pad**

### **Required basic knowledge**

**Scribing, sawing, adhesive processing, laying of building components along a string, jointing**

### **Explanations to the working drawing**

**1 subfloor, 2 adhesive bed, 3 mosaic parquetry, 4 string, 5 distance to the wall, 6 steel bolt, 7 1st laying direction, 8 2nd laying direction**

<b>Sequence of operations</b>	<b>Comments</b>
1. Checking the subfloor for strength, moisture content and horizontal surface.	Subfloor must be free of cracks, firm, retain a constant volume and be <u>dry</u> . The horizontal surface has to be checked with the help of a pipe-level, straight-edge or water-level.
2. Taking small parquetry-fillets, as many as required (vis. instruction example 1), and transporting them to the place of use,	Faulty fillets are sorted out, processing losses have to be considered.
3. Drawing off adhesive and thinner and transporting	Attention!

them to the place of use.	Pay attention to the instructions of the manufacturer - often toxic or injurious to health.
4. Preparing tools and auxiliary accessories and arranging the working place.	Make sure that the equipment is complete.
5. Cleaning the subfloor with broom, if necessary with pushing scraper; removing the dirt.	
6. Preparing primary coat and spreading it.	<p>Primary coat is made from thinned adhesive and is applied by sectors, evenly and over the entire surface of each sector by a drawing scraper.</p> <p>Observe regulations on health protection: Knee-pad, risk of splashing in the eyes, of acid skin burn, of poisonous and sometimes inflammable vapours.</p>
7. Distributing the small parquetry-fillets and putting up a string for alignment. (Vis. working drawing)	Pay attention to the angles and to parallelism.
8. Spreading the adhesive with the drawing scraper and putting the small parquetry-fillets on the adhesive coat by sectors. Pressing the fillets on firmly and accurately along the string and fixing them by slight	When laying the fillets, observe the intended pattern. Be absolutely accurate along the alignment string.

hammer blows.

9. Cleaning the working place.

Replace faulty fillets, consider

colour and grain deviations.  
Remove replaced fillets etc.; clean the tools, close vessels and take all this out of the room.

Let the parquetry set for at least 2 days.

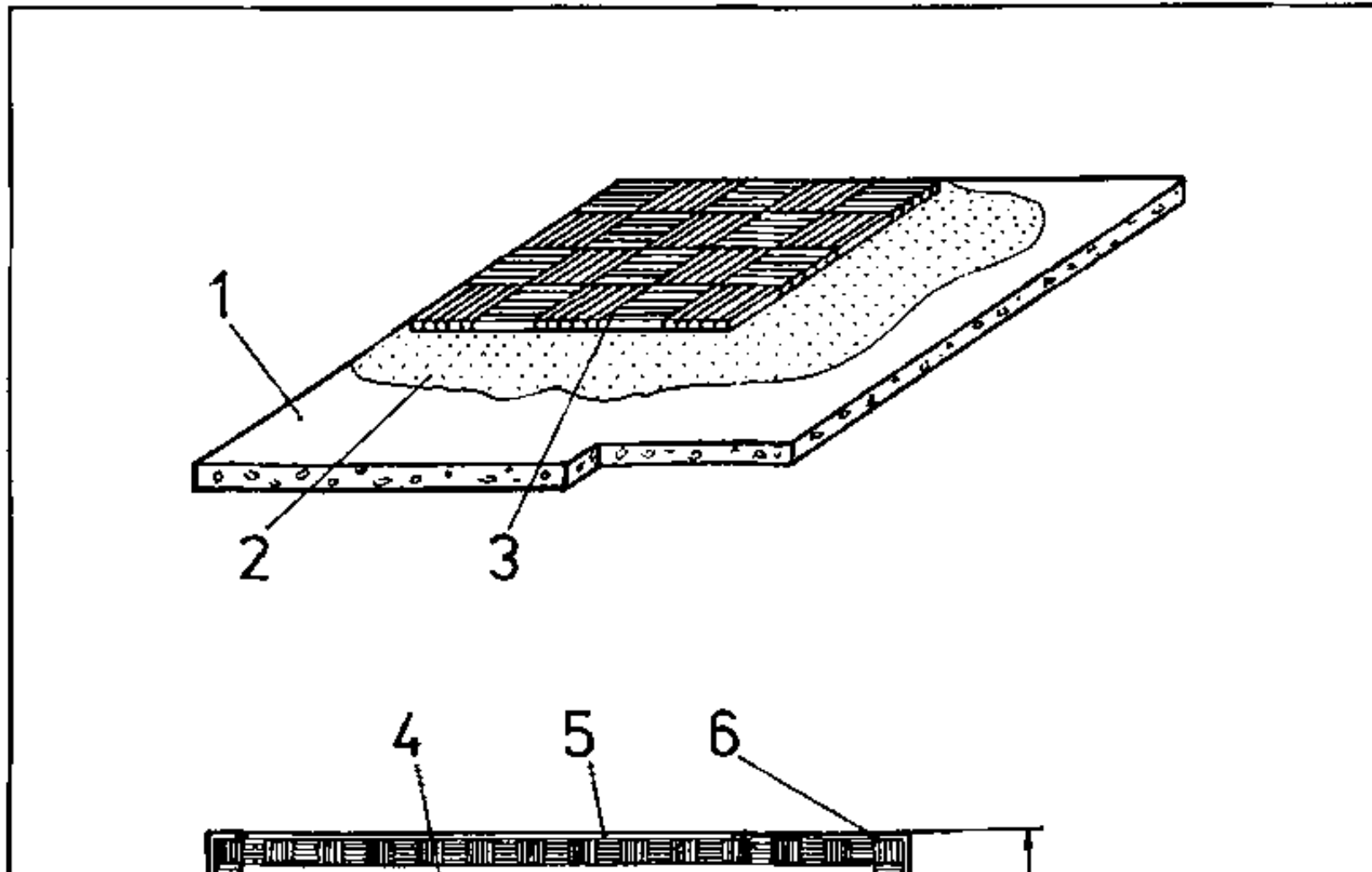

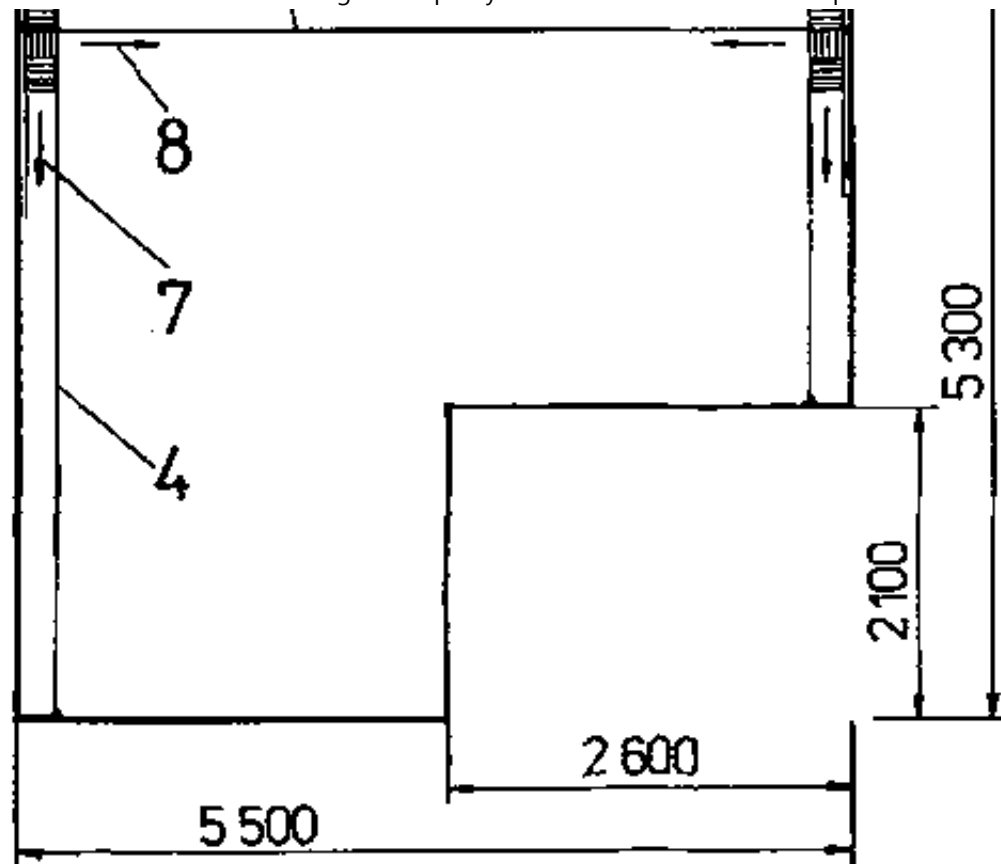

				7.2.
<b>IBE</b>	<b>Mosaic parquetry-fillets</b>			<b>3607</b>









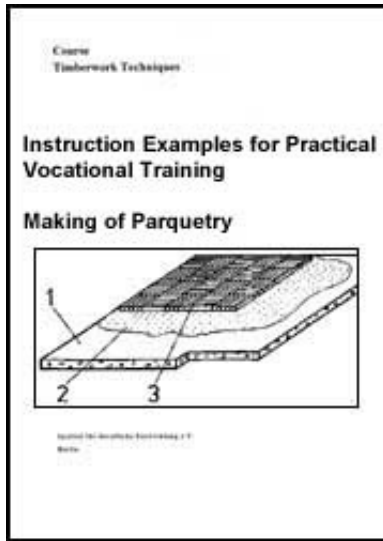

## Mosaic parquetry-fillets



[Home](#) > [ar](#).[cn](#).[de](#).[en](#).[es](#).[fr](#).[id](#).[it](#).[ph](#).[po](#).[ru](#).[sw](#)



-  **Making of Parquetry - Course: Timberwork techniques. Instruction examples for practical vocational training (Institut fr Berufliche Entwicklung, 24 p.)**
  -  **(introduction...)**
  -  **Preliminary Remarks**
  -  **Instruction Example 7.1.: Determining the Material Requirement of Single Parts of Parquetry for a Given Room**
  -  **Instruction Example 7.2.: Laying of Mosaic Parquetry**
  -  **Instruction Example 7.3.: Laying of Parquetry -**
    -  **Technique: pasted on solid ceiling, belt or ship's bottom pattern, parquetry-fillet with fixed tongue**
  -  **Instruction Example 7.4.: Laying of Parquetry -**
    - Technique: nailed on planed boarded floor, belt or ship's bottom pattern, parquetry-fillets with movable tongues**
  -  **Instruction Example 7.5.: Finishing and Sealing of Parquetry**

**Instruction Example 7.3.: Laying of Parquetry - Technique: pasted on solid ceiling,**

## **belt or ship's bottom pattern, parquetry-fillet with fixed tongue**

**Practising of parquetry laying according to the above mentioned technique.**

### **Material**

**Parquetry-fillets, parquetry adhesive, adhesive thinner, sealing cardboard such as bituminous felt, bare, cold glue for wood.**

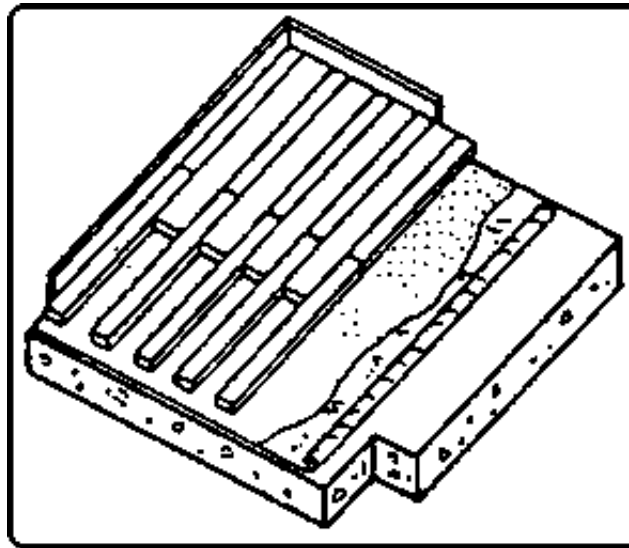

**Figure**

### **Tools**

**Hans saw, circular saw bench, hammer, plane, tow hook, broom, pushing scraper, drawing scraper**

### **Measuring and testing means**

## **Try square, flat square, folding rule, pencil, water-level, pipe-level**

### **Auxiliary accessories**

**Bucket, string, steel bolt, knee pad**

### **Required basic knowledge**

**Scribing, sawing, glue processing, laying of construction elements along the string, jointing**

### **Explanations to the working drawing**

**1 parquetry, 2 skirting board, 3 glue bed, 4 bituminous felt, 5 subfloor, 6 string, 7 distance to the wall, 8 steel bolt, 9 bituminous felt webs, 10 1st laying direction, 11 2nd laying direction**

<b>Sequence of operations</b>	<b>Comments</b>
1. Checking the subfloor of the parquetry.	
2. Cleaning the subfloor carefully with hair broom and pushing scraper.	All foreign parts that can be made loose must be carefully removed.
3. Filling the glue in a bucket and transporting it to the working site together with the sealing cardboard.	Be careful when using glue, pay attention to the instructions of the

	manufacturer.
4. Unwinding sealing cardboard and cutting it to length.	The length of the webs must correspond to the dimensions of the room.
5. Laying of the cut webs with the lateral seams edge to edge, and fitted to recesses and projections.	The webs must not overlap in any place.
6. Rolling the unwound webs back to the middle of the respective web and - after the primary coat has been applied according to Instruction Example 7.2. - spreading the glue with the drawing scraper, rolling the webs in place again, pressing them on and rubbing them into the glue.	On the opposite end of the webs the sequence of operations is analogous.
7. Putting up the string for the first two fillet rows on the steel nails driven in before, joining approximately 1 m of the length of the fillet row with the laying hammer (dry), putting the prepared piece under the string into the bed of glue, pressing it on and aligning it with the help of the string.	The string must be put up angularly and parallel to the room. Leave an air gap of 20 mm along the wall.
8. At the end of the two rows marking top cut, cutting with saw and laying with tow hook.	Before that, the last 3 fillets must get a cold glue coating on the head end.
9. Further laying of the parquetry rows along the string and by	Aligning the laid

analogy to the first two rows.

10. Remaining space to be covered with parquetry: If required, scribing longitudinal cut, cutting with circular saw bench and laying with tow hook.

11. Cleaning the working site.

parquetry fillets in the direction of the wall - check for horizontal position!  
Coat the last 3 fillets with cold glue on the longitudinal sides before.

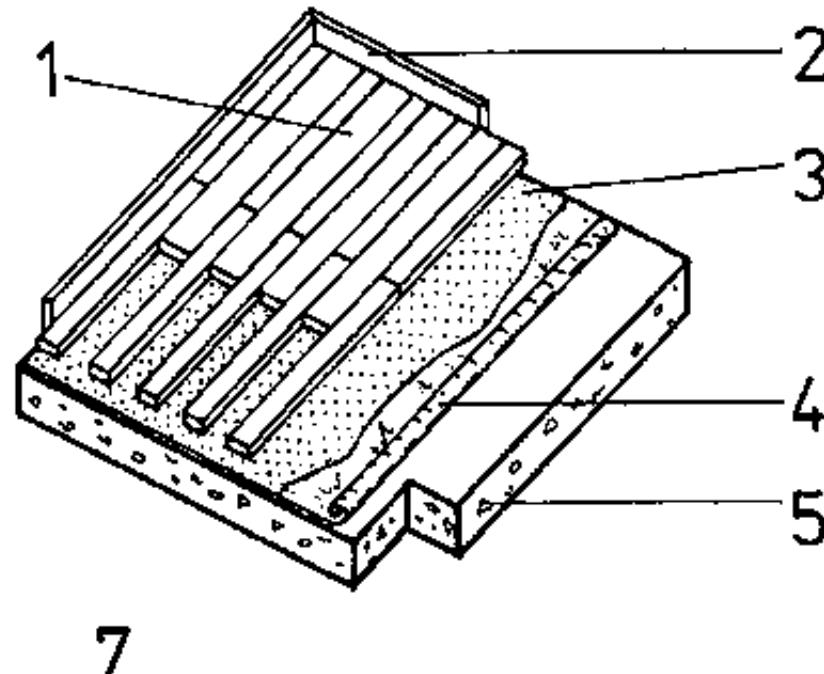

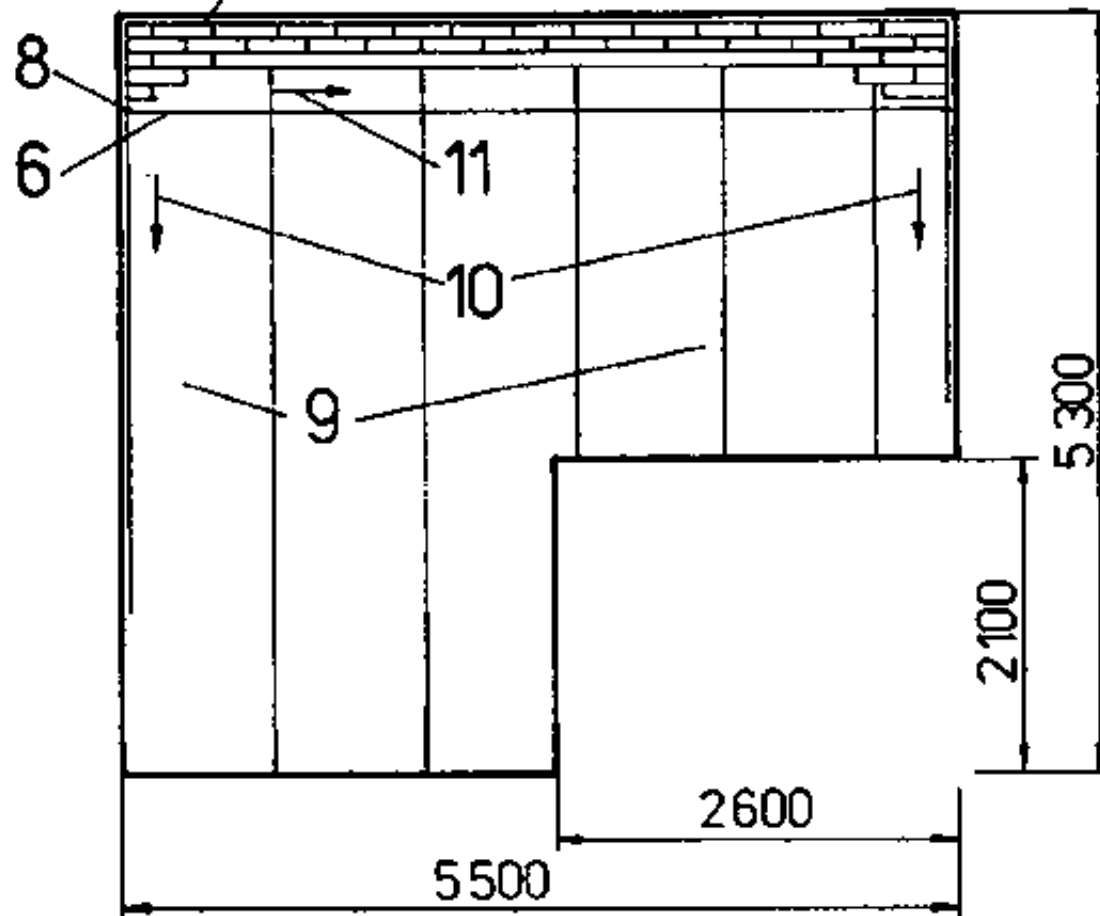







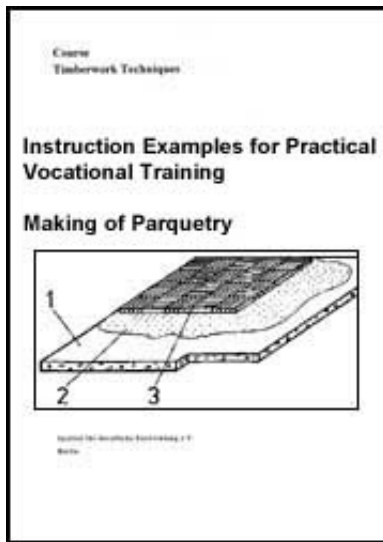

				7.3.

## Parquetry-fillets (pasted)



[Home](#) > [ar](#).[cn](#).[de](#).[en](#).[es](#).[fr](#).[id](#).[it](#).[ph](#).[po](#).[ru](#).[sw](#)



-  **Making of Parquetry - Course: Timberwork techniques. Instruction examples for practical vocational training (Institut fr Berufliche Entwicklung, 24 p.)**
-  **(introduction...)**
-  **Preliminary Remarks**
-  **Instruction Example 7.1.: Determining the Material Requirement of Single Parts of Parquetry for a Given Room**
-  **Instruction Example 7.2.: Laying of Mosaic Parquetry**
-  **Instruction Example 7.3.: Laying of Parquetry - Technique: pasted on solid ceiling, belt or ship's bottom pattern, parquetry-fillet with fixed tongue**
-  **Instruction Example 7.4.: Laying of Parquetry - Technique: nailed on planed boarded floor, belt or ship's bottom pattern, parquetry-fillets with movable tongues**
-  **Instruction Example 7.5.: Finishing and Sealing of Parquetry**



**Instruction Example 7.4. Laying of Parquetry - Technique: nailed on planed**

## **INSTRUCTION EXAMPLE 1.4.: Laying of Parquetry - Technique: nailed on planed boarded floor, belt or ship's bottom pattern, parquetry-fillets with movable tongues**

**Practising of parquetry laying according to the above technique.**

### **Material**

**Parquetry-fillets with tongues, countersunk nails  
(2 pieces per fillet)**

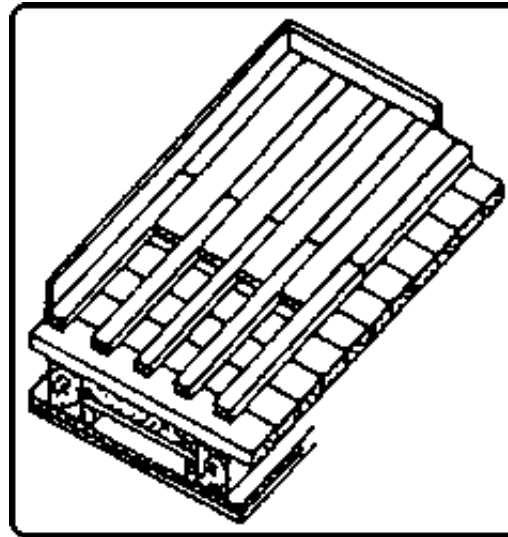

**Figure**

### **Tools**

**Hand saw, circular saw bench, hammer, nail tongs, plane, tow hook, nail punch, broom**



## Measuring and testing means

**Try square, flat square, folding rule, pencil, water-level, pipe-level**

## Auxiliary accessories

**String, steel bolts, knee pad**

## Required basic knowledge

**Scribing, sawing, laying of building components along the string, jointing**

## Explanations to the working drawing

**1 Skirting board, 2 parquetry, 3 planed deals, 4 timber beam, 5 ceiling structure, 6 string, 7 planed boarding, 8 steel bolt, 9 1st laying direction, 10 2nd laying direction, 11 1st layer of parquetry-fillets, 12 nailing of two sides (1st layer)**

<b>Sequence of operations</b>	<b>Comments</b>
1. Testing the wooden subfloor as to strength, moisture and vermin infestation.	The deals must be firmly nailed, must not project or be moist and must be free of vermin.
2. Sweeping the subfloor clean and removing the dust.	
3. Fixing the middle row and putting up the string along the middle row stretching it with the help of the steel bolts.	String must be angular and parallel to the wall.
4. Distributing the parquetry-fillets and putting in the tongues	Sort out faulty parquetry-

on one head end.

5. Laying the middle row of parquetry-fillets along the string and nailing them on the subfloor on both sides with two nails per fillet, scribing the head-end cut, sawing it and laying it with the help of the tow hook, coating the last three head ends with cold glue before.

fillets when distributing them.

The nails are driven obliquely into the rabbet. The nails are countersunk with the nail punch, so that in the rabbet no nail is in the way when the tongue is put in.

6. Distributing the required parquetry-fillets on the left and right sides of the middle row and putting the tongues in the fillets.

One tongue in one head end and longitudinal side, each.

7. Removing the string from the middle row and continuing to lay parquetry-fillets along the middle row, nailing each external end with 2 nails on the subfloor.

8. Cut final row, if required, longitudinally; therefore scribing, cutting to length and laying with tow hook. Coating the sides of the last row with cold glue before.

Leaving an air gap of 20 mm along the wall.

9. Cleaning the working place.



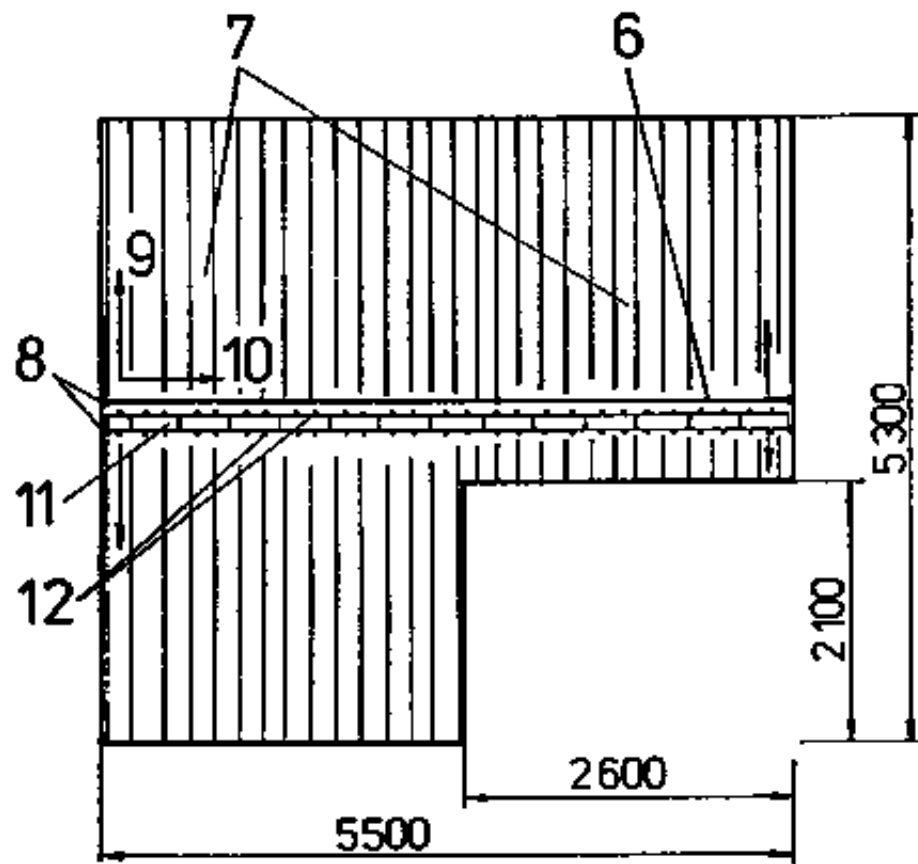
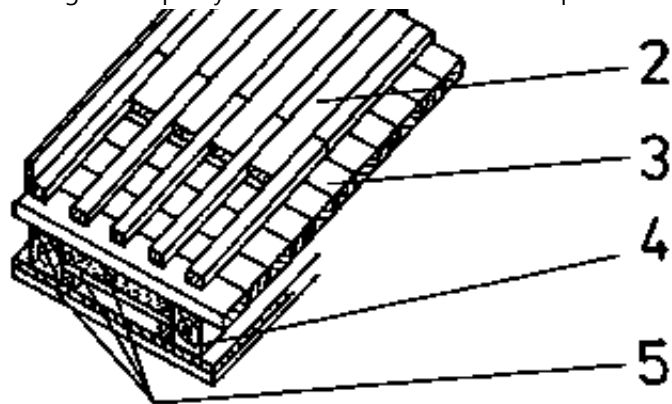

				7.4.
<b>IBE</b>	<b>Parquetry-fillets (nailed)</b>			<b>3607</b>





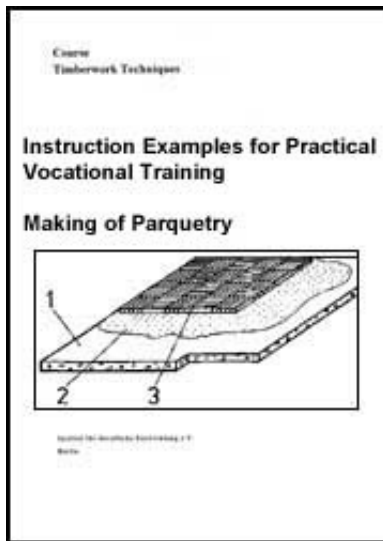

## Parquetry-fillets (nailed)



[Home](#) > [ar](#).[cn](#).[de](#).[en](#).[es](#).[fr](#).[id](#).[it](#).[ph](#).[po](#).[ru](#).[sw](#)



### **Making of Parquetry - Course: Timberwork techniques. Instruction examples for practical vocational training (Institut fr Berufliche Entwicklung, 24 p.)**

-  **(introduction...)**
-  **Preliminary Remarks**
-  **Instruction Example 7.1.: Determining the Material Requirement of Single Parts of Parquetry for a Given Room**
-  **Instruction Example 7.2.: Laying of Mosaic Parquetry**
-  **Instruction Example 7.3.: Laying of Parquetry - Technique: pasted on solid ceiling, belt or ship's bottom pattern, parquetry-fillet with fixed tongue**
-  **Instruction Example 7.4.: Laying of Parquetry - Technique: nailed on planed boarded floor, belt or ship's**

**bottom pattern, parquetry-fillets with movable tongues****Instruction Example 7.5.: Finishing and Sealing of Parquetry****Instruction Example 7.5.: Finishing and Sealing of Parquetry****Practising of parquetry finishing and sealing irrespective of the type of parquetry****Material****Parquetry sealing lacquer, thinner, joiner's putty****Tools****Broom, brush, paint roller, abrasive paper, sandpaper block, pushing scraper, grinder****Auxiliary accessories****Bucket, can****Required basic knowledge****Handling a grinder, working with parquetry sealing lacquers and knowledge of their properties, coating methods**

<b>Sequence of operations</b>	<b>Comments</b>
1. Once again cleaning parquetry thoroughly with	

broom, detecting small faults.	
2. Reworking faulty spots, such as cracks, knots and defective edges with the help of scraper and joiner's putty.	If - in spite of the careful selection of the parquetry-fillets - there should be deeper holes or defects, the joiner's putty is applied in layers.
3. Smoothing the floor with the grinder in circular motions until an even and plane surface is achieved.	When grinding, make sure that no corrugations appear.
4. Sweeping smoothed floor carefully.	Do only walk with soft and clean shoes on smoothed floor.
5. Putting on the first layer of the sealing lacquer - along the edges with brush, in the middle with paint roller.	When applying the lacquer coat make sure that no foreign bodies, such as shavings or rough particles of dust, are left under the lacquer coat.
6. After the first coating has dried, smoothing minor imperfections such as wood fibres that were put upright by fine-grained abrasive paper. Removing grinding dust carefully.	First coat will have dried after approximately 24 hours.
7. Applying two other coats of sealing lacquer at the appropriate intervals.	If required, unevennesses can be smoothed again here and there.
8. Cleaning the working place.	Painting tools are washed in thinner.

