

➔ **Maintenance and Storage of Wood - Course: Manual woodworking techniques. Trainees' handbook of lessons (Institut für Berufliche Entwicklung, 14 p.)**

- 📄 **(introduction...)**
- 📄 **1. Purpose and Meaning of Maintenance and Drying of Wood**
- 📄 **2. Ways of Drying and Storage of Sawn Timber**
- 📄 **3. Preparation of Storage of Sawn Timber**
- 📄 **(introduction...)**
- 📄 **3.1. Preparation of Sawn Timber**
- 📄 **3.2. Preparation of the Pile Base**
- 📄 **4. Construction of an Open-air Timber Storage Yard**
- 📄 **5. Construction of Sawn Timber Piles**

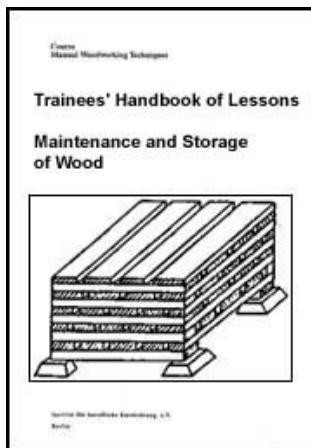

📖 **Maintenance and Storage of Wood - Course: Manual woodworking techniques. Trainees' handbook of lessons (Institut für Berufliche Entwicklung, 14 p.)**

- ➔ 📄 **(introduction...)**
- 📄 **1. Purpose and Meaning of Maintenance and Drying of Wood**
 - 📄 **2. Ways of Drying and Storage of Sawn Timber**
 - 📄 **3. Preparation of Storage of Sawn Timber**
 - 📄 **4. Construction of an Open-air Timber Storage Yard**
 - 📄 **5. Construction of Sawn Timber Piles**

**Institut für berufliche Entwicklung e.V.
Berlin**

Original title:

Arbeitsmaterial fr den Lernenden "Holzpflege und Holzlagerung"

Author: Rolf Jakoby

First edition © IBE

**Institut fr berufliche Entwicklung e.V.
Parkstrae 23
13187 Berlin**

Order No.: 93-35-3308/2



[Home](#) > [ar](#).[cn](#).[de](#).[en](#).[es](#).[fr](#).[id](#).[it](#).[ph](#).[po](#).[ru](#).[sw](#)

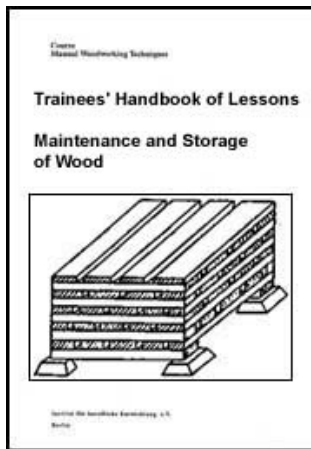

 **Maintenance and Storage of Wood - Course: Manual woodworking techniques. Trainees' handbook of lessons (Institut fr Berufliche Entwicklung, 14 p.)**

 **(introduction...)**

-   **1. Purpose and Meaning of Maintenance and Drying of Wood**
-  **2. Ways of Drying and Storage of Sawn Timber**
-  **3. Preparation of Storage of Sawn Timber**
-  **4. Construction of an Open-air Timber Storage Yard**
-  **5. Construction of Sawn Timber Piles**

1. Purpose and Meaning of Maintenance and Drying of Wood

Wood is an important and precious raw material. It can be used for many purposes, such as for the manufacture of

- furniture,

- **window frames,**
- **doors,**
- **interior furnishings,**
- **vehicle and ship components.**

Depending on the intended purpose of use, the logs cut down in the woods are

- **processed in veneer mills into veneer by chip-forming and chip less cutting,**
- **sawn in saw mills by cutting with the grain. Cutting-off of the rough edges is called edging.**

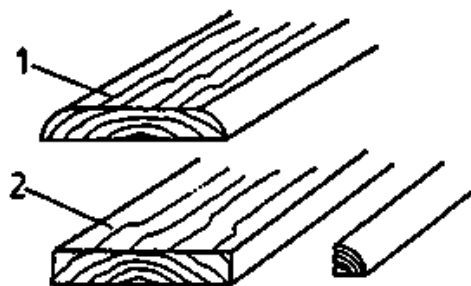





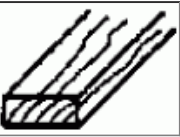
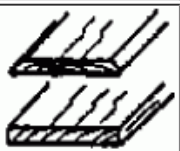
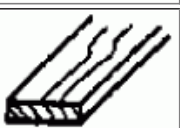

Figure 1 Cutting-off of the rough edges (1 unedged-sawn, 2 edged)

The sawn wood is called **sawn timber** which, depending on the different size and shape, is classified in the types of sawn timber as per table 1:

Table 1: Types of Sawn Timber

Sectional shape		Designation	Features	Thickness in mm	Width in mm
1/1		squared timber	edge	100	100
1/2		frame timber	edged	38 up to 100	2 × thickness
1/3		board	unedged-sawn	16	2 × thickness

					
			edged	16 up to 100	75
1/4		lath	edge	16 up to 100	75
1/5		ply	unedged- sawn or edged	6 up to 15	75
1/6		strip	edged	6 up to 15	75

After cutting-down and sawing the logs, the wood contains a considerable quantity of water.

The water contained in the wood (wood moisture content) influences the physicochemical properties of the wood.

Wet wood is difficult to work and changes its shape.

Any change of the relative air humidity, at a certain temperature, results in a change of the wood moisture content. This law applies to any type of wood and is the basis for maintenance, storage and drying of wood as well as for processing and working/machining of wood.

The moisture content in the wood is measured by means of the following methods and measuring instruments:

- Electrical measuring methods with resistance measuring instruments acc. to the principle of D.C. resistance measurement.**
- Kiln method (weighing method), where the water quantity contained in wood samples (small pieces of wood) is evaporated at 105°C in special drying kilns and determined by comparison**

weighing of the wood samples before and after evaporation.

The measure of the wood moisture content is the *moisture expressed as a percentage (in %) of dry wood substance (weight in g)*. It can be calculated acc. to the following formula:

$$\text{Moisture content of wood} = \frac{\text{wet weight of wood} - \text{dry weight of wood}}{\text{dry weight of wood}} \cdot 100\%$$

Task:

Calculate the moisture content of wood (in g and per cent) when

- the wet weight of a wood sample is 350 g,
- the dry weight of the sample is 200 g!

Depending on the purpose of use, the wood must have a certain moisture content when being worked/machined to retain

- its usability,
- its shape,
- its size.

Therefore, the excessive water is to be removed. This is done by controlled drying of the sawn timber.



[Home](#) > [ar.cn.de.en.es.fr.id.it.ph.po.ru.sw](#)



Trainees' handbook of lessons (Institut fr Berufliche Entwicklung, 14 p.)

(introduction...)

- 1. Purpose and Meaning of Maintenance and Drying of Wood**
- ➔ 2. Ways of Drying and Storage of Sawn Timber**
- 3. Preparation of Storage of Sawn Timber**
- 4. Construction of an Open-air Timber Storage Yard**
- 5. Construction of Sawn Timber Piles**

2. Ways of Drying and Storage of Sawn Timber

Basically there are two ways of drying sawn timber:

- Evaporation of the water contained in the wood ensues in the open air under natural climatic conditions until the moisture equilibrium is achieved. The period required for natural drying of wood until achievement of such state depends on the following factors:

- average local climate,**
- type of wood,**
- thickness of wood,**
- type of storage.**

The state of wood achieved in this way is called *air-dry*.

Evaporation of the water contained in the wood ensues in drying kilns under controlled conditions of heat, steam, air circulation.

Controlled drying of wood also calls for correct storage and maintenance of the sawn timber and protection against detrimental influences, such as:

- fungi changing and destroying the wood,**
- animal pests like insects or insect larvae,**

- **weather influences (rain, heavy solar radiation, storm).**

There are different ways of storing sawn timber, depending on the moisture content and purpose of use:

- **open-air timber yards,**
- **open or semi-open storage sheds,**
- **closed buildings.**



[Home](#) > [ar](#).[cn](#).[de](#).[en](#).[es](#).[fr](#).[id](#).[it](#).[ph](#).[po](#).[ru](#).[sw](#)

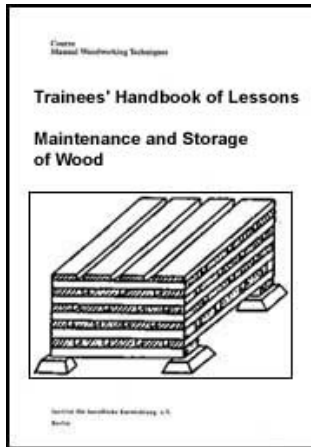

 **Maintenance and Storage of Wood - Course: Manual woodworking techniques. Trainees' handbook of lessons (Institut fr Berufliche Entwicklung, 14 p.)**

➔  **3. Preparation of Storage of Sawn Timber**

 **(introduction...)**

 **3.1. Preparation of Sawn Timber**

 **3.2. Preparation of the Pile Base**

Maintenance and Storage of Wood - Course: Manual woodworking techniques. Trainees' handbook of lessons (Institut fr Berufliche Entwicklung, 14 p.)

3. Preparation of Storage of Sawn Timber

Sawn timber is stored in piles of different types and sizes by putting the timbers side by side and one upon the other in a well-arranged order, normally using pile strips of wood. The pile is arranged on a prepared base ensuring a plane position of the timber and the necessary ground clearance for escape of humid air near the ground. Such base is made of pile stones and pile supports.

3.1. Preparation of Sawn Timber

Before the sawn timber is stored in piles, it is arranged and preliminarily stored for a short time, considering

- the type of wood,**
- the origin with respect to the trunk,**
- the dimensions,**
- quality features.**

Timbers infested with insects must be separated or prepared by cutting off the infested parts.

3.2. Preparation of the Pile Base

Pile stones and pile supports are to be made available.

Pile stones are made of concrete or of natural stone and have a large bearing surface. Recommended dimensions are:

- length = 400 mm,**
- width = 400 mm.**

The pile supports are made of steel sections or of squared timbers impregnated with wood preservatives. The dimensions are as follows:

- length = up to 1000 mm, depending on the pile width,**
- width = 100 mm,**
- thickness = 100 mm.**

The total height of the pile base is

- 300 mm on paved storage yards,**
- 400 mm on unsurfaced storage yards.**

The number of pile stones and pile supports depends on

- the pile length,
- the pile width,
- the centre-to-centre distance of the pile stones.

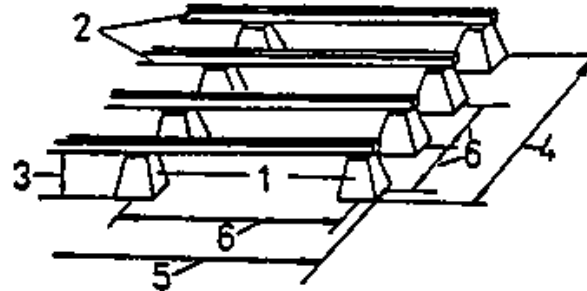

Figure 2 Pile base **1** pile stones, **2** squared timbers, **3** height of pile base, **4** pile length, **5** pile width, **6** centre-to-centre distance of pile stones

Pile strips are very important. They guarantee proper airing of the pile and prevent the sawn timber from changing its shape. They must be carefully arranged according to their dimensions:

- length = 1000 mm,
- width = 25 mm up to 50 mm,
- thickness = 25 mm.

Impregnation with wood preservatives improves their usability and prolongs their working life. Pile strips are to be stored under a roof to protect them from weather influences.



[Home](#) > [ar.cn.de.en.es.fr.id.it.ph.po.ru.sw](#)

 **Maintenance and Storage of Wood - Course: Manual woodworking techniques. Trainees' handbook of lessons (Institut fr Berufliche Entwicklung, 14 p.)**

 **(introduction...)**

 **1. Purpose and Meaning of Maintenance and Drying of Wood**

2. Ways of Drying and Storage of Sawn Timber

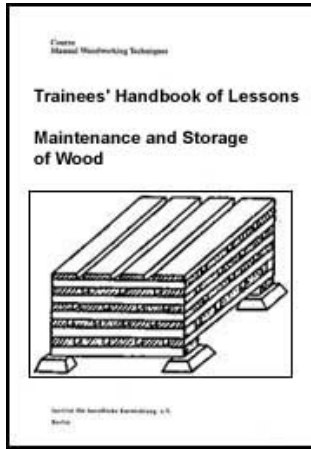

- ➔ 3: Preparation of Storage of Sawn Timber
- 4: Construction of an Open-air Timber Storage Yard
- 5: Construction of Sawn Timber Piles

4. Construction of an Open-air Timber Storage Yard

Open-air timber storage yards consist of:

- Pile areas

They are used for timber storage and must permit the longitudinal pile length to be arranged at an angle of 45 degrees up to 90 degrees to the main wind direction. Moreover, they must have a minimum distance of 10 m to the next public road and of 30 m to 50 m to neighbouring premises.

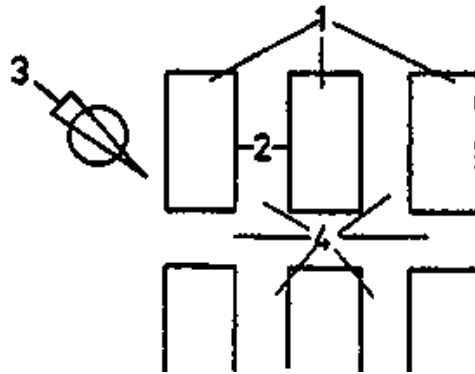

Figure 3 Components of timber storage yards 1 pile areas, 2 longitudinal pile sides, 3 main wind direction, 4 roads between the piles and lanes to prevent the spreading of fire

- Roads between the piles and lanes to prevent the spreading of fire

They are free areas between the pile areas for the purpose of:

- **stacker-truck traffic,**
- **walkways,**
- **fire-fighting.**

Their width depends on:

- **the width of the stacker trucks,**
- **the size of the neighbouring pile areas,**
- **the type of raw material and sawn timber stored.**

- Airing ways

They are gaps between the individual piles necessary for airing of the piles.

The ground of the pile areas has also to meet certain requirements. It should be plane and slightly inclined in the longitudinal direction of the pile (for the drainage of rainwater). Moreover, the ground should be free from growth, dirt, shifting sand, wood and bark waste.

Suitable ground surfacings are:

- **gravel,**
- **crushed rock,**
- **concrete.**

Clay or loam soil must be dewatered.

When constructing the pile base on the pile it is essential to make sure that it is of correct size and quality to guarantee the necessary stability of the pile and favourable storing and drying conditions for the sawn timber.

The pile stones are arranged on the pile area acc. to the following criteria:

- alignment (straightness) in

- height,
- pile length,
- pile width,

- horizontal position in pile width,

- equal spacing in

- pile length,
- pile width.

The centre-to-centre distance of the pile stones in longitudinal direction of the pile depends on the type of wood, the length and thickness of the sawn timber. It should amount to 1000 mm up to 1400 mm. The maximum centre-to-centre distance in the pile width should be 1000 mm.

Checking of the alignment of the pile stones in longitudinal direction of the pile and in pile width direction ensues by:

- putting a long straightedge on the pile stones,
- putting the straightedge to the sides of the pile stones or
- by stretching a line over and besides the pile stones and
- by visual comparison of the pile stones with the testing means.

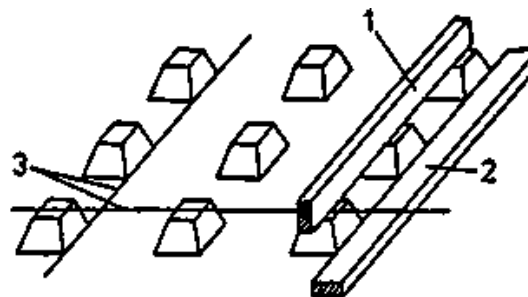

Figure 4 Checking of alignment of the pile stones 1 straightedge put on pile stones, 2 straight edge

put to the sides of pile stones, 3 stretched line

The pile stones are in alignment when there are no visible gaps between the tested surfaces and the testing means.

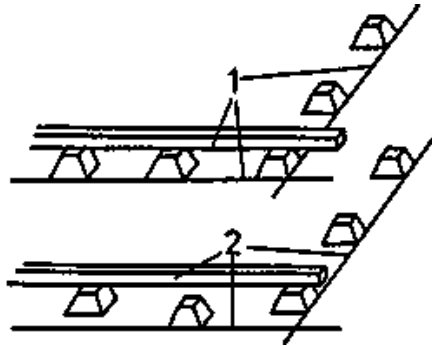

Figure 5 Checking of alignment of the pile stones *1 in alignment, 2 not in alignment*

The horizontal position of the pile stones in pile width direction is checked by putting a water level onto the straightedge.

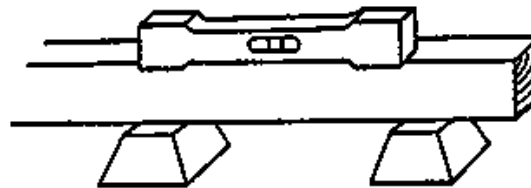

Figure 6

The pile supports are put on the pile stones with their longitudinal direction in pile width direction and in parallel to each other. The alignment and horizontal position of the pile supports are checked in the same way as checking of the position of the pile stones.



[Home](#) > [ar.cn.de.en.es.fr.id.it.ph.po.ru.sw](#)

**Maintenance and Storage of Wood - Course: Manual woodworking techniques.
Trainees' handbook of lessons (Institut fr Berufliche Entwicklung, 14 p.)**

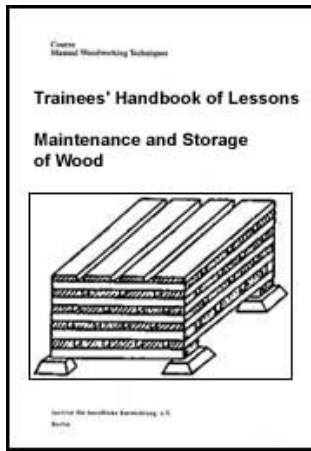

- (introduction...)**
1. Purpose and Meaning of Maintenance and Drying of Wood
 2. Ways of Drying and Storage of Sawn Timber
 3. Preparation of Storage of Sawn Timber
 4. Construction of an Open-air Timber Storage Yard
 - ➔ 5. Construction of Sawn Timber Piles

5. Construction of Sawn Timber Piles

Piles of different types are constructed for open-air storage and drying of sawn timber. The type of pile depends on:

- the type of sawn timber,
- the dimensions,
- the moisture content,
- the intended period of storage

of the sawn timber to be stored.

The construction of the pile must guarantee storage and drying of the sawn timber free from damage and meet the requirements of labour safety. Therefore, the following rules must be observed:

- Sawn timber of equal type, equal thickness, equal type of wood and, if possible, equal length only should be stored in each pile.
- When horizontally storing sawn timber of different length, the longest timbers should be stored at the bottom and the shortest timbers on the top of the pile.
- The outsides of the piles should be vertical.

- **Boards should be stored with the wide face near the heart showing upwards.**

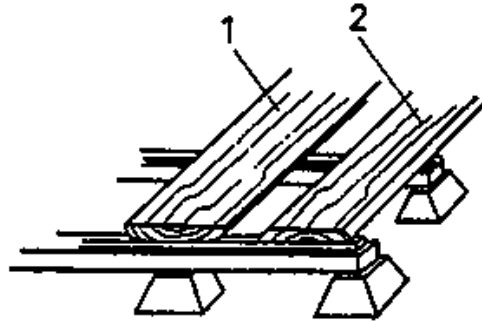

Figure 7 Storage of boards in piles of sawn timber 1 correct storage, 2 wrong storage

- **The lateral distance between edged boards and frame timbers should be at least 30 mm.**
- **Piles with high-quality sawn timber should be covered on top to protect the wood against detrimental weather influences. The covering plates must be firmly secured.**
- **For identification of the stored timber, identification plates should be fixed to sawn-timber piles showing features like:**
 - **type of wood,**
 - **board thickness,**
 - **pile volume in m³,**
 - **date of storage...**

Wet timber is stored and dried in the following types of piles: *box-type piles, package-type piles and block-type piles* using pile strips. Pile strips of equal length only are to be used for this purpose.

The pile strips at the bottom are to be put directly on the pile supports, the next strips are to be put exactly in vertical alignment with the pile strips beneath and between the layers of sawn timber.

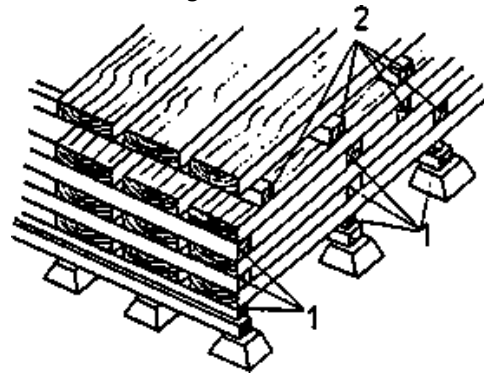

Figure 8 Position of pile strips in piles of sawn timber 1 correct position, 2 wrong position

Moreover, it is important that the edges of the pile strips, at least at one wide side of the pile, are in alignment or slightly projecting only with respect to the gross-grained faces of the sawn timber (except for package-type piles).

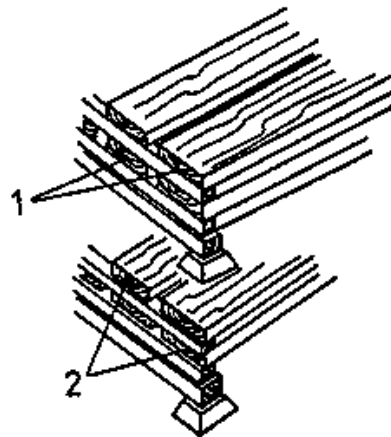

Figure 9 Position of pile strips at the wide side of piles 1 edges in alignment, 2 projecting

At least at one longitudinal side of the pile, the pile strips must be arranged so as to end or be in alignment with the sawn timber.

Task:

Why must the pile strips be arranged exactly vertically above the pile supports and above each other?

If no pile strips are used, wet and dry sawn timber is stored in the following types of *piles*: *cross-type piles*, *triangular piles*, *shear-type piles*.

Dry sawn timber is stored without pile strips in closed, dry rooms.

The different types of piles are constructed, as follows:

- Box-type pile

Edged or unedged-sawn boards or frame timbers of equal thickness and approximately the same length are well arranged side by side and piled up in layers in a box-type form using pile strips. The dimensions are:

- pile height = 4000 mm
- pile width = 1000 mm
- lateral distance to the next pile = 300 mm

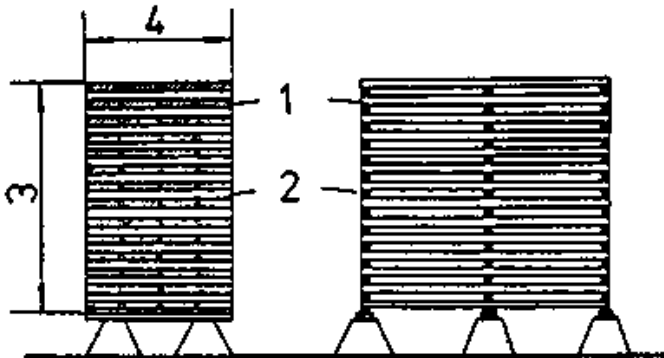

Figure 10 Construction of a box-type pile 1 boards, 2 pile strips, 3 pile height, 4 pile width

- Package-type pile

Edged or unedged-sawn timbers of equal thickness and approximately the same length are tied up in packages or piled up with intermediate pile strips. This is done by means of stacker

trucks.

Moreover, 60 mm to 80 mm thick spacers are used. The pile height is in accordance with internal works' rules and with the labour safety requirements.

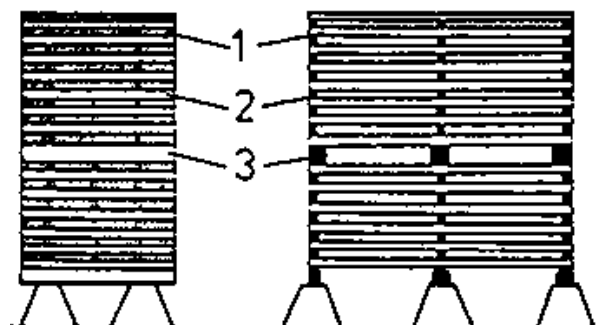

Figure 11 Construction of a package-type pile 1 boards, 2 pile strips, 3 spacers

- Block-type pile

Unedged-sawn boards, arranged acc. to their origin of trunks, are piled up in blocks using pile strips. The width of the bottom board must be be one third of the trunk diameter. Neighbouring blocks are connected with common pile strips.

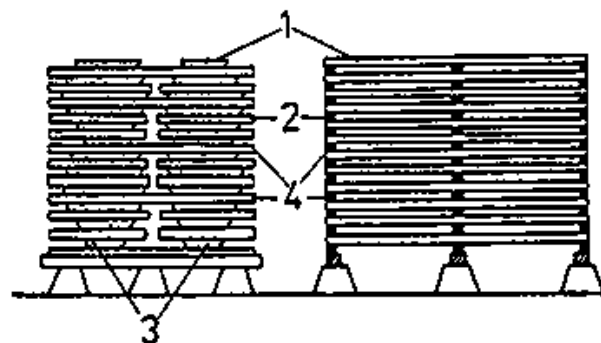

Figure 12 Construction of a block-type pile 1 unedged-sawn boards, 2 pile strips, 3 bottom boards, 4 common pile strips of neighbouring blocks

- Cross-type pile

Edged boards or squared timbers of equal length are piled up at right angles to each other without any pile strips.

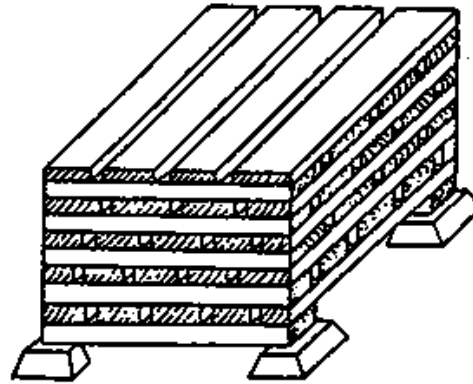

Figure 13

- Triangular pile

Edged or unedged-sawn boards of equal length are piled up in the form of equilateral triangles without any pile strips.

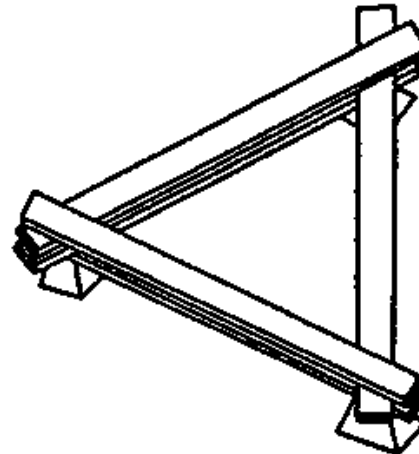

Figure 14

- Shear-type pile

Edged boards or squared timbers are erected with their gross-grained ends standing on the ground of the pile area. They are supported by a frame in a shear-type arrangement.

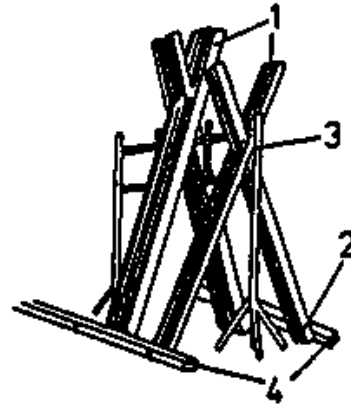

Figure 15 Shear-type pile 1 edged boards, 2 pile area, 3 frame, 4 securing of boards from slipping off

The timbers must be secured from slipping off on the ground.

