

[Home](#) > [ar](#).[cn](#).[de](#).[en](#).[es](#).[fr](#).[id](#).[it](#).[ph](#).[po](#).[ru](#).[sw](#)

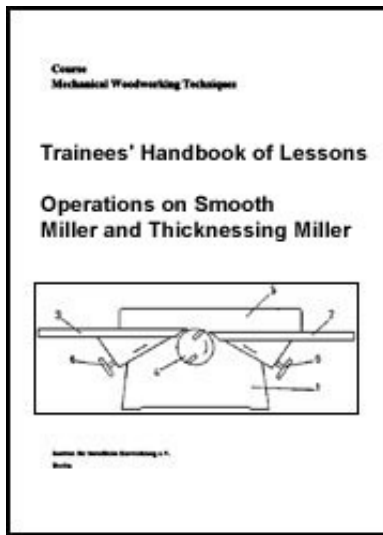

Operations on Smooth Miller and Thicknessing Miller - Course: Mechanical woodworking techniques. Trainees' handbook of lessons (Institut fr Berufliche Entwicklung, 10 p.)

(introduction...)

- 1. Purpose of Milling at the Smooth Miller**
- 2. Construction of the Smooth Miller**
- 3. Setting of the Smooth Miller**
- 4. Milling of the Workpieces**
- 5. Purpose of Milling on the Thicknessing Miller**
- 6. Construction of the Thicknessing Miller**
- 7. Setting of the Thicknessing Miller**
- 8. Milling of the Workpieces**
- 9. Tasks**









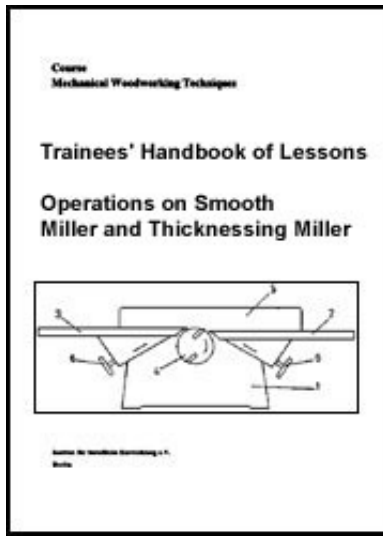

[Home](#) > [ar](#).[cn](#).[de](#).[en](#).[es](#).[fr](#).[id](#).[it](#).[ph](#).[po](#).[ru](#).[sw](#)

Operations on Smooth Miller and Thicknessing Miller - Course: Mechanical woodworking techniques. Trainees' handbook of lessons (Institut fr Berufliche Entwicklung, 10 p.)

(introduction...)



-  **1. Purpose of Milling at the Smooth Miller**
-  **2. Construction of the Smooth Miller**
-  **3. Setting of the Smooth Miller**
-  **4. Milling of the Workpieces**
-  **5. Purpose of Milling on the Thicknessing Miller**
-  **6. Construction of the Thicknessing Miller**
-  **7. Setting of the Thicknessing Miller**
-  **8. Milling of the Workpieces**
-  **9. Tasks**

**Institut fr berufliche Entwicklung e.V.
Berlin**

**Original title:
Arbeitsmaterial fr den Lernenden
"Arbeiten an Abricht- und Dickenfrsmaschinen"**

Author: Johannes Schollbach

First Edition © IBE

**Institut fr berufliche Entwicklung e.V.
Parkstrae 23
13187 Berlin**

Order No.: 93-35-3402/2



[Home](#) > [ar](#).[cn](#).[de](#).[en](#).[es](#).[fr](#).[id](#).[it](#).[ph](#).[po](#).[ru](#).[sw](#)

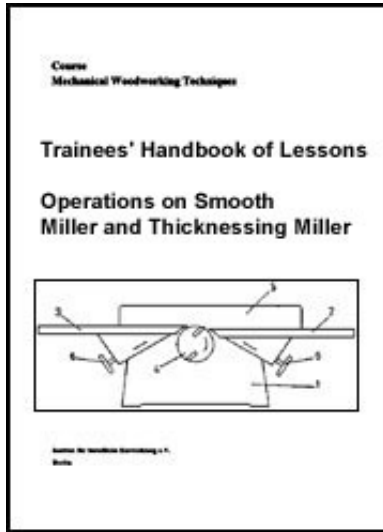

 **Operations on Smooth Miller and Thicknessing Miller - Course: Mechanical woodworking techniques. Trainees' handbook of lessons (Institut für Berufliche Entwicklung, 10 p.)**

 **(introduction...)**

 **1. Purpose of Milling at the Smooth Miller**

 **2. Construction of the Smooth Miller**

 **3. Setting of the Smooth Miller**

 **4. Milling of the Workpieces**

 **5. Purpose of Milling on the Thicknessing Miller**

 **6. Construction of the Thicknessing Miller**

 **7. Setting of the Thicknessing Miller**

 **8. Milling of the Workpieces**

  **9. Tasks**

9. Tasks

What is the purpose of milling on the smooth miller?

Which setting is done at the feeding table of the smooth miller?

What for is the stop bar of the smooth miller?

What is the feeding device used for?

Why is to make use of ear protectors?

Why is the left cover of the cutter spindle adjustable?

For what purpose is milling on the thickening miller?

What is the use of the sliding rolls inserted in the machine table?

What is the use of the both pressure beams?

What is the rebound protection for?

Milling a workpiece with lower rate of feed, milling a workpiece with high rate of feed.

What does become apparent when comparing both workpieces?

How is the dimensional accuracy to be checked?





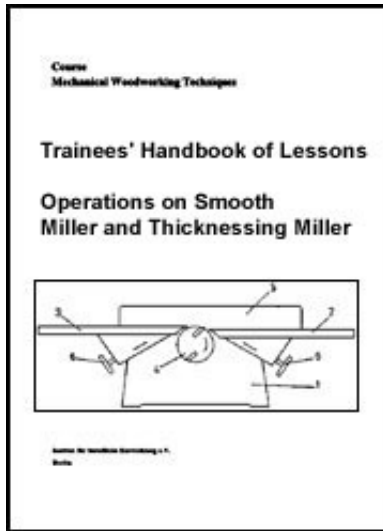







[Home](#) > [ar](#).[cn](#).[de](#).[en](#).[es](#).[fr](#).[id](#).[it](#).[ph](#).[po](#).[ru](#).[sw](#)



 **Operations on Smooth Miller and Thicknessing Miller - Course: Mechanical woodworking techniques. Trainees' handbook of lessons (Institut für Berufliche Entwicklung, 10 p.)**

 **(introduction...)**

-   **1. Purpose of Milling at the Smooth Miller**
-  **2. Construction of the Smooth Miller**
-  **3. Setting of the Smooth Miller**
-  **4. Milling of the Workpieces**
-  **5. Purpose of Milling on the Thicknessing Miller**
-  **6. Construction of the Thicknessing Miller**
-  **7. Setting of the Thicknessing Miller**
-  **8. Milling of the Workpieces**
-  **9. Tasks**

1. Purpose of Milling at the Smooth Miller

Milling on the smooth miller serves for making plane broad faces as well as narrow faces being at an angle to the broad face. Milling of broad and narrow faces is the first step of machining the workpieces on the thicknessing miller. The plane faces are the determining factor for the quality of the final product.

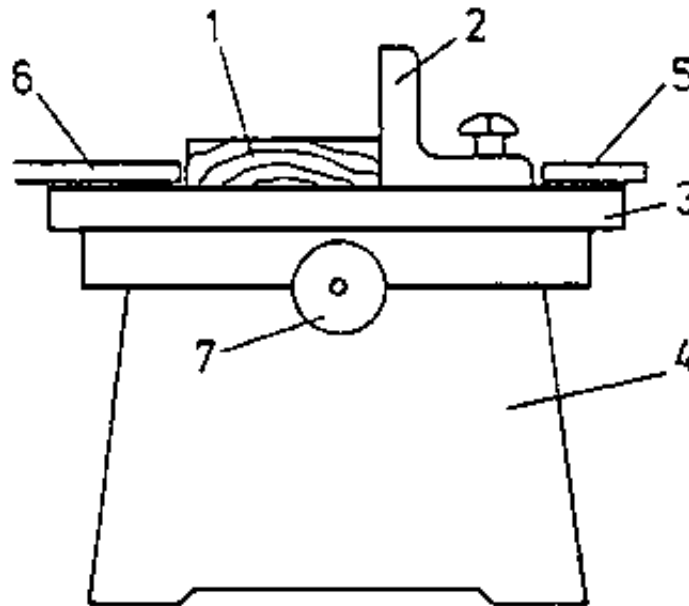

Figure 1 - Milling of the broad face

1 workpiece, 2 stop bar, 3 feeding table, 4 column, 5 rear cover of the cutter spindle, 6 front cover of the cutter spindle, 7 handwheel for adjustment of table

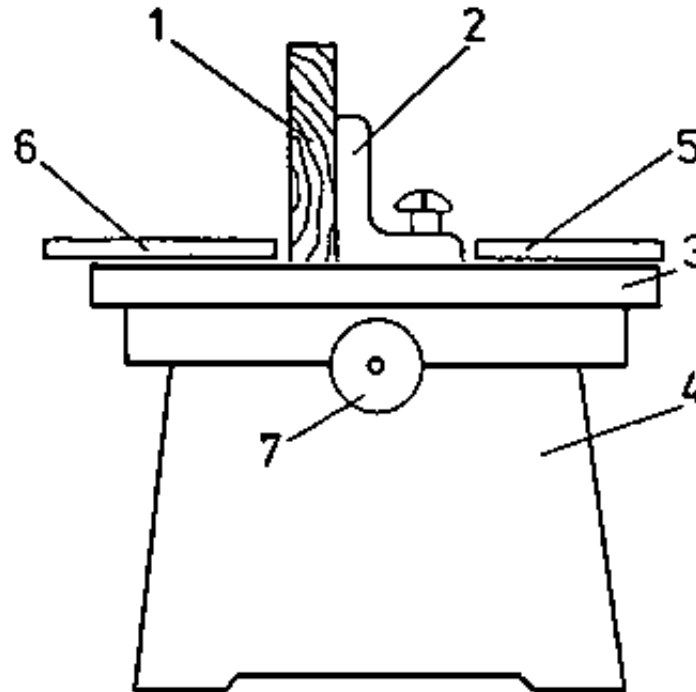

Figure 2 - Milling of the narrow face

1 workpiece, 2 stop bar, 3 feeding table, 4 column, 5 rear cover of the cutter spindle, 6 front cover of the cutter spindle, 7 handwheel for adjustment of table



[Home](#) > [ar](#).[cn](#).[de](#).[en](#).[es](#).[fr](#).[id](#).[it](#).[ph](#).[po](#).[ru](#).[sw](#)

 **Operations on Smooth Miller and Thickening Miller - Course: Mechanical woodworking techniques. Trainees' handbook of lessons (Institut fr Berufliche Entwicklung, 10 p.)**

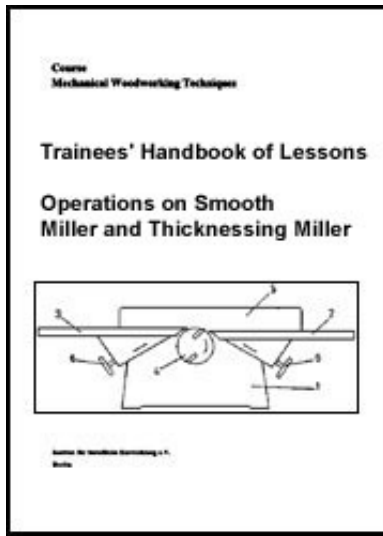

(introduction...)



1. Purpose of Milling at the Smooth Miller



2. Construction of the Smooth Miller



3. Setting of the Smooth Miller



4. Milling of the Workpieces



5. Purpose of Milling on the Thicknessing Miller



6. Construction of the Thicknessing Miller



7. Setting of the Thicknessing Miller



8. Milling of the Workpieces

9. Tasks

2. Construction of the Smooth Miller

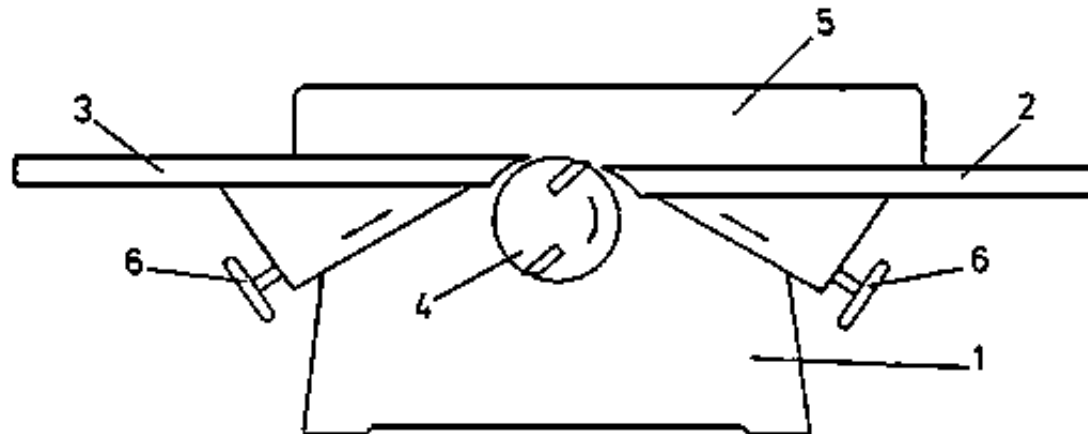

Figure 3 - Construction of the smooth miller

1 column, 2 feeding table, 3 unloading table, 4 cutter spindle, 5 stop bar, 6 handwheel for adjustment of table

Column

The column carries both, machine tables and the cutter spindle with the bearing housings. The column accomodates the electromotor.

Machine tables

The machine tables are vertically adjustable.

The depth of cut is set at the feeding table.

The feeding table is set to the flying circular height of the cutter.

Stop bar

The stop bar is horizontally and angularly adjustable. It serves for guidance when milling narrow faces.

Cutter spindle

In the cutter spindle the cutters are mounted. Their number of revolutions is between 4,000 and 6,000 revolutions per minute. The drive is done by the electromotor with the help of a belt drive.

Mode of operation of the smooth miller

The cutter spindle is set turning by the electromotor. It planes and finishes the material to be worked by chip removal.

Safety devices

The part of the cutter spindle which is not necessary for milling is covered by a stationary safety device.

The moveable left part of the safety device releases the necessary working width of the cutter spindle.

Smooth millers may cause heavy accidents. Therefore, pay special attention to the following:

- **do not switch on the machine without safety devices**
- **do not operate the machine without instruction**
- **make use of the feeding device when machining short workpieces (see Figure 5)**
- **pay attention to the order on the working place.**



[Home](#) > [ar](#).[cn](#).[de](#).[en](#).[es](#).[fr](#).[id](#).[it](#).[ph](#).[po](#).[ru](#).[sw](#)

 **Operations on Smooth Miller and Thicknessing Miller - Course: Mechanical woodworking techniques. Trainees' handbook of lessons (Institut fr Berufliche Entwicklung, 10 p.)**

 **(introduction...)**

 **1. Purpose of Milling at the Smooth Miller**

 **2. Construction of the Smooth Miller**

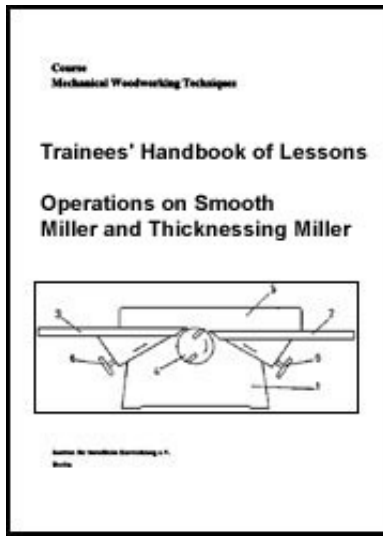

-
- 3. Setting of the Smooth Miller
 - 4. Milling of the Workpieces
 - 5. Purpose of Milling on the Thicknessing Miller
 - 6. Construction of the Thicknessing Miller
 - 7. Setting of the Thicknessing Miller
 - 8. Milling of the Workpieces
 - 9. Tasks

3. Setting of the Smooth Miller

Setting of the stop bar and the safety device for the necessary working width. Setting of the cutting depth at the feeding table. The cutting depth depends on the necessary chip removal. The chip removal depends, for instance, on the quality of the board and on the relation between rough size and end measure.



[Home](#) > [ar](#).[cn](#).[de](#).[en](#).[es](#).[fr](#).[id](#).[it](#).[ph](#).[po](#).[ru](#).[sw](#)

-  **Operations on Smooth Miller and Thicknessing Miller - Course: Mechanical woodworking techniques. Trainees' handbook of lessons (Institut für Berufliche Entwicklung, 10 p.)**
-  ***(introduction...)***

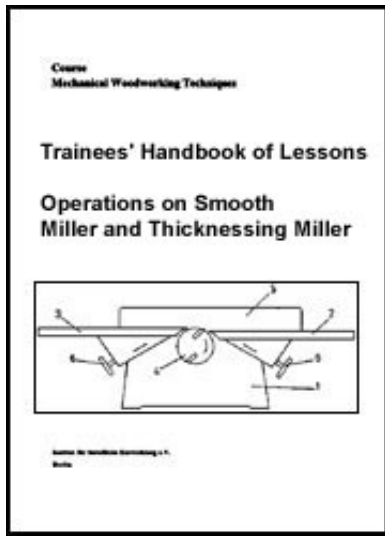

- 1. Purpose of Milling at the Smooth Miller
- 2. Construction of the Smooth Miller
- 3. Setting of the Smooth Miller
- ➔ 4. Milling of the Workpieces
- 5. Purpose of Milling on the Thicknessing Miller
- 6. Construction of the Thicknessing Miller
- 7. Setting of the Thicknessing Miller
- 8. Milling of the Workpieces
- 9. Tasks

4. Milling of the Workpieces

The workpieces are to be placed at hand. The workpiece is to put on the feeding table and to push with both hands and under pressure to the unloading table. During pushing the pressure is to shift to the unloading table step by step.

Longer workpieces are to put on with their hollow broad face. First mill both ends until you get a plane surface. Do not put too much pressure on it in order to prevent deflection.

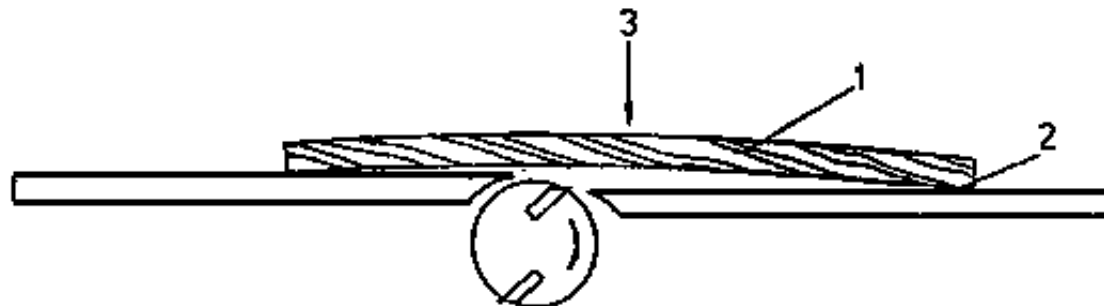

Figure 4 - Milling of high broad faces

1 workpiece, 2 milled ends of the workpiece, 3 small pressure

Short workpieces are slid by a feeding device.

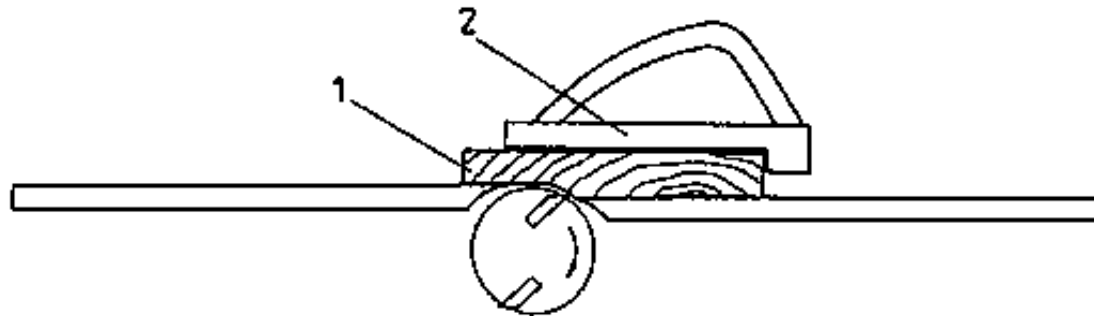

Figure 5 - Milling with feeding device

1 workpiece, 2 feeding device



[Home](#) > [ar](#).[cn](#).[de](#).[en](#).[es](#).[fr](#).[id](#).[it](#).[ph](#).[po](#).[ru](#).[sw](#)







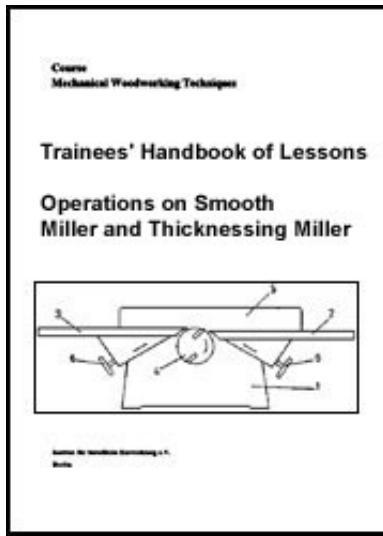

 **Operations on Smooth Miller and Thickening Miller - Course: Mechanical woodworking techniques. Trainees' handbook of lessons (Institut fr Berufliche Entwicklung, 10 p.)**

 **(introduction...)**

 **1. Purpose of Milling at the Smooth Miller**

 **2. Construction of the Smooth Miller**



-  **3. Setting of the Smooth Miller**
-  **4. Milling of the Workpieces**
-   **5. Purpose of Milling on the Thicknessing Miller**
-  **6. Construction of the Thicknessing Miller**
-  **7. Setting of the Thicknessing Miller**
-  **8. Milling of the Workpieces**
-  **9. Tasks**

5. Purpose of Milling on the Thicknessing Miller

Milling on the thicknessing miller serves for producing the necessary thickness and width of the workpiece.



[Home](#) > [ar](#).[cn](#).[de](#).[en](#).[es](#).[fr](#).[id](#).[it](#).[ph](#).[po](#).[ru](#).[sw](#)

 **Operations on Smooth Miller and Thicknessing Miller - Course: Mechanical woodworking techniques. Trainees' handbook of lessons (Institut fr Berufliche Entwicklung, 10 p.)**

 **(introduction...)**

 **1. Purpose of Milling at the Smooth Miller**

 **2. Construction of the Smooth Miller**

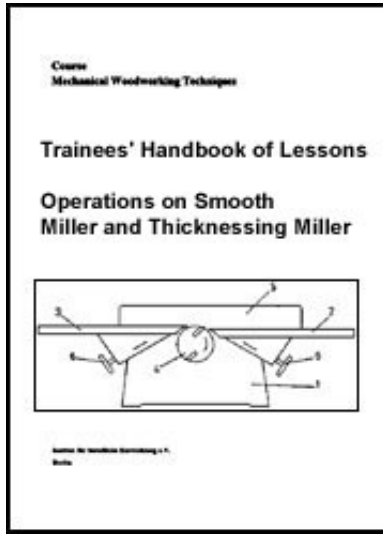

- 3. Setting of the Smooth Miller
- 4. Milling of the Workpieces
- 5. Purpose of Milling on the Thicknessing Miller
- ➔ 6. Construction of the Thicknessing Miller
- 7. Setting of the Thicknessing Miller
- 8. Milling of the Workpieces
- 9. Tasks

6. Construction of the Thicknessing Miller

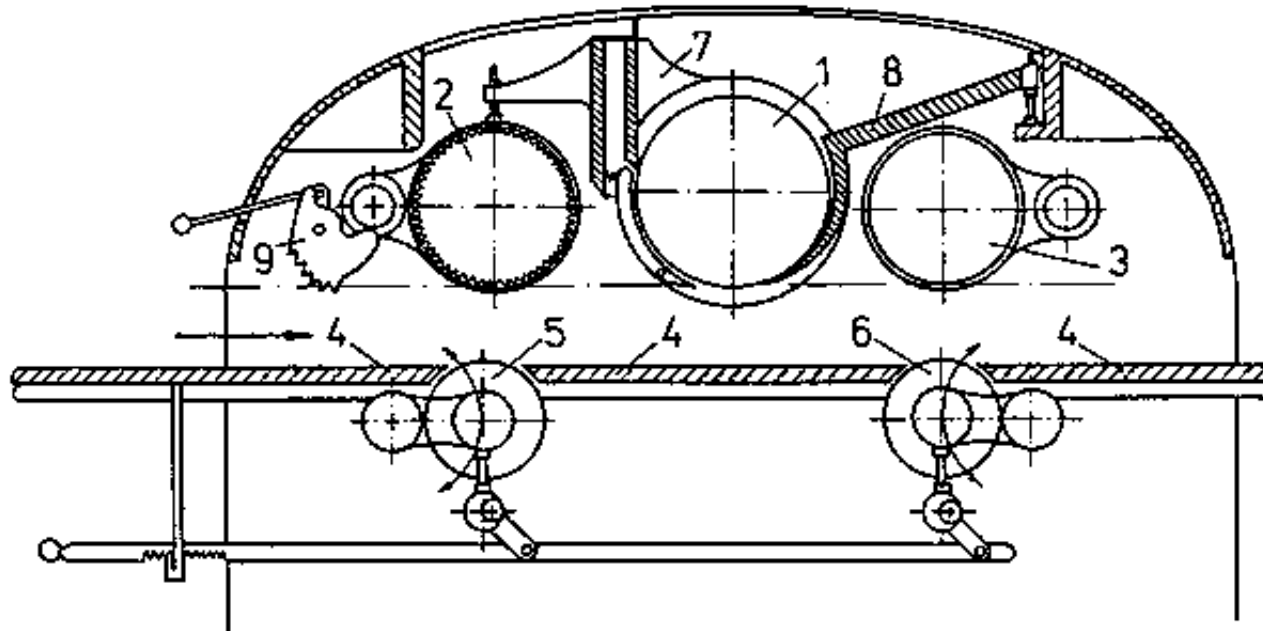

Figure 6 - Construction of the thicknessing miller

1 cutter spindle, 2 feeding roller - corrugated roll, 3 feeding roller, 4 machine table, 5 front sliding roller, 6 rear sliding roller, 7 front pressure beam, 8 rear pressure beam, 9 rebound protection

Machine table

The table is vertically adjustable for setting the intended thickness of the workpiece.

Two sliding rollers are inserted in the table to reduce friction between table and workpiece.

Feeding device

The feeding rollers move the workpiece over the machine table and under the cutter spindle.

The front and rear pressure beam prevent the fluttering of the workpiece when milling.

The rebound protection prevents the workpiece from being thrown out.

Cutter spindle

In the cutter spindle the cutters are mounted. Their number of revolutions is between 4,000 and 6,000 revolutions per minute. The electromotor drives the cutter spindle and the feeding device.

Safety devices

The closed construction of the thickening miller rules out to contact with the cutter spindle.

Concerning accident prevention it should be observed the following:

- **The rebound protection is to check for operatability.**
- **Maximum chip removal is determined by the device for chip thickness limitation (see Figure 6) (depending on the type of the machine).**
- **Pay attention to the cleanliness of the machine table.**
- **Workpieces of different thickness should not be inserted at the same time. The thinner workpiece would not be picked up by the draw-in roller (corrugated roll).**
- **Make use of ear protectors.**



[Home](#) > [ar](#).[cn](#).[de](#).[en](#).[es](#).[fr](#).[id](#).[it](#).[ph](#).[po](#).[ru](#).[sw](#)

 **Operations on Smooth Miller and Thickening Miller - Course: Mechanical woodworking techniques. Trainees' handbook of lessons (Institut fr Berufliche Entwicklung, 10 p.)**

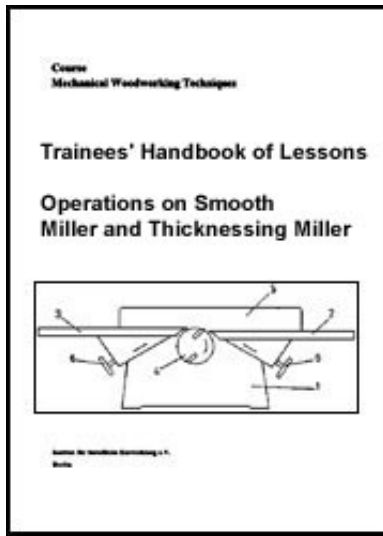

- (introduction...)**
1. Purpose of Milling at the Smooth Miller
 2. Construction of the Smooth Miller
 3. Setting of the Smooth Miller
 4. Milling of the Workpieces
 5. Purpose of Milling on the Thicknessing Miller
 6. Construction of the Thicknessing Miller
 - ➔ 7. Setting of the Thicknessing Miller
 8. Milling of the Workpieces
 9. Tasks

7. Setting of the Thicknessing Miller

The intended working measure is adjustable by vertical adjustment of the machine table. The adjusted measures are readable on a scale.

The machine table should not be fouled by resin residuals; if necessary it is to clean by crude oil or petroleum.



[Home](#) > [ar](#).[cn](#).[de](#).[en](#).[es](#).[fr](#).[id](#).[it](#).[ph](#).[po](#).[ru](#).[sw](#)

 **Operations on Smooth Miller and Thicknessing Miller - Course: Mechanical woodworking techniques. Trainees' handbook of lessons (Institut fr Berufliche Entwicklung, 10**

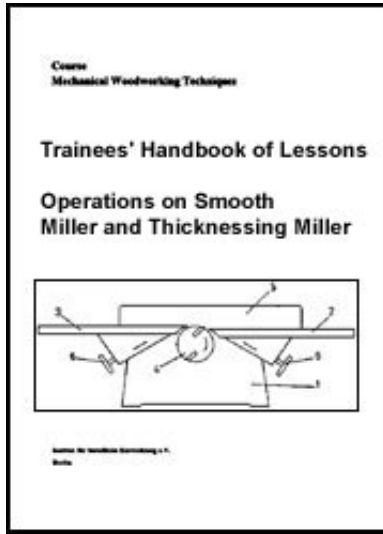

p.)

 **(introduction...)**

 **1. Purpose of Milling at the Smooth Miller**

 **2. Construction of the Smooth Miller**

 **3. Setting of the Smooth Miller**

 **4. Milling of the Workpieces**

 **5. Purpose of Milling on the Thicknessing Miller**

 **6. Construction of the Thicknessing Miller**

 **7. Setting of the Thicknessing Miller**

 **8. Milling of the Workpieces**

 **9. Tasks**

8. Milling of the Workpieces

After setting the milling thickness switch on the machine and slip in the workpieces by hand until they are taken by the feed roller. The feed device does the transport during the milling operation.

The rate of feed is adjustable and is between 5 - 25 m per minute. The lower the rate of feed is chosen the better the quality of the surface will be.

