







## **Aerial Spraying Research and Development Project - Final Report - Volume 2**

**Author(s):** *R. Allsopp*  
**Publication date:** *1990*  
**Number of pages:** *55*  
**Publisher:** *Natural Resources Institute (NRI)*  
**ISBN:** *5100.35.94.269*  
**Copyright holder:** *Crown*

---

### **Contents:**

-  [Abbreviations used](#)
-  [Acknowledgements](#)
-  [Preface](#)
-  [CHAPTER 1: PLANNING THE OPERATION](#)
-  [CHAPTER 2: TENDERS AND CONTRACTS](#)
-  [CHAPTER 3: OPERATIONAL PROCEDURES](#)
-  [CHAPTER 4: MONITORING](#)
-  [References](#)

---

### **Abbreviations used**

▲ [Top](#)

ASRDP Aerial Spraying Research and Development Project

BAe British Aerospace

DINS Doppler Integrated Navigation System  
DVS Department of Veterinary Services  
DVTCS Department of Veterinary and Tsetse Control Services  
ECU European Currency Unit  
EDF European Development Fund  
EEC European Economic Community  
FLP First larval period  
GPS Global Positioning System  
INS Inertial Navigation System  
NMD Number median diameter  
NRED Natural Resources and Environment Department (of ODA)  
NRI Natural Resources Institute  
MgO Magnesium oxide  
ODA Overseas Development Administration  
RTTCP Regional Tsetse and Trypanosomiasis Control Programme  
SAT Sequential aerosol application technique  
SEMG Scientific Environmental Monitoring Group  
SGP Sperry Gyro Platform

TANS Tactical Air Navigation System

VMD Volume median diameter

VRU Variable restrictor unit

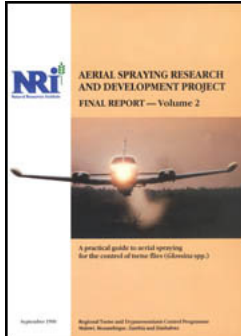

## **Aerial Spraying Research and Development Project - Final Report - Volume 2**

**Author(s):** *R. Allsopp*

**Publication date:** *1990*









**Number of pages:** *55*

**Publisher:** *Natural Resources Institute (NRI)*

**ISBN:** *5100.35.94.269*

**Copyright holder:** *Crown*

### **Contents:**

-  [Abbreviations used](#)
-  [Acknowledgements](#)
-  [Preface](#)
-  [CHAPTER 1: PLANNING THE OPERATION](#)
-  [CHAPTER 2: TENDERS AND CONTRACTS](#)
-  [CHAPTER 3: OPERATIONAL PROCEDURES](#)
-  [CHAPTER 4: MONITORING](#)
-  [References](#)

### **Acknowledgements**

**The Aerial Spraying Research and Development Project arose as an EEC/EDF funded extension to an ongoing NRI research programme funded by ODA's Natural Resources and Environment Department. It continued as a jointly funded project with staff inputs largely funded by NRED, equipment and running costs financed by the EDF.**

**Aircraft hire for R&D activities is expensive, as is the hire or purchase of avionics equipment to test in pest management situations. The ASRDP was most fortunate to have the support of Zimbabwe's Department of Veterinary Services, Tsetse and Trypanosomiasis Control Branch during its aerial spraying programme. Without this and the support and active participation of Agricaire (PVT) Ltd., who instigated many research activities and developed their own tsetse control capability, the ASRDP would have lacked an experienced institutional framework within which to operate. Access to documentation, advice and the loan of avionics equipment to test under operational control conditions were provided by British Aerospace. NRI and the ASRDP are most grateful to all for their confidence, cooperation and assistance.**

**Several insecticide manufacturing companies provided advice and materials. Special thanks are due to Hoechst (Zimbabwe and UK) and Wellcome (Zimbabwe and UK). Micronair (Aerial) UK Ltd. were also most helpful with assistance and specialised equipment.**



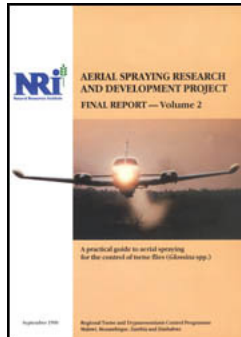





**We are especially indebted to the RTTCP Coordinator, Mr Lovemore, for his unfailing support and expert advice, to Mr Saunders and his staff in the RTTCP Regional Office and to the EEC Delegation in Harare for patiently helping us avoid the many administrative potholes and to the very many individuals whose help, advice and friendship made this project pleasant and successful.**



## **Aerial Spraying Research and Development Project - Final Report - Volume 2**

**Author(s):** *R. Allsopp*  
**Publication date:** *1990*  
**Number of pages:** *55*  
**Publisher:** *Natural Resources Institute (NRI)*  
**ISBN:** *5100.35.94.269*  
**Copyright holder:** *Crown*

### **Contents:**

-  [Abbreviations used](#)
-  [Acknowledgements](#)
-  [Preface](#)
-  [CHAPTER 1: PLANNING THE OPERATION](#)
-  [CHAPTER 2: TENDERS AND CONTRACTS](#)
-  [CHAPTER 3: OPERATIONAL PROCEDURES](#)
-  [CHAPTER 4: MONITORING](#)
-  [References](#)

### **Preface**

[▲ Top](#)

**This guide to the sequential application of low dosage aerosols for the control of tsetse flies refers primarily to the use at night of small, fixed wing aircraft e.g. Piper Aztec,**

**Beechcraft Baron, Cessna 401 (cover photo) etc.. It does not cover operations using larger aircraft such as the Dakota DC3 or those confined to daylight spraying, unless specific reference is made.**

**The potential role of helicopters in tsetse control is recognised and although encouraging preliminary work has been carried out this will not be covered in any detail in this manual.**

**The procedures described below are based largely on experiences within an EEC project in southern Africa. They do, however, apply to tsetse control throughout Africa and where techniques are considered country specific this is mentioned in the text.**

**The manual refers mainly to operations controlled by central government, with flying activities contracted out to commercial operators.**

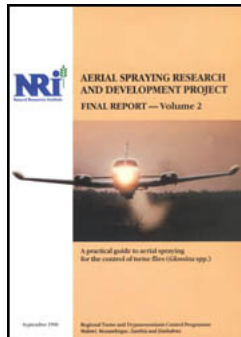

## **Aerial Spraying Research and Development Project - Final Report - Volume 2**

***Author(s): R. Allsopp***

***Publication date: 1990***

***Number of pages: 55***

***Publisher: Natural Resources Institute (NRI)***





















***ISBN: 5100.35.94.269***

***Copyright holder: Crown***

### **[Contents:](#)**



## **CHAPTER 1: PLANNING THE OPERATION**

-  [INTRODUCTION](#)
-  [OPERATIONAL DESIGN](#)
  -  [The treatment area](#)
  -  [The airstrip](#)
  -  [Seasonal timing](#)
  -  [Prevention of reinvasion](#)
  -  [Entomological surveys](#)
  -  [The insecticide](#)
-  [PLANNING A STRATEGY](#)
  -  [Contractual requirement](#)
  -  [Major equipment requirements](#)
  -  [Flying charges](#)
  -  [Insecticide requirements and flow rate calculation](#)
    -  [Insecticide requirement](#)
    -  [Flow rate calculation](#)
  -  [Estimation of the operational flying time per aircraft](#)
    -  [Mobilisation/demobilisation](#)
    -  [Pre-flight preparation](#)
    -  [Ferrying to and from the spray block](#)
    -  [Turns](#)

---

## INTRODUCTION

[▲ Top](#)

**Tsetse control generally involves the use of one or more of the following techniques:**

- 1. 'Ground spraying' with pressurised knapsack sprayers leaves a persistent deposit of insecticides such as DDT or dieldrin on tree trunks and lower branches. The technique is still used in a few countries (notably Zimbabwe and Uganda) and alternatives to the chlorinated hydrocarbon insecticides are being investigated. It is not likely to be introduced by control authorities which do not already have long experience and an existing operational infrastructure.**
- 2. 'Targets' are chemically impregnated cloth screens usually supported on a wire frame which rotates in the wind around a central upright attracting tsetse both visually and by the use of slow-release odours. Deployment and maintenance can be logistically demanding but this is offset by cost effectiveness and low environmental hazard which has resulted in their favourable acceptance by control authorities and donors.**
- 3. 'Cattle dipping' in a persistent pyrethroid dip rather than a narrow spectrum, less persistent acaricide leaves a residual deposit on the animals sufficient to kill tsetse flies for several weeks, and control ticks. The method needs veterinary supervision and close monitoring of the tick situation. It is highly cost effective where cattle dipping already takes place.**
- 4. The 'sterile male technique' is well proven and effective against other pests but has not been widely adopted for tsetse control. The cost of maintaining a colony is high and it may be necessary to reduce the population with some other method such as aerial or ground spraying before releasing sterilised males.**



**5. The 'sequential application technique' (SAT) applies low dosage aerosols from fixed wing aircraft. It eliminates adult tsetse from the treatment area with the first application then systematically removes newly emerging flies through a series of treatments carefully timed to prevent any further larviposition. The applications continue until new adults cease to emerge.**

**The period of pupal development, during which juvenile tsetse are immune to chemical attack, was perhaps the most significant factor in the design of the residual chemical control methods mentioned above. The insecticide has to remain available to all emerging adults in the population for at least the duration of maximum pupal development. SAT replaced this dependence upon residual insecticides with a series of acute, low dosage treatments. The total dosage needed for five non-residual aerosol applications is less than a single ground sprayed treatment with a comparable insecticide applied to leave a persistent deposit for several months.**

**Eradication depends upon all newly emerged females being eliminated during each application thus an even distribution of insecticide droplets is of paramount importance. As aerosol droplets only a few microns in diameter descend from the aircraft their 'behaviour' is profoundly affected by turbulent air e.g. high winds, convection etc.. The most stable conditions, thus the most suitable for SAT, occur at night and during the cool dry season. The technique has developed accordingly and has been used extensively and successfully in southern and eastern Africa.**

### **The advantages of aerial spraying**

- 1. Aerial spraying is not labour intensive. It is a mechanised technique which requires a few well qualified, and usually highly motivated personnel who rely upon advanced avionics and computerisation.**
- 2. It has the capability to treat large areas in a short period of time. It is particularly well**

**suited to epidemic situations or to facilitate resettlement where persons displaced from their homes through military activity or civil unrest are prevented from returning because major tsetse reinfestation has occurred.**

**3. Rapid reduction in tsetse density might be advantageous on commercial rangeland to relax the need for chemotherapy; as indeed it would in human epidemic situations. It might also remove the threat of increased endemicity and possible spread of trypanosomiasis while other techniques exert their more prolonged effects.**

**4. Aerial spraying can be effective in areas where access is either difficult, dangerous or undesirable and which contraindicate the use of ground based methods.**

**'Difficult' areas include remote locations, those poorly serviced by road links or rugged terrain where access is physically difficult.**

**Areas including or bordering post-war minefields are highly dangerous, particularly if large numbers of personnel need to stray from major roads, cut new tracks or carry out surveys.**

**Tsetse may need to be cleared from wildlife areas as part of an wider land use plan. The administrators of such areas may consider it undesirable to create the network of roads necessary to facilitate ground based control operations particularly where poaching is a serious threat.**

**The disadvantages of aerial spraying**

**The following might be considered as disadvantages of aerial spraying:-**

**1. It applies large amounts of chemical over large areas**

**2. It is relatively expensive**

**3. Its speed and scale complicate land use planning and require a large survey input to detect and treat residual populations**

**4. It requires either barriers or attention to neighbouring areas where tsetse still exist to prevent reinvasion**

**5. It cannot eliminate tsetse from extremely rugged terrain**

**6. It may be necessary to 'mop up' any residual population, particularly of *Glossina pallidipes*.**

**Some of these disadvantages apply to tsetse control generally. They must, however, be considered in the context of aerial spraying.**

**1. Aerial spraying does apply large amounts of chemical - 78,000 litres in Zimbabwe, 1988 for instance - but only 0.35% of this was active ingredient thus only 125g.a.i/km<sup>2</sup> was applied over a period of two months. Extensive monitoring operations in Botswana (1) and by the Regional Tsetse and Trypanosomiasis Control Programme's (RTTCP) monitoring group have not indicated that the environmental effects of carefully applied aerial spraying are unacceptable.**

**2. The technique is generally more expensive per unit area than ground spraying, chemically impregnated targets or alternative trypanosomiasis control methods such as chemotherapy (table 1).**

**Table 1. Cost comparison for tsetse and trypanosomiasis control**

	Costs (£ per sq. km. per year)			
	Direct <sup>1</sup>	Indirect <sup>2</sup>	Total	% Foreign
<b>TSETSE CONTROL</b>				
Ground spraying	78	15-84 <sup>3</sup>	93-162	65
Aerial spraying	114	57-102 <sup>4</sup>	171-216	75
Targets:				
4 per km <sup>2</sup> , 4 visits	96	24-90 <sup>3</sup>	120-186	50
1 per km <sup>2</sup> , 4 visits	24	24-90 <sup>3</sup>	48-114	50
4 per km <sup>2</sup> , 2 visits	75	24-90 <sup>3</sup>	9-165	50
<b>TRYPANOSOMIASIS CONTROL (Samorin and Berenil)</b>				
5 cattle per km <sup>2</sup> , 5 years			33-45	
10 cattle per km <sup>2</sup> , 10 years			111-150	
20 cattle per km <sup>2</sup> , 20 years			306408	

**1 direct costs cover insecticide, targets and baits, flying time, staff and transport**

**2 indirect costs cover construction of access roads and airstrips and approximate administrative overheads**

**3 lower figure for easy terrain, upper for difficult**

**4 lower figure for 6,000 km<sup>2</sup>, upper for 2,000 km<sup>2</sup>**

**Table 1 (J Barrett pers.comm.) shows that there is some overlap in the unit costs of these different methods. The aerial spraying estimates are based upon 'one-off operations and if aerial spraying were to become a routine operation continuing for several years the unit cost would reduce significantly. Also, if the flying was predominantly over flat terrain, savings could be made by increasing swathe widths over those currently considered as standard.**

**3. Land use proposals should accompany all pest management situations such as tsetse control and these can be more difficult to define where treatment is extensive and/or rapid. However, where the objective is resettlement or reclamation this does presuppose that the land was previously utilized.**

**Post treatment surveys are a major cost to the contracting authority irrespective of the tsetse control method employed. They have improved dramatically for *G. pallidipes* over the past few years with the introduction of odour-baited traps etc. and particularly after the discovery of the attractive properties of the phenols. There does not, however, appear to have been any significant reduction in the cost of surveys and there is room for improvement in the strategy and cost effectiveness of tsetse surveys following all control operations.**

**4. Reinvasion is a constant problem wherever attempts are made to eliminate tsetse; aerial spraying operations are no exception. It is virtually impossible to isolate the treated areas with natural or artificial barriers or to eliminate an entire discrete population.**

**Targets have the greatest potential to provide protection against reinvasion and hopefully it will not be too long before suitable designs and deployment configurations can provide this much needed capability.**

**5. The Aerial Spraying Research & Development Project (ASRDP) has defined the limitations of fixed wing aircraft in rugged terrain. These aircraft cannot guarantee eradication from such variable and extreme terrain as that found along the Zambezi escarpment but they are able to operate in extremely broken country or severely undulating terrain with considerable success. A recent helicopter trial gave an encouraging insight into what can be achieved with aerial spraying even in the most difficult terrain and we are now close to having an aerial capability which can cope with most terrain, for instance, within the RTTCP's common fly belt.**

**6. It is not unusual to find that a few tsetse flies have survived treatment by aerial spraying or indeed any control method. It is improbable that any single technique can guarantee to eliminate every tsetse fly from an area which might extend to several thousand km<sup>2</sup>. *G. pallidipes* seems particularly resilient but it has been successfully eliminated from areas of Zimbabwe and Somalia so objective is not impossible.**

**Attempts to reduce insecticide dosages to a minimum for environmental reasons have perhaps overshadowed their primary objective which is to kill tsetse. Research at NRI and Rekomitjie in Zimbabwe have indicated more practical dosages but it is prudent to approach control in the expectation that some survival will occur and must be rectified with an alternative technique i.e. by integrated control.**

---

## **OPERATIONAL DESIGN**

[▲ Top](#)

**Having considered the various control options and decided that aerial spraying is the**

**appropriate technique to combat a particular tsetse/trypanosomiasis problem, several parameters must be defined before a strategy can be designed, resources identified and tenders invited. These are:**

---

## **The treatment area**

[▲ Top](#)

**The area to be treated by aerial spraying is largely determined by disease and vector distribution but it will also depend to some extent upon land use strategies, politics and topography. Accepting these constraints, the area selected should take account at the very outset of the need to avoid reinvasion. Where possible it should border natural features which might minimise the risks of reinvasion and reduce the need to provide artificial barriers in the form of targets or ground spraying.**

**There are few really effective natural 'barriers' but some protection might be provided by lakes, wide rivers, extensive open grasslands (or arable lands which provide no leafy cover as shelter for tsetse) or urban development. Pre-spray surveys will indicate which, if any, boundaries are naturally protected from reinvasion. Those which are not should be positioned with regard to the method which will be used to provide this protection. The boundary might therefore be a road or a dry river bed which could provide access to a target barrier.**

**If protection is provided by ground spraying there must be an overlap of several kilometres in which case the boundary may not be a physical feature on the ground but one which is detected by the aircraft's avionics.**

***Reinvasion is the most likely reason for failing to eradicate tsetse and this must be taken into consideration at the onset of operational planning and at every stage thereafter.***

**The size of area selected for treatment depends upon the extent of the 'tsetse' problem within a land-use context, finance and the commercial facilities available. With regard to the latter, one small, twin-engined aircraft capable of lifting about 525 litres of insecticide could, with adequate crew changes, complete five sorties per night for, say, eight nights and could conceivably treat 1000km<sup>2</sup>.**

**Although feasible, this would not be recommended as it allows little or no margin for error and would put the crews under considerable stress. Two aircraft could treat the same area in half the time and although this would guarantee that the operation could be completed even if one aircraft became unserviceable, it would not fully utilise the aircrafts' capabilities and would not be cost effective.**

**The minimum size/unit configuration should be two aircraft for an area of about 1500 km<sup>2</sup>. The fixed charges for deploying aircraft would be prohibitively expensive for areas significantly less than 1500 km<sup>2</sup> and as a broad guide, each additional 1000km<sup>2</sup> would require one extra aircraft thus 3 aircraft for 2500 km<sup>2</sup>, 4 for 3500 km<sup>2</sup>, etc..**

***The larger the area treated the cheaper the cost per unit area.***

**Night spraying with helicopters has not been investigated thus one aircraft would be limited to about one hour before dusk and one to two hours after dawn. An area of about 125 km<sup>2</sup> is the maximum that could be treated in this time.**





***Plate 1. Beacon being positioned on a hilltop by a Bell 47 helicopter.***

**SAT has a rapid, non-residual effect on the adult tsetse population and it is possible for untreated flies to move without risk into a treated area within hours of spraying. The technique also relies upon drifting insecticide. Problems arising from fly movements are most likely to occur along 'edges' where there is also a greater likelihood of underdosing through reduced accumulative drift or meteorological variation. Thus block edges are potentially vulnerable and the 'edge effect' is increased with long narrow blocks. The ideal shape for a treatment area is, therefore, square.**

**Spraying along the prevailing wind reduces lateral drift and can cause patchy deposition of insecticide. The most suitable flight direction is 90° to the prevailing wind but there will be occasions when this is not practical. In such cases, the area must be sub-divided into blocks with different flight angles to the wind though avoiding if at all possible flight along the prevailing wind direction.**

**The juxtaposition of treatable terrain and untreatable hills might dictate that turns are made well inside the rising ground or that the flight path runs parallel to the rising ground**

**irrespective of prevailing wind direction. Such areas should be kept to a minimum and might even be more sensibly treated with an alternative technique (e.g. helicopter, targets or ground spraying). There might, however, be a local katabatic wind flow from the hilly ground which differs from the prevailing direction and is conducive to spraying in that particular area. Preliminary meteorological studies are extremely important if such problems are anticipated.**

**Where the spraying is in close proximity to hilly terrain there must be hazard warning beacons on appropriate features and these may need to be deployed by helicopter (Plate 1).**

**The configuration selected will ultimately be a compromise between spraying time, turning time, operational capability and the need to deposit as wide a band of insecticide as possible during each operational time unit (sortie, night, cycle).**

**On-board navigation equipment will be specified for the aircraft but some ground track guidance support will probably be required. Depending upon the sophistication of the on-board avionics and the ability of its operator, which in turn will depend upon available finance and the contractor's experience, one or two 'marker lines' may be required. It is possible to cut these in a straight line across the treatment area (e.g. where there are no existing roads such as in Botswana's Okavango Delta) in which case the flight paths can be easily marked at appropriate intervals - 200, 250m, etc.. It is more often necessary to utilise existing roads, which are seldom straight, and in such cases the distance between flight path markers must take account of the meandering and be estimated trigonometrically using maps and survey equipment; at least a compass and measuring chain. This requires some expertise and can lead to inaccuracies, particularly where the terrain is uneven and the estimate three dimensional.**

---

### **The airstrip**

**Tsetse control is frequently carried out in 'bush' or wilderness areas and to avoid long distance ferrying between base camp and treatment site it may be necessary to use bush airstrips. This can affect the choice of aircraft e.g. a high-winged Islander or Aero Commander would be more suitable than low-winged Aztec or Baron or, in the event that there is no choice (as is most often the case) the possibility of damage to the propellers or undercarriage should be anticipated. Such anticipation can take the form of selective strengthening, spare parts or attention to the strip. In the latter case, damage is most likely to occur in the first 100m of take-off, or on landing.**

**The surface of an untreated bush strip will inevitably break up under the stress of repeated, fully laden take-off and landing. Short grass cover will reduce this, thus grading is not advisable. The 'powering up' position at the head of the runway will take the greatest strain and should be firm and clear of stones. Ideally it should be concrete, say 10m × 10m × 10-15 cm. The next 100m should also be stone free and, ideally, strengthened. If this amount of concrete or tar capping is not possible cheaper alternatives are available. For instance, a strip 10m by 100-150m could be excavated to a depth of 30cm then half filled with watered and compacted gravel. This can then be capped with gravel (preferably non-plastic) to which 3% cement is mixed and again is well watered and compressed with a heavy roller.**

**Aircraft parking areas alongside the runway should also be of concrete since these too will rapidly break up from repeated propeller 'wash'. The Scientific Environmental Monitoring Group (SEMG) recommend hard standing areas for the aircraft, together with a soak-away pit to facilitate washing down and disposal of waste insecticide.**

**Unless the aircraft used is capable of a short take-off and landing with a full chemical load plus two crew (e.g. Turbo Thrush) and taking account of the altitude the strip should be at**

**least 1000m in length plus cleared under and over shoot areas. If the airstrip is too short the operation must be designed around partial loads. This increases the cost but also increases the safety margin for crews. It also reduces the likelihood of aborted take-off and possible dumping.**

**If more than one aircraft is being used it may be necessary to water the strip frequently to reduce the dust, otherwise, time is lost and expense incurred as the lead aircraft circles waiting for the dust to settle before the rest of the formation is able to get airborne (Plate 2). This requires a considerable amount of water and is ideally undertaken with a motorised bowser fitted with a sprinkler device.**



***Plate 2. Dust cloud follows take-off from earth airstrip.***

**The cost of lengthening, strengthening and maintaining a bush strip can be prohibitive (in excess of Z \$100,000 in Zimbabwe 1988 (2)) and should be compared with the cost of ferrying from the nearest surfaced airstrip.**

**Helicopters are generally able to operate without a runway but when used for tsetse**

**control they lift relatively heavy loads and may not be able lift off vertically with ease. A short runway, clear of obstructions, particularly trees, may be necessary.**

---

### **Seasonal timing**

▲ [Top](#)

**Aerial spraying is usually carried out during the cold dry season (June - September in southern Africa; February - April in NE Africa) when there is little possibility of rain, meteorological conditions are relatively stable and there is reduced leaf cover. At this time of year the nightly temperature inversion is also at it's strongest.**

---

### **Prevention of reinvasion**

▲ [Top](#)

**Low dosage insecticide aerosols applied by the SAT have a very short toxic life and treated areas are especially prone to reinvasion. This can be reduced between sorties and nights by avoiding long narrow blocks or by overlapping where appropriate but these precautions do not eliminate the possibility of reinvasion between cycles or after the operation is completed.**

**At such times the borders of the entire treatment area must be protected by some form of barrier' unless surveys have shown that adjacent areas are clear of fly.**

**Ground spraying has often been used to protect aerial spraying boundaries but it has several drawbacks. The ground spraying must have eliminated the neighbouring tsetse population before aerial spraying commences, otherwise surviving tsetse will still be able to move into the proposed SAT area. Even if these immigrants subsequently die, the females may have time to deposit pupae and establish a subterranean, juvenile population**

**which does not emerge before the planned sequence of sprays is completed.**

**If a ground sprayed barrier is the only possibility it should be instigated the year before SAT with a limited retreatment immediately before the aerial operation commences. This would substantially increase the cost per unit area and has not generally been practiced. A single ground spray application cannot guarantee to prevent reinvasion and, if used, must be accompanied by appropriate surveys to detect peripheral survivors and some technique to eliminate them (Plate 3).**



***Plate 3. Ground spraying with pressurised knap-sack sprayer.***

**One further disadvantage of ground spraying is that in order to have the treatment completed before aerial spraying begins, most of the dry season may have passed before the aerial operation can begin. There is then the danger of disruption from early rains.**

**Finally, ground spraying depends upon persistent deposits of insecticides such as DDT and this does not accord with the general concept of SAT which was designed to control tsetse with the minimum use of insecticide.**

**Chemically impregnated, odour-baited targets are increasingly used in favour of ground spraying to protect SAT boundaries. In theory these should provide an immediate and impenetrable barrier to reinvasion, thus could be deployed immediately before aerial spraying commences. However, the width of barrier and density of targets necessary to provide such a blockade to reinvasion is the subject of continuing research (3). Also their effectiveness against species other than *G. pallidipes* and *G. morsitans* has yet to be investigated. Until this research is completed and target barriers are proven to be effective in preventing the movement of tsetse their use must also be accompanied by specific surveys to detect reinvading tsetse and by a means of eliminating them (e.g. additional selectively deployed targets).**

**Used in their present form, i.e. 20-30 targets per km<sup>2</sup> in a line approximately 1 km wide, target barriers provide considerable protection against reinvasion. Their flexibility of use and low cost provide numerous strategic alternatives at the planning stage and during the course of aerial spraying should surviving or reinvading tsetse be detected. They can be left in position *ad infinitum* while the problem persists, providing they are properly maintained, and they are not an environmental hazard. They have proved very effective when deployed at low density over an area of, say, 50-100km<sup>2</sup> around a location where individual surviving flies are detected after aerial spraying is completed (4).**

**Cattle dipping with deltamethrin (Plate 4) provides a third possible type of barrier (5). This technique requires veterinary supervision but can reduce tsetse populations. Where cattle are present together with dipping facilities the technique will certainly provide some protection against reinvasion, particularly if used in conjunction with targets.**



**Plate 4. Zimbabwe cattle dip**

---

## Entomological surveys

▲ [Top](#)

**In order to make operational adjustments during aerial spraying and to assess the eventual result, it is essential that tsetse surveys are carried out before, during and after spraying. Ideally, they should cover the entire treatment area but in practice this is seldom feasible and some degree of selective sampling must be employed.**

**The sampling intensity and method(s) employed will depend upon the species to be treated and the resources available. Mobile methods such as vehicle mounted electric traps on motor cycles, trucks (Plate 5) or ox drawn trailers are all highly effective for sampling *G. morsitans* (6). Manned screen patrols (Plate 6) or odour-baited traps (Plate 7) can also be used. In southern Africa, box traps of the F3 or epsilon type baited with acetone (release rate 500mg/h) and polythene satchets containing 4 methyl phenol, octenol (1-octen-3-ol), and 3 n propyl phenol in the ratio 8:4:1 are highly effective for**



attracting *G. pallidipes* (7). Biconical traps and ox rounds have also been used to good effect, although oxen need to be watered daily and during the dry season water is not always conveniently available.



**Plate 5. Vehicle mounted electric net**

Assuming that total sampling is not possible, the surveys should commence as early as possible to provide a comprehensive distribution map. Selective operational and post spray surveys can then concentrate on:

- (i) areas which originally had a high fly density;
- (ii) particularly suitable habitat such as drainage lines for *G. pallidipes* or mopane woodland well stocked with game animals for *G. morsitans*;
- (iii) peripheral areas where reinvasion is possible or survival more likely due to edge effects;

**(iv) other areas where survival might be anticipated such as where high flying is unavoidable.**

**In addition to monitoring fly densities, it is necessary to estimate the age of flies which are captured between cycles in order to differentiate between those which have emerged and those which have survived the treatment or reinvaded. Wing fray (8,9) is a simple means of field ageing but is inaccurate. The most satisfactory means of detecting old, i.e. surviving, flies is by the technique of female ovarian dissection (10,11,12). Immediately after spraying, any female tsetse caught in the treated area should be nulliparous i.e. age category 0. After ten to fifteen days newly emerged females will have had time to ovulate and they will appear as age category 1. These are not survivors. Any females captured in the treated areas which are age category 2 or more have survived the treatment or have immigrated into the block.**

---

## **The insecticide**

[▲ Top](#)

**The type and formulation of insecticide will have been decided at the onset of the operational planning. The amount required, packaging and delivery will only be decided when a strategy is finalised.**

**Endosulfan has been the insecticide of choice in most aerial spraying operations to date (except in Botswana where cocktails of endosulfan and various pyrethroids such as deltamethrin have been favoured) and this manual will refer to this compound only.**



***Plate 6. Two man screen patrol with additional acetone attractant.***



***Plate 7. Odour-baited box trap.***

**Deltamethrin has been extensively tested and does have some technical and environmental advantages over endosulfan in certain circumstances. Doubts remain about the optimum dosage of deltamethrin for use against *G. pallidipes* and this continues to be**

**investigated. No other insecticides have yet been given clearance for use in the EEC funded Regional Programme for southern Africa.**

---

## **PLANNING A STRATEGY**

[▲ Top](#)

**Having considered the broader operational options discussed above, the strategic plan will define:-**

- 1. The location, shape and size of treatment area plus marker lines, and flight directions.***
- 2. The number and type of aircraft, possibly including a helicopter for placing and servicing hazard beacons and for other support activities.***
- 3. The location and form of airstrip.***
- 4. The location and form of barriers to prevent reinvasion.***
- 5. The location, number and type of entomological surveys.***
- 6. Timing.***
- 7. Accommodation; main camp, field camps for surveys and barriers.***
- 8. Responsibilities; Government/Contractor.***
- 9. Resources required (and their provision in relation to 8. above).***

**10. The type, formulation and amount of insecticide required.**

**The following information may be useful in translating this strategy into invitations to tender for the aerial spraying and insecticide contracts:-**

---

**Contractual requirement**[▲ Top](#)

**If the operation is of the 'turnkey' type (e.g. Somalia 1988), where all activities including surveys and border protection are undertaken by the contractor the latter two considerations devolve to the contractor and are thus simply specified, together with the resource requirement, in the tender (Table 2). If these activities remain under the control of the contracting authority, there must be a clear division of labour (Table 3).**

**Table 2. The structure of a turnkey aerial spraying operation**

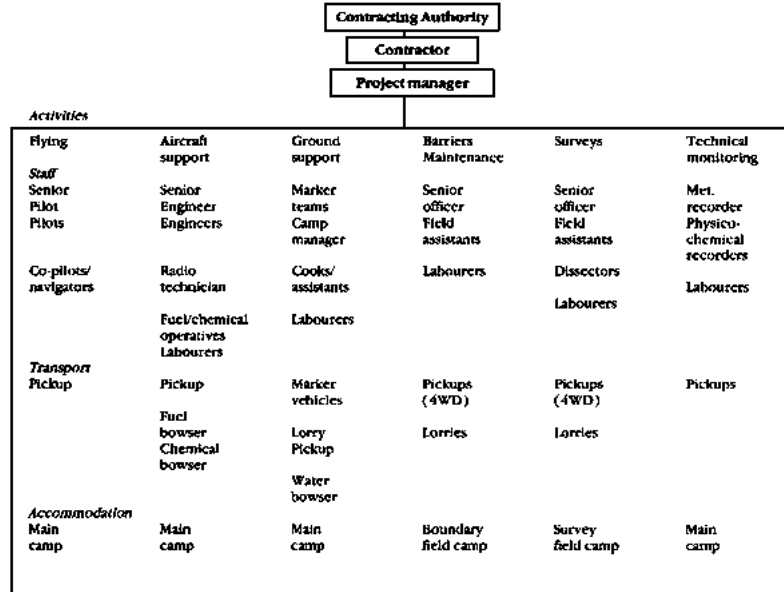

**Table 3: The structure of a central Government operation which contracts out only the flying activities and related support.**

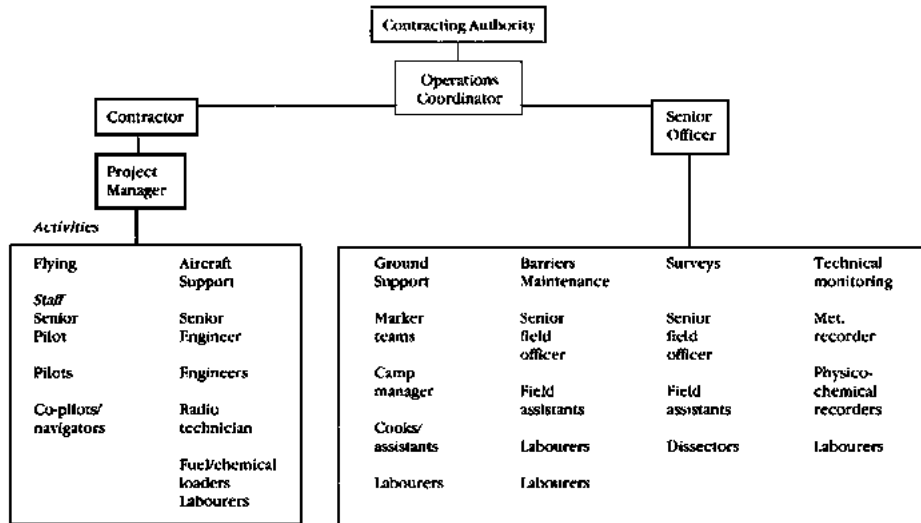

## Transport and accommodation as Table 2

**Table 3 illustrates the most common type of operation undertaken in southern Africa (viz. Botswana, Zambia, Zimbabwe) i.e. where the Government's Tsetse Control Department retains control over all ground support activities and contracts out the flying. It is apparent, even from the simple schematic plan in Table 3, that by adopting this approach the Government commitment is considerable. If funds are available but other Government resources are not, there need not be such a severe dichotomy of responsibilities. Any number of non-flying activities could be contracted out although historically the ability to undertake surveys and construct barriers has been developed by, and still largely resides within, Government Departments.**

## Major equipment requirements

[▲ Top](#)

**Illustrations of the broad equipment requirements of an aerial spraying operation are given in Table 4. There are certain items of equipment which can only be provided by the contractor and others which might more easily be supplied by central Government. Should the operation be of the 'turnkey' type, however, all the items in Table 4 would normally be provided by the contractor.**

**It is useful, before inviting tenders, to calculate certain parameters but also to be aware that some variation may need to be negotiated, e.g.**

**(i) To be cost effective, the treatment may not be an exact rounded figure such as 1500km<sup>2</sup> but may need to take account of the number of aircraft, number of sorties per night and number of nights spraying. It may also transpire that areas need to be avoided for reasons of environmental sensitivity or topographical difficulty.**

**(ii) The amount of insecticide required should include an allowance for contingencies such as loss from broken containers during delivery, re-runs and unanticipated overlaps. Emission rates should also be calculated since these will affect the spray gear specification in the tender.**

**(iii) The flying hours required should allow for contingencies such as re-runs and overlapping in the event of unfavourable meteorological conditions or navigational error.**

**Table 4: major equipment and facilities required for an aerial spraying operation**



**1. To be provided by the aerial spraying contractor**

- (i) fixed wing aircraft equipped with navigation equipment, high intensity nose lights, spray gear, and aircrew**
- (ii) helicopter and crew**
- (iii) fuel and oils with storage tanks and bowser for loading**
- (iv) ground to ground (HF) radios**
- (v) ground to air (VHF) radios**
- (vi) hazard warning beacons with power supplies**
- (vii) airstrip landing lights**
- (viii) generators for battery recharging and landing lights**
- (ix) flares and flare guns**
- (x) an air operating certificate from the Civil Aviation Authority granting permission to undertake the night spraying operation**

**2. To be provided by the Contracting Authority by agreement**

- (i) marker vehicles with telescopic masts and sundry equipment**
- (ii) water bowser and water pump(s)**

- (iii) sundry vehicles (lorries, 4WD vehicles, 2WD vehicles)**
- (iv) airstrip general working lights and power supply**
- (v) main camp lighting and power supply**
- (vi) survey camp lighting and power supply**
- (vii) dissecting microscopes and dissection kits**
- (xiii) traps, odours, electric nets etc. for tsetse surveys**
- (ix) main camp accomodation: tents, tables, chairs, cutlery, cooking facilities etc.**
- (x) main camp toilet and shower facilities**
- (xi) survey and boundary maintenance camp accomodation and facilities**
- (xii) meteorological recording equipment**
- (xiii) physico-chemical recording equipment**
- (xiv) insecticide storage and loading facilities (motorised bowser)**
- (xv) office and workshop facilities**
- (xvi) authority for contractor to import and re-export equipment**
- (xv) Government (or military) authority to undertake the night spraying operation**

---

## **Flying charges**

[▲ Top](#)

**The flying charges will include two main elements, the fixed cost and the variable or flying costs. The fixed cost includes such items as flying pay, insurance, capital outlay etc. and reduces per unit area as the size of treatment area increases.**

**In assessing a tender it is relevant to consider such factors as depreciation, which will be greater if new aircraft or equipment are used, training, which will decrease with the contractors experience, and regularity of tsetse control work which will affect the contractor's need to prepare specifically for this contract.**

**The fixed cost is a significant proportion of the overall contract charge and to help assess the validity of this element of a tender for flying services, a breakdown of the items which contribute to this cost are given as a guide in Table 5. These charges depend upon the division of responsibilities between the contracting authority and the aerial spraying contractor. The list in Table 5 covers charges directly related to the flying operations including refuelling and rechemicalling of aircraft between sorties. It excludes any charges relating to the accomodation of staff.**

**The variable costs are compiled from a number of activities which take place between starting up and shutting down each aircrafts engines. These costs are based on the number of hours each aircraft has its engines running, whether on the ground or in flight. The contractor will specify a cost per hour. Most costs will be specified per cycle and pro rata for the operation. Some costs will relate to the operation as a whole. These activities are summarised in Table 6.**

**Table 5: Summary of items contributing to the 'fixed costs' of an aerial spraying operation**

**The fixed costs include:-**

**1. Capital expenditure less estimated residual value for navigation equipment, spray equipment, radios, aircraft lights, generators etc.**

**2. Hire charges for additional aircraft, additional navigation equipment, workshop facilities/tools etc.**

**3. Staff salaries, allowances and kit:**

- basic flying pay for pilots and copilots
- salaries and overtime for engineers, assistants, radio technicians
- wages and overtime for bowser drivers, loaders and casual labour
- overalls for pilots and co-pilots, protective clothing including masks and goggles for loaders and engineers handling chemicals and fuel

**4. Pre-operational preparation:**

- fitting and testing of spray aircraft with insecticide tanks, spray gear, lights and navigation equipment
- preparation of support equipment runway lights, radio communications, support vehicles including bowsers
- pre-spray aerial surveys (aircraft and pilot costs)
- familiarisation and training (aircraft and pilot costs)

## **5. Operational support:**

- **support aircraft and road vehicles for initial mobilisation and final demobilisation plus re-supply, servicing and repair**
- **provision, utilisation and maintenance of support vehicles including motorised fuel and insecticide bowsers**
- **provision, operation and maintenance of runway and loading lights**
- **provision, placement and maintenance of hazard beacons**
- **generators for lighting and battery charging**
- **provision of field workshop facilities**

## **6. Insurance:**

- **public liability**
- **personal liability**
- **aircraft all risks**

## **7. administration.**

- **contract preparation**

- **bank charges**
- **depreciation**
- **reporting**
- **overheads**
- **contingency: currency fluctuations, foreign currency for spares etc.**

**The variable costs are compiled from a number of activities which take place between starting up and shutting down each aircrafts' engines. These costs are based on the number of hours each aircraft has its engines running, whether on the ground or in flight. The contractor will specify a cost per hour. Most costs will be specified per cycle and pro rata for the operation. Some costs will relate to the operation as a whole. These activities are summarised in Table 6.**

#### **Table 6: Summary of flying or 'valuable' costs**

##### **1. Fixed wing activities per operation:**

- **initial mobilisation (contractor's HQ to operational site)**
- **final demobilisation**

##### **2. Helicopter activities per operation:**

- **initial mobilisation**

**- final demobilisation**

**3. Fixed wing activities per cycle:**

**3.1. Pilots and co-pilots allowances for operational spraying time, bonuses for night flying etc..**

**3 2. Ground preparation (approx 0.15h):**

- warm-up, computer programming, pre take-off line-up.**
- take-off**

**3.3. Immediate post take-off (approx 0.1 h but variable)**

- circuit flying awaiting all formation airborne**
- navigation initial update**

**3.4. Ferry to and from the spray block**

**3.5. Aerial spraying**

**3.6. Turns between runs**

**3.7. Return visit between cycles to contractor's HQ for servicing etc. (as required and by agreement with the Contracting Authority)**

#### 4. Helicopter activities per cycle:

- positioning of beacons
  - general utilisation as agreed with Contracting Authority
- e.g. assistance with tsetse surveys, barrier maintenance, physico-chemical surveys

---

#### Insecticide requirements and flow rate calculation

[▲ Top](#)

The amount of insecticide to be ordered from the supplier and the flow rate used by the aerial spraying contractor depend on the dosage(s) to be applied. There is no hard and fast rule about optimal dosages and in the past they have been decided largely by 'informed guesswork'.

Endosulfan dosages for the first application have varied: 12g/ha in Botswana <sup>(13)</sup>, where the only species is *G. morsitans centralis*; 28g/ha in Zambia <sup>(14)</sup> where both *G. morsitans* and *G. pallidipes* occur; 2 × 25 g/ha in limited areas of Somalia <sup>(15)</sup> which has mostly *G. pallidipes*. Subsequent cycles (usually four, though up to six have been used <sup>(16)</sup>) have generally involved slightly lower dosages (as low as 6g/ha in Botswana) to reduce cost and environmental contamination on the understanding that all old, pregnant females (considered the most tolerant to insecticide) will have been eliminated by the first application.

A dosage of about 20g/ha is a suitable first cycle dosage for *G. morsitans*. In Zimbabwe, the first cycle against *G. pallidipes* has usually been in the region of 24 g/ha but recent



**wind tunnel studies and experience in Somalia suggest that a higher rate, of about 28 g/ha, would be more appropriate. In rugged terrain or over areas of dense vegetation it would certainly be prudent to increase these dosages slightly. To eliminate any risk of old, pregnant females being present after the first cycle, the second cycle is often kept high or is only reduced by, say, 2 g/ha. The third, fourth and fifth applications can be reduced by a further 2-4 g/ha. The first and second applications are usually with a 30% e.c, otherwise the flow rate is inordinately high. The latter applications with lower dosage rates generally require a 20% e.c. to keep the volume application rate and number of droplets sufficiently high.**

**To illustrate the calculation of insecticide requirements and application rates, an arbitrary treatment area of 1550 km<sup>2</sup> is used and the following operational statistics assumed:**

- (i) area to be treated 1550 km<sup>2</sup>;**
- (ii) flight interval (swathe width) 250m;**
- (iii) aircraft average speed 250 kph;**
- (iv) insecticide endosulfan 30% and 20% e.c.;**
- (v) dosage rates required per cycle: 24 (30% e.c.), 20 (30% e.c.), 18 (20% e.c.), 18 (20% e.c.), 18 (20% e.c.)g/ha.**

**From (v) above, the total operational dosage per hectare is 98g active ingredient(gai)/ha which is equivalent to 9.8kg/ km<sup>2</sup>.**

**The total amount of active ingredient applied over an area of 1550 km<sup>2</sup> during an**

**operational period of 2-3 months is 15190 kg.**

---

## **Insecticide requirement**

[▲ Top](#)

**The insecticide will be ordered as formulated chemical with 30% e.c. containing 300 gai/litre and 20% e.c. containing 200gai in a mixture of volatile solvents which are not normally specified for a brand name product such as Thiodan (Hoechst). Deisoline, which is relatively inexpensive, has been used as the primary solvent but the results were questionable thus its use is not encouraged.**

**The application rate per km<sup>2</sup> is calculated by dividing the required dosage rate per km<sup>2</sup> (rate in g/ha × 100) by the insecticide concentration in gai/litre. Thus for 24 g/ha of 30% e.c. the application rate/km<sup>2</sup> is:**

$$\frac{2400(\text{gai/km}^2)}{300(\text{gai/l})} == 8 \text{ litres/km}^2$$

**Similarly, the application rate for 20 g/ha of 30% e.c. = 6.67 litres/km<sup>2</sup>.**

**The amount of 30% e.c. required for the first two applications over an area of 1550 km<sup>2</sup> would therefore be 22738.5 litres of formulated chemical. Allowing for contingencies (approx 5%) and the probable form of delivery in 200 litre drums (Plate 9), the order would be for 24,000 litres.**



**Plate 8. The insecticide is usually delivered in clearly labelled 200l drums.**

**In the same way, the amount of 20% e.c. for each of three applications at the dosage rate of 18 g/ha would be calculated as:**

$$\frac{18 \times 100 (\text{gai/km}^2)}{200 (\text{gai/l})} = 9 \text{ litres/km}^2$$

**The amount of 20% e.c. required for three applications at 18 g/ha would be 41850 litres plus approximately 5% giving an order of 44000 litres.**

---

### Flow rate calculation

[▲ Top](#)

$$\text{Insecticide flow rate} = \frac{(\text{aircraft speed} \times \text{swathe width}) \times \text{dosage rate}}{60 \times \text{insecticide concentration}}$$

**(aircraft speed in kph, swathe width in km, dosage rate in gai/km<sup>2</sup> and insecticide**

**concentration in gai/litre)**

**Thus for 24g/ha of 30% e.c. the flow rate is calculated as:**

$$\frac{250 \times 0.25}{60} \times 2400 / 300 = 8.33 \text{ litres/minute}$$

**and 18g/ha of 20% e.c. is achieved by an application rate of:**

$$\frac{250 \times 0.25}{60} \times 1800 / 200 = 9.37 \text{ litres/minute}$$

**Flow rates in the region of 8 or 9 litres/minute are difficult to achieve with a single rotary atomiser of the Micronair type thus two atomisers would be recommended for the above examples.**

---

**Estimation of the operational flying time per aircraft**

[▲ Top](#)

---

**Mobilisation/demobilisation**

[▲ Top](#)

**The Contract must specify whether the spray aircraft are to remain on site throughout the operation or return to the contractor's headquarters between cycles. If the contractor is not a national company or is not local the aircraft will almost certainly remain on site throughout. If the contractor is local it may be more convenient and possibly cheaper for repairs and servicing between cycles to be carried out at headquarters.**

---

**Pre-flight preparation**

[▲ Top](#)

**Operational flying hours are calculated from the time the spray aircrafts' engines are switched on to when they are switched off. The engines will be running for several minutes before take-off while the pilots carry out their on board pre-flight checks, programme the navigation computer and wait for the entire formation to become airborne. The lead aircraft may also need to circle the airfield while the formation takes off since it is likely only the leader will carry the navigation equipment which will take them, in the dark, to their entry point into the spray block. If the airstrip is of a sufficiently high quality (Mt Darwin, Zimbabwe, Maun, Botswana) a formation of up to four aircraft may be able take off simultaneously thus saving time and reducing the difficulty of making contact in the dark.**

**Preparatory activities require about 0.25 h per aircraft per sortie depending upon the specific situation and particularly the type and state of airstrip.**

---

### **Ferrying to and from the spray block**

[▲ Top](#)

**The flying time between the operational base camp and the start of each sortie, plus the return flight from the end of the sortie, can be a major proportion of the total flying time and can be reduced with careful planning. Factors to consider are:**

**(a) The location of the airstrip in relation to the spray block. In this present context the cost of ferrying will be reduced if the airstrip is close to or within the spray block but any such saving should be compared with the possible cost of airstrip preparation.**

**(b) Where possible, each sortie should start and end at the closest practical point to the airstrip thus reducing the percentage of non-spraying time in the overall sortie time. This will be a false economy if the amount of insecticide subsequently**

**sprayed is significantly below the aircraft's load carrying capability and leads to an increase in the number of sorties.**

---

## Turns

[▲ Top](#)

**The number of turns per sorties is one less than the number of runs. The time for each turn depends upon various factors including the number of aircraft in the formation, terrain, daylight or night flying and aircraft type. When a small formation turns at night, particularly in rugged terrain the aircraft must climb well above ground level, undertake a procedure turn while keeping in close radio contact then descend to spraying height for the next run. This will take approximately four minutes. In daylight hours they may be able to turn at ground level thus reducing the turn time to, say, three minutes. If there are only two or three aircraft of a manoeuvrable type such as the Ayres Turbo Thrush, in daylight, over reasonably flat terrain this can be reduced even further, possible below two minutes using turns similar to those employed in crop spraying.**

**The contractor should be discouraged from reducing flying time by attempting rapid turns since these may result in pilot disorientation, especially with inexperienced crews. A three minute turn is about average for estimating costs.**

***NB. As a guide, the entire operation should achieve an 'activity' rate of about 28-30 km<sup>2</sup> sprayed per hour of total flying time. Thus for a 1550 km<sup>2</sup> operation the total fixed wing flying time should be in the region of 260-280 hours exclusive of mobilisation and demobilisation.***

***Operational 'efficiency' (hours spray time as a percentage of total flying time), exclusive of mobilisation/demobilisation, is generally about 45-50%. Unless there is an obvious***

***reason, such as minimal ferry time, any tender which indicates a percentage efficiency considerably above 50% should be cautiously assessed.***

**Having formed a plan of operation based on the ten strategic points listed above, tenders will be invited for the provision of insecticide and for an aerial spraying contractor to apply it. This latter invitation will also specify which, if any, additional services are to be sub-contracted.**

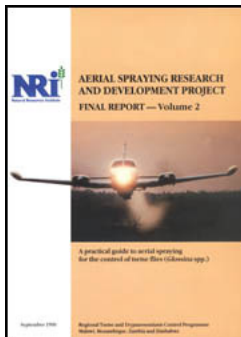

 **Aerial Spraying Research and Development Project - Final Report - Volume 2**

**Author(s):** *R. Allsopp*

**Publication date:** *1990*

**Number of pages:** *55*

**Publisher:** *Natural Resources Institute (NRI)*

**ISBN:** *5100.35.94.269*

**Copyright holder:** *Crown*

**Contents:**

 **CHAPTER 2: TENDERS AND CONTRACTS**

















 **THE AERIAL SPRAYING TENDER**

 **Part A - Special Conditions**

 **[Instructions to tenderers](#)**

 **[Proof of standing and ability](#)**

 **[Financial considerations](#)**

-  [Documentation to be provided after award of contract](#)
-  [Evaluation, breach of contract and sanctions](#)
-  [Part A - Technical Annex](#)
  -  [Contractual objectives and general information.](#)
  -  [Flying instructions](#)
  -  [Aircraft equipment](#)
  -  [Rugged terrain](#)
  -  [Bill of Quantities and Price Schedule](#)
-  [Part B - The General Conditions](#)
-  [Adjudication of the aerial spraying tenders](#)
-  [THE INSECTICIDE TENDER](#)
  -  [Part A - Technical Annex](#)
    -  [General information](#)
    -  [Insecticide specification](#)
    -  [Delivery and packaging](#)
    -  [Information to be supplied by the successful tenderer](#)
-  [THE CONTRACTS](#)

---

## CHAPTER 2: TENDERS AND CONTRACTS

[▲ Top](#)

---

## THE AERIAL SPRAYING TENDER

[▲ Top](#)

**The invitation to tender should be published approximately one year before the operation**



**is due to take place. This allows time for contractors to produce their tenders, have them scrutinised by the Contracting Authority and for the contract to be awarded well in time for the successful applicant to prepare and acquire specialised equipment. It also allows time for surveys and other preparatory activities to commence in advance of the operation.**

**The form of the invitation to tender varies between countries and between donors but in essence it must accurately describe the work to be done and the conditions governing operational procedures. Using EEC procedure as a guide, the tender dossier will normally include three sections:**

**Part A. The invitation identifies the subject of the tender, advises on the required form and timing of the tender and lists any special conditions, including financial arrangements, which supercede the general conditions specified in Part B.**

**The technical annex to Part A clearly describes the work to be carried out, specifies the resources required, allocates responsibilities and advises how the 'bill of quantities' and pricing schedule should be presented.**

**Part B. The 'general conditions' with which applicants must comply in submitting their tenders, to which the successful applicant must adhere in fulfilling the contract and which will govern both the adjudication of the tenders and the evaluation of the completed contract.**

---

## **Part A - Special Conditions**

[▲ Top](#)

**These will be based on the General Conditions given as Part B but will specifically and comprehensively relate to the contract in question. These conditions will include the**

**following:**

---

**Instructions to tenderers**[▲ Top](#)

- a. The language in which the tender and all correspondence must be conducted will be stipulated.**
- b. The currency of the tender (e.g. ECU or a national currency) will be stipulated.**
- c. Time limit for the submission of tenders (e.g. 90 days).**
- d. Constraints on the origin of equipment to be used by the contractor.**
- e. Period during which the tenderer is bound after submitting the tender (e.g. 90 days).**
- f. The tenderer must make available within a specified time (e.g. 7 days) any additional information that may be required by the Contracting Authority to facilitate their assessment of the tender.**
- g. The tenderer must declare that all regulations relating to environmental protection will be respected and agree to provide the Contracting Authority or designated representative with details of any significant accidental contamination within a specified period (e.g. 4 days).**
- h. The contractor must allow the Contracting Authority or designated representatives free access to all operational sites at all times.**
- i. The contractor must agree to provide a complete work record showing area**

**covered, total tachometer hours and total insecticide used within a specified time (e.g. 5 days) after the completion of each application.**

**j. The contractor must comply with the instructions of the Contracting Authority with regard to the timing of each insecticide application.**

---

## **Proof of standing and ability**

[▲ Top](#)

**a. The tenderer must have, and provide details of, previous operational tsetse control experience.**

**b. The tenderer must provide copies of the Certificate of Incorporation, Memorandum of Association and a recent, externally audited statement of the company accounts.**

**c. The tender must include details of the contractor's senior management, technical and flying staff and indicate what support and servicing facilities are available.**

**d. The experience of pilots and crew who will actually undertake the flying must be accurately documented with special attention to hours accumulated on tsetse control, low-level flying and night flying.**

**e. Details of any intended sub-contractor must be declared together with proof of their standing, capability and relevant experience.**

---

## **Financial considerations**

[▲ Top](#)

- a. A guide to the expected contract price should be given.**
- b. The special conditions will specify whether the contract is to be based on a fixed cost or unit price (e.g. cost per unit area for five applications).**
- c. The tender must be accompanied by a bank guarantee, tender bond or deposit equal to a percentage (e.g. 1%) of the tender.**
- d. If the tenderer wishes to be protected against price fluctuations (e.g. for imported fuel and oils), this must be specified and accompanied by supporting documentation in the tender.**
- e. Any foreign currency requirement should be indicated.**
- f. The regulations relating to the payment of advances will be stipulated (e.g. a lump sum advance of 10% of the contract price may be advanced providing the contractor furnishes proof of a bank guarantee or deposit of an equivalent amount).**
- g. The method of payment will be stipulated (e.g. interim payments totalling 80% of the total contract price as installments after each application has been completed to the satisfaction of the Contracting Authority and a final payment of 20% on satisfactory completion of the contract).**

---

#### **Documentation to be provided after award of contract**

[▲ Top](#)

- a. The contractor must advise the Contracting Authority within a specified period (e.g. 14 days) who will act as 'site agent', when the agent will arrive on site, when**

**all personnel and equipment will arrive on site.**

**b. The contractor must produce a detailed forward work plan within a specified time after the contract is awarded.**

---

## **Evaluation, breach of contract and sanctions**

[▲ Top](#)

**a. The Special Conditions should indicate who will evaluate the performance of the contractor and monitor environmental contamination. It should also indicate what criteria will be used to evaluate the completed contract.**

**b. The Contracting Authority will be empowered to terminate the contract in the event of unacceptable environmental contamination or damage to human health. Should these eventualities occur as a result of negligence on the part of the contractor it will constitute a breach of contract.**

**c. If authorised ground observers report navigational inaccuracy or areas undertreated for some other reason the area must be retreated. Should responsibility for the error lie with the contractor, no payment will be due for the flying time accrued.**

**d. A delay in executing the contract or in starting subsequent applications on the dates prescribed by the Contracting Authority will result in sanctions (e.g. 2% of the total contract price per day of delay) unless due to weather or other unavoidable condition.**

**e. In the event of the operation being abandoned by the Contracting Authority for reasons other than breach of contract on the part of the contractor, compensation**

**will be payable to the contractor.**

---

## **Part A - Technical Annex**

[▲ Top](#)

**The following technical summary and recommendations are based upon the aerial spraying experiences of the Natural Resources Institute (NRI) and the findings of the ASRDP. Alternative methods and equipment may be available and suitable, others may prove suitable if demonstrated to the Contracting Authority. This section is not intended as an example of a technical annex but is a guide to what information should be conveyed in the annex and what specific requirements should be noted. Additional information is listed in Table 4.**

---

### **Contractual objectives and general information.**

[▲ Top](#)

- a. The objective of the contract is to eradicate (or control as stated) tsetse flies from an area of.....km<sup>2</sup> by five sequential applications of.....insecticide applied as an aerosol from fixed wing aircraft.**
- b. The location of the treatment area must be indicated on a map showing the intended block size and configuration (which will be the subject of the competitive tender but should be open to negotiation, slight modification and possible price amendment after the contract is awarded), the topography in and around the block, the exact location of the proposed airstrip and any other nearby strips which the tenderer might prefer to use or might be used for emergency landing.**
- c. The length, width, constitution and condition of airstrips indicated on the map**

**should be clearly stated.**

**d. The proposed starting date and latitude in days before or after should be stated. Having started the operation the contractor must adhere strictly to the schedule advised by the Contracting Authority's operations manager. The expected duration of spraying activities from the start of cycle 1 to the end of cycle 5 is between 50 and 70 days. The interval between applications will generally be between 12 and 16 days and is highly unlikely to vary more than four days either side. The contractor should complete each cycle as quickly as possible but should not, under any circumstances, take more than eight nights.**

**e. Exceptionally, a sixth application may be required. The contractor must be prepared for this eventuality. The contract price would be amended accordingly.**

---

## **Flying instructions**

[▲ Top](#)

**a. The number of fixed wing aircraft to be provided by the contractor must be stated.**

**b. These should be light, general aviation twin-engined aircraft with an all-up weight between 2000 and 3000 kg, carrying capacity of approximately 450 kg and cruising speed in the region of 240-260 kph (130-140 knots).**

**c. Dedicated, single-engined, crop spraying aircraft might be considered with the approval of the Contracting Authority. If the airstrip is known to be very rough, preference might be given to high winged aircraft.**

**d. The emission/flying height will normally be 2-3m above the tree canopy or 15-**

**20 m above the ground except in rugged terrain.**

**e. Flight direction will, where possible, be at 90° to the prevailing wind direction (state prevailing wind direction).**

**f. Spraying will normally take place between 1700h and 0730h when there is a temperature inversion and generally stable meteorological conditions. Any rugged terrain may need to be treated during daylight hours. Spraying must be postponed if wind speeds at ground level are persistently above 3.5 - 4 m/sec throughout the treatment area or the aircraft are experiencing severe buffeting at normal spraying height. This does not apply to localised winds or brief gusting.**

**g. If a sortie is terminated due to prolonged high winds, an overlap may be required when operations resume.**

---

## **Aircraft equipment**

[▲ Top](#)

### **a. Lights:**

**The aircraft must be fully equipped for night flying and be fitted with a powerful (e.g. 3 million candle power) nose light which is manoeuvrable horizontally and vertically. Where bird strikes are a probability the nose light will need to be adequately protected.**

### **b. Navigation equipment:**

**A least one aircraft in each formation must be fitted with equipment capable of**



**navigating between the airstrip and the start of each spray run, maintaining a straight flight path for up to 100km without lateral deviation in excess of 125m, undertaking a procedure turn and returning on a reciprocal flight path displaced one swathe width e.g. 250m and maintaining this performance for the duration of each sortie (i.e. about 2-2.5 hours).**

**The British Aerospace/Racal-Decca Inertial Mixed System (comprising Decca Doppler type 72 navigation radar, Sperry SGP 500 twin gyro heading and attitude reference platform and Decca Tactical Air Navigation System (TANS) computer has proved capable of meeting these requirements.**

#### **c. Spray gear:**

**The aircraft should be fitted with external insecticide tanks except if specialised crop spraying aircraft. Internal insecticide tanks are not recommended. The aerosol generator should be of the rotary atomiser type capable of producing an aerosol with droplet volume median diameter in the region of 20-30 microns when applied at normal emission height and measured on MgO coated rotating slides 1 m above the ground. The atomiser(s) must be capable of insecticide flow rates normally within the range of 7-9 l/min. The atomiser cage can be wind or electrically driven. In the former case a protective shroud should be fitted to prevent fuselage or internal damage in the event of blades breaking in flight (Plate 9). The application monitor must display and record atomiser cage speed (10,000-12,000 rpm in level flight), flow rate in flight, total insecticide applied and, preferably, emission time.**

**The Micronair AU 4000 atomiser and dedicated monitor has proved capable of producing the required droplet spectrum and application information both accurately and reliably.**



***Plate 9. A metal or fibre glass shroud protects the fuselage should blades break off during flight.***



***Plate 10. Hilly terrain being treated by a Bell Jet Ranger.***

**a. If the treatment area includes rugged terrain this should be independently assessed to establish whether it is sufficiently extreme to exclude the use of fixed wing aircraft (Plate 10). If so, and if not too extensive, it could be treated by helicopter (17). In this event, the helicopters should be sufficiently powerful and manoeuvrable i.e. at least of the Bell Jet Ranger or Aerospatiale Squirrel type. Spraying would be daylight hours only. Alternatively, consideration should be given to using ground spraying or impregnated targets.**

**b. If bordered by rugged terrain which is not to be treated by aerial spraying but could represent a hazard during night spraying, prominent features should be marked with beacons. The deployment of hazard warning beacons is greatly facilitated by or may even necessitate the provision of a helicopter. For beacon deployment a small aircraft such as the Bell 47 is adequate.**

---

## Bill of Quantities and Price Schedule

[▲ Top](#)

**A summary of the fixed and variable costs must be presented as a Bill of Quantities and Price Schedule. Taking a fixed price contract as an example this schedule is drawn up as follows:-**

ITEM	QUANTITY	UNIT PRICE	AMOUNT
1. FIXED COSTS			
1.1. Initial mobilisation and final demobilisation			

1.2. All risks insurance			
2. TOTAL FIXED COST			
3. FLYING COSTS PER CYCLE			
3.1. Mobilisation/demobilisation			
- distance from HQ to field base			
- total flying hours			
3.2. Pre-flight preparation			
- time per sortie			
- number of sorties			
- total flying hours			
3.3. Ferrying			
- average ferry distance			
- number of ferries			
- total flying hours			
3.4. Turns			
- number of turns			
- time per turn			
- total flying time			
4. TOTAL FLYING CHARGES PER CYCLE			

4. TOTAL FLYING CHARGES PER CYCLE			
5. TOTAL FLYING CHARGES FOR FIVE CYCLES			
6. TOTAL FIXED CONTRACT PRICE (2. + 5.)			

---

## Part B - The General Conditions

[▲ Top](#)

**Part B of the EEC tender dossier is a standard list of instructions and conditions entitled 'General Conditions for Works Contracts Financed by the European Development Fund' with the reference number C-25/DGVIII/1982-EN. It can be obtained from the Commission for European Communities, DG for Development, 200 Rue de la Roi, B - 1049 Brussels, Belgium.**

---

## Adjudication of the aerial spraying tenders

[▲ Top](#)

**Both aircraft and insecticides can be hazardous to people, livestock and the environment if not handled with professional care and respect. It is therefore essential in assessing the aerial spraying tenders to establish the competence of the contractor. Nothing is as satisfactory as previous experience in the successful operation of tsetse control but if none of the tenderers has this experience then the ability of the tenderers to bring in advisers and train staff must be carefully evaluated.**

**It is essential that pilots who will actually undertake the low level night flying have appropriate experience, and there must be clear statements by the tenderers who these people will be and who will replace them should the eventuality arise.**

**The invitation to tender should state clearly which specialised equipment and services are**

**to be provided. The tenderers must unequivocally comply with these specifications or prove to the satisfaction of the Contracting Authority that any suggested alternative has an equal capability. Those tenders which do not comply with these requirements should be declared invalid.**

**To assess the capabilities of the company and the pilots and to confirm compliance with the required technical specification, the tenders must be appraised by technical experts without reference to cost. Only those which satisfy technical scrutiny should be given further consideration.**

***Under no circumstance should an aerial spraying contract be awarded with lowest cost as the sole or primary consideration.***

---

## **THE INSECTICIDE TENDER**

[▲ Top](#)

**The invitation to tender for the supply of insecticide is similar in form to that described above for the aerial spraying. Part A - Special Conditions supplies essentially the same information but specific to the supply of insecticide, thus stating amounts, delivery instructions etc. but not requiring proof of standing and ability. Part B - General Conditions is again available in a standard form entitled 'General Conditions for Supply Contracts Financed by the European Development Fund. Reference number C-25/DGVIII/1982-EN.**

---

### **Part A - Technical Annex**

[▲ Top](#)

---

### **General information**

[▲ Top](#)

**a. The insecticide required is endosulfan (6,7,8,9,10,10-hexachloro-1,5,5a,6,9,9a-hexahydro-6,9-methano-2,4,3,benzodioxathiepin- 3 -oxide).**

**b. The formulations required are 30% and 20% emulsifiable concentrates.**

**c. Total quantities required are:**

.....litres 30% e.c.

.....litres 20% e.c.

**d. Tenderers must state the origin, date of manufacture and proposed place where formulation will occur of the technical material. This must be supported by a certificate from the manufacturer.**

**e. The contractor must provide sufficient neutralising agent (e.g. 2000 litres) to deal with a major spillage and must specify the chemical nature and packaging in the tender.**

---

## **Insecticide specification**

[▲ Top](#)

**a. The formulation must be suitable for aerial application through a rotary atomiser to give an aerosol with volume median diameter of 20-30 microns when applied from a height of 15-20 m and measured on rotating MgO coated microscope slides 1 m above the ground.**

**b. Aromatic solvents with boiling points (approx 166°C) suitable for tsetse control**

**must be used. The use of diesel for the bulk solvent will not be accepted. The solvents must be named and the dynamic viscosity at 20°C of the resultant formulations stated (e.g. for endosulfan 20 % e.c.  $1.92 \pm 0.5$  Mpas 30% e.c.  $2.19 \pm 0.15$  Mpas).**

**c. Specific gravity of the formulation should be given (e.g. 0.88 for Thiodan).**

**d. The formulation must not result in the crystallisation of active ingredient in any part of the spray gear.**

**e. Labelling of the drums must be clear and durable indicating:**

- the contents**
- the concentration of the formulation, clearly differentiating between 30% and 20% e.g. with different coloured drum tops**
- batch number and date of formulation**
- clear hazard warning in accordance with FAO guidelines and in appropriate languages.**

---

## **Delivery and packaging**

[▲ Top](#)

**a. The delivery date and specific delivery location (i.e. container depot, local supplier, field camp or airstrip) of the formulated insecticide must be specified.**



**b. Packaging instruction must be specified (e.g. new, non-returnable, lacquer-lined, 1.2mm tight-head drums of 210 litre capacity which are tab sealed with two screw bungs).**

**c. Precise labelling instructions must be given**

---

### **Information to be supplied by the successful tenderer**

[▲ Top](#)

**a. The date of formulation.**

**b. A quality control certificate from an internationally recognised, independent organisation such as Société Générale de Surveillance confirming that the technical material supplied by the manufacturer and/or the formulated insecticide conform to tender specification.**

**c. Certification by a local, independent analyst that random samples of the formulation conform to specification immediately prior to operational use.**

**d. The EEC require a certificate that supplies and packaging conform with relevant health and safety regulations and that the insecticide is not banned for use in EEC countries.**

---

### **THE CONTRACTS**

[▲ Top](#)

**The successful tenderers for both aerial spraying and insecticide contracts will be notified by way of a letter of contract.**

**This letter will specify the subject of the contract, its timing, value and method of payment. It will reaffirm special conditions such as adherence to environmental or packaging regulations and will indicate which, if any, conditions specified in the invitation to tender have been renegotiated. For instance, the aerial spraying contract will specify whether the spray aircraft must remain on site between cycles or return to the contractors headquarters.**

**In the event of negotiated terms, the letter of contract supercedes any conditions specified in the invitation to tender.**

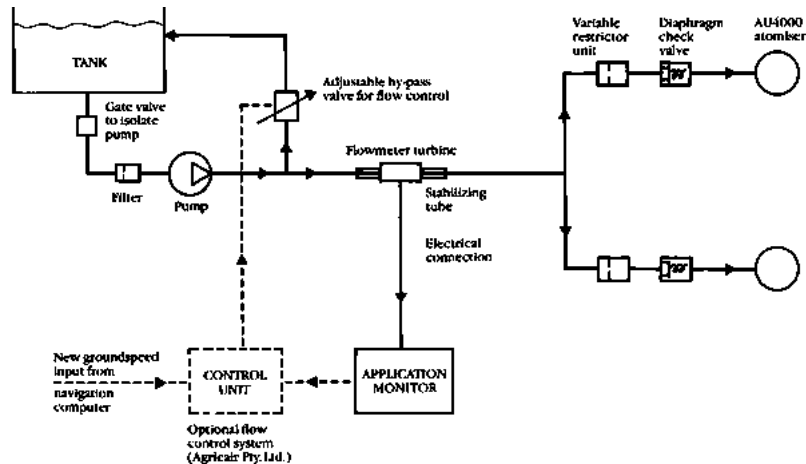

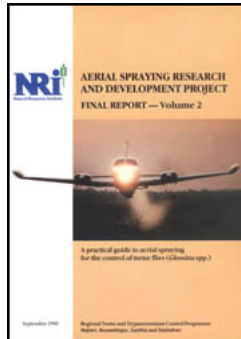

## Volume 2

**Author(s):** *R. Allsopp*

**Publication date:** *1990*

**Number of pages:** *55*











**Publisher:** *Natural Resources Institute (NRI)*

**ISBN:** *5100.35.94.269*

**Copyright holder:** *Crown*

### Contents:

#### **CHAPTER 3: OPERATIONAL PROCEDURES**

-  [Spray gear: setting and calibration](#)
-  [Insecticide loading and handling](#)
-  [Crew training and rostering](#)
-  [Track guidance/navigation](#)
  -  [Navigation equipment](#)
  -  [Ground marker parties](#)
-  [Timing the applications \(cycles\)](#)
-  [Emergency precautions](#)
  -  [Personal safety](#)
  -  [Environmental safety](#)

---

## CHAPTER 3: OPERATIONAL PROCEDURES

[▲ Top](#)

### **Spray gear: setting and calibration**

**ASRDP and NRI operational experience has been limited to Micronair rotary atomisers which are used almost exclusively in tsetse spraying. Other systems are available and some have been tested but the following notes relate only to Micronair equipment and specifically the model AU 4000 (Figure 1).**

**The spray gear consists of the following basic units:**

- (i) the insecticide tank**
- (ii) the pump**
- (iii) the flow controller and printer**
- (iv) the flow turbine**
- (v) the atomiser**

**Insecticide tanks can be fitted internally in place of the passenger seats or as custom-made external belly tanks. The former have shown a tendency to leak or allow the highly volatile solvents to escape inside the aircraft. This can be unpleasant and distracting to the pilots and is only avoided with certainty by using external tanks. Whether internal or external, the tanks should be filled through external dry couplings to avoid spillage and leakage. Each tank will have a 'dump' facility which is either mechanically or electrically activated. The position of the dump switch is important; it must be close at hand and readily accessible but not in a position where it can be accidentally activated. The dump door seal must be of a material resistant to corrosive chemicals otherwise leaks, possibly quite severe, will occur.**

**Pumps may be electrically or hydraulically driven. Electrically driven centrifugal pump (e.g. Stuart Turner 12HS) are well suited. The pump pressurises the system to about 2 bars (30 psi) and, allowing for some recirculation, should have a capacity of 10-15**

**litres/minute at this pressure. It must be constructed of materials resistant to corrosive chemicals and should ideally be fitted with ceramic or graphite seals. It should be mounted below the tank so that there is always a head of chemical above it to allow flooded suction. A gate valve ahead of the pump allows cleaning and servicing when the tank is full.**

**To set and check the emission rate it is first programmed into the computerised application monitor while the aircraft is on the ground. The operator (co-pilot) inputs aircraft speed and swathe width then with the monitor set to read volume/area (litres/ha) the pump is switched on. Insecticide flows through the system to be collected in a container placed beneath the stationary atomiser and pressure in the system is adjusted by means of a by-pass valve until the required flow rate is shown on the monitor. Having achieved the required 'indicated' flow rate this can be checked by measuring the amount of insecticide collected in a calibrated container during a period of, say, five minutes and extrapolating to litres/minute. Care must be taken to avoid splashing while carrying out this calibration procedure. A closed 200l drum with a single square aperture which fits over the atomiser and which preferably can be wheeled into place ensures minimum splashing and maximum accuracy.**

**A method by which flow rate automatically adjusts to accommodate changes in ground speed was developed jointly by Micronair and Agricaire (PVT) Ltd. This system replaces Micronair's application monitor with a flow controller and is dependant upon some means of estimating ground speed i.e. Doppler. It is extremely useful, if not essential, for even distribution of insecticide over undulating terrain and overcomes the need for manual flow rate adjustment to accommodate speed changes which are inevitable on reciprocal runs due to wind influences etc..**

**The digital read-out of either the monitor or controller can be switched to show the flow rate at any time, the atomiser cage speed or the amount of insecticide used so far in the**

**sortie. This information can be printed out for recording purposes.**

**The flow turbine measures the insecticide flow rate and passes this information as required to the monitor. Depending on the flow rate to be used, the turbine will be either 0.5 inches (127mm - Micronair part No. EX 2027) or 0.625 inches (159mm - part No. EX 524) in diameter. The former will measure flow rates from 1 to 8 litres/minute, the latter 5-40 litres/minute. To stabilise the flow of insecticide through the turbine, metal 'straightening tubes' must be connected immediately upstream and downstream of the turbine. The upstream tube should be ten times the turbine diameter, the down stream tube five times the diameter. The remaining plumbing can be flexible tubing but, as with the pump, it should all be corrosion resistant.**

**The atomiser is essentially a spinning cage usually driven by adjustable, wind powered fan blades (Plate 11). The blade angle can be adjusted between 25° and 45°, the smallest angle giving the greatest cage speed. A typical blade angle to give the required droplet spectrum for tsetse spraying is 30-32.5°. Insecticide enters the central spindle of the cage through a variable restrictor unit (VRU) which has seven apertures marked in odd numbers between 1 (0.77mm diameter) and 13 (5.56mm). At a pressure of two bars the smallest aperture gives a flow rate of 0.34 litres/minute and the largest 16.2 litres/minute. A setting of nine or eleven is common for tsetse spraying. Both the VRU aperture and blade angle should be set before the system is calibrated and must then be kept constant once the correct parameters are produced.**

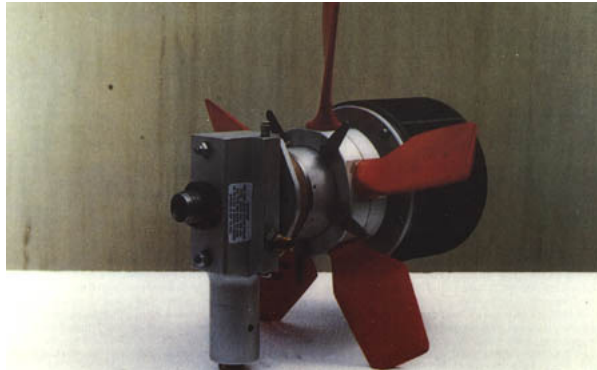

***Plate 11. Micronair AU 4000.***

**Calibration of the system is partially carried out on the ground and partially in flight. Calibration of the cage speed and corresponding aerosol droplet size require the aircraft to overfly a sampling position where droplets can be collected on MgO coated 6.35mm microscope slides. The procedure for measuring droplet sizes is given in Chapter 4.**

---

### **Insecticide loading and handling**

[▲ Top](#)

**The SEMG recommend procedures for transporting insecticide to the treatment area and from the storage compound to the aircraft. They also specify protective clothing to be worn by all persons handling insecticide (18) including engineers who may need to adjust an atomiser etc. and must set an example for the unskilled labour.**

**The insecticide will probably be delivered in 200l drums from which it can be pumped directly into the aircraft's insecticide tank or via a holding tank (Plate 12). Such loading**

**methods are, however, slow, prone to splashing and not to be encouraged. It is more efficient to transfer the insecticide from the drums into a motorised bowser preferably while standing on a concrete pad which can be washed down should there be any spillage. The insecticide can then be pumped through dry couplings from the bowser into the aircraft tanks.**



***Plate 12. Rechemicalling the aircraft direct from the drums or via a holding tank can cause splashing and has largely been replaced by dry couplings and motorised bowsers.***

**Loading directly from drums can cause long intervals between sorties and this is undesirable for a number of reasons. They leave the marker parties unoccupied, often in the middle of the night, which, at the very least is boring, but can result in them falling asleep thus delaying the next sortie even further. Prolonged delays leave more time in which wind changes can disrupt the insecticide drift. They can reduce the number of sorties achievable per night and should problems arise, such as aircraft breakdown which demands increased work with the facilities remaining, this could be critical.**

**In order to monitor the amount of insecticide applied, it is important to maintain accurate**



**records of insecticide loaded each sortie, the volume applied, and the residue remaining in the tank after each sortie. The application monitor print-out will give the total amount sprayed per sortie but a malfunction could give inaccurate records and may go unnoticed unless physical checks are made during loading. This could result in under or over dosing and in extreme cases could result in insufficient chemical available to complete the operation. The insecticide should therefore be accurately metered into the aircraft's tank then the residue checked against the indicated load sprayed according to the monitor or controller. These records should be regularly scrutinised by the operation manager and should reveal any discrepancy in the application rate.**

**It is not advisable to leave the highly corrosive insecticide formulation in the tanks during prolonged period of inactivity such as between cycles.**

**Aircraft refuelling must also be undertaken with care but this will be entirely the responsibility of the contractor and carried out under the supervision of the flying crews or engineers. Normal safety procedures such as no smoking during refuelling or in the vicinity of fuel storage tanks must be observed at all times.**

**The provision of adequate lighting to ensure safe refuelling and rechemicalling during the night is essential and neither operation should be allowed while aircraft engines are still running.**

---

## **Crew training and rostering**

[▲ Top](#)

**These activities will be the responsibility of the contractor who must have appropriate experience. Inexperienced crews can be used if properly trained and used selectively.**

**For their own safety and to avoid environmental accidents such as unnecessary dumping,**

**the crews must be entirely familiar with their aircraft and their use at night. It is not advisable for pilots to switch from one aircraft to another during an operation. The continuous concentration needed for low-level night flying is extremely demanding and the margin for error slight. Absolute familiarity with a single aircraft for the duration of an operation should be encouraged wherever possible.**

**Formation flying is not a familiar activity to most non-military pilots and pre-operational training is essential again for safety and environmental reasons. Estimating and maintaining a distance of 250m from a lead aircraft while flying low level at night requires practice and should not be left for the first operational cycle. It is also advisable to retain a formation structure throughout the operation i.e. each trail aircraft always on the same side of the leader thus not having to estimate distances to the right on one run then to the left on another. Maintaining common flight speeds within the formation is also important since trail aircraft falling behind have a tendency to pull into line astern thus overdosing in some areas and underdosing in others. This can be avoided by having all aircraft of the same type or at least with similar performance capabilities.**

**Low-level night flying is also an activity which is alien to most commercial pilots and will require some group training. Turning between reciprocal runs and descending back to spraying height, at night, in a formation of three or four aircraft, is probably the most difficult manoeuvre in tsetse spraying and, again, cannot be left until undertaken in operational circumstances. Some visual assistance can be provided to keep the formation in contact and help avoid disorientation, which is not uncommon during turns. Strategic positioning of lights reflecting from the tail of all lead aircraft and dipping the main beam vertically (a system developed by Agricaire) gives some three dimensional structure to what is otherwise merely pinpoints of light in shapeless darkness. The formation turn requires radio communication throughout the manoeuvre, familiarity with the system and confidence in the leader i.e. the products of working and training together. Night flying in rugged terrain can be aided by the use of image intensifying 'night vision goggles'. For**

**head up use by the pilot these are very expensive and the cheaper binocular type can only be used by the co-pilot. A high degree of crew confidence is again needed for these to be used effectively.**

***In this context, familiarity reinforces confidence and competence. The need for adequate pre-operational training cannot be overstressed.***

**Crew rostering is also the responsibility of the contractor or chief pilot but from the point of view of pilot safety and possible environmental contamination arising from pilot error it is important that crews are not overstressed either in the amount of flying they must undertake each night or each cycle. Civil Aviation regulations must be adhered to and in most countries this will limit the successive nights any pilots can fly.**

**Factors such as previous experience, training and sufficient manpower must be clearly specified in the tender invitation and then carefully considered in assessing and awarding the contract.**

---

**Track guidance/navigation**

[▲ Top](#)

---

**Navigation equipment**

[▲ Top](#)

**The type of navigation equipment to be provided by the contractor and the limits within which it must work will be specified in the invitation to tender.**

**Four basic types have been used for general aircraft navigation over the past years and all have been used in tsetse control. Two more types have more recently come into use. The systems which have been used for tsetse control are:**

**(a) A trisponder system which used local transmitters, placed by the operator in suitable high locations and then triangulates with a control unit in the aircraft to determine position. The system tested in Zimbabwe in 1983 was Decca's Flying Flagman. Low-level flying in undulating terrain resulted in shadowing and lost signals (19).**

**(b) 'Omega' type navigation which receives signals from two or more fixed transmitting stations around the world. Excellent for long distance travel but only accurate to about 2 nautical miles, therefore, not having the resolution to place the aircraft on reciprocal flight paths 200m apart.**

**(c) Inertial navigation systems (INS) use highly accurate and sophisticated gyros to detect velocity in three planes and by computerised analysis of these data are able to calculate the aircraft's position in relation to its start point. INS is relatively expensive and the system used in Zambia in 1987 caused repeated delays because it needed 45 minutes to 'warm up' after the engines were started. A thorough appraisal of the system used in Zambia was not possible so its navigational performance may well have been satisfactory. Some inaccurate flying was noted which may have been due to the operator who was inexperienced and had no formal training with the equipment (20).**

**(d) The Racal/Decca 'Doppler' system beams microwave signals down to the ground at three different angles then receives the reflected signals on an antennae from which a command computer is then able to calculate velocities in three planes and hence position in relation to the starting point. This is a self-contained system within the aircraft and has been used in Zimbabwe and Somalia in conjunction with a good heading and attitude reference platform, the British Aerospace SGP 500. This Doppler Integrated Navigation System (DINS) has been thoroughly tested in**

## **Zimbabwe and is recommended for tsetse control (20).**

### **The two new systems are:**

**(a) Terrain profile matching which is self-contained within the aircraft and identifies the aircraft's location from digitised maps. This is a very expensive system and requires expenditure on digitising maps for each area in which it will operate. It is bulky and, overall, is not suitable for tsetse control.**

**(b) Satellite navigation which has the greatest potential for the future. Global Positioning Systems (GPS) will eventually have 24-hour world-wide satellite coverage from which receiving antennae in aircraft will be able to identify their position with extreme accuracy. Used with fast flying aircraft, e.g. military, GPS cannot be used without a heading and attitude reference such as the SGP 500 or later generation gyros so the price is increased. With relatively slow flying tsetse aircraft, GPS may be sufficient as a stand alone system which would make its cost highly competitive, possibly under £20,000. At present, however, satellite coverage is limited and is unlikely to be widely available for tsetse control before 1993.**

---

### **Ground marker parties**

[▲ Top](#)

**One, two or three marker parties have been used to assist the aircraft's track guidance but, when used together with sophisticated avionics such as the DINS, they can actually cause confusion. The accuracy of ground marker positions can only be as good as the maps used to locate the anticipated flight paths and the operatives who position the marker pegs. Single-ended marking should be sufficient with a good airborne navigation system and if the system can be regularly updated using surveyed points or beacons it is**

**not absolutely essential to have any ground marking. In practice, however, a single marker line is useful to the pilots and helps to keep a check on tracking accuracy.**

**The ground marker party requires a ground to air radio and some means of visually signalling its position to the aircraft. Telescopic masts (Clarks Q12M) which lift rotating beacons of the type used on emergency service vehicles to a height of 12m have proved highly effective where the terrain allows (Plate 13). In very rugged terrain small signalling flares which rise to a height of about 70m are also very useful.**

**The marker team can keep a record of the flight path accuracy, relative to their surveyed position, and other useful data such as approximate wind speed and direction etc.. One great advantage of having marker parties in the treatment area is that they can advise the pilots about wind speeds at ground level and recommend postponement if these stay persistently above about 4m/sec.**



***Plate 13. A marker party vehicle with telescopic mast partially erected.***

---

**Timing the applications (cycles)**

**The sequence of insecticide applications must be timed so that females emerging after one treatment have insufficient time to deposit larvae before the next. The interspray period, e.g. time from the start of cycle 1 to start of cycle 2, is therefore calculated from the number of days estimated for a newly emerged female to deposit her first offspring. This first larval period (FLP) is temperature dependent and is approximately five days longer than the development time of subsequent larvae. The interspray period between all cycles is calculated in this way and applications continue until the pupal period, measured from the start of cycle 1, has been covered and new adults cease to emerge. If the FLP is calculated as, say, 15 days, the interspray period will normally be two or three days less to ensure that larviposition does not occur before retreatment. The reduction in time cannot be much greater than this since it might shorten the overall treatment time below the pupal period and possibly necessitate an additional application which would, of course, increase the cost. For many years the first larval period and pupal period have been calculated by formulae first compiled by an anonymous author. Attempts to improve these formulae or to estimate the rates of larval and pupal development more accurately have so far proved unsuccessful thus they are still estimated from the following formulae:**

$$\text{FLP .... } \frac{1}{0.0661 + 0.0035(t - 24)}$$

$$\text{Pupal period .... } \frac{1}{0.0323 + 0.0028(t - 24)}$$

**(where t is the mean daily temperature; min + max/2 in °C)**

**The denominators of the above functions equate to the amount of daily development and their reciprocals give estimates of the first larval period and pupal period in days. Thus if the average daily temperature (t) is 22°C, the FLP denominator equals 0.0521 and the FLP**

**equals 19.19 days. It is useful to accumulate the amount of daily larval development throughout an operation as in Table 7. By estimating temperatures a few days ahead this can help to predict the date of the next application. Similarly, the daily pupal period can be calculated to show when no further emergence is expected and can be used as a check that the five cycles have in fact covered the pupal period.**

**Table 7. Estimation of first larval period and pupal period from daily average temperatures (t); Zimbabwe 1988**

date	temp (C)	t-24	daily FLP	cum FLP				PP	Daily cycle 1	PP from cycle 2
July 1	20.75	3.25	.054725	cycle 1				.0232	.0232	
2	22	-2	.0591	0591				.0267	.0499	
3	18	-6	.0451	.1042				.0155	.0654	
4	18	-6	.0451	1493				.0155	.0809	
5	22.25	-1.75	.059975	.209275				.0274	.1083	
6	23.5	-.5	.06435	.273625				.0309	.1392	
7	20.75	-3.25	.054725	.32835				.0232	.1624	
8	20	-4	.0521	.38045				.0211	.1835	
9	18.5	-5.5	.04685	.4273				.0169	.2004	
10	20	-4	.0521	.4794				.0211	.2215	
11	21.625	-	.0577875	.5371875				.02565	.24715	



		2.375								
12	19	-5	.0486	.5857875				.0183	.26545	
13	18	-6	.0451	.6308875				.0155	.28095	
14	17	-7	.0416	.6724875	cycle 2				.0127	.29365
15	16.5	-7.5	.03985	.7123375	.03985			.0113	.30495	.0113
16	17	-7	.0416	.7539375	.08145				.0127	.31765
17	17.25	-6.75	.042475	.7964125	.123925				.0134	.33105
18	17.7	-6.3	.04405	.8404625	.167975				.01466	.34571
19	17.125	-6.875	.0420375	.8825	.2100125				.01305	.35876
20	19.375	-4.625	.0499125	.9324125	.259925				.01935	.37811
21	20.5	-3.5	.05385	.9862625	.313775				.0225	.40061
22	20	-4	.0521	1.038363	.365875				.0211	.42171
23	20.75	-3.25	.054725		.4206				.0232	.44491
24	19.5	-4.5	.05035		.47095				.0197	.46461
25	195	-4.5	.05035		.5213				.0197	.48431
26	19.5	-4.5	.05035		.57165				.0197	.50401
27	20	-4	.0521		.62375				.0211	.52511

28	18.5	-5.5	.04685		.6706				.0169	.54201
29	18	-6	.0451		.7157				.0155	.55751
30	20	-4	.0521		.7678				.0211	.57861
31	20	-4	.0521		.8199				.0211	.59971
Aug 1	20	-4	.0521		.872	cycle 3			.0211	.62081
2	20	-4	.0521		.9241	.0521			.0211	.64191
3	21	-3	.0556		.9797	.1077			.0239	.66581
4	21.5	-2.5	.05735		1.03705	.16505			.0253	.69111
5	18.5	-5.5	.04685			.2119			.0169	.70801
6	18.375	- 5.625	.0464125			.2583125			.01655	.72456
7	18.625	- 5.375	.0472875			.3056			.01725	.74181
8	19.375	- 4.625	.0499125			.3555125			.01935	.76116
9	20.5	-3.5	.05385			.4093625			.0225	.78366
10	19.5	-4.5	.05035			.4597125			.0197	.80336
11	195	-4.5	.05035			.5100625			.0197	.82306
12	18.25	-5.75	.045975			.5560375			.0162	.83926

13	19.75	-4.25	.051225			.6072625			.0204	.85966
14	20.5	-3.5	.05385			.6611125			.0225	.88216
15	195	-4.5	.05035			.7114625			.0197	.90186
16	19.875	-4.125	.0516625			.763125	cycle 4		.02075	.92261
17	20.7	-3.3	.05455			.817675	.05455		.02306	.94567
18	20.5	-3.5	.05385			.871525	.1084		.0225	.96817
19	18.625	-5.375	.0472875			.9188125	.1556875		.01725	.98542
20	20.25	-3.75	.052975			.9717875	.2086625		.0218	1.00722
21	20.5	-3.5	.05385			1.025638	.2625125		.0225	
22	18	-6	.0451				.3076125		.0155	
23	20	-4	.0521				.3597125		.0211	
24	20.25	-3.75	.052975				.4126875		.0218	
25	20.25	-3.75	.052975				.4656625		.0218	
26	21	-3	.0556				.5212625		.0239	
27	22	-2	.0591				.5803625		.0267	
28	22	-2	.0591				.6394625		.0267	

29	22	-2	.0591				.6985625		.0267	
30	22	-2	.0591				.7576625	cycle 5	.0267	
31	23	-1	.0626				.8202625		.0295	
Sept 1	24.5	.5	.06785				.8881125		.0337	
2	24.5	.5	.06785				9559625			
3	24.5	.5	.06785				1.023813			

## Emergency precautions

[▲ Top](#)

**The use of insecticides should always be closely controlled and this is particularly important when they are applied in large amounts by aircraft. Precautions must be taken to ensure that hazards relating to both aircraft and insecticides are minimised and that procedures are in place should accidents occur. The SEMG have produced guidelines for handling insecticides and an eco-technical team monitors RTTCP operational spraying. Safety has been mentioned above but the following should be reiterated:**

## Personal safety

[▲ Top](#)

**In the event that an aircraft accident occurs it is vital that assistance be called without delay. It is essential that communication lines to a central HQ, which is able to mobilise appropriate activities, are kept open throughout all operational spraying times. It is also necessary to have a contingency plan so that immediate and effective action can be taken.**

**It is most important that all areas where aircraft are on the ground with engines running are well illuminated at night and that stringent regulations are imposed to prevent persons approaching aircraft until the engines are stopped.**

**There should be no smoking at any time in the vicinity of aircraft, fuel storage areas or insecticide storage areas.**

**Clean water and soap should be available in the vicinity of areas where insecticides are handled. Procedures, antidotes and experienced personnel for treating persons contaminated by insecticide should be available at all times when insecticides are being handled.**

---

## **Environmental safety**

[▲ Top](#)

**The greatest potential danger of environmental contamination occurs in the event of insecticide being 'dumped' from the aircraft tank. This is an immediate safety precaution if the pilot considers the aircraft to be in danger through power loss etc.. When the dump occurs at height the insecticide is spread over a considerable area and is very difficult to locate and treat on the ground. The environmental monitoring team (e.g. SEMG) must still be advised immediately so that appropriate action can be taken if possible.**

**A dump on take-off, with a full load being released while still close to the ground, represents the very greatest threat of concentrated contamination over an area of several hundred m<sup>2</sup>. Being so close to the airstrip it should be possible to take immediate remedial action. A contingency plan and transport should be available to prevent any delay in locating the contaminated area. This should be immediately isolated (e.g. fenced off) and treated with a neutralising agent such as slaked lime which should always be on hand.**

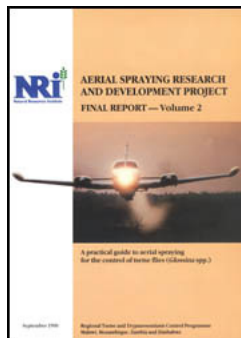

## **Aerial Spraying Research and Development Project - Final Report - Volume 2**

**Author(s):** *R. Allsopp*

**Publication date:** *1990*













**Number of pages:** *55*

**Publisher:** *Natural Resources Institute (NRI)*

**ISBN:** *5100.35.94.269*

**Copyright holder:** *Crown*

### **Contents:**

-  **CHAPTER 4: MONITORING**
-  **Physico-chemical monitoring (droplet sampling)**
  -  [Preparation of the samplers](#)
  -  [Calibration trials](#)
  -  [Operational sampling](#)
  -  [Analysing droplet data](#)
-  [Meteorological monitoring](#)
-  [Eco-technical monitoring](#)
-  **Operational monitoring**
  -  [Aircraft statistics for each aircraft per sortie](#)
  -  [Insecticide loading details](#)
  -  [Application statistics](#)

---

## CHAPTER 4: MONITORING

[▲ Top](#)

---

### Physico-chemical monitoring (droplet sampling)

[▲ Top](#)

**Physico-chemical monitoring or droplet sampling serves two main purposes in tsetse control:**

- (a) to calibrate the aircraft and its spray system before spraying commences.**
- (b) to monitor the performance of the aircraft and spray gear during operational spraying.**

**Similar techniques are also used for research purposes but these are considerably more comprehensive and sophisticated and are not discussed here (21,22).**

**Many attempts have been made to improve the field monitoring of aerially applied aerosols, for instance, the use of oil sensitive papers and cascade impactors such as those produced by Casella and Andersen. The latter have certain advantages, in particular they collect smaller droplets more efficiently, but for simplicity and cost effectiveness none has replaced the MgO (magnesium oxide) coated revolving microscope slide (23). This system, which has become the standard for droplet sampling, requires the following equipment:**

- a. a six volt, 330 rpm (spindle speed) motor with battery**

- b. 13 cm centre mounted arm with slide holders at each end**
- c. microscope slides cut to 0.634 cm and suitable slide boxes**
- d. magnesium ribbon**
- e. a 1m tripod**
- f. an anemometer**
- g. a suitable (100x) microscope with Porton G12 graticule.**

**The objective is to sample the aerosol by causing droplets to impinge on the slides. This creates craters in the magnesium oxide coating which have a constant size ratio with the drops that made them. The craters can be measured using a microscope and 'Porton' graticule (Graticules Ltd). Sedentary 2.54cm (1") microscope slides were originally used but the amount of 'swept' air, and therefore the potential number of droplets collected, is substantially increased by spinning the slides. A number of other improvements have been made over the past years. For instance, the normal 1" microscope slide has a much poorer collection efficiency than a narrower slide, thus they are now cut down to 0.634cm. The probability of droplet impaction is affected by their lateral speed thus the results should be corrected for wind speed during sampling. The sampled air may contain artefacts, particularly moisture in droplet form (mists), which produces similar craters in the MgO. Fluorescent dyes are routinely added to the insecticide at a concentration of 0.05% to facilitate the identification of insecticide droplets.**

**Accurate droplet sampling analysis therefore relies upon wind speed corrections and the use of fluorescent dyes and these should be used wherever possible. It is possible to obtain a rough estimate of the droplet spectrum for calibrating the output of the atomisers**



**using raw data from the rotary samplers.**

**There is a huge inherent variation in droplet sizes and, particularly, numbers between sampling sites in operational spraying so a rough estimate is of little use in assessing operational performance other than to give some indication that the aerosol is made up of droplets in the required size range.**

**The efficiency with which rotary samplers collect droplets varies considerably with droplet size and to a lesser extent wind speed. They are particularly inefficient for the smaller droplets and in order to relate samples collected with realistic estimates of the droplet spectrum actually affecting tsetse it is necessary to apply corrections. The correction factor for 0.6cm slides rotating at 420 rpm around a radius of 65mm is  $0.444 \times \text{wind speed}$  (23).**

**The corrected VMD and NMD will invariably be lower than the uncorrected figure. A satisfactory droplet spectrum is characterised by an uncorrected volume median diameter (VMD) of 20-30 microns and/or a number median diameter (NMD) of 15-25 microns. (A VMD of 30 microns means that half the volume of the aerosol is contained in droplets of 30 microns diameter or less; an NMD of 25 means that half the number of droplets in the aerosol have a diameter of 25 microns or less). A lower VMD would be acceptable, indeed desirable. A VMD approaching 40 microns or NMD over 30 microns is too high and would require adjustment to the spray gear e.g. a reduced atomiser blade angle.**

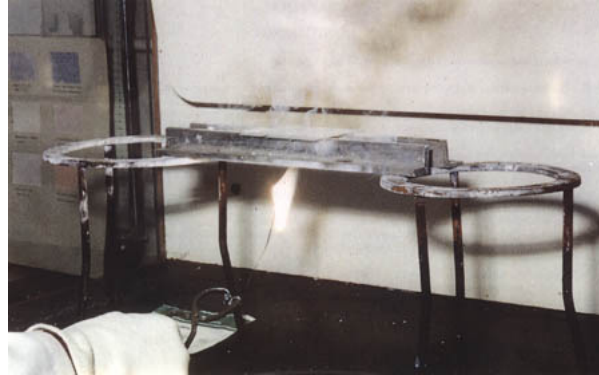

***Plate 14. MgO is deposited on microscope slides by burning a small strip of magnesium ribbon under the slides, which in this case were supported on two lengths of angle aluminium.***

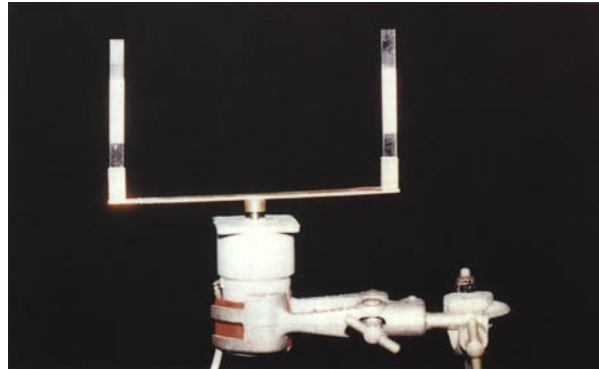

***Plate 15. A rotary sampler.***

## **Preparation of the samplers**

[▲ Top](#)

**The microscope slides are prepared by burning short lengths (10cm) of magnesium ribbon under a row of, say, 20 slides placed edge to edge and supported at each end in such a way that the centre of the slide is exposed to the cloud of MgO powder.. The slides can be held in position very simply by using bricks, pencils, metal strips or a custom made metal box (Plate 14). Magnesium ribbon is difficult to set alight and requires a constant flame rather than matches. Once alight it generates an extremely high temperature so forceps or pliers must be used to hold the burning strips. It is also very bright and should only be viewed through dark spectacles. Four or five 10cm strips will be needed to produce an even coating of MgO just thick enough to appear opaque if held against the light. The slides should be kept in a slide box which holds them securely so they can be transported without damaging to the MgO.**

**The rotary sampler consists of an electric motor which drives a 13cm custom-made, centre-mounted arm with some form of slide holder at each end (Plate 15). Six-volt motors are very convenient since they can be powered by rechargeable dry cell batteries or AA torch batteries which will last long enough for most sampling sessions. Motors and rechargeable batteries are widely available from electronics component suppliers such as RS Components. A 330 rpm motor and 13 cm slide carrier produces a tangential speed of 420 rpm.**

**The standard sampling height is 1m from the ground and the motor can be held on a suitable tripod or simply taped to a wooden stake.**

**Ideally, each sampler or sampling site will be accompanied by an anemometer (e.g. Vector Instruments) which records wind run for the duration of the sampling session and from which the average wind speed can be calculated.**

## Calibration trials

[▲ Top](#)

**Each aircraft's spray system should be tested in flight before operational use to ensure that the correct droplet spectrum is being produced. For this, samplers should be positioned 50m apart in a line which extends 100m beyond the operational swathe width and along the wind direction. The aircraft will then fly across at 90° to the layout making three or four passes over the second sampler from the upwind end and continuing the flight 2-3 km each side of the layout. Calibration must be carried out during normal spraying hours between dusk and dawn and the samplers can be switched off and collected 15-20 minutes after the final pass.**

---

## Operational sampling

[▲ Top](#)

**Samplers and anemometers can be used in a variety of ways to monitor the physical structure and distribution of the insecticide aerosol during operational spraying and to assess the performance of the aerial spraying operators. Sampling intensity will depend upon the problems anticipated and resources available.**

**In reasonably level, lightly wooded terrain being treated by experienced spraying operators the physico-chemical monitoring need only be minimal. It would, however, be prudent to sample more intensively in deep river valleys and dense vegetation situations where droplet penetration might be impeded and where additional treatment might be required (24). Inexperienced operators would also need to be carefully monitored to ensure that they produce the required droplet spectrum and distribution, their navigation is accurate and their formation spacing is correct (20).**

**Individual samplers or groups of two or three several metres apart can be deployed for 'spot checks' in dense vegetation or river beds. They can be deployed near trap sites or environmental monitoring sites to confirm that these were subject to normal spray distribution or, in the event of anomalous results, to help explain why. They can also be used to assess the extent of downwind drift, particularly in situations where drifting insecticide has been anticipated in siting barriers (25).**

**Sampling layouts similar to those used for calibration trials can be used to monitor the distribution of insecticide within single swathes or over the swathes covered by an aircraft formation. Longer layouts with samplers placed at appropriate intervals can monitor distribution over an entire sortie or even a whole nights spraying.**

---

### **Analysing droplet data**

[▲ Top](#)

**Droplet craters in the MgO can be counted and measured in a number of ways. If many slides need to be counted, automatic (e.g. Automatic Measuring Systems image analyser) or semi-automatic systems (e.g. Zeiss TGA 10 Fleming particle analyser) are available but at a high cost and with limited field applicability.**

**The simple system, most frequently used in field situations requires a portable microscope fitted with a  $\times 10$  eyepiece,  $\times 10$  objective and a Porton G12 graticule. If a fluorescent dye has been used in the formulation the droplets will only fluoresce under an ultra violet lamp placed to provide top lighting to the slides. Craters in the MgO are matched against graduations on the graticule and, correcting the measurements to take account of their spread factor, the diameters of a sample of droplets are recorded. Ideally, a sample of about 100 droplets per slide should be measured.**

These data may be analysed graphically using log probability paper (26,27) but for simplicity and speed the following NRI (J. Cooper) programme written in BASIC can be run on a pocket computer (e.g. Sharp PC series) to provide all the required statistics.

Computer programme written in BASIC for the analysis of droplet data.

```
10  REM SIZER
20  INPUT "NO. of CLASSES"; C
30  DIM N(C): DIM S(C): DIM P(C): DIM V(C): DIM R(C)
40  INPUT "AREA OF FOV, CM2"; A
50  INPUT "LMR LT"; S(0)
60  FORM = 1 TO C
70  S(M)=(20.5)*S(M-1)
80  NEXT M
90  LET U=S(C)
100 LET U=INT(10*U)
110 LET U=U/10
120 INPUT "SAMPLE NO."; J
130 LET T=0: LET X=0
140 FOR M = 1 TO C

150 INPUT "N(M)"; N(M)
160 LET T=T+N(M)
```

```
100 LET I = I + N(M)
170 NEXT M
180 INPUT "NO. OF FOV": F
190 LET F = 1 / (F * A)
200 FOR M = 1 TO C
210 LET P(M) = N(M) / T + P(M-1)
220 IF P(M) = 0.5 THEN LET X = INT(S(M) + 0.5): LET M = C
230 IF P(M) > 0.5 THEN LET X = S(M-1) + (S(M) - (S(M-1))
    *(0.5 - (P(M-1)))) / (P(M) - P(M-1))
240 IF P(M) > 0.5 THEN LET M = C
250 NEXT M
260 IF X > 0 THEN LET X = INT(X + 0.5)
270 LET W = 0
280 LET K = 3.1418 / 6
290 FOR M = 1 TO C
300 V(M) = (((S(M) * S(M-1)) 0.5) 3) * K
310 NEXT M
320 FOR M = 1 TO C
330 R(M) = N(M) * V(M)
```

```
340 LET W=W+R(M)
350 NEXT M
360 FOR M=1 TO C
370 P(M)=R(M)/W +P(M-1)
380 IF P(M) = 0.5 THEN LET Y= INT(P(M) + 0.5): LET M=C
390 IF P(M)>0.5 THEN LET Y=S(M-1) + ((S(M)-S(M-1))*
    (0.5-(P(M-I)))/(P(M)-P(M-I)))
400 IF P(M)>0.5 THEN LET M=C
410 NEXT M
420 IF Y>0 THEN LET Y= INT(Y+ 0.5)
430 PRINT " "
440 GOSUB 470
450 GOTO 120
460 END
470 LPRINT"
480 LPRINT "UPR. LT="; U
490 LPRINT "SAMPLE NO.";J
500 LPRINT "TOTAL DRPS="; T
510 LPRINT "NO/CM2 = " INT(T*F)

520 LPRINT TOTAL VOL. PL="; INT(W/1000)
```



```
530 LPRINT "PL/CM2 = "; INT(W*F/1000)
540 LPRINT "NMD = ";X
550 LPRINT "VMD = ";Y
560 RETURN
```

---

## Meteorological monitoring

[▲ Top](#)

**Meteorological data are collected as follows:**

**(a) The average daily temperatures are derived from maximum and minimum thermometers, preferably in a Stevenson Screen, recording at some convenient location throughout the operation. Alternatively, aspirated temperature probes connected to some form of meteorological recorder (e.g. Eltek Squirrel Data Logger) can be used. These data are used to calculate the first larval period from which the schedule of applications is determined.**

**(b) During daylight hours ground temperatures are generally higher than the air temperatures above and in this 'lapse' condition the difference increases progressively with height. As the warm air at ground level rises by convection there is a tendency for turbulence and mixing to occur. These are not conducive to the even distribution and sedimentation of small aerosol droplets which have very low terminal velocities and are easily deflected upwards. At night the ground loses heat by long wave radiation and cools the air immediately above it by conduction. This band of cooler air, which varies in depth from a few metres to several hundred, is the temperature inversion and within it the meteorological conditions tend to be stable. For this reason SAT is carried out at night.**

**The presence of a temperature inversion is indicated by the flattening and slow dispersal**

**of smoke plumes from 'cooking' fires etc.. It is more accurately measured using a meteorological recorder with a temperature probe at ground level and one several metres above. As the sun sets, the difference between the high and low probes will change from negative to positive as the inversion is formed. The difference, which can vary between a fraction of a degree and several degrees Centigrade, will normally persist throughout the night unless disrupted by some other meteorological occurrence such as high winds.**

**The presence of a temperature inversion indicates that conditions are suitable for SAT. Spraying in lapse conditions should only be contemplated if there are other satisfactory indications, such as low wind speeds and no convection, that the conditions are suitably stable.**

**(c) Prevailing wind speeds and directions should be established throughout the treatment area and in specific situations where localised, particularly katabatic, variations might occur. Ideally these data should be collected during the spraying season of the previous year but, failing that, in the weeks prior to the start of the operation. A data logger such as the Eltek Squirrel with wind vane and anemometer probes recording at 15 minute intervals is well suited to this.**

**With similar equipment, it is useful to record wind conditions in several sites throughout the treatment area for the duration of the operation. Edge effects should be carefully monitored, particularly where areas are expected to be affected by drifting insecticide rather than direct spraying. Together with physico-chemical data this may indicate where minor changes to the flying pattern or the location of barrier targets need to be considered or, in the event of tsetse survival, may help to explain why.**

**As explained above, wind speed data are also collected in conjunction with droplet sampling. The Eltek loggers are suitable for this but rather expensive since several would be required. Wind run anemometers (e.g. Vector Instruments) are sufficient.**

---

## Eco-technical monitoring

[▲ Top](#)

**This is a specific requirement of the RTTCP but is a sensible precaution for any aerial spraying operation.**

**The SEMG examine the biological environment in order to detect any contamination or inordinately high non-target mortality which might result from the aerial spraying. They also advise on the handling of insecticides and procedures to be adopted in the event of spillage, dumping etc.. Their responsibilities are, therefore, largely reactive since they are not qualified to comment on flow rates, VRU settings, application monitor malfunctions etc. which might give rise to environmental contamination.**

**Eco-technical monitoring is proactive. It combines the environmental and health monitoring of the SEMG with close operational scrutiny to ensure that leakage, spillage, overdosing, indeed any application malfunction, is minimised. In the wider sense it includes physico-chemical monitoring, checking navigational and formation accuracy. It also requires regular scrutiny of the spray gear blade angles, VRU settings, seals etc. and careful monitoring of the insecticide loads taken and returned.**

---

## Operational monitoring

[▲ Top](#)

**The objectives of operational monitoring are to ensure that the contract is carried out satisfactorily, on time and with the resources allocated. There is a degree of overlap with eco-technical monitoring to the extent that misuse of equipment, spillage, overdosing etc. can cause delays, deplete insecticide stocks or in the most extreme case lead to the operation being terminated by the SEMG or Contracting Authority.**

**Three aspects must be carefully and comprehensively monitored throughout the operation:**

---

### **Aircraft statistics for each aircraft per sortie**

[▲ Top](#)

**These include the start time, the flying time recorded as tachometer hours, the emission time and the estimated speed. These data will be presented to the operations manager by the pilots at the end of each sortie.**

**The tachometer times must correspond with the contractual agreement and are the basis of approval for interim payments to the contractor.**

**The percentage efficiency i.e. total flying time per cycle which is actually used for spraying ( $100/\text{tacho time} \times \text{emission time}$ ) is a good guide to the contractors cost effective use of aircraft to achieve the control objectives.**

---

### **Insecticide loading details**

[▲ Top](#)

**The target load, based on the area to be sprayed and the application rate, is known. This will be compared with the load actually sprayed according to the application monitor and, as a double check, by recording the amount of insecticide loaded at each refill and the amount remaining in the tank at the end of each sortie. These checks ensure that the required amount of insecticide is being applied, that mistakes are not being made which might lead to overdosing or possible shortage of insecticide and they prevent any gradual accumulation in the tank which might ultimately exceed the aircraft's carrying capacity.**

**The application monitor printout showing the amount of insecticide applied will be**

**presented by each pilot at the end of each sortie. Insecticide loading records must be carefully maintained by the loading supervisor.**

## Application statistics

[▲ Top](#)

**The area to be treated in each sortie is predetermined, the area actually treated will be recorded by the application monitor and will be made known to the operations manager after each sortie. Some discrepancy can be expected but should not be greater than about 10%. Any serious discrepancy would be checked and compared with other statistics, such as the load applied, to ensure that the monitor is working properly and that over or underdosing did not occur.**

**The dosage rate applied in litres/km<sup>2</sup> can be calculated from the load actually sprayed and the area to be sprayed. Any serious overdose would be reported to the environmental monitoring team. A significant underdose would require retreatment.**

**A summary of the operational statistics recorded during the 1988 operation in Zimbabwe is given in Table 8.**

**Table 8. A Summary of Operational Statistics taken from the 1988 operation in Zimbabwe**

DATE		SORTIE		AIRCRAFT STATISTICS		INSECTICIDE LOADING (litres)			APPLICATION STATISTICS			
		a/c	Timing		No. runs	Emission time	Est'd speed	target load	refill	load taken	load sprayed	line k spray
		rea	start	tacho		(secs)	(kph)					loa

Aug 30	1	NI	1650h	(hrs) 2.70	8	2487		321.30	330	400	322	173.60	1
		NI		2.70	8	2492	260.03	321.30	320	400	328	173.36	1
		HG		2.70	8	2492		321.30	303	400	322	172.84	1
	2	NI	2010h	1.50	9	2431	253.23	305.24	360	438	305	167.12	1
		NC		1.50	9	2435	252.81	305.24	334	406	306	168.64	1
		HG		1.50	9	2435		305.24	336	414	305	166.64	1
Aug 31	3	NI	1700h	1.80	9	2868	254.18	361.46	375	508	362	199.00	2
		NC		1.50	9	2873	253.74	361.46	331	431	362	197.76	2
	4	NI	1920h	1.60	7.5	2823	263.97	369.50	402	548	366	197.12	2
		NC		1.60	7.5	2846	261.84	369.50	362	431	368	197.04	2
	5	NI	2204h	1.50	6.5	2337	263.41	305.24	406	588	306	161.64	1
		NC		1.50	6.5	2343	262.74	305.24	368	431	307	164.92	1
Sept 1	6	NI	1745h	1.40	6.5	2548	254.32	321.30	270	552	320	173.08	1
		NC		1.40	6.5	2550	254.12	321.30	260	384	320	176.36	1
	7	NI	1940h	1.50	7	2627	259.00	337.37	330	562	337	181.20	:
		NC		1.50	7	2632	258.51	337.37	320	384	337	182.32	:

		HG		1.50	7	2632		337.37	300	369	3.37	180.84	1
	8	NI	2230h	1.50	6	2425	261.22	342.72	337	562	316	167.64	1
		NC		1.50	6	2424	261.21	342.72	337	384	316	167.84	1
		HG		1.50	6	2424		342.72	337	369	315	168.60	1
Sept 2	9	NI	2020h	1.80	6	2500		353.43	337	583	318	171.60	1
		NC		1.80	6	2503		353.43	336	404	318	173.20	1
		HG		1.80	6	2503		317.73	448	502	318	172.04	1
	10	NI	1655h	1.40	6	2774	256.96	353.43	318	583	354	191.84	1
		NC		1.40	6	2778	256.59	353.43	298	384	354	192.20	1
		HG		1.40	6	2778		353.43	148	332	375	158.60	1
	11	NI	1845h	1.40	6	2441		314.16	374	603	314	168.40	1
		NC		1.40	6	2446		314.16	374	404	314	169.48	1
		HG		1.40	6	2446		314.16	400	357	314	168.80	1
Sept 3	12	NI	2118h	1.70	7	3020	267.02	399.84	370	659	399	208.80	2
		NC		1.70	7	3017	267.29	399.84	370	460	399	208.76	2
		HG		1.70	7	3017		399.84	344	387	399	209.64	2
	13	NI	2330h	1.30	6	2160	260.00	278.46	329	589	279	149.96	1

		NC		1.30	6	2162	259.76	278.46	329	390	279	149.68	1
		HG		1.30	6	2162		278.46	329	317	279	14960	1
	14	NI	0120h	1.50	6	2120	264.91	278.46	259	569	279	146.40	1
		NC		1.50	6	2126	264.16	278.46	259	370	279	147.20	1
		HG		1.50	6	2126		278.46	259	297	279	147.88	1
Sept 4	15	NI	1650h	1.90	10	2780	253.81	349.86	319	609	349	191.28	1
		NC		1.90	10	2783	253.54	349.86	319	410	349	194.28	1
		HG		1.90	10	2783		34986	.319	337	349	190.72	1
	16	NI	1918h	1.20	4	1481	252.80	185.64	219	479	186	90.04	1
		NC		1.20	4	1484	252.29	185.64	219	280	186	102.88	1
		HG		1.20	4	1484	252.29	185.64	219	207	186	95.08	1
										201 (contaminated-discarded)			
						mean kph	258.42						
		Totals		70.50 hours efficiency 42.9%		30.29	hours	14139.00	14213 litres 71.065 drums		14213 litres		

## Entomological monitoring

[▲ Top](#)



**Tsetse surveys will commence long before the aerial spraying operation begins. Once it has begun, entomological monitoring assesses the success of each application and ultimately determines whether the contractual objective has been achieved. This generally means that tsetse have been eliminated from the treatment area.**

**Entomological monitoring takes two forms:**

- (a) Ageing of female tsetse captured after each application.**
- (b) Tsetse density estimates.**

**(a) New adult tsetse flies begin to emerge almost immediately after each application. At first these are easily recognised as newly emerged teneral flies but within a matter of days they are visually indistinguishable from old flies which may have survived the treatment. It is essential to determine whether flies captured after each application are newly emerged or whether they are old and have therefore either survived or reinvaded.**

**It is very difficult to age male tsetse. A rough estimate distinguishing 'old' from 'young' can be obtained by measuring the amount of pteridine in the eye pigment (28) or the amount of wing fray. Neither method gives a sufficiently reliable estimate therefore this monitoring concentrates on females which can be assigned quite accurate ages by the method of ovarian dissection.**

**Very briefly, the ovarian ageing technique is based upon the fact that female tsetse have a pair of ovaries, each containing two ovarioles. The four ovarioles ovulate in a regular sequence i.e. first egg from the right inner position, second egg from the left inner position, third right outer, fourth left outer. As seen under the microscope, the largest egg**

**follicle is next in line to discharge an ovum into the uterus and is the one which establishes the age category of the female. A tiny follicular relic remains after each ovulation so that it is possible to determine up to eight ovulations designated as age categories 0 (nulliparous) to 7. Beyond age category 7, it is impossible to determine whether the female is in the second or any subsequent ovarian cycle so all old flies are collected into the four categories 4 to 7. This system is, however, sufficiently accurate for monitoring aerial spraying since any female in age category 2 or more has survived or reinvaded.**

**A newly emerged female must be inseminated by a male before ovarian development begins. This occurs once and lasts the females lifetime. After a tsetse population has been treated with insecticide the number of newly emerged flies is low and it may take some time for this meeting and mating to take place. It is quite common in the days immediately after treatment to find young females which have not been inseminated. This is uncommon in a normal population, particularly *G. morsitans*.**

**After insemination the first egg develops for 7 to 9 days within the ovary and then passes into the uterus (29). At this point, the first egg follicle appears as an empty sac and the next follicle to develop, i.e. in the left inner position, is the largest of the four, the female's age category thus changes from 0 to 1. Within the uterus the egg develops into a larva, undergoes three instar changes over the next 7 days and, approximately 15 days after the adult has emerged, is deposited onto the ground where it burrows and pupates. This first larval period, which is temperature dependent, is critical to the timing of the operational cycles since the female must not be given time to deposit a larva.**

**After each application except the last it is normal to capture increasing numbers of newly emerged flies and it is possible to capture females which are quite heavily pregnant. Providing these are only in the second ovarian cycle i.e. no older than age category 1, they are not survivors. Any females in age category 2 or above must have emerged before the**

**previous treatment thus will have survived or reinvaded.**

**It is very difficult to determine whether an old female captured inside the treatment area after spraying is indeed a survivor or has reinvaded. If the fly is caught close to the boundary it is perhaps more likely to have reinvaded than one caught in the centre of the block. If it is caught soon after treatment carrying a third instar larva it will probably have reinvaded since heavily pregnant females are less mobile.**

**Providing these older females are very scarce there is no need to take remedial action so it is immaterial whether they have reinvaded or survived. If they are caught in significant numbers after the first or second applications it will be necessary to eliminate them and prevent the situation reoccurring. In this case it will be necessary to make an educated guess as to whether a barrier needs to be improved or the aerial spraying technique modified, for instance, by increasing the dosage. The more information there is available on the distribution and age of these problem females the more likely it is that a credible decision will be made.**

**If a significant number of surviving or reinvading females are captured after the third or fourth application it is too late to modify the technique or the barriers and it will have to be accepted that eradication will not be achieved and some form of 'mopping up' should be planned immediately.**

**(b) Population density in and around the treatment area will be monitored before, during and after insecticidal treatment to give an overall picture of the effects of the spraying. These surveys will provide the females which are aged as in (a) above and in the same way the more surveys carried out the better the chance of detecting survivors or establishing beyond doubt that eradication has been achieved. During and after spraying every female captured should be dissected.**

**The survey techniques selected will depend on the species of tsetse, terrain, vegetation**

**and resources. Mobile trapping with vehicle-mounted electric traps is particularly good for *G. morsitans*. Odour-baited traps are excellent for *G. pallidipes*. Ox rounds are effective for both species but require a plentiful supply of water which is seldom available during the normal aerial spraying season.**

**During the spraying it is important to collect captured flies as often as possible so they remain fresh for dissection. Skilled dissectors can dissect flies held in 5% formalin for about a week but the technique becomes very time consuming. After the last application the primary objective is to establish presence or absence of tsetse irrespective of age so it is less vital to get the fresh flies to a dissector. Whatever technique is used it must be regularly serviced during spraying but can be used in conjunction with preservatives after the last cycle.**

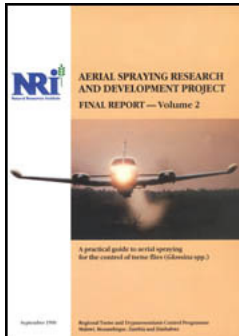

## **Aerial Spraying Research and Development Project - Final Report - Volume 2**

**Author(s):** *R. Allsopp*  
**Publication date:** *1990*  
**Number of pages:** *55*  
**Publisher:** *Natural Resources Institute (NRI)*  
**ISBN:** *5100.35.94.269*  
**Copyright holder:** *Crown*

### **[Contents:](#)**



[Abbreviations used](#)



[Acknowledgements](#)[Preface](#)[CHAPTER 1: PLANNING THE OPERATION](#)[CHAPTER 2: TENDERS AND CONTRACTS](#)[CHAPTER 3: OPERATIONAL PROCEDURES](#)[CHAPTER 4: MONITORING](#)[References](#)

---

## References

[▲ Top](#)

- 1. Douthwaite, R.J., Fox, P.J., Matthiesen, P., Russell-Smith, A. (1981) Environmental impact of aerosols of endosulfan, applied for control in the Okavango Delta, Botswana. *Final Report of the Endosulfan Monitoring Project. Overseas Development Administration, London.***
- 2. Zimbabwe Department of Veterinary Services, Tsetse and Trypanosomiasis Control Branch. Annual Report 1988**
- 3. Shereni, W (1990) Mark release and recapture studies to evaluate the efficacy of barriers of odour baited and insecticide treated targets against invasion by tsetse flies (*Glossina* spp) (Diptera: Glossinidae). *FAO Internal Report.***
- 4. Zimbabwe Department of Veterinary Services, Tsetse and Trypanosomiasis Control Branch Annual Report 1987**
- 5. Wilson, A (1987) A preliminary report on a large scale field trial to assess the effect of dipping in deltamethrin on the incidence of trypanosomiasis in cattle in a tsetse infested area. *Zimbabwe Department of Veterinary Services. Internal Report.***

- 6. Vale, G.A., Hall, D.R. and Gough A.J.E. (1988) The response of tsetse flies (*Glossina* spp) (Diptera: Glossinidae) to phenols and urine in the field. *Bulletin of Entomological Research* 78: 293-300**
- 7. Torr, S.J., Parker, A.G. and Leigh-Browne, G. (1989) The response of *Glossina pallidipes* Austen (Diptera: Glossinidae) to odour-baited traps and targets. *Bulletin of Entomological Research* 79: 991-108**
- 8. Jackson, C.H.N. (1946) An artificially isolated generation of tsetse flies (Diptera). *Bulletin of Entomological Research* 37: 291-299**
- 9. Allsopp, R. (1985) Wing fray in *Glossina morsitans centralis* Machado (Diptera: Glossinidae). *Bulletin of Entomological Research*, 75: 1-11**
- 10. Saunders, D. (1962) Age determination for female tsetse flies and the age composition of samples of *Glossina pallidipes* Aust., *G. palpalis fuscipes* Newst. and *G. brevipalpis* Newst.. *Bulletin of Entomological Research* 53: 579-595**
- 11. Challier, A. (1965) Amelioration de la methode de determination de l'age physiologique des glossines. Etudes faite sur *Glossina palpalis gambiensis* Vanderplank, 1949. *Bulletin Société Pathologie exotique* 58: 250-2 59**
- 12. Mulligan, H.W. (1970) *The African Trypanosomiases*. Allen and Unwin, London. 950pp.**
- 13. Davies, J.E. (1981) Insecticide drift and reinvasion of spray blocks in aerial spraying experiments against *Glossina morsitans centralis* Machado (Dipter: Glossinidae). *Bulletin of Entomological Research* 71: 499-508**
- 14. Park, P.O., Gledhill, J.A., Alsop, N.J. and Lee. (1972) A large-scale scheme for the eradication of *Glossina morsitans morsitans* Westw. in the Western Province of Zambia by**

**aerial ultra-low-volume application of endosulfan. *Bulletin of Entomological Research* 61: 373-384**

**15. Johnstone, D.R., Cooper, J.F., Casci, F. and Dobson, H.M (1990) The interpretation of spray application monitoring data in tsetse control operations using insecticidal aerosols applied from aircraft. *Atmospheric Environment* 24A(1): 53-61**

**16. Turner, D.A. and Brightwell, R. (1986) An evaluation of a sequential aerial spraying operation against *Glossina pallidipes* Austen (Diptera: Glossinidae) in the Lambwe Valley of Kenya: aspects of post-spray recovery and evidence of natural population regulation. *Bulletin of Entomological Research* 76: 331-349**

**17. Aerial Spraying Research and Development Project Annual Report 1989. *EEC Delegation, Harare.***

**18. Scientific Environmental Monitoring Group, Saarbrücken. Annual Report 1989. *EEC Delegation, Harare.***

**19. Hursey, B.S. and Allsopp, R.(1983) Sequential applications of low dosage aerosols from fixed wing aircraft as a means of eradicating tsetse flies (*Glossina* spp) from rugged terrain in Zimbabwe. *Tsetse and Trypanosomiasis Control Branch, Department of Veterinary Services, Zimbabwe.***

**20. Aerial Spraying Research and Development Project Annual Reports 1987, 1988. *EEC Delegation, Harare.***

**21. Johnstone, D.R., Allsopp, R., Cooper, J.F. and Dobson, H.M. (1988) Predicted and observed droplet deposition on tsetse flies *Glossina morsitans* following aerosol application from aircraft. *Pesticide Science* 22: 107-121**

- 22. Johnstone, D.R., Cooper, J.F., Casci, F. and Dobson, H.M. (1990) The interpretation of spray monitoring data in tsetse control operations using insecticidal aerosols applied from aircraft. *Atmospheric Environment* 24A: 53-61**
- 23. Cooper, J.F., Dobson, H.M. and Johnstone, D.R. (1987) A rotary sampler for coarse aerosol sampling: sampling rates and impact efficiency corrections to give a good estimate of airborne drops. *First Conference, Aerosol Society, Loughborough*. 3pp**
- 24. Allsopp, R. and Hursey, B.S. (1986) Integrated chemical control of tsetse flies (*Glossina* spp) in Western Zimbabwe 1984-1985. *Tsetse and Trypanosomiasis Control Branch, Department of Veterinary Services, Zimbabwe*.**
- 25. Johnstone, D.R. and Cooper, J.F. (1988) Monitoring of aerial spraying for tsetse fly eradication in Northern Zimbabwe, 1988. *Natural Resources Institute Internal Report*.**
- 26. Matthews, G.A. (1979) *Pesticide application methods*. Longman, London. 334pp.**
- 27. Coutts, H.H. (1984) The application of pesticides. Assessment techniques for spray pattern analysis. *Gesellschaft fur Technische Zusammenarbeit (GTZ). Eschborn, West Germany*.**
- 28. Lehane, M.J. and Mail, T.S. (1985) Determination of age of adult male and female *Glossina morsitans morsitans* using a new technique. *Ecological Entomology* 10: 219-224**
- 29. Langley, P.A. (1977) Physiology of tsetse flies (*Glossina* spp) (Diptera: Glossinidae): a review. *Bulletin of Entomological Research* 67: 523-574**





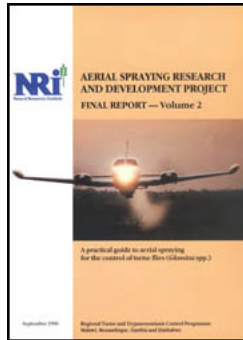

## Volume 2

**Author(s):** *R. Allsopp*

**Publication date:** *1990*

**Number of pages:** *55*















**Publisher:** *Natural Resources Institute (NRI)*

**ISBN:** *5100.35.94.269*

**Copyright holder:** *Crown*

---

### Contents:

-  [Abbreviations used](#)
-  [Acknowledgements](#)
-  [Preface](#)
-  [CHAPTER 1: PLANNING THE OPERATION](#)
-  [INTRODUCTION](#)
-  [OPERATIONAL DESIGN](#)
-  [The treatment area](#)
-  [The airstrip](#)
-  [Seasonal timing](#)
-  [Prevention of reinvasion](#)
-  [Entomological surveys](#)
-  [The insecticide](#)
-  [PLANNING A STRATEGY](#)
-  [Contractual requirement](#)

-  [Major equipment requirements](#)  
[Flying charges](#)

-  [Insecticide requirements and flow rate calculation](#)

-  [Insecticide requirement](#)

-  [Flow rate calculation](#)

-  [Estimation of the operational flying time per aircraft](#)

-  [Mobilisation/demobilisation](#)

-  [Pre-flight preparation](#)

-  [Ferrying to and from the spray block](#)

-  [Turns](#)

-  [CHAPTER 2: TENDERS AND CONTRACTS](#)

-  [THE AERIAL SPRAYING TENDER](#)

-  [Part A - Special Conditions](#)

-  [Instructions to tenderers](#)

-  [Proof of standing and ability](#)

-  [Financial considerations](#)

-  [Documentation to be provided after award of contract](#)

-  [Evaluation, breach of contract and sanctions](#)

-  [Part A - Technical Annex](#)

-  [Contractual objectives and general information.](#)

-  [Flying instructions](#)

-  [Aircraft equipment](#)

-  [Rugged terrain](#)

- 

[Bill of Quantities and Price Schedule](#)

 [Part B - The General Conditions](#)

 [Adjudication of the aerial spraying tenders](#)

 [THE INSECTICIDE TENDER](#)

 [Part A - Technical Annex](#)

 [General information](#)

 [Insecticide specification](#)

 [Delivery and packaging](#)

 [Information to be supplied by the successful tenderer](#)

 [THE CONTRACTS](#)

 [CHAPTER 3: OPERATIONAL PROCEDURES](#)

 [Spray gear: setting and calibration](#)

 [Insecticide loading and handling](#)

 [Crew training and rostering](#)

 [Track guidance/navigation](#)

 [Navigation equipment](#)

 [Ground marker parties](#)

 [Timing the applications \(cycles\)](#)











 [Emergency precautions](#)

 [Personal safety](#)

 [Environmental safety](#)

 [CHAPTER 4: MONITORING](#)

 [Physico-chemical monitoring \(droplet sampling\)](#)

-  [Preparation of the samplers](#)
- [Calibration trials](#)
-  [Operational sampling](#)
-  [Analysing droplet data](#)
-  [Meteorological monitoring](#)
-  [Eco-technical monitoring](#)
-  [Operational monitoring](#)
-  [Aircraft statistics for each aircraft per sortie](#)
-  [Insecticide loading details](#)
-  [Application statistics](#)
-  [Entomological monitoring](#)
-  [References](#)

---

## Aerial Spraying Research and Development Project - Final Report - Volume 2

[▲ Top](#)

**A practical guide to aerial spraying  
for the control of tsetse flies (*Glossina* spp.)**



**September 1990**

**Regional Tsetse and Trypanosomiasis Control Programme**

**Malawi, Mozambique, Zambia and Zimbabwe**

**by**

**R. Allsopp  
(Team Leader)**

**Funded by the**

**EUROPEAN ECONOMIC COMMUNITY  
Accounting number 5100.35.94.269**

**In association with the**

**NATURAL RESOURCES INSTITUTE  
Central Avenue  
Chatham Maritime  
Kent  
United Kingdom**

**September 1990**

**© *Crown Copyright 1991***

**The Natural Resources Institute (NRI) is the scientific arm of Britain's Overseas Development Administration. NRI's principal aim is to increase the productivity of renewable natural resources in developing countries through the application of science and technology. Its areas of expertise are resource assessment and farming systems, integrated pest management, and food science and crop utilization.**

**Short extracts of material from this report may be reproduced in any non-advertising, non-**

**profit-making context provided that the source is acknowledged as follows:**

**Allsopp, R. (1991). *Aerial Spraying Research and Development Project final report - volume 2*. Chatham: Natural Resources Institute, for the European Economic Community, vi + 48pp.**

**Permission for commercial reproduction, however, should be sought from the Head, Publications and Publicity Section, Natural Resources Institute, Chatham Maritime, Kent ME4 4TB, United Kingdom.**

**No charge is made for single copies of this publication sent to governmental and educational establishments research institutes and non-profit-making organisations, working in countries eligible for British Government aid Free copies cannot normally be addressed to individuals by name, but only under their official titles.**

**Natural Resources Institute  
ISBN 0-85954-287-4**

